



SLM-1 Electronic Load Chassis

Operation and Programming Manual

Programmable Power Solutions

About AMETEK

AMETEK Programmable Power, Inc., a Division of AMETEK, Inc., is a global leader in the design and manufacture of precision, programmable power supplies for R&D, test and measurement, process control, power bus simulation and power conditioning applications across diverse industrial segments. From bench top supplies to rack-mounted industrial power subsystems, AMETEK Programmable Power is the proud manufacturer of Elgar, Sorensen, California Instruments and Power Ten brand power supplies.

AMETEK, Inc. is a leading global manufacturer of electronic instruments and electromechanical devices with annualized sales of \$2.5 billion. The Company has over 11,000 colleagues working at more than 80 manufacturing facilities and more than 80 sales and service centers in the United States and around the world.

Trademarks

AMETEK is a registered trademark of AMETEK, Inc.

Other trademarks, registered trademarks, and product names are the property of their respective owners and are used herein for identification purposes only.

Notice of Copyright

SLM-1 Electronic Load Chassis Operating and Programming Manual© 2010 AMETEK Programmable Power, Inc. All rights reserved.

Exclusion for Documentation

UNLESS SPECIFICALLY AGREED TO IN WRITING, AMETEK PROGRAMMABLE POWER, INC. ("AMETEK"):

- (a) MAKES NO WARRANTY AS TO THE ACCURACY, SUFFICIENCY OR SUITABILITY OF ANY TECHNICAL OR OTHER INFORMATION PROVIDED IN ITS MANUALS OR OTHER DOCUMENTATION.
- (b) ASSUMES NO RESPONSIBILITY OR LIABILITY FOR LOSSES, DAMAGES, COSTS OR EXPENSES, WHETHER SPECIAL, DIRECT, INDIRECT, CONSEQUENTIAL OR INCIDENTAL, WHICH MIGHT ARISE OUT OF THE USE OF SUCH INFORMATION. THE USE OF ANY SUCH INFORMATION WILL BE ENTIRELY AT THE USER'S RISK, AND
- (c) REMINDS YOU THAT IF THIS MANUAL IS IN ANY LANGUAGE OTHER THAN ENGLISH, ALTHOUGH STEPS HAVE BEEN TAKEN TO MAINTAIN THE ACCURACY OF THE TRANSLATION, THE ACCURACY CANNOT BE GUARANTEED. APPROVED AMETEK CONTENT IS CONTAINED WITH THE ENGLISH LANGUAGE VERSION, WHICH IS POSTED AT WWW.PROGRAMMABLEPOWER.COM.

Date and Revision

July 2015 Revision D

Part Number

M540070-01



Contact Information

Telephone: 800 733 5427 (toll free in North America)
858 450 0085 (direct)
Fax: 858 458 0267
Email: sales.ppd@ametek.com
service.ppd@ametek.com
Web: www.programmablepower.com

This page intentionally left blank.

Important Safety Instructions

Before applying power to the system, verify that your product is configured properly for your particular application.

 WARNING	Hazardous voltages may be present when covers are removed. Qualified personnel must use extreme caution when servicing this equipment. Circuit boards, test points, and output voltages also may be floating above (below) chassis ground.
 WARNING	The equipment used contains ESD sensitive ports. When installing equipment, follow ESD Safety Procedures. Electrostatic discharges might cause damage to the equipment.

Only *qualified personnel* who deal with attendant hazards in power supplies, are allowed to perform installation and servicing.

Ensure that the AC power line ground is connected properly to the Power Rack input connector or chassis. Similarly, other power ground lines including those to application and maintenance equipment *must* be grounded properly for both personnel and equipment safety.

Always ensure that facility AC input power is de-energized prior to connecting or disconnecting any cable.

In normal operation, the operator does not have access to hazardous voltages within the chassis. However, depending on the user's application configuration, **HIGH VOLTAGES HAZARDOUS TO HUMAN SAFETY** may be normally generated on the output terminals. The customer/user must ensure that the output power lines are labeled properly as to the safety hazards and that any inadvertent contact with hazardous voltages is eliminated.

Guard against risks of electrical shock during open cover checks by not touching any portion of the electrical circuits. Even when power is off, capacitors may retain an electrical charge. Use safety glasses during open cover checks to avoid personal injury by any sudden component failure.

Neither AMETEK Programmable Power Inc., San Diego, California, USA, nor any of the subsidiary sales organizations can accept any responsibility for personnel, material or inconsequential injury, loss or damage that results from improper use of the equipment and accessories.

SAFETY SYMBOLS



WARNING
Risk of Electrical Shock



CAUTION
Refer to Accompanying Documents



Off (Supply)



Direct Current (DC)



Standby (Supply)



Alternating Current (AC)



On (Supply)



Three-Phase Alternating Current



Protective Conductor Terminal



Earth (Ground) Terminal



Fuse



Chassis Ground

This page intentionally left blank.

Product Family: SLM-1 Electronic Load Chassis

Warranty Period: One Year

WARRANTY TERMS

AMETEK Programmable Power, Inc. ("AMETEK"), provides this written warranty covering the Product stated above, and if the Buyer discovers and notifies AMETEK in writing of any defect in material or workmanship within the applicable warranty period stated above, then AMETEK may, at its option: repair or replace the Product; or issue a credit note for the defective Product; or provide the Buyer with replacement parts for the Product.

The Buyer will, at its expense, return the defective Product or parts thereof to AMETEK in accordance with the return procedure specified below. AMETEK will, at its expense, deliver the repaired or replaced Product or parts to the Buyer. Any warranty of AMETEK will not apply if the Buyer is in default under the Purchase Order Agreement or where the Product or any part thereof:

- is damaged by misuse, accident, negligence or failure to maintain the same as specified or required by AMETEK;
- is damaged by modifications, alterations or attachments thereto which are not authorized by AMETEK;
- is installed or operated contrary to the instructions of AMETEK;
- is opened, modified or disassembled in any way without AMETEK's consent; or
- is used in combination with items, articles or materials not authorized by AMETEK.

The Buyer may not assert any claim that the Products are not in conformity with any warranty until the Buyer has made all payments to AMETEK provided for in the Purchase Order Agreement.

PRODUCT RETURN PROCEDURE

1. Request a Return Material Authorization (RMA) number from the repair facility (**must be done in the country in which it was purchased**):
 - **In the USA**, contact the AMETEK Repair Department prior to the return of the product to AMETEK for repair:
Telephone: 800-733-5427, ext. 2295 or ext. 2463 (toll free North America)
858-450-0085, ext. 2295 or ext. 2463 (direct)
 - **Outside the United States**, contact the nearest Authorized Service Center (ASC). A full listing can be found either through your local distributor or our website, www.programmablepower.com, by clicking Support and going to the Service Centers tab.
2. When requesting an RMA, have the following information ready:
 - Model number
 - Serial number
 - Description of the problem

NOTE: Unauthorized returns will not be accepted and will be returned at the shipper's expense.

NOTE: A returned product found upon inspection by AMETEK, to be in specification is subject to an evaluation fee and applicable freight charges.

This page intentionally left blank.

About this Manual

This manual has been written expressly for the Sorensen brand SL series of electronic loads, which have been designed and certified to meet the Low Voltage and Electromagnetic Compatibility Directive Requirements of the European Community.

Since the goal of the Low Voltage Directive is to ensure the safety of the equipment operator, universal graphic symbols have been used both on the unit itself and in this manual to warn the operator of potentially hazardous situations (see Safety Information page).

This page intentionally left blank.

CONTENTS

SECTION 1 FEATURES, FUNCTIONS, AND SPECIFICATIONS.....1-1

1.1	Introduction	1-1
1.2	Features and Functions.....	1-2
1.3	Specifications	1-2
1.4	Regulatory Compliance	1-2
1.5	System Block Diagram	1-3

SECTION 2 INSTALLATION2-1

2.1	INSPECTION	2-1
2.1.1	Line Voltage	2-1
2.1.2	Grounding Requirements	2-2
2.1.3	Environmental Requirements	2-3
2.1.4	Service or Repair.....	2-3
2.1.5	Accessories	2-3
2.2	CONNECTIONS.....	2-3
2.2.1	GPIB Connection.....	2-3
2.2.2	RS-232C Connection.....	2-4
2.2.3	Analog Programming BNC Input	2-4
2.3	Maintenance.....	2-4
2.3.1	Cleaning	2-4

SECTION 3 OPERATION.....3-1

3.1	Introduction	3-1
3.2	Power Connection	3-2

3.2.1	Power-On Status	3-2
3.3	STORE / RECALL Function.....	3-3
3.3.1	STORE Procedure.....	3-3
3.3.2	RECALL Procedure:	3-3
3.4	SEQUENCE Function.....	3-4
3.4.1	EDIT MODE.....	3-5
3.4.2	TEST MODE.....	3-5
SECTION 4 GPIB/RS-232 PROGRAMMING OPERATION		4-1
4.1	Introduction	4-1
4.2	RS-232 Interface and Commands	4-1
4.3	GPIB/RS-232C Command List	4-2
4.3.1	Command Syntax Abbreviations.....	4-2
4.4	GPIB/RS-232 Command Description.....	4-7
4.4.1	Setting Commands	4-7
4.4.2	Query Commands.....	4-21
Appendix A	GPIB Programming Example	
Appendix B	RS-232 Programming Example	
Appendix C	SLM-series AC Load GPIB/RS-232 Operating Flow Chart	
Appendix D	SLM-series DC Load GPIB/RS-232 Operating Flow Chart	
Appendix E	SLD-series BPIB/RS-232 Operating Flow Chart	

LIST OF FIGURES

Figure 1-1	System Block Diagram.....	1-3
Figure 2-1	Input Power Setting Switch	2-2
Figure 2-2	Fuse Holder in AC Line Input Connector.....	2-2
Figure 2-3	SLM-1 Chassis Rear Panel.....	2-4
Figure 3-1	SLM-1 Chassis Front Panel, without Module.....	3-1
Figure 3-2	SLM-1 Front Panel Keys and LEDs	3-2
Figure 3-3	Auto Sequence Function Set-Up and Operation Flowchart	3-4
Figure 4-1	RS-232 Interface Diagram	4-1
Figure 4-2	Protection Status Register	4-24
Figure 4-3	Error Status Byte Register	4-24

LIST OF TABLES

Table 1-1 SL-Series Maximum Ratings Specifications	1-1
Table 1-2 SLM-1 Chassis Specifications.....	1-2
Table 4-1 GPIB Command Terminator	4-2
Table 4-2 GPIB/RS-232 Setting Command Summary	4-4
Table 4-3 GPIB/RS-232 Preset Query Command Summary with Applicable Module Types.....	4-4
Table 4-4 State Command Summary.....	4-5
Table 4-5 System Commands - All Modules	4-6
Table 4-6 Measure and Limit Commands	4-6
Table 4-7 Global Commands	4-6
Table 4-8 Waveform Information	4-14

This page intentionally left blank.

SECTION 1

FEATURES, FUNCTIONS, AND SPECIFICATIONS

1.1 INTRODUCTION

The SLM-1 electronic load chassis is designed with an open bay to easily receive one single-bay SLM or SLD load module, which slides into the bay from the front of the chassis. The specification ratings for the SL-series plug-in modules are shown in Table 1-1. Please refer to the Xantrex catalog or to the applicable module operation manual for detailed specifications.

Model	Max.Current	Max. Voltage	Max. Power
SLM-60-20-300	20 Arms	60 Vrms	300 W
SLM-150-8-300	8 Arms	150 Vrms	300 W
SLM-300-4-300	4 Arms	300 Vrms	300 W
SLM-500-1-300	1Arms	300 Vrms	300 W
SLM-60-30-300	30A	60V	150W
SLM-60-15-75	15A	60V	75W
SLM-60-30-150	30A	60V	150W
SLM-60-60-300	60A	60V	300W
SLM-250-10-300	10A	250V	300W
SLM-500-10-300	10A	500V	300W
SLD-60-505-255	50A/5A	+60V/+60V	250W/50W
SLD-61-505-255	50A/5A	+60V/-60V	250W/50W
SLD-60-20-102	20A/20A	+60V/+60V	100W/100W
SLD-61-5-752	5A/5A	+60V/-60V	75W/75W
SLD-62-5-752	5A/5A	-60V/-60V	75W/75W

Table 1-1 SL-Series Maximum Ratings Specifications

1.2 FEATURES AND FUNCTIONS

The SLM chassis provides high performance, easy operation and a cost-effective solution for power source testing. The features of the SLM-1 electronic load chassis are:

- Plug-in design allows for easy replacement of different load modules as applications change
- Flexible configuration allows the bay to accept any SLM-(single module) or SLD-(dual) series load module
- The analog programming BNC input on the rear panel can control the load module's load current with arbitrary waveforms (SLM DC modules single channel) or synchronization (SLM AC modules) **NOTE: SLD dual channel modules do not support analog programming.**
- RS-232 connector provides serial interface for remote control for easy connection to a computer
- GPIB interface (option), one GPIB address can control the electronic load module with set load status and read back meter capabilities.

1.3 SPECIFICATIONS

Specification details of the SLM-1 chassis are shown in Table 1-2.

AC INPUT	LINE	100V/115V±10%	200V/230V±10%
	FREQUENCY	50/60 HZ	
	FUSE	2A/250V (5x20mm)	1A/250V (5x20mm)
	MAX. POWER CONSUMPTION	40 W	
DIMENSIONS (W*H*D)		5.9x7.0x17.5 in. (150 x 177 x 445 mm)	
WEIGHT		NET: 12.4 lbs. (5.5 kg)	

Table 1-2 SLM-1 Chassis Specifications

1.4 REGULATORY COMPLIANCE

- Certified to UL 61010-1, CSA C22.2 No. 61010.1 and IEC/EN 61010-1
- CE Compliant:
 - Low Voltage Directive (73/23/EEC) using EN 61010-1, and
 - EMC Directive (89/336/EEC) using EN 61326
- FCC Compliant to 21 CFR, Subpart J.

1.5 SYSTEM BLOCK DIAGRAM

The system block diagram is shown in Figure 1-1. There are two power supplies in the SLM-1 chassis, one for the system controller and one for each of the four optically isolated channels.

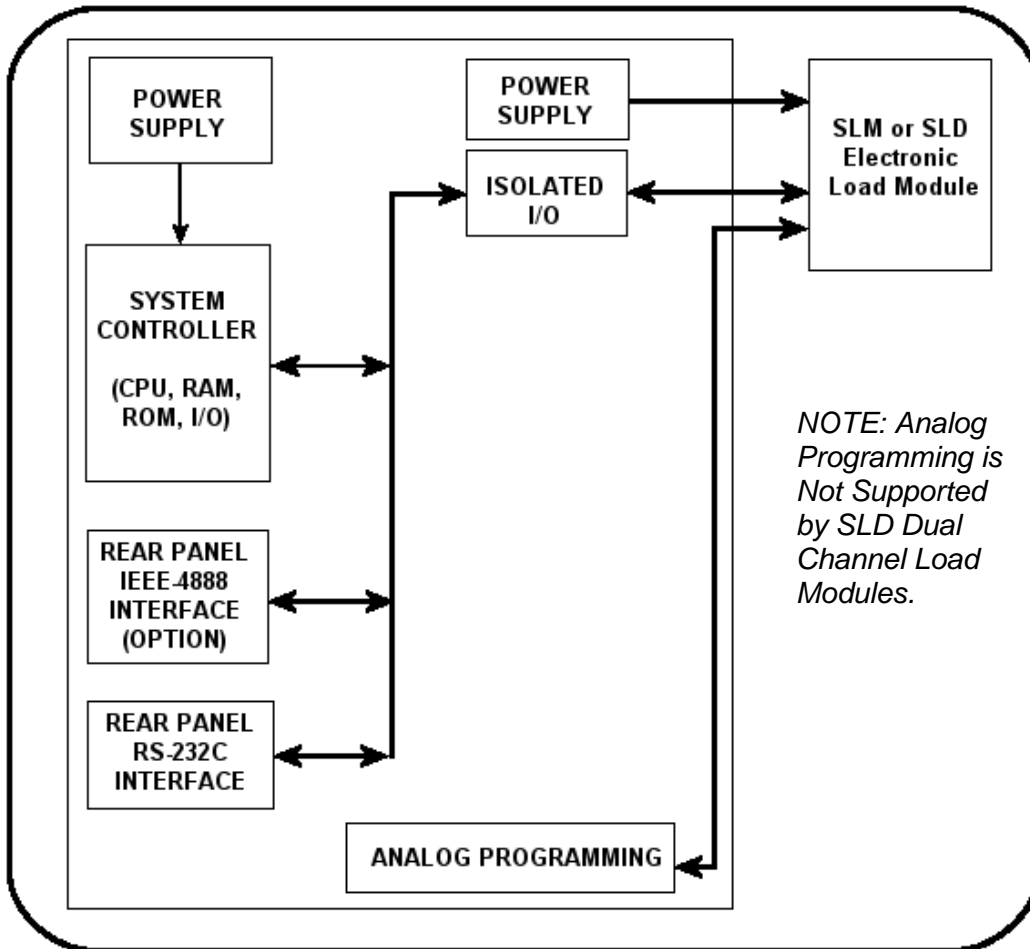

Figure 1-1 System Block Diagram

This page intentionally left blank.

SECTION 2 INSTALLATION

2.1 INSPECTION

The SLM-1 chassis was carefully inspected before shipment. If instrument damage has occurred during transport, please inform the Xantrex sales and service office or representative per the Warranty instructions of this manual. SLM-1 chassis was shipped with a power cord for the type of outlet used at your location. If the appropriate cord was not included, please contact your nearest Xantrex sales representative to obtain the correct cord. Refer to Section 2.1.1 to check the line voltage selection and fuse type.

2.1.1 Line Voltage

The SLM-1 chassis can operate with 100/200Vac or 115/230Vac input as indicated on the rear pane label I (Figure 2-1). Make sure that the factory mark corresponds to your nominal line voltage. If not correctly marked, perform the following procedures:

1. With the SLM-1 chassis power OFF, disconnect the power cord.
2. Set the switches on the rear panel to the proper voltage as follows:
 - a. Set Switch to 100V/115V for 100Vac or 115Vac line voltage
 - b. Set Switch to 200V/230V for 200Vac or 230Vac

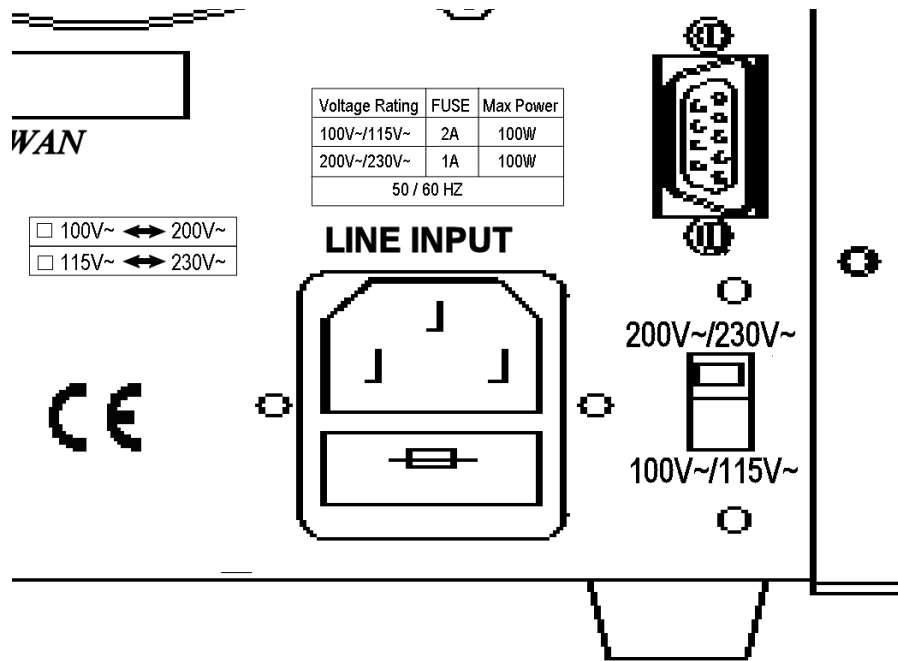

Figure 2-1 Input Power Setting Switch

3. Check the rating of the line fuse and replace it with the correct fuse if necessary.
4. The AC line fuse is located below the AC line receptacle (Figure 2-2). With the power cord removed, use a small screwdriver to extract the fuse holder from under the AC socket. Replace the fuse with the appropriate type as indicated in Table 1-2. These fuses are normal-blow fuses.
5. Reinstall fuse holder and reconnect the power cord.

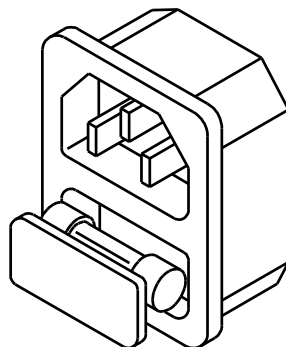

Figure 2-2 Fuse Holder in AC Line Input Connector

2.1.2 Grounding Requirements

The SLM-1 chassis is equipped with a three-conductor cable that plugs into an appropriate receptacle to ground the instrument's cover.

2.1.3 Environmental Requirements

- For indoor use only
- Installation Category II (over voltage)
- Pollution Degree 2
- Altitude up to 2000 meters (with power derating)
- Relative Humidity 80% RH Max
- Ambient Operating Temperature 0-40°C with ideal between 25°C ± 5°C

2.1.4 Service or Repair

If the instrument is damaged, please attach a tag to the instrument, identifying the owner and indicating the required service. Follow the procedures detailed in the warranty at the end of this manual.

2.1.5 Accessories

The following parts should be included in the shipment:

- Three-conductor 18 gauge power cord, 1 ea.
- SLM-1 Electronic Load Chassis operation manual, 1 ea. (this manual)

If a module is configured with the chassis, the following parts should be included in the shipment:

- Vsense cable(s) for each input
- Hook terminals for each input
- Banana plugs for each input
- Imonitor BNC cable (if applicable)

2.2 CONNECTIONS

2.2.1 GPIB Connection

The GPIB connector on the rear panel (Figure 2-3) connects the SLM-1 chassis to a controller and to other GPIB devices. A GPIB system can be connected in any configuration (star, linear, or both), with the following provisions:

- The maximum number of devices including the controller is no more than 15.
- The maximum length of all cables is no more than 2 meters times the number of devices connected together, up to 20 meters maximum.

Ensure that the lock screws are firmly hand-tightened; use a screwdriver only for the removal of screws. Figure 2-3 shows the rear panel of the SLM-1 chassis, where the GPIB connector is located. The GPIB address of the SLM-1 chassis is set on the front panel (Figure 3-1).

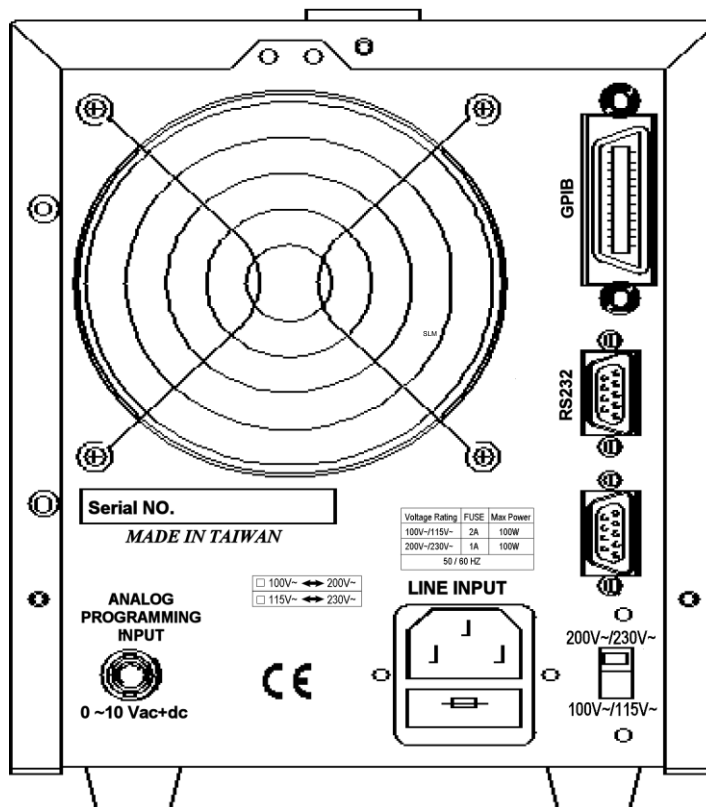

Figure 2-3 SLM-1 Chassis Rear Panel

2.2.2 RS-232C Connection

The RS-232C connector (female) on the rear panel connects the SLM-1 chassis to the computer's RS-232C port.

2.2.3 Analog Programming BNC Input

The BNC connector on the rear panel connects the SLM-1 chassis to the SLM-Series single channel module analog programming input, or to the external sync input of SLM-Series AC load module. **NOTE: SLD dual channel modules do not support analog programming.**

2.3 MAINTENANCE

2.3.1 Cleaning



WARNING:

To avoid electrical shock or damage to the meter, do not get water inside the case.

Periodically wipe the case with a damp cloth and detergent; do not use abrasives or solvents.

SECTION 3 OPERATION

3.1 INTRODUCTION

The front panel of the SLM-1 chassis is shown in Figure 3-1.



Figure 3-1 SLM-1 Chassis Front Panel, without Module

3.2 POWER CONNECTION

Before connecting AC power to the SLM-1 chassis, make sure the power source matches the power requirements of the SLM-1 electronic load chassis (as marked on the rear panel) per Section 2.1.1. The power switch in the lower left-of-center area of the SLM-1 chassis, turns power On/Off to the chassis and to the installed electronic load module.



PREVENT DAMAGE TO THE LOAD: Do NOT apply voltage or current with power switched OFF. Turn ON the power switch to the load PRIOR to applying voltage or current to the input terminals (i.e., before turning on the power supply under test).

3.2.1 Power-On Status

Local/Manual Operation Displays

STORE/RECALL: All LEDs are OFF; BANK LED display shows 01; SL-series electronic load is in Power On initial state (please refer to the appropriate SL-series Electronic Load Operations Manual for the startup state of each module).

GPIB Address Setting

1. Press STATE 4+STATE 5 (keys running vertically on left side of chassis) simultaneously to set the GPIB address.
2. Press UP or DOWN on the BANK keys (lower left corner of chassis) to select the address number (0-31) (see LED to right of BANK keys).
3. Press STATE 2 to exit GPIB address setting mode.

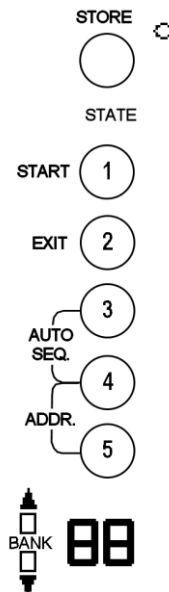

Figure 3-2 SLM-1 Front Panel Keys and LEDs

3.3 STORE / RECALL FUNCTION

The eight function keys on the front panel of SLM chassis are designed for high throughput testing. There are 30 banks (only one bank for AC modules) of 5 operation states for a total of 150 testing steps that can be stored in EEPROM memory. Each state can save or recall the load status and level for the load module. For more detail about the STORE and RECALL functions, refer to the operation flow-chart in the applicable SL-Series Electronic Load Module Operations Manual.

3.3.1 STORE Procedure

1. Set the load status and load level for the load module within the chassis.
2. For AC loads, go to the next step in this procedure. For DC load modules, select the Memory Bank (01-30) for storing the load status and level.
3. Press the STORE key on the SLM chassis, the STORE LED begins flashing to indicate ready to store. Either press a State key (next step in this procedure), or Exit by pressing Store key again or by waiting 20 seconds, at which time the STORE LED will turn off to prevent accidentally overwriting a memory state.
4. Press one of the State 1-5 keys. The appropriate State key's LED will light immediately; the load level and status of SL-series load module is now stored into the EEPROM memory. The STORE procedure is completed when the STORE LED turns OFF.

Notes:

If more than one state is stored in the same State key, the last one entered will be treated as an update and will overwrite the previously input state.

After pressing the STORE key, the front panel keys on the SL-series electronic load module are still active. However, the STATE LED will turn off if any key on the load module is pressed. This indicates that the front panel state of the load module is not the same as stored state.

3.3.2 RECALL Procedure:

For SLM AC Series

Press one of the Memory State 1 through 5 keys; its corresponding LED lights, and the stored state on the SLM chassis is sent to the module. If any key is pressed on the load module, the State LED indicator turns off immediately to indicate that the module state no longer matches the recalled state.

For DC Loads

Use BANK up and down keys to select the Memory Bank, then press one of the Memory State 1 through 5 keys; its corresponding LED lights, and the stored state on the SLM chassis is sent to the module. If any key is pressed on the load module, the State LED indicator turns off immediately to indicate that the module state no longer matches the recalled state.

3.4 SEQUENCE FUNCTION

There are two modes in the SEQUENCE function: EDIT MODE and TEST MODE, The AUTO SEQ function can be initiated by pressing State 3 + State 4 keys simultaneously. To enter EDIT MODE, press STORE; to enter the TEST MODE, press START key. Please refer to the flow chart in Figure 3-3. A brief description of each mode follows the flow chart.

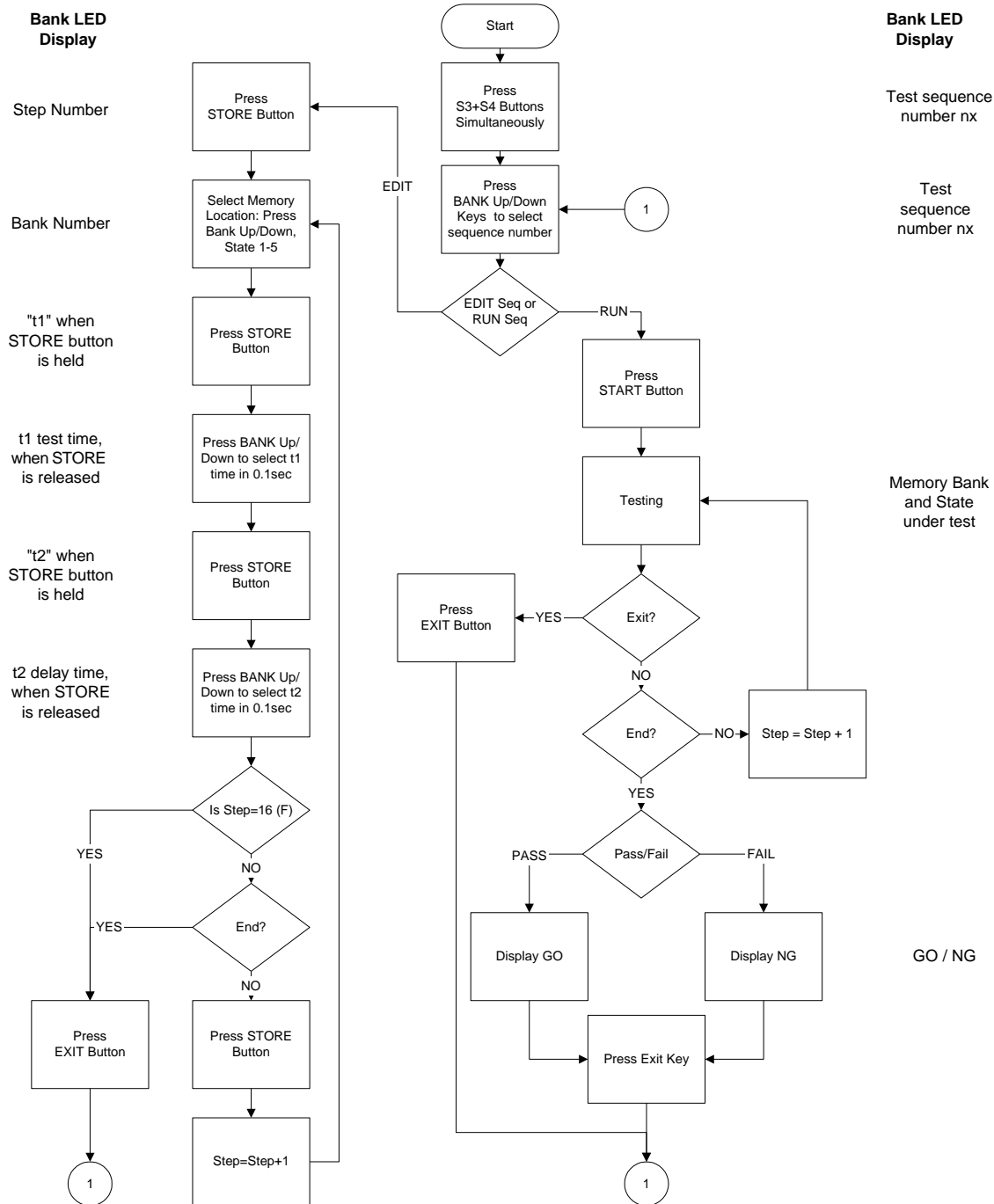

Figure 3-3 Auto Sequence Function Set-Up and Operation Flowchart

3.4.1 EDIT MODE

To enter the EDIT mode of the Sequence function, press State3 + State4 keys simultaneously (State 3 and State 4 LEDs are On, indicating Auto Sequence function is now active). Use the BANK up/down keys to select the sequence to be edited, then press the STORE key to begin the editing process.

The EDIT MODE flow chart is described below:

- Nine Auto Sequences (n1-n9) can be edited within the SLM chassis.
- Each Auto Sequence has up to 16 test steps, where each step is pulled from any of 5 Stored memory sets for AC modules (in the 5 State locations), or 150 Stored memory sets for DC modules (30 Bank memory locations in each of 5 State locations).
- Each test step has t1 (test time, or duration of test step) and t2 (delay time), the unit of time is 100mS, the range is 0.1S - 9.9S in 100mS resolution. SLM chassis will check each module GO/NG at the end of t1 (test time), the next step will be started after t2 (delay time).
- The test step sequence can include up to 16 steps, and can be terminated by pressing the EXIT key (State 2) if fewer than 16 steps are required.

3.4.2 TEST MODE

To enter the TEST Mode of Sequence function, press State 3 + State 4 keys simultaneously; (State 3 and State 4 LEDs are On, indicating Auto Sequence function is now active). Use the BANK Up/Down keys to select the sequence test to be run, then press the START key to run the test sequence.

- After pressing the START key, the SLM chassis controls the installed module to recall the memory stored in Auto-sequence (n1~n9).
- Each test sequence starts from (Step 0 - t1 - t2), then (step 1 - t1 - t2), and so on until either it completes the last step or is stopped by pressing the EXIT (State 2) key.
- The two-digit BANK LED will display "GO" (flash) if all test steps in the module pass, and will show "NG" (flash) if there is at least one failure during the test.
- At that point, you can either press the Start key to continue with another test, or press EXIT (State 2) key to quit the Auto-Sequence function.

This page intentionally left blank.

SECTION 4

GPIB/RS-232 PROGRAMMING OPERATION

4.1 INTRODUCTION

The rear panel of the SLM chassis is designed to connect with a PC (Personal Computer) or NOTEBOOK PC through GPIB or RS-232 interfaces.

4.2 RS-232 INTERFACE AND COMMANDS

The following RS-232 commands are the same as GPIB commands. The RS-232 protocol in SLM chassis is listed as follows:

BAUD-RATE 9600
 Parity none
 Data bit 8 bits
 Stop bit 1 bit
 Command delay time 20 msec.

The connections for the rear panel RS-232 interface are shown below; Figure 4-1a depicts the connector wire diagram, and Figure 4-1b depicts the connections using a standard RS-232 cable.

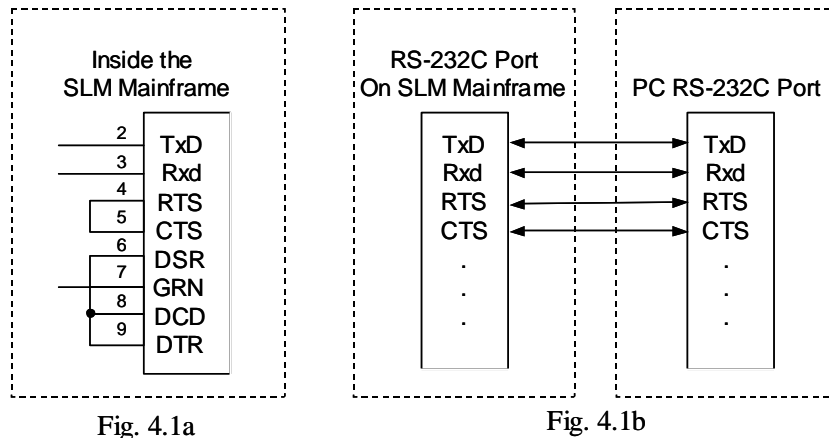

Figure 4-1 RS-232 Interface Diagram

The following RS-232 setting commands are *channel-dependent* commands except "CHAN" which is a *channel-specific* command; therefore, for proper program execution "CHAN" should be sent first, and then the *channel-dependent* command.

For example:

Short ON of Channel 1 of SL-series Electronic Load module, the RS-232 programming command is: CHAN 1;SHOR ON.

As with the GPIB commands, the following RS-232 commands with [GLOB:] option can set all the SL-series electronic load modules in the SLM chassis to be active simultaneously. This feature can greatly reduce the testing time and increase efficiency.

4.3 GPIB/RS-232C COMMAND LIST

4.3.1 Command Syntax Abbreviations

- SP** :Space, the ASCII code is 20 Hexadecimal.
- ;** :Semicolon, Program line terminator, the ASCII code is 0A Hexadecimal.
- NL** :New line, Program line terminator, the ASCII code is 0A Hexadecimal.
- N** :Integer from 1 to 8.
- NR2** :Digits with decimal point. It can be accepted in the range and format of **##.#####**.

Example: 30.12345, 5.0

Description of GPIB Programming Command Syntax.

- { } :The contents of the { } symbol must be used as a part or data of the GPIB command, it can not be omitted.
- [] :The contents of the [] symbol indicates that the command is optional, depending on the testing application.
- | :This symbol means to make a choice between one or the other. For example "HIGH|LOW" means it can only use HIGH or LOW as the command, but one of the choices must be used.
- Terminator :The program line terminator character must be sent after the GPIB command; the available command terminator characters that can be accepted in the SLM chassis are listed in Table 4-1.

LF
LF WITH EOI
CR, LF
CR, LF WITH EOI

Table 4-1 GPIB Command Terminator

A terminator informs GPIB that it has reached the end of statement. Normally, this is sent automatically by your GPIB programming statements. In this manual, the terminator is assumed at the end of

each example line of code. If it needs to be indicated, it is shown by symbol (nl); which stand for “new line” and represents ASCII code byte the OA Hexadecimal or 10 decimal.

Semicolon “;” :The semicolon “;” is a back-up command, the semicolon allows you to combine command statements on one line to create command message.

Table 4-2 presents a summary of the GPIB/RS-232 Setting commands, and Table 4-3 summarizes the GPIB/RS-232 preset Query commands with applicable module types. Table 4-4 is a summary of State commands, the System commands are in Table 4-5, Measure and Limit commands are in Table 4-6, and the Global commands are in Table 4-7.

Setting Preset Numeric Command	Model			Remark
	SLM DC	SLD	SLM AC	
[PRESet:] BANK{SP}{d}{; NL}			•	d=0~30
[PRESet:] WAVE{SP}{m}{; NL}			•	M=0~5
[PRESet:] FREQuency{SP}{NR2}{; NL}			•	40.0~70.0Hz
[PRESet:] RISE{SP}{NR2}{; NL}	•			
[PRESet:] FALL{SP}{NR2}{; NL}	•			
[PRESet:] SLEWrate{SP}{NR2}{; NL}		•		
[PRESet:] PERIod:{HIGH LOW}{SP}{NR2}{; NL}	•	•		
[PRESet:] LDONv{SP}{NR2}{; NL}	•	•		
[PRESet:] LDOFv{SP}{NR2}{; NL}	•	•		
[PRESet:] CC{SP}{NR2}{; NL}		•		
[PRESet:] CC:{A B}{SP}{NR2}{; NL}			•	
[PRESet:] CC:{HIGH LOW}{SP}{NR2}{; NL}	•	•		
[PRESet:] CP:{HIGH LOW}{SP}{NR2}{; NL}	•			
[PRESet:] CR{SP}{NR2}{; NL}		•		
[PRESet:] CR:{A B}{SP}{NR2}{; NL}			•	
[PRESet:] CR:{HIGH LOW}{SP}{NR2}{; NL}	•			
[PRESet:] CV:{HIGH LOW}{SP}{NR2}{; NL}	•			
[PRESet:] CV{SP}{NR2}{; NL}		•		

Table 4-2 GPIO/RS-232 Setting Command Summary

Query Preset Numeric Command	Model			RETURN
	SLM DC	SLD	SLM AC	
[PRESet:] BANK{SP}{?}{; NL}			•	0~10
[PRESet:] WAVE{SP}{?}{; NL}			•	1~5
[PRESet:] FREQuency{?}{; NL}			•	40.0~70.0
[PRESet:] RISE{?}{; NL}	•			###.####
[PRESet:] FALL{?}{NR2}{; NL}	•			###.####
[PRESet:] SLEWrate{?}{; NL}		•		###.####
[PRESet:] PeRIod:{HIGH LOW}{?}{; NL}	•	•		###.####
[PRESet:] LDONv{?}{; NL}	•	•		###.####
(PRESet:] LDOFv{?}{; NL}	•	•		###.####
(PRESet:] CC{?}{; NL}		•		###.####
(PRESet:] CC:(A B){?}{; NL}			•	###.####
(PRESet:] CC:{HIGH LOW}{?}{; NL}	•	•		###.####
(PRESet:] CP:{HIGH LOW}{?}{; NL}	•			###.####
[PRESet:] CR{?}{; NL}		•		###.####
[PRESet:] CR:{A B}{?}{; NL}			•	###.####
[PRESet:] CR:{HIGH LOW}{?}{; NL}	•	•		###.####
[PRESet:] CV:{HIGH LOW}{?}{; NL}	•			###.####
[PRESet:] CV{?}{; NL}		•		###.####

Table 4-3 GPIO/RS-232 Preset Query Command Summary with Applicable Module Types

STATE Command	Model			RETURN
	SLM DC	SLD	SLM AC	
[STATe:] LOAD{SP}{ON OFF}{; NL}	•	•	•	
[STATe:] LOAD{?}{; NL}	•	•	•	0=OFF, 1=ON::
[STATe:] MODE{SP}{CC CR CV CP}{; NL}	•	•	•	
[STATe:] MODE{?}{; NL}	•	•	•	0=:CC, 1=:CR 2=:CV, 3=:CP
[STATe:] SHORt{SP}{ON OFF}{; NL}	•	•	•	
[STATe:] SHORt{?}{; NL}	•	•	•	0=OFF, 1=ON::
[STATe:] PRESet{SP}{ON OFF}{; NL}	•	•	•	
[STATe:] PRESe{?}{; NL}	•	•	•	0=OFF, 1=ON::
[STATe:] SENSE{SP}{ON OFF}{; NL}	•	•	•	
[STATe:] SENSE{?}{; NL}	•	•		0=OFF, 1=ON::
[STATe:] RANGE{SP}{1 2}{; NL}				
[STATe:] RANGE{?}{; NL}				0:I, 1:II
[STATe:] LEVEl{SP}{HIG LOW AIB}{; NL}	•		•	
[STATe:] LEVEl{?}{; NL}	•		•	0=:LOW, 1=:HIGH
[STATe:] DYNAmic{SP}{ON OFF}{; NL}	•	•		
[STATe:] DYNAmic{?}{; NL}	•	•		0=:OFF, 1=:ON
[STATe:] SYNCronize{SP}{ON OFF}{; NL}			•	
[STATe:] SYNCronize{?}{; NL}			•	0=OFF, 1=ON::
[STATe:] WATT{SP}{ON OFF}{; NL}	•		•	
[STATe:] WATT{?}{; NL}	•		•	0=OFF, 1=ON::
[STATe:] CLEAr{; NL}	•	•	•	
[STATe:] ERRor{?}{; NL}	•	•	•	Dddddddd
[STATe:] DUAL{SP}{DVM DAM OFF}{; NL}		•		
[STATe:] PARAllel{SP}{ON OFF}{; NL}		•		
[STATe:] NGAB{SP}{ON OFF}{; NL}		•		0=:OK, 1=:NG
[STATe:] NGAB{?}{; NL}		•		0=:OK, 1=:NG
[STATe:] NG{?}{; NL}	•	•	•	0=:OK, 1=:NG
[STATe:] PROTEct{?}{; NL}	•	•	•	Dddddddd

Table 4-4 State Command Summary

COMMAND	NOTE	RETURN
[SYStem:] CHANnel{SP}{A B}{; NL}		
[SYStem:] CHANnel{SP}{?}{; NL}		[A B]
[SYStem:] RECall{SP}{m[,n]}{; NL}	M=1~5 n=1~30	
[SYStem:] STORe{SP}{m[,n]}{; NL}	M=1~5 n=1~30	
[SYStem:] REMOTE{; NL}	Only RS232 cmd	
[SYStem:] LOCAL{; NL}	Only RS232 cmd	0=:OFF, 1=:ON
[SYStem:] NAME{?}{; NL}		"XXXXX"

Table 4-5 System Commands - All Modules

COMMAND	SLM DC	SLD	SLM AC	RETURN
MEASure:CURRent {?}{; NL}	•	•	•	###.####
MEASure:VOLTag e {?}{; NL}	•	•	•	###.####
MEASure:PWR {?}{; NL}			•	###.####
MEASure:VA {?}{; NL}			•	###.####
LIM:CURRent:{HIGH LOW}{SP}{NR2}{; NL}	•	•	•	
LIM:CURRent:{HIGH LOW}{?}{; NL}	•	•	•	###.####
LIM:POWer:{HIGH LOW}{SP}{NR2}{; NL}	•		•	
LIM:POWer:{HIGH LOW}{?}{; NL}	•		•	###.####
LIM:VA:{HIGH LOW}{SP}{NR2}{; NL}			•	
LIM:VA:{HIGH LOW}{?}{; NL}			•	###.####
LIM:VOLTag e:{HIGH LOW}{SP}{NR2}{; NL}	•	•	•	
LIM:VOLTag e:{HIGH LOW}{?}{; NL}	•	•	•	###.####

Table 4-6 Measure and Limit Commands

COMMAND	SLM DC	SLD	SLM AC	RETURN
GLOBal:[STATe:] PRESet{SP}{ON OFF}{; NL}	•	•	•	
GLOBal:[STATe:] LOAD{SP}{ON OFF}{; NL}	•	•	•	
GLOBal:[STATe:] MODE{SP}{ON OFF}{; NL}	•	•	•	
GLOBal:[STATe:] SHORt{SP}{ON OFF}{; NL}	•	•		
GLOBal:[STATe:] DYNAmic{SP}{ON OFF}{; NL}	•	•		
GLOBal:[STATe:] LEVEl{SP}{HIGH LOW}{; NL}	•			
GLOBal:[STATe:] LEVEl{SP}{A B}{; NL}			•	
GLOBal:[STATe:] RANGe{SP}{1 2}{; NL}	•	•		
GLOBal:MEASure:CURRent{?}{; NL}	•	•	•	###.##
GLOBal:MEASure:VOLtag e{?}{; NL}	•	•	•	###.##

Table 4-7 Global Commands

REMARKS:

1. d : 0 - 9
2. GLOB : GLOBAL (ALL CHANNELS ACTIVE AT SAME TIME)
3. CURRENT ENGINEERING UNIT : A
4. VOLTAGE ENGINEERING UNIT : V
5. RESISTANCE ENGINEERING UNIT : Ω
6. PERIOD ENGINEERING UNIT : mS
7. SLEW-RATE ENGINEERING UNIT : A/ μ S

Note: The RS-232 command set is the same as the GPIB command set.

4.4 GPIB/RS-232 COMMAND DESCRIPTION

4.4.1 Setting Commands

CHANNEL

Purpose:

"CHAN" selects the multiple Electronic load channel to which all subsequent channel-specific commands will be directed.

Command Syntax:

All Modules: CHAN{SP}n{;NL}

Description:

"CHAN" command selects the specified Electronic load Channel A or B as the Electronic load module number (from left to right). This command is a channel *independent* command; therefore, this command should be programmed before an electronic load channel *dependent* command.

The load channel number command applies to SLD modules only..

Example:

CHAN A selects channel A of an installed SLD module.

Note:

Please refer to Appendices C, D and E for proper programming procedure of SL-series electronic load modules.

CURRENT Level

Purpose:

The load current setting in Constant Current mode.

Command Syntax:

All SLM Modules: CC:{LOW|HIGH}{SP}{NR2}{;|NL}

SLD Modules: CC{SP}{NR2}{;|NL}

Description:

CC:{LOW|HIGH}{SP}{NR2}{;|NL}

Sets the current level of SLM-series AC or DC Electronic Load modules.

CC:{SP}{NR2}{;|NL}

This command is used to set the load current level for CC static mode of SLD-series electronic load module.

Note:

- a. The load current data must include the decimal point; otherwise, this command will not execute. The load current level can be programmed up to the sixth place after the decimal point.
- b. The HIGH level load current **MUST** be higher than the LOW level load current (and vice versa) for proper dynamic waveform definition; if not, the SLM-series Electronic Load will adjust and limit the programmed values to be equal. The adjustment matches the second input value to the first input value. This means that if the value for the LOW level is input first, and then the HIGH level value is input as less than the programmed LOW level, the SLM-series load module will adjust the HIGH level to be equal to the LOW level. If the value for the HIGH level is input first and the LOW level value is input as higher than the programmed HIGH level, the SLM-series load module will adjust the LOW level to be equal to the HIGH level.
- c. If the programmed load current level is over the maximum rated specification, the full scale current will be sent to the load module.
- d. Engineering unit for load current is Amps.
- e. Please refer to Appendices C, D and E for proper programming procedure of SL-series electronic load modules.

Example:

CC:LOW 1.8 set LOW level load current to 1.8 A.

CC:HIGH 25.123456 set HIGH level load current to 25.123456 A.

RESISTANCE Level

Purpose:

The load resistance setting in Constant Resistance mode.

Command Syntax:

All SLM Modules: CR:{HIGH|LOW}{SP}{NR2}{;|NL}

SLD Modules CR:{SP}{NR2}{;|NL}

Description:

CR:{HIGH|LOW}{SP}{NR2}{;|NL}

This command is used to set the LOW/HIGH load resistance level of SLM series AC and DC electronic load module.

CR:{SP}{NR2}{;|NL}

This command is used to set the load resistance level of SLD-Series load module.

Note:

- a. The load resistance data must include the decimal point; otherwise, this command will not execute. The load resistance level can be programmed up to the sixth place after the decimal point.
- b. The HIGH level load resistance **MUST** be higher than the LOW level load resistance (and vice versa) for proper dynamic waveform definition; if not, the SLM-series Electronic Load will adjust and limit the programmed values to be equal. The adjustment matches the second input value to the first input value. This means that if the value for the LOW level is input first, and then the HIGH level value is input as less than the programmed LOW level, the SLM-series load module will adjust the HIGH level to be equal to the LOW level. If the value for

the HIGH level is input first and the LOW level value is input as higher than the programmed HIGH level, the SLM-series load module will adjust the LOW level to be equal to the HIGH level.

- c. If the programmed load resistance level is over the maximum rated specification, the full scale resistance will be sent to the load module.
- d. Engineering unit for load resistance is Ohms.
- e. Please refer to Appendices C, D and E for proper programming procedure of SL-series electronic load modules.

Example:

CR:LOW 0.123 set LOW level load resistance to 0.123 OHM.

CR:HIGH 3.456789 set HIGH level load resistance to 3.456789 OHM.

VOLTAGE Level**Purpose:**

The load voltage setting in Constant Voltage mode.

Command Syntax :

SLM DC Modules: CV:{HIGH|LOW}{SP}{NR2}{;|NL}

SLD Modules: CV:{SP}{NR2}{;|NL}

Description:

CV:{HIGH|LOW}{SP}{NR2}{;|NL}

This command is used to set the load voltage level of SLM-series DC electronic load modules.

CV {SP}{NR2}{;|NL}

This command is used to set the load voltage level of SLD-series electronic load modules.

Notes:

- a. The load voltage data must include the decimal point; otherwise, this command will not execute. The load voltage level can be programmed up to the sixth place after the decimal point.
- b. The HIGH level load voltage MUST be higher than the LOW level load voltage (and vice versa) for proper dynamic waveform definition; if not, the SLM-series Electronic Load will adjust and limit the programmed values to be equal. The adjustment matches the second input value to the first input value. This means that if the value for the LOW level is input first, and then the HIGH level value is input as less than the programmed LOW level, the SLM-series load module will adjust the HIGH level to be equal to the LOW level. If the value for the HIGH level is input first and the LOW level value is input as higher than the programmed HIGH level, the SLM-series load module will adjust the LOW level to be equal to the HIGH level.
- c. If the programmed load voltage level is over the maximum rated specification, the full scale voltage will be sent to the load module.
- d. Engineering unit for load current is Volts.
- e. Please refer to Appendices C, D and E for proper programming procedure of SL-series electronic load modules.

Example:

CV:LOW 3.0 set LOW level load voltage to 3.0 V.

CV:HIGH 45.123456 set HIGH level load voltage to 45.123456 V.

POWER Level**Purpose:**

The load power setting in Constant Power mode.

Command Syntax:

SLM DC Modules: CP:{HIGH|LOW}{SP}{NR2}{;|NL}

Description:

This command is used to set the load Power level of electronic load modules.

Note : Mode CP is available in SLM-series DC loads only.

LOAD ON/OFF**Purpose:**

Turn the Electronic load module input ON or OFF.

Command Syntax:

All Modules: [GLOB:]LOAD{SP}{OFF|ON}{NL}

Description:

This command sets the Electronic load to sink current from power source. GLOB:LOAD ON All the Electronic load modules in the SLM chassis are ready to sink current from power source.

Example:

GLOB:LOAD OFF ; All load modules in the SLM chassis are at input OFF condition.

CHAN 3:LOAD ON ; Set the channel 3 load module to LOAD ON status, this load module is ready to sink current from the power source.

CHAN 1:LOAD 0; Set the channel 1 load module to LOAD OFF.

LOAD ON VOLTAGE Setting**Purpose:**

The Load ON voltage setting (Initial is 1.0V) of DC electronic load modules.

Command Syntax:

SLM DC, SLD Modules: LDON{SP}{NR2}{;|NL}

Description:

The Load On voltage can be adjusted by the LDON command. The range is 0.1-25.0 V (Res. = 0.1V). The load will start to sink current if power source output voltage is higher than Load On voltage.

Example:

LDON 2.5; Set the Load On voltage to 2.5V, The load will start to sink current when the power source output voltage is higher than 2.5V.

LOAD OFF VOLTAGE Setting**Purpose:**

The Load OFF voltage setting (Initial is 0.5V) of DC electronic load modules.

Command Syntax:

SLM DC, SLD Modules: LDOF{SP}{NR2}{;|NL}

Description:

The Load Off voltage can be adjusted by the LDOF command; the adjust range is 0.1-load on voltage (Res. = 0.1V. The load will stop to sink current if power source output voltage is lower than Load Off voltage.

Example:

LDOF 2.0 ; Set the Load Off voltage to 2.0V. The load will start to sink current when power source output voltage is lower than 2.0V.

LEVEL HIGH/LOW**Purpose:**

Select Low or High level in static mode, of DC electronic loads, or LEVEL A/B of AC electronic loads.

Command Syntax:

All Modules: [GLOB:] LEVE {SP}{HIGH|LOW}{NL}

Description:

LEVE LOW is Set LOW current level in CC mode, LOW resistance level in CR mode, or LOW voltage level in CV mode at the active load channel.

LEVE 1 is Set HIGH current level in CC mode, HIGH resistance level in CR mode, or HIGH voltage level in CV mode at the active load channel.

PRESET ON/OFF**Purpose:**

Set the upper or lower digit multi-function meter to display the programming load level.

Command Syntax:

All Modules: [GLOB:]PRES{SP}{0|1|OFF|ON}{NL}

Description:

GLOB:PRES ON is set all the load module in the SLM chassis to preset on status.

MODE**Purpose:**

Select the operating mode of Electronic load module.

Command Syntax:

All Modules: [GLOB:]MODE{SP}{0|1|2|3|CC|CR|CV|CP}{NL}

Description:

GLOB:MODE CC ; set the presently operating mode to Constant Current mode for all load module in the SLM chassis.

MODE CV ; set the presently operating mode to Constant Voltage mode.

MODE 1 ; set the presently operating mode to Constant Resistance mode.

MODE CP ; set the presently operation mode to Constant Power mode.

Note:

MODE CV is available in DC loads only.

MODE CP is available in DC, single input loads only.

CLEAR status register

Purpose:

CLEAR the PROT and ERR status byte registers.

Command Syntax:

All Modules: CLER{NL}

Description:

CLER ; clear the PROT and ERR status byte register, the PROT and ERR status byte register will indicate "0" after executing the CLER command.

STORE

Purpose:

STORE the load level and load status into the memory of the SL-series electronic LOAD.

Command Syntax:

SLM DC, SLD Modules: STOR{SP}{m[,n]};|NL}

SLM AC Modules: STOR{SP}{m};|ML}

Description:

Parameter m is 1~5 for 5 different states with SL-series electronic load module's load status and load current into the non-volatile memory.

Parameter n is 1-30 for 30 memory bank for 150 (m*n) different state with DC electronic load module's load status and load current into the EEPROM memory in the electronic loads.

Example:

STORE 1; store the AC electronic load module's load status and load current into the memory 1.

STORE 2,30; store the DC electronic load module's load status and load current into the memory 147.

RECALL

Purpose:

Recall the state of load level and status, is stored by the GPIB/RS232 STORE command.

Command Syntax:

SLM DC, SLD Modules: REC{SP}{m[,n]};|NL}

SLM AC Modules: REC{SP}{m};|NL}

Description:

This command is used to recall the memory state, is stored into memory by the GPIB/RS232 STORE command, up to 5 states can be recalled for AC electronic load modules, and up to 150 states can be recalled for DC electronic load modules.

Example:

REC 1; Recall the state of load level and status that is stored in memory 1 by GPIB/RS232 STOR command.

REC 147; Recall the state of load level and status that is stored in memory 147 by GPIB/RS232 STOR command.

SYNCHRONOUS ON/OFF**Purpose:**

To set synchronous function ON/OFF of SLM AC series electronic load module.

Command Syntax:

SLM AC Modules: SYNC{SP}{0|1|OFF|ON}{;|NL}

Description:

1. External synchronous signal (SYNC ON): Using external synchronous signal as the synchronous triggering signal of the electronic load thus making the load current synchronous with the voltage.
2. Internal synchronous signal (SYNC OFF): Using the signal at the terminal of the input connector thus generating synchronous signal through the internal zero-crossing circuit and isolated circuit.

Example:

SYNC ON ; To set external synchronization.

SYNC OFF ; To set internal synchronization.

WATT Meter ON/OFF**Purpose:**

To set display of power meter of SLM AC series electronic load module.

Command Syntax:

SLM AC Modules: WATT{SP}{0|1|OFF|ON}{;|NL}

Description:

This command is to set the power meter display. This command must be used in conjunction with PRES:OFF. When setting to ON, the top monitor will change from voltmeter to Watt meter while the monitor at the bottom will change from ammeter to Volt-Ameter (VA) and the unit is "W" and "VA" respectively. When setting to OFF, the Watt meter on the top will change back to voltmeter while the VA meter at the bottom will change back to ammeter and the unit is "Vrms" and "Arms" respectively.

Example:

PRES OFF

WATT ON ; to display WATT, VA meter.

WATT OFF ; to display Voltage, Current meter.

WAVEFORM BANK**Purpose:**

To set waveform bank for AC electronic load modules.

Command Syntax:

SLM AC Modules: BANK{SP}{d}{;|NL} d:0-10

Description:

This command is to set the desired waveform bank.

1. waveform bank 0-4 are sine wave.
2. waveform bank 5-9 are square wave.
3. waveform bank 10 is DC.
4. There are five (5) waveforms for each of eleven (11) waveform banks for a total of 55 waveforms. Waveform information is shown in Table 4-8.

Example:

BANK 1, to set waveform bank 1.

BANK 10, to set waveform bank 10.

	Waveform Bank	m=1	m=2	m=3	m=4	m=5
Sine Wave	0	$\sqrt{2}$	2.0	2.5	3.0	3.5
	1	1.5	1.6	1.7	1.8	1.9
	2	2.0	2.1	2.2	2.3	2.4
	3	2.5	2.6	2.7	2.8	2.9
	4	3.0	3.1	3.2	3.3	3.4
Square Wave	5	1.0	1.1	1.2	1.3	1.4
	6	1.5	1.6	1.7	1.8	1.9
	7	2.0	2.1	2.2	2.3	2.4
	8	2.5	2.6	2.7	2.8	2.9
	9	3.0	3.1	3.2	3.3	3.4
DC	10	$\sqrt{2}dc$	2dc	2.5dc	3.0dc	3.5dc

Table 4-8 Waveform Information

WAVEFORM

Purpose:

To set waveform for AC electronic load modules.

Command Syntax:

SLM AC Modules: WAVE{SP}{m}{;|NL} m:1-5

Description:

This command is to set the current Crest Factor (C.F.) at CC MODE (Peak Value Factor).

This command works only at CC MODE. When BANK varies, these 5 sets of C.F. will at the same time define different C.F. as shown in Table 4-8. For details, please refer to SLM AC Operation Manual.

Example:

WAVE 2 ; To set 2nd set C.F.

WAVE 5 ; To set 5th set C.F.

FREQUENCY

Purpose:

Setting of Frequency Value for AC electronic load modules.

Command Syntax:

SLM AC Modules: FREQ{SP}{NR2}{;|NL}

Description:

This command is for setting the frequency value of electronic load. To use this command, attention must be paid to the following items:

- The frequency value designated must include the decimals, otherwise, the command will become null and void.
- The minimum effective digit of the value is the fifth place after the decimal point.

- If the value designated exceeds the specification of the electronic load, the chassis will send out the full scale current value of the electronic load specification.
- The frequency range is 40.0~70.0Hz.

The engineering unit for frequency is Hz.

Example:

FREQ 50.0, to set frequency is 50.0Hz.

FREQ 60.0, to set frequency is 60.0Hz.

FREQ 0.1, to set frequency is 0.1Hz, that is to set DC.

VOLTAGE Limit

Purpose:

To set the upper/lower limit value of threshold voltage.

Command Syntax:

All Modules: LIM:VOLT:{HIGH|LOW}{SP}{NR2}{;|NL}

Description:

This command is to set the upper/lower limit value of threshold voltage. When input voltage is lower than the lower limit value or higher than the upper limit value, NG indicating light will come on to indicate "NO GOOD."

Example:

LIM:VOLT:LOW 1.0 ; To set the lower limit value of threshold voltage to 1.0 V.

LIM:VOLT:HIGH 200.0 ; To set the upper Limit vale of threshold voltage to 200.0V.

CURRENT Limit

Purpose:

To set the upper/lower limit value of threshold current.

Command Syntax:

All Modules: LIM:CURR{HIGH/LOW}{SP}{NR2}{;|NL}

Description:

This command is to set the lower limit value of threshold current. When load sink current is lower than this lower limit value or higher than the upper limit value, NG indicating light will come on to indicate "NO GOOD."

Example:

LIM:CURR:LOW:0.05 ; To set the lower limit value of threshold current to 0.05A.

LIM:CURR:HIGH:10.0 ; To the upper limit value of threshold current to 10.0A.

POWER Limit

Purpose:

To set the upper/lower limit value of threshold power (W).

Command Syntax:

SLM DC Modules: LIM:POW:{HIGH|LOW}{SP}{NR2}{;|NL}

Description:

This command is to set the upper/lower limit value of threshold power (WATT). When power (WATT) is lower than this lower limit value or higher than the upper limit value, NG indicating light will come on to indicate "NO GOOD."

Example:

LIM:POW:LOW 0.05 ; To set the lower limit value of threshold power (W) to 0.05 W.

LIM:POW:HIGH 250.0 ; To set the upper limit value of threshold power(W) to 250.0 W.

VA Limit

Purpose:

To set the upper/lower limit value of threshold power (VA).

Command Syntax:

SLM AC Modules: LIM:VA:{HIGH|LOW}{SP}{NR2}{;|NL}

Description:

This command is to set the upper/lower limit value of threshold power (VA). When power (VA) is lower than this lower limit value or higher than the upper limit Value, NG indicating light will come on to indicate "NO GOOD."

Example:

LIM:VA:LOW 0.05 ; To set the lower limit value of threshold power (VA) is 0.05 VA.

LIM:VA:HIG 250.0 ; To set the upper limit value of threshold power(VA)is 250.0 VA.

PERIOD

Purpose:

Set the Tlow/Thigh duration of dynamic load in Constant Current mode.

Command Syntax:

SLM DC, SLD Modules: PERI:{LOW|HIGH}{SP}{NR2}{NL}

Description:

The PERiod of dynamic waveform is composed by Tlow and Thigh. The PERIOD LOW and HIGH data must include decimal point, otherwise this command will not execute.

The value for PERIOD LOW and HIGH can be programmed up to the sixth place after the decimal point. If the period of Tlow and Thigh setting is over the maximum specification at programmed range of load module, the maximum duration of Tlow and Thigh will be sent to the load module.

Please verify the appropriate timer range before executing the load PERI LOW or HIGH command, otherwise the PERI load module will adjust to fit the Tlow and Thigh ranges after programming the PERI LOW or HIGH command. The engineering unit for PERI LOW and HIGH is "ms."

Note:

1. There are four timer ranges in the Tlow / T high generator to produce a wide period dynamic range, these ranges are adjusted by the load module automatically which depends on the programmed Tlow / Thigh range.
2. Example: CHA and CHB use the same T-high and T-low controller in the SLD-series modules.

Example:

PERI:LOW 0.125;PERI:HIG 0.8

Set the LOW dynamic load duration to 0.125 ms, and the HIGH dynamic load duration to 0.8 ms.

RISE Time

Purpose:

RISE load current slew rate setting.

Command Syntax:

SLM DC Modules: RISE{SP}{NR2}{NL}

Description:

The RISE load current slew rate of load level change or dynamic load can be programmed by RISE command. The RISE slew rate of SLM-series DC electronic load modules can be fully independent from the FALL slew rate.

The RISE load current slew rate data must include a decimal point, otherwise this command is will not execute.

The value for the RISE load current slew rate can be programmed up to sixth place after the decimal point. If the programming load current level is over the maximum specification at the programmed range of SLM DC series load module, the fastest RISE slew rate will be sent to the load module. Please verify the range I/II command before execute the load RISE slew rate setting command, otherwise the load module will adjust to fit the RISE slew rate after programming the RISE command. The engineering unit for RISE slew rate is "A/us."

Example:

RISE 1.25 set RISE slew rate to 1.25 A/us.

FALL Time

Purpose:

FALL load current slew rate setting.

Command Syntax:

SLM DC Modules: FALL{SP}{NR2}{NL}

Description:

Programs the FALL load current slew rate of load level change or dynamic load. The FALL slew rate of SLM DC electronic load modules can be fully independent of the RISE slew rate.

The FALL load current slew rate data must include a decimal point, otherwise this command will not execute. The value for FALL load current slew rate can be programmed up to the sixth place after the decimal point. If the programming load FALL slew rate is over the full-scale specification, the fastest FALL slew rate will be sent to the load module. Please verify the range I/II command before executing the load FALL slew rate setting command, otherwise, the load module will adjust to fit the FALL slew rate after programming the FALL command.

The engineering unit for FALL slew rate is "A/μs".

Example:

FALL 0.124 set FALL slew rate to 0.124 A/μs.

SLEW Rate**Purpose:**

Set the load current slew rate of SLD-series electronic load module.

Command Syntax:

SLD Modules: SLEW{SP}{NR2}{;|NL}

Description:

Rise and Fall slew rate is the same for the SLEW command setting of SLD electronic load module.

The Slew rate has two ranges, and it follows the CC mode range change automatically: when CC Dynamic mode is in Range I, the slew rate is in range I, if CC Dynamic mode is in range II, then Slew rate is in range II.

SHORT ON/OFF**Purpose:**

Short the DC input of Electronic load module.

Command Syntax:

SLM DC, SLD Modules: [GLOB:]SHOR{SP}{0|1|OFF|ON}{NL}

Description:

This command applies the short across the input of the Electronic load. Executing SHOR does not affect any programmed settings and the Electronic load will return to those settings when the short is removed.

Example:

GLOB:SHOR ON ; set all load module load input to short state.

CHAN 2;SHOR OFF ; set channel 1, 2 load module load input short open state.

SENSE ON/OFF**Purpose:**

Set the voltage sense ON/OFF of Electronic load.

Command Syntax:

All Modules: [GLOB:]SENS{SP}{0|1|OFF|ON}{NL}

Description:

Set the Vsense inputs Off or On. If Vsense is set to Off, voltage measurement is taken at the load input terminals. If Vsense is set to On, voltage is measured at the Vsense input. On SLM-series DC loads, Vsense is auto/off or on. If it is set to auto/off, the module will measure the Vsense input if the voltage is greater than 1V (on 60V models) or 3V (on 250 and 500V models).

Example:

GLOB:SENS ON set all load module V-sense input to sense ON state.

CHAN 2;SENS OFF set channel 1, 2 load module V-sense input to sense OFF state.

DYNAMIC ON/OFF**Purpose:**

Set DYNamic ON or OFF command.

Command Syntax:

SLM DC, SLD Modules: [GLOB:]DYN{SP}{0|1|OFF|ON}{NL}

Description:

GLOB:DYN OFF ; set all DC load modules in the SLM chassis to static load mode.

CHAN 4;DYN 1 ; set channel 4 load module to dynamic load mode.

NG Enable /Disable**Purpose:**

Set Meter GO/NG check ON or OFF.

Command Syntax:

SLD Modules: NGAB{SP}{OFF|ON}{;|NL}

Description:

Setting NG ON or OFF indicates that the NG check is enabled or disabled; the NG ON or OFF can be changed by NGAB ON/OFF command. The Load GO/NG check includes voltage and current meter GO/NG check, so user can set the current's Upper limit to max. and set the lower to min. if the current meter NG check is not required and vice versa.

Note : When CH A NG is set to OFF, the front panel NG A LED is disabled.

Note : When CH B NG is set to OFF, the front panel NG B LED is disabled.

PARAllel ON/OFF**Purpose:**

A // b; Parallel Load Channel A and B for SLD-series electronic load.

Command Syntax :

Common Voltage SLD Modules: PARA{SP}{ON|OFF}{;|NL}

Description:

The parallel ON/OFF command is available for SLD-60-505-255-SLD-60-20-102 and SLD-62-5-752 modules. PARA command to set ON (Parallel) or OFF (Not Parallel). Dual Load parallel operation is available for same polarity load in a module; it can be a two positive or two negative load.

During the parallel loading operation, the load level and status of CH A and B is still independent. Only the current meter shows the CH A + CH B load current on Channel A's and B's current meter; user can use the DUAL command setting to display load current for CH A and B.

For the 2+ or 2- load parallel operation, user should make a wire connection from each load channel input to power supply output.

DUAL**Purpose:**

Setting the Dual voltage or Dual current meter display of the SLD-series electronic load module.

Command Syntax:

SLD Modules: DUAL{SP}{DVM|DAM|OFF}{;|NL}

Description:

The Dual V/A command is not controlled by CH A/B operation; it is an independent command operation. This command is used for dual voltage meter or current meter to be displayed on the two 5-digit LED displays.

DUAL DVM; To set the meter is in dual voltage meter mode, the engineering unit is "V".

DUAL DAM; To set the meter is in dual current meter mode, the engineering unit is "A".

DUAL OFF; Disable the dual meter function, the upper 5-digit LED display is voltage meter, the lower 5-digit LED display is current meter.

4.4.2 Query Commands

CHANNEL

Purpose:

The active channel query command.

Command Syntax:

System: CHAN?{NL}

Description:

CHAN? return the active channel, "1-4" indicate the active channel is channel "1-4".

CURRENT Level

Purpose:

The Constant Current mode's load current level query command.

Command Syntax:

All SLM Modules: CC:{HIGH|LOW}{?}{;|NL}

SLD Modules: CC{?}{;|NL}

Description:

CURR:LOW? return the presently programmed low load current level in Constant Current mode of SLM-series DC or AC electronic load module.

CURR? return the presently programmed load current level in Constant Current mode of SLD-series electronic load module.

RESISTANCE Level

Purpose:

The Constant Resistance mode's load resistance level query command.

Command Syntax:

All SLM Modules: CR:{HIGH|LOW}{?}{;|NL}

SLD Modules: CR{?}{;|NL}

Description:

RES:LOW? returns the presently programmed low load resistance level in Constant Resistance mode of SLM-series DC or AC electronic load module.

RES? returns the presently programmed load resistance level in Constant Resistance mode of SLD-series electronic load module.

The engineering unit is "OHM".

VOLTAGE Level

The Constant Voltage mode's load voltage level query command.

Command Syntax:

SLM DC Modules: CV:{LOW|HIGH}?{NL}

SLD Modules: CV:{NL}

Description:

CV:LOW? return the presently programmed low load voltage level in Constant Voltage mode of SLM DC electronic load module.

CV:HIGH? return the presently programmed high load voltage level in Constant Voltage mode of SLM DC electronic load module.

The engineering unit is "V".

POWER Level

The Constant Power mode's load power level query command.

Command Syntax:

SLM DC Modules: CP:{LOW|HIGH}?{NL}

Description:

CP:LOW? return the presently programmed low load power level in Constant Power mode of SLM DC electronic load module.

CP:HIGH? return the presently programmed high load power level in Constant Power mode of SLM DC electronic load module.

The engineering unit is "W".

LOAD ON/OFF**Purpose:**

LOAD ON or LOAD OFF status query command.

Command Syntax:

All Modules: LOAD?{NL}

Description:

LOAD? returns the present load status, "0" indicates LOAD OFF, and "1" indicates LOAD ON.

LOAD ON Voltage**Purpose:**

LOAD ON voltage level query command.

Command Syntax:

SLM DC, SLD Modules: LDON?{;|NL}

Description:

LDON? returns the present load on voltage of SLD-series electronic load module.

LOAD OFF Voltage**Purpose:**

LOAD OFF voltage level query command.

Command Syntax:

SLM DC, SLD Modules: LDOF?{;|NL}

Description:

LDOF? returns the present load off voltage of SLD-series electronic load module.

LEVEL HIGH/LOW**Purpose:**

Static mode's LEVEL low or high status query command or active LEVEL of AC electronic load query command.

Command Syntax:

SLM Modules: LEVE?{NL}

Description:

LEVE? returns the present level status, "0" indicates LEVEL LOW, and "1" indicates LEVEL HIGH.

PRESET ON/OFF**Purpose:**

PRESet ON or OFF status query command.

Command Syntax:

All Modules: PRES?{NL}

Description:

PRES? returns the present preset status, "0" indicates PRESet OFF, and "1" indicates PRESet ON.

MODE**Purpose:**

CC, CR, CV or CP operating mode query command.

Command Syntax:

All Modules: MODE?{NL}

Description:

MODE? returns the present operating mode status, "0" indicates CC MODE, "1" indicates CR MODE, and "2" indicates CV MODE, "3" indicates CP MODE.

CV MODE is available DC electronic loads (except 500V models).

CP MODE is available in SLM DC electronic load modules.

NAME**Purpose:**

Electronic Load module model number query command.

Command Syntax:

All Modules: NAME?{NL}

Description:

NAME? return the active Electronic Load channel's model number.

PROTECTION Status Register

Purpose:

OPP, OTP, OVP, and OCP protection status query command.

Command Syntax:

All Modules: PROT?{NL}

Description:

PROT? returns the present protection status; the status byte register summarizes all of the protection status events from all status register. The following figure describes the status byte that occurred on the SLM-series Electronic load. The PROT status byte register is cleared when a CLER command clears all of the PROT and ERR status registers.

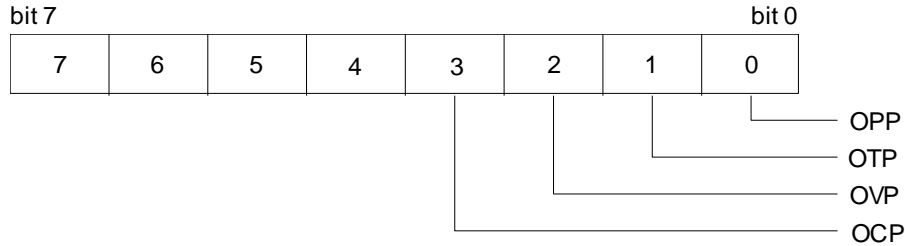

Figure 4-2 Protection Status Register

ERROR Status register

Purpose:

ERRor status register query command.

Command Syntax:

All Modules: ERR?{;|NL}

Description:

ERR? returns the present error status; the status byte register summarizes all of the error status events from all status registers. the following figure describes the status byte the happened on the SLM-series electronic load. The ERR status byte register is cleared when a CLER command clears all of the PROT and ERR status registers.

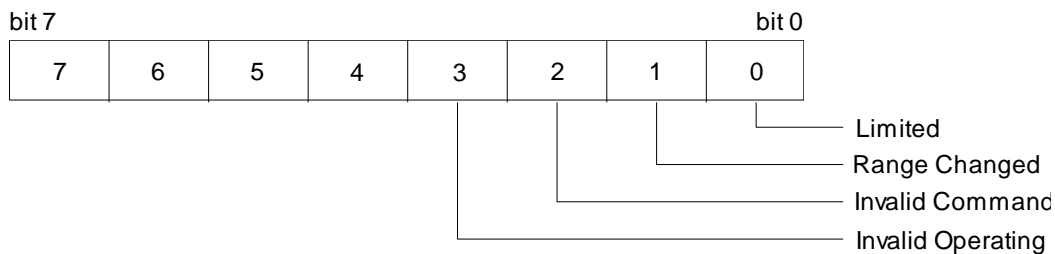

Figure 4-3 Error Status Byte Register

bit 0: Limited

This bit set to high by Electronic Module Load setting command causing over range. Reset by CLER command.

Example:

Module SLM-60-60-300
 MODE CC
 RANG 1

CURR:HIGH 20.0
setting current 20.0 A
actual setting current 3.071 A
bit 0 will set to high

bit 1:Range Changed

This bit set to high by Electronic Module Load setting command causing change range. Reset by CLER command.

Example:

Module SLM-60-60-300
FALL 0.050 MA
FALL 100.0 MA
setting fall time to 100.0 MA will change range then bit 1 will set to high.

bit 2 :invalid command

This bit set to high by accepted illegal command.

bit 3 :invalid operating

This bit set to high by accepted invalid operating command.

Example:

Module SLM-60-60-300
MODE CR
DYN ON
DYNAMIC function only supports CC MODE.

VOLTAGE METER**Purpose:**

The reading of 4 1/2 digit voltage meter read back query command.

Command Syntax:

All Modules: MEAS:VOLT?{NL}

Description:

MEAS:VOLT? returns the present 4 1/2 digital voltage meter reading. The returned data format is shown in Table 4-2, the engineering unit is "V".

CURRENT METER**Purpose:**

The reading of 4 1/2 digit current meter read back query command.

Command Syntax:

All Modules: MEAS:CURR?{NL}

Description:

MEAS:CURR? returns the present 4 1/2 digital current meter reading. The engineering unit is "A."

POWER METER**Purpose:**

To read the value of Watt meter.

Command Syntax:

SLM Modules: MEAS:POW?{;|NL}

Description:

MEAS:POW? Reads back the value of 4 digit of the Watt meter; unit is (W).

VA METER**Purpose:**

To read the value of VA meter.

Command Syntax:

SLM AC Modules: MEAS:VA?{;|NL}

Description:

MEAS:VA? Reads back the value of 4 digit of VAmeter, unit is (VA).

GLOB:GLOBAL (All channels active at the same time)

If a channel does not have a module installed, read back will be 9999, to input buffer.

GLOB:MEAS:VOLT**Purpose:**

The reading of 4 1/2 digit voltage meter from channel 1 to channel 4 read back query command.

Command Syntax:

All Modules: GLOB:MEAS:VOLT?{NL}

Description:

GLOB:MEAS:VOLT? returns the present 4 1/2 digital voltage meter reading from channel 1 to channel 4 respectively. The returned data format is shown in Table 4-2, the engineering unit is "V".

Example:

GLOB:MEAS:VOLT?

read back data is 4.998, 12.002, 9999., 11.998 where channel 1 voltage is 4.998V, channel 2 voltage is 12.002V, channel 3 is non-installed, channel 4 voltage is 11.998V.

GLOB:MEAS:CURR**Purpose:**

The reading of 4 1/2 digit current meter from channel 1 to channel 4 read back query command.

Command Syntax:

All Modules: GLOB:MEAS:CURR?{NL}

Description:

GLOB:MEAS:CURR? returns the present 4 1/2 digital current meter reading from channel 1 to channel 4 respectively. The engineering unit is "A".

Example:

GLOB:MEAS:CURR?

read back data is 4.998, 3.002, 9999., 0.998 where channel 1 current is 4.998 A, channel 2 current is 3.002 A, channel 3 is non installed, channel 4 current is 0.998 A.

SYNCHRONOUS ON/OFF**Purpose:**

To read the setting condition of SYNC.

Command Syntax:

SLM AC Modules: SYNC?{;|NL}

Description:

SYNC? Reads back the condition of SYNC. "0" denotes OFF, "1" denotes ON.

SENSE ON/OFF**Purpose:**

To read the setting condition of Sense ON or OFF.

Command Syntax:

All Modules: SENS?{;|NL}

Description:

SENS? Reads back the setting condition of SENS. "0" denotes OFF, "1" denotes ON.

WATT Meter ON/OFF**Purpose:**

To read the setting condition of WATT.

Command Syntax:

SLM Modules: WATT?{;|NL}

Description:

WATT? Reads back the setting condition of WATT. "0" denotes OFF, "1" denotes ON.

WAVEFORM BANK**Purpose:**

To read the set value of BANK

Command Syntax:

SLM AC Modules: BANK?{;|NL}

Description:

BANK? Reads back the set value of BANK. 0-10 denotes waveform bank of level 0-10.

WAVEFORM**Purpose:**

To read the set value of WAVE.

Command Syntax:

SLM AC Modules: WAVE?{;|NL}

Description:

WAVE? Reads back the set value of WAVE. 1-5 denotes the C.F. setting of level 1-level 5.

FREQUENCY**Purpose:**

To read the set frequency of FREQ.

Command Syntax:

SLM AC Modules: FREQ?{;|NL}

Description:

Reads back the set frequency of FREQ, unit is Hz.

VOLTAGE Limit**Purpose:**

To read the set value of upper/lower limit value of threshold voltage.

Command Syntax:

All Modules: LIM:VOLT:{HIGH/LOW}?{;|NL}

Description:

LIM:VOLT:LOW? Reads back the lower limit set value of threshold voltage; unit is "volts" (V).

CURRENT Limit**Purpose:**

To read the set value of upper/lower limit value of threshold current.

Command Syntax:

All Modules: LIM:CURR{HIGH|LOW}?{;|NL}

Description:

LIM:CURR:LOW? Reads back the lower limit set value of threshold current; unit is "amps (A)".

POWER Limit**Purpose:**

To read the set value of upper/lower limit value of threshold power (W).

Command Syntax:

SLM DC Modules: LIM:POW{HIGH|LOW}?{;|NL}

Description:

LIM:POW:LOW? Reads back the lower limit set value of threshold power; unit is "watts" (W).

VA Limit**Purpose:**

To read the set value of upper/lower limit value of threshold power (VA).

Command Syntax:

SLM AC Modules: LIM:VA{HIGH|LOW}?{;|NL}

Description:

LIM:VA:LOW? Reads back the lower limit set value of threshold power, unit is (VA).

NG**Purpose:**

To read the set value of NG.

Command Syntax:

All Modules: NG?{;|NL}

Description:

NG? Reads back the condition indicating light of NG. "0" denotes that NG (NO GOOD) indicating light has been extinguished. "1" denotes that NG indicating light has been lit.

NG Enable /Disable**Purpose:**

To read NG ON/OFF setting.

Command Syntax:

SLD Modules: NGAB{?}{;|NL}

Description:

NGAB? returns the presently NG ON/OFF status, "0" indicates NG disable, and "1" indicates NG enable.

PERIOD**Purpose:**

The dynamic mode's Tlow or Thigh duration query command

Command Syntax:

SLM DC, SLD Modules: PERI:{LOW|HIGH}?{NL}

Description:

PERI:LOW? returns the presently programmed low duration time in dynamic load mode
PERI:HIGH? returns the presently programmed high duration time in dynamic load mode
The engineering unit is "msec".

RISE Time**Purpose:**

The dynamic load mode's RISE slew rate query command

Command Syntax:

SLM DC Modules: RISE?{NL}

Description:

RISE? returns the presently programmed low load current level in Constant Current mode
The engineering unit is "A/us".

FALL Time**Purpose:**

The dynamic load mode's FALL slew rate query command.

Command Syntax:

SLM DC Modules: FALL?{NL}

Description:

FALL? returns the presently programmed low load current level in Constant Current mode
The engineering unit is "A/us".

SHORT ON/OFF**Purpose:**

SHORT ON or OFF status query command.

Command Syntax:

SLM DC, SLD Modules: SHOR?{NL}

Description:

SHOR? returns the presently SHORT status, "0" indicates SHORT OFF, and "1" indicates SHORT ON.

DYNAMIC ON/OFF**Purpose:**

DYNamic ON or OFF status query command

Command Syntax:

SLM DC, SLD Modules: DYN?{NL}

Description:

DYN? returns the presently DYNamic ON or OFF status, "0" indicates static load mode or DYNamic OFF, and "1" indicates DYNamic load mode or DYNamic ON.

This page intentionally left blank.

APPENDIX A

GPIB PROGRAMMING EXAMPLE

Example Program in C

```
/* Link this program with appropriate *cib*.obj. */

/* This application program is written in TURBO C 2.0 for the IBM PC-AT compatible. The
National Instruments Cooperation (NIC) Model PC-2A board provides the interface between
the PC-AT and a Sorensen brand Electronic Load. The appropriate *cib*.obj file is required
in each program to properly link the NIC board to C LANGUAGE and include the <decl.h.>
HEADER FILE to C LANGUAGE. */

#include <stdio.h>
#include <dos.h>
#include <math.h>
#include "decl.h"      /* NI GPIB CARD HEADER FILE */

main()
{
    char ouster[20],rdbuf[15],spec[10];
    int i,ch,load;
    /* Assign unique identifier to the device "dev5" and store in variable load. check for error.
ibfind error = negative value returned. */
    if((load = ibfind("dev5")) < 0)      /* Device variable name is load */
    {
        /* GPIB address is 5 */
        printf("\r*** INTERFACE ERROR ! ***\a\n");
        printf("\r\nError routine to notify that ibfind failed.\n");
        printf("\r\nCheck software configuration.\n");
        exit(1);
    }
    /* Clear the device */
    if((ibclr(load)) & ERR);
    {
        printf("INTERFACE ERROR ! \a");
        exit(1);
    }
    clrscr();
    /* Clear load error register */
    for(i=1,ch=0;i<=4;i++,ch++)
    {
        outstr=chan[ch];
        ibwrt(load,outstr,6);
        ibwrt(load,"CLER",4);
    }
    ibwrt( load,"NAME?",5);          /* Get the SL-series module load specification */
    strset(rdbuf,'\0');             /* Clear rdbuf string buffer */
```

```
strset(spec,'\0');                /* Clear spec string buffer */
ibrd(load,spec,20);
if (spec[3] == '9')
    printf("\n SLM series specification error !");
/* Set the channel 1, preset off, current sink 1.0 amps and load on commands to the load. */
ibwrt( load,"chan 1;pres off;curr:low 0.0;curr high 1.0;load on ",51);
ibwrt( load,"meas:curr ?",11);
/* Get the load actually sink current from the load */
ibrd( load,rdbuf,20);
/* go to local. */
ibloc(load);
}
```

Example Program in BASICA

LOAD DECL.BAS using BASICA MERGE command.

```
100 REM You must merge this code with DECL.BAS
105 REM
110 REM Assign a unique identifier to the device "dev5" and store it in variable load%.
125 REM
130     udname$ = "dev5"
140     CALL ibfind (udname$,load%)
145 REM
150 REM Check for error on ibfind call
155 REM
160     IF load% < 0 THEN GOTO 2000
165 REM
170 REM Clear the device
175 REM
180     CALL ibclr (load%)
185 REM
190 REM Get the module load specification
195 REM
200     wrt$ = "NAME?" : CALL ibwrt(load%,wrt$)
210     rd$ = space$(20) : CALL ibrd(load%,rd$)
215 REM
220 REM Set the channel 1, preset off, current sink 1.0 amps and load on commands to the
load.
225 REM
230     wrt$ = "chan 1;pres off;curr:low 0.0;curr high 1.0;load on"
240     CALL ibwrt(load%,wrt$)
245 REM
250 REM Get the load actually sink current from the load
255 REM
260     wrt$ = "meas:curr?" : CALL ibwrt(load%,wrt$)
270     rd$ = space$(20) : CALL ibrd(load%,rd$)
275 REM
280 REM Go to local
285 REM
290 CALL ibloc(load%)

2000 REM Error routine to notify that ibfind failed.
2010 REM Check software configuration.
2020 PRINT "ibfind error !" : STOP
```

This page intentionally left blank.

APPENDIX B

RS-232 PROGRAMMING EXAMPLE

C Language Interface for DOS Handlers " pd_rs232.c "

```
#include <dos.h>
#include <stdio.h>
#include <conio.h>
#include <string.h>

#define COMPTR      44          /* command array pointer      */
#define QUELEN      1024       /* size of serial input       */
#define SUCCESS     0          /* return value variable for success */
#define OPER_ERR    -1         /* operate error              */
#define TIME_OUT    1          /* time_out                   */
int input_index = 0;          /* index of serial input buffer */
int rd_result = 0;           /* return value variable of pd_rd() */
int timeout = 0;            /* timeout flag                */
char queue[QUELEN];         /* serial input buffer         */
int ACE_DATA_REG;          /* ACIA data register          */
int ACE_INT_ENB_REG;       /* ACIA interrupt enable register */
int ACE_INT_IDENT_REG;     /* ACIA interrupt identification register*/
int ACE_LINE_CTL_REG;      /* ACIA line control register */
int ACE_MODEM_CTL_REG;     /* ACIA modem control register*/
int ACE_LINE_STAT_REG;     /* ACIA line status register   */
int ACE_MODEM_STAT_REG;    /* ACIA modem status register  */
int COM_INT_NUM;           /* ACIA communication port interrupt number*/
int IRQ_MASK;              /* IRQ mask for PC IRQ flag    */
void pd_loc(void);          /* function of disable interrupt routine */
void pd_rem(void);          /* function of enable interrupt routine */
int pd_init(int);          /* function of initial communication port*/
int pd_wrt(char *,int);     /* function of write to device */
int pd_rd(char *,int);     /* function of read from device */
int read_buf(void);
int pd_meas(char *,char*, int, int);

#define PIC_CTL_REG    0x20     /* 8259A PIC control register */
#define PIC_INT_MASK_REG 0x21   /* 8259A PIC interrupt mask register */
#define NON_SPEC_EOI   0x20     /* non-specific end of interrupt */
#define CTS            0x10     /* clear to send */
#define DSR            0x20     /* data set ready */
#define RI             0x40     /* ring indicator */
#define DCD            0x80     /* data carrier detect */
#define DCTS          1         /* delta clear to send */
#define DDSR          2         /* delta data set ready */
#define TERI          4         /* trailing edge ring detect */
#define DDCD          8         /* delta data carrier detect */
```

```

#define OE          2          /* overrun error          */
#define PE          4          /* parity error           */
#define FE          8          /* frame error            */
#define BI          0x10       /* break interrupt        */
#define THRE       0x20       /* transmit holding reg. empty */

/* SLM series elec. load command sets */
int pd_wrt(char *wrtbuf,int count)
{
    static char *combuf[COMPTR] = {"CHAN", "CURR:HIGH", "CURR:LOW",
        "RES:HIGH", "RES:LOW", "VOLT:HIGH",
        "VOLT:LOW", "PERD:HIGH", "PERD:LOW",
        "FALL", "RISE", "GLOB:LOAD",
        "GLOB:LEV", "GLOB:PRES", "GLOB:SHOR",
        "GLOB:DYN", "GLOB:RANG", "GLOB:MODE",
        "CLER", "CHAN?", "MEAS:VOLT?",
        "MEAS:CURR?","CURR:HIGH?", "CURR:LOW?",
        "ERR?", "RES:HIGH?", "RES:LOW?",
        "VOLT:HIGH?","VOLT:LOW?", "NAME?",
        "PERD:HIGH?","PERD:LOW?", "FALL?",
        "RISE?", "LOAD?", "LEV?",
        "PRES?", "SHOR?", "DYN?",
        "RANG?", "MODE?", "PROT?",
        "REMOTE", "LOCAL" };

    int cnt,result,t;
    int comerr,err;
    char ch;
    char tempbuf[QUELEN];
    char intbuf[QUELEN];
/*   for (cnt = 0;cnt < 1024;cnt++)
    {
        intbuf[cnt] = "";
        tempbuf[cnt]="";
    } */
    strset(intbuf,"");
    strset(tempbuf,"");
    for (cnt = 0;cnt < count+1;cnt++,wrtbuf++)
    {
        intbuf[cnt] = *wrtbuf;
    }
    cnt = cnt--;
    intbuf[cnt] = '\r';
    cnt = cnt++;
    count = count++;
    intbuf[cnt] = '\n';
    t = strchr(intbuf," ");
    if (t > count)
    t = count-1;
    for (cnt = 0;cnt < t;cnt++)
    {

```

```

    tempbuf[cnt] = intbuf[cnt];
}
strupr(tempbuf);
strupr(intbuf);
cnt = 0;
do
{
    comerr = strncmp(tempbuf,combuf[cnt],t);
    cnt = cnt++;
}while(( cnt != COMPTR) && (comerr != 0));
if ( comerr == 0)
{
    result = SUCCESS;
    for (cnt = 0;cnt < count+1;cnt++)
    { while(inportb(ACE_LINE_STAT_REG) & THRE == 0);
      ch = intbuf[cnt];
      delay(20);
      outportb(ACE_DATA_REG, ch);
    }
    timeout = 0;
    for (cnt = 0; cnt <= count;cnt++)
    {
        ch = intbuf[cnt];
        if(ch == '?')
        {
            do
            {
                read_buf();
            }while((rd_result == 0)&&(timeout == 0));
            rd_result = 0;
        }
    }
    for (cnt = 0;cnt<= count;cnt++)
    {
        intbuf[cnt] = "";
        tempbuf[cnt] = "";
    }
    return(result);
}
return(OPER_ERR);
}
int pd_rd(char *buf,int count)
{
    char ch;
    int cnt = 0;
    do
    {
        ch = queue[cnt];
        *buf = ch;
        cnt = cnt++;
    }

```

```

    buf = buf++;
}while((ch != '\n') && (cnt != count));
*buf = '\0';
queue[0] = '\0';
if (timeout == 1)
{
    return(TIME_OUT);
}
return(SUCCESS);
}
int read_buf()
{
    char ch,ch1;
    int temp_index;
    unsigned long ticks;
    float sec1,sec2;
    rd_result = 0;
    ticks = biostime(0,0);
    sec1 = ticks/18.2;
    do
    {
        ticks = biostime(0,0);
        sec2 = ticks/18.2;
        if((sec2 - sec1) >= 20.0)                /* delay about 1 Sec */
        {
            timeout = 1;
        }
        ch = inportb(ACE_INT_IDENT_REG);
        ch &= 0x06;
        switch(ch)
        {
            case 6:
                inportb(ACE_DATA_REG);           /* read the data register to empty it */
                break;
            case 0:
                break;
            case 2:
                break;
            case 4:                               /* read character from data register */
                ch1 = inportb(ACE_DATA_REG);
                temp_index = input_index + 1;    /* increment index of input buffer*/
                if (ch1 != '\n')                /* check terminate bit */
                {
                    queue[input_index] = ch1;   /* store character to input buffer*/
                    input_index = temp_index;
                }
            else
            {
                queue[input_index] = ch1;
                input_index = temp_index;
            }
        }
    }
}

```

```

        input_index = 0;          /* if terminate bit was detected */
        temp_index = 0;
        rd_result = 1;           /* clear index and set return value */
    }
    break;
}
/* finally send the non-specific */
}while ((rd_result == 0) && (timeout == 0));
}

int pd_init(int pd_com)
{
    if ((pd_com != 1) && (pd_com != 2))
        return(OPER_ERR);
    if (pd_com == 2)             /* initial communication port 2 */
    {
        ACE_DATA_REG    = 0x2f8;
        ACE_INT_ENB_REG = 0x2f9;
        ACE_INT_IDENT_REG = 0x2fa;
        ACE_LINE_CTL_REG = 0x2fb;
        ACE_MODEM_CTL_REG = 0x2fc;
        ACE_LINE_STAT_REG = 0x2fd;
        ACE_MODEM_STAT_REG = 0x2fe;
        COM_INT_NUM     = 11;
        IRQ_MASK        = 0xf7;    /* IRQ mask for IRQ3 (11110111) */
    }
    else                          /* initial communication port 1 */
    {
        ACE_DATA_REG    = 0x3f8;
        ACE_INT_ENB_REG = 0x3f9;
        ACE_INT_IDENT_REG = 0x3fa;
        ACE_LINE_CTL_REG = 0x3fb;
        ACE_MODEM_CTL_REG = 0x3fc;
        ACE_LINE_STAT_REG = 0x3fd;
        ACE_MODEM_STAT_REG = 0x3fe;
        COM_INT_NUM     = 12;
        IRQ_MASK        = 0xef;    /* IRQ mask for IRQ4 (11101111) */
    }
    bioscom(0, 0xe3, pd_com-1);    /* boud rate : 9600, 1 start bit */
    pd_rem();                       /* no parity, 1 stop bit. */
    pd_wrt("remote",6);           /* data bit : 8 bits */
    return(SUCCESS);
}

int pd_meas(char *wrtmbuf, char *rdmbuf,int wrtmcnt,int rdmcnt)
{
    static char *wrtbuff[10] = { "CURR 1", "CURR 2", "CURR 3", "CURR 4",
        "VOLT 1", "VOLT 2", "VOLT 3", "VOLT 4", };
    char tmpbuf[20]={"chan "};
    int cnt,result,t,cmp,measerr;
    char ch;

```

```
char rdtmpbuf[20],chanbuf[20];
char measbuf[6];
for (cnt = 0; cnt < wrtmcnt; cnt++, wrtmbuf++)
{
    measbuf[cnt] = *wrtmbuf;
}
strupr(measbuf);
cnt = 0;
do
{
    measerr = strncmp(measbuf,wrtbuf[cnt],6);
    cnt = cnt++;
}while((cnt != 10) && (measerr != 0));
if(measerr == 0)
{
    result = SUCCESS;
    if (strncmp(measbuf,"CURR", 4) == 0)
    {
        ch = measbuf[5];
        switch(ch)
        {
            case '1':
                pd_wrt("chan 1",6);
                pd_wrt("meas:curr?",10);
                pd_rd(rdmbuf,rdmcnt);
                strncat(tmpbuf,chanbuf,1);
                pd_wrt(tmpbuf,6);
                break;
            case '2':
                pd_wrt("chan 2",6);
                pd_wrt("meas:curr?",10);
                pd_rd(rdmbuf,rdmcnt);
                strncat(tmpbuf,chanbuf,1);
                pd_wrt(tmpbuf,6);
                break;
            case '3':
                pd_wrt("chan 3",6);
                pd_wrt("meas:curr?",10);
                pd_rd(rdmbuf,rdmcnt);
                strncat(tmpbuf,chanbuf,1);
                pd_wrt(tmpbuf,6);
                break;
            case '4':
                pd_wrt("chan 4",6);
                pd_wrt("meas:curr?",10);
                pd_rd(rdmbuf,rdmcnt);
                strncat(tmpbuf,chanbuf,1);
                pd_wrt(tmpbuf,6);
                break;
        }
    }
}
```



```

    }
    else if(strncmp(measbuf,"VOLT",4) == 0)
    {
        ch = measbuf[5];
        switch(ch)
        {
            case '1':
                pd_wrt("chan 1",6);
                pd_wrt("meas:volt?",10);
                pd_rd(rdmbuf,rdmcnt);
                strncat(tmpbuf,chanbuf,1);
                pd_wrt(tmpbuf,6);
                break;
            case '2':
                pd_wrt("chan 2",6);
                pd_wrt("meas:volt?",10);
                pd_rd(rdmbuf,rdmcnt);
                strncat(tmpbuf,chanbuf,1);
                pd_wrt(tmpbuf,6);
                break;
            case '3':
                pd_wrt("chan 3",6);
                pd_wrt("meas:volt?",10);
                pd_rd(rdmbuf,rdmcnt);
                strncat(tmpbuf,chanbuf,1);
                pd_wrt(tmpbuf,6);
                break;
            case '4':
                pd_wrt("chan 4",6);
                pd_wrt("meas:volt?",10);
                pd_rd(rdmbuf,rdmcnt);
                strncat(tmpbuf,chanbuf,1);
                pd_wrt(tmpbuf,6);
                break;
        }
    }
}
else
{
    return(OPER_ERR);
}
return (result);
}

void pd_rem(void)
{
    char ch;
    outportb(ACE_INT_ENB_REG, 0xd); /* enable ACIA interrupt register */
    inportb(ACE_DATA_REG); /* empty receive data register */
    inportb(ACE_LINE_STAT_REG); /* clear line status register */
}

```

```

    outportb(ACE_MODEM_CTL_REG, 0xb);    /* set RTS,DTR to enable modem and
*/
                                        /* turn on OUT2 to enable the
8250's */
                                        /* IRQ interrupt to system
*/
}
void pd_loc(void)
{
    char ch;
    outportb(ACE_INT_ENB_REG, 0);        /* disable all 8250 interrupt    */
    outportb(ACE_MODEM_CTL_REG, 0);      /* clear RTS,DTR to disable modem and
*/
                                        /* turn off OUT2 to disable the
8250's*/
                                        /* IRQ interrupt to system
*/
}/* Program terminated. */

```

C Example Program

```
/* Link this program with pd_rs232.obj */
```

```

#include <dos.h>
#include <stdio.h>
#include <conio.h>
#include <string.h>

main()
{
    int com;
    int io_err= 0;
    char rdbuf[1024];
    clrscr();
    printf("Input COM1/COM2 port is : ");
    scanf("%d", &com);
    if((io_err = pd_init(com)) == 0)      /* Initial RS-232 interface */
    {
        setstr(rdbuf,"");
        pd_wrt("chan 1",6);
        delay(200);
        pd_wrt("name?",5);
        if ((io_err = pd_rd(a,10)) == 0)
        {
            do
            {
                /* Set the channel 1, preset off, current sink 1.0 amps and load on commands to the load. */
                pd_wrt("chan 1",6);
                delay(200);
                pd_wrt("pres off",8);
            }
        }
    }
}

```

```
        delay(200);
        pd_wrt("curr:low 0.0",12);
        delay(200);
        pd_wrt("curr high 1.0",13);
        delay(200);
        pd_wrt("load on",7);
        delay(200);
        pd_wrt("meas:curr ?",11);
/* Get the load actually sink current from the load */
        delay(200);
        pd_rd(rdbuf,20);
        io_err = 1;
        }while (io_err == 0);
    }
    else
    {
        printf("\a");
        printf("chan 1 I/O reading error !\n");
        exit(1);
    }
    pd_loc(); /* Go to local */
}
}
```

This page intentionally left blank.

APPENDIX C

SLM-SERIES AC LOAD GPIB/RS-232

OPERATING FLOW CHART

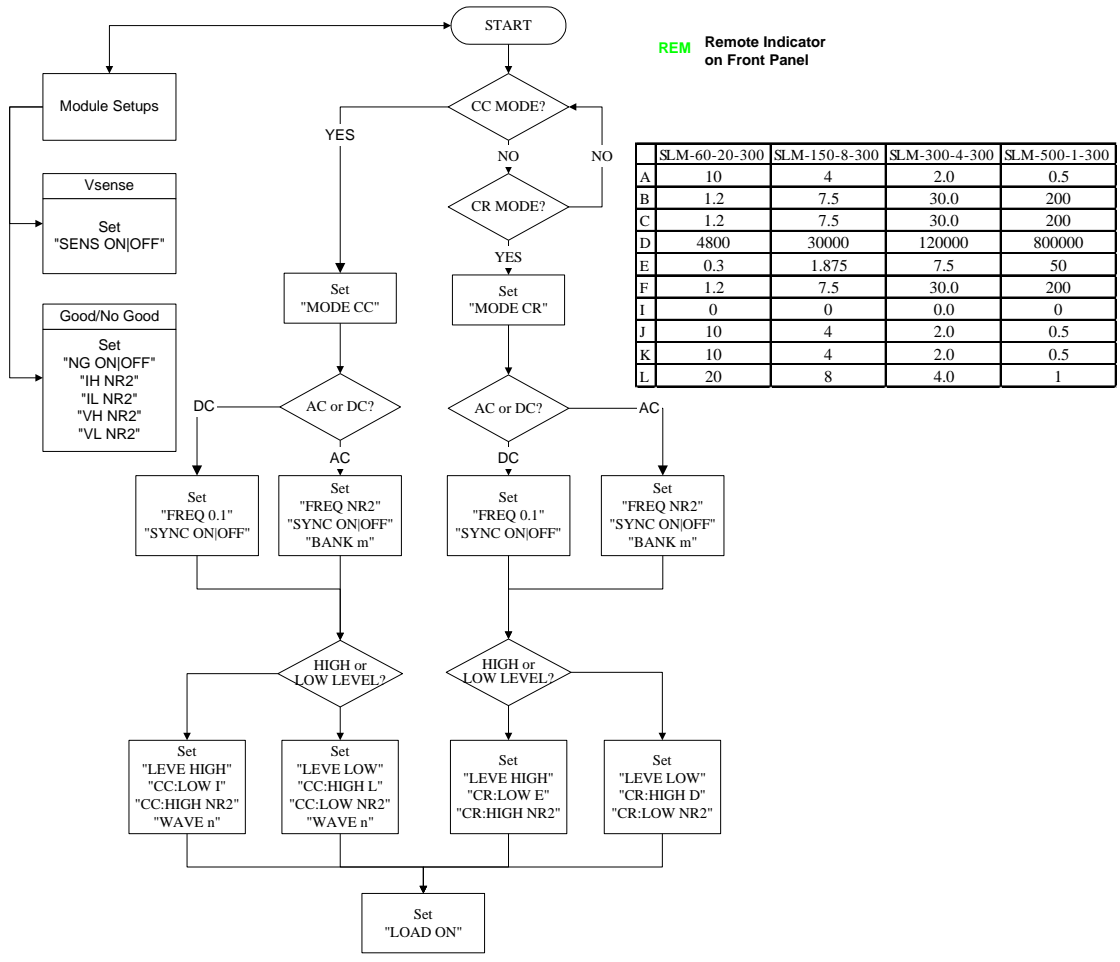

This page intentionally left blank.

APPENDIX D

SLM-SERIES DC LOAD GPIB/RS-232

OPERATING FLOW CHART

The following flow chart shows the typical SLM Series chassis remote control and load current level and status setting procedures of each load module.

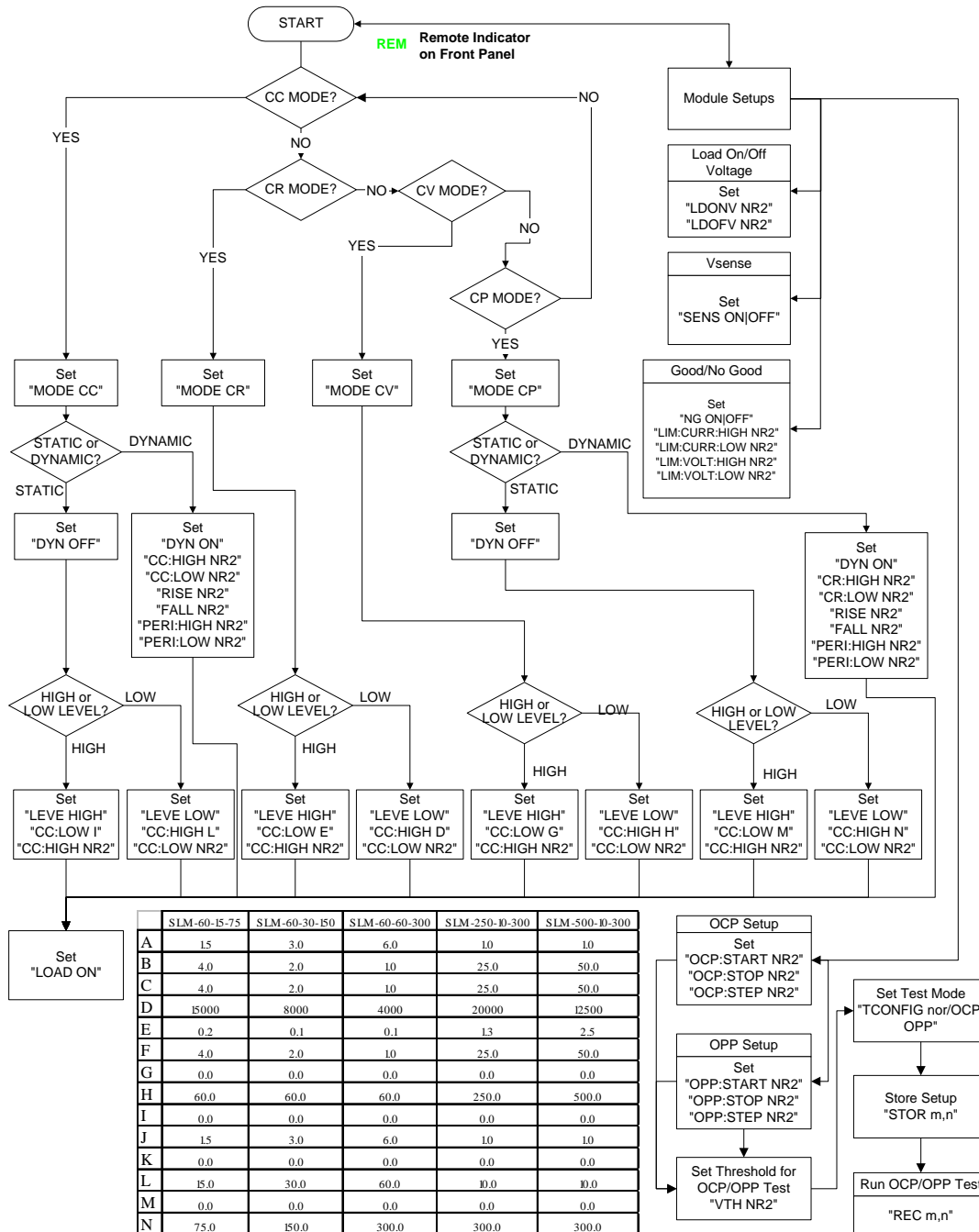

This page intentionally left blank.

APPENDIX E

SLD-SERIES GPIB/RS-232

OPERATING FLOW CHART

The following flow chart shows the typical SLM-Series chassis remote control and load current level and status setting procedures of each SLD-series load module.

