

SP-1U/2U Series High Performance Programmable DC Power Supply



- High Efficiency
- High Precision
- High Stability

SP-1U/2U Series High Performance Programmable DC Power Supply



Output			Model	Size	Ripple		Response		Certificates
Rated Voltage	Rated Current	Rated Power			Voltage	Current	Voltage increase	Voltage Drop	
20V	60A	600W	SP20VDC600W	1U ①	40mVp-p/6mVrms	20mA (TYP Value)	≤10ms(No load), ≤10ms(Full load)	≤150ms(No load), ≤20ms(Full load)	CE/RoHs
		1000W	SP20VDC1000W					≤150ms(No load), ≤15ms(Full load)	CE/RoHs
		1200W	SP20VDC1200W					≤150ms(No load), ≤12ms(Full load)	CE/RoHs
32V	50A	600W	SP32VDC600W	1U ①	40mVp-p/6mVrms	20mA (TYP Value)	≤12ms(No load), ≤12ms(Full load)	≤150ms(No load), ≤20ms(Full load)	CE/RoHs
		1000W	SP32VDC1000W					≤150ms(No load), ≤15ms(Full load)	CE/RoHs/CSA/FCC
		1200W	SP32VDC1200W					≤150ms(No load), ≤12ms(Full load)	CE/RoHs/CSA/FCC
		1600W	SP32VDC1600W					≤150ms(No load), ≤10ms(Full load)	CE/RoHs/CSA/FCC
	200A	1000W	SPS32VDC1000W	2U ⑤	60mVp-p/10mVrms	200mA (TYP Value)	≤20ms(No load), ≤40ms(Full load)	≤500ms(No load), ≤45ms(Full load)	CE
		2000W	SP32VDC2000W					≤20ms(No load), ≤30ms(Full load)	CE
		3000W	SP32VDC3000W					≤20ms(No load), ≤25ms(Full load)	CE/RoHs
40V	40A	600W	SP40VDC600W	1U ①	40mVp-p/6mVrms	20mA (TYP Value)	≤10ms(No load), ≤10ms(Full load)	≤150ms(No load), ≤20ms(Full load)	CE/RoHs
		1000W	SP40VDC1000W					≤150ms(No load), ≤15ms(Full load)	CE/RoHs/CSA/FCC
		1200W	SP40VDC1200W					≤150ms(No load), ≤12ms(Full load)	CE/RoHs/CSA/FCC
	120A	1600W	SP40VDC1600W	2U ⑤	40mVp-p/6mVrms	20mA (TYP Value)	≤10ms(No load), ≤10ms(Full load)	≤150ms(No load), ≤10ms(Full load)	CE/RoHs/CSA/FCC
		1000W	SPS40VDC1000W					≤350ms(No load), ≤10ms(Full load)	CE/RoHs
		2000W	SP40VDC2000W					CE/RoHs	
		3000W	SP40VDC3000W					CE/RoHs	
75V	25A	600W	SP75VDC600W	1U ②	40mVp-p/6mVrms	10mA (TYP Value)	≤10ms(No load), ≤10ms(Full load)	≤160ms(No load), ≤20ms(Full load)	CE/RoHs/CSA
		1000W	SP75VDC1000W					≤160ms(No load), ≤15ms(Full load)	CE/RoHs/CSA/FCC
		1200W	SP75VDC1200W					≤160ms(No load), ≤12ms(Full load)	CE/RoHs/CSA/FCC
		1500W	SP75VDC1500W					≤160ms(No load), ≤10ms(Full load)	CE/RoHs/CSA/FCC
	60A	4000W	SP75VDC4000W	2U ④	40mVp-p/8mVrms	10mA (TYP Value)	≤15ms(No load), ≤15ms(Full load)	≤450ms(No load), ≤20ms(Full load)	CE/RoHs/CSA/FCC
80V	60A	1000W	SP80VDC1000W	2U ④	40mVp-p/6mVrms	10mA (TYP Value)	≤15ms(No load), ≤15ms(Full load)	≤450ms(No load), ≤30ms(Full load)	CE
		2000W	SP80VDC2000W					CE/RoHs	
		3000W	SP80VDC3000W					CE/RoHs	
120V	40A	1000W	SPS120VDC1000W	2U ④	80mVp-p/15mVrms	10mA (TYP Value)	≤20ms(No load), ≤20ms(Full load)	≤350ms(No load), ≤21ms(Full load)	CE/RoHs
		2000W	SP120VDC2000W					CE/RoHs/CSA/FCC	
		3000W	SP120VDC3000W					CE/RoHs/CSA/FCC	
		4000W	SP120VDC4000W					CE/RoHs	
150V	10A	600W	SP150VDC600W	1U ③	120mVp-p/40mVrms	10mA (TYP Value)	≤25ms(No load), ≤25ms(Full load)	≤400ms(No load), ≤32ms(Full load)	CE/RoHs
		1000W	SP150VDC1000W					CE/RoHs	
		1200W	SP150VDC1200W					CE/RoHs	
		1500W	SP150VDC1500W					CE/RoHs	
	30A	1000W	SPS150VDC1000W	2U ④	80mVp-p/15mVrms	10mA (TYP Value)	≤25ms(No load), ≤25ms(Full load)	≤500ms(No load), ≤25ms(Full load)	CE/RoHs
		2000W	SP150VDC2000W					CE/RoHs/CSA/FCC	
		3000W	SP150VDC3000W					CE/RoHs/CSA/FCC	
200V	8A	600W	SP200VDC600W	1U ③	120mVp-p/40mVrms	10mA (TYP Value)	≤30ms(No load), ≤30ms(Full load)	≤600ms(No load), ≤50ms(Full load)	CE/RoHs
		1000W	SP200VDC1000W					≤600ms(No load), ≤40ms(Full load)	CE/RoHs
		1200W	SP200VDC1200W					≤600ms(No load), ≤36ms(Full load)	CE/RoHs
		1500W	SP200VDC1500W					≤600ms(No load), ≤30ms(Full load)	CE/RoHs
	24A	1000W	SPS200VDC1000W	2U ④	150mVp-p/30mVrms	20mA (TYP Value)	≤30ms(No load), ≤30ms(Full load)	≤500ms(No load), ≤20ms(Full load)	CE/RoHs
		2000W	SP200VDC2000W					CE/RoHs	
		3000W	SP200VDC3000W					CE/RoHs	
		4000W	SP200VDC4000W					CE/RoHs	
600V	10A	1000W	SPS600VDC1000W	2U ⑤	350mVp-p/40mVrms	10mA (TYP Value)	≤60ms(No load), ≤60ms(Full load)	≤800ms(No load), ≤110ms(Full load)	CE/RoHs
		2000W	SP600VDC2000W					≤800ms(No load), ≤90ms(Full load)	CE/RoHs
		3000W	SP600VDC3000W					≤800ms(No load), ≤75ms(Full load)	CE/RoHs
		4000W	SP600VDC4000W					≤800ms(No load), ≤60ms(Full load)	CE/RoHs
800V	7.5A	1000W	SPS800VDC1000W	2U ⑤	800mVp-p/200mVrms	10mA (TYP Value)	≤60ms(No load), ≤60ms(Full load)	≤800ms(No load), ≤60ms(Full load)	CE/RoHs
		2000W	SP800VDC2000W					CE/RoHs	
		3000W	SP800VDC3000W					CE/RoHs	
		4000W	SP800VDC4000W					CE/RoHs	

Dimensions & Weight



① 423.0x44.0x447.0 mm & 9.2kg



② 423.0x44.0x447.0 mm & 8.9kg



③ 423.0x44.0x447.0 mm & 9.3kg



④ 423.0x87.0x469.0 mm & 13.2kg



⑤ 423.0x87.0x514.0 mm & 14.7kg

Features

- Low ripple and noise
- High accuracy and high resolution
- CC and CV working mode switch freely
- Support LIST/SEQUENCE file editing
- OVP/OCP/OPP/OTP/SCP
- Remote compensation
- With external analog control input interface
- Standard USB/LAN/RS485/RS232 communication interface
- Master/Slave parallel and series operation mode for up to 10 units

Optional Information

GPIO communication card & cables

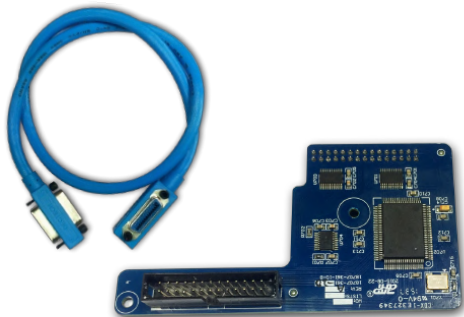

Three-core input cable (Input voltage range 176-265V, only supported on 1U height units)



SP-1U/2U Series High Performance Programmable DC Power Supply

Front Panel Introduction

1U Power Supply Front Panel



2U Power Supply Front Panel



Key	Introduction
0~9	Numeric Key
.	Decimal Point
ESC	Escape
▲	UP, used for choose menu or increase set value in menu operation
▼	DOWN, used for choose menu or decrease set value in menu operation
Enter	Enter
V-set	Set power supply's output voltage value
I-set	Set power supply's output current-limiting value
Display	Press it to back to the main interface quickly
On/Off	Control ON/OFF of power supply
Menu	Menu
Shift	Work with functional keys to realize multifunction
LOCAL	Panel operation
RECALL	Recall stored setting value of power supply from internal storage
STORE	Store current settings of power supply to storage location
DVM/POWER	Display DVM value and power value

SP Series Back Panel Introduction

1U Power Supply Back Panel

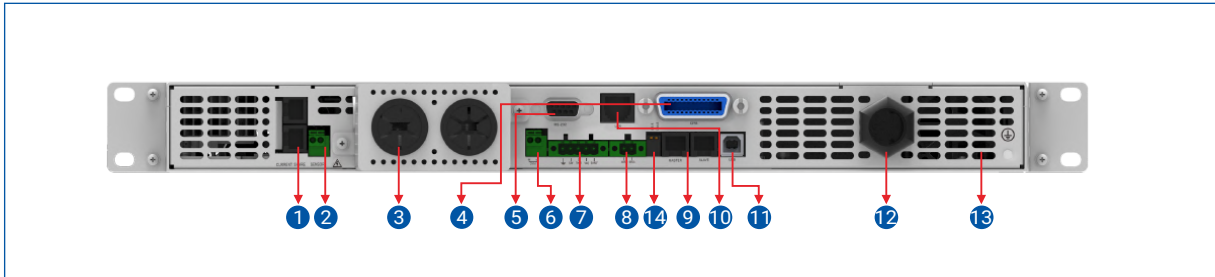

2U Power Supply Back Panel

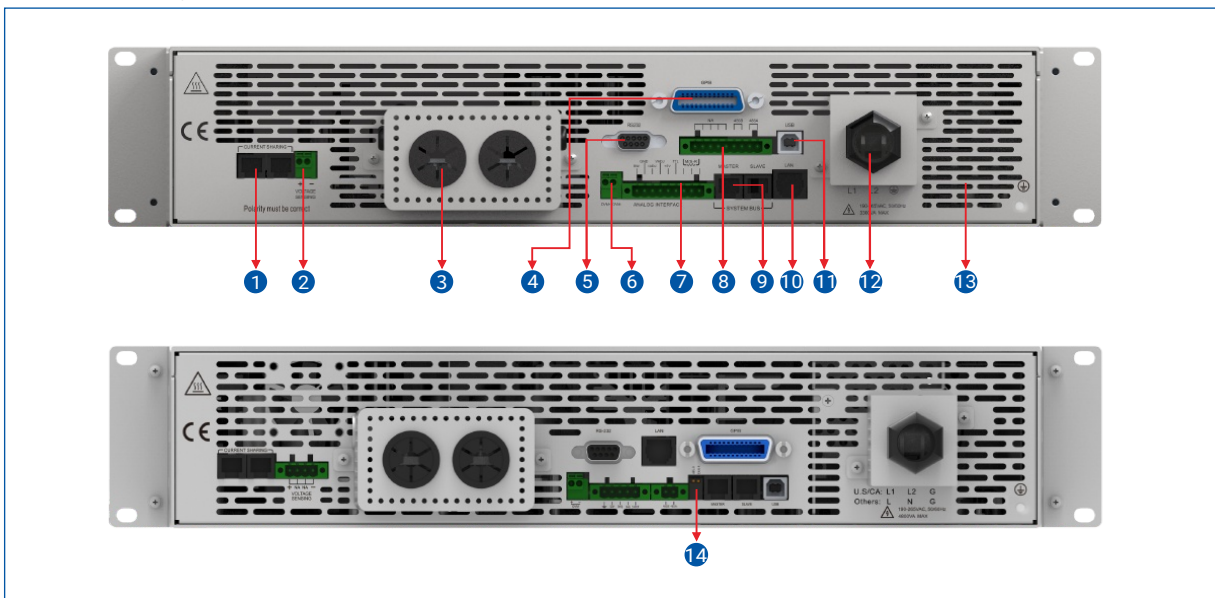

- ① AVG1/AVG2 Connector, used for connecting between units to enable current sharing.
- ② Voltage Remote Supporting Connector (VOLTAGE SENSING): Used to support wire voltage drops.
- ③ DC output terminal: Left (-), Right (+).
- ④ GPIB Communication connector.
- ⑤ RS-232 Communication connector.
- ⑥ DVM Connector.
- ⑦ ANALONG INTERFACE signal connection terminal.
- ⑧ RS-485 Communication connector.
- ⑨ SYSTEM BUS control, used for transmission of master and slaves.
- ⑩ LAN Communication Interface.
- ⑪ USB Communication Interface.
- ⑫ AC Power Connection terminal.
- ⑬ The fan duct outlet.
- ⑭ Termination resistor for RS485 and CAN Communication.

Note: There is a slight difference between these two kinds of rear panels of 2U units.

SP-1U/2U Series High Performance Programmable DC Power Supply

Short Mode

This function is applicable to cable/fuse current carrying capacity test, when activated, the power supply will shutdown the short circuit protection function and maintain ultra-low voltage to output rated current.

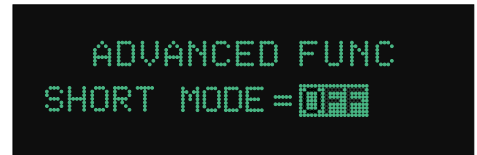
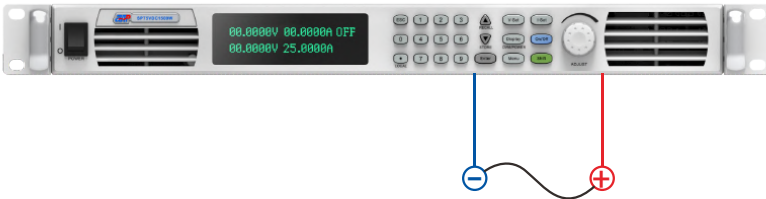

Timer Control Function

This function is applicable to unattended occasions, activate the timer and the output, the screen will show the countdown of the timer. Once it reaches down to zero, the supply will turn off the output automatically. And the full protection of the power supply will make sure the safe usage of this function.

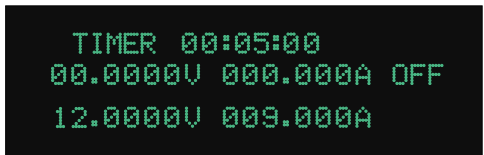
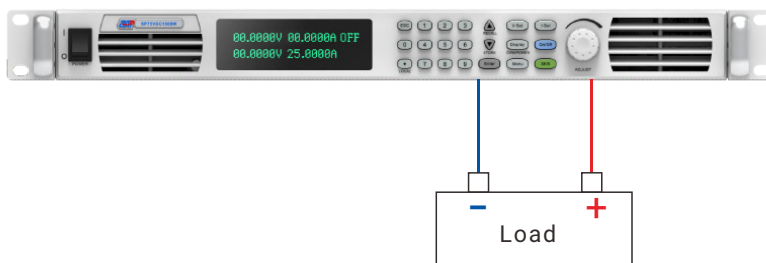

Remote Compensation Function

This function is applicable to compensate the voltage drop on the load line in order to improve the accuracy of test. In practical applications, even if the voltage drop is negligible, it is best to connect the remote compensation cable to the output terminal. When using the remote compensation functionality, please disconnect the S+, S- from the power supply's output terminal, and connect them to both ends of the DUT. Maximum compensation voltage is up to 5V. The output power need be lower than 1.05% of the rated power after compensation.

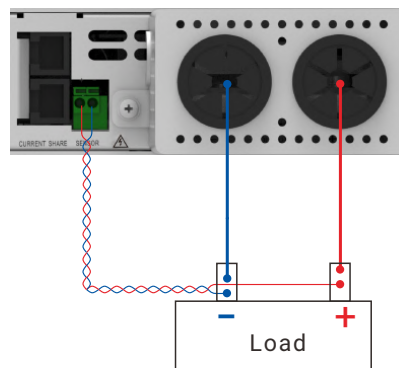

External Control Function

This series power supply can offer external voltage/ potentiometers control output, can be controlled by external voltage(0~5V) or external potentiometers(5~10K) in order to remotely adjust the power supply voltage and current regulation settings and the output status of the power supply.

External Voltage Control

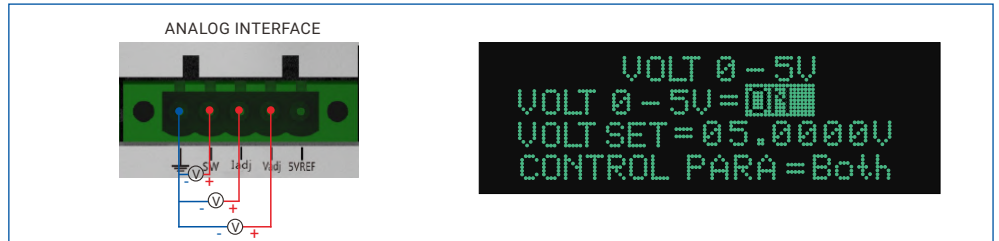

External Potentiometer Control



LIST Waveform Editing Function

This series power supply supports 3 kinds of LIST file editing format in order to meet the output elements of different test requirements. The minimum resolution of time setting is 1ms.

Impulse File Format

Sets the trend of the output voltage over time and its duration. Set the mode of the output waveform execution as required, LOOP , CONT, STEP.

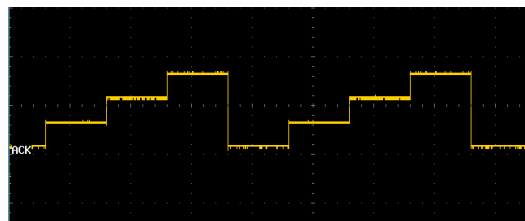
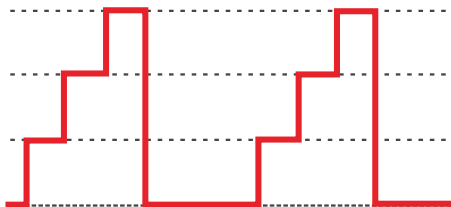

Slope File Format

Support to set the slope of output voltage, achieve to slowly increase and drop of the output voltage. Set the mode of the output waveform execution as required, LOOP, CONT, STEP.

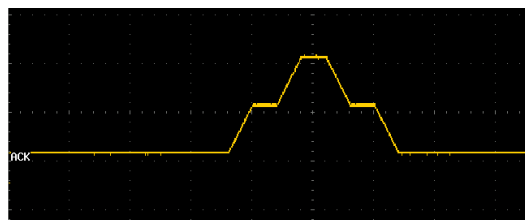
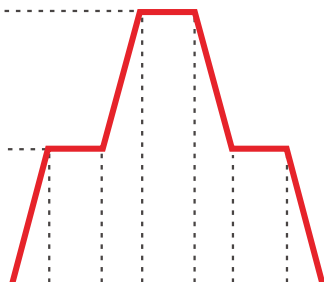

SEQUENCE Waveform Editing function

This function is an upgrade version of the LIST file editing. Its every step is a complete LIST file. It can combine several LIST file and output, meanwhile, it can set the number of repetitions per LIST file and number of executions of the entire SEQUENCE file.

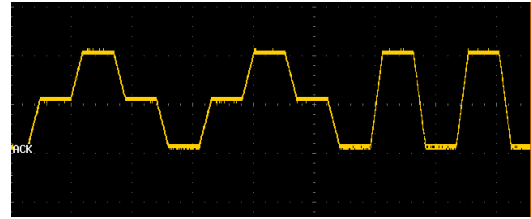

Measure Average Function

Under this mode, if the DUT has a sharp change in voltage and current, the averaging times can be adjusted to be FAST, MEDIUM or SLOW to make the displayed value more stable.



Current Counting Function

This function offers testing of the cutoff time of a breaker or a fuse. Starts timing when the current reaches the circuit breaker or fuse's fusing current I_b , stops timing when disconnected, the timing resolution is up to 200ms.

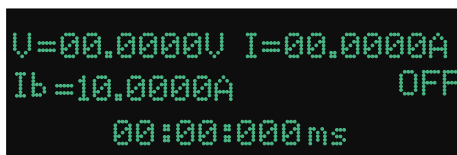

Quick Recall Function

Support to recall the stored parameters directly by the numeric keys on the front panel. Firstly, user stores the frequently used data in the power supply's memory, press the numeric key directly after entering the quick recall mode, can quick recall the datas which are stored in **[1]** ~ **[9]**.

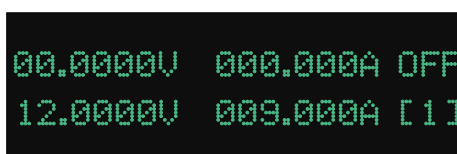

Master/Slave Mode

This series power supply support Master/Slave parallel and series operation mode for up to 10 units, extended power up to 40kW. The current sharing function in parallel mode realizes the equalization of the power supplies in the system, thereby ensuring the extended power without affecting the performance index of the power supply. CAN parallel mode realizes the same dynamic response of the system as single unit, realizing high-speed and non-delayed synchronous response of master and slave.

Parallel Connection

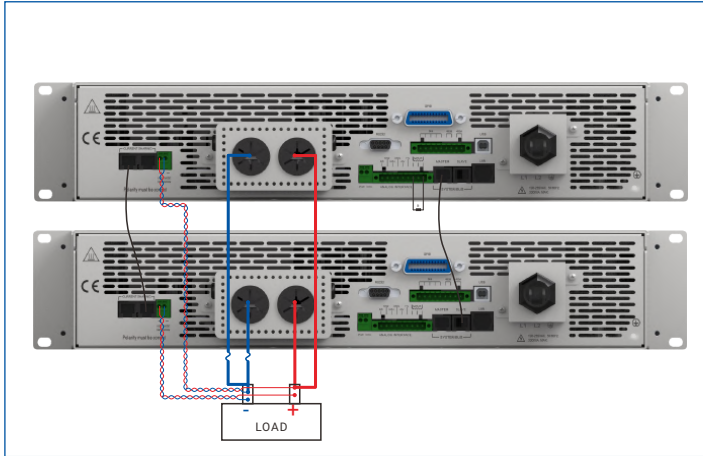

Series Connection

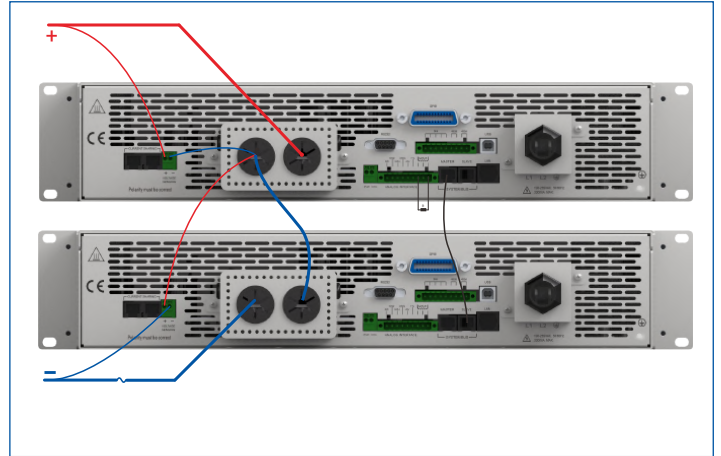

Positive / Negative Voltage Output Mode

This mode which enables both positive and negative outputs simultaneously in master slave operation.

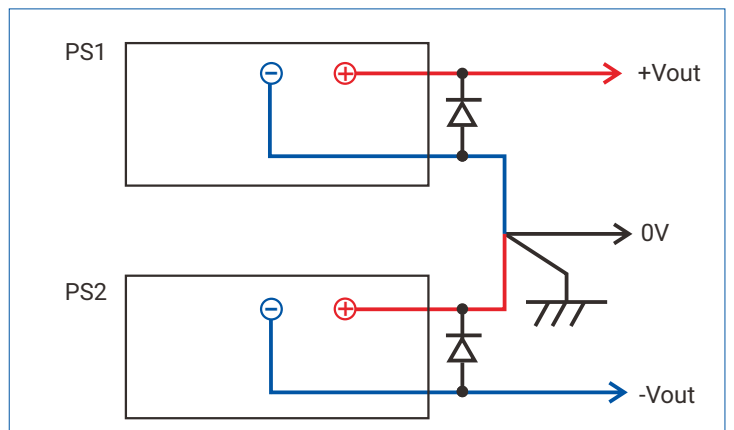
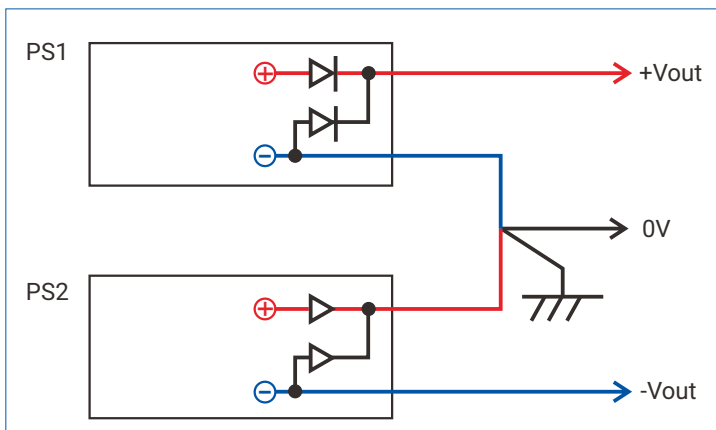
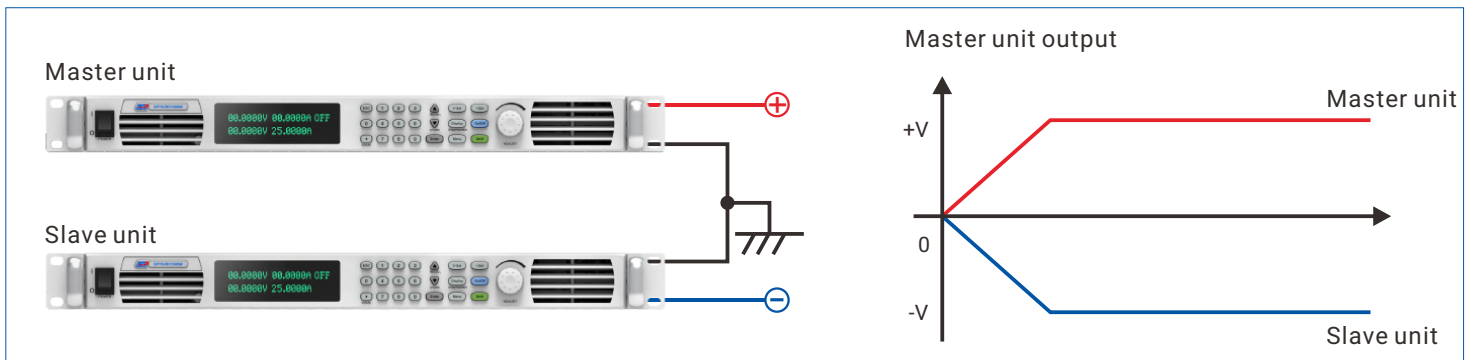

The power supply below 200A has been connected with anti reverse diode, so the external diode isn't needed in the actual connection, and the 200A power supply needs to connect the diode.

SP-1U/2U Series High Performance Programmable DC Power Supply

Built-in Standard Automobile Electric Test Waveform

It can be used to simulate the transient interference of power supply which may often be encountered in the process of automobile startup and operation. In accordance with industry standards, this series power supply has built-in voltage curves under the DIN40839 and ISO 16750-2 standards for 12V and 24V test grades. User can call the voltage curve directly for testing or edit as desired.

The built-in standard waveform cutline and file names are as below:

No.	Standard	Test item name	Waveform	List/Sequence File Name(Built-in)
1	ISO16750-2	Automobile Start Transient Voltage Drop		List 3-2 (12V Voltage Grade) List 3-7 (24V Voltage Grade)
2	ISO16750-2	Automobile Electronic Restoration Function Test		Sequence1 (includes List 3-3 and List 3-4, for 12V system) Sequence 2 (includes List 3-8 and List 3-9, for 24V system)
3	ISO16750-2	Automobile Electronic Engine Start Test		List 3-5
4	DIN40839	Automobile Electronic Engine Start Test		List 3-1

Anti reverse irrigation/Power Sink Function

This series power supply has protection against reverse irrigation, so as to cut off the current of DUT in a certain test condition to the direction of power supply, and prevent the damage to the power supply hardware circuit from DUT.



Meanwhile, this series power supply comes standard with short circuit copper sheet, When the test requires the power supply to absorb the spike generated by DUT to ensure the safety of the operation, the short-circuit copper piece can be connected, and the energy is absorbed by the output capacitor inside the power supply and other circuits.

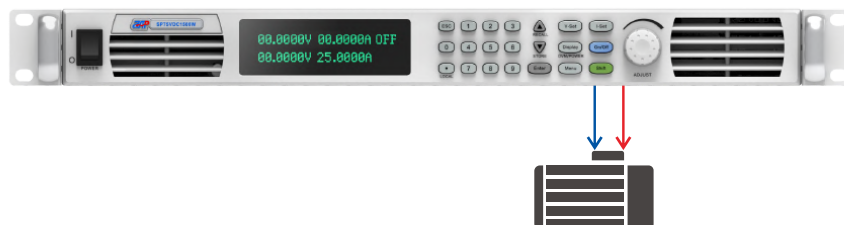

Note: Please consult your sales representative to get detailed information about anti reverse irrigation protection for power supply models above 200A.

Monitoring Software

All power supplies come standard with graphical monitoring software, which supports all communication interfaces and covers almost all functions of the power supply front panel operation. In the communication selection interface, users can select the communication interface and search for the connected power supply according to the actual connection.

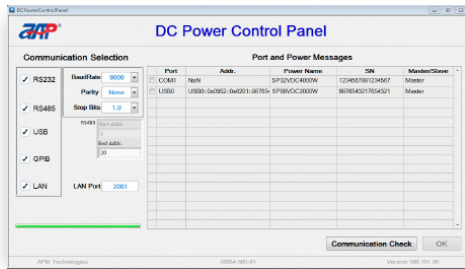

When the communication port has only one power supply connection, it enters the Single Mode interface. Includes the basic settings of voltage and current and measurement function, and List waveform editing/ saved test data function.

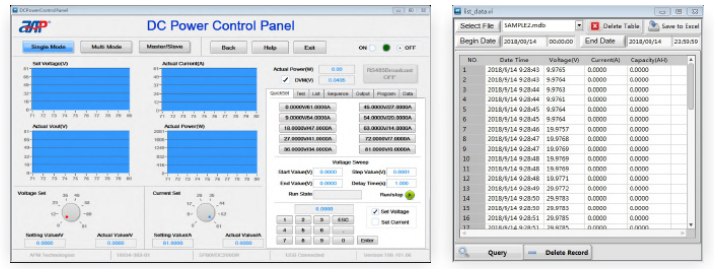

When the communication port has more than one power supply connection, it enters the Multi Mode interface. Supports switching control or display current power supply's settings.

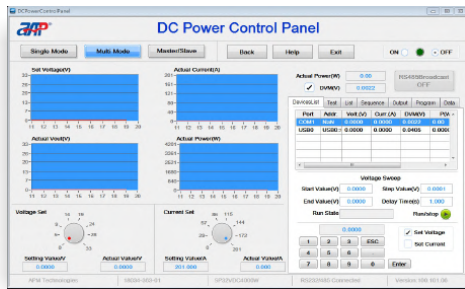

When the communication port connects the power supply that is the Master unit, it enters Master/Slave interface. The Master/Slave interface only maintains communication with the Master unit, and the parameters are synchronously written to the slaves.

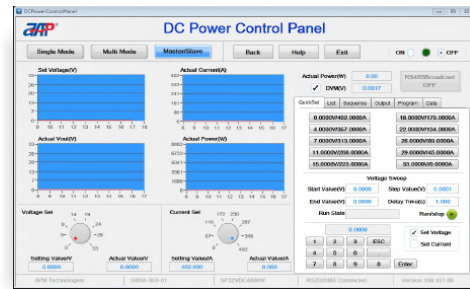

WebServer Function

Use can control the power supply on a computer using a web browser. No need to install the monitoring software, just open web browser and input IP address to control the unit, which can meet basic setting and monitoring requirements.



SP-1U/2U Series High Performance Programmable DC Power Supply

600W in 1U

Model	SP20VDC600W	SP32VDC600W	SP40VDC600W	SP75VDC600W	SP150VDC600W	SP200VDC600W
Input						
Input Voltage	90~265VAC					
Input Frequency	47~63Hz					
Power Factor	>0.98					
Input Power	750VA(MAX)					
Output						
Output Voltage Range	0~20V	0~32V	0~40V	0~75V	0~150V	0~200V
Output Current Range	0~60A	0~50A	0~40A	0~25A	0~10A	0~8A
Output Power Range	0~600W					
Voltage Load Regulation	10mV	10mV	10mV	10mV	15mV	15mV
Current Load Regulation	60mA	50mA	40mA	25mA	10mA	8mA
Voltage Display Resolution	0.1mV	0.1mV	0.1mV	0.1mV	1mV	1mV
Current Display Resolution	0.2mA	0.2mA	0.2mA	0.2mA	0.2mA	0.1mA
Voltage Programmable Resolution	1.5mV	1.5mV	1.5mV	1.5mV	3mV	3mV
Current Programmable Resolution	2mA	2mA	2mA	1mA	1mA	1mA
Voltage Setting Accuracy ^[1]	0.05%+15mV	0.05%+15mV	0.05%+15mV	0.05%+15mV	0.1%+15mV	0.1%+15mV
Current Setting Accuracy	0.1%+60mA	0.1%+50mA	0.1%+40mA	0.1%+25mA	0.1%+10mA	0.1%+8mA
Voltage Measurement Accuracy ^[2]	0.05%+15mV	0.05%+15mV	0.05%+15mV	0.05%+15mV	0.1%+15mV	0.1%+15mV
Current Measurement Accuracy	0.1%+60mA	0.1%+50mA	0.1%+40mA	0.1%+25mA	0.1%+10mA	0.1%+8mA
Voltage Ripple ^[2]	40mVp-p 6mVrms	40mVp-p 6mVrms	40mVp-p 6mVrms	40mVp-p 6mVrms	120mVp-p 40mVrms	120mVp-p 40mVrms
Current Ripple ^[3]	60mA (Full Range) 20mA (TYP Value)	50mA (Full Range) 20mA (TYP Value)	40mA (Full Range) 20mA (TYP Value)	25mA (Full Range) 10mA (TYP Value)	40mA (Full Range) 10mA (TYP Value)	40mA (Full Range) 10mA (TYP Value)
Line Regulation(Voltage)	0.005%+1mV	0.005%+1mV	0.005%+1mV	0.005%+1mV	0.02%+8mV	0.02%+8mV
Line Regulation(Current)	4mA	4mA	4mA	4mA	10mA	30mA
Voltage Temperature Coefficient ^[4]	100ppm/°C					
Current Temperature Coefficient ^[4]	150ppm/°C					
DVM Resolution	0.1mV	0.1mV	0.1mV	0.1mV	4mV	1mV
DVM Precision ^[1]	0.05%+15mV	0.05%+15mV	0.05%+15mV	0.05%+15mV	0.1%+30mV	0.1%+15mV
Operating Mode	Constant voltage (CV) / Constant current (CC)					
Remote Compensation	4V MAX					
Master-slave Control	Yes					
Response (Voltage Increase)	≤10ms	≤12ms	≤10ms	≤10ms	≤25ms	≤30ms
Response (Voltage Drop)	≤150ms (no load) ≤20ms (full load)	≤150ms (no load) ≤20ms (full load)	≤150ms (no load) ≤20ms (full load)	≤160ms (no load) ≤20ms (full load)	≤400ms (no load) ≤32ms (full load)	≤600ms (no load) ≤30ms (full load)
Load Transient Recovery Time ^[5]	≤2ms	≤2ms	≤2ms	≤2ms	≤3ms	≤3ms
Command Response Time	50ms					
Series Capability ^[6]	Up to 10 units	Up to 10 units	Up to 10 units	Up to 10 units	Up to 8 units	Up to 6 units
Parallel Capability	Up to 10 units					
Current Sharing ^[7]	9V	9V	12V	20V	40V	50V
Efficiency (full load)	85%	86%	87%	88%	88%	87%
Other						
Protection Function	OVP/OCP/OTP/OPP/SCP/FOLDBACK					
Anti Reverse Irrigation Protection	Yes					
Input Fuse	20A, 125VAC/250VAC, fast-acting type	30A, 125VAC/250VAC, fast-acting type	30A, 125VAC/250VAC, fast-acting type	30A, 125VAC/250VAC, fast-acting type	10A, 125VAC/250VAC, fast-acting type	10A, 125VAC/250VAC, fast-acting type
Unit Weight/Shipping Weight	9.2kg/12kg	9.2kg/12kg	9.2kg/12kg	8.9kg/11.7kg	9.3kg/12.7kg	9.3kg/12.7kg
Dimensions(WxHxD)	423.0x44.0x447.0 mm					
Communication Modes	1. RS232/RS485/USB/LAN; 2. RS232/RS485/USB/LAN/GPIB					
Operating Environment	Temperature 0~40°C, Relative Humidity 10%~90%(no condensation); Pollution degree 2, Installation category II, Indoor use.					
Cooling Mode	Forced air-cooling					
Altitude	2000m					
Insulation	AC input ↔ DC output, 4242VDC, AC input ↔ PE, 2121VDC					

[1] %output+offset, when output voltage less than 5V, offset voltage is 30mV.

[2] Vp-p@20MHz, Vrms@1.25MHz.

The 20V/32V/40V/75V models voltage ripple is 50mVp-p/6mVrms @ 1V. For the 600V and 800V models, the voltage ripple from 0~5V is out of the range show above.

[3] Arms@1.25MHz, the TYP Value is measured at the rated output voltage with 100% resistive load, and the measured value at full range of output voltage with 100% resistive load is less than the Full Range value.

[4] 0~40°C.

[5] Time for output voltage to recover within 0.5%(0.75% @800V models) of its rated output for a load change from 10% to 90% of its rated output current. Voltage set point from 10% to 90% of rated output.

[6] The communication must insulated users from output when using remote control and the output voltage exceeds 800VDC.

[7] Current Share error $I_{\text{error}} = (I_{\text{AV}} * 2.5\% + 5\% \text{ F.S.}) A$, F.S is the full scale of the current. $I_{\text{AV}} = I_{\text{sum}}/n$, where I_{AV} is average current, I_{sum} is total current and n is number of parallel units.

Note: Output voltage must be higher than 30% of maximum output voltage when Current Share function properly.

All specifications are subject to change without notice.

SP-1U/2U Series High Performance Programmable DC Power Supply

1000W in 1U

Model	SP20VDC1000W	SP32VDC1000W	SP40VDC1000W	SP75VDC1000W	SP150VDC1000W	SP200VDC1000W
Input						
Input Voltage	90~265VAC					
Input Frequency	47~63Hz					
Power Factor	>0.98					
Input Power	1300VA(MAX)					
Output						
Output Voltage Range	0~20V	0~32V	0~40V	0~75V	0~150V	0~200V
Output Current Range	0~60A	0~50A	0~40A	0~25A	0~10A	0~8A
Output Power Range	0~1000W					
Voltage Load Regulation	10mV	10mV	10mV	10mV	15mV	15mV
Current Load Regulation	60mA	50mA	40mA	25mA	10mA	8mA
Voltage Display Resolution	0.1mV	0.1mV	0.1mV	0.1mV	1mV	1mV
Current Display Resolution	0.2mA	0.2mA	0.2mA	0.2mA	0.2mA	0.1mA
Voltage Programmable Resolution	1.5mV	1.5mV	1.5mV	1.5mV	3mV	3mV
Current Programmable Resolution	2mA	2mA	2mA	1mA	1mA	1mA
Voltage Setting Accuracy ^[1]	0.05%+15mV	0.05%+15mV	0.05%+15mV	0.05%+15mV	0.1%+15mV	0.1%+15mV
Current Setting Accuracy	0.1%+60mA	0.1%+50mA	0.1%+40mA	0.1%+25mA	0.1%+10mA	0.1%+8mA
Voltage Measurement Accuracy ^[1]	0.05%+15mV	0.05%+15mV	0.05%+15mV	0.05%+15mV	0.1%+15mV	0.1%+15mV
Current Measurement Accuracy	0.1%+60mA	0.1%+50mA	0.1%+40mA	0.1%+25mA	0.1%+10mA	0.1%+8mA
Voltage Ripple ^[2]	40mVp-p 6mVrms	40mVp-p 6mVrms	40mVp-p 6mVrms	40mVp-p 6mVrms	120mVp-p 40mVrms	120mVp-p 40mVrms
Current Ripple ^[3]	60mA (Full Range) 20mA (TYP Value)	50mA (Full Range) 20mA (TYP Value)	40mA (Full Range) 20mA (TYP Value)	25mA (Full Range) 10mA (TYP Value)	40mA (Full Range) 10mA (TYP Value)	40mA (Full Range) 10mA (TYP Value)
Line Regulation(Voltage)	0.005%+1mV	0.005%+1mV	0.005%+1mV	0.005%+1mV	0.02%+8mV	0.02%+8mV
Line Regulation(Current)	4mA	4mA	4mA	4mA	10mA	30mA
Voltage Temperature Coefficient ^[4]	100ppm/°C					
Current Temperature Coefficient ^[4]	150ppm/°C					
DVM Resolution	0.1mV	0.1mV	0.1mV	0.1mV	4mV	1mV
DVM Precision ^[1]	0.05%+15mV	0.05%+15mV	0.05%+15mV	0.05%+15mV	0.1%+30mV	0.1%+15mV
Operating Mode	Constant voltage (CV) / Constant current (CC)					
Remote Compensation	4V MAX					
Master-slave Control	Yes					
Response (Voltage Increase)	≤10ms	≤12ms	≤10ms	≤10ms	≤25ms	≤30ms
Response (Voltage Drop)	≤150ms (no load) ≤20ms (full load)	≤150ms (no load) ≤15ms (full load)	≤150ms (no load) ≤15ms (full load)	≤160ms (no load) ≤15ms (full load)	≤400ms (no load) ≤25ms (full load)	≤600ms (no load) ≤40ms (full load)
Load Transient Recovery Time ^[5]	≤2ms	≤2ms	≤2ms	≤2ms	≤3ms	≤3ms
Command Response Time	50ms					
Series Capability ^[6]	Up to 10 units	Up to 10 units	Up to 10 units	Up to 10 units	Up to 8 units	Up to 6 units
Parallel Capability	Up to 10 units					
Current Sharing ^[7]	9V	9V	12V	20V	40V	50V
Efficiency (full load)	85%	89%	89%	89%	89%	87%
Other						
Protection Function	OVP/OCP/OTP/OPP/SCP/FOLDBACK					
Anti Reverse Irrigation Protection	Yes					
Input Fuse	20A, 125VAC/250VAC, fast-acting type	30A, 125VAC/250VAC, fast-acting type	30A, 125VAC/250VAC, fast-acting type	30A, 125VAC/250VAC, fast-acting type	30A, 125VAC/250VAC, fast-acting type	30A, 125VAC/250VAC, fast-acting type
Unit Weight/Shipping Weight	9.2kg/12kg	9.2kg/12kg	9.2kg/12kg	8.9kg/11.7kg	9.3kg/12.7kg	9.3kg/12.7kg
Dimensions(WxHxD)	423.0x44.0x447.0 mm					
Communication Modes	1. RS232/RS485/USB/LAN; 2. RS232/RS485/USB/LAN/GPIB					
Operating Environment	Temperature 0~40°C, Relative Humidity 10%~90%(no condensation); Pollution degree 2, Installation category II, Indoor use.					
Cooling Mode	Forced air-cooling					
Altitude	2000m					
Insulation	AC input <->DC output, 4242VDC, AC input <-> PE, 2121VDC					

[1] %output+offset, when output voltage less than 5V, offset voltage is 30mV.

[2] Vp-p@20MHz, Vrms@1.25MHz.

The 20V/32V/40V/75V models voltage ripple is 50mVp-p/6mVrms @ 1V. For the 600V and 800V models, the voltage ripple from 0~5V is out of the range show above.

[3] Arms@1.25MHz, the TYP Value is measured at the rated output voltage with 100% resistive load, and the measured value at full range of output voltage with 100% resistive load is less than the Full Range value.

[4] 0~40°C.

[5] Time for output voltage to recover within 0.5%(0.75% @800V models) of its rated output for a load change from 10% to 90% of its rated output current. Voltage set point from 10% to 90% of rated output.

[6] The communication must insulated users from output when using remote control and the output voltage exceeds 800VDC.

[7] Current Share error $le<(lav*2.5% + 5% F.S) A$, F.S is the full scale of the current. $lav=Isum/n$, where lav is average current, $Isum$ is total current and n is number of parallel units.

Note: Output voltage must be higher than 30% of maximum output voltage when Current Share function properly.

All specifications are subject to change without notice.

SP-1U/2U Series High Performance Programmable DC Power Supply

1200W in 1U

Model	SP20VDC1200W	SP32VDC1200W	SP40VDC1200W	SP75VDC1200W	SP150VDC1200W	SP200VDC1200W
Input						
Input Voltage	90~265VAC					
Input Frequency	47~63Hz					
Power Factor	>0.98					
Input Power	1500VA(MAX)					
Output						
Output Voltage Range	0~20V	0~32V	0~40V	0~75V	0~150V	0~200V
Output Current Range	0~60A	0~50A	0~40A	0~25A	0~10A	0~8A
Output Power Range	0~1200W					
Voltage Load Regulation	10mV	10mV	10mV	10mV	15mV	15mV
Current Load Regulation	60mA	50mA	40mA	25mA	10mA	8mA
Voltage Display Resolution	0.1mV	0.1mV	0.1mV	0.1mV	1mV	1mV
Current Display Resolution	0.2mA	0.2mA	0.2mA	0.2mA	0.2mA	0.1mA
Voltage Programmable Resolution	1.5mV	1.5mV	1.5mV	1.5mV	3mV	3mV
Current Programmable Resolution	2mA	2mA	2mA	1mA	1mA	1mA
Voltage Setting Accuracy ^[1]	0.05%+15mV	0.05%+15mV	0.05%+15mV	0.05%+15mV	0.1%+15mV	0.1%+15mV
Current Setting Accuracy	0.1%+60mA	0.1%+50mA	0.1%+40mA	0.1%+25mA	0.1%+10mA	0.1%+8mA
Voltage Measurement Accuracy ^[1]	0.05%+15mV	0.05%+15mV	0.05%+15mV	0.05%+15mV	0.1%+15mV	0.1%+15mV
Current Measurement Accuracy	0.1%+60mA	0.1%+50mA	0.1%+40mA	0.1%+25mA	0.1%+10mA	0.1%+8mA
Voltage Ripple ^[2]	40mVp-p 6mVrms	40mVp-p 6mVrms	40mVp-p 6mVrms	40mVp-p 6mVrms	120mVp-p 40mVrms	120mVp-p 40mVrms
Current Ripple ^[3]	60mA (Full Range) 20mA (TYP Value)	50mA (Full Range) 20mA (TYP Value)	40mA (Full Range) 20mA (TYP Value)	25mA (Full Range) 10mA (TYP Value)	40mA (Full Range) 10mA (TYP Value)	40mA (Full Range) 10mA (TYP Value)
Line Regulation(Voltage)	0.005%+1mV	0.005%+1mV	0.005%+1mV	0.005%+1mV	0.02%+8mV	0.02%+8mV
Line Regulation(Current)	4mA	4mA	4mA	4mA	10mA	30mA
Voltage Temperature Coefficient ^[4]	100ppm/°C					
Current Temperature Coefficient ^[4]	150ppm/°C					
DVM Resolution	0.1mV	0.1mV	0.1mV	0.1mV	4mV	1mV
DVM Precision ^[1]	0.05%+15mV	0.05%+15mV	0.05%+15mV	0.05%+15mV	0.1%+30mV	0.1%+15mV
Operating Mode	Constant voltage (CV) / Constant current (CC)					
Remote Compensation	4V MAX					
Master-slave Control	Yes					
Response (Voltage Increase)	≤10ms	≤10ms	≤10ms	≤10ms	≤25ms	≤30ms
Response (Voltage Drop)	≤150ms (no load) ≤12ms (full load)	≤150ms (no load) ≤12ms (full load)	≤150ms (no load) ≤12ms (full load)	≤160ms (no load) ≤12ms (full load)	≤400ms (no load) ≤21ms (full load)	≤600ms (no load) ≤36ms (full load)
Load Transient Recovery Time ^[5]	≤2ms	≤2ms	≤2ms	≤2ms	≤3ms	≤3ms
Command Response Time	50ms					
Series Capability ^[6]	Up to 10 units	Up to 10 units	Up to 10 units	Up to 10 units	Up to 8 units	Up to 6 units
Parallel Capability	Up to 10 units					
Current Sharing ^[7]	9V	9V	12V	20V	40V	50V
Efficiency (full load)	84%	84%	89%	90%	89%	90%
Other						
Protection Function	OVP/OC/OTP/OPP/SCP/FOLDBACK					
Anti Reverse Irrigation Protection	Yes					
Input Fuse	20A, 125VAC/250VAC, fast-acting type	20A, 125VAC/250VAC, fast-acting type	30A, 125VAC/250VAC, fast-acting type	30A, 125VAC/250VAC, fast-acting type	30A, 125VAC/250VAC, fast-acting type	30A, 125VAC/250VAC, fast-acting type
Unit Weight/Shipping Weight	9.2kg/12kg	9.2kg/12kg	9.2kg/12kg	8.9kg/11.7kg	9.3kg/12.7kg	9.3kg/12.7kg
Dimensions(WxHxD)	423.0x44.0x447.0 mm					
Communication Modes	1. RS232/RS485/USB/LAN; 2. RS232/RS485/USB/LAN/GPIB					
Operating Environment	Temperature 0~40°C, Relative Humidity 10%~90%(no condensation); Pollution degree 2, Installation category II, Indoor use.					
Cooling Mode	Forced air-cooling					
Altitude	2000m					
Insulation	AC input ↔ DC output, 4242VDC, AC input ↔ PE, 2121VDC					

[1] %output+offset, when output voltage less than 5V, offset voltage is 30mV.

[2] Vp-p@20MHz, Vrms@1.25MHz.

The 20V/32V/40V/75V models voltage ripple is 50mVp-p/6mVrms @ 1V. For the 600V and 800V models, the voltage ripple from 0~5V is out of the range show above.

[3] Arms@1.25MHz, the TYP Value is measured at the rated output voltage with 100% resistive load, and the measured value at full range of output voltage with 100% resistive load is less than the Full Range value.

[4] 0~40°C.

[5] Time for output voltage to recover within 0.5%(0.75% @800V models) of its rated output for a load change from 10% to 90% of its rated output current. Voltage set point from 10% to 90% of rated output.

[6] The communication must insulated users from output when using remote control and the output voltage exceeds 800VDC.

[7] Current Share error $I_{\text{error}} = (I_{\text{avg}} * 2.5\% + 5\% \text{ F.S}) / n$, F.S is the full scale of the current. $I_{\text{avg}} = I_{\text{sum}} / n$, where I_{avg} is average current, I_{sum} is total current and n is number of parallel units.

Note: Output voltage must be higher than 30% of maximum output voltage when Current Share function properly.

All specifications are subject to change without notice.

SP-1U/2U Series High Performance Programmable DC Power Supply

1500W in 1U

Model	SP75VDC1500W	SP150VDC1500W	SP200VDC1500W
Input			
Input Voltage	90~265VAC		
Input Frequency	47~63Hz		
Power Factor	>0.98		
Input Power	1900VA(MAX)		
Output			
Output Voltage Range	0~75V	0~150V	0~200V
Output Current Range	0~25A	0~10A	0~8A
Output Power Range	0~1500W		
Voltage Load Regulation	10mV	15mV	15mV
Current Load Regulation	25mA	10mA	8mA
Voltage Display Resolution	0.1mV	1mV	1mV
Current Display Resolution	0.2mA	0.2mA	0.1mA
Voltage Programmable Resolution	1.5mV	3mV	3mV
Current Programmable Resolution	1mA	1mA	1mA
Voltage Setting Accuracy ^[1]	0.05%+15mV	0.05%+15mV	0.05%+15mV
Current Setting Accuracy	0.1%+25mA	0.1%+10mA	0.1%+8mA
Voltage Measurement Accuracy ^[1]	0.05%+15mV	0.1%+15mV	0.1%+15mV
Current Measurement Accuracy	0.1%+25mA	0.1%+10mA	0.1%+8mA
Voltage Ripple ^[2]	40mVp-p 6mVrms	120mVp-p 40mVrms	120mVp-p 40mVrms
Current Ripple ^[3]	25mA (Full Range) 10mA (TYP Value)	40mA (Full Range) 10mA (TYP Value)	40mA (Full Range) 10mA (TYP Value)
Line Regulation(Voltage)	0.005%+2mV	0.02%+8mV	0.02%+8mV
Line Regulation(Current)	4mA	10mA	30mA
Voltage Temperature Coefficient ^[4]	100ppm/°C		
Current Temperature Coefficient ^[4]	150ppm/°C		
DVM Resolution	0.1mV	4mV	1mV
DVM Precision ^[1]	0.05%+15mV	0.1%+30mV	0.1%+15mV
Operating Mode	Constant voltage (CV) / Constant current (CC)		
Remote Compensation	4V MAX		
Master-slave Control	Yes		
Response (Voltage Increase)	≤10ms	≤25ms	≤30ms
Response (Voltage Drop)	≤160ms (no load) ≤10ms (full load)	≤400ms (no load) ≤18ms (full load)	≤600ms (no load) ≤30ms (full load)
Load Transient Recovery Time ^[5]	≤2ms	≤3ms	≤3ms
Command Response Time	50ms		
Series Capability ^[6]	Up to 10 units	Up to 8 units	Up to 6 units
Parallel Capability	Up to 10 units		
Current Sharing ^[7]	20V	40V	50V
Efficiency (full load)	91%	90%	91%
Other			
Protection Function	OVP/OCP/OTP/OPP/SCP/FOLDBACK		
Anti Reverse Irrigation Protection	Yes		
Input Fuse	30A, 125VAC/250VAC, fast-acting type		
Unit Weight/Shipping Weight	8.9kg/11.7kg	9.3kg/12.7kg	9.3kg/12.7kg
Dimensions(WxHxD)	423.0x44.0x447.0 mm		
Communication Modes	1. RS232/RS485/USB/LAN; 2. RS232/RS485/USB/LAN/GPIB		
Operating Environment	Temperature 0~40°C, Relative Humidity 10%~90%(no condensation); Pollution degree 2, Installation category II, Indoor use.		
Cooling Mode	Forced air-cooling		
Altitude	2000m		
Insulation	AC input <->DC output, 4242VDC, AC input <-> PE, 2121VDC		

[1] %output+offset, when output voltage less than 5V, offset voltage is 30mV.

[2] Vp-p@20MHz, Vrms@1.25MHz.

The 20V/32V/40V/75V models voltage ripple is 50mVp-p/6mVrms @ 1V. For the 600V and 800V models, the voltage ripple from 0~5V is out of the range show above.

[3] Arms@1.25MHz, the TYP Value is measured at the rated output voltage with 100% resistive load, and the measured value at full range of output voltage with 100% resistive load is less than the Full Range value.

[4] 0~40°C.

[5] Time for output voltage to recover within 0.5%(0.75% @800V models) of its rated output for a load change from 10% to 90% of its rated output current. Voltage set point from 10% to 90% of rated output.

[6] The communication must insulated users from output when using remote control and the output voltage exceeds 800VDC.

[7] Current Share error $I_{\text{error}} \leq (I_{\text{avg}} \times 2.5\% + 5\% \text{ F.S}) \text{ A}$, F.S is the full scale of the current. $I_{\text{avg}} = I_{\text{sum}}/n$, where I_{avg} is average current, I_{sum} is total current and n is number of parallel units.

Note: Output voltage must be higher than 30% of maximum output voltage when Current Share function properly.

All specifications are subject to change without notice.

SP-1U/2U Series High Performance Programmable DC Power Supply

1600W in 1U

Model	SP32VDC1600W	SP40VDC1600W
Input		
Input Voltage	90~265VAC	
Input Frequency	47~63Hz	
Power Factor	>0.98	
Input Power	2000VA(MAX)	
Output		
Output Voltage Range	0~32V	0~40V
Output Current Range	0~50A	0~40A
Output Power Range	0~1600W	
Voltage Load Regulation	10mV	
Current Load Regulation	50mA	40mA
Voltage Display Resolution	0.1mV	
Current Display Resolution	0.2mA	
Voltage Programmable Resolution	1.5mV	
Current Programmable Resolution	2mA	
Voltage Setting Accuracy ^[1]	0.05%+15mV	
Current Setting Accuracy	0.1%+50mA	0.1%+40mA
Voltage Measurement Accuracy ^[1]	0.05%+15mV	
Current Measurement Accuracy	0.1%+50mA	0.1%+40mA
Voltage Ripple ^[2]	40mVp-p 6mVrms	
Current Ripple ^[3]	50mA (Full Range) 20mA (TYP Value)	40mA (Full Range) 20mA (TYP Value)
Line Regulation(Voltage)	0.005%+1mV	
Line Regulation(Current)	4mA	
Voltage Temperature Coefficient ^[4]	100ppm/°C	
Current Temperature Coefficient ^[4]	150ppm/°C	
DVM Resolution	0.1mV	
DVM Precision ^[1]	0.05%+15mV	
Operating Mode	Constant voltage (CV) / Constant current (CC)	
Remote Compensation	4V MAX	
Master-slave Control	Yes	
Response (Voltage Increase)	≤12ms	≤10ms
Response (Voltage Drop)	≤150ms (no load) ≤10ms (full load)	
Load Transient Recovery Time ^[5]	≤2ms	
Command Response Time	50ms	
Series Capability ^[6]	Up to 10 units	
Parallel Capability	Up to 10 units	
Current Sharing ^[7]	9V	12V
Efficiency (full load)	89%	90%
Other		
Protection Function	OVP/OCP/OTP/OPP/SCP/FOLDBACK	
Anti Reverse Irrigation Protection	Yes	
Input Fuse	30A, 125VAC/250VAC, fast-acting type	
Unit Weight/Shipping Weight	9.2kg/12kg	
Dimensions(WxHxD)	423.0x44.0x447.0 mm	
Communication Modes	1. RS232/RS485/USB/LAN; 2. RS232/RS485/USB/LAN/GPIB	
Operating Environment	Temperature 0~40°C, Relative Humidity 10%~90%(no condensation); Pollution degree 2, Installation category II, Indoor use.	
Cooling Mode	Forced air-cooling	
Altitude	2000m	
Insulation	AC input <->DC output, 4242VDC, AC input <-> PE, 2121VDC	

[1] %output+offset, when output voltage less than 5V, offset voltage is 30mV.

[2] Vp-p@20MHz, Vrms@1.25MHz.

The 20V/32V/40V/75V models voltage ripple is 50mVp-p/6mVrms @ 1V. For the 600V and 800V models, the voltage ripple from 0~5V is out of the range show above.

[3] Arms@1.25MHz, the TYP Value is measured at the rated output voltage with 100% resistive load, and the measured value at full range of output voltage with 100% resistive load is less than the Full Range value.

[4] 0~40°C.

[5] Time for output voltage to recover within 0.5%(0.75% @800V models) of its rated output for a load change from 10% to 90% of its rated output current. Voltage set point from 10% to 90% of rated output.

[6] The communication must insulated users from output when using remote control and the output voltage exceeds 800VDC.

[7] Current Share error $I_{\text{error}} = (I_{\text{avg}} * 2.5\% + 5\% \text{ F.S}) / n$, A, F.S is the full scale of the current. $I_{\text{avg}} = I_{\text{sum}} / n$, where I_{avg} is average current, I_{sum} is total current and n is number of parallel units.

Note: Output voltage must be higher than 30% of maximum output voltage when Current Share function properly.

All specifications are subject to change without notice.

SP-1U/2U Series High Performance Programmable DC Power Supply

1000W in 2U(1)

Model	SPS32VDC1000W	SPS40VDC1000W	SPS80VDC1000W	SPS120VDC1000W
Input				
Input Voltage	90~265VAC			
Input Frequency	47~63Hz			
Power Factor	>0.98	>0.98	>0.97	>0.98
Input Power	1500VA(MAX)	1300VA(MAX)	1200VA(MAX)	1300VA(MAX)
Output				
Output Voltage Range	0~32V	0~40V	0~80V	0~120V
Output Current Range	0~200A	0~120A	0~60A	0~40A
Output Power Range	0~1000W			
Voltage Load Regulation	30mV	15mV	15mV	15mV
Current Load Regulation	200mA	120mA	60mA	40mA
Voltage Display Resolution	0.1mV	0.1mV	0.1mV	1mV
Current Display Resolution	1mA	1mA	0.2mA	0.1mA
Voltage Programmable Resolution	1mV	1mV	1.5mV	3mV
Current Programmable Resolution	6mA	3mA	2mA	1mA
Voltage Setting Accuracy ^[1]	0.05%+15mV	0.05%+15mV	0.05%+15mV	0.1%+15mV
Current Setting Accuracy	0.1%+200mA	0.1%+120mA	0.1%+60mA	0.1%+40mA
Voltage Measurement Accuracy ^[1]	0.05%+15mV	0.05%+15mV	0.05%+15mV	0.1%+15mV
Current Measurement Accuracy	0.1%+200mA	0.1%+120mA	0.1%+60mA	0.1%+40mA
Voltage Ripple ^[2]	60mVp-p 10mVrms	40mVp-p 6mVrms	40mVp-p 6mVrms	80mVp-p 15mVrms
Current Ripple ^[3]	400mA (Full Range) 200mA (TYP Value)	150mA (Full Range) 20mA (TYP Value)	50mA (Full Range) 10mA (TYP Value)	60mA (Full Range) 10mA (TYP Value)
Line Regulation(Voltage)	0.01%+8mV	0.02%+8mV	0.01%+8mV	0.02%+8mV
Line Regulation(Current)	200mA	30mA	30mA	40mA
Voltage Temperature Coefficient ^[4]	100ppm/°C			
Current Temperature Coefficient ^[4]	150ppm/°C			
DVM Resolution	0.1mV	0.1mV	0.1mV	1mV
DVM Precision ^[1]	0.05%+15mV	0.05%+15mV	0.05%+15mV	0.1%+15mV
Operating Mode	Constant voltage (CV) / Constant current (CC)			
Remote Compensation	4V MAX	4V MAX	4V MAX	5V MAX
Master-slave Control	Yes			
Response (Voltage Increase)	≤20ms (no load) ≤40ms (full load)	≤10ms	≤15ms	≤20ms
Response (Voltage Drop)	≤500ms (no load) ≤45ms (full load)	≤350ms (no load) ≤10ms (full load)	≤450ms (no load) ≤30ms (full load)	≤350ms (no load) ≤21ms (full load)
Load Transient Recovery Time ^[5]	≤2ms			
Command Response Time	50ms			
Series Capability ^[6]	Up to 10 units			
Parallel Capability	Up to 10 units			
Current Sharing ^[7]	12V	12V	20V	30V
Efficiency (full load)	85%	87%	89%	88%
Other				
Protection Function	OVP/OCP/OTP/OPP/SCP/FOLDBACK			
Anti Reverse Irrigation Protection	No(customers can purchase other accessories to achieve this function, please consult the salesrepresentative for details)	Yes	Yes	Yes
Input Fuse	20A, 125VAC/250VAC, fast-acting type	30A, 125VAC/250VAC, fast-acting type	30A, 125VAC/250VAC, fast-acting type	30A, 125VAC/250VAC, fast-acting type
Unit Weight/Shipping Weight	14.7kg/18.7kg	14.7kg/18.7kg	13.2kg/16.8kg	13.2kg/16.8kg
Dimensions(WxHxD)	423.0x87.0x514.0 mm	423.0x87.0x514.0 mm	423.0x87.0x469.0 mm	423.0x87.0x469.0 mm
Communication Modes	1. RS232/RS485/USB/LAN; 2. RS232/RS485/USB/LAN/GPIB			
Operating Environment	Temperature 0~40°C, Relative Humidity 10%~90%(no condensation); Pollution degree 2, Installation category II, Indoor use.			
Cooling Mode	Forced air-cooling			
Altitude	2000m			
Insulation	AC input <->DC output, 4242VDC, AC input <-> PE, 2121VDC			

[1] %output+offset, when output voltage less than 5V, offset voltage is 30mV.

[2] Vp-p@20MHz, Vrms@1.25MHz.

The 20V/32V/40V/75V models voltage ripple is 50mVp-p/6mVrms @ 1V. For the 600V and 800V models, the voltage ripple from 0~5V is out of the range show above.

[3] Arms@1.25MHz, the TYP Value is measured at the rated output voltage with 100% resistive load, and the measured value at full range of output voltage with 100% resistive load is less than the Full Range value.

[4] 0~40°C.

[5] Time for output voltage to recover within 0.5%(0.75% @800V models) of its rated output for a load change from 10% to 90% of its rated output current. Voltage set point from 10% to 90% of rated output.

[6] The communication must insulated users from output when using remote control and the output voltage exceeds 800VDC.

[7] Current Share error $\leq (\text{lav} * 2.5\% + 5\% \text{ F.S}) \text{ A}$, F.S is the full scale of the current. $\text{lav} = \text{lsum}/n$, where lav is average current, lsum is total current and n is number of parallel units.

Note: Output voltage must be higher than 30% of maximum output voltage when Current Share function properly.

All specifications are subject to change without notice.

SP-1U/2U Series High Performance Programmable DC Power Supply

1000W in 2U(2)

Model	SPS150VDC1000W	SPS200VDC1000W	SPS600VDC1000W	SPS800VDC1000W
Input				
Input Voltage	90~265VAC			
Input Frequency	47~63Hz			
Power Factor	>0.98			
Input Power	1300VA(MAX)			
Output				
Output Voltage Range	0~150V	0~200V	0~600V	0~800V
Output Current Range	0~30A	0~24A	0~10A	0~7.5A
Output Power Range	0~1000W			
Voltage Load Regulation	15mV	15mV	30mV	200mV
Current Load Regulation	30mA	24mA	10mA	20mA
Voltage Display Resolution	1mV			
Current Display Resolution	0.1mA			
Voltage Programmable Resolution	3mV	4mV	12mV	24mV
Current Programmable Resolution	1mA			
Voltage Setting Accuracy ^[1]	0.1%+15mV	0.1%+15mV	0.05%+150mV	0.05%+200mV
Current Setting Accuracy	0.1%+30mA	0.1%+24mA	0.1%+10mA	0.1%+7.5mA
Voltage Measurement Accuracy ^[3]	0.1%+15mV	0.1%+15mV	0.05%+150mV	0.05%+200mV
Current Measurement Accuracy	0.1%+30mA	0.1%+24mA	0.1%+10mA	0.1%+7.5mA
Voltage Ripple ^[2]	80mVp-p 15mVrms	150mVp-p 30mVrms	350mVp-p 40mVrms	800mVp-p 200mVrms
Current Ripple ^[3]	60mA (Full Range) 10mA (TYP Value)	50mA (Full Range) 20mA (TYP Value)	25mA (Full Range) 10mA (TYP Value)	25mA (Full Range) 10mA (TYP Value)
Line Regulation(Voltage)	0.02%+8mV	0.02%+8mV	0.01%+30mV	0.01%+40mV
Line Regulation(Current)	30mA	30mA	15mA	15mA
Voltage Temperature Coefficient ^[4]	100ppm/°C			
Current Temperature Coefficient ^[4]	150ppm/°C			
DVM Resolution	1mV	1mV	12mV	12mV
DVM Precision ^[5]	0.1%+15mV	0.1%+15mV	0.05%+150mV	0.05%+200mV
Operating Mode	Constant voltage (CV) / Constant current (CC)			
Remote Compensation	5V MAX			
Master-slave Control	Yes			
Response (Voltage Increase)	≤25ms	≤30ms	≤60ms	≤60ms
Response (Voltage Drop)	≤500ms (no load) ≤25ms (full load)	≤500ms (no load) ≤35ms (full load)	≤800ms (no load) ≤110ms (full load)	≤800ms (no load) ≤60ms (full load)
Load Transient Recovery Time ^[6]	≤2ms	≤2ms	≤3ms	≤3ms
Command Response Time	50ms			
Series Capability ^[6]	Up to 8 units	Up to 6 units	Up to 2 units	Not Recommended
Parallel Capability	Up to 10 units			
Current Sharing ^[7]	40V	50V	200V	250V
Efficiency (full load)	88%	88%	86%	85%
Other				
Protection Function	OVP/OCP/OTP/OPP/SCP/FOLDBACK			
Anti Reverse Irrigation Protection	Yes			
Input Fuse	30A, 125VAC/250VAC, fast-acting type			
Unit Weight/Shipping Weight	13.2kg/16.8kg	14.7kg/18.7kg	13.2kg/16.8kg	13.2kg/16.8kg
Dimensions(WxHxD)	423.0x87.0x469.0 mm	423.0x87.0x469.0 mm	423.0x87.0x514.0 mm	423.0x87.0x514.0 mm
Communication Modes	1. RS232/RS485/USB/LAN; 2. RS232/RS485/USB/LAN/GPIB			
Operating Environment	Temperature 0~40°C, Relative Humidity 10%~90%(no condensation); Pollution degree 2, Installation category II, Indoor use.			
Cooling Mode	Forced air-cooling			
Altitude	2000m			
Insulation	AC input <->DC output, 4242VDC, AC input <-> PE, 2121VDC			

[1] %output+offset, when output voltage less than 5V, offset voltage is 30mV.

[2] Vp-p@20MHz, Vrms@1.25MHz.

The 20V/32V/40V/75V models voltage ripple is 50mVp-p/6mVrms @ 1V. For the 600V and 800V models, the voltage ripple from 0~5V is out of the range show above.

[3] Arms@1.25MHz, the TYP Value is measured at the rated output voltage with 100% resistive load, and the measured value at full range of output voltage with 100% resistive load is less than the Full Range value.

[4] 0~40°C.

[5] Time for output voltage to recover within 0.5%(0.75% @800V models) of its rated output for a load change from 10% to 90% of its rated output current. Voltage set point from 10% to 90% of rated output.

[6] The communication must insulated users from output when using remote control and the output voltage exceeds 800VDC.

[7] Current Share error $I_{\text{error}} = (I_{\text{AV}} * 2.5\% + 5\% \text{ F.S}) / A$, F.S is the full scale of the current. $I_{\text{AV}} = I_{\text{sum}} / n$, where I_{AV} is average current, I_{sum} is total current and n is number of parallel units.

Note: Output voltage must be higher than 30% of maximum output voltage when Current Share function properly.

All specifications are subject to change without notice.

SP-1U/2U Series High Performance Programmable DC Power Supply

2000W in 2U(1)

Model	SP32VDC2000W	SP40VDC2000W	SP80VDC2000W	SP120VDC2000W
Input				
Input Voltage	190~265VAC			
Input Frequency	47~63Hz			
Power Factor	>0.98			
Input Power	2600VA(MAX)	2400VA(MAX)	2400VA(MAX)	2400VA(MAX)
Output				
Output Voltage Range	0~32V	0~40V	0~80V	0~120V
Output Current Range	0~200A	0~120A	0~60A	0~40A
Output Power Range	0~2000W			
Voltage Load Regulation	30mV	15mV	15mV	15mV
Current Load Regulation	200mA	120mA	60mA	40mA
Voltage Display Resolution	0.1mV	0.1mV	0.1mV	1mV
Current Display Resolution	1mA	1mA	0.2mA	0.1mA
Voltage Programmable Resolution	1mV	1mV	1.5mV	3mV
Current Programmable Resolution	6mA	3mA	2mA	1mA
Voltage Setting Accuracy ^[1]	0.05%+15mV	0.05%+15mV	0.05%+15mV	0.1%+15mV
Current Setting Accuracy	0.1%+200mA	0.1%+120mA	0.1%+60mA	0.1%+40mA
Voltage Measurement Accuracy ^[1]	0.05%+15mV	0.05%+15mV	0.05%+15mV	0.1%+15mV
Current Measurement Accuracy	0.1%+200mA	0.1%+120mA	0.1%+60mA	0.1%+40mA
Voltage Ripple ^[2]	60mVp-p 10mVrms	40mVp-p 6mVrms	40mVp-p 6mVrms	80mVp-p 15mVrms
Current Ripple ^[3]	400mA (Full Range) 200mA (TYP Value)	150mA (Full Range) 20mA (TYP Value)	50mA (Full Range) 10mA (TYP Value)	60mA (Full Range) 10mA (TYP Value)
Line Regulation(Voltage)	0.01%+8mV	0.01%+8mV	0.01%+8mV	0.02%+8mV
Line Regulation(Current)	200mA	30mA	30mA	30mA
Voltage Temperature Coefficient ^[4]	100ppm/°C			
Current Temperature Coefficient ^[4]	150ppm/°C			
DVM Resolution	0.1mV	0.1mV	0.1mV	1mV
DVM Precision ^[1]	0.05%+15mV	0.05%+15mV	0.05%+15mV	0.1%+15mV
Operating Mode	Constant voltage (CV) / Constant current (CC)			
Remote Compensation	4V MAX	4V MAX	4V MAX	5V MAX
Master-slave Control	Yes			
Response (Voltage Increase)	≤20ms (no load) ≤30ms (full load)	≤10ms	≤15ms	≤20ms
Response (Voltage Drop)	≤500ms (no load) ≤30ms (full load)	≤350ms (no load) ≤10ms (full load)	≤450ms (no load) ≤30ms (full load)	≤350ms (no load) ≤21ms (full load)
Load Transient Recovery Time ^[5]	≤2ms	≤2ms	≤2ms	≤3ms
Command Response Time	50ms			
Series Capability ^[6]	Up to 10 units	Up to 10 units	Up to 10 units	Up to 8 units
Parallel Capability	Up to 10 units			
Current Sharing ^[7]	12V	12V	20V	30V
Efficiency (full load)	91%	88%	89%	89%
Other				
Protection Function	OVP/OCP/OTP/OPP/SCP/FOLDBACK			
Anti Reverse Irrigation Protection	No(customers can purchase other accessories to achieve this function, please consult the salesrepresentative for details)	Yes	Yes	Yes
Input Fuse	20A, 125VAC/250VAC, fast-acting type	30A, 125VAC/250VAC, fast-acting type	30A, 125VAC/250VAC, fast-acting type	30A, 125VAC/250VAC, fast-acting type
Unit Weight/Shipping Weight	14.7kg/18.7kg	14.7kg/18.7kg	13.2kg/16.8kg	13.2kg/16.8kg
Dimensions(WxHxD)	423.0x87.0x514.0 mm	423.0x87.0x514.0 mm	423.0x87.0x469.0 mm	423.0x87.0x469.0 mm
Communication Modes	1. RS232/RS485/USB/LAN; 2. RS232/RS485/USB/LAN/GPIB			
Operating Environment	Temperature 0~40°C, Relative Humidity 10%~90%(no condensation); Pollution degree 2, Installation category II, Indoor use.			
Cooling Mode	Forced air-cooling			
Altitude	2000m			
Insulation	AC input <->DC output, 4242VDC, AC input <-> PE, 2121VDC			

[1] %output+offset, when output voltage less than 5V, offset voltage is 30mV.

[2] Vp-p@20MHz, Vrms@1.25MHz.

The 20V/32V/40V/75V models voltage ripple is 50mVp-p/6mVrms @ 1V. For the 600V and 800V models, the voltage ripple from 0~5V is out of the range show above.

[3] Arms@1.25MHz, the TYP Value is measured at the rated output voltage with 100% resistive load, and the measured value at full range of output voltage with 100% resistive load is less than the Full Range value.

[4] 0~40°C.

[5] Time for output voltage to recover within 0.5%(0.75% @800V models) of its rated output for a load change from 10% to 90% of its rated output current. Voltage set point from 10% to 90% of rated output.

[6] The communication must insulated users from output when using remote control and the output voltage exceeds 800VDC.

[7] Current Share error $\leq(\text{lav}^*2.5\% + 5\% \text{ F.S}) \text{ A}$, F.S is the full scale of the current. $\text{lav}=\text{lsum}/\text{n}$, where lav is average current, lsum is total current and n is number of parallel units.

Note: Output voltage must be higher than 30% of maximum output voltage when Current Share function properly.

All specifications are subject to change without notice.

SP-1U/2U Series High Performance Programmable DC Power Supply

2000W in 2U(2)

Model	SP150VDC2000W	SP200VDC2000W	SP600VDC2000W	SP800VDC2000W
Input				
Input Voltage	190~265VAC			
Input Frequency	47~63Hz			
Power Factor	>0.98			
Input Power	2400VA(MAX)			
Output				
Output Voltage Range	0~150V	0~200V	0~600V	0~800V
Output Current Range	0~30A	0~24A	0~10A	0~7.5A
Output Power Range	0~2000W			
Voltage Load Regulation	15mV	15mV	30mV	200mV
Current Load Regulation	30mA	24mA	10mA	20mA
Voltage Display Resolution	1mV			
Current Display Resolution	0.1mA			
Voltage Programmable Resolution	3mV	4mV	12mV	24mV
Current Programmable Resolution	1mA			
Voltage Setting Accuracy ^[1]	0.1%+15mV	0.1%+15mV	0.05%+150mV	0.05%+200mV
Current Setting Accuracy	0.1%+30mA	0.1%+24mA	0.1%+10mA	0.1%+7.5mA
Voltage Measurement Accuracy ^[3]	0.1%+15mV	0.1%+15mV	0.05%+150mV	0.05%+200mV
Current Measurement Accuracy	0.1%+30mA	0.1%+24mA	0.1%+10mA	0.1%+7.5mA
Voltage Ripple ^[2]	40mVp-p 6mVrms	150mVp-p 30mVrms	350mVp-p 40mVrms	800mVp-p 200mVrms
Current Ripple ^[3]	60mA (Full Range) 10mA (TYP Value)	50mA (Full Range) 20mA (TYP Value)	25mA (Full Range) 10mA (TYP Value)	25mA (Full Range) 10mA (TYP Value)
Line Regulation(Voltage)	0.02%+8mV	0.02%+8mV	0.01%+30mV	0.01%+40mV
Line Regulation(Current)	30mA	30mA	15mA	20mA
Voltage Temperature Coefficient ^[4]	100ppm/°C			
Current Temperature Coefficient ^[4]	150ppm/°C			
DVM Resolution	1mV	1mV	12mV	12mV
DVM Precision ^[1]	0.1%+15mV	0.1%+15mV	0.05%+150mV	0.05%+200mV
Operating Mode	Constant voltage (CV) / Constant current (CC)			
Remote Compensation	5V MAX			
Master-slave Control	Yes			
Response (Voltage Increase)	≤25ms	≤30ms	≤60ms	≤60ms
Response (Voltage Drop)	≤500ms (no load) ≤25ms (full load)	≤500ms (no load) ≤20ms (full load)	≤800ms (no load) ≤90ms (full load)	≤800ms (no load) ≤60ms (full load)
Load Transient Recovery Time ^[5]	≤3ms			
Command Response Time	50ms			
Series Capability ^[6]	Up to 8 units	Up to 6 units	Up to 2 units	Not Recommended
Parallel Capability	Up to 10 units			
Current Sharing ^[7]	40V	50V	200V	250V
Efficiency (full load)	90%	90%	90%	91%
Other				
Protection Function	OVP/OCP/OTP/OPP/SCP/FOLDBACK			
Anti Reverse Irrigation Protection	Yes			
Input Fuse	30A, 125VAC/250VAC, fast-acting type	30A, 125VAC/250VAC, fast-acting type	20A, 125VAC/250VAC, fast-acting type	20A, 125VAC/250VAC, fast-acting type
Unit Weight/Shipping Weight	13.2kg/16.8kg	13.2kg/16.8kg	14.7kg/18.7kg	14.7kg/18.7kg
Dimensions(WxHxD)	423.0x87.0x469.0 mm	423.0x87.0x469.0 mm	423.0x87.0x514.0 mm	423.0x87.0x514.0 mm
Communication Modes	1. RS232/RS485/USB/LAN; 2. RS232/RS485/USB/LAN/GPIB			
Operating Environment	Temperature 0~40°C, Relative Humidity 10%~90%(no condensation); Pollution degree 2, Installation category II, Indoor use.			
Cooling Mode	Forced air-cooling			
Altitude	2000m			
Insulation	AC input ↔DC output, 4242VDC, AC input ↔ PE, 2121VDC			

[1] %output+offset, when output voltage less than 5V, offset voltage is 30mV.

[2] Vp-p@20MHz, Vrms@1.25MHz.

The 20V/32V/40V/75V models voltage ripple is 50mVp-p/6mVrms @ 1V. For the 600V and 800V models, the voltage ripple from 0~5V is out of the range show above.

[3] Arms@1.25MHz, the TYP Value is measured at the rated output voltage with 100% resistive load, and the measured value at full range of output voltage with 100% resistive load is less than the Full Range value.

[4] 0~40°C.

[5] Time for output voltage to recover within 0.5%(0.75% @800V models) of its rated output for a load change from 10% to 90% of its rated output current. Voltage set point from 10% to 90% of rated output.

[6] The communication must insulated users from output when using remote control and the output voltage exceeds 800VDC.

[7] Current Share error $I_{\text{error}} = (I_{\text{AV}} \times 2.5\% + 5\% \text{ F.S}) \times A$, F.S is the full scale of the current. $I_{\text{AV}} = I_{\text{sum}}/n$, where I_{AV} is average current, I_{sum} is total current and n is number of parallel units.

Note: Output voltage must be higher than 30% of maximum output voltage when Current Share function properly.

All specifications are subject to change without notice.

SP-1U/2U Series High Performance Programmable DC Power Supply

3000W in 2U(1)

Model	SP32VDC3000W	SP40VDC3000W	SP80VDC3000W	SP120VDC3000W
Input				
Input Voltage	190~265VAC			
Input Frequency	47~63Hz			
Power Factor	>0.98			
Input Power	3700VA(MAX)	3400VA(MAX)	3400VA(MAX)	3400VA(MAX)
Output				
Output Voltage Range	0~32V	0~40V	0~80V	0~120V
Output Current Range	0~200A	0~120A	0~60A	0~40A
Output Power Range	0~3000W			
Voltage Load Regulation	30mV	15mV	15mV	15mV
Current Load Regulation	200mA	120mA	60mA	40mA
Voltage Display Resolution	0.1mV	0.1mV	0.1mV	1mV
Current Display Resolution	1mA	1mA	0.2mA	0.1mA
Voltage Programmable Resolution	1mV	1mV	1.5mV	3mV
Current Programmable Resolution	6mA	2mA	2mA	1mA
Voltage Setting Accuracy ^[1]	0.05%+15mV	0.05%+15mV	0.05%+15mV	0.1%+15mV
Current Setting Accuracy	0.1%+200mA	0.1%+120mA	0.1%+60mA	0.1%+40mA
Voltage Measurement Accuracy ^[1]	0.05%+15mV	0.05%+15mV	0.05%+15mV	0.1%+15mV
Current Measurement Accuracy	0.1%+200mA	0.1%+120mA	0.1%+60mA	0.1%+40mA
Voltage Ripple ^[2]	60mVp-p 10mVrms	40mVp-p 6mVrms	40mVp-p 6mVrms	80mVp-p 15mVrms
Current Ripple ^[3]	400mA (Full Range) 200mA (TYP Value)	150mA (Full Range) 20mA (TYP Value)	50mA (Full Range) 10mA (TYP Value)	60mA (Full Range) 10mA (TYP Value)
Line Regulation(Voltage)	0.01%+8mV	0.01%+8mV	0.01%+8mV	0.02%+8mV
Line Regulation(Current)	200mA	30mA	30mA	30mA
Voltage Temperature Coefficient ^[4]	100ppm/°C			
Current Temperature Coefficient ^[4]	150ppm/°C			
DVM Resolution	0.1mV	0.1mV	0.1mV	1mV
DVM Precision ^[1]	0.05%+15mV	0.05%+15mV	0.05%+15mV	0.1%+15mV
Operating Mode	Constant voltage (CV) / Constant current (CC)			
Remote Compensation	4V MAX	4V MAX	4V MAX	5V MAX
Master-slave Control	Yes			
Response (Voltage Increase)	≤20ms (no load) ≤20ms (full load)	≤10ms	≤15ms	≤20ms
Response (Voltage Drop)	≤500ms (no load) ≤25ms (full load)	≤350ms (no load) ≤10ms (full load)	≤450ms (no load) ≤30ms (full load)	≤350ms (no load) ≤21ms (full load)
Load Transient Recovery Time ^[5]	≤2ms			
Command Response Time	50ms			
Series Capability ^[6]	Up to 10 units			
Parallel Capability	Up to 10 units			
Current Sharing ^[7]	12V	12V	20V	30V
Efficiency (full load)	91%	88%	91%	91%
Other				
Protection Function	OVP/OCP/OTP/OPP/SCP/FOLDBACK			
Anti Reverse Irrigation Protection	No(customers can purchase other accessories to achieve this function, please consult the salesrepresentative for details)	Yes	Yes	Yes
Input Fuse	30A, 125VAC/250VAC, fast-acting type	40A, 125VAC/250VAC, fast-acting type	40A, 125VAC/250VAC, fast-acting type	40A, 125VAC/250VAC, fast-acting type
Unit Weight/Shipping Weight	14.7kg/18.7kg	14.7kg/18.7kg	13.2kg/16.8kg	13.2kg/16.8kg
Dimensions(WxHxD)	423.0x87.0x514.0 mm	423.0x87.0x514.0 mm	423.0x87.0x469.0 mm	423.0x87.0x469.0 mm
Communication Modes	1. RS232/RS485/USB/LAN; 2. RS232/RS485/USB/LAN/GPIB			
Operating Environment	Temperature 0~40°C, Relative Humidity 10%~90%(no condensation); Pollution degree 2, Installation category II, Indoor use.			
Cooling Mode	Forced air-cooling			
Altitude	2000m			
Insulation	AC input <->DC output, 4242VDC, AC input <-> PE, 2121VDC			

[1] %output+offset, when output voltage less than 5V, offset voltage is 30mV.

[2] Vp-p@20MHz, Vrms@1.25MHz.

The 20V/32V/40V/75V models voltage ripple is 50mVp-p/6mVrms @ 1V. For the 600V and 800V models, the voltage ripple from 0~5V is out of the range show above.

[3] Arms@1.25MHz, the TYP Value is measured at the rated output voltage with 100% resistive load, and the measured value at full range of output voltage with 100% resistive load is less than the Full Range value.

[4] 0~40°C.

[5] Time for output voltage to recover within 0.5%(0.75% @800V models) of its rated output for a load change from 10% to 90% of its rated output current. Voltage set point from 10% to 90% of rated output.

[6] The communication must insulated users from output when using remote control and the output voltage exceeds 800VDC.

[7] Current Share error $I_{\text{error}} < (I_{\text{AV}} * 2.5\% + 5\% \text{ F.S}) A$, F.S is the full scale of the current. $I_{\text{AV}} = I_{\text{SUM}}/n$, where I_{AV} is average current, I_{SUM} is total current and n is number of parallel units.

Note: Output voltage must be higher than 30% of maximum output voltage when Current Share function properly.

All specifications are subject to change without notice.

SP-1U/2U Series High Performance Programmable DC Power Supply

3000W in 2U(2)

Model	SP150VDC3000W	SP200VDC3000W	SP600VDC3000W	SP800VDC3000W
Input				
Input Voltage	190~265VAC			
Input Frequency	47~63Hz			
Power Factor	>0.98			
Input Power	3400VA(MAX)			
Output				
Output Voltage Range	0~150V	0~200V	0~600V	0~800V
Output Current Range	0~30A	0~24A	0~10A	0~7.5A
Output Power Range	0~3000W			
Voltage Load Regulation	15mV	15mV	30mV	200mV
Current Load Regulation	30mA	24mA	10mA	20mA
Voltage Display Resolution	1mV			
Current Display Resolution	0.1mA			
Voltage Programmable Resolution	3mV	4mV	12mV	24mV
Current Programmable Resolution	1mA			
Voltage Setting Accuracy ^[1]	0.1%+15mV	0.1%+15mV	0.05%+150mV	0.05%+200mV
Current Setting Accuracy	0.1%+30mA	0.1%+24mA	0.1%+10mA	0.1%+7.5mA
Voltage Measurement Accuracy ^[1]	0.1%+15mV	0.1%+15mV	0.05%+150mV	0.05%+200mV
Current Measurement Accuracy	0.1%+30mA	0.1%+24mA	0.1%+10mA	0.1%+7.5mA
Voltage Ripple ^[2]	80mVp-p 15mVrms	150mVp-p 30mVrms	350mVp-p 40mVrms	800mVp-p 200mVrms
Current Ripple ^[3]	60mA (Full Range) 10mA (TYP Value)	50mA (Full Range) 20mA (TYP Value)	25mA (Full Range) 10mA (TYP Value)	25mA (Full Range) 10mA (TYP Value)
Line Regulation(Voltage)	0.02%+8mV	0.02%+8mV	0.01%+30mV	0.01%+40mV
Line Regulation(Current)	30mA	30mA	15mA	20mA
Voltage Temperature Coefficient ^[4]	100ppm/°C			
Current Temperature Coefficient ^[4]	150ppm/°C			
DVM Resolution	1mV	1mV	12mV	12mV
DVM Precision ^[1]	0.1%+15mV	0.1%+15mV	0.05%+150mV	0.05%+200mV
Operating Mode	Constant voltage (CV) / Constant current (CC)			
Remote Compensation	5V MAX			
Master-slave Control	Yes			
Response (Voltage Increase)	≤25ms	≤30ms	≤60ms	≤60ms
Response (Voltage Drop)	≤500ms (no load) ≤25ms (full load)	≤500ms (no load) ≤20ms (full load)	≤800ms (no load) ≤75ms (full load)	≤800ms (no load) ≤60ms (full load)
Load Transient Recovery Time ^[5]	≤2.5ms	≤3ms	≤3ms	≤3ms
Command Response Time	50ms			
Series Capability ^[6]	Up to 8 units	Up to 6 units	Up to 2 units	Not Recommended
Parallel Capability	Up to 10 units			
Current Sharing ^[7]	40V	50V	200V	250V
Efficiency (full load)	92%	91%	91%	91%
Other				
Protection Function	OVP/OCP/OTP/OPP/SCP/FOLDBACK			
Anti Reverse Irrigation Protection	Yes			
Input Fuse	40A, 125VAC/250VAC, fast-acting type	40A, 125VAC/250VAC, fast-acting type	30A, 125VAC/250VAC, fast-acting type	30A, 125VAC/250VAC, fast-acting type
Unit Weight/Shipping Weight	13.2kg/16.8kg	13.2kg/16.8kg	14.7kg/18.7kg	14.7kg/18.7kg
Dimensions(WxHxD)	423.0x87.0x469.0 mm	423.0x87.0x469.0 mm	423.0x87.0x514.0 mm	423.0x87.0x514.0 mm
Communication Modes	1. RS232/RS485/USB/LAN; 2. RS232/RS485/USB/LAN/GPIB			
Operating Environment	Temperature 0~40°C, Relative Humidity 10%~90%(no condensation); Pollution degree 2, Installation category II, Indoor use.			
Cooling Mode	Forced air-cooling			
Altitude	2000m			
Insulation	AC input ↔ DC output, 4242VDC, AC input ↔ PE, 2121VDC			

[1] %output+offset, when output voltage less than 5V, offset voltage is 30mV.

[2] Vp-p@20MHz, Vrms@1.25MHz.

The 20V/32V/40V/75V models voltage ripple is 50mVp-p/6mVrms @ 1V. For the 600V and 800V models, the voltage ripple from 0~5V is out of the range show above.

[3] Arms@1.25MHz, the TYP Value is measured at the rated output voltage with 100% resistive load, and the measured value at full range of output voltage with 100% resistive load is less than the Full Range value.

[4] 0~40°C.

[5] Time for output voltage to recover within 0.5%(0.75% @800V models) of its rated output for a load change from 10% to 90% of its rated output current. Voltage set point from 10% to 90% of rated output.

[6] The communication must insulated users from output when using remote control and the output voltage exceeds 800VDC.

[7] Current Share error $I_{\text{error}} = (I_{\text{avg}} * 2.5\% + 5\% \text{ F.S}) / A$, F.S is the full scale of the current. $I_{\text{avg}} = I_{\text{sum}} / n$, where I_{avg} is average current, I_{sum} is total current and n is number of parallel units.

Note: Output voltage must be higher than 30% of maximum output voltage when Current Share function properly.

All specifications are subject to change without notice.

SP-1U/2U Series High Performance Programmable DC Power Supply

4000W in 2U(1)

Model	SP32VDC4000W	SP40VDC4000W	SP75VDC4000W	SP120VDC4000W
Input				
Input Voltage	190~265VAC			
Input Frequency	47~63Hz			
Power Factor	>0.98			
Input Power	4800VA(MAX)	4500VA(MAX)	4500VA(MAX)	4500VA(MAX)
Output				
Output Voltage Range	0~32V	0~40V	0~75V	0~120V
Output Current Range	0~200A	0~120A	0~60A	0~40A
Output Power Range	0~4000W			
Voltage Load Regulation	30mV	15mV	15mV	15mV
Current Load Regulation	200mA	120mA	60mA	40mA
Voltage Display Resolution	0.1mV	0.1mV	0.1mV	1mV
Current Display Resolution	1mA	1mA	0.1mA	0.1mA
Voltage Programmable Resolution	1mV	1mV	2mV	3mV
Current Programmable Resolution	6mA	3mA	2mA	1mA
Voltage Setting Accuracy ^[1]	0.05%+15mV	0.05%+15mV	0.1%+15mV	0.1%+15mV
Current Setting Accuracy	0.1%+200mA	0.1%+120mA	0.1%+60mA	0.1%+40mA
Voltage Measurement Accuracy ^[1]	0.05%+15mV	0.05%+15mV	0.1%+15mV	0.1%+15mV
Current Measurement Accuracy	0.1%+200mA	0.1%+120mA	0.1%+60mA	0.1%+40mA
Voltage Ripple ^[2]	60mVp-p 10mVrms	40mVp-p 6mVrms	40mVp-p 8mVrms	80mVp-p 15mVrms
Current Ripple ^[3]	400mA (Full Range) 200mA (TYP Value)	150mA (Full Range) 20mA (TYP Value)	60mA (Full Range) 10mA (TYP Value)	60mA (Full Range) 10mA (TYP Value)
Line Regulation(Voltage)	0.01%+8mV	0.01%+8mV	0.01%+8mV	0.02%+8mV
Line Regulation(Current)	200mA	30mA	30mA	30mA
Voltage Temperature Coefficient ^[4]	100ppm/°C			
Current Temperature Coefficient ^[4]	150ppm/°C			
DVM Resolution	0.1mV	0.1mV	0.1mV	1mV
DVM Precision ^[1]	0.05%+15mV	0.05%+15mV	0.05%+15mV	0.1%+15mV
Operating Mode	Constant voltage (CV) / Constant current (CC)			
Remote Compensation	4V MAX	4V MAX	5V MAX	5V MAX
Master-slave Control	Yes			
Response (Voltage Increase)	≤20ms (no load) ≤20ms (full load)	≤10ms	≤15ms	≤20ms
Response (Voltage Drop)	≤500ms (no load) ≤20ms (full load)	≤350ms (no load) ≤10ms (full load)	≤450ms (no load) ≤20ms (full load)	≤350ms (no load) ≤21ms (full load)
Load Transient Recovery Time ^[5]	≤2ms			
Command Response Time	50ms			
Series Capability ^[6]	Up to 10 units			
Parallel Capability	Up to 10 units			
Current Sharing ^[7]	12V	12V	20V	30V
Efficiency (full load)	91%	91%	91%	92%
Other				
Protection Function	OVP/OCP/OTP/OPP/SCP/FOLDBACK			
Anti Reverse Irrigation Protection	No(customers can purchase other accessories to achieve this function, please consult the salesrepresentative for details)	Yes	Yes	Yes
Input Fuse	40A, 125VAC/250VAC, fast-acting type			
Unit Weight/Shipping Weight	14.7kg/18.7kg	14.7kg/18.7kg	13.2kg/16.8kg	13.2kg/16.8kg
Dimensions(WxHxD)	423.0x87.0x514.0 mm	423.0x87.0x514.0 mm	423.0x87.0x469.0 mm	423.0x87.0x469.0 mm
Communication Modes	1. RS232/RS485/USB/LAN; 2. RS232/RS485/USB/LAN/GPIB			
Operating Environment	Temperature 0~40°C, Relative Humidity 10%~90%(no condensation); Pollution degree 2, Installation category II, Indoor use.			
Cooling Mode	Forced air-cooling			
Altitude	2000m			
Insulation	AC input <->DC output, 4242VDC, AC input <-> PE, 2121VDC			

[1] %output+offset, when output voltage less than 5V, offset voltage is 30mV.

[2] Vp-p@20MHz, Vrms@1.25MHz.

The 20V/32V/40V/75V models voltage ripple is 50mVp-p/6mVrms @ 1V. For the 600V and 800V models, the voltage ripple from 0~5V is out of the range show above.

[3] Arms@1.25MHz, the TYP Value is measured at the rated output voltage with 100% resistive load, and the measured value at full range of output voltage with 100% resistive load is less than the Full Range value.

[4] 0~40°C.

[5] Time for output voltage to recover within 0.5%(0.75% @800V models) of its rated output for a load change from 10% to 90% of its rated output current. Voltage set point from 10% to 90% of rated output.

[6] The communication must insulated users from output when using remote control and the output voltage exceeds 800VDC.

[7] Current Share error $I_{\text{error}} < (I_{\text{AV}} * 2.5\% + 5\% \text{ F.S}) A$, F.S is the full scale of the current. $I_{\text{AV}} = I_{\text{SUM}}/n$, where I_{AV} is average current, I_{SUM} is total current and n is number of parallel units.

Note: Output voltage must be higher than 30% of maximum output voltage when Current Share function properly.

All specifications are subject to change without notice.

SP-1U/2U Series High Performance Programmable DC Power Supply

4000W in 2U(2)

Model	SP150VDC4000W	SP200VDC4000W	SP600VDC4000W	SP800VDC4000W
Input				
Input Voltage	190~265VAC			
Input Frequency	47~63Hz			
Power Factor	>0.98			
Input Power	4500VA(MAX)			
Output				
Output Voltage Range	0~150V	0~200V	0~600V	0~800V
Output Current Range	0~30A	0~24A	0~10A	0~7.5A
Output Power Range	0~4000W			
Voltage Load Regulation	15mV	25mV	30mV	200mV
Current Load Regulation	30mA	24mA	10mA	20mA
Voltage Display Resolution	1mV			
Current Display Resolution	0.1mA			
Voltage Programmable Resolution	3mV	4mV	12mV	24mV
Current Programmable Resolution	1mA			
Voltage Setting Accuracy ^[1]	0.1%+15mV	0.1%+15mV	0.05%+150mV	0.05%+200mV
Current Setting Accuracy	0.1%+30mA	0.1%+24mA	0.1%+10mA	0.1%+7.5mA
Voltage Measurement Accuracy ^[1]	0.1%+15mV	0.1%+15mV	0.05%+150mV	0.05%+200mV
Current Measurement Accuracy	0.1%+30mA	0.1%+24mA	0.1%+10mA	0.1%+7.5mA
Voltage Ripple ^[2]	80mVp-p 15mVrms	150mVp-p 30mVrms	350mVp-p 40mVrms	800mVp-p 200mVrms
Current Ripple ^[3]	60mA (Full Range) 10mA (TYP Value)	50mA (Full Range) 20mA (TYP Value)	25mA (Full Range) 10mA (TYP Value)	25mA (Full Range) 10mA (TYP Value)
Line Regulation(Voltage)	0.02%+8mV	0.02%+8mV	0.01%+30mV	0.01%+40mV
Line Regulation(Current)	30mA	30mA	15mA	20mA
Voltage Temperature Coefficient ^[4]	100ppm/°C			
Current Temperature Coefficient ^[4]	150ppm/°C			
DVM Resolution	1mV	1mV	12mV	12mV
DVM Precision ^[1]	0.1%+15mV	0.1%+15mV	0.05%+150mV	0.05%+200mV
Operating Mode	Constant voltage (CV) / Constant current (CC)			
Remote Compensation	5V MAX			
Master-slave Control	Yes			
Response (Voltage Increase)	≤25ms	≤30ms	≤60ms	≤60ms
Response (Voltage Drop)	≤500ms (no load) ≤25ms (full load)	≤500ms (no load) ≤20ms (full load)	≤800ms (no load) ≤60ms (full load)	≤800ms (no load) ≤60ms (full load)
Load Transient Recovery Time ^[5]	≤2.5ms	≤3ms	≤3ms	≤3ms
Command Response Time	50ms			
Series Capability ^[6]	Up to 8 units	Up to 6 units	Up to 2 units	Not Recommended
Parallel Capability	Up to 10 units			
Current Sharing ^[7]	40V	50V	200V	250V
Efficiency (full load)	93%	92%	92%	92%
Other				
Protection Function	OVP/OCP/OTP/OPP/SCP/FOLDBACK			
Anti Reverse Irrigation Protection	Yes			
Input Fuse	40A, 125VAC/250VAC, fast-acting type			
Unit Weight/Shipping Weight	13.2kg/16.8kg	13.2kg/16.8kg	14.7kg/18.7kg	14.7kg/18.7kg
Dimensions(WxHxD)	423.0x87.0x469.0 mm	423.0x87.0x469.0 mm	423.0x87.0x514.0 mm	423.0x87.0x514.0 mm
Communication Modes	1. RS232/RS485/USB/LAN; 2. RS232/RS485/USB/LAN/GPIB			
Operating Environment	Temperature 0~40°C, Relative Humidity 10%~90%(no condensation); Pollution degree 2, Installation category II, Indoor use.			
Cooling Mode	Forced air-cooling			
Altitude	2000m			
Insulation	AC input <-> DC output, 4242VDC, AC input <-> PE, 2121VDC			

[1] %output+offset, when output voltage less than 5V, offset voltage is 30mV.

[2] Vp-p@20MHz, Vrms@1.25MHz.

The 20V/32V/40V/75V models voltage ripple is 50mVp-p/6mVrms @ 1V. For the 600V and 800V models, the voltage ripple from 0~5V is out of the range show above.

[3] Arms@1.25MHz, the TYP Value is measured at the rated output voltage with 100% resistive load, and the measured value at full range of output voltage with 100% resistive load is less than the Full Range value.

[4] 0~40°C.

[5] Time for output voltage to recover within 0.5%(0.75% @800V models) of its rated output for a load change from 10% to 90% of its rated output current. Voltage set point from 10% to 90% of rated output.

[6] The communication must insulated users from output when using remote control and the output voltage exceeds 800VDC.

[7] Current Share error $I_{\text{error}} = (I_{\text{avg}} * 2.5\% + 5\% \text{ F.S.}) A$, F.S is the full scale of the current. $I_{\text{avg}} = I_{\text{sum}}/n$, where I_{avg} is average current, I_{sum} is total current and n is number of parallel units.

Note: Output voltage must be higher than 30% of maximum output voltage when Current Share function properly.

All specifications are subject to change without notice.

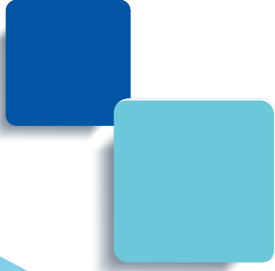

APM Technologies Ltd

Add:#7, Link Innovation and Research Center, Kechuang Road,
Nancheng, Dongguan, Guangdong, China

Tel:+86 769-2202 8588 ext:2892 Fax:+86 769-2202 6771

E-mail:overseas@apmtech.cn Web:en.apmtech.cn