



SOLDERING STATION & SOLDERING SPARE PARTS

DESOLDERING STATION

STATIC CONTROL EQUIPMENTS & SPARE PARTS

INDUSTRIAL TOOLS

SOLDERING STATION

Bakon[®]



Enterprise Introduction

Bakon Electronic Technology Co., Ltd was established in 1998, Shenzhen, China. For over twenty years, Bakon has expanded and grown into nationwide top manufacturing for three groups of products: ESD control products in electronic manufacture areas; manual soldering and auto soldering solutions; brush-less electric screwdriver, under our Bakon and SBK brands.



Bakon has become the foremost Chinese domestic brand who committed to bring world class soldering solutions to our clients and aim to expand its international market. It has produced for largest well known brands of China as well as international brands such as GREE ELECTRIC, BYD, and Foxconn, OPPO, Haier, Hisense, HUAWEI, etc..



BK969

High Efficient Constant Temperature Soldering Station

- The heating element is made of imported temperature-resistant materials with advanced technology, and has a long life
- The heating element is powered by a low-voltage DC source to ensure anti-static, no leakage and no interference;
- 200~480°C temperature setting; stable and accurate control;;
- Lightweight handle, no fatigue after long-term use;
- Split design, easy to place



Accessories:



Bk905 handle



BK1321S heating element

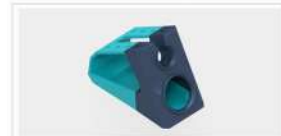

Bk515 soldering iron stand



BK900M series soldering tips

Specifications:

Intelligent lead-free soldering station	BK969
Operating Voltage	AC230V/50HZ
No-load standby power	200~480°C
Max instantaneous power	≤5W
Rated power	70W
Temperature stability (no load)	±2°C
Resistance of soldering iron tip to ground	<2Ω
Voltage from iron tip to ground	< 2mV
Dimension	L135xW107xH83mm
Correction method	Potentiometer calibration
Net/Gross weight	≈1.6Kg/≈1.8Kg

BK969A

High Efficient Constant Temperature Soldering Station

- The heating element is made of imported temperature-resistant materials with advanced technology, and has a long life
- The heating element is powered by a low-voltage DC source to ensure anti-static, no leakage and no interference;
- Use high temperature and anti-static wire
- Lightweight handle, no fatigue after long-term use;
- Split design, easy to place..



Specifications:

Intelligent lead-free soldering station	BK969A
Operating Voltage	AC100-240V, 50/60HZ
No-load standby power	200~480°C
Max instantaneous power	≤5W
Rated power	60W
Temperature stability (no load)	±2°C
Resistance of soldering iron tip to ground	<2Ω
Voltage from iron tip to ground	< 2mV
Dimension	L135xW107xH83mm
Correction method	电位器校正
Net/Gross weight	≈0.8Kg/≈1.0Kg

Accessories:



Bk905 handle



BK1321S heating element

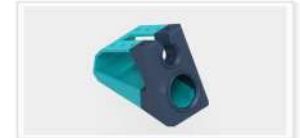

Bk515 soldering iron stand



BK900M series soldering tips

BK969S

High Efficient Digital Display Constant Temperature Soldering Station

- Wide voltage power supply 100-240V
- High-definition large-screen display, compact body;
- New drive circuit design, high heating stability;
- Heating element short circuit protection, sensor abnormal reminder;
- Password protection to avoid illegal modification of settings.



Specifications:

Intelligent lead-free soldering station	BK969S
Operating Voltage	AC100-240V, 50/60HZ
No-load standby power	180°C ~ 480°C
Max instantaneous power	≤5W
Rated power	60W
Temperature stability (no load)	±2°C
Resistance of soldering iron tip to ground	<2Ω
Voltage from iron tip to ground	<2mV
Dimension	L128xW104xH79mm
Net/Gross weight	≈0.8Kg/≈1.0Kg

Accessories:



Bk905 handle



BK1321S heating element

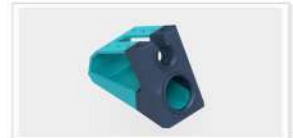

Bk515 soldering iron stand



Bk 900M soldering iron stand

BK969D

High Efficient Digital Display Constant Temperature Soldering Station

- Wide voltage power supply 100-240V
- High-definition large-screen display, compact body
- New drive circuit design, fast heating speed
- Adopt one-piece heating core, sensor abnormal reminder
- The handle adopts patented ergonomic design, and feels comfortable
- Password protection to avoid illegal modification of settings



Specifications:

Intelligent lead-free soldering station	BK969D
Operating Voltage	AC100-240V, 50/60HZ
No-load standby power	180°C ~ 480°C
Max instantaneous power	≤5W
Rated power	65W
Temperature stability (no load)	±2°C
Resistance of soldering iron tip to ground	<2Ω
Voltage from iron tip to ground	< 2mV
Dimension	L128xW104xH79mm
Net/Gross weight	≈0.8Kg/≈1.0Kg

Accessories:



Lf008 handle



T12 heating element

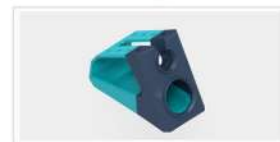

Bk515 soldering iron stand



BK701D Smart hot air rework station

- C1321 pluggable heating element is used, which is convenient for heating element replacement;
- The heating element is made of imported temperature-resistant materials with advanced technology and has a long life;
- Pump type air supply, rapid temperature rise and convenient temperature setting;
- Adjustable air volume and temperature, suitable for dismantling all kinds of QFP, SOP, PLCC or SOJ chips;
- After turning off the heating switch, the automatic cooling system starts to operate to prevent the heating element from overheating;
- With Fahrenheit/Celsius display function;
- After finishing the work, turn off the heating switch and display "--" to enter the standby state.



Available accessories:



SBK907B handle



C1321 heating core



BK506A soldering iron stand



BK 900M heating element



BK853B heating element



Nozzle

Specification:

Hot air rework station	BK701D	
Output Power	700W	
Input voltage	AC230V 50HZ	
Host	working environment	5~45°C
	Display form	LED digital tube
	Size	L160xW141xH95mm
	Airflow type	air pump
Desoldering station	air flow volume	120L/min
	Temperature adjustment range	100°C~500°C
	Temperature stability	±3°C
Soldering station	Temperature adjustment range	100°C~480°C
	Temperature stability	±2°C
	Welding tip to ground voltage/resistance	< 2mV/ < 2ohm



BK861 Smart hot air desoldering station

1. Use high-definition large LCD color screen display.
2. There are three working channels of CH1, CH2 and CH3, and the air volume and temperature of each channel can be set.
3. With password protection function and key lock function.
4. Real-time operation is convenient, with magnetic control switch control, the handle is placed on the handle frame and it will immediately enter sleep.
5. With automatic sleep function, parameters can be set in sleep state.
6. The sensor is closed loop, the microcomputer triggers the temperature control by zero crossing, the power is large, the temperature rises quickly, the temperature adjustment is convenient and accurate and stable, and it is not affected by the air volume.



Specification:

Model:	BK861
Power/temperature range:	1000W / 100°C-500°C
Air volume range / max air volume:	1~120 / 250L / min
Size / weight:	L260xW190xH130±5mm / ≈ 5.1kg
Working environment:	0~40°C / 32~104°F
Screen display:	HD LCD display
Fan type:	Brush-less vortex fan
Temperature calibration method:	Digital calibration
Temperature control method:	Microcomputer temperature control
I/O control port:	Sleep signal/alarm output/temperature OK signal

Available accessories :





BK862 Intelligent dual-control desoldering station

1. Use high-definition large LCD color screen display.
2. There are three working channels of CH1, CH2 and CH3, and the air volume and temperature of each channel can be set.
3. With password protection function and key lock function.
4. Real-time operation is convenient, with magnetic control switch control, the handle is placed on the handle frame and it will immediately enter sleep.
5. With automatic sleep function, parameters can be set in sleep state.
6. The sensor is closed loop, the microcomputer triggers the temperature control by zero crossing, the power is large, the temperature rises quickly, the temperature adjustment is convenient and accurate and stable, and it is not affected by the air volume.



Specification:

Model:	BK862
Power/temperature range:	2000W / 100°C-500°C
Air volume range / max air volume:	1~120 / 250L / min
Size / weight:	L260xW190xH130±5mm / ≈ 5.1kg
Working environment:	0~40°C / 32~104°F
Screen display:	HD LCD display
Fan type:	Brush-less vortex fan
Temperature calibration method:	Digital calibration
Temperature control method:	Microcomputer temperature control
I/O control port:	Sleep signal/alarm output/temperature OK signal

Available accessories :





BK863 Intelligent 2 in1 soldering station

1. Use high-definition large LCD color screen display.
2. There are three working channels of CH1, CH2 and CH3, and the air volume and temperature of each channel can be set.
3. With password protection function and key lock function.
4. Real-time operation is convenient, with magnetic control switch control, the handle is placed on the handle frame and it will immediately enter sleep.
5. With automatic sleep function, parameters can be set in sleep state.
6. The sensor is closed loop, the microcomputer triggers the temperature control by zero crossing, the power is large, the temperature rises quickly, the temperature adjustment is convenient and accurate and stable, and it is not affected by the air volume.



Available accessories :



Specification:

Model:	BK863
Power/temperature range:	2000W / 100°C-500°C
Power of Iron/temperature range:	90W/ 100~480°C
Air volume range / max air volume:	1~120 / 250L / min ≈
Size / weight:	L260xW190xH130±5mm / 5.1kg
Working environment:	0~40°C / 32~104°F
Screen display:	HD LCD display
Fan type:	Brush-less vortex fan
Temperature calibration method:	Digital calibration
Temperature control method:	Microcomputer temperature control
I/O control port:	Sleep signal/alarm output/temperature OK signal

BK60/90 High Frequency Soldering Station

- Large Display.
- Advanced circuit board design, temperature boost control.
- Computer programmed, high temperature stability.
- Burn resistant cord and Quick heating time to the setting point.
- Three preset levels of temperature control.
- Auto sleep and tip sleep function eliminates tip oxidization.
- Short circuit protection via sensor alarm.
- Ergonomic handle.
- Easy to replace ceramic heating element.
- Password lockout prevents unauthorized system setup.



Specifications

Model	BK60/90
Input voltage	AC230V/50HZ
Temp range	200~480°C
Standby power	≤5W
Max power	60W/90W
Temp stability	±2°C
Tip to ground resistance	<2Ω
Tip to ground potential reach	< 2mV
Dimension	L150×W130×H99mm
Calibration	Software programmed

Accessory:



BK906 Hand piece



BK1380 Heating element



BK512-Iron holder



BK600 Tips

BK3300A Eddy-Current Heating Lead-Free Soldering Station

- Eddy current high frequency heating. Rapid heating.
- Upfront sensor placing. Accurate temperature sensor and quick thermal recovery.
- Easy to replace ceramic heating element.
- Aluminum alloy housing, ESD design.
- Built-in cooling fan prevents soldering station from overheating, prolong product's life.
- Auto-Sleep after no actions for 20 minutes. Reduces tip temperature to preserve tip life.
- Auto-Power Off after no actions for 60 minutes and it reduces oxidation when the iron is not in use.
- Password lockout prevents unauthorized system setup.
- Calibration output for temperature adjusting.



Plug-in Heating element

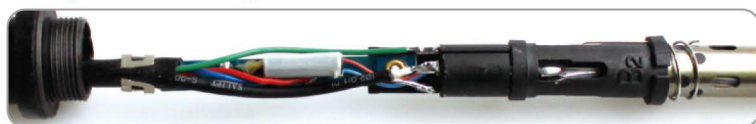

Specifications

Model:	BK3300A
Input Voltage	AC230V/50HZ
Temp Range	50~600°C
Max power	150W
Temp Stability	±2°C
Tip to ground resistance	<2Ω
Tip to ground potential	<2mV
Dimension	(L)215x(W)126×(H)106mm
Temperature lock	Yes
Auto sleep	Yes

Accessory:



LF301 Hand piece



VH300 Heater element+sensor



BK507-G Iron holder



BK500 Tips

BK2000A Eddy-Current Heating Lead-Free Soldering Station

- Eddy current high frequency heating. Rapid heating.
- Upfront sensor placing. Accurate temperature sensor and quick thermal recovery.
- Aluminum alloy housing, ESD design.
- Built-in cooling fan prevents soldering station from overheating, prolong product's life.
- Auto-Sleep after no actions for 20 minutes. Reduces tip temperature to preserve tip life.
- Auto-Power Off after no actions for 60 minutes and it reduces oxidation when the iron is not in use.
- Password lockout prevents unauthorized system setup.
- Calibration output for temperature adjusting.

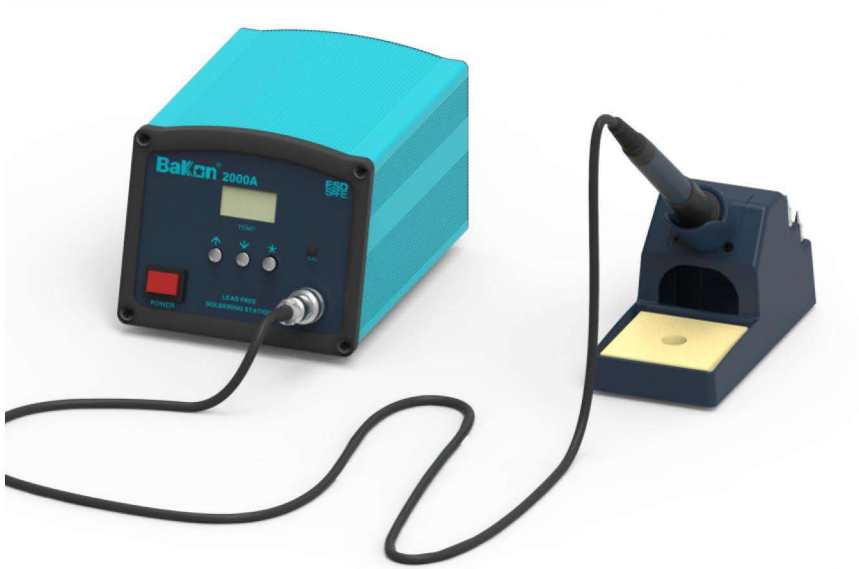

Specifications

Model	BK2000A
Input voltage	AC230V/50HZ
Temp range	50~600°C
Max Power	90W
Temp stability	±2°C
Tip to ground resistance	<2Ω
Tip to ground potential reach	< 2mV
Dimension	(L)165x(W)130×(H)105mm
Temperature lock	Yes
Auto sleep	Yes

Accessory:



LF202 Hand piece



VH90 Heating element



BK507-G Iron holder



BK200 Tips

BK2000 Eddy-Current Heating Lead-Free Soldering Station

- Eddy current high frequency heating. Rapid heating and quick thermal recovery. Suitable for high quality lead free soldering.
- Can be operated in low temperature.
- Computer controlled, screen display.
- Temperature setting by buttons with digital calibration.
- Auto sleep and Auto Power Off (optional).
- Password lockout prevents unauthorized system setup.
- ESD design, multiple tips model available.



Specifications

Model	BK2000
Input Voltage	AC230V/50HZ
Temp Range	200~500°C
Max power	120W
Temp Stability	±2°C
Tip to ground resistance	<2Ω
Tip to ground potential	< 2mV
Dimension	(L)150x(W)130x(H)105mm
Temperature lock	Yes

Accessory:



LF201 Hand piece



VH90 Heater element



BK506A Iron holder



BK200 Tips

BK1000 Eddy-Current Heating Lead-Free Soldering Station

- Eddy current high frequency heating. Rapid heating and quick thermal recovery. Suitable for high quality lead free soldering.
- Can be operated in low temperature.
- Computer controlled, screen display.
- Temperature setting by buttons with digital calibration.
- Auto Power Off (optional).
- Password lockout prevents unauthorized system setup.
- ESD design, multiple tips available.



Specifications

Model	BK1000
Input Voltage	AC230V/50HZ
Temp Range	200~500°C
Max power: 120W	90W
Temp Stability	±2°C
Tip to ground resistance	<2Ω
Tip to ground potential	< 2mV
Dimension	(L)145x(W)125×(H)95mm
Temperature lock	Yes

Accessory:



LF100 Hand piece



VH90 Heating element

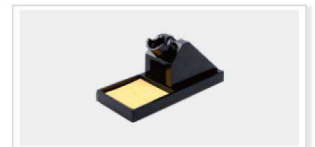

BK506A Iron holder



BK200 Tips

BK3500 Soldering Station with Self Feeder

- Eddy current high frequency heating. Rapid heating and quick thermal recovery. Suitable for high quality lead free soldering. Multiple types of tips available for replacements.
- Micro computer controlled. Screen display.
- Temperature setting by buttons with digital calibration.
- More functions available, such as auto sleep, auto shut off.
- Adjustable auto feeding. Feeding speed and volumes, interval time can be regulated.
- Two types of feeding hose optional: Long hose and short hose. Easy to use.
- Pedal switch or manual switch to choose for feeding. Soldering is convenient, easy to adjust directions.



Specifications

Model	BK3500
Input voltage	AC230V/50HZ
Temp range	200~500°C
Max power	120W
Temp stability	±2°C
Tip to ground resistance	<2Ω
Tip to ground potential	< 2mV
Feeding Speed	≈14mm/s~35mm/s
Feeding Volume(auto mode)	0.5~123mm
Feeding Interval Time	0~3.5s
Gauge	0.4、0.5、0.6、0.8、1.0、1.2、1.6
Feeding Adjustable	Yes

Accessory:



LF302 Hand piece

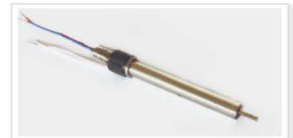

VH90 Heating element



BK502 Iron holder



BK200 Tips

BK936ESD High Frequency Soldering Station

- Light weight handle. No feeling of fatigue over long period of operation.
- Separated design. Compact structure. Easy tip place.
- Multiple types of tips available for replacement: ESD type and non ESD type both available.



Specifications

Model	BK936ESD
Input Voltage	AC220V/50HZ
Temp Range	200~480°C
Standby Power	≤5W
Max power	65W
Temp stability	±2°C
Tip to ground resistance	<2Ω
Tip to ground potential	< 2mV
Dimension	L170×W120×H93mm
Temp Calibration	Calibration of Potentiometer

Accessory:



BK907ESD Hand piece



BK1321 Ceramic heating element



BK506A Iron holder



BK900M Tips

SBK936D⁺ 60W High Frequency Soldering Station

- Three-Digit Display. Temperature decreases or increases by $\pm 1^{\circ}\text{C}$.
- 180-480 Temperature range. The temperature stability is linear with the range of $\pm 3^{\circ}\text{C}$.
- Press button to input the offset.
- Celsius and Fahrenheit options.
- Auto Sleep.
- Separated design. Compact structure. Easy to place. Types of tips available for replacement.



Specifications

Model	SBK936D ⁺
Input Voltage	AC230V/50HZ
Temp range	200~480°C
Standby Power	$\leq 5\text{W}$
Max power	60W
Temp stability	$\pm 2^{\circ}\text{C}$
Tip to ground resistance	$< 2\Omega$
Tip to ground potential	$< 2\text{mV}$
Dimension	L141×W130×H90mm
Temp Calibration	Digital

Accessory:



SBK907D⁺ Hand piece



BK1321 Ceramic heating element

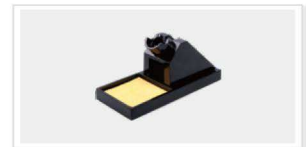

BK506A Iron holder



BK900M Tips

SBK936B 65W Soldering Station

- Temperature adjustment knob, easy to operate.
- Separated design. Compact structure. Easy to place. Types of tips available for replacement.
- Light weight handle. No feeling of fatigue over long period of operation.
- Heating resistance elements prolong handle's lifetime.
- Easy to replace heating element.
- Heating element is easy to unplug and easy to replace.



Plug-in heater design

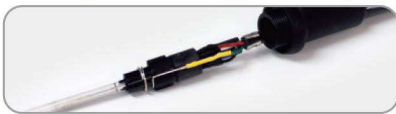

Specifications

Model	SBK936B
Input Voltage	AC230V/50HZ
Temp Range	200~480°C
Standby Power	≤5W
Max power	65W
Temp stability	±2°C
Tip to ground resistance	<2Ω
Tip to ground potential	<2mV
Dimension	L170×W120×H93mm
Temp Calibration	Calibration of Potentiometer

Accessory:



SBK907B Hand piece



C1321 ceramic heating element

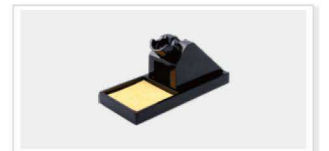

BK506A Iron holder



BK900M Tips

SBK936b 40W Soldering Station

- Temperature adjustment knob. Easy to operate.
- Separated design. Compact structure. Easy to place. Types of tips available for replacement.
- Light weight handle. No feeling of fatigue over long period of operation.
- Temperature range is 200-480. The temperature offset is within 2.



Specifications

Model	SBK936b
Input Voltage	AC230V/50HZ
Temp Range	200~480°C
Standby Power	≤5W
Max power	40W
Temp stability	±2°C
Tip to ground resistance	<2Ω
Tip to ground potential	< 2mV
Dimension	L170×W120×H93mm
Temp Calibration	Calibration of Potentiometer

Accessory:



SBK907b Hand piece



BK1326 Heating element



BK506A Iron holder



BK900M Tips

BK950D Portable Digital Control Temperatures Soldering Station

- Three-Digit Display.
- Separated design. Compact structure. Easy to place tips. Types of tips available for replacement.
- Light weight handle No feeling of fatigue over long period of operation.
- Heating element easy to replace.



T12 Tip: Unplug soldering tip and heating element, replace both same time.



Specifications

Model	BK950D
Input Voltage	AC100~240V
Temp Range	180~450°C
Max power	50W
Temp stability	±2°C
Dimension	L120×W60×H36
Temp Calibration	Digital correction

BK606/BK609 LCD Soldering Iron

- Light weight handle No feeling of fatigue over long period of operation.
- Digital indicator on body of handle. Adjustable temperature. Easy to place and use.
- Precise digital calibration.
- Celsius and Fahrenheit options.

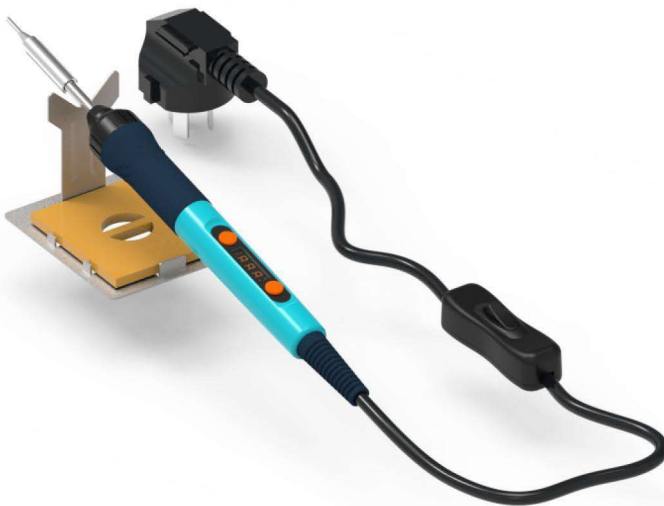

Specifications

Model	BK606/BK609
Input Voltage	AC110V/230V
Temp Range	200~450°C
Max power	60W/90W
Temp stability	±2°C
Dimension	L170×W30×H30
Temp Calibration	Digital correction

BK191 Thermometer

- CA wire sensor precisely tests temperature of tip.
- Easy to read digital temperature display.
- Metal alloy coating resists corrosion and oxidation.
- Sensor replacement is easy.



Specifications

Model	BK191
Resolution	1°C
Range of measurement	0 ~ 600°C
Precision	±3°C
Applied Sensor	K (CA) Thermocouple
Display	3 ¹ / ₂ LCD digital display B □ □ □
Power supply	DC9V Dry battery
Battery life	≥150 hours
Outer dimensions	160(L) X 80(W)X 45(H) mm
Weight	≈ 200g
Environmental temperature range	0 ~ 40°C, 20 ~ 80%RH Relative humidity

Accessory:

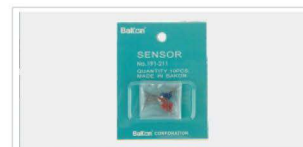

Sensor wire

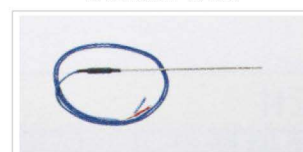

Temperature tester
(for soldering pot)



Temperature tester
(for soldering station)

Operation:



External heat type lead-free soldering iron Tsui

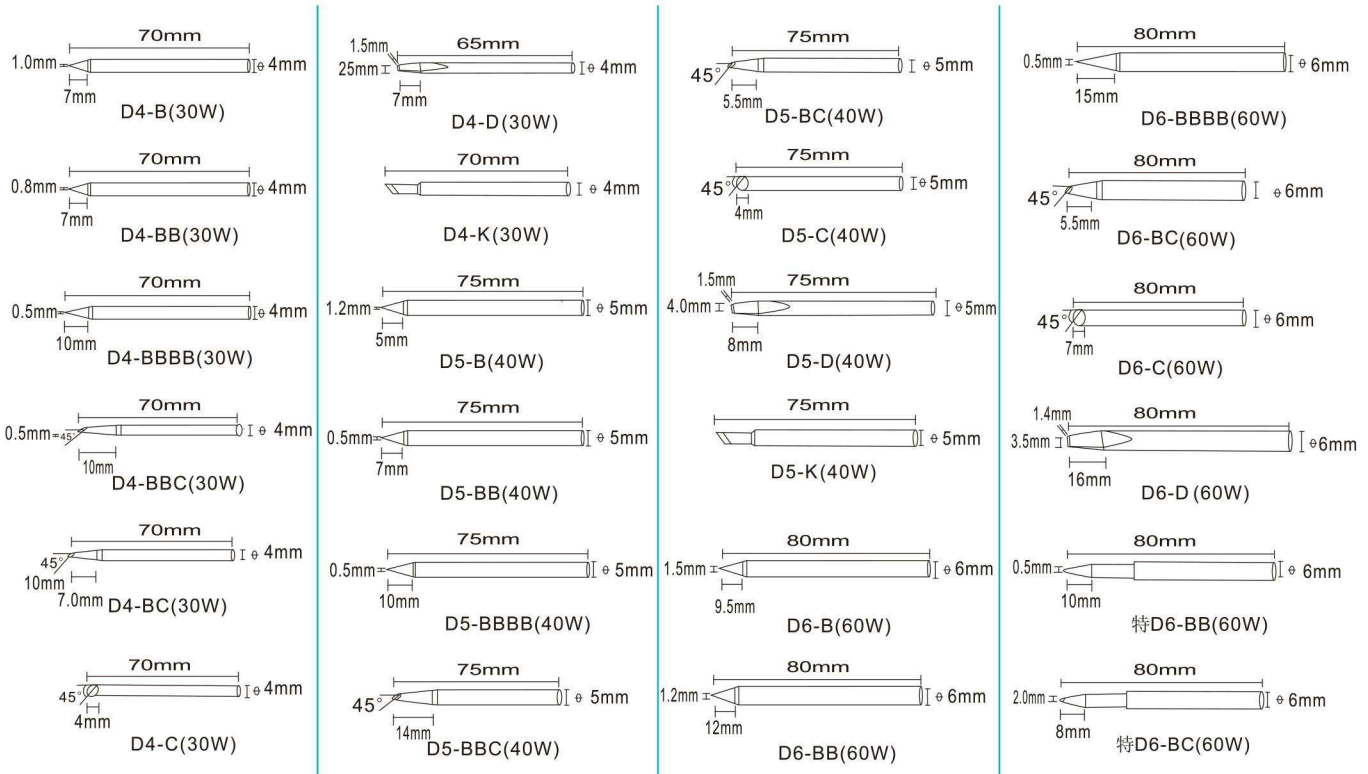

★ Suitable for 30W, 40W, 60W external hot soldering iron

200 series lead-free soldering tips

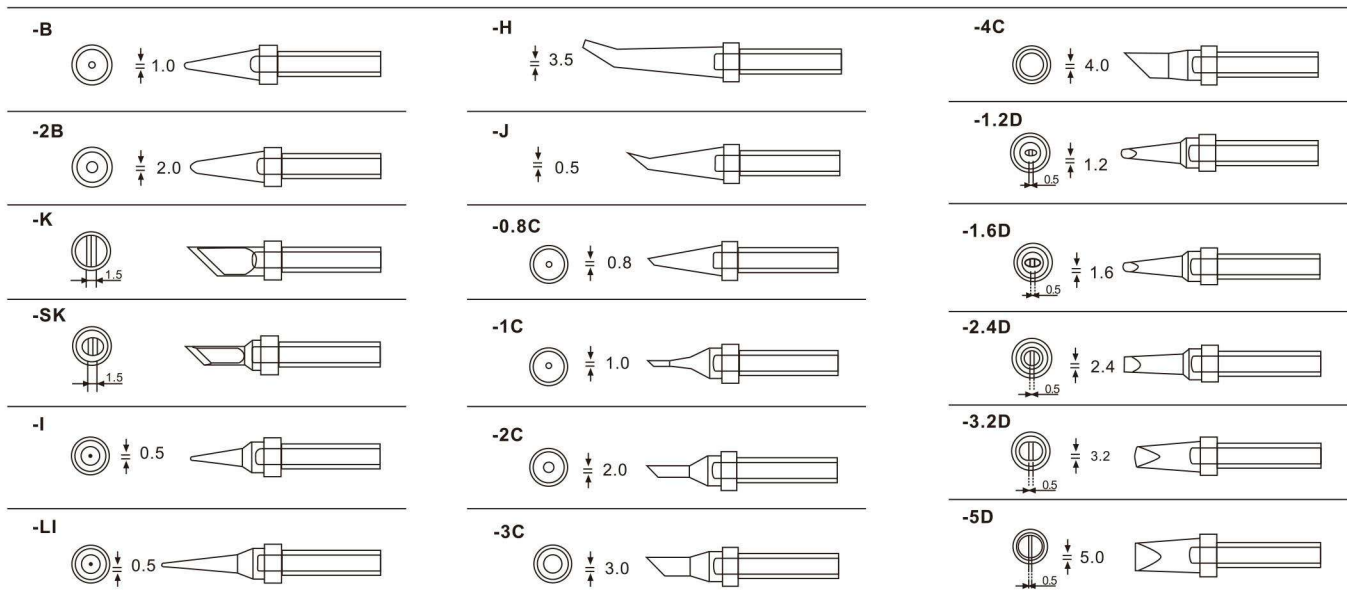

★ 200 series soldering iron head for BK1000, 2000, 2000A, 3200, 3500, 3800 Quick 3202, 3112, 3100, 3101, 3102, 203D, 203, 203H, 204, 204H, 303, etc.

501 series lead-free soldering tips

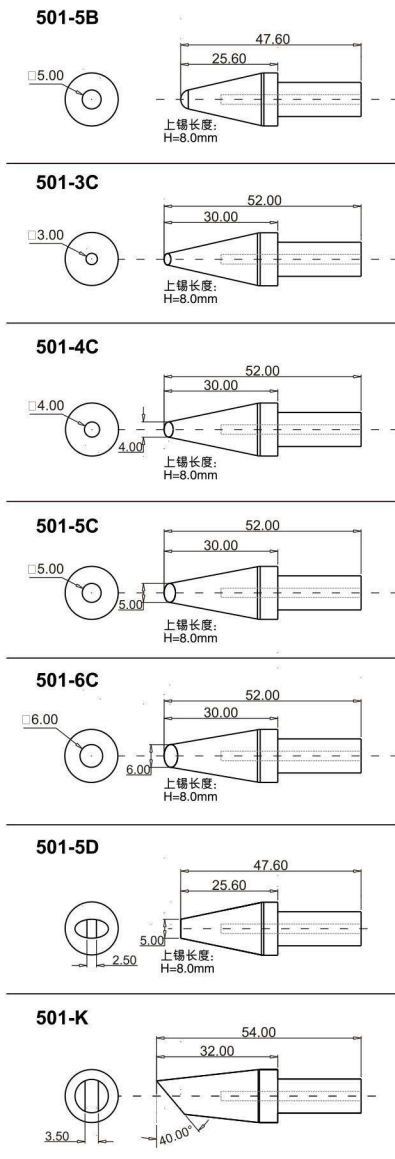

500 series lead-free soldering tips

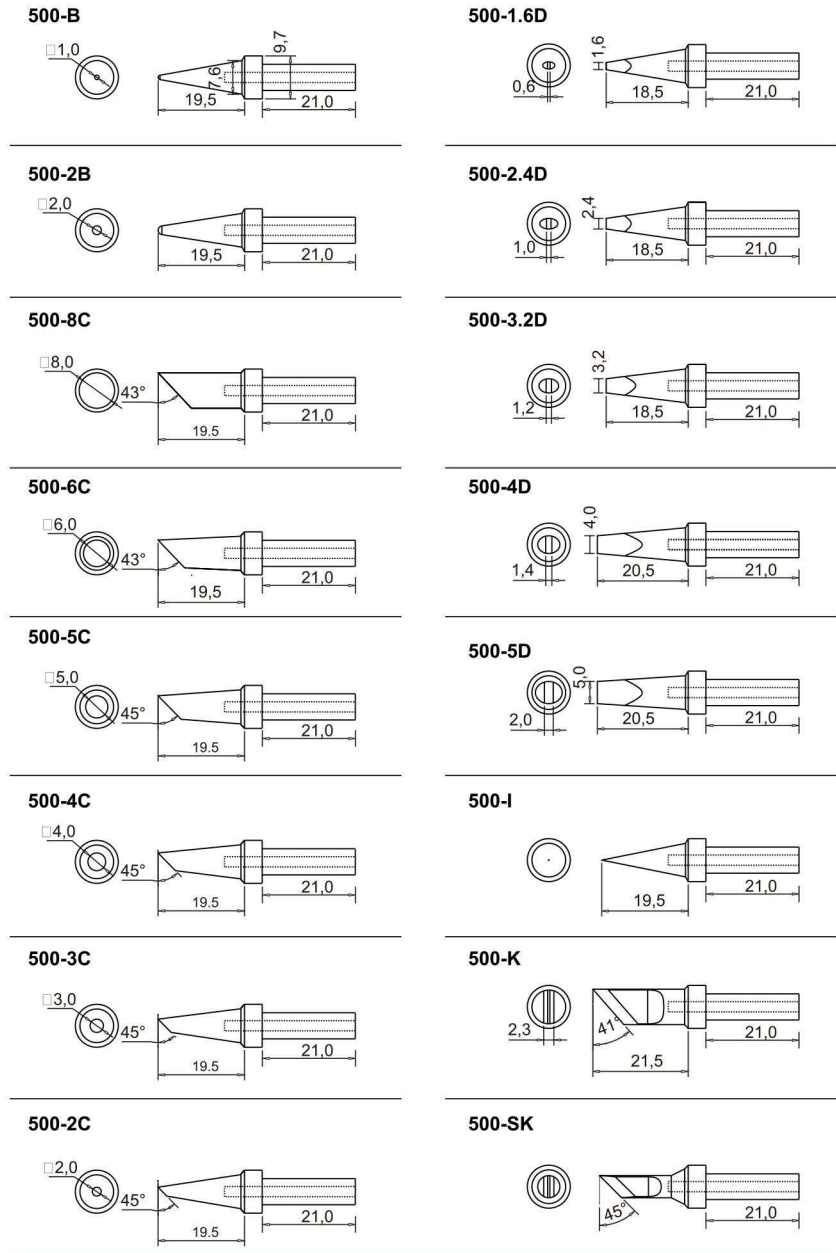

- ★ 501 series soldering tips compatible for BK3300, Quick206B and other lead-free soldering stations
- ★ 500 series soldering tips compatible for BK3300L, BK3300A, BK3600, Quick205 (flash) and other lead-free soldering stations

900M series lead free soldering tips

900M-T-B		900M-T-H	
900M-T-BF2**		900M-T-0.5C	
900M-T-LB		900M-T-0.8C	
900M-T-SB		900M-T-1C	
900M-T-S4		900M-T-1CF*	
900M-T-0.8D		900M-T-1.5CF*	
900M-T-1.2D		900M-T-2C	
900M-T-1.6D		900M-T-2CF*	
900M-T-2.4D		900M-T-3C	
900M-T-3.2D		900M-T-3CF*	
900M-T-S3		900M-T-S10	
900M-T-1.2LD		900M-T-4C	
900M-T-2LD		900M-T-4CF*	
900M-T-1.8H		900M-T-S11	
		900M-T-I	
		900M-T-SI	
		900M-T-K	

★ 900M($\phi 6.5\text{mm}$) series soldering tips compatible for 936 and 937 series soldering stations

T12/T13 series lead free tips. (heating element and tips 2 in 1)



T12/T13-B 	T12/T13-B2 	T12/T13-B3 	T12/T13-B4 	T12/T13-BL 	T12/T13-BC1 T12/T13-BCF1
T12/T13-BC2 T12/T13-BCF2 	T12/T13-BC3 T12/T13-BCF3 	T12/T13-C1 	T12/T13-C4 T12/T13-CF4 	T12/T13-D08 	T12/T13-D12
T12/T13-D16 	T12/T13-D24 	T12/T13-D4 	T12/T13-D52 	T12/T13-DL08 	T12/T13-DL12
T12/T13-DL32 	T12/T13-DL52 	T12/T13-I 	T12/T13-IL 	T12/T13-ILS 	T12/T13-J02
T12/T13-JL02 	T12/T13-JS02 	T12/T13-K 	T12/T13-KF 	T12/T13-KL 	T12/T13-KR
T12/T13-KU 	T12/T13-1201 	T12/T13-1202 	T12/T13-1203 	T12/T13-1204 	T12/T13-1205
T12/T13-1206 	T12/T13-1207 	T12/T13-1208 	T12/T13-1209 	T12/T13-1001 	T12/T13-1002
T12/T13-1003 	T12/T13-1004 	T12/T13-1005 	T12/T13-1006 	T12/T13-1007 	T12/T13-1008
T12/T13-1009 	T12/T13-1010 	T12/T13-1401 	T12/T13-1402 	T12/T13-1403 	T12/T13-1404
T12/T13-1405 	T12/T13-1406 	T12/T13-BZ 	T12/T13-BZZ 	T12/T13-BC1Z T12/T13-BCF1Z 	T12/T13-BC2Z T12/T13-BCF2Z
T12/T13-BCM2 	T12/T13-BC3Z T12/T13-BCF3Z 	T12/T13-BCM3 	T12/T13-4C4Z T12/T13-4CF4Z 	T12/T13-D12Z 	T12/T13-D16Z
T12/T13-D24Z 	T12/T13-D4Z 	T12/T13-KFZ 	T12/T13-KRZ 	T12/T13-WB2 	T12/T13-WB08
T12/T13-WB12 	T12/T13-WB16 	T12/T13-WD52 	T12/T13-WI 		

★ The soldering iron tip is only tinned on the bevel

★ T12 compatible for 942, BK950, FX-951, FX-952 lead-free soldering station

BK881 Hi Efficiency Thermostatic 2 in 1 De-soldering Station & Soldering Station

- Large Easy to Read Digital Display.
- Compact design. Lightweight handle, meet all kinds soldering demands. Extra de-soldering function makes work more efficient.
- 2 in 1 design with de-soldering and soldering work simultaneously. Save work space. Increase production volume and brings efficient manufacturing.
- Large LCD Display, compact, lightweight. LCD Display provides clear interface with the operator to adjust temperature and air level.
- Can be used for a variety of components such as QFP, SOP, PLCC or SOJ chips for de-soldering.
- Upgraded micro-computer control, digital adjustment and display.
- Auto protection for heating materials, which adopts Pulse Heating for better protection to heating elements, handle, and air nozzles which prolongs station life.
- ESD safe components avoid static damage.
- Auto Cooling to prevent heating components from overheating.
- Heats rapidly, stable temperature and high frequency.



Specifications

Model	BK881	
Station	Display	LCD
	Airflow Type	Air bar Output
	Air volume	23L/Min.
	Dimension	(L)150x(W)130x(H)99mm
	Weight	2.5kg
Air Nozzle	Power Consumption	560W
	Hot air temperature	100~500°C
	Length	120cm
Soldering	Weight	184g
	Power Consumption	90W
	Temp range	200~480°C
	Handle length	120cm

Accessory :



BK906 Hand piece



BK1380 Heating element



BK512 Iron holder



BK600 Tips



BK853D Heating element



Nozzles

BK880 High Efficiency Thermostatic Hot Air De-soldering & Soldering Station

- Large LCD Display, compact, lightweight. LCD Display provides clear interface with the operator to adjust temperature and air level.
- Can be used for a variety of components such as QFP, SOP, PLCC or SOJ chips for de-soldering.
- Upgraded micro-computer, to adjust system digitally.
- Auto protection for heating materials, which adopts Pulse Heating for better protection to heating elements, handle, and air nozzles to prolong life.
- Built-in temperature sensor, provides stable temperature output.
- Memory saves for temperature and airflow volume.
- After use, set handle onto holder for auto cooling.



Specifications

Model	BK880	
Station	Power consumption	Standby: 1W
	Airflow Type	Air Bar
	Air Volume	120L/Min.
	Dimension	(L)150x(W)130x(H)99mm
	Weight	2.5kg
Air Nozzle	Power consumption	600W
	Air temperature	100~500°C
	Length	120cm
	Weight	184g

Accessory :



BK853D Heating element



Nozzles

SBK8586 2 in 1 Integrated Soldering & Rework Station

- Large Easy to Read Digital Display. Compact design. Lightweight handle, meet all kinds soldering demands. Extra de-soldering function makes work more efficient.
- 2 in 1 design with de-soldering and soldering work simultaneously. Save work space. Increase production volume and brings efficient manufacturing.
- Large LED Display, compact, lightweight. LED Display provides clear interface with the operator to adjust temperature and air level.
- Can be used for a variety of components such as QFP, SOP, PLCC or SOJ chips for de-soldering.
- Upgraded micro-computer control, digital adjustment and display.
- Auto protection for heating materials, which adopts Pulse Heating for better protection to heating elements, handle, and air nozzles which prolongs station life.
- ESD safe components avoid static damage.
- Auto Cooling to prevent heating components from overheating.



Specifications

Model	SBK8586	
Station	Display	LED
	Airflow Type	Air bar Output
	Air volume	120L/Min.
	Dimension	(L)160x(W)95x(H)141mm
	Weight	2.5kg
Air Nozzle	Power Consumption	700W
	Hot air temperature	100~500°C
	Length	120cm
	Weight	184g
Soldering	Power Consumption	60W
	Temp range	200~480°C
	Handle length	120cm

Accessory:



SBK907E Soldering iron



BK1327 Heater Core



BK506A Iron holder



BK900M Iron tips



BK853 Fever body



Nozzles

BK870A Intelligent Warm Air Rework station

- Heating cord temp indicates in real-time, adjusts temperature and airflow volume.
- Memory saves for temperature and airflow volume
- Cooling mode after power off, shutting off after 100°C.
- Auto protection for heating materials, which adopts Pulse Heating for better protection to heating elements, handle, and air nozzles which prolongs life of unit.
- Built-in upgraded micro-computer. Digital adjustment and display.
- Heating sensor, stable output temperature
- Temperature and airflow volume controlled by handle and station both. Suitable for all kinds chips de-soldering.

Air Volume, Air temp adjustable. (handpiece)



Specifications

Model		BK870A
Station	Power consumption	Standby: 2W
	Airflow Type	Pulse heating and plumbing
	Air Volume	23L/Min.
	Dimension	(L)250x(W)190x(H)145mm
	Weight	3.4kg
Air Nozzle	Power consumption	560W
	Air temperature	100~480°C
	Length	120cm
	Weight	120g

Accessory:



BK853 Heating element



Nozzles

SBK858D Intelligent Warm Air Rework station

- Compact design, save space.
- Can adjust temperature and air level and used for a variety of components such as QFP, SOP, PLCC or SOJ chips for de-soldering.
- Upgraded micro-computer, to adjust system digitally.
- Auto protection for heating materials, which adopts Pulse Heating for better protection to heating elements, handle, and air nozzles to prolong life.
- Built-in temperature sensor, provides stable temperature output.
- Memory saves for temperature and airflow volume.
- After use, set handle onto holder for auto cooling.



Specifications

Model	SBK858D
Power consumption	550W±10%
Airflow Type	Brushless Fan Soft Wind
Air volume	120L/Min
Temp range	100~500°C /212~932°F
Display	LED digital tube (R.P. 1°C /°F)
Temperature compensation	±50°C/± 120F
Handle length	≤120cm
Dimension	L15xW10xH13.8cm
Weight	1.55kg
Noise	<45dB
Workplace	-20~40°C
Storage environment	-20~80°C
Storage humidity	35%~45%

Accessory:



BK853S Heating element



Nozzles

Nozzle series

Unit : mm

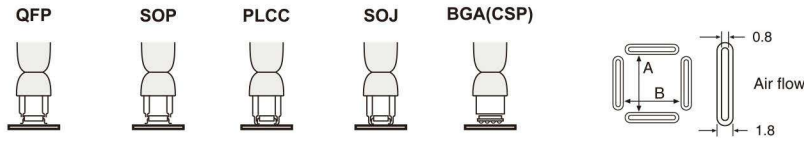

★ The size indicated by the name/specification is the IC size.

	QFP	SOP	PLCC	SOJ	BGA(CSP)		
The following nozzles can be used with the vacuum suction function	A1125B QFP 10 x 10 A:10.2 B:10.2	A1126B QFP 14 x 14 A:15.2 B:15.2	A1127B QFP 17.5 x 17.5 A:19.2 B:19.2	A1128B QFP 14 x 20 A:15.2 B:21.2	A1129B QFP 28 x 28 A:29.7 B:29.7	A1135B PLCC 17.5 x 17.5 (44 Pins) A:18.5 B:18.5	A1136B PLCC 20 x 20 (52 Pins) A:21 B:21
	A1137B PLCC 25 x 25 (68 Pins) A:26 B:26	A1138B PLCC 30 x 30 (84 Pins) A:31 B:31	A1139B PLCC 12.5 x 7.1 (18 Pins) A:6.9 B:14	A1140B PLCC 11.5 x 11.5 (28 Pins) A:13 B:13	A1141B PLCC 11.5 x 14 (32 Pins) A:15 B:13	A1180B BQFP 17 x 17 A:18.2 B:18.2	A1181B BQFP 19 x 19 A:19.2 B:19.2
	A1182B BQFP 24 x 24 A:24.2 B:24.2	A1184B SOJ 18 x 8 A:10 B:10	A1185B TSOL 13 x 10 A:11.9 B:11.9	A1186B TSOL 18 x 10 A:18.2 B:18.2	A1187B TSOL 18.5 x 8 A:18.5 B:18.5	A1257B SOP 11 x 21 A:11.7 B:11.7	A1258B SOP 7.6 x 12.7 A:8.2 B:8.2
	A1259B SOP 13 x 28 A:13.5 B:13.5	A1260B SOP 8.6 x 18 A:8.7 B:8.7	A1261B QFP 20 x 20 A:20.2 B:20.2	A1262B QFP 12 x 12 A:12.2 B:12.2	A1263B QFP 28 x 40 A:27.7 B:39.7	A1264B QFP 40 x 40 A:40.2 B:40.2	A1265B QFP 32 x 32 A:32.2 B:32.2
	A1188B PLCC 9 x 9 (20 Pins) A:11 B:11	A1189B PLCC 34 x 34 (100 Pins) A:36.5 B:36.5	A1203B QFP 35 x 35 A:35.2 B:35.2	A1214B SOJ 10 x 26 A:12 B:26	A1215B QFP 42.5 x 42.5 A:42.5 B:42.5	A1470 BGA 8 x 8 A:9 B:9	A1471 BGA 12 x 12 A:13 B:13
	A1472 BGA 13 x 13 A:14 B:14	A1473 BGA 15 x 15 A:16 B:16	A1474 BGA 18 x 18 A:19 B:19	A1475 BGA 27 x 27 A:28 B:28	A1476 BGA 35 x 35 A:36 B:36	A1477 BGA 38 x 38 A:39 B:39	A1478 BGA 40 x 40 A:41 B:41
	A1124B* Single ϕ 2.5 ϕ 2.5 (I.D)	A1130* Single ϕ 4.4 ϕ 4.4 (I.D)	A1131* SOP 4.4 x 10 A:4.8 B:10	A1132* SOP 5.6 x 13 A:5.7 B:13	A1133* SOP 7.5 x 15 A:7.2 B:15	A1134* SOP 7.5 x 18 A:7.2 B:18	A1142B* Bent Single 1.5 x 3 A:1.5 (I.D) B:3 (I.D) 45°
	A1183* SOJ 15 x 8 A:8 B:8	A1190* Dual Single 2.5 x 9.5 A:2.5 (I.D) B:9.5	A1191* SIP 25L A:26 B:26	A1192* SIP 50L A:52.5 B:52.5	A1325* Dual Single ϕ 1.5 x 5-10 Adjustable Pitch A:5 B:10 Nozzle distance You can adjust ϕ 1.5 (I.D) The pitch between the two nozzles is adjustable		

Vacuum suction function is not available for the following nozzles

BK8016/BK8020 Electronic Hot Gun

- Used for operations which requires strict de-soldering working temperature standards, and adjusts its temperature.
- Such as mobile phone repair(250-280), BGA components de-soldering, plastics intenerating. Paint and paint removal (DE-painting is not for concrete paint, magnetic paint or mine paint).
- Package shrink and plastic pipe bending.
- To shrink Polyethylene used for medal adhesion. To remove sticker and other adhesive decoration.
- Release rusty and tight screw nut, screw.
- Intenerating before grease cleaning and hard powder replacement.



BK8020

BK8016

Application:

Tin melting, unfreeze, paint removal, tube heating, lab vessel cleaning, liquid heat energy transfer, etc. Various nozzles and accessories available. Max power consumption can reach 2000W, max temp 600, high frequency and easy to operate. Temp adjustable.

Specifications

Model	BK8020	BK8016
Power consumption	2000W	1600W
Temp at nozzle outlet approx	50~630°C	60~600°C
Airflow volume	250L~500L/min	200L~450L/min
Dimension	245(L)x185(W)x70(H)mm	245(L)x185(W)x70(H)mm
Weight	≈550g	≈520g
Insulation level	☐ / II	☐ / II

BK493 Smoke Absorber

- Absorbs and removes contaminated air quickly and directly at the source.
- Adjust airflow direction by changing the nozzle angle. Easy to remove and replace. Low noise operation and long lifetime.
- Filters contain variety of chemical activator synthesis and It provides powerful suction.
- ESD and non ESD choices.
- The extractor can be placed by clipping to the working station desk. Saves workspace and provides convenient operation.



Specifications

Model	BK493
Input voltage	AC220V 50Hz / AC110V 60Hz
Power consumption	30W
Airflow capacity	1.0m ³ /min
Dimensions	(W)101*(H)182*(L)167mm
Weight	1.5KG
Accessories	Activate carbon filter 3 pcs / kit

BK725A Auto Screw Feeder

- Auto digital screw feeder updated with digital counting function and working more stable.
- Digital display.
- Screw numbers from 0 to 999, auto alarm warning and power off when fully feed or running out of screw.
- Counting can be automatic or manual.
- Adjustable rail track.
- Compatible with 1-5mm diameter screws.



No stuck screws

Screws will first start to roll in the feeder bin and guided to the right track. Any out of rail track screws would roll back to the feeder bin to rotate again. Easy adjustment of vibration and speed. Screw stays firmly at the fixed pickup point.

Malfunction Alarm

Vibration and screw delivery controlled separately. Free to adjust delay length and time. When malfunction happens during operation, alarm will be heard.

Specifications

Model	BK725A
Suitable Screw	L=20MM
Output Speed	2capsules / sec
Diameter of the screw head	1.0~5.0mm
Input Voltage	DC12V
Weight	≈1.5kg
Accessories	DC12V
Dimension	180(L)*125(W)*150(H)mm

BK715 Auto Screw Feeder

- This auto digital screw feeder updated with digital counting function and working more stable than traditional ones and 1.4 times working faster per screw, which enable up to 6 times faster production work.
 - Operator works with digital display and it's easy to operate.
 - Screw numbers from 0 to 999, auto alarm warning and power off when fully feed or lack of screw.
 - No need to align screws but pour group of screws into the harbor bin.
 - Compact design.
 - Counting can be automatic or manually.
 - Rail adjustable.
- Compatible with 1-5mm diameter screws



No stuck screws

Screws will first start to roll in the feeder bin and guided to the right track. Any out of rail track screws would roll back to the feeder bin to rotate again. Easy adjustment of vibration and speed. Screw stays firmly at the fixed pickup point.

Malfunction Alarm

Vibration and screw delivery controlled separately. Free to adjust delay length and time. When malfunction happens during operation, alarm will be heard.

Specifications

Model	BK715
Suitable Screw	L=20MM
Output Speed	2capsules / sec
Diameter of the screw head	1.0~5.0mm
Input Voltage	DC12V
Weight	≈1.5kg
Accessories	DC12V
Dimension	180(L)*125(W)*150(H)mm

BK218 Automatic Spring Separator

- Automatically sorts springs and deliver untangled spring to assembly points. To bring optimum performance by increasing high volume production and reducing assembly costs of labor.
- Compact, Lightweight, Portable, Safe to use, fast sorting, and help springs stay in their original shapes.
- Compatible with AC 50 HZ, 220V.
- Compatible with XXX diameter of wire of spring, XXX diameter of springX, and XXX spring lengths.
- Cylindrical or conical helix spring.



Specifications

Model	BK218
Compatible spring	Helix
Voltage	AC220V
Diameter of spring	2~12mm
Length of spring	2~20mm
Diameter of wire of spring	0.45~1.5mm

M1000/ M1000S Automatic Tape Dispenser

•The dispenses tapes automatically on the carousel in specific length fast and precisely.it accepts most tapes and is perfect for packing, cell manufacturing and assembly work.

M1000



M1000S



Specifications

Model	M1000/M1000S
Voltage	AC220V 50Hz/AC110V 60Hz
Power Consumption	18W
Tape width	7-50mm
Cutting Length	20-999mm±1mm/5-999mm
Roll Dia.	N/A
Weight	2.85KG
Size	137 (W)×218(D)×150(H)

Z-CUT2 Tape Dispenser

- Adjustable cutting length.
- Superior performance in cutting narrow and soft tape.
- Easy to set up and take out tape.
- Compatible with tapes with inner diameter of: 75, 32, 25.
- Available for both 220V and 110V models.



Suitable for

All gaps between the cutting of tapes are adjustable.
Used for all kinds of tapes and core holders.

Specifications

Model	Z-CUT 2
VOLTAGE	AC220V 50Hz/AC110V 60Hz
Power Consumption	14W
Tape width	3-22mm
Cutting Length	11-58±1mm
Roll Dia.	25/32/75mm
Weight	2.85Kg
Size	310(L)*170(W)*165(H)mm

Z-CUT10 Tape Dispenser

- Cuts tape and places it on carousel by pressing button.
- It increases the production volume and brings efficient manufacturing.
- Providing consistent clean lengths tape cutting.
- Compatible with all sizes of tapes and accepting filament, polyimide, acetate cloth, glass cloth, double-sided tape, plastic, aluminum foil, cellophane, masking, normex, copper, cloth, polyethylene, PTFE, paper, craft, OPP, Kapton etc.
- Adjustable length of the tape and gap of the tape by handle operation.
- Easy to replace blades.
- Motion sensor cutting. Infrared cutting



Specifications

Model	Z-CUT 10
Voltage	AC220V 50Hz/AC110V 60Hz
Electromechanical material	ABS
Tape width	3-25mm
Cutting Length	8-70mm
Roll Dia.	150mm max
Weight	1.9Kg
Size	256(L)*150(W)*256(H)mm

BK782/BK780

Label automatic peeling machine

- The equipment adopts imported stepping motor and control components, with firm structure and reliable performance, and can cope with continuous working environment.
- The electronic control system is easy to operate, fully automatic stripping, flat labeling, and no wrinkles.
- After the label is taken out, the second sheet is automatically sent out, and the small label can be juxtaposed in several rows and peeled off once.
- One machine can be used by many people, and the interval or continuous whole roll type and barcode can be applied.
- Label peeling position can be adjusted freely.
- This machine has 0~999999 automatic counting function, which is convenient for calculating output..
- The sensor can slide left and right to freely select the direction when peeling off multi-mode labels.
- Delay gear can be adjusted from 1~10, voltage 110V, 220V optional.
- The peeling speed is steplessly adjusted, and it is more suitable for the application of various types of labels. Electronic manufacturing industry, chemical industry, food processing industry, logistics and distribution industry.

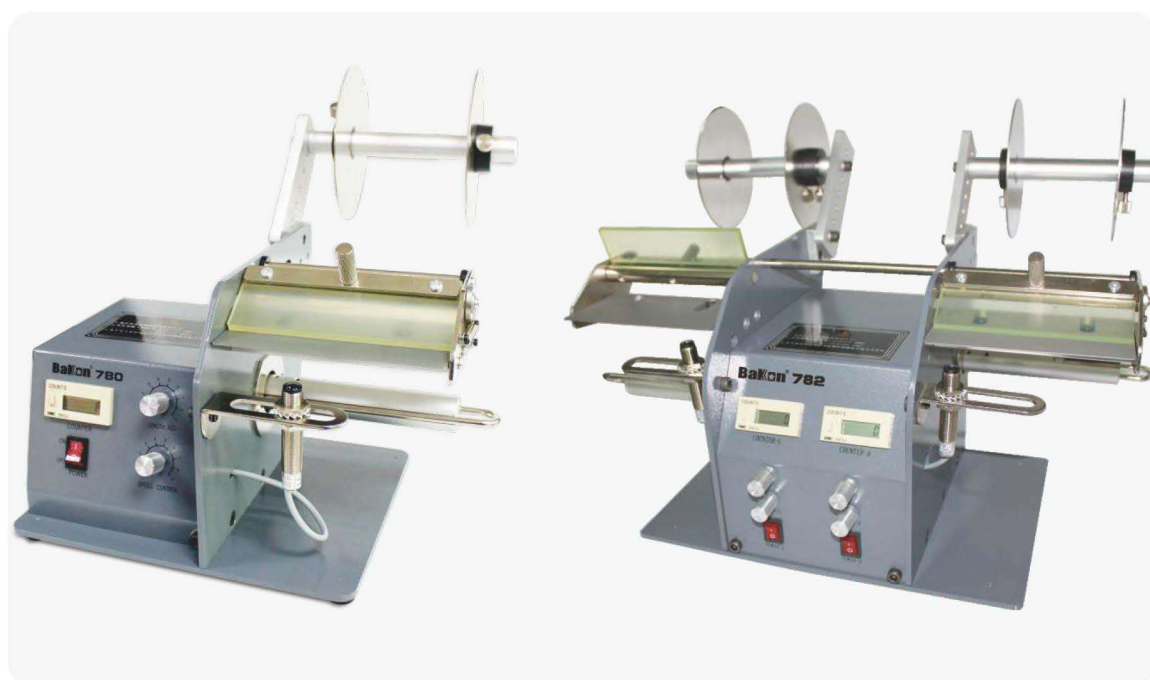

Specifications

Model	BK782/BK780
Label length	4~200mm
Label width	4~120mm(Customizable)
Label peeling speed	0~255mm/Min
Paper roll outer diameter	Max 200mm
Paper roll inner diameter	Min 20mm(Customizable)
Power supply	220V/50HZ(110V/60HZ Customizable)
Power	≈6W
Weight	10.0/6.2kg
Dimensions	270(L)x365(W)x270(H) / 260(L)x290(W)x260(H)mm

Customer examples

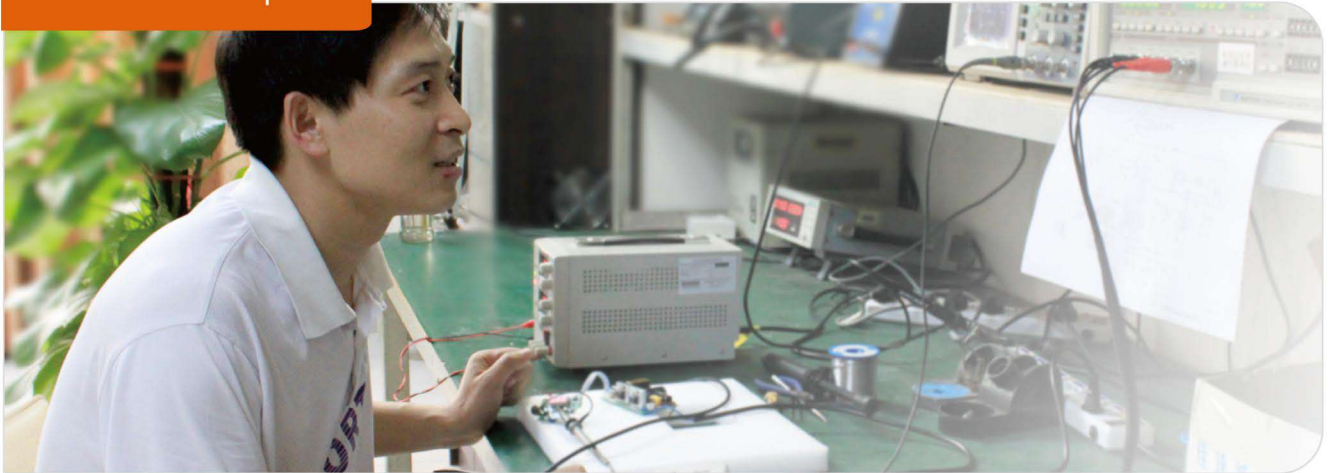

Technology , innovation , win the future

Contact us

SHENZHEN BAKON ELECTRONIC TECHNOLOGY CO., LTD.

Free service hotline: **440-0988-936**

Office: Room 713, Jiayu Building (Near Songgang Railway station) ,
Songgang Town, Bao'an, Shenzhen, China, 518105

Factory: 5th Floor, 1st Building, Fubulun Industrial Zone, Chaoyang Road,
Songgang Street, Bao'an District, Shenzhen, China 518105