

User Manual

8500B Series

Programmable DC Electronic Loads



Contents

1	General Information	5
1.1	Product Overview	5
1.2	Package Contents	5
1.3	Product Dimensions	6
1.4	Rackmount Installation	6
1.5	Front Panel Overview	6
1.5.1	Combination Keys	6
1.6	Rear Panel Overview	8
1.7	Display Overview	8
2	Getting Started	10
2.1	Input Power	10
2.2	Fuse Requirements	10
2.2.1	Fuse Replacement	10
2.3	Input Connections	11
2.4	Preliminary Check	11
2.4.1	Verify AC Input Voltage	11
2.4.2	Self-test Errors	11
2.4.3	Input Check	12
2.4.4	Check Model and Firmware Version	12
3	Front Panel Operation	13
3.1	Local Mode/Remote Mode	13
3.2	Constant Current (CC) Mode	13
3.2.1	Configure CC Parameters	13
3.3	Slew Rate Measurement and Actual Transition time	14
3.4	Constant Voltage (CV) Mode	14
3.4.1	Configure CV Parameters	14
3.5	Constant Power (CW) Mode	14
3.5.1	Configure CW Parameters	14
3.6	Constant Resistance (CR) Mode	15
3.6.1	Configure CR Parameters	15
4	Advanced Functions	16
4.1	Short Operation	16
4.2	Transient Operation	16
4.2.1	CC Mode	16
4.2.2	CV, CW, and CR modes	17
4.3	List Operation	17
4.3.1	Configure List	18
4.3.2	Run List	18
4.3.3	Disable List Mode	19
4.4	Battery Test Function	19
4.4.1	Test Configuration	19
4.4.2	Enable Battery Test Mode	19
4.4.3	Recall Battery File	20
4.4.4	Start Battery Test	20
4.5	Test Operations	20
4.5.1	Automatic Test Function	20
4.5.2	Setting Up Program Files	20
4.5.3	Configuring Pass/Fail Parameters	20

4.5.4	Configuring Instrument Settings	20
4.6	PROGRAM	22
4.6.1	Complete–Stop Failure–Stop	22
4.6.2	Recall and Run Program	23
4.7	Ripple Function	23
5	Configuration Functions	24
5.1	VON Function	24
6	System Settings	27
6.1	Run Recall Edit	27
6.2	Key Lock	27
6.1	Restore Factory Default Settings	28
6.1.1	Configure Power-On State	28
6.1.2	Load On Knob	28
6.1.3	Configure Trigger Source	29
6.1.4	Save/Recall Instrument Settings	29
6.1.5	Select Storage Group	30
6.1.6	Save Settings	30
6.1.7	Recall Settings	30
6.1.8	Display Input On Timer	31
6.1.9	Remote Interface Setup	31
6.1.10	RS-232	31
6.1.11	CONFIG Menu	32
6.1.11.1	Von Operation	32
6.1.12	Configure Protection Settings	32
6.1.13	PROTECT MENU	32
6.1.14	Max-P A-Limit P-Limit Time	32
6.1.15	Overcurrent Protection (OCP)	32
6.1.16	Overpower Protection (OPP)	34
6.1.17	Recall OPP File	35
6.1.18	Overvoltage Protection (OVP)	35
6.1.19	Overtemperature Protection (OTP)	36
6.1.20	Reverse Voltage Protection (LRV/RRV)	36
6.1.21	Configure Timed Input	36
6.1.22	Measurement Configurations	36
6.1.23	CR LED Function	37
6.1.24	Remote Sensing	38
6.1.25	External Triggering	38
6.1.26	Current Monitoring (I Monitor)	39
7	Protection Functions	40
7.1	OCP Test Function	40
7.2	OPP Test Function	41
7.3	OPP TEST	42
8	Remote Operation	43
8.1	Interface Connection	43
8.2	Serial Interface	43
8.2.1	GPIB	43
8.2.2	USBTMC	43
8.2.3	Remote Commands	43

9	Troubleshooting Guide	44
9.1	General	44
9.2	Remote Control	44
9.3	Error Information References	44
9.4	Exception handling	44
10	Service Information	46
11	LIMITED THREE-YEAR WARRANTY	47

General Information

1.1 Product Overview

The 8500B Series DC Electronic Loads are versatile instruments used for static and dynamic testing of DC power supplies, batteries, DC-to-DC converters, battery chargers, and other applications including fuel-cell, and solar cell test. Primary modes include constant voltage (CV), constant current (CC), constant resistance (CR), and constant power (CW). A wide range of dynamic loading applications can also be simulated through user-programmable slew rates, load levels, duration, and conducting voltage. Further, transient, list mode, battery mode, and LED modes further extend testing capabilities. Versatile triggering options allow the dynamic load behavior to be synchronized with other events. The DC load is remotely programmable via the TTL serial interface. This interface requires 0-5V signal levels and can connect to typical serial ports via an adapter such as the IT-E132B.

Features:

- CC/CV/CR/CW operating modes
- List mode
- Transient mode
- Measurement speed up to 40 kHz
- Remote sense function
- Battery test function
- OCP and OPP automatic test
- CR-LED function
- Store/recall up to 100 setups
- Analog current monitoring
- Adjustable slew rate in CC mode
- OVP/OCP/OPP/OTP and reverse voltage protection

1.2 Package Contents

Please inspect the instrument mechanically and electrically upon receiving it. Unpack all items from the shipping carton, and check for any obvious signs of physical damage that may have occurred during transportation. Report any damage to the shipping agent immediately. Save the original packing carton for possible future reshipment. Every instrument is shipped with the following contents:

- 8500B series DC Electronic load
- IT-E132B USB to TTL adapter
- AC Power Cord
- Certificate of Calibration
- Test Report

Verify that all items above are included. If anything is missing, please contact B&K Precision.

1.3 Product Dimensions

All models are designed to fit in a standard 19-inch rackmount. The dimensions are shown in **Figure 1.1**.

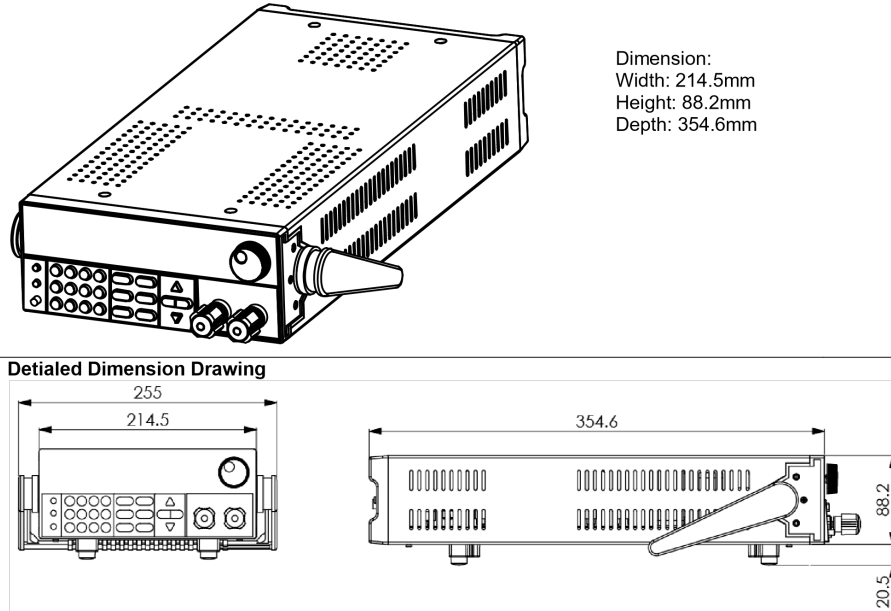

Figure 1.1 External Dimensions - Half-rack models

1.4 Rackmount Installation

The instrument can be installed in a standard 19 inch rack. For half-rack models, the optional rackmount kit IT-E151 is required. **Figure 1.2** shows one of the half-rack sized units using the IT-E151 rackmount kit. This rackmount kit also accomodates up to two half-rack models installed side by side.

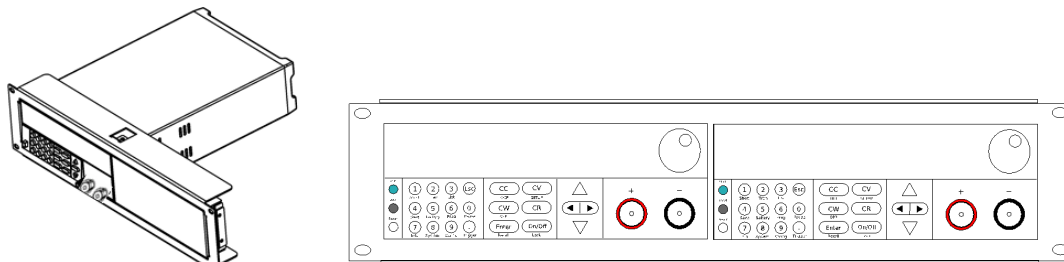

Figure 1.2 Half-Rack sized Unit

1.5 Front Panel Overview

See **Figure 1.3**.

1.5.1 Combination Keys

Press **Shift** button first and then other keys to activate the more advanced functions.

Shift + **Short** 1 Turn short circuit on or off.



Item	Description
1	VFD Display
2	Power Switch and Function Keys
3	Numeric Input and Advanced Functions
4	Mode keys and Input Control
5	Navigation Keys
6	Input Terminals
7	Rotary Input Knob

Figure 1.3 Front Panel

- Shift + (2) Start or stop transient condition.
- Shift + (3) Set LIST operation parameters.
- Shift + (4) Store the DC Load state in non-volatile memory.
- Shift + (5) Turn on or off battery testing function.
- Shift + (6) Enter auto test function.
- Shift + (7) Display product's Model/SN/Version.
- Shift + (8) System menu setting
- Shift + (9) Configure menu setting
- Shift + (0) Press this button if you need a pause when running an auto test file.
- Shift + (.) Cause an immediate trigger.
- Shift + Enter OCP test function.
- Shift + Set detailed parameters in CC/CV/CW/CRmode.
- Shift + Enter OPP test function.
- Shift + Recall the DC Load state from non-volatile memory.
- Shift + Key lock function

1.6 Rear Panel Overview



Item	Description
1	Power Input and Fuse Holder
2	AC Voltage Switch
3	Current Monitor Output
4	Remote Sense and Trigger Input
5	TTL (5V) Communication DE-9 Connector

1.7 Display Overview



Item	Description
1	Measured Voltage
2	Measured Current
3	Measured Power
4	Set Value
5	Input Off indicator, lit when input is off
6	Operation mode indicators (CC, CV, CW, CR)
12	Remote control active indicator
13	Error indicator
14	Waiting for Trigger indicator
15	Timer indicator
16	External indicator
16	Remote Sense active indicator
17	Protection event indicator
18	Auto range
19	Key Lock indicator
20	Shift indicator

Getting Started

Before connecting and powering up the instrument, please review and go through the instructions in this chapter.

2.1 Input Power

The load has a selectable AC input that accepts line voltage input within:

Voltage	Frequency
115 V (+/-10%) or 230 V (+/- 10%)	47 Hz – 63 Hz

Table 2.1 Input Power Requirements

Use the line voltage selector switch in the back to switch between 110 V and 220 V operation.



Disconnect all cables including the power cord from the instrument when changing the instrument's line voltage. After changing the line voltage setting, ensure the instrument has fuses of the proper ratings and types for the selected line voltage before applying line power.

2.2 Fuse Requirements

An AC input fuse is necessary when powering the instrument. Below is a table of the fuse required for all models operating with either 110 VAC or 220 VAC input. See Table ???. The fuses are **5mm x 20mm High Energy Slow Blow** type (ceramic casing with sand fill).

Model	Fuse Specification (110 VAC)	Fuse Specification (220 VAC)
8542B	1.25 A, 250 V	500 mA, 250 V
8500B	1.25 A, 250 V	500 mA, 250 V
8502B	1.25 A, 250 V	500 mA, 250 V
8510B	3.15 A, 250 V	1.6 A, 250 V

Table 2.2 Fuse Ratings

2.2.1 Fuse Replacement

Follow the steps below to replace to check the fuse:

1. Locate the fuse box next to the AC input connector in the rear panel, see **Figure 2.1**.
2. With a small flat blade screwdriver, insert into the fuse box slit to pull and slide out the fuse box as indicated below.
3. Check and replace fuse (if necessary) for the desired line voltage operation.

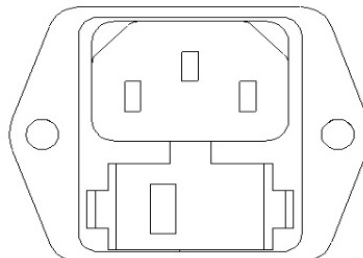

Figure 2.1 Fuse Holder

2.3 Input Connections

The main DC input terminal is a screw type binding post terminal located in the front panel, holes are included for inserting wires, and the binding post also includes “banana jack” connections. Each connection allows for different current levels. The “banana” input is capable of up to 10 A of current. Any more current is not recommended and could lead to excessive connector heating, melting and worse.

Note: The screws on the terminals can be completely removed to allow for ring type adapters. The screw posts are 7mm in diameter.

Due to the high current rating of the DC load, proper wire sizes are necessary for safe connectivity and to prevent wires from overheating.



Before connecting wires to the input terminals, turn OFF the load to avoid damage to the instrument and the device under test (DUT).



High Current Connection



Low (<10 A) Current Connection

Figure 2.2 Input Connections

2.4 Preliminary Check

Complete the steps in this section to verify that the load is ready for use.

2.4.1 Verify AC Input Voltage

Verify and check to make sure proper AC voltages are available to power the instrument. The AC voltage range must meet the acceptable specification as explained in Section ??.

Connect AC power cord to the AC receptacle in the rear panel and press the power switch to the ON position to turn ON the instrument. It will run through a self test procedure with the screen shown below:

2.4.2 Self-test Errors

Connect AC power cord to the AC receptacle in the rear panel and press the power switch to the ON position to turn ON the instrument. Various elements of the system are checked during the power-on self test routine. If any occur, they



are reported during the power-up procedure. See [Section 9](#) for troubleshooting and error information details. During self-test, the display displays “System Init”, and dots are displayed showing the test progress level.

2.4.3 Input Check

Follow the steps below to check that the load is operating correctly, and that the load elements (power transistors) are not damaged. A DC power supply rated for at least 5V and 1 A is required for this check.

1. Connect the input terminal to a DC power supply and configure the supply to output 5 V and current limit to 1 A.
2. Power on the load. The display will show the “OFF” annunciator above the voltage display.
3. Turn on the DC power supply’s output. Observe the load’s measured voltage display, it should read approximately 5 V.
4. Press the “CC” button to enable the constant current load mode.
5. Use the keypad to enter 0.5 A. Press the Enter key to set the value.
6. The display should show **CC = 0.500A** on the bottom right.
7. Press “On/Off” to enable the load. The “On/Off” button should light up, and the “Off” indicator on screen should disappear. The measured current should now display a value close to 0.5 A.
8. This setup verifies that the load is drawing power correctly from the power supply.



If the load does not show 5 V, or shows significant current draw from the connected power supply, the load may be damaged and need service. If when the supply is connected, showing 5 V on the load’s display, and no current is drawn, the load may be damaged and need service.

Note: If the load is not drawing power from the DC power supply, check all load protection limits and settings within the menu to verify that the load is configured to allow drawing power at 5V, 0.500 A. Also, verify that the CC mode parameters are setup to operate within the configured valid ranges by pressing  + 

If after checking all of the above, and verifying the power supply used for testing is not at fault, contact B&K for further assistance.

2.4.4 Check Model and Firmware Version

The model and firmware version can be verified by using the *IDN? query remote command. It can also be found from the front panel:

1. Press  and 
2. The display will show the following:

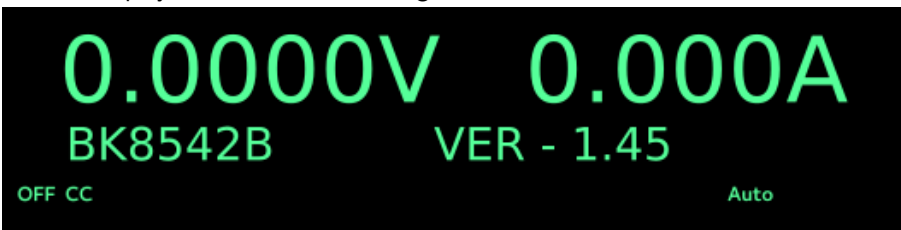

3. This shows the model to be a BK8542B with Firmware: 1.45
4. Press (esc) to return to the normal display.

Front Panel Operation

The electronic load provides the following modes:

- Constant current (CC) operation mode
- Constant voltage (CV) operation mode
- Constant resistance (CR) operation mode
- Constant power (CW) operation mode

3.1 Local Mode/Remote Mode

The 8500B series can either be operated locally or remotely. When in “Remote” mode, the **RMT** indicator will be lit. When in this mode, the front panel of the load is disabled and all commands are issued via the serial interface. In order to exit “Remote” mode and work in “Local” mode, press the “Local” button. This is the small grey button on the left hand side of the numeric keypad.

3.2 Constant Current (CC) Mode

In this mode, the load will draw the specified current as long as the source is capable of delivering it. The load uses transistors in parallel to implement the load circuit, and as such there are some limits. For example, the load has a finite minimum resistance determined by the R_{dsOn} of the transistors. Next, given the resistance limits, there is a limit to the amount of current that may be drawn for a given voltage. The datasheet shows curves for this limit in the section called “Low Voltage Operation”. Please refer to the datasheet for details for each model.

3.2.1 Configure CC Parameters

There are several parameters that should be setup prior to operating in CC mode. First, enable the “CC” mode of operation by pressing the CC mode key. Next, enter the setup menu by pressing “Shift” and then the “CV” key. Above the “CV” key, “Setup” is written. The following are the available menu items, scroll through them with the up/down arrow keys or by entering a value and pressing enter.

- Range** This defines the maximum allowed current set value. Use this limit to protect against accidentally entering excessive current values either from the keypad or dial.
- High** This is the voltage high limit for the automatic test mode, it does not apply otherwise. During automatic test mode, the device under test (DUT) must be operating below the configured value for the test to PASS upon completion. If the DUT operates above the configured value, the test will FAIL upon completion.
- Low** This parameter refers to the voltage low limit for the automatic test mode. During automatic test mode, the DUT must be operating above the configured value for the test to PASS upon completion. If the DUT operates below the configured value, the test will FAIL upon completion.

Rise Up/ Fall Down These parameters define the current slew rate of the load as it changes to a new programmed value. The programmed slew rate takes effect immediately when set, so if the transient or triggered modes are active, it will apply immediately.

3.3 Slew Rate Measurement and Actual Transition time

Current slew rate is defined as the change in current over time. A programmable slew rate allows a controlled transition from one load setting to another. The actual transition time is defined as the time for the input to change from 10% to 90%, or 90% to 10% of the programmed current values. The graph below illustrates slew rate measurements.

Between the 10% and 90% region, the slew rate can be measured by observing the steepest slope portion. In case of very large load changes, e.g. from no load to full load, the actual transition time will be larger than the expected (measured) time. For this reason, the firmware allows the user to program slew rate values outside of the specified slew rate ranges. The minimum transition time for all programmable slew rates is also limited in cases where the transition from one setting to another is very small, due to bandwidth limitations of the load.

3.4 Constant Voltage (CV) Mode

In this mode, the electronic load will attempt to sink enough current to control the source voltage to the programmed value.

3.4.1 Configure CV Parameters

There are several parameters that should be set up prior to operating in CV mode. Press **Enter** so that it lights up, then press **Enter** and to access Setup for CV mode. The setup menu will be shown:

- Range** This value will also act as a limit to how much voltage the load can be configured.
- High** This is the current upper limit for the automatic test mode. The system must be operating below the configured value for the test to PASS upon completion. If the DUT operates above this value, the test will FAIL.
- Low** This is the current lower limit for the automatic test mode. The system must be operating below the configured value for the test to PASS upon completion. If the DUT operates below this value, the test will FAIL.

3.5 Constant Power (CW) Mode

In this mode, the electronic load will consume a constant power. When input voltage increases, the input current will decrease, while power ($P = V \cdot I$) will remain the same. This is a sampled system, so the performance is not as fast as in CC and CV modes.

3.5.1 Configure CW Parameters

There are several parameters that should be set up prior to operating in CW mode. Press **Enter** so that it lights up, then press **Enter** and to access "Setup" for CW mode. The setup menu will be shown: The setup parameters are: Range, High (Voltage limit), and Low (Voltage limit). Use the **Enter** keys to select each parameter, and use the numeric keypad to change the value. Press **Enter** to confirm the change.

- Range** This value will also act as a limit the allowed power setting value.
- High** This parameter sets the upper voltage limit for the automatic test mode. If the voltage exceeds this upper limit during the test, the test will fail.
- Low** This parameter sets the lower voltage limit for the automatic test mode. If the voltage exceeds this lower limit during the test, the test will fail.

3.6 Constant Resistance (CR) Mode

In this mode, the electronic load approximates a resistor. The current draw is varied by the load according to the input voltage. The performance of this mode is not as fast as in CC or CV mode. This is because it is a sampled system and response to changing input takes a finite amount of time.

3.6.1 Configure CR Parameters



There are several parameters that should be set up prior to operating in CR mode. Press so that it lights up, then press)and to access Setup for CR mode. The setup menu will be shown: The setup parameters are: Range, High (Voltage limit), and Low (Voltage limit). Use the (arrow keys) key to select each parameter, and use the numeric keypad to change the value. Press (enter) to confirm the change.

- Range** This value will also act as a limit the allowed resistance setting value.
- High** This parameter sets the upper voltage limit for the automatic test mode. If the voltage exceeds this upper limit during the test, the test will fail.
- High** This parameter sets the lower voltage limit for the automatic test mode. If the voltage exceeds this lower limit during the test, the test will fail.

Advanced Functions

In addition to the 4 general modes of operation, there are a number of other more application specific functions. These functions enable more advanced testing.

4.1 Short Operation

The electronic load can simulate a short circuit at its input. During front panel operation, press  +  to switch the short on/off state. Short operation will not affect the present setting. When turning off the short state, the load returns to the original set state. The actual value of the electronic load in short operation depends on the mode and range that is active when the short is turned on. In CC or CR mode, the maximum short current is typically 110% of the current range. In CV mode, short means setting the load's constant voltage to be 0 V. In short operation mode, you can measure the maximum short current (A_{max}) or DC current (ADC) of the power source to be measured. You can set this function via the Configuration menu.

4.2 Transient Operation



Transient mode periodically switches between two load levels. There are three different transient modes:

- Continuous** Generates a respective pulse stream that toggles between two load levels.
- Pulse** Generates a load change that returns to its original state after some time period.
- Toggle** Generates a repetitive pulse stream that toggles between two load levels. It is similar to continuous mode except that the transient points are controlled by explicit triggers instead of an internal transient generator.

Depending on the selected **Trigger Source** from within the "SYSTEM" menu, the operation may start immediately. To run the transient operation, first press to enable the input. Then, send a trigger to start the operation. If **Trigger Source** is set to "Manual", press and then (or press) to send a trigger. Refer to "Configure Trigger Source" in section "SYSTEM Menu" to configure the **Trigger Source**.

Note: The number next to "TRAN" on display will count each transition. It can only count up to 65535 transitions, after which it will reset to 0 and start over.

To disable transient operation, first press to disable the input. Then, press and (or press). Select "Off" and press to confirm.

1. First, select the load's mode of operation, which will determine which type of transient operation will be configured. Press or to select between CC, CV, CW, or CR mode. Verify the selection by the backlight behind its corresponding button, which will be lit when selected.
2. Enable transient mode from the "Tran" menu. This is accessed via " + ".
3. Select the transient mode "Continuous", "Pulse", or "Toggle". Press .

4.2.1 CC Mode

In Constant Current mode, the configurable parameters are the following:

- Mode** Continuous, pulse, or toggle

Up The rising edge current slew rate in A/us.

Down The falling edge slew rate in A/us.

Level A, Level B The 2 current levels applied.

In Continuous mode, the following are also set:

Freq The transient cycle frequency.

Duty The duty cycle or percentage of time the load will be at either level (A/B). The percentage defines the ratio of the B level to the cycle. So for 75% and 1 Hz, the B level will be on for 750 ms and the A level 250 ms.

In Pulse Mode, the following is also set:

Width The transient frequency

4.2.2 CV, CW, and CR modes

In Constant Voltage, Power and Resistance modes, the configurable parameters are the following:

Mode Continuous, pulse, or toggle

Level A, Level B The 2 levels.

In Continuous mode, the following are also set:

Freq The transient cycle frequency.

Duty The duty cycle or percentage of time the load will be at either level (A/B). The percentage defines the ratio of the B level to the cycle. So for 75% and 1 Hz, the B level will be on for 750 ms and the A level 250 ms.

In Pulse Mode, the following is also set:

Width The transient frequency

4.3 List Operation

List mode lets you generate complex sequences of input changes with rapid, precise timing. The parameters of List operation include the name, number of steps (2-84), step width time (20us-3600s), and every steps' set value and slew rate. The list file is saved in non-volatile memory. There are 7 groups of List files. List mode is available in CC mode only.

In List operation mode, the load starts the List operation when it receives the trigger signal, and will continue until the List is completed, or the instrument receives another trigger signal.

List Sequence

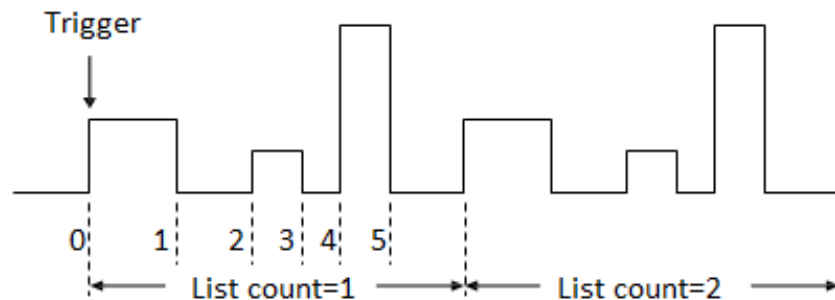







Figure 4.1 List Mode Current Waveform







4.3.1 Configure List

Lists are run exclusively from internal memory only. As in other menus, an active field is denoted by an underline cursor or flashing. To enter a list into memory, complete the following:

1. Press  + .
2. Set the first field in the menu to "OFF". If the field is set to "ON", press  to change the value to "OFF".
3. Move the selected field via the  buttons to the "EDIT" (shown as EDI) field and press  to start editing a List. If nothing happens, ensure the first field is set to "OFF".
4. Set the current range.
5. Set the number of steps in the list. This is a value between 2 and 84.
6. Set the first step's current, slew rate, and step time.
7. The next step in the list will prompt automatically. Enter the values for each step in the same way.
8. When each step is entered, the system prompts for the number of times to run the sequence. A 1 in this field means the sequence will run only once.
9. Enter the list file location to store the newly created list.

The list is now saved and may be recalled.

4.3.2 Run List

1. Select the list to run:
 1. From the "List" menu, select "CALL" and press .
The load prompts for the list to recall (1 through 7).
 2. Enter the list number and press  to recall it.
2. Enable List mode by selecting the "Off" menu item and press .
The "OFF" changes to "ON" and the "Trig" indicator lights.
3. Use the  button to go back to the normal display. The load is now ready and waiting for a trigger.
4. Press  to enable the input, and send a trigger to start the list program.
If Trigger Source is set to Manual, press  +  to send a trigger. See Section ?? for details about triggers.

Note: The number next to LIST on the display shows the current running step number. When the list ends, it will change back to "0".

Note: At the end of a list operation, the load's input remains on the settings of the last step value.

4.3.3 Disable List Mode

1. Disable the input via the **On/Off** or remote command.
2. Press **Shift** + **List** (3)
3. Select the “ON” item and press **Enter** to change the value to confirm. The “Trig” indicator will disappear.

4.4 Battery Test Function

The 8500B series products include battery test capabilities. This function provides a constant current load. The test records the time, and charge consumed in Amp-hours. Three independent conditions are available to customize the test. These are voltage, charge (Ah), and time.

Stop conditions are not optional. If one of the conditions is not required for a test, then the value should be set so that it will not trigger. For example, if the capacity is unimportant to the test, set the value to maximum (999.999 Ah).

The run the battery test function a configuration is loaded into memory, the battery test mode is then enabled, and finally the mode is started by a trigger signal.



4.4.1 Test Configuration

To configure a battery test, the “RUNMODE” must be set to “NORMAL”. See Section ?? for details.



1. Press **Shift** + **Batt** (5)
2. The battery test parameters menu will open.
3. Set the parameters of the test:
 - Range** The maximum current allowed. Set to a value equal to or higher than the desired discharge current.
 - Current** The discharge current for the test.
 - Stop Voltage** The lower limit voltage for the battery.
 - Stop Cap (Capacity)** The maximum capacity to discharge. For example, 50% discharge of a 10 Ah battery, this would be 5 Ah.
 - Stop Timer** The maximum test time.
4. When the settings are entered, the last step is to set the memory location. Set the value (1 - 10) and press **Enter** to complete the configuration entry.

4.4.2 Enable Battery Test Mode

1. Press **Shift** + **Sys** (8) to enter the system menu.
2. Use the **◀▶** keys to navigate to the ‘RUNMODE’ setting.
3. Press **Enter** to enter the setting menu.

- Use the  to scroll through the different settings and select “BATTERY”.
- After setting the mode, exit the menu using the .
Battery test mode is now enabled.

4.4.3 Recall Battery File

Press  +  to select program file, the panel displays “RECALL BATTERY 1”. Enter the file name (1-10) and press  button.

4.4.4 Start Battery Test

With the battery mode enabled, the load will work in a limited CC mode. If the battery test conditions are met, the input may be enabled, and the battery mode test current will be drawn. If the limits are not met, the input will automatically turn off.

To start a battery test, send a trigger to the load. In manual trigger mode, press the . The battery test will automatically terminate when the stop conditions are met.

4.5 Test Operations

4.5.1 Automatic Test Function

The automatic test function of the load is useful for simulating various tests and allows the user to edit up to 10 program files. Each file has 10 steps and up to 100 steps are edited and saved into the EEPROM. Convenient for production environments, automatic test can cascade sequences across multiple channels and allows setting of Pass/Fail (P/F) criteria.

4.5.2 Setting Up Program Files

4.5.3 Configuring Pass/Fail Parameters

The Pass/Fail criteria is found in the SETUP menu of the front panel, under the high/low parameters. Users must set pass/fail criteria for each mode (Configure CC Parameters, Configure CV Parameters, Configure CR Parameters, and/or Configure CW Parameters) used in the Automatic Test sequence, prior to running the automated test. Please see the Configure CC Parameters, Configure CV Parameters, Configure CR Parameters, and/or Configure CW Parameters configuration sections to set these parameters.

4.5.4 Configuring Instrument Settings

The automatic test runs a program that uses the settings stored into the internal EEPROM memory. Each program can run 10 sequences, and each of these sequences is correlated to instrument settings that are stored within a designated group of internal EEPROM memory. They are designated according to the table below:

Example:

- In Program 1, sequence 1 correlates to instrument settings stored in memory location 1.
- In Program 5, sequence 5 correlates to instrument settings stored in memory location 45.
- In Program 8, sequence 10 correlates to instrument settings stored in memory location 80.

PROGRAM 1 Sequence	1	2	3	4	5	6	7	8	9	10
Save Group	1	2	3	4	5	6	7	8	9	10
PROGRAM 2 Sequence	1	2	3	4	5	6	7	8	9	10
Save Group	11	12	13	14	15	16	17	18	19	20
PROGRAM 3	1	2	3	4	5	6	7	8	9	10
Save Group	21	22	23	24	25	26	27	28	29	30
PROGRAM 4 Sequence	1	2	3	4	5	6	7	8	9	10
Save Group	31	32	33	34	35	36	37	38	39	40
PROGRAM 5 Sequence	1	2	3	4	5	6	7	8	9	10
Save Group	41	42	43	44	45	46	47	48	49	50
PROGRAM 6 Sequence	1	2	3	4	5	6	7	8	9	10
Save Group	51	52	53	54	55	56	57	58	59	60
PROGRAM 7 Sequence	1	2	3	4	5	6	7	8	9	10
Save Group	61	62	63	64	65	66	67	68	69	70
PROGRAM 8 Sequence	1	2	3	4	5	6	7	8	9	10
Save Group	71	72	73	74	75	76	77	78	79	80
PROGRAM 9 Sequence	1	2	3	4	5	6	7	8	9	10
Save Group	81	82	83	84	85	86	87	88	89	90
PROGRAM 10 Sequence	1	2	3	4	5	6	7	8	9	10
Save Group	91	92	93	94	95	96	97	98	99	100

Settings	Store to Memory location
Mode of Operation	Setting Value
CC	1 A
CV	3 V
CW	0.5 W
CR	2 Ohms
CC	3.8 A
CC	0.5 A
CV	2.8 V

Within each program, sequences are activated or deactivated (skipped), but they run in order from 1 through 10. Therefore, when setting and storing instrument settings into the memory, keep in mind the order of which you want them to be recalled and run in the automatic test program.

For example, suppose you want to run a test program that simulates the load profile below:

Configure and save settings into memory according to the table below:

Refer to section "Save/Recall Instrument Settings" in section "SYSTEM Menu" for details on saving settings into internal memory.

Note: If the program requires more than 10 sequences, each program is linked (chained) to another program after it has completed.

) to access the "PROGRAM" menu. It will look like the display below:

2. Select "Edit" and press **Enter**. The first parameter to configure is the "Active Sequence".

This allows activating or deactivating a sequence in the program. Sequences that are activated will be part of the test program. Deactivated sequences will be skipped. To activate a sequence, press the number corresponding to the sequence using the numeric keypad. For example, if sequence 1 through 5 are to be activated, press. The activated sequence numbers on the display will change to "Y", indicating that they are active and will be run as part of the test program. In this example, the display will look like below:

To deactivate, press the corresponding number with the numeric keypad again. The sequence number on the display will change back from “Y” to the actual sequence number.

3. Press to continue. The next parameter to configure will be the **Pause Sequence**. This allows the test program to pause after running any selected sequence. For example, if the test program should pause before running sequence 2 and 4, use the

numeric keypad and press and () so that number “1” and “3” in the **Pause Sequence** on the display will indicate “Y”. When the program finishes running sequence 1, it will pause until user presses a button to continue the test. Then when the program finishes running sequence 3, it will pause again until user presses a button to continue the test. The display will look like below for this configuration:

Note: A () symbol will replace the sequence numbers that are deactivated from the previous steps.

Press **Enter** to continue. The next parameter to configure will be the Short Sequence.

This allows the test program to run a short circuit test of the selected sequence. Use the numeric keypad to select which sequence number to activate short circuit test, and its number will change to “Y”.

5. Press **Enter** to continue. The display will show the following:

SEQ01 will be shown if sequence 1 is activated. Otherwise, it will display SEQXX where XX is the first sequence number in the program that is activated (starts from 1-9 and then 0).

The load is prompting to enter the On Time for the sequence number in seconds. This is the length of time in which to run the sequence with input enabled (ON). Valid range is

0.0 s – 60.0 s. Use the numeric keypad or rotary knob to enter a value. Then press **Enter**

1. Now, the load will prompt to enter **Off Time**. This is the length of time in which to run the sequence with input disabled (OFF). Valid range is 0.0 s – 60.0 s. Use the numeric keypad or rotary knob to enter a value. Then **Enter** press .

2. The load will then prompt to enter **P/F Delay Time**. This is delay time is illustrated by the graph below:

0 Tpf (Ton+ T off)
Tpf = P/F Delay Time
Ton = On Time
Toff = Off Time

Use the numeric keypad or rotary knob to enter a value. Then press **Enter** .

If there are more than one active sequence, the load will repeat the prompts to configure the **On Time, Off Time, and P/F Delay Time**. Follow steps 7 – 9 for each sequence. Once all sequences’ parameters are configured, the display will show:

4.6 PROGRAM

4.6.1 Complete–Stop Failure–Stop

Select **Complete-Stop** or **Failure-Stop**, then press **Enter** .

Complete-Stop: Stop test when program is complete. **Failure-Stop:** Stop test when testing fails.

The load will prompt to enter a value for **Chain Program File**. This specifies the next program to run immediately after the end of the test. Select between 0 – 10. Select “0” if no other programs will be run at the end of the test. Otherwise, select the program number to run after the test is completed. Use the numeric keypad or rotary knob to enter a value and then press **Enter** to confirm. Lastly, the load will prompt to select a number to **Save Program File**. This is the program number that will be referred to when recalling all the configured settings from previous steps or chaining with another program. Select between 1 – 10 with the

numeric keypad or rotary knob. Then press **Enter** to confirm and save all settings to the selected program number. The display will not return to the “PROGRAM” menu.

4.6.2 Recall and Run Program

The following is a procedure to recall and run a saved test program.

Recall a Program

Press **)** to enter the “Program” menu.

Select “Recall” and press **.** The display will be shown as below:

Use the numeric keypad or rotary to select the program number to recall from memory.

Enter a number between 1 and 10. Then press **.**

The display go back to the “Program” menu. To view the recalled settings, select “Edit” and press **.**

Note: If you recall a program from an empty location, it will give you an error message, and all settings viewed under the Edit option will be reset to default values.

Run a Program

1. Press **)** and then **)** to enter the “Program” menu.
2. Make sure the program you want to run has already been recalled from the previous instructions. Select “Run” and press **.**
3. The display will show the following:

“PRG01” from this display indicates which program has been loaded to run. Depending on which program is recalled, it will show **PRG01-PRG10**.

“STOP” indicates the program is not running.

4. Now, press **(.-trig)**  once to start running the program. The display will change to:

-01 next to “PRG01” indicates the current running sequence number within the selected program number.

“on” indicates the input state is enabled for the selected sequence. If **On Time** is not set to 0.0S for the sequence, it will show “on”. This indicator can also show “off” to indicate the input state is disabled. If “short” is selected for the sequence, it will display “short”.

“pass” indicates at the current sequence has passed the test. If a failure occurs, it will indicate “fail”.

If pause is activated for a selected sequence while running the program, the display will show:

At this point, the program is in a pause state. To continue the test, press  once.

Note: At any time while the program is in the running state, if you wish to re-test a sequence or test a previous sequence, press the **(up)** key. Each press will go back up one sequence and run the test again starting from that sequence. You can also skip to the next sequence in the test by pressing .

To pause the program at any time while it is in the running state, press  and the **(#pause)** (or press **(pause)**). A Pause indicator will appear on the bottom right of the display. To resume, repeat the same step.

When the program is in a pause state, the input state is overridden by pressing .

At the end of the test, the display will show:

If there is a failure, “fail” will be indicated in place of “pass”. At this point, you can press  to view which sequences were tested and passed/failed. It will be indicated like the following:

“Y” indicates the tested sequence(s) that passed/failed. If a sequence has been skipped in the test, its sequence number will be indicated instead of a “Y”.

7. To stop a running program at any time, press  once. To completely exit

the automatic test function, press  a few times until the load returns back to the normal display.

4.7 Ripple Function

The 8500B series DC electronic loads have test ripple function. You can read ripple voltage and ripple current by sending instructions. See the programming manual for more information.

Configuration Functions

5.1 VON Function

The DC load can be set to only turn on if the voltage is above a set value(VON set) under configure menu by pressing [**Shift**]+ [**9**]. There are two types of VON function: "Living" and "Latch". The following will have detailed description for the two types.

NOTE

VON set is used to ensure an electronic system under test will not have power applied unless the supply voltage is above a certain value. If you have no such testing request, do not set this value arbitrarily. If your instrument can not work normally, for example, set CC=1A, after turn on the input while the current is still 0A instead of setting value 1A, then you should check VON set firstly. If VON set is not 0V, then please modify to 0V.

VON LIVING MODE

In Living mode, when power is applied to the DC load, the voltage must rise above VON setting before the load draws current from the source. If the voltage below VON setting on the load's terminals, the load will turn off input.

VON LATCH MODE

In Latch mode, as before, the load will turn on only when the voltage exceed VON setting, but once on, it will now stay on, even if the voltage drops to zero.

Menu Operation:::

How to Navigate the Menu

Before using the instrument, it is important to be familiarized with its menu structure and learn how to view or change settings and parameters. Follow the steps below to guide you in selecting menu options.

1. Follow the instructions above to access the System or Config menu.
2. The selected item will be blinking. Use and) keys to move through the menu selections.
3. When the desired menu section is blinking, press to access its menu settings.
4. Below is the display when SYSTEM is selected.

SYSTEM MENU

Initialize Power-On

5. The selected item will be blinking. Use) keys to move through the menu items. When there is a on the right side of the display, that means there are more menu items available to select from. Similarly, a will appear on the left side of the display when there are menu items to the left
6. There may be parameters or options to select within each menu item. Follow the same instructions as described in the previous steps to select them. Some settings can be changed by using) arrow keys. To save changes to a setting, press .
7. To exit the menu at any time, press .

3.1 Menu Options (check this with the unit)

Most settings and parameters can be configured from the built-in menu systems of the instrument. There are two main menus: System and Config.

System Menu (System)

Press [**Shift**] + [**8**] (system) to enter the system menu.

Config Menu

Press [**Shift**]+ [**9**] (Config) to enter the menus.

POWER-ON	POWER-ON		Power on state of instrument
	RST(default)	Do not remember state in SAVE 0.Customer can save a often used data in SAVE 0 to recall when power on the DC load next time.	
	SAV0	Remember state in SAVE 0	
BUZZER	BUZZER		
	ON(default)	Enable audible beep when key is pressed	
	OFF	No sound when key is pressed	
KNOB	KNOB		
	UPDATE(default)	The value modified with knob during operation will be saved after load is off.For example; the DC load is set to 1A by press [CC] and turned on the input.Then increase the setting value to 2A with knob.When customer turn off load and trun on again, the setting value changes to 2A.	
	OLD	As explained above, after the DC load is turned on again,the setting value is 1A instead of 2A changed with knob.	
TRIGGER	SOURCE		Set trigger mode
	MANUAL(Def)	Triggered from the [Shift] + []	key
	EXTERNAL	Triggered from a TTL high signal at the trigger connector on rear panel	
	BUS	Triggered from a serial bus command 5AH	
	HOLD	Receiving a command 9DH	
MEMORY	MEMORY		Recall the prestored datas
	GROUP= 0	0:indicates1-10 group;"1":indicates 11-20group, by parity of reasoning	
DISPLAY	DISP-TIMER		Timer function
	ON	Enable timer function	
	OFF(default)	Disable timer function	
RS-232	RS-232		
	4800_8N 1	Baudrate 4800, data bit 8, none parity, stop bit 1	
	9600_8N 1	Baudrate 9600, data bit 8, none parity, stop bit 1	
	19200_8N 1	Baudrate 19200, data bit 8, none parity, stop bit 1	
	38400_8N 1	Baudrate 38400, data bit 8, none parity, stop bit 1	
PROTOCOL	SCPI	Select SCPI protocol	
	FRAME	Select FRAME protocol	
ADDRESS	ADDRESS= 0	Set the instrument's address(0~31)	
RUNMODE	RUN	Runing mode at power on	
	NORMAL	Normal mode	
	BATTERY	Default in battery test mode at power on	
	PROG_TEST	Default in autotest mode at power on	
	OCP_TEST	Default in OCP test mode at power on	
	OPP_TEST	Default in OPP test mode at power on	
DEFAULT	DEFAULT		
	NO	Do not return instrument to factory default settings.	
	YES	Retrun instrument to factory default settings	

PROTECT	Max-P		Set hardware power protection
	MAX POWER=150.00W	Set hardware OPP value	
	A-LIMIT		Set software current protecting state
	A-LIMIT		
	ON	Enable software over current protection function	
	A-LIM POIN=30.000A	Set the software OCP level	
	A-LIM DELAY=3S	Set the OCP delay time	
	OFF	Disable the software OCP function	
	P- LIMIT		Set software power protecting state
	P-LIM POIN=150.00W	Set the software OPP level.	
	P-LIM DELAY=3S	Set the OPP delay time.	
	TIMER		Set load on timer
	LOAD-TIMER		
	ON	Enable load-on timer	
	LOAD-TIMER=10.0S	Set the load on time(0.1S~9999.9S)	
	OFF	Disable load on timer	
MEASURE	V-RANGE		Voltage auto-range function
	V-RANGE		
	ON	Enable voltage auto range function	
	OFF	Disable voltage auto range function	
	FILTER		Set the filter parameter
	FILTER COUNT = 2~14	Filter count set, range 2~16	
	TIME-V1		
	TIME-VOLT1=0.000V	Set the start time, to measure the voltage rise/fall time.	
	TIME-V2		
	TIME-VOLT2=120.00V	Set the end time, to measure the voltage rise/fall time	
CR-LED	CR-LED		Imitate LED (in CR mode)
	ON	Open the function(in CR mode,press [Shift]+ [CV] to set Vd value)	
	OFF	Disable the function	
SENSE	REM- SENSE		Remote sense function
	ON	Enable remote sense function	
	OFF	Disable remote sense function	
VON	VON		Set the load's VON point
	LIVING	VON point living state	
	VON POINT = 0.10V	Set the VON value	
	LATCH	VON point latch state, ON /OFF	
	VON POINT = 0.10V	Set the VON value	
RESET	RESET		Reset the config menu
	NO	Do not reset	
	YES	Reset	

System Settings

1 Run Recall Edit

1. Select "Edit" and press . Enter a value using the numeric keypad or rotary knob for "Voltage On Level". The value must be within the maximum input limits of the load. Press to continue.
2. Enter a value for "Voltage On Delay". This is set between 0.00s and 99.99s. Then press to continue.
1. Follow the same steps for "Current Range". The value must be within the maximum input limits of the load. Press to continue.
2. Set the "Start Power". The value must be within the maximum input limits of the load. Press to continue.
3. Follow the same steps for "Step Power" and "End Power". Press after each settings to continue.
4. Enter a value for "OPP Voltage" and press to continue.
5. Enter a value for "Max Trip Power", and then "Min Trip Power". Press after each settings to continue.
1. The load will prompt to "Save OPP File". Select a number between 1 and 5. Then press to save all settings to the selected location.

Note: At any time when configuring any parameters for the test, you can press the) key to select the previous parameter to edit.

To recall the settings:

1. Press to enter the "OPP Test" menu.

Select "Recall" and press .

1. Use the keypad or knob to select the saved location number and press . All settings will be recalled when selecting "Edit" from the "OPP Test" menu.

To run the OPP test:

1. Recall the settings from memory by following the steps above.
2. From the "OPP Test" menu, select "Run" and press . The display will show the following:

```
OFF CC  
v-0.000a 10.000V 0.000A  
0.00W 0.00W Stop
```

1. Press) to start the test. When the test is running, "Run" will be indicated in place of "Stop". When the test ends, either "Pass" or "Fault" will appear next to "Stop".
2. To stop the test at any time, press).

2 Key Lock

The front panel keys are locked to prevent unwanted changes to output settings and instrument configurations. Follow the steps below to enable/disable key lock.

1. Press) and then (). A "*" indicator will light up on the display, indicating that the front panel keys are lock. At this point, all keys are disabled except for the Lock function.

1. To unlock the keys again, press) and then () again. The "*" indicator will disappear and all keys will be enabled.

6.1 Restore Factory Default Settings

All instrument settings are reset back to their factory default values by doing the following:

Note: Restoring the instrument to factory default will change all current instrument settings and parameters back to their default values.

1. From the "SYSTEM" menu, select "Initialize" and press **Enter**.
2. The following screen will display. Select "Yes" to restore default settings, or "No" to cancel.

The following table lists some of the factory default settings.

Table 3 - Factory Default Settings

Communication	RS232 (4800, 8, N, 1, NONE)
Display On Timer	Off
Trigger Source	Manual
Protocol	SCPI
Von	Latch
A-Limit	Off
Memory	Group 0
Power-On	RST
Buzzer	On
Load On Knob	Update
On Timer	Off
Voltage Auto Range	On
Averaging Filter	2 ¹⁴
Remote Sense	Off
External Program	Off

6.1.1 Configure Power-On State

The initial Power-On state of the load is configured by following the steps below:

1. From the "SYSTEM" menu, select "Power-On" and press **Enter**.
2. There are two options:

Rst(Def) – Factory Default.

"Sav0" – Settings before last power up. Recalls the settings saved to "0" memory location.

1. Select the settings you want during power up, and press **Enter** to save changes.
2. To exit the menu at any time, press **Esc** twice.

6.1.2 Load On Knob

This setting controls the behavior of the knob.

1. From the "SYSTEM" menu, select "Knob" and press **Enter** .
2. There are two options:

Update(default) Real time update.

Old No update (when turning load ON/OFF, original value before use of rotary knob will be set)

3. Select the settings you want during power up and press **Enter** to save changes.
4. To exit the menu at any time, press **Esc** twice.

6.1.3 Configure Trigger Source

The trigger function is used to initiate the start of a program in list mode and also as a toggle for transient mode. The trigger source is set so that users can send a trigger from the front panel, through a remote command via remote interface or through the external trigger input in the rear panel. Follow the steps below to configure the trigger mode:

1. From the "SYSTEM" menu, browse and select "Trigger" and press **Enter** .

Manual(Def) Manual trigger. Front panel trigger button is used to send a trigger (press and (or press ^{Trig}) to send trigger).

External External trigger. Trigger is sent by connecting the "Trig" input and the ground input together in the rear panel. A TTL signal may also be used as a trigger signal when sent across these terminals. If using a TTL signal, the unit triggers off of a falling edge. Signal pulse width must be > 10 μ s.

Hold Hold trigger. This behaves similarly to "Bus" trigger, however the "TRIG:IMM" command is used instead.

Bus Bus trigger. Remote commands "*TRG" and "TRIG:IMM" can both be used to send a trigger. With "Bus" trigger, multiple devices are triggered at the same time when communicating via GPIB interface.

Timer Timer trigger. A trigger will be sent periodically based on the set time. Time is set from 0.01 s to 9999.99 s.

2. Select one of the options. For timer trigger, use the numeric keypad or rotary knob to set the time.
3. To exit the menu at any time, press twice.

6.1.4 Save/Recall Instrument Settings

The instrument can save up to 100 instrument settings in non-volatile memory. Memory is allocated in 10 different storage groups (group 0 to 9), and each group has 10 memory locations to store settings (0 to 9). These memory locations are referenced by numbers 1 – 100. When saving an instrument setting, numbers 1 to 100 is selected. However, when recalling an instrument setting, the group must be selected first and then the numeric keypad buttons 1 through 9 and 0, which refers to the 10 locations of the selected storage group. Below is the table illustrating the storage group and allocated memory locations.

When recalling settings, each of the numeric keypad numbers corresponds to the memory locations based on the storage group selected according to the table above. For storage group 0, recalling memory location 1 is done by pressing ; location 2 is done by pressing , and so on. Memory location 10 is recalled by pressing . For storage group 1, recalling memory location 11 by pressing , location 12 by pressing , and so on.

Example:

Storage Group	Memory locations
0	1 – 10
1	11 – 20
2	21 – 30
3	31 – 40
4	41 – 50
5	51 – 60
6	61 – 70
7	71 – 80
8	81 – 90
9	91 - 100

Settings are saved to memory location 60. To recall those settings, set storage group to 5 from the menu, then press recall and the number .

6.1.5 Select Storage Group

1. From the “SYSTEM” menu, browse and select “Memory” and press . The following screen will appear.
1. Use the current adjust knob or the numeric keypad to enter the storage group. Select between “0 – 9”. Press **Enter** to save selection.
2. To exit the menu at any time, press **Esc** twice.

NOTE: The storage group setting also affects the automatic test function of the load. Refer to “Automatic Test Function” for more details.

6.1.6 Save Settings

1. Set up all the instrument settings that you want to save.
2. Then, press) and . The display will show the following:
3. Use the current adjust knob or the numeric keypad to enter the memory location in which to store current instrument settings. Select between “0 – 100”. Press **Enter** to save to the selection location.

NOTE: The “0” memory location is reserved for storing instrument settings last configured before power-off and is used only for power-on state configuration only.

6.1.7 Recall Settings

1. First, consider the memory locations you want to recall from. As they are grouped together, select the appropriate storage group from the “SYSTEM” menu first by following the instructions in previous section.
2. Once selected, press (b-**Shift**) and **Enter** (or press (recall)) and it will light up to indicate the instrument is in “Recall” mode.

- Use the keypad numbers to recall the settings from the corresponding memory location referenced by the storage group selected in Step 1.
- Once entered, the saved settings at the location will be immediately recalled.

Note: When in Recall mode, users can recall settings from different locations without having to press additional keys each time. For example, you can press 1 to recall settings in location one, and then press 5 to recall settings in location 5 on the fly.

- To exit "Recall" mode, press **Esc**.

6.1.8 Display Input On Timer

The instrument has an internal timer that counts how long the input has been enabled (ON). Follow the steps below to enable the timer display.

- From the "SYSTEM" menu, browse and select "Displ" and press **Enter**. The following screen will appear.
 - Select "On" to enable the timer, and "Off (default)" to disable. Press **Enter** to confirm.
 - Press **Esc** twice to exit the menu. The timer will now be displayed like the following:
 - When input is enabled (ON), the timer will start counting the time. When input is disabled (OFF), the timer will reset itself to a value close to 0 seconds.

6.1.9 Remote Interface Setup

The instrument has RS232, USBTMC, and GPIB remote interfaces available for remote communication. Follow the steps below to select and configure each interface.

Note: The "RMT" indicator will appear on display when the instrument is successfully connected to a PC remotely through any remote interface. Keys on the front panel will be locked until the instrument is in LOCAL mode. To return to LOCAL mode from the front panel, press **Shift** (and then **Config** 9). The "RMT" indicator will disappear when the instrument is in LOCAL mode.

From the "SYSTEM" menu, browse and select "Communication" and press **Enter**. The following screen will appear.

6.1.10 RS-232

Follow the steps below to configure the instrument for RS-232 operation:

- Select "RS-232" and press to set to RS-232 for remote communication. The following display will be shown:
 - " " is the baud rate; "8" is the data bits; "N" is the parity; "1" is the stop bit; "Addr..." is for address.
 - Use the **)** keys to select between each serial settings, and use **)** keys to change the settings.

1. The following setting options that are used: Baudrate: 4800, 9600, 19200, 38400, 57600, 115200* Data bits: 8

Parity: N (None), E (Even), O (Odd)

Stop bit: 1

Flow control: NONE, CTS/RTS, XON/XOFF

Note: The default is 4800, 8, N, 1, NONE.

*Setting the baud rate to 115200 may provide unstable results during remote communication. Select a lower baud rate if communication errors occur.

1. All serial settings must match with the settings configured on the PC in order for communication to link successfully.

6.1.11 CONFIG Menu

All setup procedures and settings explained in this section are accessed from the CONFIG menu. To access this menu, press) and (). The following screen will show:

6.1.11.1 Von Operation

The Von voltage value is set to control the voltage turn on state for the electronic load. When the input voltage exceeds the Von voltage value, the electronic load's input state turns on.

This function can protect a DUT when its voltage goes below a specified level. For example, when testing a power supply's discharge characteristics, you can set the Von voltage level start and stop discharging of the power supply.

Note: Von Operation will have a short delay (< 1 s) from when a condition exceeds or goes below a specified level to when the load's input state changes.

When Von Latch is ON, the electronic load will begin sinking current if input voltage exceeds Von voltage. When the input voltage drops below the Von voltage value, the electronic load will stop sinking current and the input will turn off.

Figure 15 - The Load's Operating Range with Von Latch set to ON

When Von Latch is OFF, the electronic load will begin sinking current if the input voltage exceeds the Von voltage.

When the input voltage drops below the Von voltage value, the electronic load will still continue sinking current and the input remains on.

Figure 16 - Von Latch OFF The Load's Operating Range with Von Latch set to OFF

To set the Von modes, from the "CONFIG" menu, select "Von" and press **Enter** . The following will be displayed:

Use the and (arrows)) keys to select between "On" or "Off" and press confirm

selection. Afterwards, you will be prompted to enter the voltage point of "Von". Use the numeric keypad or rotary knob to change this value.

6.1.12 Configure Protection Settings

The electronic load has the following protection functions: Overvoltage protection (OVP), overcurrent protection (OCP), overpower protection (OPP), overtemperature protection (OTP), and local and remote reverse voltage protection (LRV/RRV).

The instrument will act appropriately once any of the above protections are active. You can press any button on the front panel to restore the protection function. For example, if the electronic load triggers the overtemperature protection, the buzzer will alarm, the input will automatically turn off, and the mainframe VFD will display OTP.

Some OCP and OPP features are configured from within the "Protect" menu. To access this menu, go into "CONFIG" menu and select "Protect". The following display will show:

6.1.13 PROTECT MENU

6.1.14 Max-P A-Limit P-Limit Time

6.1.15 Overcurrent Protection (OCP)

The electronic load includes both hardware and software overcurrent protection features.

"Hardware OCP" - The electronic load's maximum input current will be limited to approximately 110% of the current range. Once the hardware OCP is triggered, the status register's OC bit will be set. When the hardware OCP is removed,

the status register's OC bit will be reset. Hardware overcurrent protection will not affect the electronic load's input on/off state.

"Software OCP" - Users can set the electronic load's software OCP value with the following steps.

1. Go to "CONFIG" menu and select "Protect". Then press **Enter**.
2. Select "A-limit" and press **Enter**.
3. To enable software OCP, select "On" and press **Enter**. The default is "Off".
4. If enabled (ON), the load will prompt to enter a value for "Point". Use the numeric keypad or rotary knob to enter the OCP current limit value, then press **Enter**. The valid range depends on the model of the load.
5. It will then prompt to enter a value for "Delay". This is the protection trip delay, which is the amount of time to delay from when the input has reached the limit before triggering

OCP. Use the numeric keypad or rotary knob to enter a value, then press **Enter** to confirm change. The valid range is 0 – 60 seconds.

NOTE:

Software OCP will disable the input if the input current has reached or exceeded the protection limits.

Operations to Clear the OCP State

Check whether the input current is within the electronic load's rated current or the programmed protection current ranges. If it is outside the range, disconnect the device under test. Then press any key on the front panel or remotely send SCPI command PROTECTION:CLEAR. The OCP displayed on the front panel will turn off and the load exits OCP protection state.

To start an OCP test, press "[]+ []" (OCP) to enter OCP operation.
 EDIT OCP TEST

1. VON LEVEL=0.000V: - Set Voltage threshold
2. VON DELAY=0.00S - After delay certain time, the DC load starts to draw current.
3. RANGE=3.000A - Set current range
4. START=0.1000A - Set start current
5. STEP=0.1000A - Set step current
6. STEP DEL=0.20S - Set delay time of each step
7. END=2.0000A - Set end current
8. OCP VOLT=2.000V - Set OVP value
9. MAX TRIP =1.5000A - Upper limit of OCP value
10. MIN TRIP=0.9000A - Lower limit of OCP value
11. SAVE OCP FILE=1 - Save OCP test file (1-10)

Set the power on mode to be OCP test mode:

After above steps, press [] button to run ocp test file. Recall OCP File:

1. Press "[]+ **Enter** button to select program file, the panel displays "CALL OCP FILE= 1". Enter the file name(1-10), press "**Enter**" button to confirm.

Operation - Display on front panel

- | |
|---|
| 1. Press “[^{Shift} ●] + [8]” (system) enter into system menu - 0.0000V 0.000A POWER-ON BUZZER |
| 2. Press right key, select RUNMODE and confirm - 0.0000V 0.000A RUN <NORMAL
with Enter button - |
| 3. Press direction key to select OCP_TEST, Press “ Enter ” to confirm. - 0.0000V 0.000A RUN <OCP_TEST> |
| 4. Press [Esc] button to quit the set. - 0.0000V 0.000A STOP 0.000A |

2. According to the following steps to escape OCP mode: press “[^{Shift} ●] + [8]” (system) — “RUNMODE” — “[Enter]” — select “NORMAL” mode — “**Enter**”.

6.1.16 Overpower Protection (OPP)

The electronic load includes both hardware and software OPP features.

“Hardware OPP” – In the event that the electronic load’s input power exceeds the set power protection limit, the hardware OPP will limit the power. Once the hardware OPP is triggered, the status register’s OP bit will be set. When the hardware OPP is removed, the status register’s OP bit will be reset. Hardware overpower protection will not turn the electronic load’s input off.

Follow the steps below to set the hardware OPP limit.

1. Go to “CONFIG” menu and select “Protect”. Then press **Enter**.
2. Select “Max-P” and press **Enter**.
3. The load will prompt to enter a value for “Point”. This is the hardware OPP limit value.

Use the numeric keypad or rotary knob to enter a value. Press **Enter** to confirm the change.

“Software OPP” - Users can set the electronic load’s software OPP value with the following steps.

1. Go to “CONFIG” menu and select “Protect”. Then press **Enter**.
2. Select “P-limit” and press **Enter**.
3. To enable software OPP, select “On” and press **Enter**. The default is “Off”.
4. If enabled (ON), the load will prompt to enter a value for “Point”. Use the numeric keypad or rotary knob to enter the OPP power limit value, then press **Enter**. The valid range depends on the model of the load.
5. It will then prompt to enter a value for “Delay”. This is the protection trip delay, which is the amount of time to delay from when the input has reached the limit before triggering

OPP. Use the numeric keypad or rotary knob to enter a value, then press **Enter** to confirm change. The valid range is 0 – 60 seconds.

Operations to Clear the OPP State

Check whether the input power is within the rated power range or the programmed protection ranges. If it is outside the range, disconnect the device under test. Then press any key on the front panel or remotely send command PROTECTION:CLEAR. The OPP displayed on the front panel will turn off and the electronic load exits OPP protection state.



To start a OPP test, press “[^{Shift} ●] + [^{Trig} ⏏]” (Trigger).

Press “[^{Shift} ●] + [CW]” (OPP) to enter OPP test operation.

OPP TEST RUN
 OPP TEST
 STOP Run OPP test file
 CALL OPP TEST
 Recall OPP File=1 Recall OPP test file(range file1-file10)
 EDIT OPP TEST

1. VON LEVEL=0.000V - - Set Voltage on value
2. VON DELAY=0.01S - - Set Voltage on delay time
3. RANGE=5A - - Set working current range
4. START =0.1W - - Set start power value
5. STEP =1W - - Set step power value
6. STEP DEL=1S - - Set step delay time
7. END =12W - - Set cut-off power value
8. OPP VOLT=7V - - Set OPP value
9. MAX TRIP =6.5W - - Upper limit of OPP value
10. MIN TRIP =5.6W - - Lower limit of OPP value
11. SAVE OPP FILE=1 - - Save OPP test file

Set the power on mode to be OPP test mode
 Operation - Display on front pannel

1. Press “[]+ [8]” (system) enter into sysmtem menu - 0.0000V 0.000A POWER-ON BUZZER
2. Press right key,select RUNMODE and - 0.0000V 0.000A RUN <NORMAL> confirm with “” button -
3. Press direction key to OCP_TEST,Press “” to confirm. - select - 0.0000V 0.000A RUN <OPP_TEST>
4. Press “[Esc]” button to quit the set. - - 0.0000V 0.000A STOP 0.000A

After above steps,press  button to run OPP test file.





images/triggerButton

file:

images/triggerButton

state:

6.1.17 Recall OPP File

1. Press “[]+  ” button to select programe file,the panel displays “CALL OPP FILE= 1”. Enter the file name(1-10), press  button to confirm.
2. According to the following steps to escape OPP mode:press []+ [8]

(system)——RUNMODE————select “NORMAL” mode——.

6.1.18 Overvoltage Protection (OVP)

The instrument’s maximum OVP limit is 110% of the maximum rated voltage.

If the OVP circuit has triggered, input will turn off, buzzer alarm will go off, and the status register's OV and VF bit will be set. The mainframe will display OVP and the condition will remain until they are reset. Once overvoltage protection occurs, the "VF" pin on the rear panel will output TTL Low voltage level. Under normal conditions, it outputs a 5 V TTL high signal.

Operations to Clear the OVP State

Check whether the input voltage is within the electronic load's rated voltage or the programmed protection voltage ranges. If it is outside the range, please disconnect the device under test. Then press any key on the front panel or remotely send SCPI command

PROTection:CLEAr. The OVP displayed on the front panel will turn off and the electronic load exits OVP protection state.

6.1.19 Overtemperature Protection (OTP)

There is an overtemperature protection circuit, which will turn off the input if the internal temperature exceeds safe limits. When the electronic load's internal circuit temperature is over 85C, the load will enable OTP. Input will automatically be turned off and the VFD will display OTP. At the same time the OT and PS bits in the status register will be set and remain until they are reset.

Operations to Clear the OTP State

When the electronic load temperature has dropped below the protection point, press any key on the front panel or remotely send command PROTection:CLEAr. The OTP displayed on the front panel will turn off and the electronic load exits OTP protection state.

6.1.20 Reverse Voltage Protection (LRV/RRV)

This function protects the electronic load in case the input DC voltage lines are connected with the wrong polarity. When a reverse voltage (LRV – local reverse voltage, RRV – remote reverse voltage) connection condition is detected, the input will immediately turn off, the buzzer will alarm the user, and the status register's reverse voltage (LRV/RRV) and VF bits will be set. The load will display LRV/RRV until they are reset.

In this condition, the "VF" pin will output a low level.

Operations to Clear the Reverse Voltage State

Check whether the connection is reversed. If so, disconnect the device to be measured and the reverse voltage state will be cleared.

6.1.21 Configure Timed Input

The load has a built-in timer function that is configured to allow enabling (ON) the main input for a specified amount of time. To configure this time, follow the steps below:

1. Go to "CONFIG" menu and select "Protect". Then press **Enter** .
2. Select "Time" and press **Enter** .
3. To enable timed input, select "On" and press **Enter** . The default is "Off".
4. It will then prompt to enter a value for "Delay". This is the amount of time to enable the input from when the is pressed (or when input is turned ON remotely). Once this time is past, input will be disabled (OFF). Use the numeric keypad or rotary knob to enter the value. Press **Enter** to confirm the change. The valid range is 0 – 60000 seconds.
5. Now, press **ESC** twice to exit the menu. The instrument will show the delay timer as follows:

6.1.22 Measurement Configurations

Voltage Auto Range

By default, the load has auto range enabled for voltage measurements and operations. To enable or disable, follow the steps below:

1. Go to “CONFIG” menu and select “Measure” and press **Enter** .
2. Select “V-Range” and press **Enter** .
3. To enable voltage auto range, select “On” and press **Enter** . To disable, select “Off” and press **Enter** to confirm the change.

Measuring Rise and Fall Time

The instrument can measure the rise or fall time from a specified start and stop voltage level of the measured input. This feature requires the display timer to be enabled first. To enable timer, please follow the instructions in the “Display Input On Timer” section of “SYSTEM Menu”.

To setup this measurement, follow the steps below:

1. Go to “CONFIG” menu and select “Measure”. Then press **Enter** .
2. Select “TimeV1” and press **Enter** . The load will prompt to enter a value. Use the numeric keypad or rotary knob to set a value and press **Enter** to confirm. This is for the start voltage level. When the measured input voltage reaches this level, the timer will start.
3. Now, select “TimeV2” from the “Measure” menu and press **Enter** . The load will prompt to enter a value. Use the numeric keypad or rotary knob to set a value and press **Enter** to confirm. This is for the stop voltage level. When the measured input voltage reaches this level, the timer will stop. The time on display will show the time difference between the measured start and stop voltage level.

Measurement Averaging Filter

The measurement averaging filter is adjusted. Increasing the averaging will provide more accurate readings, but slower measurement update rate. Decreasing the averaging will provide faster measurement update rate, but less accurate readings.

To configure, follow the steps below:

1. Go to “CONFIG” menu and select “Measure”. Then press **Enter** .
2. Select “Filter” and press **Enter** . The load will prompt to enter a value for “Average Count”.
3. Use the numeric keypad or rotary knob to adjust this value, then press **Enter** to save the change. The valid range is from 2 – 16 ($2^2 - 2^{16}$). The default is 14 (2^{14}).

6.1.23 CR LED Function

CR LED is a function that allows the instrument to simulate the loading behavior of typical LEDs, which is used for testing LED drivers. When the function is enabled, the load allows the user to configure the LED’s operating resistance and forward voltage along with the voltage range (same as CR operation). Below illustrates the V-I characteristics curve of a typical LED.

I

Figure 17 - CR LED IV Characteristics Curve





Vd Forward voltage of the LED

Rd LED’s operating resistance

V_o Operating voltage across the LED

I_o Operating current across the LED

To configure CR LED function, follow the steps below:

1. Press  to access the “CONFIG” menu.
 2. Select “CR_LED” and press
 3. Select “On” and press to exit the “CONFIG” menu.
 4. Press to enter CR operation, then press (b-) and to access CR mode settings.
 5. Use the numeric keypad or rotary knob to enter the values for “Range”, “Voltage High”, “Voltage Low”, and “Vd”. “Vd” will be the forward voltage of the LED you want to simulate. This option will only appear after “CR_LED” has been enabled from the “CONFIG” menu.
1. While in CR mode, use the numeric keypad or rotary knob to enter a value for “Rd,” the resistance.
 2. Now that both “Vd” and “Rd” are configured, turn ON the input by pressing .

6.1.24 Remote Sensing

Remote sensing is used to counteract the effect of lead resistance. For example, if you connect a power supply to the DC Load, the voltage at the power supply’s terminals will not be the same as the voltage at the DC Load’s terminals if there is a current flowing because of the finite resistance from the wires. Using remote sensing, you can sense the voltage at the power supply’s terminals, effectively removing the effect of the voltage drop in the connection wire.

When using remote sensing, the power displayed by the instrument includes both the power dissipated inside the instrument and the power dissipated in the leads from the power supply to the DC Load’s input terminals.

Steps to enable remote sensing in the menu:

1. Press [] + [9] key into the menu
2. VFD displays > , press [Enter] key to confirm
3. Press [(right/left)] to choose > , press [Enter] key to confirm
4. Press [(right/left)] to choose > , press [Enter] key to confirm, then remote sense function has been set, and VFD display indicator.



Remote Sensing: SENSE (+) and SENSE (–) are the remote sensing inputs. By eliminating the effect of the inevitable voltage drop in the DC load leads, remote sensing provides greater accuracy by allowing the DC load to regulate directly at the source’s output terminals.

Wiring Diagram for Remote Sensing:

6.1.25 External Triggering

EXTERNAL: An external trigger is a TTL low signal applied to the Trigger connection on the back panel. This TTL signal must last for more than 5 ms. A trigger applied to this input is used to change settings (voltage, current, resistance), toggle between settings in transient- toggle mode, or generate a pulse in pulse mode.

Operation to select the trigger source as external:

- [] + [8] (system) to enter the menu, use [(right/left)] to select TRIGGER, press , and then select EXTERNAL. Press  to exit the menu.

6.1.26 Current Monitoring (I Monitor)

Current monitoring terminal will output 0-10V analog signal to corresponding to 0 to full range of input current. You can connect an external voltmeter or an oscilloscope to display the input current's changing

Protection Functions

1 OCP Test Function

The load has a built-in OCP test function that can be used to automate testing for OCP conditions. The load can save up to 5 OCP test programs into internal memory, which can be recalled and run.

The OCP Test program requires the following parameters be configured before it can be run.

“Voltage On Level”	This is the minimum voltage level the load measures before the start of the test.
“Voltage On Delay”	This is the delay time from when the Voltage On Level is reached to the actual start of the test.
“Current Range”	This specifies the current range of the test. All models have two current ranges, with the lower range allowing for higher resolution. This value will also limit the maximum current settings for other parameters configured for the test program.
“Start Current”	This is the starting current value when OCP test begins. The settable range of this value is limited by “Current Range”.
“Step Current”	This is the size of the step current as the test runs from the “Start Current” to “End Current”. The test will only run through in steps if the measured input voltage is greater than the “OCP Voltage”. Otherwise, the test will end after running the “Start Current” for the amount of time specified in “Step Delay”.
“Step Delay”	This is the delay time to hold each current step in the test. This determines how fast or slow to run through the test.
“End Current”	This is the ending current value before OCP test ends. The test will only run through in steps from “Start Current” to the “End Current” if input voltage is greater than the “OCP Voltage”. The settable range of this value is limited by “Current Range”.
“OCP Voltage”	This value is a limit that is used to test for OCP conditions. In the event of an over current condition, when the input voltage is greater than this value, the test will run through from “Start Current” to “End Current” in steps. The input current (the over current) value will be checked during this process. If current is within the “Max Trip Current” and “Min Trip Current” boundaries, the load will indicate “Pass” at the end of the test. If outside of these boundaries, the load will indicate “Fault”.
“Max Trip Current”	The maximum acceptable current limit of the over current value.
“Min Trip Current”	The minimum acceptable current limit of the over current value.

The following is a step by step procedure to configure an OCP test program.

1. Press) and to enter the “OCP Test” menu. The following will be displayed:

1. Select “Edit” and press (enter) . Enter a value using the numeric keypad or rotary knob for “Voltage On Level”. The value must be within the maximum input limits of the load.

Press (enter) to continue.

1. Enter a value for “ Voltage On Delay”. This can be set between 0.00s and 99.99s. Then press (enter) to continue.
2. Follow the same steps for “ Current Range”. The value must be within the maximum input limits of the load. Press (enter) to continue.
3. Set the “Start Current”. The value must be less than “Current Range”. Press (enter) to continue.
4. Do the same for “Step Current” and “End Current”. Press (enter) after each setting to continue.
5. Enter a value for “OCP Voltage” and press (enter) to continue.

6. Finally, enter a value for “Max Trip Current”, and then “Min Trip Current”. Press (enter) after each settings to continue.

7. The load will prompt to “Save OCP File”. Select a number between 1 and 5. Then press

(enter) to save all settings to the selected location.

Note: At any time when configuring any parameters for the test, you can press the key to select the previous parameter to edit.

To recall the settings:

1. Press) and to enter the “OCP Test” menu. Select “Recall” and press
2. Use the keypad or knob to select the saved location number and press . All settings will be recalled when selecting “Edit” from the “OCP Test” menu.

To run the OCP test:

1. Recall the settings from memory by following the steps above.
2. Then, from the “OCP Test” menu, select “Run” and press . The display will show the following:

Press (.)trig to start the test. When the test is running, “Run” will be indicated in place of “Stop”. When the test ends, either “Pass” or “Fault” will appear next to “Stop”.

4. To stop the test at any time, press .

2 OPP Test Function

The load has a built-in OPP test function that can be used to automate testing for OPP conditions. The load can save up to 5 OPP test programs into internal memory, which can be recalled and run.

The OPP Test program requires the following parameters be configured before it can be run.

“Voltage On Level”	This is the minimum voltage level the load measures before the start of the test.
“Voltage On Delay”	This is the delay time from when the “Voltage On Level” is reached to the actual start of the test.
“Current Range”	This specifies the current range of the test. All models have two current ranges, with the lower range allowing for higher resolution. This value will also limit the maximum settings for other parameters configured for the test program.
“Start Power”	This is the starting power value when OPP test begins.
“Step Power”	This is the size of the step power as the test runs from the “Start Power” to “End Power”. The test will only run through in steps if the measured input voltage is greater than the “OPP Voltage”. Otherwise, the test will end after running the “Start Power” for the amount of time specified in Step

“Delay”.

The following is a step by step procedure to configure an OPP test program.

1. Press) and to enter the “OPP Test” menu. The following will be displayed:

3 OPP TEST

"Step Delay"	This is the delay time to hold each power step in the test. This determines how fast or slow to run through the test.
"End Power"	This is the ending power value before OPP test ends. The test will only run through in steps from "Start Power" to the "End Power" if input voltage is greater than the "OPP Voltage".
"OPP Voltage"	This value is a limit that is used to test for OPP conditions. In the event of an over power condition, when the input voltage is greater than this value, the test will run through from "Start Power" to "End Power" in steps. The input power (the over power) value will be checked during this process. If power is within the "Max Trip Power" and "Min Trip Power" boundaries, the load will indicate "Pass" at the end of the test. If outside of these boundaries, the load will indicate "Fault".
"Max Trip Power"	The maximum acceptable power limit of the over power value.
"Min Trip Power"	The minimum acceptable power limit of the over power value.

Remote Operation

8.1 Interface Connection

8.2 Serial Interface

PIN	Description
1	-
2	Transmit Data
3	Receive Data
4	-
5	GND
6	-
7	CTS
8	RTS
9	-

A straight pin-to-pin DB9 female to DB9 male serial cable is required for using the RS-232 interface. Do not use a null modem or crossover DB9 serial cable.

8.2.1 GPIB

The load can be configured with a GPIB address from 0 – 31. To communicate via GPIB, connect a GPIB cable to the GPIB interface on the rear panel, as illustrated below.

8.2.2 USBTMC

The device is SR1, RL1, and DT1 enabled. It can receive the following request: REN_CONTROL, GO_TO_LOCAL, LOCAL_LOCKOUT. When it receives MsgID = TRIGGER USBTMC command, it will transmit TRIGGER command to the function layer.

8.2.3 Remote Commands

The instrument supports some SCPI commands and some instrument specific commands. These commands enable a computer to remotely communicate and control the instrument over any of the supported remote interfaces: USBTMC, RS-232, and GPIB.

Refer to the programming manual for details, which can be downloaded from www.bkprecision.com.

Troubleshooting Guide

Below are some frequently asked questions and answers. Please check if any apply to your instrument before contacting B&K Precision.

1 General

Q: I cannot power up the instrument.

Check that the power cord is securely connected to the AC input and there is live power from your electrical AC outlet. Verify that the AC power coming from the mains have the correct voltage. The load can accept a specific range of AC input voltages. Refer to section “

Q: I cannot set power (in CW) or current (in CC) at the maximum rating.

4. Check the power and current “Limits” from the “Protect” menu within the “CONFIG” menu. Refer to section 3.4 for details.

2 Remote Control

Q: I am trying to send the commands over USB/RS232, but it does not seem to respond.

Check that you are sending ASCII strings that are terminated with a CR (carriage return) and LF (line feed) character. For RS-232, check that the baud rate, parity, data bits, stop bit, and flow control settings match with the settings configured on the software interface. To check these settings, go to the “SYSTEM” menu and enter the “Communication” menu, and select RS-232.

3 Error Information References

The following error information may occur when an error occurs during Power On self-test:

- If the EEPROM was damaged, the VFD will display “Eeprom Fail”.
- If the latest operation data in EEPROM is lost, then VFD will display “Config Data Lost”.
- If the calibration data in EEPROM is lost, then VFD will display “Cal data lost”.
- If the system setting data in EEPROM is lost, the VFD will display “Eeprom data lost”. Please press [**Shift**] + [**4**] and [**0**] to save after setting parameters.

4 Exception handling

If the electronic load cannot start normally, please check and take measures by reference to steps below.

1. Check whether the power line is correctly connected and confirm whether the electronic load is powered. Correct wiring of power line => 2

Incorrect wiring of power line => Re-connect the power line and check whether the exception is removed.

1. Check whether the power in On.[**Power**] key is under

Yes => 3

No => Please check the [**Power**] key to start power and check whether the exception is removed.

1. Check whether set power voltage of electronic load is larger than the power supply voltage. If set power voltage is 220 V and the supply voltage is 110V, the electronic load cannot start.

2. Check whether the fuse of electronic fuse is burned out.

If yes, change fuse. Detailed steps:

- Pull out power line and take out the fuse box at power line jack with a small screw driver. As shown below.
- If the fuse is fused, please change fuse of same specification based on machine model. See the table below for matching information of fuse and machine model.

Service Information

Warranty Service: Please go to the support and service section on our website at bkprecision.com to obtain an RMA #. Return the product in the original packaging with proof of purchase to the address below. Clearly state on the RMA the performance problem and return any leads, probes, connectors and accessories that you are using with the device.

Non-Warranty Service: Please go to the support and service section on our website at bkprecision.com to obtain an RMA #. Return the product in the original packaging to the address below. Clearly state on the RMA the performance problem and return any leads, probes, connectors and accessories that you are using with the device. Customers not on an open account must include payment in the form of a money order or credit card. For the most current repair charges please refer to the service and support section on our website.

Return all merchandise to B&K Precision Corp. with prepaid shipping. The flat-rate repair charge for Non-Warranty Service does not include return shipping. Return shipping to locations in North America is included for Warranty Service. For overnight shipments and non-North American shipping fees please contact B&K Precision Corp.

B&K Precision Corp.

: 22820 Savi Ranch Parkway

Yorba Linda, CA 92887

bkprecision.com

714-921-9095

Include with the returned instrument your complete return shipping address, contact name, phone number and description of problem.

LIMITED THREE-YEAR WARRANTY

B&K Precision Corp. warrants to the original purchaser that its products and the component parts thereof, will be free from defects in workmanship and materials for a period of **three years** from date of purchase.

B&K Precision Corp. will, without charge, repair or replace, at its option, defective product or component parts. Returned product must be accompanied by proof of the purchase date in the form of a sales receipt.

To help us better serve you, please complete the warranty registration for your new instrument via our website www.bk-precision.com

Exclusions: This warranty does not apply in the event of misuse or abuse of the product or as a result of unauthorized alterations or repairs. The warranty is void if the serial number is altered, defaced or removed.

B&K Precision Corp. shall not be liable for any consequential damages, including without limitation damages resulting from loss of use. Some states do not allow limitations of incidental or consequential damages. So the above limitation or exclusion may not apply to you.

This warranty gives you specific rights and you may have other rights, which vary from state-to-state.

B&K Precision Corp.
22820 Savi Ranch Parkway
Yorba Linda, CA 92887
www.bkprecision.com
714-921-9095