

# **BK PRECISION**<sup>®</sup>

Model: 8600/B, 8601/B, 8602/B, 8610/B, 8612/B, 8614/B,  
8616, 8620, 8622, 8624, and 8625

## **Programmable DC Electronic Loads**

**USER MANUAL**



# Safety Summary

The following safety precautions apply to both operating and maintenance personnel and must be followed during all phases of operation, service, and repair of this instrument.

## **WARNING**

Before applying power to this instrument:

- Read and understand the safety and operational information in this manual.
- Apply all the listed safety precautions.
- Verify that the voltage selector at the line power cord input is set to the correct line voltage. Operating the instrument at an incorrect line voltage will void the warranty.
- Make all connections to the instrument before applying power.
- Do not operate the instrument in ways not specified by this manual or by B&K Precision.

Failure to comply with these precautions or with warnings elsewhere in this manual violates the safety standards of design, manufacture, and intended use of the instrument. B&K Precision assumes no liability for a customer's failure to comply with these requirements.

### ***Category rating***

The IEC 61010 standard defines safety category ratings that specify the amount of electrical energy available and the voltage impulses that may occur on electrical conductors associated with these category ratings. The category rating is a Roman numeral of I, II, III, or IV. This rating is also accompanied by a maximum voltage of the circuit to be tested, which defines the voltage impulses expected and required insulation clearances. These categories are:

**Category I (CAT I):** Measurement instruments whose measurement inputs are not intended to be connected to the mains supply. The voltages in the environment are typically derived from a limited-energy transformer or a battery.

**Category II (CAT II):** Measurement instruments whose measurement inputs are meant to be connected to the mains supply at a standard wall outlet or similar sources. Example measurement environments are portable tools and household appliances.

**Category III (CAT III):** Measurement instruments whose measurement inputs are meant to be connected to the mains installation of a building. Examples are measurements inside a building's circuit breaker panel or the wiring of permanently-installed motors.

Category IV (CAT IV): Measurement instruments whose measurement inputs are meant to be connected to the primary power entering a building or other outdoor wiring.

**⚠ WARNING**

Do not use this instrument in an electrical environment with a higher category rating than what is specified in this manual for this instrument.

**⚠ WARNING**

You must ensure that each accessory you use with this instrument has a category rating equal to or higher than the instrument's category rating to maintain the instrument's category rating. Failure to do so will lower the category rating of the measuring system.

***Electrical Power***

This instrument is intended to be powered from a CATEGORY II mains power environment. The mains power should be 120 V RMS or 240 V RMS. Use only the power cord supplied with the instrument and ensure it is appropriate for your country of use.

***Ground the Instrument***

**⚠ WARNING**

To minimize shock hazard, the instrument chassis and cabinet must be connected to an electrical safety ground. This instrument is grounded through the ground conductor of the supplied, three-conductor AC line power cable. The power cable must be plugged into an approved three-conductor electrical outlet. The power jack and mating plug of the power cable meet IEC safety standards.

**⚠ WARNING**

Do not alter or defeat the ground connection. Without the safety ground connection, all accessible conductive parts (including control knobs) may provide an electric shock. Failure to use a properly-grounded approved outlet and the recommended three-conductor AC line power cable may result in injury or death.

**⚠ WARNING**

Unless otherwise stated, a ground connection on the instrument's front or rear panel is for a reference of potential only and is not to be used as a safety ground.

***Do not operate in an explosive or flammable atmosphere***

**⚠ WARNING**

Do not operate the instrument in the presence of flammable gases or vapors, fumes, or finely-divided particulates.

**⚠ WARNING**

The instrument is designed to be used in office-type indoor environments. Do not operate the instrument

- In the presence of noxious, corrosive, or flammable fumes, gases, vapors, chemicals, or finely-divided particulates.
- In relative humidity conditions outside the instrument's specifications.
- In environments where there is a danger of any liquid being spilled on the instrument or where any liquid can condense on the instrument.
- In air temperatures exceeding the specified operating temperatures.
- In atmospheric pressures outside the specified altitude limits or where the surrounding gas is not air.
- In environments with restricted cooling air flow, even if the air temperatures are within specifications.
- In direct sunlight.

**⚠ CAUTION**

This instrument is intended to be used in an indoor pollution degree 2 environment. The operating temperature range is 0 °C to 40 °C and the operating humidity range is ≤ 95% relative humidity with no condensation allowed.

Measurements made by this instrument may be outside specifications if the instrument is used in non-office-type environments. Such environments may include rapid temperature or humidity changes, sunlight, vibration and/or mechanical shocks, acoustic noise, electrical noise, strong electric fields, or strong magnetic fields.

***Do not operate instrument if damaged***

**⚠ WARNING**

If the instrument is damaged, appears to be damaged, or if any liquid, chemical, or other material gets on or inside the instrument, remove the instrument's power

cord, remove the instrument from service, label it as not to be operated, and return the instrument to B&K Precision for repair. Notify B&K Precision of the nature of any contamination of the instrument.

***Clean the instrument only as instructed***

**⚠ WARNING**

Do not clean the instrument, its switches, or its terminals with contact cleaners, abrasives, lubricants, solvents, acids/bases, or other such chemicals. Clean the instrument only with a clean dry lint-free cloth or as instructed in this manual.

***Not for critical applications***

**⚠ WARNING**

This instrument is not authorized for use in contact with the human body or for use as a component in a life-support device or system.

***Do not touch live circuits***

**⚠ WARNING**

Instrument covers must not be removed by operating personnel. Component replacement and internal adjustments must be made by qualified service-trained maintenance personnel who are aware of the hazards involved when the instrument's covers and shields are removed. Under certain conditions, even with the power cord removed, dangerous voltages may exist when the covers are removed. To avoid injuries, always disconnect the power cord from the instrument, disconnect all other connections (for example, test leads, computer interface cables, etc.), discharge all circuits, and verify there are no hazardous voltages present on any conductors by measurements with a properly-operating voltage-sensing device before touching any internal parts. Verify the voltage-sensing device is working properly before and after making the measurements by testing with known-operating voltage sources and test for both DC and AC voltages. Do not attempt any service or adjustment unless another person capable of rendering first aid and resuscitation is present.

Do not insert any object into an instrument's ventilation openings or other openings.

## **WARNING**

Hazardous voltages may be present in unexpected locations in circuitry being tested when a fault condition in the circuit exists.

### *Fuse replacement*

## **WARNING**

Fuse replacement must be done by qualified service-trained maintenance personnel who are aware of the instrument's fuse requirements and safe replacement procedures. Disconnect the instrument from the power line before replacing fuses. Replace fuses only with new fuses of the fuse types, voltage ratings, and current ratings specified in this manual or on the back of the instrument. Failure to do so may damage the instrument, lead to a safety hazard, or cause a fire. Failure to use the specified fuses will void the warranty.

### *Servicing*

## **CAUTION**

Do not substitute parts that are not approved by B&K Precision or modify this instrument. Return the instrument to B&K Precision for service and repair to ensure that safety and performance features are maintained.

### *Cooling fans*

## **CAUTION**

This instrument contains one or more cooling fans. For continued safe operation of the instrument, the air inlet and exhaust openings for these fans must not be blocked nor must accumulated dust or other debris be allowed to reduce air flow. Maintain at least 25 mm clearance around the sides of the instrument that contain air inlet and exhaust ports. If mounted in a rack, position power devices in the rack above the instrument to minimize instrument heating while rack mounted. Do not continue to operate the instrument if you cannot verify the fan is operating (note some fans may have intermittent duty cycles). Do not insert any object into the fan's inlet or outlet.

***Do not short-circuit batteries***

**⚠ WARNING**

When using a DC load to discharge a battery, do not exceed the battery manufacturer's specified maximum rate of discharge.

***Use correctly sized wires***

**⚠ WARNING**

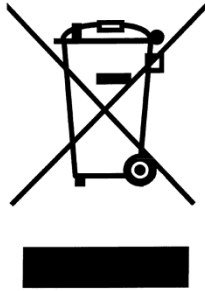
To connect the load to the power supply, use a wire diameter large enough to handle the maximum continuous output short-circuit current of the power supply without the wire overheating.

***For continued safe use of the instrument***

- Do not place heavy objects on the instrument.
- Do not obstruct cooling air flow to the instrument.
- Do not place a hot soldering iron on the instrument.
- Do not pull the instrument with the power cord, connected probe, or connected test lead.
- Do not move the instrument when a probe is connected to a circuit being tested.

# Compliance Statements

Disposal of Old Electrical & Electronic Equipment (Applicable in the European Union and other European countries with separate collection systems)



This product is subject to Directive 2002/96/EC of the European Parliament and the Council of the European Union on waste electrical and electronic equipment (WEEE) , and in jurisdictions adopting that Directive, is marked as being put on the market after August 13, 2005, and should not be disposed of as unsorted municipal waste. Please utilize your local WEEE collection facilities in the disposition of this product and otherwise observe all applicable requirements.



# **CE Declaration of Conformity**

The instrument meets the requirements of 2006/95/EC Low Voltage Directive and 2004/108/EC Electromagnetic Compatibility Directive with the following standards.








## **Low Voltage Directive**

- EN61010-1: 2001

## **EMC Directive**

- EN 61000-3-2: 2006
- EN 61000-3-3: 1995+A1: 2001+A2: 2005
- EN 61000-4-2 / -3 / -4 / -5 / -6 / -11
- EN 61326-1: 2006

## Safety Symbols

	CAUTION indicates a hazardous situation which, if not avoided, could result in minor or moderate injury.
	WARNING indicates a hazardous situation which, if not avoided, could result in death or serious injury.
	Chassis (earth ground) symbol.
	On (Power)
	Off (Power)
	On (Power). This is the In position of the power switch when instrument is ON.
	Off (Power). This is the Out position of the power switch when instrument is OFF.



DANGER indicates a hazardous situation which, if not avoided, will result in death or serious injury.



WARNING indicates a hazardous situation which, if not avoided, could result in death or serious injury.



CAUTION indicates a hazardous situation which, if not avoided, could result in minor or moderate injury.



Safety instructions (or equivalent) signs indicate specific safety-related instructions or procedures.

# Table of Contents

<b>Safety Summary</b> .....	<b>i</b>
Compliance Statements .....	vii
CE Declaration of Conformity.....	viii
<b>1 General Information</b> .....	<b>1</b>
1.1 Product Overview .....	1
1.2 Package Contents .....	2
1.3 Product Dimensions .....	2
1.4 Rackmount Installation .....	6
1.5 Front Panel Overview.....	7
<i>Front Panel Description</i> .....	8
1.6 Rear Panel Overview .....	9
<i>Rear Panel Description</i> .....	10
1.7 Display Overview.....	10
<i>Display Description</i> .....	11
<b>2 Getting Started</b> .....	<b>12</b>
2.1 Input Power and Fuse Requirements.....	12
<i>Input Power</i> .....	12
<i>Fuse Requirements</i> .....	13
<i>Fuse Replacement</i> .....	13
2.2 Input Connections.....	14
2.3 Preliminary Check .....	15
<i>Self-test Errors</i> .....	15
<i>Input Check</i> .....	16
<i>Check Model and Firmware Version</i> .....	17
<b>3 Front Panel Operation</b> .....	<b>18</b>
3.1 Menu Options .....	18
<i>System Menu</i> .....	18
<i>Config Menu</i> .....	18
<i>How to Navigate the Menu</i> .....	19
3.2 Configure Operation Modes (CC/CV/CR/CW) .....	20

<i>Constant Current (CC) Mode</i> .....	20
<i>Constant Voltage (CV) Mode</i> .....	23
<i>Constant Resistance (CR) Mode</i> .....	24
<i>Constant Power (CW) Mode</i> .....	25
<i>Setting CC, CV, CR, CW Mode</i> .....	27
3.3    SYSTEM Menu .....	27
<i>Restore Factory Default Settings</i> .....	28
<i>Configure Power-On State</i> .....	29
<i>Load On Knob</i> .....	29
<i>Configure Trigger Source</i> .....	30
<i>Save/Recall Instrument Settings</i> .....	31
<i>Display Input On Timer</i> .....	34
<i>Remote Interface Setup</i> .....	34
3.4    CONFIG Menu .....	37
<i>Von Operation</i> .....	37
<i>Configure Protection Settings</i> .....	40
<i>Configure Timed Input</i> .....	44
<i>Measurement Configurations</i> .....	44
<i>CR LED Function</i> .....	46
<i>Remote Sense</i> .....	47
<i>External Analog Control and Monitor</i> .....	48
3.5    Short Operation .....	50
3.6    Transient Operation .....	51
<i>Continuous</i> .....	51
<i>Pulse</i> .....	52
<i>Toggle</i> .....	52
3.7    List Operation .....	56
<i>Configure List</i> .....	57
<i>Run List</i> .....	59
3.8    Battery Test Function .....	60
3.9    Test Operations .....	61
<i>Automatic Test Function</i> .....	61
<i>OCP Test Function</i> .....	71

<i>OPP Test Function</i> .....	74
3.10 Key Lock.....	77
<b>4 Remote Operation.....</b>	<b>78</b>
4.1 Interface Connection.....	78
<i>RS-232</i> .....	78
<i>GPIB (non-B series only)</i> .....	79
<i>USBTMC</i> .....	79
4.2 Remote Commands.....	79
<b>5 Troubleshooting Guide .....</b>	<b>80</b>
<i>General</i> .....	80
<i>Remote Control</i> .....	80
<b>6 Specifications .....</b>	<b>81</b>
Supplementary Characteristics .....	87
<b>7 Calibration.....</b>	<b>89</b>
<b>Index.....</b>	<b>90</b>

# 1 General Information

## 1.1 Product Overview

The 8600/B Series DC Electronic Loads are versatile instruments used for static and dynamic testing of DC power supplies, batteries, DC-to-DC converters, and battery chargers. Other applications include fuel-cell and photovoltaic cell test.

The DC load can be used in one of the following operation modes: constant voltage (CV), constant current (CC), constant resistance (CR), or constant power (CW). A wide range of dynamic loading applications can be simulated through user-programmable slew rates, load levels, duration, and conducting voltage. The DC load can be remotely programmed via the USB, GPIB (non-B series only), or RS-232 serial interface. Versatile triggering options allow the dynamic load behavior to be synchronized with other events.

A battery test mode is provided that will measure the ampere-hour (Ah) characteristic of a battery. Shorts can be simulated by either the front panel or custom programming. The DC source or other components can be protected from excessive voltage, current, or power, which will cause the DC load to shut down if excessive levels or reverse polarity are detected.

### Features:

- CC/CV/CR/CW operating modes
- High Resolution Display
- Transient mode up to 25 kHz
- List mode function
- Measurement speed up to 50 kHz
- Remote sense function
- Built-in battery test function
- OCP and OPP auto test function
- CR-LED function
- Store/recall up to 100 setups
- RS232/USBTMC/GPIB (non-B series only) interfaces
- Analog current control and monitoring
- Adjustable slew rate in CC mode
- OVP/OCP/OPP/OTP and reverse voltage protection

## 1.2 Package Contents

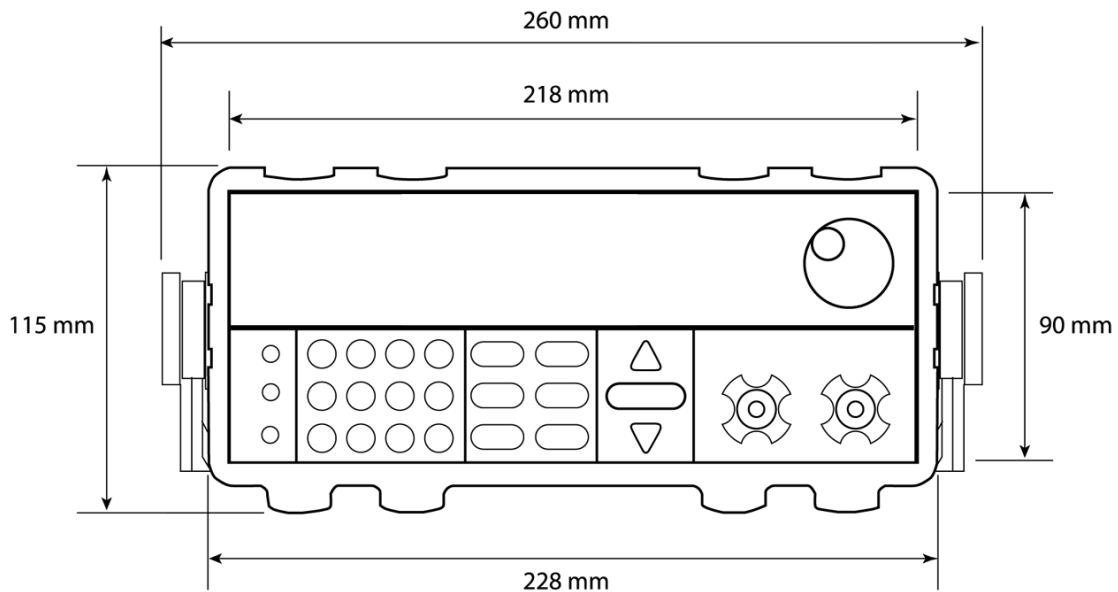
Please inspect the instrument mechanically and electrically upon receiving it. Unpack all items from the shipping carton, and check for any obvious signs of physical damage that may have occurred during transportation. Report any damage to the shipping agent immediately. Save the original packing carton for possible future reshipment. Every instrument is shipped with the following contents:

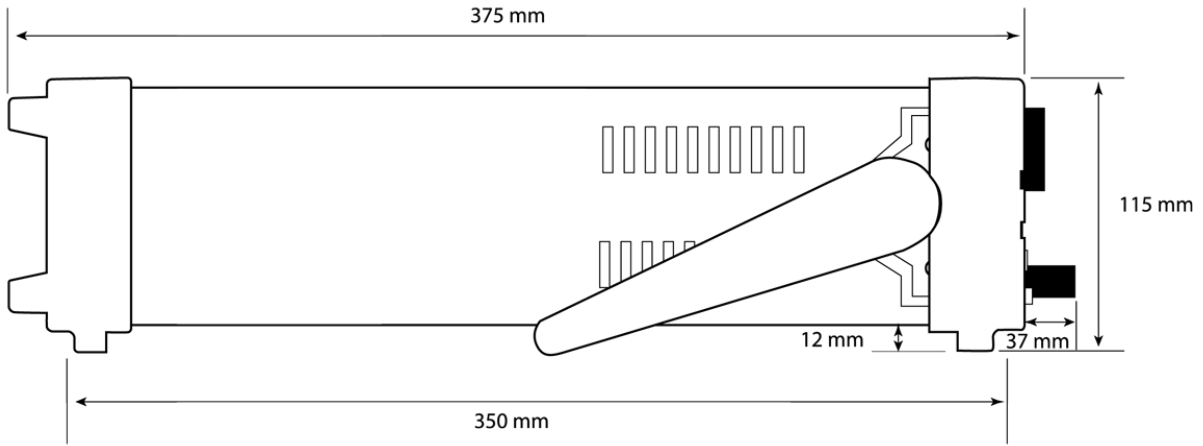
- **1x 8600/B series DC Electronic load**
- **1x AC Power Cord**
- **Certificate of Calibration**

Verify that all items above are included in the shipping container. If anything is missing, please contact B&K Precision.

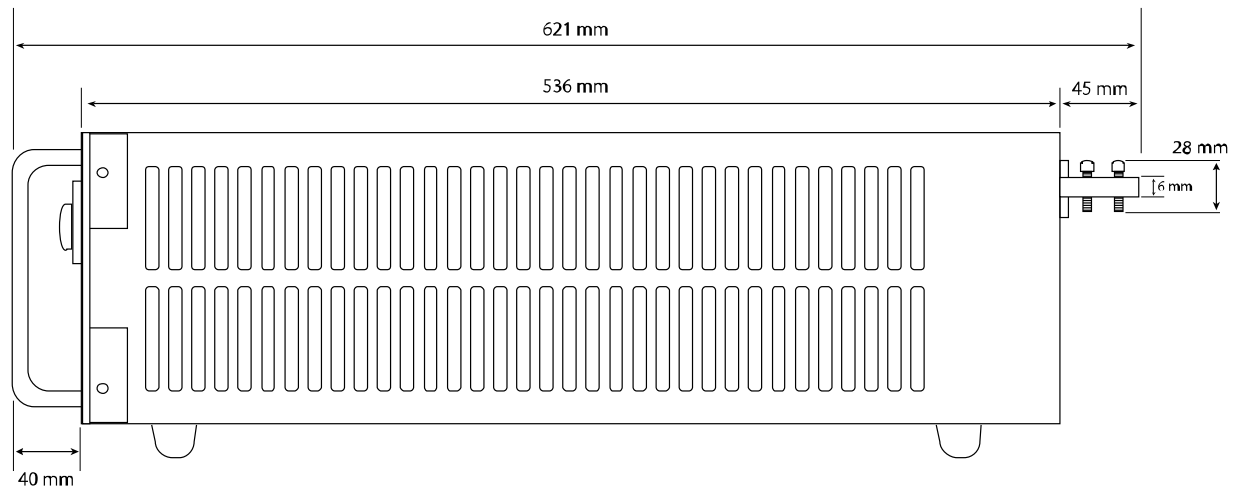
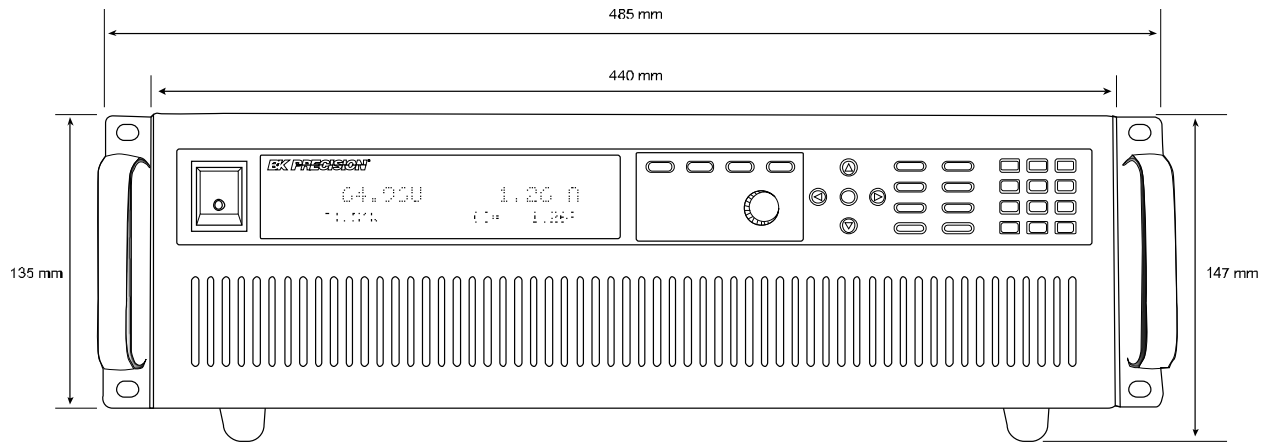
## 1.3 Product Dimensions

All models are designed to fit in a standard 19-inch rackmount. The dimensions are shown in Figure 1 below.



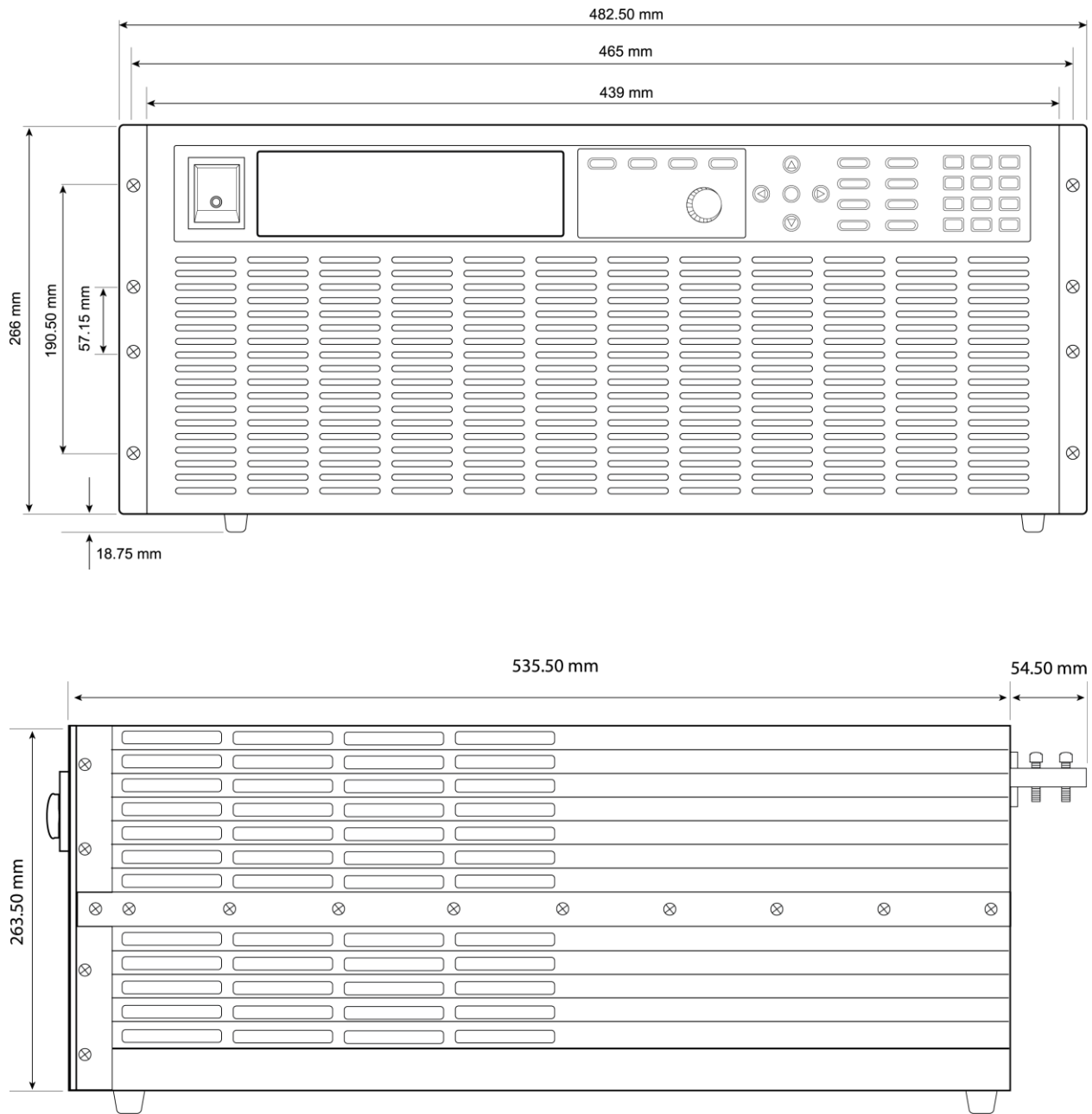


**Figure 1 – Front and Side View (Half-rack models)**



**Figure 2 - Front and Side View (Full-rack 3U models)**





**Figure 3 Front and Side View (Full-rack 6U models)**

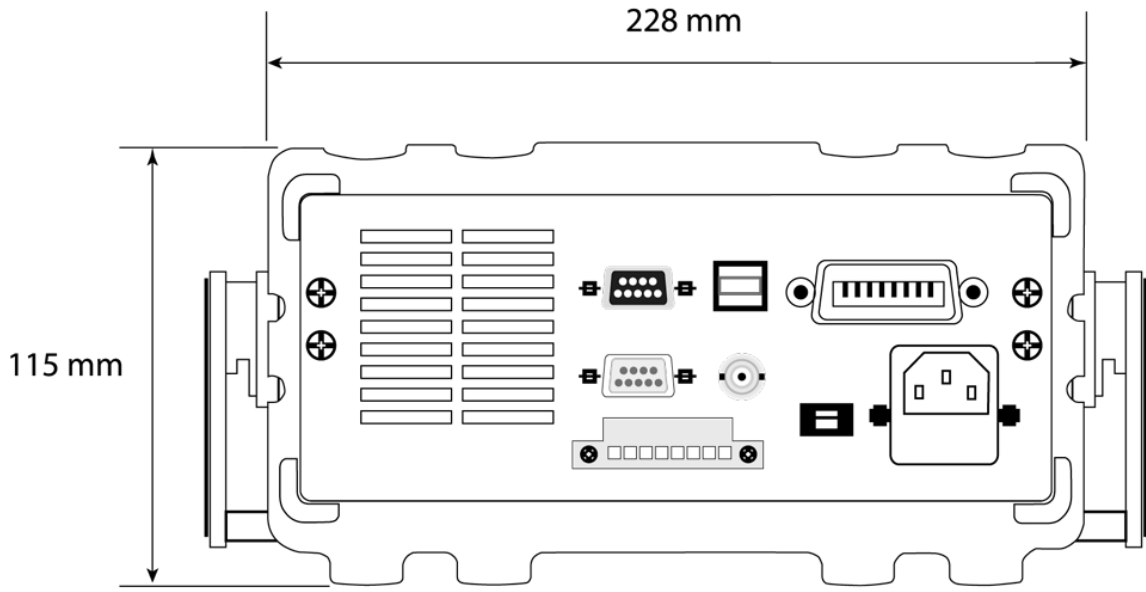


Figure 4 - Rear View (Half-rack models)

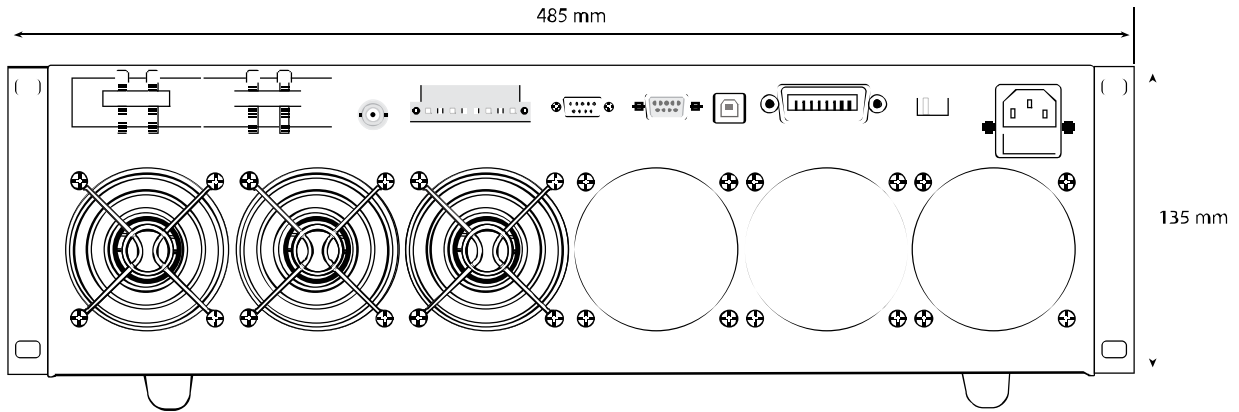


Figure 5 - Rear View (Full-rack 3U models)

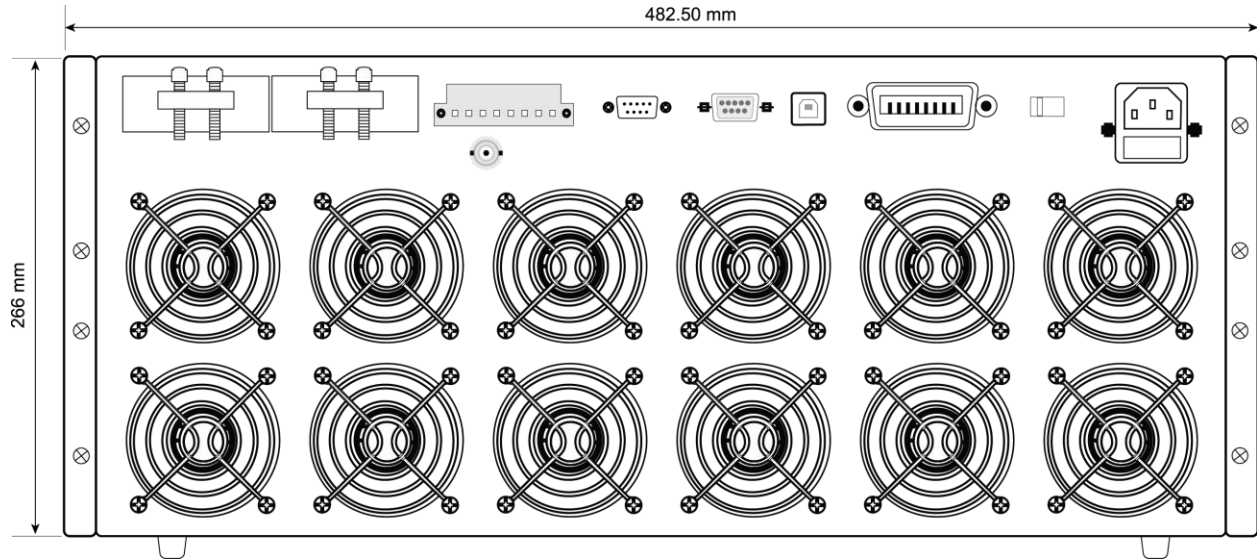
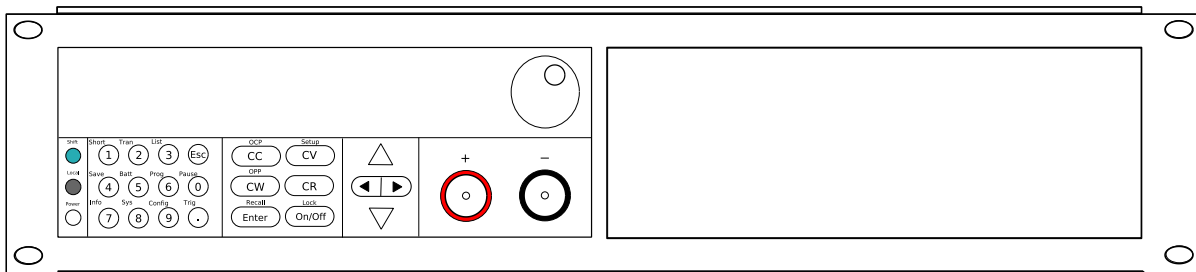
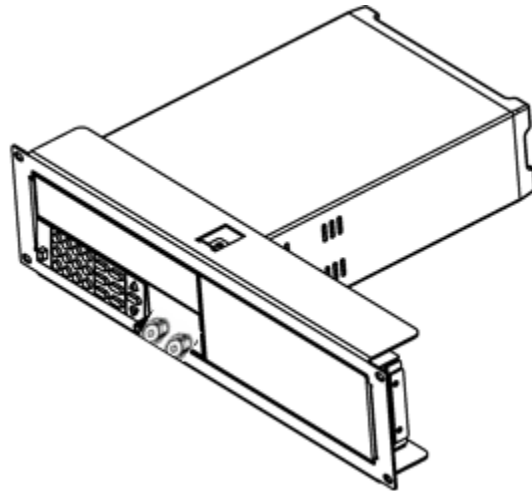


Figure 6 Rear View (Full-rack 6U models)

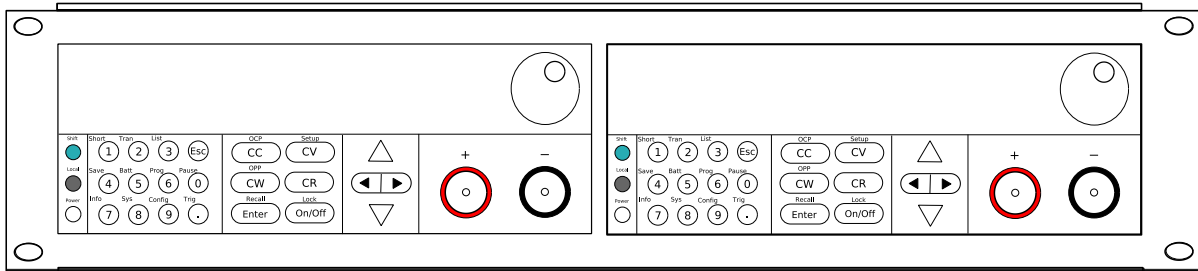
## 1.4 Rackmount Installation

The instrument can be installed in a standard 19 inch rack. For half-rack models, the optional rackmount kit IT-E151 is required (No rackmount kit required for full-rack models). Below is an image of a half-rack model installed with the IT-E151 rackmount kit.





This rackmount kit will allow up to two half-rack models installed side by side, as shown below.



## 1.5 Front Panel Overview

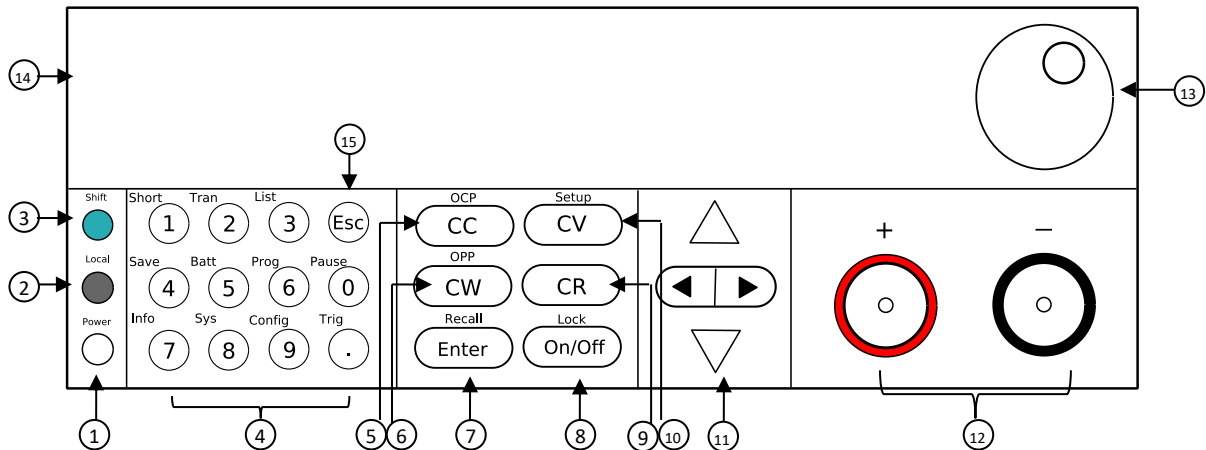


Figure 7 – Front Panel (Half-rack models)

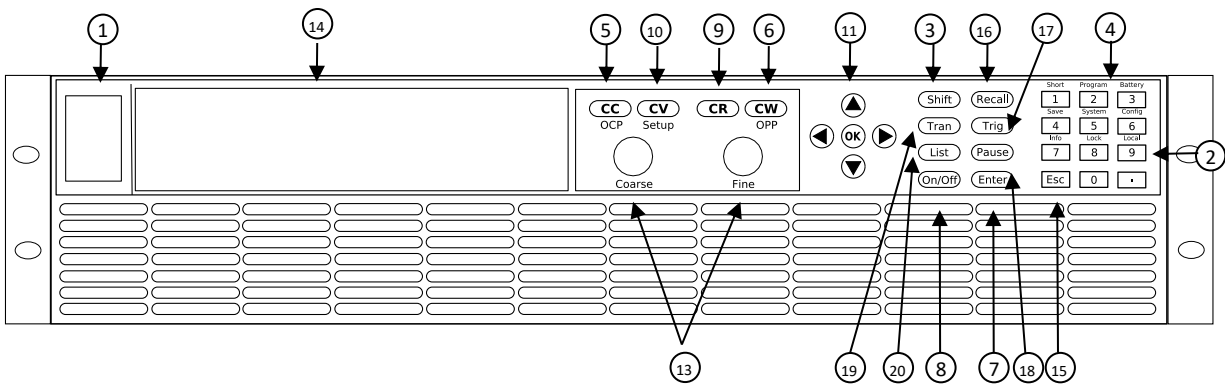


Figure 8 - Front Panel (Full-rack models)

### Front Panel Description

①	Power On/Off switch
②	Local button
③	Shift button
④	Numeric keypad
⑤	CC/OCP button
⑥	CW/OPP button
⑦	Enter/Recall settings button
⑧	Input On/Off and key lock button
⑨	CR button
⑩	CV/Setup button
⑪	Navigation arrow keys
⑫	Input terminal
⑬	Rotary knob
⑭	VFD display
⑮	ESC button
⑯	Recall button (Full-rack models)
⑰	Trig button (Full-rack models)
⑱	Pause button (Full-rack models)

19 Trans button (Full-rack models)

20 List button (Full-rack models)

## 1.6 Rear Panel Overview

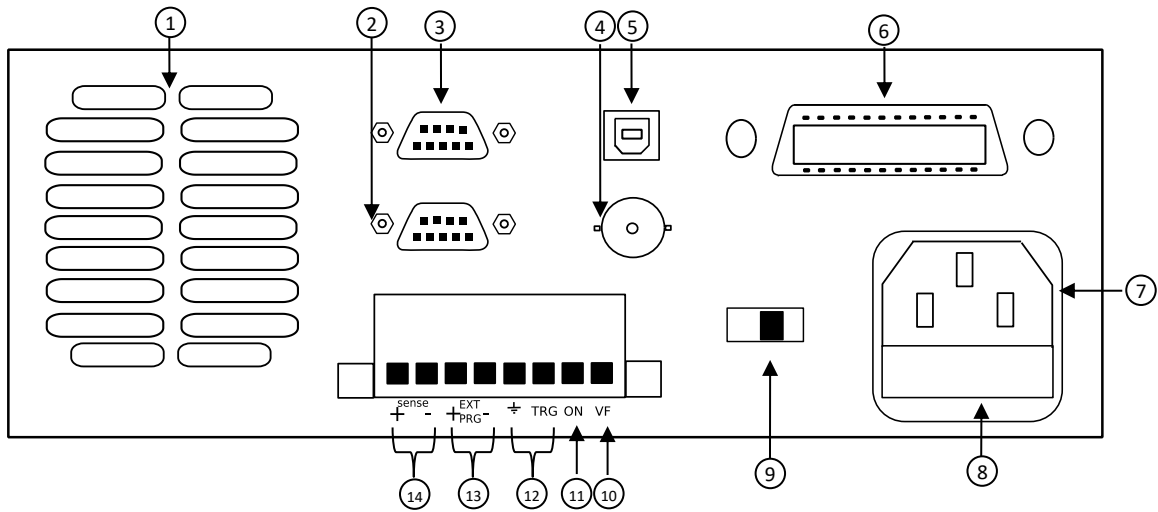


Figure 9 - Rear Panel (Half-rack models)

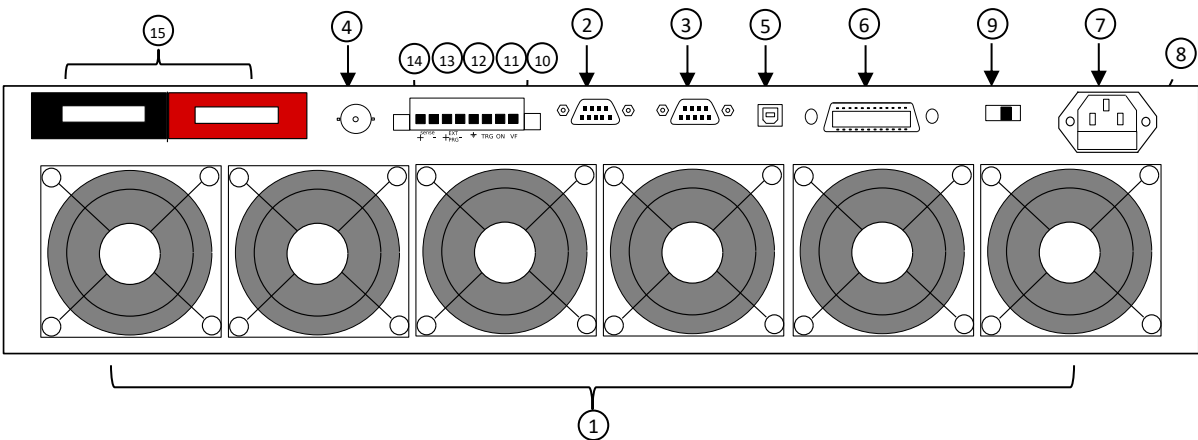


Figure 10 - Rear Panel (Full-rack models)

## Rear Panel Description

①	Cooling fan vent
②	Remote control port (not used)
③	RS232 Interface
④	Current Monitor BNC output
⑤	USB Interface
⑥	GPIB Interface
⑦	AC input receptacle
⑧	Fuse box
⑨	Line voltage selector
⑩	Voltage fault (VF) output terminal
⑪	Input On/Off (ON) control terminal
⑫	External trigger input terminals
⑬	External programming input terminals
⑭	Remote sense terminals
⑮	Input Terminal (Full-rack models)

## 1.7 Display Overview

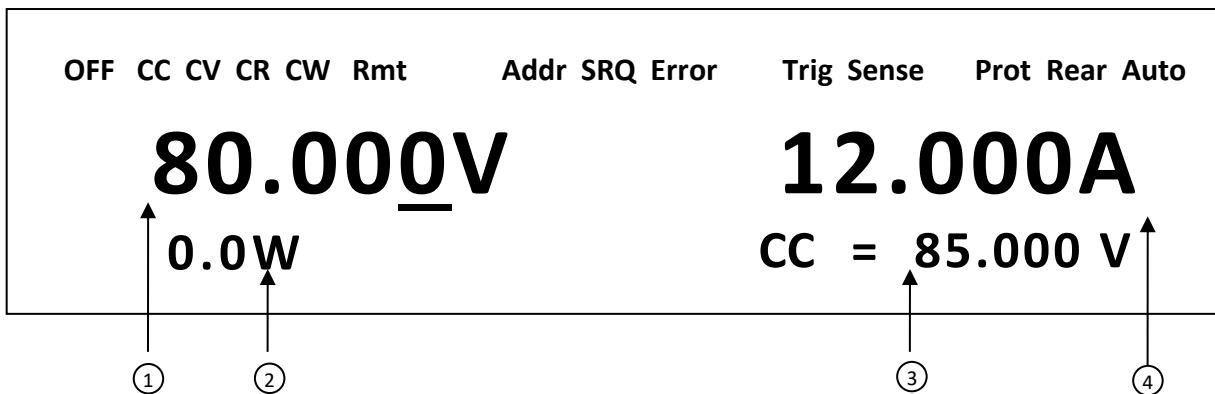


Figure 11 – Display Screen

## ***Display Description***

①	Measured input voltage
②	Measured input power
③	Settings Display <i>Displays parameter settings such as CC, CV, CR, CW</i>
④	Measured input current
<b>OFF</b>	Indicates input is disabled
<b>CC</b>	Indicates constant current (CC) operation
<b>CV</b>	Indicates constant voltage (CV) operation
<b>CR</b>	Indicates constant resistance (CR) operation
<b>CW</b>	Indicates constant power (CW) operation
<b>Rmt</b>	Indicates remote mode
<b>Addr</b>	Indicates remote communication activity
<b>SRQ</b>	SRQ service request indicator
<b>Error</b>	Indicates an error has occurred
<b>Trig</b>	Indicates waiting for trigger
<b>Sense</b>	Indicates remote sense enabled
<b>Prot</b>	Indicates protection trip for over voltage, over power, or over current
<b>Rear</b>	Indicates external analog control is enabled.
<b>Auto</b>	Indicates voltage auto range is enabled.
<b>*</b>	Indicates key lock is enabled
<b>Shift</b>	Indicates shift mode (for access to secondary button functions)



## 2 Getting Started

Before connecting and powering up the instrument, please review and go through the instructions in this chapter.

### 2.1 Input Power and Fuse Requirements

#### ***Input Power***

The load has a selectable AC input that accepts line voltage input within:

Voltage: **115 V (+/-10%) or 230 V (+/- 10 %)**

Frequency: **47 Hz – 63 Hz**

Use the line voltage selector switch in the back to switch between 110 V and 220 V operation.

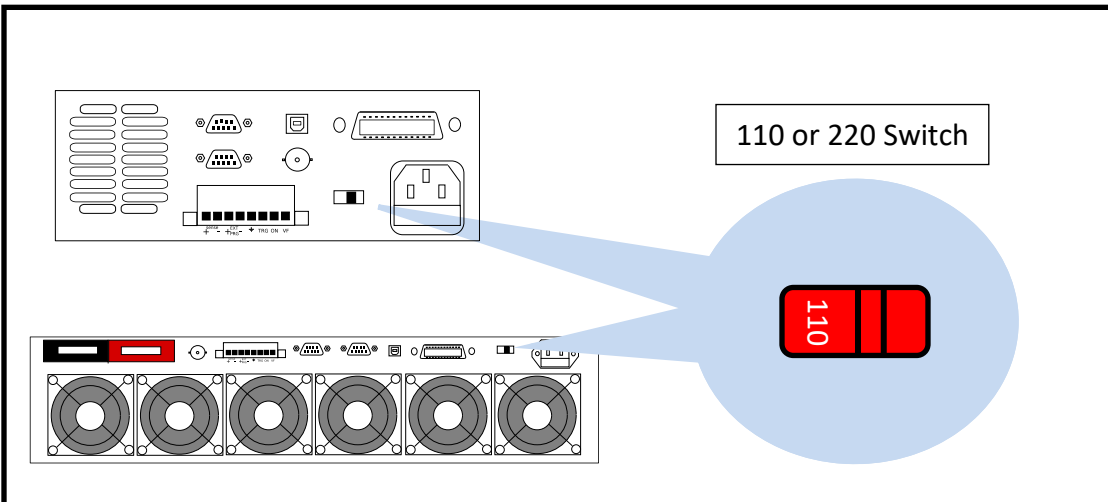


Figure 12 - Line Voltage Switch Location

## **WARNING**

Disconnect all cables including the power cord from the instrument when changing the instrument's line voltage. After changing the line voltage setting, ensure the instrument has fuses of the proper ratings and types for the selected line voltage before applying line power.

### ***Fuse Requirements***

An AC input fuse is necessary when powering the instrument. Below is a table of the fuse required for all models operating with either 110 VAC or 220 VAC input.

**Table 1 - Fuse Requirements**

<b>Model</b>	<b>Fuse Specification (110 VAC)</b>	<b>Fuse Specification (220 VAC)</b>
8600/B	T 1.25 A, 250 V	T 500 mA, 250 V
8601/B	T 1.25 A, 250 V	T 500 mA, 250 V
8602/B	T 1.25 A, 250 V	T 500 mA, 250 V
8610/B	T 3.15 A, 250 V	T 1.6 A, 250 V
8612/B	T 3.15 A, 250 V	T 1.6 A, 250 V
8614/B	T 3.15 A, 250 V	T 1.6 A, 250 V
8616	T 3.15 A, 250 V	T 1.6 A, 250 V
8620	T 3.15 A, 250 V	T 1.6 A, 250 V
8622	T 3.15 A, 250 V	T 1.6 A, 250 V
8624	T 5 A, 250 V	T 2.5 A, 250 V
8625	T 5 A, 250 V	T 2.5 A, 250 V

### ***Fuse Replacement***

Follow the steps below to replace or check the fuse.

1. Locate the fuse box next to the AC input connector in the rear panel.
2. With a small flat blade screwdriver, insert into the fuse box slit to pull and slide out the fuse box as indicated below.
3. Check and replace fuse (if necessary) for the desired line voltage operation.

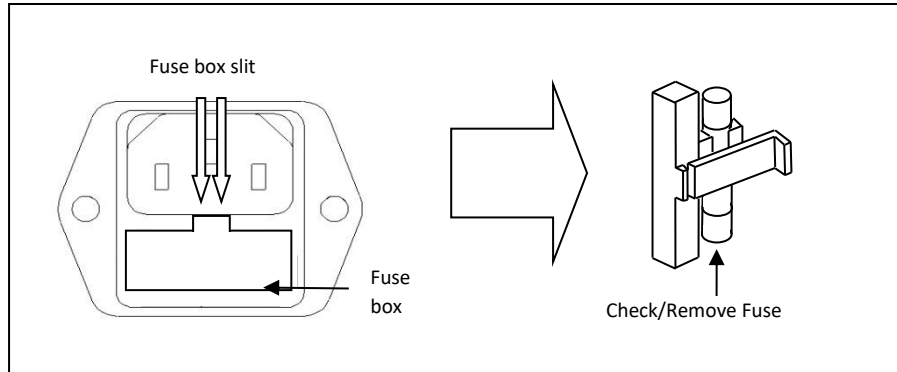


Figure 13 - Fuse Box

## 2.2 Input Connections

The main DC input terminal is a screw type binding post terminal located in the front panel. To loosen, turn the terminal cap counter-clock wise.

**Note:** *The screws on the terminals can be completely removed to allow for ring type adapters (must be greater than 6mm in diameter).*

Due to the high current rating of the DC load, proper wire sizes are necessary for safe connectivity and to prevent wires from overheating.

### **CAUTION**

**Before connecting wires to the input terminals, turn OFF the load to avoid damage to the instrument and the device under test (DUT). For safety, wires must have a wire gauge size large enough to prevent overheating when the load operates at maximum rated current. It will also minimize large voltage drops from resistances in the wires.**

## 2.3 Preliminary Check

Complete the following steps to verify that the load is ready for use.

**1. Verify AC Input Voltage**


Verify and check to make sure proper AC voltages are available to power the instrument. The AC voltage range must meet the acceptable specification as explained in “2.1 Input Power and Fuse Requirements”.



**Check to verify that the unit is configured to operate at the AC input voltage level of the power source. If not, it will damage the unit and void its warranty.**

**2. Connect Power and Self Test**

Connect AC power cord to the AC receptacle in the rear panel and press the power

switch to the  ON position to turn ON the instrument. It will run through a self test procedure with the screen shown below:



### ***Self-test Errors***

The following errors will be displayed if self-test did not complete successfully:




Table 2 - Self-test Messages

Error Message on Display	Description
EEPROM FAILURE	The internal EEPROM is corrupted or damaged.
Config Data Lost	The last operation data within the EEPROM is lost.
Calibration Data Lost	Calibration data within the EEPROM is lost.
FactoryCal.Data Lost	Factory calibration data is lost.
MainframeInitialize Lost	The system settings within the EEPROM is lost.

If any of these errors occur, please contact B&K Precision.




## Input Check

Follow the steps below to check that the load is operating correctly. A DC power supply rated for at least 5V and 1 A will be required to proceed with this check.

1. Power on the load. The display will show the **OFF** annunciator above the voltage display.
2. Connect the input terminal to a DC power supply and configure the supply to output 5 V and current limit to 1 A.
3. Turn on the DC power supply's output. Observe the load's measured voltage display, which should read close to or exactly 5.000V.
4. Press  so that its back light turns on, and enter 0.500 A using the numeric keypad. Press .
5. The display should show **CC = 0.500A** on the bottom right.
6. Press  and its backlight will be lit. The **OFF** indicator will change to **CC** and the measured current should now display a value close to 0.500 A.
7. This setup verifies that the load is drawing power correctly from the power supply.

---




**Note:** If the load is not drawing power from the DC power supply, check all load protection limits and settings within the menu to verify that the load is configured to allow drawing power at 5V, 0.500 A. Also, verify that the CC mode parameters are setup to operate within the configured valid ranges by pressing

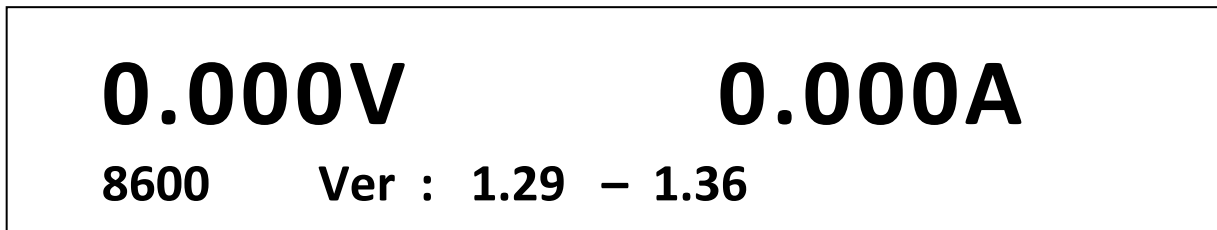
 (  ) and .


---

## Check Model and Firmware Version

The model and firmware version can be verified by using the **\*IDN?** query remote command. It can also be found from the front panel:

1. Press  (  ) and press .
2. The display will show the following:



3. The model is shown above as 8600/B, and the firmware version is shown as 1.29-1.36.
4. Press  once to return to the normal display.

# 3 Front Panel Operation

## 3.1 Menu Options

Most settings and parameters can be configured from the built-in menu systems of the instrument. There are two main menus: System and Config.

### System Menu

To access the system menu, press  (Shift) then  (8)  (5).

The system menu will have the following options:

<b>Initialize</b>	Reset load settings to factory default values.
<b>Power-On</b>	Configure power-on state.
<b>Buzzer</b>	Enable/Disable key sound.
<b>Knob</b>	Controls update method when using knob to control load.
<b>Trigger</b>	Configure Trigger.
<b>Memory</b>	Select memory location for save/recall instrument settings.
<b>Displ (Display)</b>	Enable/Disable load ON timer.
<b>Communication</b>	Select communication interface.
<b>Protocol</b>	Select standard SCPI or extended set of protocols for remote communication.

### Config Menu

To access the system menu, press  (Shift) then  (9)  (6).

The system menu will have the following options:

<b>Von</b>	Configures Von function
<b>Protect</b>	Configures protection parameters and limits
<b>Measure</b>	Configures measurement parameters
<b>CR_LED</b>	Enables/Disables CR LED function
<b>Remote-Sense</b>	Enables/Disables remote sense
<b>Ext-Program</b>	Enables/Disables external analog control

## How to Navigate the Menu

Before using the instrument, it is important to be familiarized with its menu structure and learn how to view or change settings and parameters. Follow the steps below to guide you in selecting menu options.

1. Follow the instructions above to access the System or Config menu.
2. The selected item will be blinking. Use ◀ and ▶ (◀ or ▶) keys to move through the menu selections.
3. When the desired menu section is blinking, press **Enter** to access its menu settings.
4. Below is the display when **SYSTEM** is selected.



5. The selected item will be blinking. Use ◀ and ▶ (◀ or ▶) keys to move through the menu items. When there is a ▶ on the right side of the display, that means there are more menu items available to select from. Similarly, a ◀ will appear on the left side of the display when there are menu items to the left.
6. There may be parameters or options to select within each menu item. Follow the same instructions as described in the previous steps to select them. Some settings can be changed by using ▲ ▼ (▲ or ▼) arrow keys. To save changes to a setting, press **Enter**.
7. To exit the menu at any time, press **Esc**.



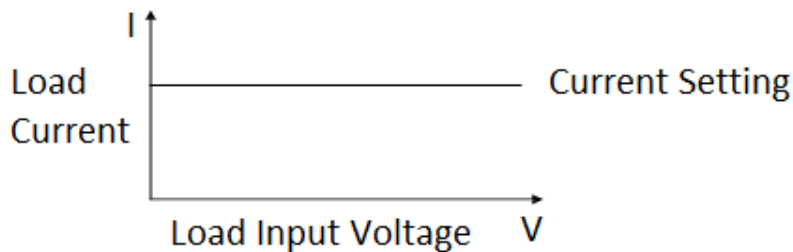
## 3.2 Configure Operation Modes (CC/CV/CR/CW)

The electronic load can work in the following modes:

- 1) Constant current (CC) operation mode
- 2) Constant voltage (CV) operation mode
- 3) Constant resistance (CR) operation mode
- 4) Constant power (CW) operation mode




### **Constant Current (CC) Mode**

In this mode, the electronic load will sink a current in accordance with the programmed value regardless of the input voltage.



### **Configure CC Parameters**

There are several parameters that should be setup prior to operating in CC mode. Press






 so that it lights up, then press  (Shift) and  to access **Setup** for CC mode. The setup menu will be shown:

**Constant Current**

Range=60.000A



The setup parameters are: Range, High (Voltage limit), Low (Voltage limit), and Rise/Fall time.

Use the   ( or ) key to select each parameter, and use the numeric keypad to change the value. Press  to confirm the change.

### Range

Use the numeric keypad to change the range. This value will also act as a limit to how much current the load can be configured to. The adjustable ranges vary depending on the model. See specifications for details.

### High

This parameter refers to the voltage high limit for the automatic test mode. During automatic test mode, the **device under test (DUT)** must be operating below the configured value for the test to PASS upon completion. If the DUT operates above the configured value, the test will FAIL upon completion.

**Note:** This parameter is used for *Automatic Test Function ONLY*.

### Low

This parameter refers to the voltage low limit for the automatic test mode. During automatic test mode, the DUT must be operating above the configured value for the test to PASS upon completion. If the DUT operates below the configured value, the test will FAIL upon completion.

**Note:** This parameter is used for *Automatic Test Function ONLY*.

### High-Rate / Low-Rate

Use the  and  keys to select either **High-Rate** or **Low-Rate**, then press .

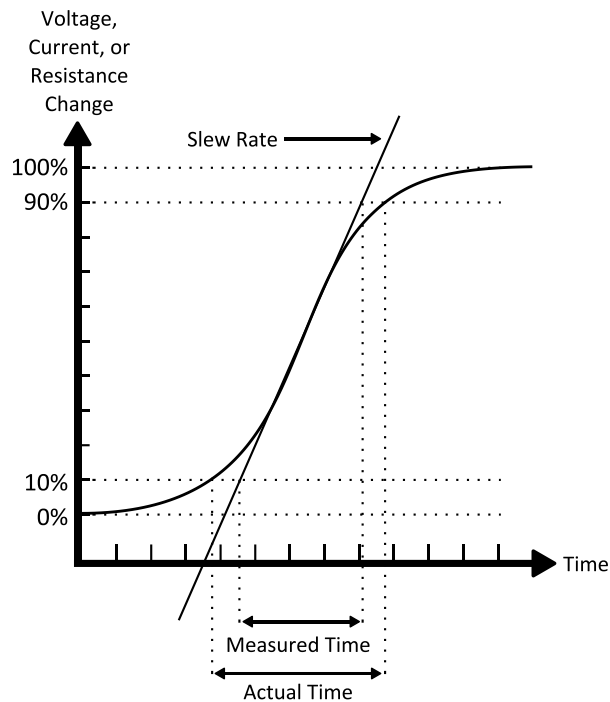
Depending on the selection, the configurable range for the rise and fall times will be different.

### Rise Up / Fall Down

These parameters define the slew rate of the load, which determines the rate at which the input current to a module changes to a new programmed value. You can set the current level's rise/fall slew rate on the front panel or by remote operation. The programmed slew rate is immediately in effect to the triggered and transient current level changes.

## Slew Rate Measurement and Actual Transition time

Current slew rate is defined as the change in current over time. A programmable slew rate allows a controlled transition from one load setting to another. The actual transition time is defined as the time for the input to change from 10% to 90%, or 90% to 10% of the programmed current values. The graph below illustrates slew rate measurements.

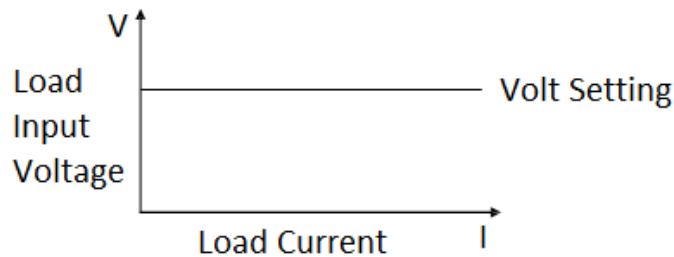


**Figure 14 - Slew Rate Measurement**

Between the 10% and 90% region, the slew rate can be measured by observing the steepest slope portion. In case of very large load changes, e.g. from no load to full load, the actual transition time will be larger than the expected (measured) time. For this reason, the firmware allows the user to program slew rate values outside of the specified slew rate ranges. The minimum transition time for all programmable slew rates is also limited in cases where the transition from one setting to another is very small, due to bandwidth limitations of the load.

## Constant Voltage (CV) Mode

In this mode, the electronic load will attempt to sink enough current to control the source voltage to the programmed value.




### Configure CV Parameters





There are several parameters that should be set up prior to operating in CV mode. Press

 so that it lights up, then press  () and  to access **Setup** for CV mode.

The setup menu will be shown:



The setup parameters are: Range, High (Current limit), and Low (Current limit). Use the 

 ( or ) key to select each parameter, and use the numeric keypad to change the value. Press  to confirm the change.

### Range

Use the numeric keypad to change the range. This value will also act as a limit to how much voltage the load can be configured to. The adjustable ranges vary depending on the model. See specifications for details.

## High

This parameter refers to the current high limit for the automatic test mode. During automatic test mode, the **device under test (DUT)** must be operating below the configured value for the test to PASS upon completion. If the DUT operates above the configured value, the test will FAIL upon completion.

**Note:** This parameter is used for *Automatic Test Function ONLY*.

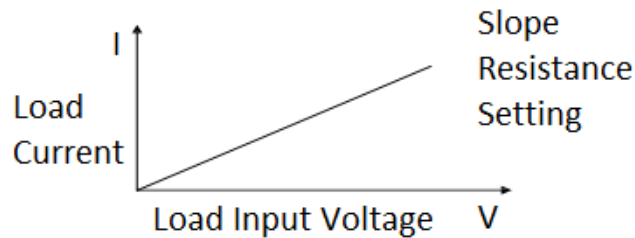
## Low

This parameter refers to the current low limit for the automatic test mode. During automatic test mode, the DUT must be operating above the configured value for the test to PASS upon completion. If the DUT operates below the configured value, the test will FAIL upon completion.

**Note:** This parameter is used for *Automatic Test Function ONLY*.

## ***Constant Resistance (CR) Mode***

In this mode, the electronic load is equivalent to a constant resistance, as shown below. The electronic load will linearly change the current, according to the input voltage.



## **Configure CR Parameters**

There are several parameters that should be set up prior to operating in CR mode. Press

**CR**

so that it lights up, then press



( **Shift** )

and **CV**

to access **Setup** for CR mode.

The setup menu will be shown:

# Constant Resistance

Range=7500.0Ω



The setup parameters are: Range, High (Voltage limit), and Low (Voltage limit). Use the



( or ) key to select each parameter, and use the numeric keypad to change the value. Press to confirm the change.

## Range

Use the numeric keypad to change the range. This value will also act as a limit to how much resistance the load can be configured to. The adjustable ranges vary depending on the model. See specifications for details.

## High

This parameter refers to the voltage high limit for the automatic test mode. During automatic test mode, the **device under test (DUT)** must be operating below the configured value for the test to PASS upon completion. If the DUT operates above the configured value, the test will FAIL upon completion.

**Note:** This parameter is used for *Automatic Test Function* **ONLY**.

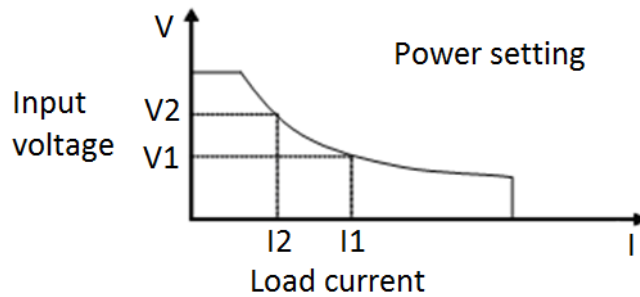
## Low

This parameter refers to the voltage low limit for the automatic test mode. During automatic test mode, the DUT must be operating above the configured value for the test to PASS upon completion. If the DUT operates below the configured value, the test will FAIL upon completion.

**Note:** This parameter is used for *Automatic Test Function* **ONLY**.

## ***Constant Power (CW) Mode***

In this mode, the electronic load will consume a constant power. When input voltage increases, the input current will decrease, while power ( $P = V \cdot I$ ) will remain the same.



### Configure CW Parameters

There are several parameters that should be set up prior to operating in CW mode. Press

OPP  
CW so that it lights up, then press Shift (Shift) and Setup  
CV to access **Setup** for CW mode. The setup menu will be shown:

# Constant Power

Range=250.00W ▼

The setup parameters are: Range, High (Voltage limit), and Low (Voltage limit). Use the ▼  
△ (▲ or ▼) keys to select each parameter, and use the numeric keypad to change the value. Press Enter to confirm the change.

#### Range

Use the numeric keypad to change the range. This value will also act as a limit to how much power the load can be configured to. The adjustable ranges vary depending on the model. See specifications for details.

#### High

This parameter refers to the voltage high limit for the automatic test mode. During automatic test mode, the **device under test (DUT)** must be operating below the configured value for the

test to PASS upon completion. If the DUT operates above the configured value, the test will FAIL upon completion.

**Note:** This parameter is used for *Automatic Test Function* **ONLY**.






## Low

This parameter refers to the voltage low limit for the automatic test mode. During automatic test mode, the DUT must be operating above the configured value for the test to PASS upon completion. If the DUT operates below the configured value, the test will FAIL upon completion.

**Note:** This parameter is used for *Automatic Test Function* **ONLY**.

## Setting CC, CV, CR, CW Mode

Follow the steps below to configure the mode and enable the load.

1. Press  /  /  /  (for CC/CV/CR/CW mode) so that it lights up.
2. Use the numeric keypad or the rotary dial to enter the desired setting value.
3. Use the ◀ and ▶ (◀ or ▶) keys to change the cursor position to adjust different digits.
4. Press  to enable the input.

## 3.3 SYSTEM Menu

All setup procedures and settings explained in this section can be accessed from the **SYSTEM**

menu. To access this menu, press  (Shift) and  (8)  (5).



# SYSTEM MENU

Initialize
Power-ON
Buzzer
▶

***Restore Factory Default Settings***

All instrument settings can be reset back to their factory default values by doing the following:

---

**Note:**

**Restoring the instrument to factory default will change all current instrument settings and parameters back to their default values.**

---

1. From the **SYSTEM** menu, select **Initialize** and press Enter.
2. The following screen will display. Select **Yes** to restore default settings, or **No** to cancel.

# INITIALIZE SYSTEM?

NO
YES

The following table lists some of the factory default settings.

**Table 3 - Factory Default Settings**

Communication	RS232 (4800, 8, N, 1, NONE)
Display On Timer	Off
Trigger Source	Manual
Protocol	SCPI
Von	Latch
A-Limit	Off

Memory	Group 0
Power-On	RST
Buzzer	On
Load On Knob	Update
On Timer	Off
Voltage Auto Range	On
Averaging Filter	2 <sup>14</sup>
Remote Sense	Off
External Program	Off

## ***Configure Power-On State***

The initial Power-On state of the load can be configured by following the steps below:

1. From the **SYSTEM** menu, select **Power-On** and press **Enter** .
2. There are two options:  
**Rst(Def)** – Factory Default.  
**Sav0** – Settings before last power up. Recalls the settings saved to “0” memory location.
3. Select the settings you want during power up, and press **Enter** to save changes.
4. To exit the menu at any time, press **Esc** twice.

## ***Load On Knob***

This setting controls the behavior of the knob.

1. From the **SYSTEM** menu, select **Knob** and press **Enter** .
2. There are two options:  
**Update(default)** – Real time update.  
**Old** – No update (when turning load ON/OFF, original value before use of rotary knob will be set)
3. Select the settings you want during power up and press **Enter** to save changes.
4. To exit the menu at any time, press **Esc** twice.

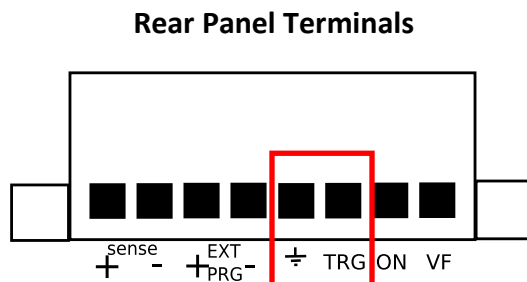
## Configure Trigger Source

The trigger function is used to initiate the start of a program in list mode and also as a toggle for transient mode. The trigger source can be set so that users can send a trigger from the front panel, through a remote command via remote interface or through the external trigger input in the rear panel. Follow the steps below to configure the trigger mode:

1. From the **SYSTEM** menu, browse and select **Trigger** and press **Enter**.
2. Here are the options:  
**Manual(Def)** – Manual trigger. Front panel trigger button is used to send a trigger

(press **Shift** and **Trig** (or press **Trig**) to send trigger).

**External** – External trigger. Trigger can be sent by connecting the **Trig** input and the ground input together in the rear panel. A TTL signal may also be used as a trigger signal when sent across these terminals. If using a TTL signal, the unit triggers off of a falling edge.



---

**NOTE:**

**Signal pulse width must be > 10  $\mu$ s.**


---

**Hold** – Hold trigger. This behaves similarly to **Bus** trigger, however the **TRIG:IMM** command is used instead.

**Bus** – Bus trigger. Remote commands **\*TRG** and **TRIG:IMM** can both be used to send a trigger. With **Bus** trigger, multiple devices can be triggered at the same time when communicating via GPIB (non-B series only) interface.

**Timer** – Timer trigger. A trigger will be sent periodically based on the set time. Time can be set from 0.01 s to 9999.99 s.

3. Select one of the options. For timer trigger, use the numeric keypad or rotary knob to set the time.






4. To exit the menu at any time, press  twice.

## ***Save/Recall Instrument Settings***


The instrument can save up to 100 instrument settings in non-volatile memory. Memory is allocated in 10 different storage groups (group 0 to 9), and each group has 10 memory locations to store settings (0 to 9). These memory locations are referenced by numbers 1 – 100. When saving an instrument setting, numbers 1 to 100 can be selected. However, when recalling an instrument setting, the group must be selected first and then the numeric keypad buttons 1 through 9 and 0, which refers to the 10 locations of the selected storage group. Below is the table illustrating the storage group and allocated memory locations.

**Table 4 - Save/Recall Storage Group**


Storage Group	Corresponding memory locations for save operation
0	1 – 10
1	11 – 20
2	21 – 30
3	31 – 40
4	41 – 50
5	51 – 60
6	61 – 70
7	71 – 80
8	81 – 90
9	91 - 100

When recalling settings, each of the numeric keypad numbers corresponds to the memory locations based on the storage group selected according to the table above. For storage group 0, recalling memory location 1 is done by pressing ; location 2 is done by pressing , and so on. Memory location 10 is recalled by pressing . For storage group 1, recalling memory location 11 by pressing , location 12 by pressing , and so on.



### Example:

Settings are saved to memory location 60. To recall those settings, set storage group to 5 from the menu, then press recall and the number .

### Select Storage Group

1. From the **SYSTEM** menu, browse and select **Memory** and press . The following screen will appear.



2. Use the current adjust knob or the numeric keypad to enter the storage group. Select between **0 – 9**. Press  to save selection.
3. To exit the menu at any time, press  twice.




---

#### **NOTE:**

**The storage group setting also affects the automatic test function of the load. Refer to “Automatic Test Function” for more details.**

---

### Save Settings

1. Set up all the instrument settings that you want to save.
2. Then, press  () and . The display will show the following:

**80.000V**

**12.000A**

**0.00 W**

**Save 1**

3. Use the current adjust knob or the numeric keypad to enter the memory location in which to store current instrument settings. Select between **0 – 100**. Press **Enter** to save to the selection location.




---

**NOTE:**

The “0” memory location is reserved for storing instrument settings last configured before power-off and is used only for power-on state configuration only.

---

### **Recall Settings**

1. First, consider the memory locations you want to recall from. As they are grouped together, select the appropriate storage group from the **SYSTEM** menu first by following the instructions in previous section.
2. Once selected, press  and  (or press  ) and it will light up to indicate the instrument is in **Recall** mode.
3. Use the keypad numbers to recall the settings from the corresponding memory location referenced by the storage group selected in Step 1.
4. Once entered, the saved settings at the location will be immediately recalled.

---

**Note:** When in Recall mode, users can recall settings from different locations without having to press additional keys each time. For example, you can press **1** to recall settings in location one, and then press **5** to recall settings in location 5 on the fly.

---

5. To exit **Recall** mode, press  .

## ***Display Input On Timer***

The instrument has an internal timer that counts how long the input has been enabled (ON). Follow the steps below to enable the timer display.

1. From the **SYSTEM** menu, browse and select **Displ** and press **Enter**. The following screen will appear.





2. Select **On** to enable the timer, and **Off (default)** to disable. Press **Enter** to confirm.
3. Press **Esc** twice to exit the menu. The timer will now be displayed like the following:



4. When input is enabled (ON), the timer will start counting the time. When input is disabled (OFF), the timer will reset itself to a value close to 0 seconds.

## ***Remote Interface Setup***

The instrument has RS232, USBTMC, and GPIB (non-B series only) remote interfaces available for remote communication. Follow the steps below to select and configure each interface.


**Note:** The **RMT** indicator will appear on display when the instrument is successfully connected to a PC remotely through any remote interface. Keys on the front panel will be locked until the instrument is in LOCAL mode. To return to LOCAL mode from the front panel, press  (Shift) and then  <sup>Local</sup> 9 ). The **RMT** indicator will disappear when the instrument is in LOCAL mode.

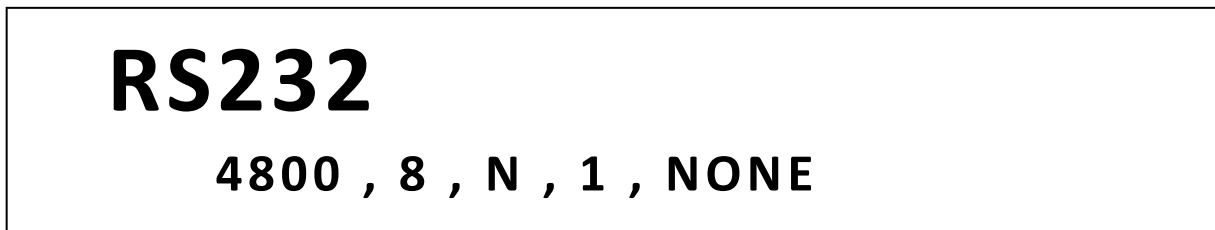
From the **SYSTEM** menu, browse and select **Communication** and press . The following screen will appear.











### RS-232

Follow the steps below to configure the instrument for RS-232 operation:

1. Select **RS-232** and press  to set to RS-232 for remote communication. The following display will be shown:



2. **4800** is the baud rate; **8** is the data bits; **N** is the parity; **1** is the stop bit; **Addr...** is for address.
3. Use the  and  ( or ) keys to select between each serial settings, and use   ( or ) keys to change the settings.
4. The following setting options that can be used:  
**Baudrate: 4800, 9600, 19200, 38400, 57600, 115200\***  
**Data bits: 8**



Parity: N (*None*), E (*Even*), O (*Odd*)  
Stop bit: 1  
Flow control: NONE, CTS/RTS, XON/XOFF

---

**Note:** The default is 4800, 8, N, 1, NONE.

---

**\*Setting the baud rate to 115200 may provide unstable results during remote communication. Select a lower baud rate if communication errors occur.**

5. All serial settings must match with the settings configured on the PC in order for communication to link successfully.

## **USBTMC**

A **USB Type A to Type B cable** (i.e. USB printer cable) is required to connect the USB port in the rear panel to a PC. Follow the steps below to setup the load for remote communication.

1. From the **SYSTEM** menu, browse and select **Communication** and press **Enter** .
2. Select **USBTMC** and press **Enter** to set USBTMC for remote communication.
3. Install the USB driver. For Windows® 7 and 8 users, this may install automatically. For other users, visit [www.bkprecision.com](http://www.bkprecision.com) to download the driver.

---

**Note:** Users who have LabVIEW™ or NI-VISA installed will automatically have this driver in their system. In this case, driver download is not required.

---




## **GPIB (non-B series only)**

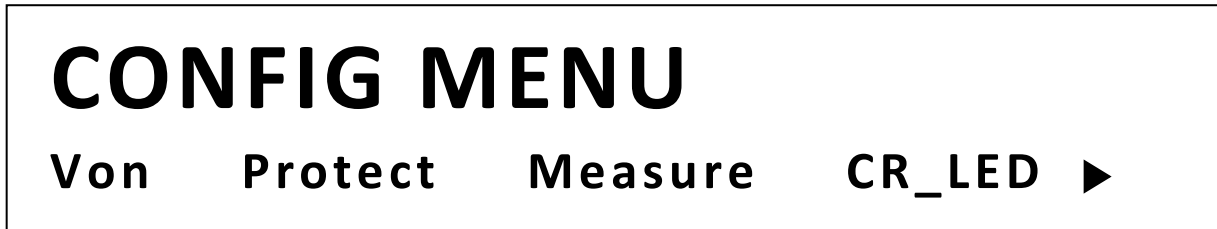
Follow these instructions to select GPIB interface for remote operation.

1. From the **SYSTEM** menu, browse and select **Communication** and press **Enter** .
2. Select **GPIB** and press **Enter** to set to GPIB for remote communication.
3. The load will give a prompt to select an **Address**. This is the GPIB address to which the instrument will be assigned to.
4. Use the current adjust knob or the numeric keypad to enter an address from 0 – 31.
5. Press **Enter** to save the selected address and the display will return to the **Communication** menu.

## 3.4 CONFIG Menu

All setup procedures and settings explained in this section can be accessed from the **CONFIG**

menu. To access this menu, press  (**Shift**) and  (**9**)  (**6**). The following screen will show:



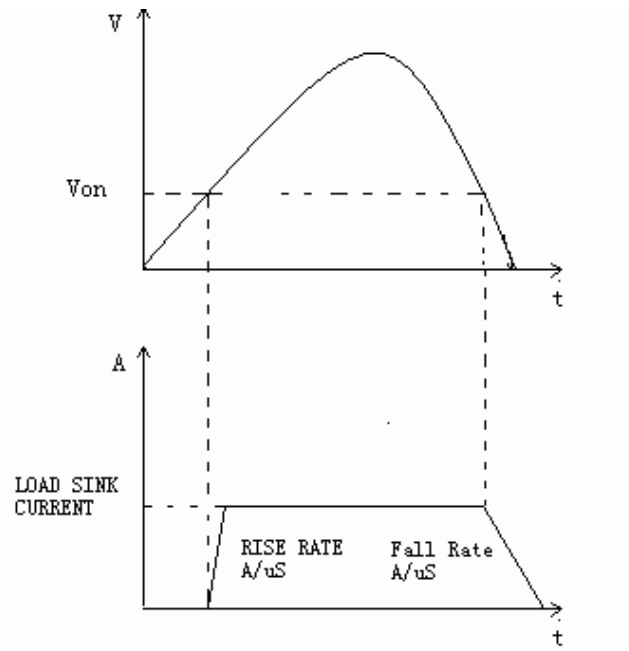
### *Von Operation*

The Von voltage value can be set to control the voltage turn on state for the electronic load. When the input voltage exceeds the Von voltage value, the electronic load's input state turns on.

This function can protect a DUT when its voltage goes below a specified level. For example, when testing a power supply's discharge characteristics, you can set the Von voltage level start and stop discharging of the power supply.

**Note: Von Operation will have a short delay (< 1 s) from when a condition exceeds or goes below a specified level to when the load's input state changes.**

When Von Latch is ON, the electronic load will begin sinking current if input voltage exceeds Von voltage. When the input voltage drops below the Von voltage value, the electronic load will stop sinking current and the input will turn off.



**Figure 15 - The Load's Operating Range with Von Latch set to ON**

When Von Latch is OFF, the electronic load will begin sinking current if the input voltage exceeds the Von voltage. When the input voltage drops below the Von voltage value, the electronic load will still continue sinking current and the input remains on.

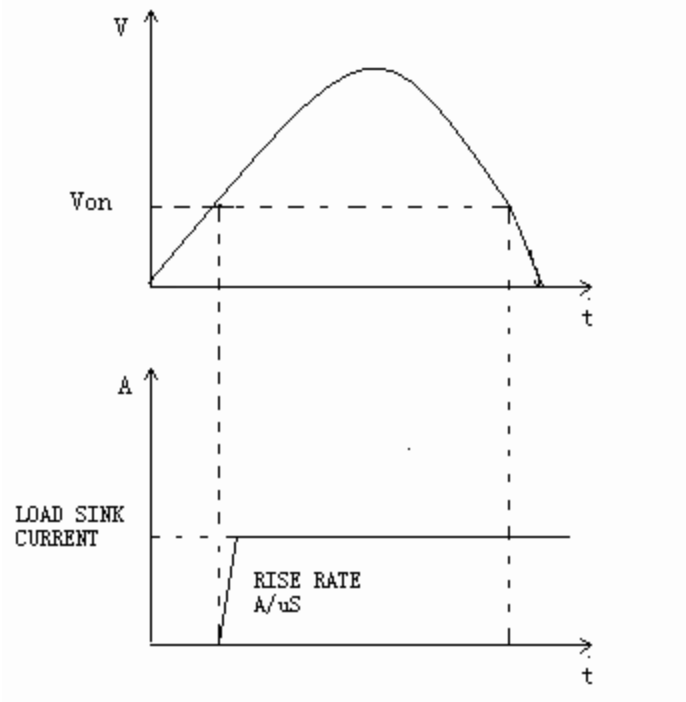


Figure 16 - Von Latch OFF The Load's Operating Range with Von Latch set to OFF

To set the Von modes, from the **CONFIG** menu, select **Von** and press **Enter** . The following will be displayed:

# VON LATCH

On                  Off

Use the **◀** and **▶** (**◀** or **▶**) keys to select between **On** or **Off** and press **Enter** confirm selection. Afterwards, you will be prompted to enter the voltage point of **Von**. Use the numeric keypad or rotary knob to change this value.

## Configure Protection Settings

The electronic load has the following protection functions: Overvoltage protection (OVP), overcurrent protection (OCP), overpower protection (OPP), overtemperature protection (OTP), and local and remote reverse voltage protection (LRV/RRV).

The instrument will act appropriately once any of the above protections are active. You can press any button on the front panel to restore the protection function. For example, if the electronic load triggers the overtemperature protection, the buzzer will alarm, the input will automatically turn off, and the mainframe VFD will display OTP.

Some OCP and OPP features can be configured from within the **Protect** menu. To access this menu, go into **CONFIG** menu and select **Protect**. The following display will show:



### Overcurrent Protection (OCP)

The electronic load includes both hardware and software overcurrent protection features.

**Hardware OCP** - The electronic load's maximum input current will be limited to approximately 110% of the current range. Once the hardware OCP is triggered, the status register's OC bit will be set. When the hardware OCP is removed, the status register's OC bit will be reset. Hardware overcurrent protection will not affect the electronic load's input on/off state.

**Software OCP** - Users can set the electronic load's software OCP value with the following steps.

1. Go to **CONFIG** menu and select **Protect**. Then press .
2. Select **A-limit** and press .
3. To enable software OCP, select **On** and press . The default is **Off**.
4. If enabled (ON), the load will prompt to enter a value for **Point**. Use the numeric keypad or rotary knob to enter the OCP current limit value, then press . The valid range depends on the model of the load.

5. It will then prompt to enter a value for **Delay**. This is the protection trip delay, which is the amount of time to delay from when the input has reached the limit before triggering OCP. Use the numeric keypad or rotary knob to enter a value, then press **Enter** to confirm change. The valid range is 0 – 60 seconds.

---

**NOTE:**

**Software OCP will disable the input if the input current has reached or exceeded the protection limits.**

---

### **Operations to Clear the OCP State**

Check whether the input current is within the electronic load's rated current or the programmed protection current ranges. If it is outside the range, disconnect the device under test. Then press any key on the front panel or remotely send SCPI command PROTECTION:CLEAR. The OCP displayed on the front panel will turn off and the load exits OCP protection state.

### **Overpower Protection (OPP)**

The electronic load includes both hardware and software OPP features.

**Hardware OPP** – In the event that the electronic load's input power exceeds the set power protection limit, the hardware OPP will limit the power. Once the hardware OPP is triggered, the status register's OP bit will be set. When the hardware OPP is removed, the status register's OP bit will be reset. Hardware overpower protection will not turn the electronic load's input off.

Follow the steps below to set the hardware OPP limit.

1. Go to **CONFIG** menu and select **Protect**. Then press **Enter**.
2. Select **Max-P** and press **Enter**.
3. The load will prompt to enter a value for **Point**. This is the hardware OPP limit value. Use the numeric keypad or rotary knob to enter a value. Press **Enter** to confirm the change.

**Software OPP** - Users can set the electronic load's software OPP value with the following steps.

1. Go to **CONFIG** menu and select **Protect**. Then press **Enter**.
2. Select **P-limit** and press **Enter**.
3. To enable software OPP, select **On** and press **Enter**. The default is **Off**.
4. If enabled (ON), the load will prompt to enter a value for **Point**. Use the numeric keypad or rotary knob to enter the OPP power limit value, then press **Enter**. The valid range depends on the model of the load.
5. It will then prompt to enter a value for **Delay**. This is the protection trip delay, which is the amount of time to delay from when the input has reached the limit before triggering OPP. Use the numeric keypad or rotary knob to enter a value, then press **Enter** to confirm change. The valid range is 0 – 60 seconds.

### **Operations to Clear the OPP State**

Check whether the input power is within the rated power range or the programmed protection ranges. If it is outside the range, disconnect the device under test. Then press any key on the front panel or remotely send command PROTection:CLEAr. The OPP displayed on the front panel will turn off and the electronic load exits OPP protection state.

### **Overvoltage Protection (OVP)**

The instrument's maximum OVP limit is 110% of the maximum rated voltage.

If the OVP circuit has triggered, input will turn off, buzzer alarm will go off, and the status register's OV and VF bit will be set. The mainframe will display OVP and the condition will remain until they are reset. Once overvoltage protection occurs, the **VF** pin on the rear panel will output TTL Low voltage level. Under normal conditions, it outputs a 5 V TTL high signal.

### **Operations to Clear the OVP State**

Check whether the input voltage is within the electronic load's rated voltage or the programmed protection voltage ranges. If it is outside the range, please disconnect the device under test. Then press any key on the front panel or remotely send SCPI command PROTection:CLEAr. The OVP displayed on the front panel will turn off and the electronic load exits OVP protection state.

### **Overtemperature Protection (OTP)**

There is an overtemperature protection circuit, which will turn off the input if the internal temperature exceeds safe limits. When the electronic load's internal circuit temperature is over 85°C, the load will enable OTP. Input will automatically be turned off and the VFD will display OTP. At the same time the OT and PS bits in the status register will be set and remain until they are reset.

### **Operations to Clear the OTP State**

When the electronic load temperature has dropped below the protection point, press any key on the front panel or remotely send command PROTECTION:CLEAR. The OTP displayed on the front panel will turn off and the electronic load exits OTP protection state.

### **Reverse Voltage Protection (LRV/RRV)**

This function protects the electronic load in case the input DC voltage lines are connected with the wrong polarity. When a reverse voltage (LRV – local reverse voltage, RRV – remote reverse voltage) connection condition is detected, the input will immediately turn off, the buzzer will alarm the user, and the status register's reverse voltage (LRV/RRV) and VF bits will be set. The load will display LRV/RRV until they are reset.

In this condition, the VF pin will output a low level.

### **Operations to Clear the Reverse Voltage State**

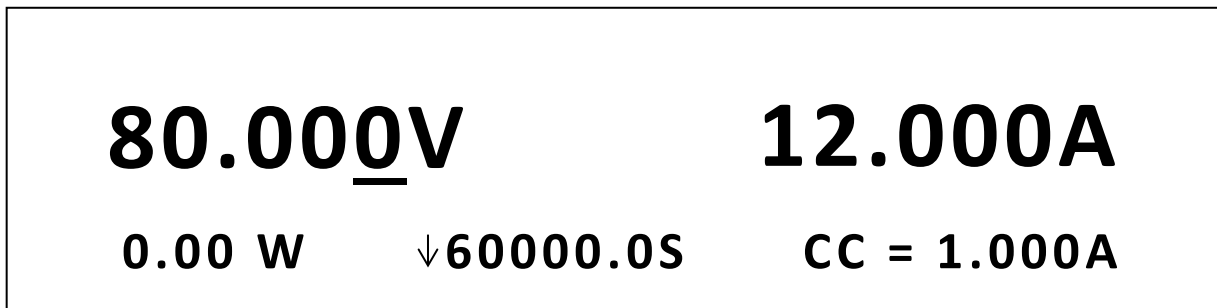
Check whether the connection is reversed. If so, disconnect the device to be measured and the reverse voltage state will be cleared.



## Configure Timed Input

The load has a built-in timer function that can be configured to allow enabling (ON) the main input for a specified amount of time. To configure this time, follow the steps below:

1. Go to **CONFIG** menu and select **Protect**. Then press **Enter**.
2. Select **Time** and press **Enter**.
3. To enable timed input, select **On** and press **Enter**. The default is **Off**.
4. It will then prompt to enter a value for **Delay**. This is the amount of time to enable the input from when the **On/Off** is pressed (or when input is turned ON remotely). Once this time is past, input will be disabled (OFF). Use the numeric keypad or rotary knob to enter the value. Press **Enter** to confirm the change. The valid range is 0 – 60000 seconds.
5. Now, press **Esc** twice to exit the menu. The instrument will show the delay timer as follows:



## Measurement Configurations

### Voltage Auto Range

By default, the load has auto range enabled for voltage measurements and operations. To enable or disable, follow the steps below:

1. Go to **CONFIG** menu and select **Measure** and press **Enter**.
2. Select **V-Range** and press **Enter**.

3. To enable voltage auto range, select **On** and press **Enter** . To disable, select **Off** and press **Enter** to confirm the change.

### **Measuring Rise and Fall Time**

The instrument can measure the rise or fall time from a specified start and stop voltage level of the measured input. This feature requires the display timer to be enabled first. To enable timer, please follow the instructions in the “Display Input On Timer” section of “3.3 SYSTEM Menu”.

To setup this measurement, follow the steps below:

1. Go to **CONFIG** menu and select **Measure**. Then press **Enter** .
2. Select **TimeV1** and press **Enter** . The load will prompt to enter a value. Use the numeric keypad or rotary knob to set a value and press **Enter** to confirm. This is for the start voltage level. When the measured input voltage reaches this level, the timer will start.
3. Now, select **TimeV2** from the **Measure** menu and press **Enter** . The load will prompt to enter a value. Use the numeric keypad or rotary knob to set a value and press **Enter** to confirm. This is for the stop voltage level. When the measured input voltage reaches this level, the timer will stop. The time on display will show the time difference between the measured start and stop voltage level.

### **Measurement Averaging Filter**

The measurement averaging filter can be adjusted. Increasing the averaging will provide more accurate readings, but slower measurement update rate. Decreasing the averaging will provide faster measurement update rate, but less accurate readings.

To configure, follow the steps below:

4. Go to **CONFIG** menu and select **Measure**. Then press **Enter** .
5. Select **Filter** and press **Enter** . The load will prompt to enter a value for **Average Count**.
6. Use the numeric keypad or rotary knob to adjust this value, then press **Enter** to save the change. The valid range is from **2 – 16** ( $2^2 - 2^{16}$ ). The default is 14 ( $2^{14}$ ).

## CR LED Function

CR LED is a function that allows the instrument to simulate the loading behavior of typical LEDs, which can be used for testing LED drivers. When the function is enabled, the load allows the user to configure the LED's operating resistance and forward voltage along with the voltage range (same as CR operation). Below illustrates the V-I characteristics curve of a typical LED.

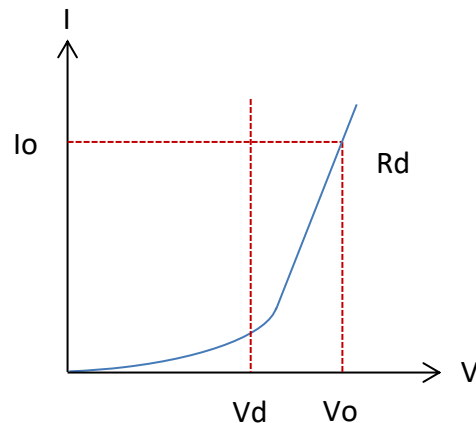


Figure 17 - CR LED IV Characteristics Curve










Vd = Forward voltage of the LED

Rd = LED's operating resistance

Vo = Operating voltage across the LED

Io = Operating current across the LED

To configure CR LED function, follow the steps below:

1. Press  (Shift) and  (9) ( 6) to access the **CONFIG** menu.
2. Select **CR\_LED** and press .
3. Select **On** and press . Press  to exit the **CONFIG** menu.
4. Press  to enter CR operation, then press  (Shift) and  CV to access CR mode settings.

- Use the numeric keypad or rotary knob to enter the values for **Range**, **Voltage High**, **Voltage Low**, and **Vd**. **Vd** will be the forward voltage of the LED you want to simulate. This option will only appear after **CR\_LED** has been enabled from the **CONFIG** menu.
- While in CR mode, use the numeric keypad or rotary knob to enter a value for **Rd**, the resistance.
- Now that both **Vd** and **Rd** are configured, turn ON the input by pressing **On/Off**.

## Remote Sense

Remote sense can be used to compensate for voltage drops (up to 1 V) due to resistance from test leads connected to your device under test (DUT), thus providing more accurate voltage measurement. The instrument is setup with remote sense disabled by default.

To enable and use remote sense, follow the steps below:

- Power OFF the load and disconnect all leads/cables connected to it.
- Connect the sense terminals in the rear panel to the DUT source terminals.
- Then, connect the DUT source terminals to the load's main input terminals. The setup should look like the figure below:

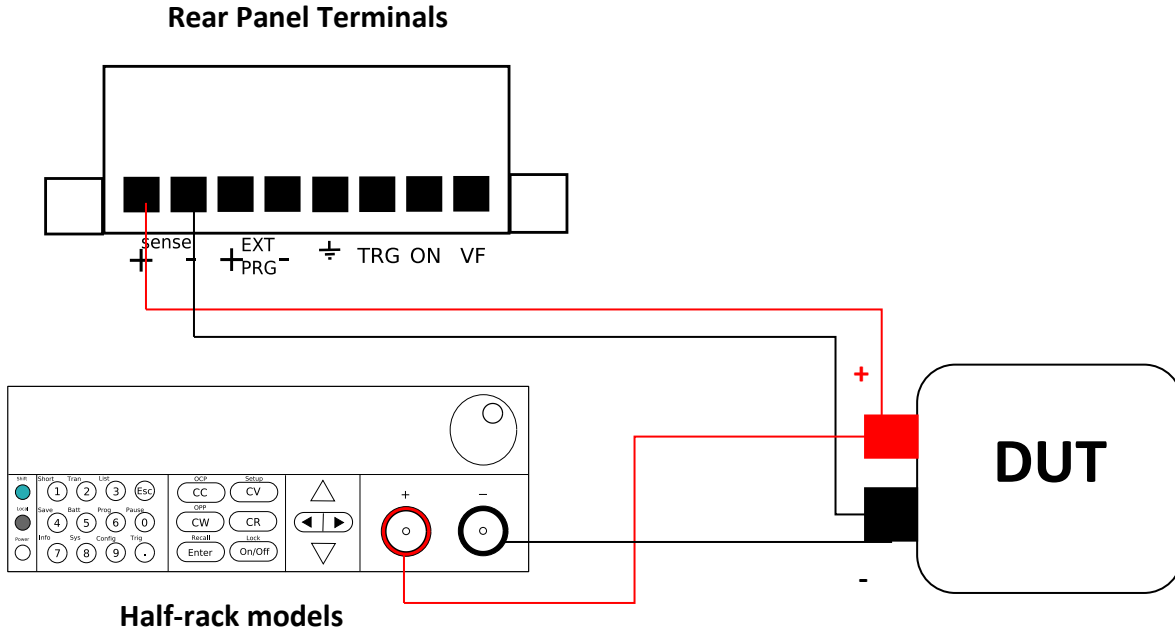
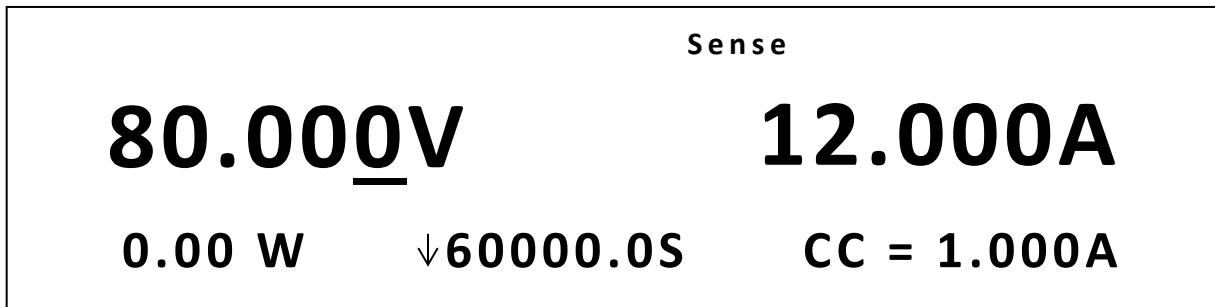


Figure 18 - Remote Sense Connection Setup

7. To enable remote sense, go to **CONFIG** menu and select **Remote-Sense** and press **Enter**.
8. Select **On** to enable or **Off** to disable remote sense. The default is **Off**.
9. Once it is turned on, the **Sense** annunciator will appear at the top of the display.



## CAUTION

The electric potential on the positive terminal of Sense+ connector must be higher than the negative terminal.

## *External Analog Control and Monitor*

### External Current Control

You can control the current setting of the electronic load in CC mode using the external analog programming terminals labeled **EXT PRG**. A 0-10 V input signal will simulate 0 – full scale of the electronic load to regulate the input current of the electronic load (10V indicates the full range of electronic load’s current rating).

To configure this function, follow the steps below:

1. Go to **CONFIG** menu and select **Ext-Program** and press **Enter**.
2. Select **On** to enable external analog control. Then press **Enter** to confirm. To disable, select **Off** and press **Enter**.
3. The **Rear** annunciator will appear on the front panel once external analog control is enabled.

- Connect the external analog control pins from the rear panel of the instrument to your voltage control source as shown below:

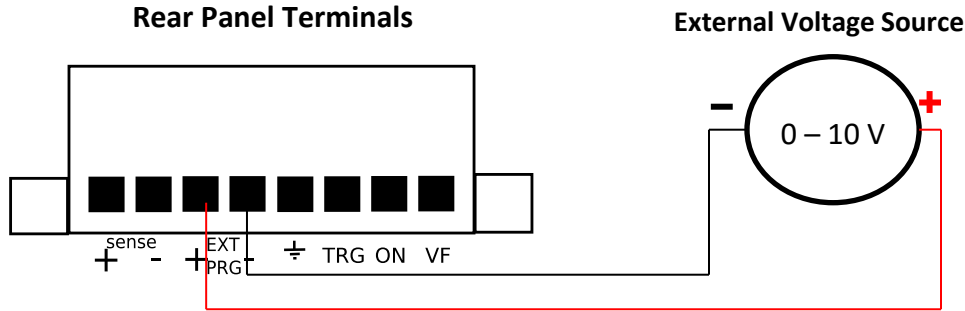


Figure 19 - Analog Control Setup

- Set the instrument to CC mode and enable the input to begin controlling with the external voltage source.

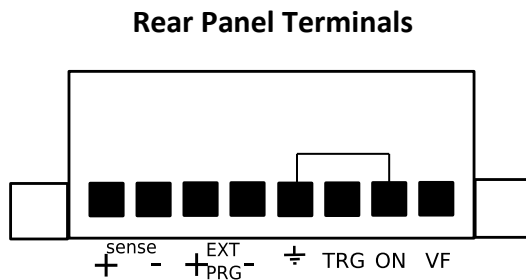
## ⚠ CAUTION

Do not connect more than 30 V into the external program terminal pins or damages may occur.

### External Input On/Off Control

The electronic load's input can be enabled (ON) or disabled (OFF) via the external control pins labeled **ON** and ground pin (  $\text{⏏}$  ).

**Enable (ON) input:** Short the two pins together, as shown below:



**Disable (OFF) input:** Disconnect the short between the two pins.

---

**Note:** The external analog control does not have to be turned ON from the menu for these pins to function as intended. To avoid accidentally turning ON the load's input, keep these pins opened with nothing connected when external On/Off control is not used or needed.

---

### **Voltage Fault Indicator**

The terminal pin labeled **VF** in the rear panel outputs a 5 VDC signal under normal operations. When OVP, LRV, or RRV conditions occur, the pin will output 0 VDC to indicate the protection trip.

### **Current Monitor**

The rear panel has a BNC output labeled **I Monitor** for current monitoring. It will output a 0-10 V analog signal which reflects 0 - full range of the input current accordingly. You can connect an external voltmeter or an oscilloscope to display the input current's change.

## **3.5 Short Operation**

The electronic load can simulate a short circuit at its input. During front panel operation, press



( Shift )

Short



to switch the short on/off state. Short operation will not affect the present setting. When turning off the short state, the load returns to the original set state.

The actual value of the electronic load in short operation depends on the mode and range that is active when the short is turned on. In CC or CR mode, the maximum short current is typically 110% of the current range. In CV mode, short means setting the load's constant voltage to be 0 V. In short operation mode, you can measure the maximum short current ( $A_{max}$ ) or DC current (ADC) of the power source to be measured. You can set this function via the Configuration menu.

## 3.6 Transient Operation

Transient operation enables the module to periodically switch between two load levels, as might be required for testing power supplies or other DC sources. There are three different transient testing modes: continuous, pulse, and toggle.

Continuous	Generates a respective pulse stream that toggles between two load levels.
Pulse	Generates a load change that returns to its original state after some time period.
Toggle	Generates a repetitive pulse stream that toggles between two load levels. It is similar to continuous mode except that the transient points are controlled by explicit triggers instead of an internal transient generator.

### ***Continuous***

In this mode, the electronic load generates a repetitive pulse stream that toggles between two load levels. Load could switch the state between two value settings, value A and value B.

In CC mode, transient testing can be used to check the stability of the source voltage. Transient functions have two current levels (A level, B level), which should be in the same range (high range or low range). You can set the frequency as well as the duty cycle, which will affect the timing and width of each level.

The slew rate determines the rate at which the level changes. Upon receiving a trigger, and the load will continuously switch between the A/B levels preset. Transient loads are usually used to test the power supply's performance under continuous changing load conditions. Figure 20 shows the current waveform of continuous transient operation mode.



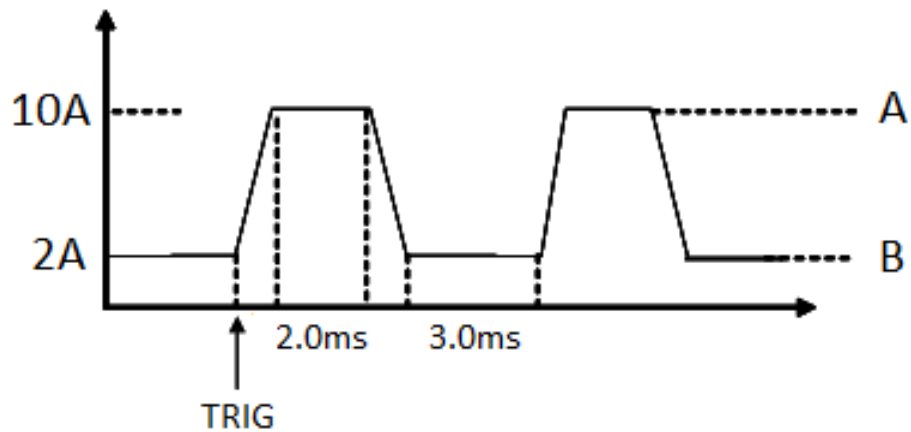


Figure 20 - Continuous Transient Operation Current Waveform

### ***Pulse***

In this mode, the electronic load generates a transient pulse of programmable width when pulse transient operation is in effect.

In pulse mode, you can set A/B level, the pulse width, and A/B slew rate. The electronic load will automatically switch to A level after maintaining A width time. Then it will switch to B level. The electronic load will not switch to A level again until the instrument receives a trigger signal. The following figure shows the current waveform in pulse transient operation.

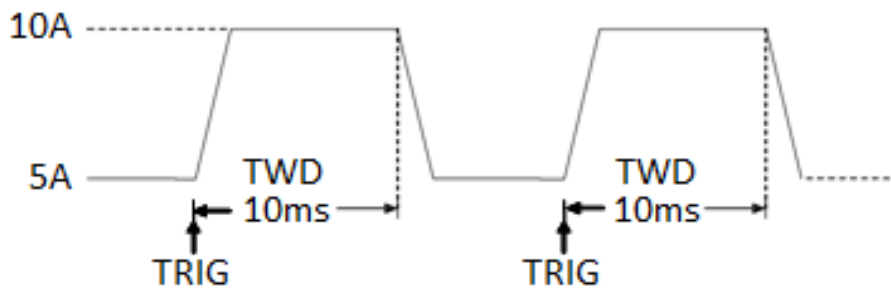


Figure 21 - Pulse Transient Operation

### ***Toggle***

In toggle mode, the electronic load will switch between A level and B level when receiving a trigger signal. The following picture shows the current waveform in toggle transient operation.



Figure 22 - Toggle Transient Operation

To enable and setup transient mode, follow the steps below:

1. First, select the load's mode of operation, which will determine which type of transient

operation will be configured. Press    or  to select between CC, CV, CW, or CR mode. Verify the selection by the backlight behind its corresponding button, which will be lit when selected.

2. From the front panel, press  and then  (or press ). The following display will show:



3. To enable transient operation, select **On** and press . The following display will show:

# TRANSITION


**Continuous      Pulse      Toggle**

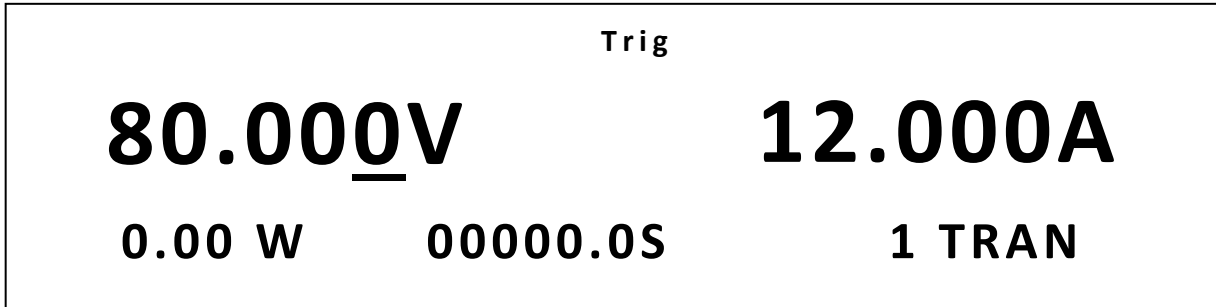
4. Select the transient mode **Continuous**, **Pulse**, or **Toggle**. Press **Enter**.
5. For CC mode, the following display will show. For all other modes, skip to step 9.





# TRANSITION

**High-Rate                      Low-Rate**

6. Select either **High-Rate** or **Low-Rate**. These options configure the settable slew rate range. If **High-Rate** is selected, users can adjust the slew rate of the transient in the A/us range. If **Low-Rate** is selected, users can adjust the same in A/ms range. The settable range will vary depending on the model.
7. The load will then prompt to enter a value for **Rise Up**, which is the slew rate for a rising transition between the two levels of the transient. Use the numeric keypad or rotary knob to set the value, then press **Enter** to confirm.
8. The load will then prompt to enter a value for **Fall Down**, which is the slew rate for the falling transition between the two levels of the transient. Use the numeric keypad or rotary knob to set the value, then press **Enter** to confirm.
9. The load will then prompt to enter a value for **Level A**. This is one of the two load levels for transient operation, and as such will be labeled as level A. Enter a value within the load's full range, then press **Enter**. The next prompt will ask to enter a value for **Level B**, which is the other load level for transient operation. Enter a value and press **Enter**.
10. For **Continuous** mode: The load will prompt to enter the transient's **Frequency**. Enter a value and press **Enter**. It will then prompt to enter the **Duty** cycle. Enter a value between **0.01% and 99.99%**.  
  
For **Pulse** mode: The load will prompt to enter the **Pulse Width**. Enter a value, then press **Enter**.

11. The load will return to the **Transient** menu. Press  to return to the normal display. The **Trig** annunciator will appear and the display will look like below.








12. Depending on the selected **Trigger Source** from within the **SYSTEM** menu, the operation may start immediately.
13. To run the transient operation, first press  to enable the input. Then, send a trigger to start the operation. If **Trigger Source** is set to **Manual**, press  and then  (or press  ) to send a trigger. Refer to “Configure Trigger Source” in section “3.3 SYSTEM Menu” to configure the **Trigger Source**.

---

**Note:** The number next to **TRAN** on display will count each transition. It can only count up to 65535 transitions, after which it will reset to 0 and start over.

---

14. To disable transient operation, first press  to disable the input. Then, press  and  (or press  ). Select **Off** and press  to confirm.

## 3.7 List Operation

List mode lets you generate complex sequences of input changes with rapid, precise timing. This is useful when running test sequences with a minimum amount of overhead.

The parameters of List operation include the name, number of steps (2-84), step width time (20us-3600s), and every steps' set value and slew rate. The list file can be saved in non-volatile memory where it can be quickly recalled. Users can edit up to 7 groups of List files in CC mode only.

In List operation mode, the electronic load begins to enable the List operation when it receives the trigger signal and will continue until the List operation is completed or the instrument receives another trigger signal.

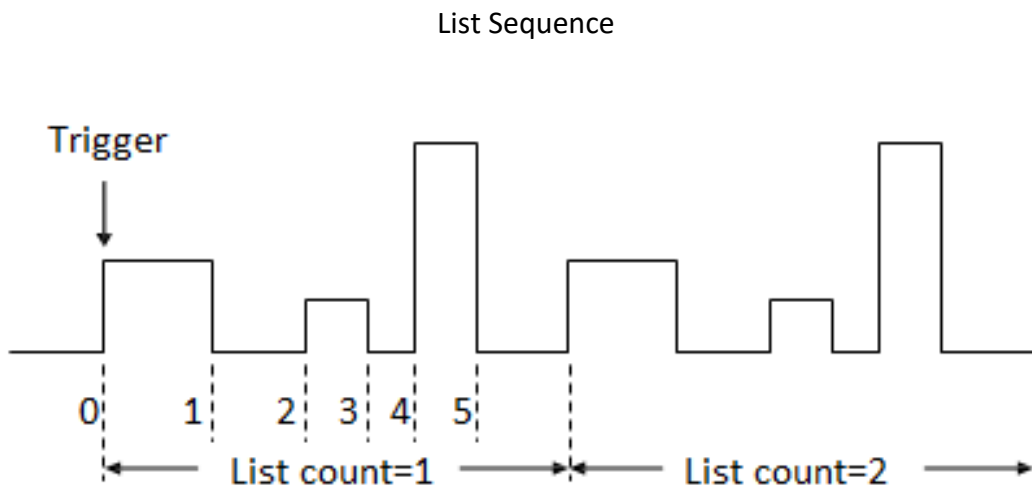






Figure 23 - List Mode Current Waveform

## Configure List



Follow the steps below to configure list operation:

1. From the front panel, press  and then  (or press  ). The following display will show:



2. Select **Edit** and press  . The following display will show:



3. Select either **High-Rate** or **Low-Rate**. These options configure the settable slew rate range. If **High-Rate** is selected, users can adjust the slew rate of the transient in the A/us range. If **Low-Rate** is selected, users can adjust the same in A/ms range. The settable range will vary depending on the model.
4. The load will then prompt to enter a value for **Current Range**. Use the numeric keypad or rotary knob to set the value for current range, then press  to confirm.
5. The load will then prompt to enter a value for **File Step**, which is the total number of steps for the list. Use the numeric keypad or rotary knob to set the value, then press  to confirm. Valid range is **2 – 84**.
6. The load will prompt to enter values for each steps parameters, starting with the step level. Use the numeric keypad or rotary knob to enter a value.

# EDIT LIST

Step 001 Level = 0.0000A

7. Press  and it will prompt to enter the slew rate of the step. If **High-Rate** was selected earlier, units will be in **A/us**. Otherwise, it will be in **A/ms**.

# EDIT LIST

Step 001 Rate = 0.0001A/us

8. Press  and it will prompt to enter the step with. Valid range is **20 us – 3600 s**. Enter a value and then press  to continue.

# EDIT LIST

Step 001 Width = 0.00002S

9. The load will prompt to enter parameters for the next step. Follow steps 6-8 to enter the values for the step's parameters. Once all steps' parameters are entered, the load will prompt for the **Repeat Count**, which sets how many times to repeat the list program. Valid range is **1 – 65535**. Press  to continue.
10. The load will prompt to select the memory location to store the list parameter information. There are seven total save locations. Enter a value between **1** and **7**, then press  to confirm. The display will return to the **List** menu.

---

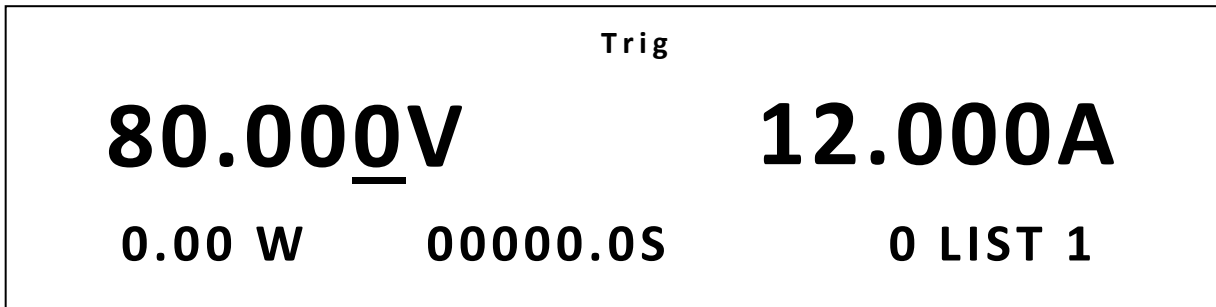
**Note:** If **List** mode is enabled, the **Edit** menu will be locked and list parameters cannot be changed until **List** mode is disabled.

---

## Run List

To run a list, follow the steps below:

1. From the **List** menu, select **Recall** and press **Enter**. The load will prompt for the memory location of the list to recall. Enter between **1 – 7** and press **Enter** to recall.
2. Then, select **On** and press **Enter**. The **Trig** annunciator will appear, and the **On** selection will become **Off**.
3. Press **Esc** to go back to the normal display, which will then look like the following:



4. Press **On/Off** to enable (ON) the load's input, and send a trigger to initiate the start of the list program.
5. If **Trigger Source** is set to **Manual**, press **Shift** and then **Trig** (or press **Trig**) to send a trigger. Refer to "Configure Trigger Source" in section "3.3 SYSTEM Menu" to configure the **Trigger Source**.

---

**Note:** The number next to **LIST** on the display shows the current running step number. When the list ends, it will change back to "0".

---

---

**Note:** If **List** mode is enabled, the **Recall** menu will be locked and list parameters cannot be changed until **List** mode is disabled.

---

---

**Note:** At the end of a list operation, the load's input does not disable automatically and will continue to draw power at the list's last step value until **On/Off** is pressed to disable the input or if controlled remotely, the input OFF command is sent at the end.

---



- To disable list operation, first press **On/Off** to disable the input and then press **Shift** and **3** (or press **List**). Select **Off** and press **Enter** to confirm. The **Trig** annunciator will disappear when list operation is disabled.

## 3.8 Battery Test Function

The load has a built-in battery test function that uses CC mode and calculates the battery capacity using a fixed current load. The test's stop conditions can be specified by the following:

**Stop Voltage:** Set a cut-off voltage level. When this level is reached, the test will end. Valid range: 0 V – max. rated voltage.

**Stop Capacity:** Sets a capacity level. When the calculated capacity reaches this level, the test will end. Valid range: 0 Ah – 999.99 Ah

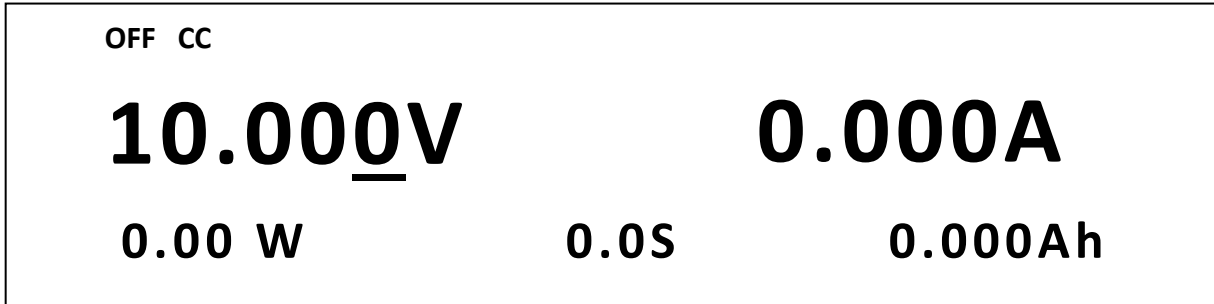
**Stop Timer:** Sets a timer. When the specified time is reached, the test will end. Valid range: 0 s – 99999 s.

During operation, the load will sink current at the specified level while measuring and updating the capacity value in amp-hours (Ah) and tracking the time period of the test. When any one of the three stop conditions above is met, the test will end, and the display will show the measured capacity and time results.

To setup and run the battery test function, follow the steps below:

- Disable the input of the load and connect it to the battery to be tested.
- Press **CC** and use the numeric keypad or rotary knob to enter a current sink value for the test. Press **Enter**.
- Press **Shift** (**Shift**) and **5** (**Battery**) to configure and enable the battery test function.
- The load will prompt to enter all three test stop conditions, starting with **Stop Voltage** value. Use the numeric keypad or rotary knob to enter a voltage level. Then press **Enter** to continue.
- The load will prompt to enter the **Stop Capacity**. Use the numeric keypad or rotary knob to enter a capacity value in Ah. Then press **Enter** to continue.

6. Lastly, it will prompt to enter the **Stop Timer**. Use the numeric keypad or rotary knob to enter a time value in seconds. Then press **Enter** to finish the setup.
7. The display will then show the following:



8. To start the battery test, press **Trig** (**Trig**) once. The input will automatically be enabled (ON) with the **On/Off** button's backlight lit. The timer on the display will run continuously and Ah measurement will update through time. The test will continue to run until one of the three stop conditions is met.

## 3.9 Test Operations

### ***Automatic Test Function***

The automatic test function of the load is useful for simulating various tests and allows the user to edit up to 10 program files. Each file has 10 steps and up to 100 steps can be edited and saved into the EEPROM. Convenient for production environments, automatic test can cascade sequences across multiple channels and allows setting of Pass/Fail (P/F) criteria.

### **Setting Up Program Files**

#### **Configuring Pass/Fail Parameters**

The Pass/Fail criteria can be found in the SETUP menu of the front panel, under the high/low parameters. Users must set pass/fail criteria for each mode (*Configure CC Parameters*, *Configure CV Parameters*, *Configure CR Parameters*, and/or *Configure CW Parameters*) used in

the Automatic Test sequence, prior to running the automated test. Please see the *Configure CC Parameters*, *Configure CV Parameters*, *Configure CR Parameters*, and/or *Configure CW Parameters* configuration sections to set these parameters.

### Configuring Instrument Settings

The automatic test runs a program that uses the settings stored into the internal EEPROM memory.

Each program can run 10 sequences, and each of these sequences is correlated to instrument settings that are stored within a designated group of internal EEPROM memory. They are designated according to the table below:

**Table 5 - Program Save Group/Sequence Association**

PROGRAM 1 Sequence	1	2	3	4	5	6	7	8	9	10
Save Group	1	2	3	4	5	6	7	8	9	10
PROGRAM 2 Sequence	1	2	3	4	5	6	7	8	9	10
Save Group	11	12	13	14	15	16	17	18	19	20
PROGRAM 3 Sequence	1	2	3	4	5	6	7	8	9	10
Save Group	21	22	23	24	25	26	27	28	29	30
PROGRAM 4 Sequence	1	2	3	4	5	6	7	8	9	10
Save Group	31	32	33	34	35	36	37	38	39	40
PROGRAM 5 Sequence	1	2	3	4	5	6	7	8	9	10
Save Group	41	42	43	44	45	46	47	48	49	50
PROGRAM 6 Sequence	1	2	3	4	5	6	7	8	9	10
Save Group	51	52	53	54	55	56	57	58	59	60
PROGRAM 7 Sequence	1	2	3	4	5	6	7	8	9	10
Save Group	61	62	63	64	65	66	67	68	69	70
PROGRAM 8 Sequence	1	2	3	4	5	6	7	8	9	10
Save Group	71	72	73	74	75	76	77	78	79	80

PROGRAM 9 Sequence	1	2	3	4	5	6	7	8	9	10
Save Group	81	82	83	84	85	86	87	88	89	90
PROGRAM 10 Sequence	1	2	3	4	5	6	7	8	9	10
Save Group	91	92	93	94	95	96	97	98	99	100

Example:

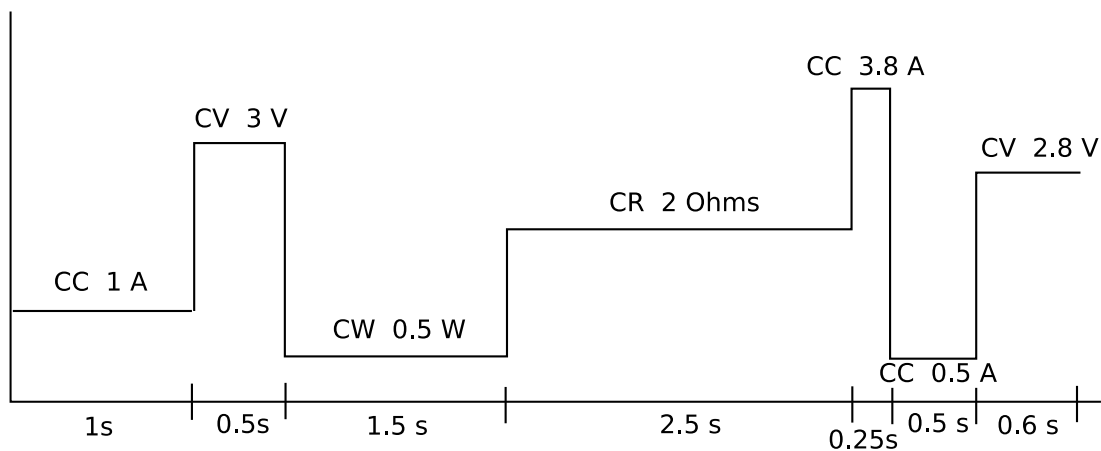
In Program 1, sequence 1 correlates to instrument settings stored in memory location 1.

In Program 5, sequence 5 correlates to instrument settings stored in memory location 45.

In Program 8, sequence 10 correlates to instrument settings stored in memory location 80.

Within each program, sequences can be activated or deactivated (skipped), but they run in order from 1 through 10. Therefore, when setting and storing instrument settings into the memory, keep in mind the order of which you want them to be recalled and run in the automatic test program.

For example, suppose you want to run a test program that simulates the load profile below:



Configure and save settings into memory according to the table below:

Settings		Store to Memory location
Mode of Operation	Setting Value	



CC	1 A	1
CV	3 V	2
CW	0.5 W	3
CR	2 $\Omega$	4
CC	3.8 A	5
CC	0.5 A	6
CV	2.8 V	7

Refer to section “Save/Recall Instrument Settings” in section “3.3 SYSTEM Menu” for details on saving settings into internal memory.

---

**Note:** If the program requires more than 10 sequences, each program can be linked (chained) to another program after it has completed.

---


1. Setup the program parameters. From the front panel press  (Shift) and then  (Program 2) to access the **PROGRAM** menu. It will look like the display below:



2. Select **Edit** and press . The first parameter to configure is the **Active Sequence**.



This allows activating or deactivating a sequence in the program. Sequences that are activated will be part of the test program. Deactivated sequences will be skipped. To activate a sequence, press the number corresponding to the sequence using the

numeric keypad. For example, if sequence 1 through 5 are to be activated, press 



. The activated sequence numbers on the display will change to **Y**, indicating that they are active and will be run as part of the test program. In this example, the display will look like below:

# EDIT PROGRAM

**Active Sequence = 09876YYYYY**

To deactivate, press the corresponding number with the numeric keypad again. The sequence number on the display will change back from **Y** to the actual sequence number.

3. Press **Enter** to continue. The next parameter to configure will be the **Pause Sequence**. This allows the test program to pause after running any selected sequence. For example, if the test program should pause before running sequence 2 and 4, use the

numeric keypad and press <sup>Short</sup> **1** and <sup>List</sup> **3** ( <sup>Battery</sup>) so that number **1** and **3** in the **Pause Sequence** on the display will indicate **Y**. When the program finishes running sequence 1, it will pause until user presses a button to continue the test. Then when the program finishes running sequence 3, it will pause again until user presses a button to continue the test. The display will look like below for this configuration:

# EDIT PROGRAM

**Pause Sequence = **4Y2Y****

---

**Note:** A  symbol will replace the sequence numbers that are deactivated from the previous steps.

---

4. Press **Enter** to continue. The next parameter to configure will be the **Short Sequence**. This allows the test program to run a short circuit test of the selected sequence. Use the numeric keypad to select which sequence number to activate short circuit test, and its number will change to **Y**.

# EDIT PROGRAM

Short Sequence = □□□□□□4Y2Y

5. Press  to continue. The display will show the following:

# EDIT PROGRAM

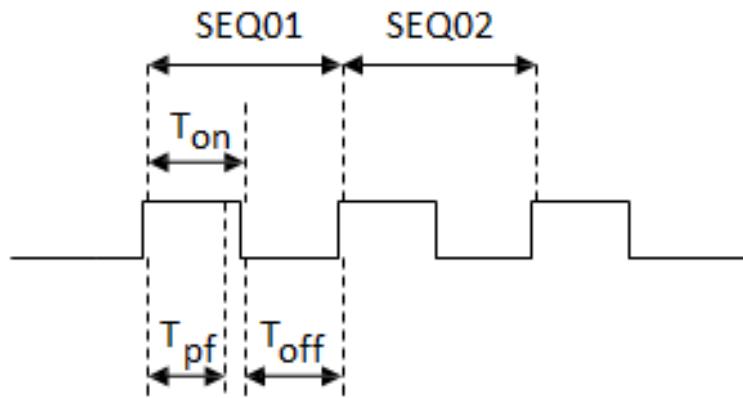
SEQ01 On Time = 0.0 S

**SEQ01** will be shown if sequence 1 is activated. Otherwise, it will display SEQXX where XX is the first sequence number in the program that is activated (starts from 1-9 and then 0).

The load is prompting to enter the **On Time** for the sequence number in seconds. This is the length of time in which to run the sequence with input enabled (ON). Valid range is 0.0 s – 60.0 s. Use the numeric keypad or rotary knob to enter a value. Then press

.

6. Now, the load will prompt to enter **Off Time**. This is the length of time in which to run the sequence with input disabled (OFF). Valid range is 0.0 s – 60.0 s. Use the numeric keypad or rotary knob to enter a value. Then press .
7. The load will then prompt to enter **P/F Delay Time**. This is delay time is illustrated by the graph below:



$$0 \leq T_{pf} \leq (T_{on} + T_{off})$$

$T_{pf}$  = P/F Delay Time  
 $T_{on}$  = On Time  
 $T_{off}$  = Off Time

- Use the numeric keypad or rotary knob to enter a value. Then press **Enter** .
8. If there are more than one active sequence, the load will repeat the prompts to configure the **On Time, Off Time, and P/F Delay Time**. Follow steps 7 – 9 for each sequence.
  9. Once all sequences' parameters are configured, the display will show:

# PROGRAM

**Complete-Stop**

**Failure-Stop**

Select **Complete-Stop** or **Failure-Stop**, then press **Enter** .

**Complete-Stop:** Stop test when program is complete.

**Failure-Stop:** Stop test when testing fails.

10. The load will prompt to enter a value for **Chain Program File**. This specifies the next program to run immediately after the end of the test. Select between 0 – 10. Select **0** if no other programs will be run at the end of the test. Otherwise, select the program number to run after the test is completed. Use the numeric keypad or rotary knob to enter a value and then press **Enter** to confirm.
11. Lastly, the load will prompt to select a number to **Save Program File**. This is the program number that will be referred to when recalling all the configured settings from previous steps or chaining with another program. Select between 1 – 10 with the






numeric keypad or rotary knob. Then press **Enter** to confirm and save all settings to the selected program number. The display will not return to the **PROGRAM** menu.

## Recall and Run Program

The following is a procedure to recall and run a saved test program.

### Recall a Program

1. Press  (**Shift**) and then  (**6**)  (**2**) to enter the **Program** menu.
2. Select **Recall** and press **Enter**. The display will be shown as below:

# RECALL PROGRAM

Recall Program File = 1




3. Use the numeric keypad or rotary to select the program number to recall from memory. Enter a number between 1 and 10. Then press **Enter**.
4. The display go back to the **Program** menu. To view the recalled settings, select **Edit** and press **Enter**.

---

**Note:** If you recall a program from an empty location, it will give you an error message, and all settings viewed under the **Edit** option will be reset to default values.

---

### Run a Program

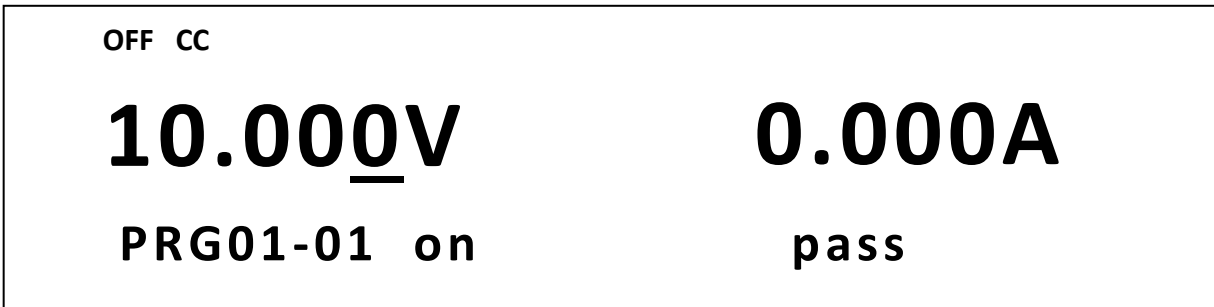
1. Press  (**Shift**) and then  (**6**)  (**2**) to enter the **Program** menu.
2. Make sure the program you want to run has already been recalled from the previous instructions. Select **Run** and press **Enter**.
3. The display will show the following:



**PRG01** from this display indicates which program has been loaded to run. Depending on which program is recalled, it will show **PRG01-PRG10**.

**STOP** indicates the program is not running.

4. Now, press  (  ) once to start running the program. The display will change to:

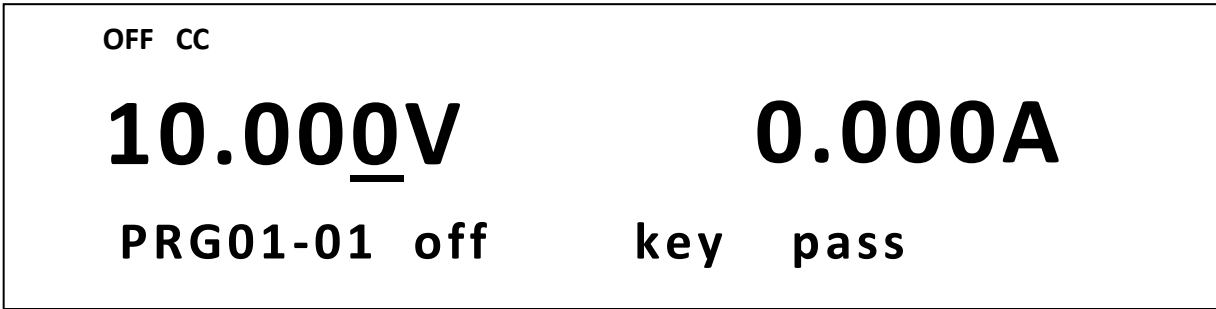




**-01** next to **PRG01** indicates the current running sequence number within the selected program number.





**on** indicates the input state is enabled for the selected sequence. If **On Time** is not set to 0.0S for the sequence, it will show **on**. This indicator can also show **off** to indicate the input state is disabled. If **short** is selected for the sequence, it will display **short**.





**pass** indicates at the current sequence has passed the test. If a failure occurs, it will indicate **fail**.

5. If pause is activated for a selected sequence while running the program, the display will show:

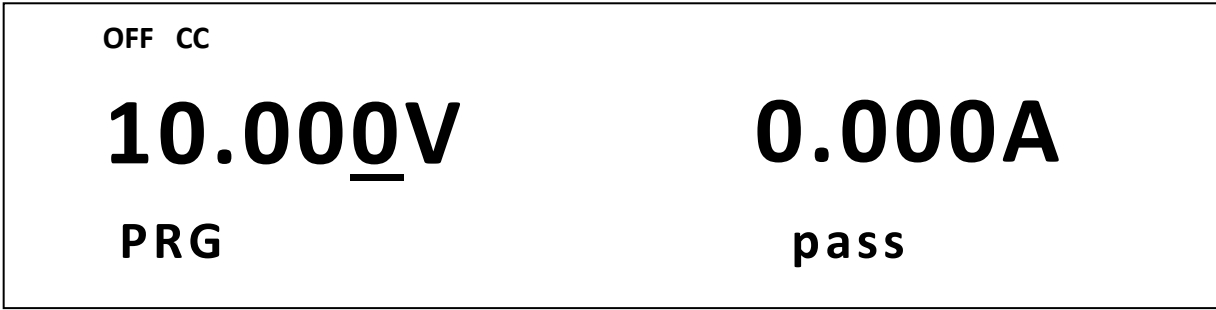


At this point, the program is in a pause state. To continue the test, press  () once.



**Note:** At any time while the program is in the running state, if you wish to re-test a sequence or test a previous sequence, press the  () key. Each press will go back up one sequence and run the test again starting from that sequence. You can also skip to the next sequence in the test by pressing  () .

To pause the program at any time while it is in the running state, press  and then  (or press  ). A Pause indicator will appear on the bottom right of the display. To resume, repeat the same step. When the program is in a pause state, the input state can be overridden by pressing  .

6. At the end of the test, the display will show:






If there is a failure, **fail** will be indicated in place of **pass**. At this point, you can press

 () to view which sequences were tested and passed/failed. It will be indicated like the following:



Y indicates the tested sequence(s) that passed/failed. If a sequence has been skipped in the test, its sequence number will be indicated instead of a Y.

7. To stop a running program at any time, press  () once. To completely exit the automatic test function, press  a few times until the load returns back to the normal display.

## ***OCP Test Function***



The load has a built-in OCP test function that can be used to automate testing for OCP conditions. The load can save up to 5 OCP test programs into internal memory, which can be recalled and run.

The OCP Test program requires the following parameters be configured before it can be run.



- |                         |  |
|-------------------------|--|
| <b>Voltage On Level</b> | This is the minimum voltage level the load measures before the start of the test.  |
| <b>Voltage On Delay</b> | This is the delay time from when the Voltage On Level is reached to the actual start of the test.  |
| <b>Current Range</b>    | This specifies the current range of the test. All models have two current ranges, with the lower range allowing for higher resolution. This value will also limit the maximum current settings for other parameters configured for the test program. |








<b>Start Current</b>	This is the starting current value when OCP test begins. The settable range of this value is limited by <b>Current Range</b> .
<b>Step Current</b>	This is the size of the step current as the test runs from the <b>Start Current</b> to <b>End Current</b> . The test will only run through in steps if the measured input voltage is greater than the <b>OCP Voltage</b> . Otherwise, the test will end after running the <b>Start Current</b> for the amount of time specified in <b>Step Delay</b> .
<b>Step Delay</b>	This is the delay time to hold each current step in the test. This determines how fast or slow to run through the test.
<b>End Current</b>	This is the ending current value before OCP test ends. The test will only run through in steps from <b>Start Current</b> to the <b>End Current</b> if input voltage is greater than the <b>OCP Voltage</b> . The settable range of this value is limited by <b>Current Range</b> .
<b>OCP Voltage</b>	This value is a limit that is used to test for OCP conditions. In the event of an over current condition, when the input voltage is greater than this value, the test will run through from <b>Start Current</b> to <b>End Current</b> in steps. The input current (the over current) value will be checked during this process. If current is within the <b>Max Trip Current</b> and <b>Min Trip Current</b> boundaries, the load will indicate <b>Pass</b> at the end of the test. If outside of these boundaries, the load will indicate <b>Fault</b> .
<b>Max Trip Current</b>	The maximum acceptable current limit of the over current value.
<b>Min Trip Current</b>	The minimum acceptable current limit of the over current value.

The following is a step by step procedure to configure an OCP test program.

1. Press  (Shift) and  to enter the **OCP Test** menu. The following will be displayed:



2. Select **Edit** and press . Enter a value using the numeric keypad or rotary knob for **Voltage On Level**. The value must be within the maximum input limits of the load. Press  to continue.

3. Enter a value for **Voltage On Delay**. This can be set between 0.00s and 99.99s. Then press  to continue.
4. Follow the same steps for **Current Range**. The value must be within the maximum input limits of the load. Press  to continue.
5. Set the **Start Current**. The value must be less than **Current Range**. Press  to continue.
6. Do the same for **Step Current** and **End Current**. Press  after each setting to continue.
7. Enter a value for **OCP Voltage** and press  to continue.
8. Finally, enter a value for **Max Trip Current**, and then **Min Trip Current**. Press  after each settings to continue.
9. The load will prompt to **Save OCP File**. Select a number between 1 and 5. Then press  to save all settings to the selected location.

---


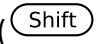



**Note:** At any time when configuring any parameters for the test, you can press the




key to select the previous parameter to edit.

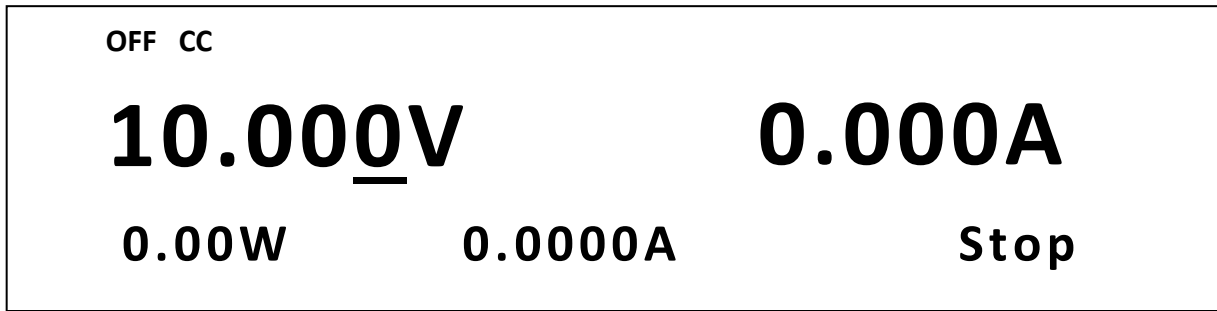
---



To recall the settings:

1. Press  () and  to enter the **OCP Test** menu. Select **Recall** and press .
2. Use the keypad or knob to select the saved location number and press . All settings will be recalled when selecting **Edit** from the **OCP Test** menu.

To run the OCP test:

1. Recall the settings from memory by following the steps above.
2. Then, from the **OCP Test** menu, select **Run** and press . The display will show the following:



3. Press  to start the test. When the test is running, **Run** will be indicated in place of **Stop**. When the test ends, either **Pass** or **Fault** will appear next to **Stop**.
4. To stop the test at any time, press .

### ***OPP Test Function***

The load has a built-in OPP test function that can be used to automate testing for OPP conditions. The load can save up to 5 OPP test programs into internal memory, which can be recalled and run.



The OPP Test program requires the following parameters be configured before it can be run.

<b>Voltage On Level</b>	This is the minimum voltage level the load measures before the start of the test.
<b>Voltage On Delay</b>	This is the delay time from when the <b>Voltage On Level</b> is reached to the actual start of the test.
<b>Current Range</b>	This specifies the current range of the test. All models have two current ranges, with the lower range allowing for higher resolution. This value will also limit the maximum settings for other parameters configured for the test program.
<b>Start Power</b>	This is the starting power value when OPP test begins.
<b>Step Power</b>	This is the size of the step power as the test runs from the <b>Start Power</b> to <b>End Power</b> . The test will only run through in steps if the measured input voltage is greater than the <b>OPP Voltage</b> . Otherwise, the test will end after running the <b>Start Power</b> for the amount of time specified in






### Step Delay.

<b>Step Delay</b>	This is the delay time to hold each power step in the test. This determines how fast or slow to run through the test.
<b>End Power</b>	This is the ending power value before OPP test ends. The test will only run through in steps from <b>Start Power</b> to the <b>End Power</b> if input voltage is greater than the <b>OPP Voltage</b> .
<b>OPP Voltage</b>	This value is a limit that is used to test for OPP conditions. In the event of an over power condition, when the input voltage is greater than this value, the test will run through from <b>Start Power</b> to <b>End Power</b> in steps. The input power (the over power) value will be checked during this process. If power is within the <b>Max Trip Power</b> and <b>Min Trip Power</b> boundaries, the load will indicate <b>Pass</b> at the end of the test. If outside of these boundaries, the load will indicate <b>Fault</b> .
<b>Max Trip Power</b>	The maximum acceptable power limit of the over power value.
<b>Min Trip Power</b>	The minimum acceptable power limit of the over power value.

The following is a step by step procedure to configure an OPP test program.

1. Press  (Shift) and  to enter the **OPP Test** menu. The following will be displayed:



2. Select **Edit** and press . Enter a value using the numeric keypad or rotary knob for **Voltage On Level**. The value must be within the maximum input limits of the load. Press  to continue.
3. Enter a value for **Voltage On Delay**. This can be set between 0.00s and 99.99s. Then press  to continue.
4. Follow the same steps for **Current Range**. The value must be within the maximum input limits of the load. Press  to continue.
5. Set the **Start Power**. The value must be within the maximum input limits of the load. Press  to continue.





6. Follow the same steps for **Step Power** and **End Power**. Press **Enter** after each settings to continue.
7. Enter a value for **OPP Voltage** and press **Enter** to continue.
8. Enter a value for **Max Trip Power**, and then **Min Trip Power**. Press **Enter** after each settings to continue.
9. The load will prompt to **Save OPP File**. Select a number between 1 and 5. Then press **Enter** to save all settings to the selected location.

**Note:** At any time when configuring any parameters for the test, you can press the

 () key to select the previous parameter to edit.





To recall the settings:

1. Press  (**Shift**) and  to enter the **OPP Test** menu. Select **Recall** and press **Enter**.
2. Use the keypad or knob to select the saved location number and press **Enter**. All settings will be recalled when selecting **Edit** from the **OPP Test** menu.

To run the OPP test:









1. Recall the settings from memory by following the steps above.
2. From the **OPP Test** menu, select **Run** and press **Enter**. The display will show the following:

OFF CC		
<b>10.000</b>	<b>V</b>	<b>0.000A</b>
<b>0.00W</b>	<b>0.00W</b>	<b>Stop</b>

3. Press  () to start the test. When the test is running, **Run** will be indicated in place of **Stop**. When the test ends, either **Pass** or **Fault** will appear next to **Stop**.
4. To stop the test at any time, press  () .

## 3.10 Key Lock

The front panel keys can be locked to prevent unwanted changes to output settings and instrument configurations. Follow the steps below to enable/disable key lock.

1. Press  () and then  (). A \* indicator will light up on the display, indicating that the front panel keys are lock. At this point, all keys are disabled except for the Lock function.
2. To unlock the keys again, press  () and then  () again. The \* indicator will disappear and all keys will be enabled.

# 4 Remote Operation

## 4.1 Interface Connection

### **RS-232**

For RS-232 connectivity, refer to the diagram below for pinout information. The RS-232 is labeled in the rear panel and it is a female DB-9 interface.

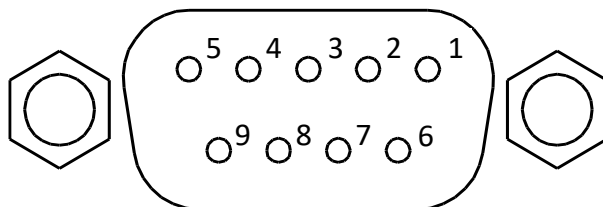


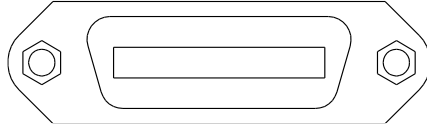
Table 6 - RS232 Pin Outs

PIN	Description
1	-
2	Transmit Data
3	Receive Data
4	-
5	GND
6	-
7	CTS
8	RTS
9	-

A straight pin-to-pin DB9 female to DB9 male serial cable is required for using the RS-232 interface. Do not use a null modem or crossover DB9 serial cable.

### ***GPIB (non-B series only)***

The load can be configured with a GPIB address from 0 – 31. To communicate via GPIB, connect a GPIB cable to the GPIB interface on the rear panel, as illustrated below.



### ***USBTMC***

The device is SR1, RL1, and DT1 enabled. It can receive the following request:

REN\_CONTROL, GO\_TO\_LOCAL, LOCAL\_LOCKOUT. When it receives MsgID = TRIGGER USBTMC command, it will transmit TRIGGER command to the function layer.

## **4.2 Remote Commands**

The instrument supports some SCPI commands and some instrument specific commands. These commands enable a computer to remotely communicate and control the instrument over any of the supported remote interfaces: USBTMC, RS-232, and GPIB(non-B series only) .

Refer to the programming manual for details, which can be downloaded from [www.bkprecision.com](http://www.bkprecision.com).

# 5 Troubleshooting Guide

Below are some frequently asked questions and answers. Please check if any apply to your instrument before contacting B&K Precision.

## ***General***

**Q: I cannot power up the instrument.**

Check that the power cord is securely connected to the AC input and there is live power from your electrical AC outlet.

Verify that the AC power coming from the mains have the correct voltage. The load can accept a specific range of AC input voltages. Refer to section “2.1”.

**Q: I cannot set power (in CW) or current (in CC) at the maximum rating.**

4. Check the power and current **Limits** from the **Protect** menu within the **CONFIG** menu. Refer to section 3.4 for details.

## ***Remote Control***

**Q: I am trying to send the commands over USB/RS232, but it does not seem to respond.**

Check that you are sending ASCII strings that are terminated with a CR (carriage return) and LF (line feed) character.

For RS-232, check that the baud rate, parity, data bits, stop bit, and flow control settings match with the settings configured on the software interface. To check these settings, go to the **SYSTEM** menu and enter the **Communication** menu, and select RS-232.

## 6 Specifications

**Note:** All specifications apply to the unit after a temperature stabilization time of 15 minutes over an ambient temperature range of  $23\text{ }^{\circ}\text{C} \pm 5\text{ }^{\circ}\text{C}$ . Specifications are subject to change without notice.

Model		8600/B	8601/B	8602/B
<b>Input Ratings</b>				
Input Voltage		0 – 120 V	0 – 120 V	0 – 500 V
Input Current	Low	0 – 3 A	0 – 6 A	0 – 3 A
	High	0 – 30 A	0 – 60 A	0 – 15 A
Input Power		150 W	250 W	200 W
Minimum Operating Voltage	Low	0.11 V at 3 A	0.18 V at 6 A	1 V at 3 A
	High	1.1 V at 30 A	1.1 V at 60 A	4.5 V at 15 A
<b>CV Mode</b>				
Range	Low	0 – 18 V		0 – 50 V
	High	0 – 120 V		0 – 500 V
Resolution	Low	1 mV		
	High	10 mV		
Accuracy	Low	$\pm(0.05\%+0.02\%FS)$	$\pm(0.025\%+0.05\%FS)$	$\pm(0.05\%+0.025\%FS)$
	High	$\pm(0.05\%+0.025\%FS)$	$\pm(0.025\%+0.05\%FS)$	$\pm(0.05\%+0.025\%FS)$
<b>CC Mode</b>				
Range	Low	0 – 3 A	0 – 6 A	0 – 3 A
	High	0 – 30 A	0 – 60 A	0 – 15 A
Resolution	Low	0.1 mA	0.1 mA	0.1 mA
	High	1 mA	1 mA	1 mA
Accuracy	Low	$\pm(0.05\%+0.05\%FS)$		
	High	$\pm(0.05\%+0.05\%FS)$		
<b>CR Mode</b>				
Range	Low	0.05 $\Omega$ – 10 $\Omega$		0.3 $\Omega$ – 10 $\Omega$
	High	10 $\Omega$ - 7.5 k $\Omega$		
Resolution		16 bit		
Accuracy	Low	0.01%+0.08 S		
	High	0.01%+0.0008 S		
<b>CW Mode</b>				
Range		150 W	250 W	200 W
Resolution		10 mW		
Accuracy		0.1% + 0.1%FS	0.2% + 0.2%FS	0.1% + 0.1%FS

Models		8600/B	8601/B	8602/B
<b>Transient Mode (CC mode)</b>				
T1 & T2 <sup>1</sup>		20 $\mu$ s – 3600 s / Resolution: 10 $\mu$ s		
Accuracy		5 $\mu$ s + 100 ppm		
Slew Rate <sup>2</sup>	Low Rate	0.001-2.5 A/ms		0.001-1 A/ms
	High Rate	0.001-2.5 A/ $\mu$ s		0.001-1 A/ $\mu$ s
Accuracy		within 40 % of programmed value		
<b>Measurement</b>				
<b>Readback Voltage</b>				
Range	Low	0 – 18 V	0 – 18 V	0 – 50 V
	High	0 – 120 V	0 – 120 V	0 – 500 V
Resolution	Low	1 mV		
	High	10 mV		
Accuracy		$\pm(0.05 \%+0.05 \% \text{ FS})$		
<b>Readback Current</b>				
Range	Low	0 – 3 A	0 – 6 A	0 – 3 A
	High	0 – 30 A	0 – 60 A	0 – 15 A
Resolution	Low	0.01 mA	0.1 mA	0.01 mA
	High	0.1 mA	1 mA	0.1 mA
Accuracy		$\pm(0.05 \%+0.05 \% \text{ FS})$	$\pm(0.05 \%+0.1 \% \text{ FS})$	$\pm(0.05\%+0.05 \% \text{ FS})$
<b>Readback Power</b>				
Range		150 W	250 W	200 W
Resolution		10 mW		
Accuracy		$\pm(1 \%+0.1 \% \text{ FS})$	$\pm(0.2 \%+0.2 \% \text{ FS})$	$\pm(0.1 \%+0.1 \% \text{ FS})$
<b>Protection Range (typical)</b>				
OPP		150 W	250 W	200 W
OCP	Low	3.3 A	6.6 A	3.3 A
	High	33 A	66 A	16.5 A
OVP		120 V	120 V	500 V
OTP		85°C		
<b>General (typical)</b>				
Short Circuit				
Current (CC)	Low	3.3 A	6.6 A	3.3 A
	High	33 A	66 A	16.5 A
Voltage		0 V		
Resistance		35 m $\Omega$	30 m $\Omega$	300 m $\Omega$
Input Terminal Impedance		150 k $\Omega$	300 k $\Omega$	1 M $\Omega$

Model		8610/B	8612/B	8614/B	8616
<b>Input Ratings</b>					
Input Voltage		0 – 120 V	0 – 500 V	0 – 120 V	0 – 500 V
Input Current	Low	0 – 12 A	0 – 3 A	0 – 24 A	0 – 6 A
	High	0 – 120 A	0 – 30 A	0 – 240 A	0 – 60 A
Input Power		750 W		1500 W	1200 W
Minimum Operating Voltage	Low	0.12 V at 12 A	0.36 V at 3 A	0.15 V at 24 A	0.36 V at 6 A
	High	1.2 V at 120 A	3.6 V at 30 A	1.5 V at 240 A	3.6 V at 60 A
<b>CV Mode</b>					
Range	Low	0 – 18 V	0 – 50 V	0 – 18 V	0 – 50 V
	High	0 – 120 V	0 – 500 V	0 – 120 V	0 – 500 V
Resolution	Low	0.1 mV	1 mV	0.1 mV	1 mV
	High	1 mV	10 mV	1 mV	10 mV
Accuracy	Low	$\pm(0.025\%+0.05\%FS)$		$\pm(0.025\%+0.025\%FS)$	$\pm(0.025\%+0.05\%FS)$
	High	$\pm(0.025\%+0.05\%FS)$			
<b>CC Mode</b>					
Range	Low	0 – 12 A	0 – 3 A	0 – 24 A	0 – 6 A
	High	0 – 120 A	0 – 30 A	0 – 240 A	0 – 60 A
Resolution	Low	1 mA	0.1 mA	1 mA	0.1 mA
	High	10 mA	1 mA	10 mA	1 mA
Accuracy	Low	$\pm(0.05\%+0.1\%FS)$	$\pm(0.05\%+0.05\%FS)$	$\pm(0.05\%+0.1\%FS)$	$\pm(0.05\%+0.05\%FS)$
	High	$\pm(0.05\%+0.1\%FS)$	$\pm(0.05\%+0.05\%FS)$	$\pm(0.05\%+0.1\%FS)$	$\pm(0.05\%+0.05\%FS)$
<b>CR Mode</b>					
Range	Low	0.02 $\Omega$ – 10 $\Omega$	0.15 $\Omega$ – 10 $\Omega$	0.01 $\Omega$ – 10 $\Omega$	0.1 $\Omega$ – 10 $\Omega$
	High	10 $\Omega$ - 7.5 k $\Omega$			
Resolution		16 bit			
Accuracy	Low	0.01%+0.08 S			
	High	0.01%+0.0008 S			
<b>CW Mode</b>					
Range		750 W		1500 W	1200 W
Resolution		10 mW		100 mW	
Accuracy		0.2% + 0.2%FS			



Models		8610/B	8612/B	8614/B	8616
<b>Transient Mode (CC mode)</b>					
T1 & T2 <sup>1</sup>		20 $\mu$ s – 3600 s/Resolution: 10 $\mu$ s			
Accuracy		5 $\mu$ s + 100 ppm			
Slew Rate <sup>2</sup>	Low Rate	0.001-0.25 A/ $\mu$ s	0.0001-0.1 A/ $\mu$ s	0.001-0.25 A/ $\mu$ s	0.0001-0.1 A/ $\mu$ s
	High Rate	0.01-2.5 A/ $\mu$ s	0.001-1 A/ $\mu$ s	0.01-2.5 A/ $\mu$ s	0.001-1 A/ $\mu$ s
Accuracy		within 40% of programmed value			
<b>Measurement</b>					
<b>Readback Voltage</b>					
Range	Low	0 – 18 V	0 – 50 V	0 – 18 V	0 – 50 V
	High	0 – 120 V	0 – 500 V	0 – 120 V	0 – 500 V
Resolution	Low	0.1 mV	1 mV	0.1 mV	1 mV
	High	1 mV	10 mV	1 mV	10 mV
Accuracy		$\pm(0.05\%+0.05\%FS)$			
<b>Readback Current</b>					
Range	Low	0 – 12 A	0 – 3 A	0 – 24 A	0 – 6 A
	High	0 – 120 A	0 – 30 A	0 – 240 A	0 – 60 A
Resolution	Low	1 mA	0.1 mA	1 mA	0.1 mA
	High	10 mA	1 mA	10 mA	1 mA
Accuracy		$\pm(0.05\%+0.1\%FS)$	$\pm(0.05\%+0.05\%FS)$	$\pm(0.05\%+0.1\%FS)$	$\pm(0.05\%+0.05\%FS)$
<b>Readback Power</b>					
Range		750 W		1500 W	1200 W
Resolution		10 mW		100 mW	
Accuracy		$\pm(0.2\%+0.2\%FS)$			
<b>Protection Range (typical)</b>					
OPP		760 W		1550 W	1250 W
OCP	Low	13.2 A	3.3 A	26.4 A	6.6 A
	High	132 A	33 A	264 A	66 A
OVP		130 V	530 V	130 V	530 V
OTP		85°C			
<b>General (typical)</b>					
Short Circuit					
Current (CC)	Low	13.2 A	3.3 A	26.4 A	6.6 A
	High	132 A	33 A	264 A	66 A
Voltage		0 V			
Resistance		10 m $\Omega$	120 m $\Omega$	6 m $\Omega$	60 m $\Omega$
Input Terminal Impedance		300 k $\Omega$	1 M $\Omega$	300 k $\Omega$	1 M $\Omega$

Notes:

- 1) Fast pulse trains with large transitions may not be achievable.
- 2) The slew rate specifications are not warranted but are descriptions of typical performance. The actual transition time is defined as the time for the input to change from 10% to 90%, or vice versa, of the programmed current values. In case of very large load changes, e.g. from no load to full load, the actual transition time will be larger than the expected time. The load will automatically adjust the slew rate to fit within the range (high or low) that is closest to the programmed value.

Model		8620	8622	8624	8625
<b>Input Ratings</b>					
Input Voltage		0 – 120 V	0 – 500 V	0 – 120 V	0 – 120 V
Input Current	Low	0 – 48 A	0 – 10 A	0 – 60 A	0 – 72 A
	High	0 – 480 A	0 – 100 A	0 – 600 A	0 – 720 A
Input Power		3000 W	2500 W	4500 W	6000 W
Minimum Operating Voltage	Low	0.2 V at 48 A	0.3 V at 10 A	0.18 V at 60 A	0.18 V at 72 A
	High	2 V at 480 A	3 V at 100 A	18 V at 600 A	1.8 V at 720 A
<b>CV Mode</b>					
Range	Low	0 – 18 V	0 – 50 V	0 – 18 V	0 – 18 V
	High	0 – 120 V	0 – 500 V	0 – 120 V	0 – 120 V
Resolution	Low	1 mV			
	High	10 mV			
Accuracy	Low	$\pm(0.025\%+0.05\%FS)$		$\pm(0.025\%+0.025\%FS)$	$\pm(0.025\%+0.05\%FS)$
	High	$\pm(0.025\%+0.05\%FS)$			
<b>CC Mode</b>					
Range	Low	0 – 48 A	0 – 10 A	0 – 60 A	0 – 72 A
	High	0 – 480 A	0 – 100 A	0 – 600 A	0 – 720 A
Resolution	Low	1 mA			
	High	10 mA			
Accuracy	Low	$\pm(0.25\%+0.05\%FS)$			
	High	$\pm(0.25\%+0.05\%FS)$			
<b>CR Mode</b>					
Range	Low	0.01 $\Omega$ – 10 $\Omega$	0.03 $\Omega$ – 10 $\Omega$	0.01 $\Omega$ – 10 $\Omega$	0.005 $\Omega$ – 10 $\Omega$
	High	10 $\Omega$ - 7.5 k $\Omega$			
Resolution		16 bit			
Accuracy	Low	0.01%+0.08 S			
	High	0.01%+0.0008 S			
<b>CW Mode</b>					
Range		3000 W	2500 W	4500 W	6000 W
Resolution		100 mW			
Accuracy		0.2% + 0.2%FS			

Models		8620	8622	8624	8625
<b>Transient Mode (CC mode)</b>					
T1 & T2 <sup>1</sup>		20 $\mu$ s – 3600 s/Resolution: 10 $\mu$ s			
Accuracy		5 $\mu$ s + 100 ppm			
Slew Rate <sup>2</sup>	Low Rate	0.001-0.25 A/ $\mu$ s	0.0001-0.1 A/ $\mu$ s	0.001-0.25 A/ $\mu$ s	0.001-0.25 A/ $\mu$ s
	High Rate	0.01-2.5 A/ $\mu$ s	0.01-1 A/ $\mu$ s	0.01-2.5 A/ $\mu$ s	0.01-2.5 A/ $\mu$ s
Accuracy		within 40% of programmed value			
<b>Measurement</b>					
<b>Readback Voltage</b>					
Range	Low	0 – 18 V	0 – 50 V	0 – 18 V	0 – 18 V
	High	0 – 120 V	0 – 500 V	0 – 120 V	0 – 120 V
Resolution	Low	1 mV			
	High	10 mV			
Accuracy		$\pm(0.025\%+0.025\%FS)$			
<b>Readback Current</b>					
Range	Low	0 – 48 A	0 – 10 A	0 – 60 A	0 – 72 A
	High	0 – 480 A	0 – 100 A	0 – 600 A	0 – 720 A
Resolution	Low	1 mA			
	High	10 mA			
Accuracy		$\pm(0.05\%+0.1\%FS)$	$\pm(0.05\%+0.05\%FS)$	$\pm(0.05\%+0.1\%FS)$	$\pm(0.05\%+0.1\%FS)$
<b>Readback Power</b>					
Range		3000 W	2500 W	4500 W	6000 W
Resolution		100 mW			
Accuracy		$\pm(0.2\%+0.2\%FS)$			
<b>Protection Range (typical)</b>					
OPP		3050 W	2550 W	4550 W	6050 W
OCP	Low	26.4 A	11 A	66 A	79.2 A
	High	264 A	110 A	660 A	792 A
OVP		130 V	530 V	130 V	130 V
OTP		85°C			
<b>General (typical)</b>					
Short Circuit					
Current (CC)	Low	52.8 A	11 A	66 A	79.2 A
	High	528 A	110 A	660 A	792 A
Voltage		0 V			
Resistance		5 m $\Omega$	30 m $\Omega$	3 m $\Omega$	2.5 m $\Omega$
Input Terminal Impedance		300 k $\Omega$	1 M $\Omega$	300 k $\Omega$	300 k $\Omega$

Notes:

- 1) Fast pulse trains with large transitions may not be achievable.

- 2) The slew rate specifications are not warranted but are descriptions of typical performance. The actual transition time is defined as the time for the input to change from 10% to 90%, or vice versa, of the programmed current values. In case of very large load changes, e.g. from no load to full load, the actual transition time will be larger than the expected time. The load will automatically adjust the slew rate to fit within the range (high or low) that is closest to the programmed value.

## Supplementary Characteristics

### Memory capacity

100 Groups

### Recommended calibration period

Once per year

### AC Input (selectable by switch on the rear panel)

Option 1: 220 V  $\pm$ 10%, 50/60 Hz

Option 2: 110 V  $\pm$ 10%, 50/60 Hz

### Cooling method

Fan cool

### Environmental conditions

This instrument is intended for indoor use in a pollution degree 2 environment. Environmental limits are as follows:

<b>Operating temperature</b>	0 to 40 °C
<b>Storage temperature</b>	-10 to 60 °C
<b>Humidity</b>	Indoor use, $\leq$ 95%

## Dimensions and weight

Model	Dimensions (W x H x D) (excludes front and rear rubber bezels and side handle)	Weight
8600/B	218 x 90 x 387 mm	4.5 kg
8601/B	218 x 90 x 387 mm	4.5 kg
8602/B	218 x 90 x 387 mm	4.5 kg
8610/B	439 x 133.3 x 580 mm	24.6 kg
8612/B	439 x 133.3 x 580 mm	24.6 kg
8614/B	439 x 133.3 x 580 mm	24.6 kg
8616	439 x 133.3 x 580 mm	24.6 kg
8620	439 x 133.3 x 580 mm	24.6 kg
8622	439 x 133.3 x 580 mm	24.6 kg
8624	439 x 266 x 590 mm	64.4 kg
8625	439 x 266 x 590 mm	64.4 kg

## Environmental Conditions:

This instrument is designed for indoor use and operated with maximum relative humidity of  $\leq 95\%$ .

The internal cooling fan speed is temperature controlled. Refer to the table below:

Internal Temperature	35 °C	50°C	70°C
Fan Speed	Low	Medium	High

To ensure the most current version of this manual, please download the latest version here: <http://www.bkprecision.com/search/8600/B>

For current up-to-date product information, please visit [www.bkprecision.com](http://www.bkprecision.com)

## 7 Calibration

### CAUTION

It is recommended that the instrument be returned to B&K Precision for service and periodic calibration to ensure the instrument is performing within its specifications.

B&K Precision recommends calibrating the instrument once per year.

# Index

AC input, 12  
*Automatic Test*, 21, 24, 25, 27, 32, 61  
Constant Current, 20  
Constant Power, 25  
Constant Resistance, 24  
Constant Voltage, 23  
Firmware Version, 17  
Fuse, 13  
Key Lock, 77  
line voltage input, 12  
List mode, 56  
Menu, 18  
Remote sense, 47  
Restore Factory Default, 28  
RMT, 35  
Self Test, 15  
Self-test, 15  
Short, 50  
System Menu, 18  
Transient operation, 51  
Trigger Source, 30  
Von Latch, 37

# SERVICE INFORMATION

---

**Warranty Service:** Please go to the support and service section on our website at [www.bkprecision.com](http://www.bkprecision.com) to obtain a RMA #. Return the product in the original packaging with proof of purchase to the address below. Clearly state on the RMA the performance problem and return any leads, probes, connectors and accessories that you are using with the device.

**Non-Warranty Service:** Please go to the support and service section on our website at [www.bkprecision.com](http://www.bkprecision.com) to obtain a RMA #. Return the product in the original packaging to the address below. Clearly state on the RMA the performance problem and return any leads, probes, connectors and accessories that you are using with the device. Customers not on an open account must include payment in the form of a money order or credit card. For the most current repair charges please refer to the service and support section on our website.

Return all merchandise to B&K Precision Corp. with prepaid shipping. The flat-rate repair charge for Non-Warranty Service does not include return shipping. Return shipping to locations in North America is included for Warranty Service. For overnight shipments and non-North American shipping fees please contact B&K Precision Corp.

B&K Precision Corp.  
22820 Savi Ranch Parkway  
Yorba Linda, CA 92887  
[www.bkprecision.com](http://www.bkprecision.com)  
714-921-9095

**Include with the returned instrument your complete return shipping address, contact name, phone number and description of problem.**



# LIMITED THREE-YEAR WARRANTY

---

B&K Precision Corp. warrants to the original purchaser that its products and the component parts thereof, will be free from defects in workmanship and materials for a period of **three years** from date of purchase.

B&K Precision Corp. will, without charge, repair or replace, at its option, defective product or component parts. Returned product must be accompanied by proof of the purchase date in the form of a sales receipt.

To help us better serve you, please complete the warranty registration for your new instrument via our website [www.bkprecision.com](http://www.bkprecision.com)

**Exclusions: This warranty does not apply in the event of misuse or abuse of the product or as a result of unauthorized alterations or repairs. The warranty is void if the serial number is altered, defaced or removed.**

B&K Precision Corp. shall not be liable for any consequential damages, including without limitation damages resulting from loss of use. Some states do not allow limitations of incidental or consequential damages. So the above limitation or exclusion may not apply to you.

This warranty gives you specific rights and you may have other rights, which vary from state-to-state.

B&K Precision Corp.  
22820 Savi Ranch Parkway  
Yorba Linda, CA 92887  
[www.bkprecision.com](http://www.bkprecision.com)  
714-921-9095



22820 Savi Ranch Parkway

Yorba Linda, CA 92887

[www.bkprecision.com](http://www.bkprecision.com)

© 2022 B&K Precision Corp.