

Cyclic Corrosion Test Cabinet - E / VH

SF/xxx/CCT-E: CW 1500 series

SF/xxx/VH: CW 1900 Series

Operating Instructions (V2.0 1119)



IMPORTANT! Before taking this instrument in use we strongly advise you to read this manual carefully.

GUARANTEE

C&W Specialist Equipment Limited (hereinafter called C&W) guarantee the cabinet supplied for a period of one year from the date of delivery to the customers place of work subject to the below mentioned conditions and excluding the items listed. If within the said period any part of the cabinet is found to be defective,

C&W will (subject to the conditions and excluded items) exchange or repair such parts free of charge. All labour, transport and material costs are covered by this guarantee.

This guarantee is to be additional to and does not take away any of the purchaser's rights under the Sale of Goods Act 1979. Neither does this guarantee supersede any guarantee given by the manufacturers whose services will be employed where appropriate.

Conditions of Guarantee

1. The cabinet has not been tampered with or repaired by anyone other than an employee or agent of C&W, unless under direct instructions from C&W.
2. The cabinet has been installed correctly as per the instructions of C&W.
3. The cabinet has not been subject to misuse, or to willful or accidental damage (including damage caused by fire or lightning).
4. The cabinet has been used solely for the purpose for which it was manufactured and kept in and operated to the conditions specified by C&W.
5. The guarantee excludes parts that have a limited life span and components that are non mechanical or electrical that fail due to third party damage.
 - Indicator Lamps
 - Light Bulbs
 - Fuses
 - Salt Solution Filters
 - Peristaltic Pump Tubing
 - Salt Fog Atomiser (fluid cap only)

On behalf of the company

Remco Wever
Managing Director

CONTENT

1.	CYCLIC CORROSION TEST CHAMBERS	4
	Controlled temperature changes	4
	Salt fog environment.....	5
	Constant temperature drying	5
	Forced air drying	5
	Constant temperature high humidity	5
	Cyclic temperature high humidity.....	6
	Combined sequence testing	6
	Continuous testing.....	6
	Intermittent testing.....	6
2.	INSTALLATION.....	7
	Services Required:.....	7
	Mains Electricity	7
	Compressed Air Supply.....	7
	Water Supply.....	7
	Connection of Condenser Unit to Cabinet.....	9
	Electrical.....	9
	Water	9
	Water Supply Options.....	9
	Water Consumption.....	10
	Low Level Reservoir Alarm.....	10
	Cabinet Cut Off Alarm	10
	Drainage.....	10
	Water Reservoir	10
	Connections	11
	Maintenance.....	11
	Drains/Vent	11
	Cabinet Positioning	14
3.	TECHNICAL INFORMATION	15
4.	CONSTRUCTION	15
5.	HEATING SYSTEM.....	16
	Sample chamber	16
	Sat Rh generation	16
	Air humidifier	16
	Temperature control, Sample chamber.....	16
	PROCEDURE TO EXTRACT INFORMATION FROM NANODAC RECORDER	17
6.	CCT CABINET WITH VARIABLE HUMIDITY	22
	Humidity Control and Production	22
	Air humidifier control.....	24
	Cabinet protection	24
7.	TABLE OF SALT SPRAY STANDARDS - ALL MODELS	25
8.	CABINET VARIATIONS	26
9.	PROFILE CONTROLLER.....	28
	Air Purge Function.....	28
	SAMPLE PROGRAM CCT-VH-E.....	28
10.	CHECK LIST	32
11.	SCHEDULED MAINTENANCE	33
12.	TROUBLE SHOOTING	37
	No Humidity.....	37
	No Heat.....	37
13.	OPERATING	38
	Starting to Test - Neutral Salt Solution Test.....	39
14.	GAS SPRINGS - SAFETY REQUIREMENTS	40
	Installation instructions	40

1. CYCLIC CORROSION TEST CHAMBERS

Models SF/2000/CCT, SF/1000/CCT, SF/450/CCT, SF/200/CCT, SF/100/CCT and all VH Models

This range of advanced controlled environment test systems has been developed to enable the corrosion engineer to subject his samples to the following range of conditions quickly, accurately and conveniently.

1. CONTROLLED TEMPERATURE CHANGES.
2. SALT FOG ENVIRONMENT.
3. CONSTANT TEMPERATURE DRYING.
4. FORCED AIR DRYING.
5. CONSTANT TEMPERATURE HIGH HUMIDITY.
6. CYCLIC TEMPERATURE HIGH HUMIDITY.
7. CONSTANT TEMPERATURE VARIABLE HUMIDITY (VH MODELS ONLY).
8. CYCLIC TEMPERATURE VARIABLE HUMIDITY (VH MODELS ONLY).
9. RAIN CYCLE ROOF SPRAY – FORD SPEC (SPECIAL).
10. WALL RINSE CYCLE – RENAULT SPEC (SPECIAL).

These facilities have been incorporated into the system with a user configurable programmer/controller interfaced via a solid state decoder to the various relays and actuators required.

CONTROLLED TEMPERATURE CHANGES

Controlled temperature changes are achieved by programming the temperature to be reached against the rate of change of temperature so that temp/time is a straight line function of variable slope. In addition to just changing temperature other functions can be introduced at the same time, these include washing waste products from the humidity generator after a salt fog spray. The Programmer/Controller used for control of the temperature calls for either heating or cooling dependent upon the slope of the time/temp gradient. The cooling can be switched either on or off independent of the computer to increase the slope of the temperature gradient.

SALT FOG ENVIRONMENT

A specially designed Lucite atomiser jet mounted centrally in the lower half of the sample chamber generates a fine salt mist with the atomised product about 100 microns diameter by the introduction of:

- a) **Air:** Dependant upon the standard to which the machine is required to operate the air supply can be either humidified or dry.

Humidified Air: Compressed, oil free and filtered air is introduced via an air regulator and pressure gauge to a humidifier system where it is heated to a preset temperature and moistened prior to its introduction to the atomiser jet.

Dry Air: Is supplied to the atomiser jet via an air regulator and pressure gauge after being filtered etc. It is not treated in any other way to alter its temperature or moisture content.

- b) **Salt Solution:** The specified salt solution is contained in an external reservoir and is introduced to the jet via an inline filter, a variable speed pump and flowmeter. Accurate control of the flow rate and air pressure enable the operator to quickly and repeatedly adjust the fall out per unit area of the test chamber to that required by the various testing standards.

CONSTANT TEMPERATURE DRYING

Can either take place after a salt fog cycle or a humidity cycle is programmed into the sequence of events predetermined by the test conditions. The temperature in the test chamber is raised by an amount that reduces the humidity of the test chamber to acceptable levels and maintained for the period of time required to dry the surface of the samples THOROUGHLY.

FORCED AIR DRYING

More complete drying can be obtained by the introduction of a quantity of circulating air into the test chamber and also keeping the set temperature at an elevated level.

CONSTANT TEMPERATURE HIGH HUMIDITY

This event normally requires temperatures greater than 35°C but not often higher than 48°C. The test chamber can be set anywhere between these temperatures. Water is introduced into humidity generators and heated by the computer and its associated equipment to maintain the test chamber temperature. The generated humidity level is generally between 90 and 98%, adequate for all specifications.

CYCLIC TEMPERATURE HIGH HUMIDITY

In general this test requires temperature changes between 42°C and 48°C at time intervals of 30 minutes. These temperature changes can be programmed into the controller by the use of a sub program for a number of cycles as required by the various testing specifications. At the end of this sequence the system can revert back to any other part of the combined testing cycle.

COMBINED SEQUENCE TESTING

These events can be combined in a large number of ways to make up a complete sequence of tests. Typical testing cycles contain at least three of the above parameters at different temperatures e.g. salt fog at 35°C, drying at 60°C and humidity at 42°C with time intervals of 4 hours, 2 hours and 2 hours. These variations can be modified at will by entering programs into the memory contained in the programmer/controller.

CONTINUOUS TESTING

The system can easily be programmed to carry out:-

1. Salt Fog Spraying (continuous or intermittent)
2. Constant Temperature High Humidity.
3. Cyclic Temperature High Humidity.
4. Variable Humidity with Variable Temperature (VH Models only).

Programming these events is quite simple and they can be called up from the controller memory at any time after a program reset has been displayed. Another way of obtaining a continuous test is to HOLD the sequence at the appropriate segment. This involves timing the period of the hold, conversely, when using a program an adequate time period can be programmed into the continuous test.

INTERMITTENT TESTING

Again the system can be programmed to carry out intermittent salt fog and drying tests. The Mebon Prohesion test is one that comes to mind as an example of this type of sequence. It is quite a simple matter to program humidity testing with a drying cycle either at elevated temperature or at ambient temperature over a number of sequences.

THE COMPLEXITY OF THE TESTING SEQUENCE IS OVERCOME BY THE SIMPLICITY OF PROGRAMMING THE SYSTEM

2. INSTALLATION

SERVICES REQUIRED:

- 1) Mains Electricity
- 2) Compressed Air Supply
- 3) Water Supply

MAINS ELECTRICITY

2000 litre capacity chamber

SF/2000/CCT

3 Phase Power Supply 380-415V 2Kw/16 Amp per Phase 6Kw (max load)

SF/2000/CCT/VH

3 Phase Power Supply 380-415V 2Kw/16 Amp per Phase 8Kw (max load)

1000 litre capacity chamber

SF/1000/CCT

25 Amp Power Supply 220-240V 50/60Hz 5Kw (max load)

SF/1000/CCT/VH

3 Phase Power Supply 380-415V 2Kw/16 Amp per Phase 8Kw (max load)

450 litre capacity chamber

SF/450/CCT

16 Amp Power Supply 220-240V 60/60Hz 3.2Kw (max load)

SF/450/CCT/VH

25 Amp Power Supply 220-240V 50/60Hz 7Kw (max load)

200 litre capacity chamber

SF/200/CCT

13 Amp Power Supply 220-240V 50/60Hz 2.2Kw (max load)

100 litre capacity chamber

SF/100/CCT

13 Amp Power Supply 220-240V 50/60Hz 2.2Kw (max load)

COMPRESSED AIR SUPPLY

A clean, oil free and filtered air supply is required.

When using mains air, a wall mounted air regulator should be used to reduce the air pressure entering the test chamber to 2-3 Bar (30 - 40 psi).

WATER SUPPLY

A clean water supply should be connected to the test chamber.

In areas known to have a hard water supply, it is recommended to install an inline de-ioniser unit to prevent a build up of calcium deposits on the operative solenoid valve seats and the humidity generator heating elements.

The pressure of the water supply should be regulated to between 2 - 4 Bar (20- 60 psi).

Note It is important to note that min. water pressure should be no less than 2.0 Bar (30 psi).

SERVICES IN PANEL

PLAN VIEW

Condenser Unit – Models HCC/450M, HCC/1000, SF450/CCT/VH, SF/2000/CCT/VH

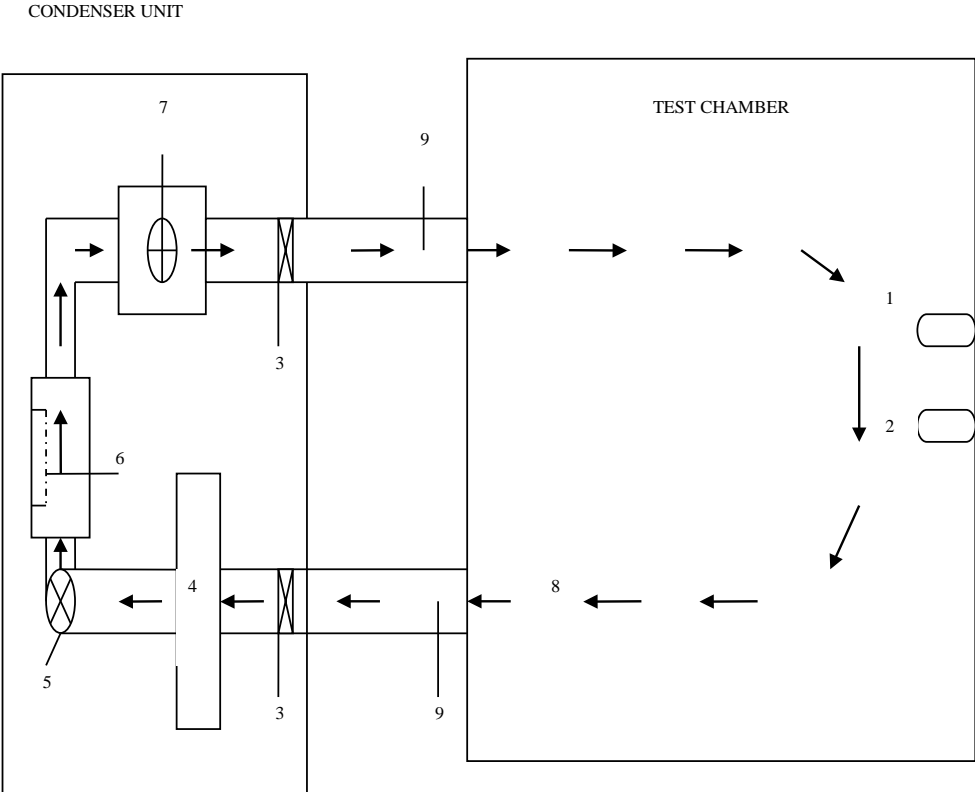

- 1 Temperature sensor
- 2 RH Humidity sensor
- 3 Gas tight pneumatic valves
- 4 Fridge plant cooling/condensing foil
- 5 Air circulation fan

- 6 Air heater
- 7 Ultra sonic humidification unit
- 8 Air circulation
- 9 100mm Ø ducting for air circulation

CONNECTION OF CONDENSER UNIT TO CABINET

Models: SF/CCT/VH – All Models

The above models are supplied with a Condenser Unit, which should be positioned to the left of the cabinet

AIR FLOW AND RETURN PIPES

There are two flexible plastic pipes which should connect the condenser unit to the cabinet.

Push the flexible pipes over the corresponding outlets on the cabinet and condenser unit and then tighten the circular pipe fasteners so that each pipe is secure.

These pipes take the air into the test chamber, which has been conditioned in the condenser unit and then air from the test chamber back into the condenser unit to be re-conditioned.

WARNING NOTE: Water condensate may build up in these pipes and this can be reduced by making sure that there is a “fall” from the condenser unit to the cabinet, allowing the “condensate build up” to flow into the cabinet and then out through the cabinet drain.

If “condensate” continues to build up then you should periodically raise the pipes by hand so that the water runs into the test chamber.

ELECTRICAL

UK MARKET ONLY

All models are manufactured with a mains power connector box at the rear of the cabinet. It will be necessary to connect a suitable cable (20 Amp rated minimum) from the power box at the rear of the cabinet to a wall mounted fused isolator which has the correct supply for the cabinet.

WATER

De-ionised or de-mineralised water should always be used in the cabinet. Failure to use de-ionised or de-mineralised water will result in the filter blocking in the humidification box which will result in no humidity production.

NOTE: The filters should be replaced every eight weeks of use.

WATER SUPPLY OPTIONS

1. MAINS WATER

If a mains water supply is connected to your water reservoir then there must be a de-ionised system in the line to remove the dissolved solids (calcium carbonate).

2. WATER RESERVOIR

If the cabinet is supplied with a water reservoir it will ONLY be in the form of a plastic container, which has a capacity of 114 litres. The reservoir is supplied on castors and comes complete with a lid. The plastic lid should always be kept in place.

Inside the reservoir there is an in-line filter and this should be replaced every approx.10 weeks.

The reservoir is linked to the cabinet by a feed pipe and this should be connected using the push on fitting and locking nut.

The reservoir should be filled with de-ionised or de-mineralised water.

WATER CONSUMPTION

The rate of use of water will vary according to the humidity level set.

Low Consumption

At low humidity set points – Below 50% RH, the rate of water consumption will be low therefore the running time of the cabinet will increase between filling.

High Consumption

At high humidity set points – Above 50% to 98% RH, the rate of water consumption will be high therefore the running time of the cabinet will decrease between filling.

LOW LEVEL RESERVOIR ALARM

Supplied as an optional extra at the time of ordering.

If this has been ordered there will be a low level water sensor in the reservoir. The reservoir will have a power supply from the cabinet so that when a low level situation occurs the low level switch will activate an audible and/or visual alarm to indicate the situation.

CABINET CUT OFF ALARM

Supplied as an optional extra at the time of ordering.

If this has been ordered, there will be a second low level water sensor fitted below the audible low level sensor. Should the operator fail to restore the de-ionised water level then the second low level sensor will be activated and this will switch the cabinet off preventing damage to the cabinet humidification system and cabinet contents.

DRAINAGE

Connect the main drain from the cabinet to a local waste drain close to the cabinet.

1. When the cabinet is operating high humidity levels excess water/condensation will build up in the cabinet and it will drain to waste.
2. When the cabinet is operating at low humidity levels excess water is removed from the chamber and condensed on the cooling coil. This water will be removed via the “condenser drain pipe”.

Connections: The tube from the fitting marked “condenser drain” should be connected to the main cabinet drain or taken to a waste drain close to the cabinet.

Drainage: For guidance see Method of Drainage diagrams.

WATER RESERVOIR

All models are supplied with as standard a 114 litre de-ionised water reservoir. This should be positioned close to the condenser unit. The reservoir will include an internal water filter.

CONNECTIONS

The pipe on the reservoir should be connected to the fitting marked "RH Generator Water In".

The tank should then be filled with de-ionised water or de-mineralised water.

DO NOT CONNECT MAINS WATER TO THE CABINET OR RESERVOIR UNLESS INSTRUCTED TO DO SO.

NOTE: If a reservoir is not supplied with the cabinet then a suitable plastic reservoir should be sourced locally.

Fittings for the reservoir will be supplied and these should be added to your reservoir including the internal water filter.

MAINTENANCE

The filter in the reservoir should be changed every 10 weeks. Filter Ref Code C/28.

DRAINS/VENT

An 1¼" p.v.c. pipe is used to drain away the used Salt Solutions from the test chamber.

It is important that this 1¼" p.v.c. pipe follows a continuous downhill slope to your foul water drain system.

You may wish to insert a U bend in the pipe to eliminate stray odours returning to the test chamber.

METHODS FOR DRAINAGE

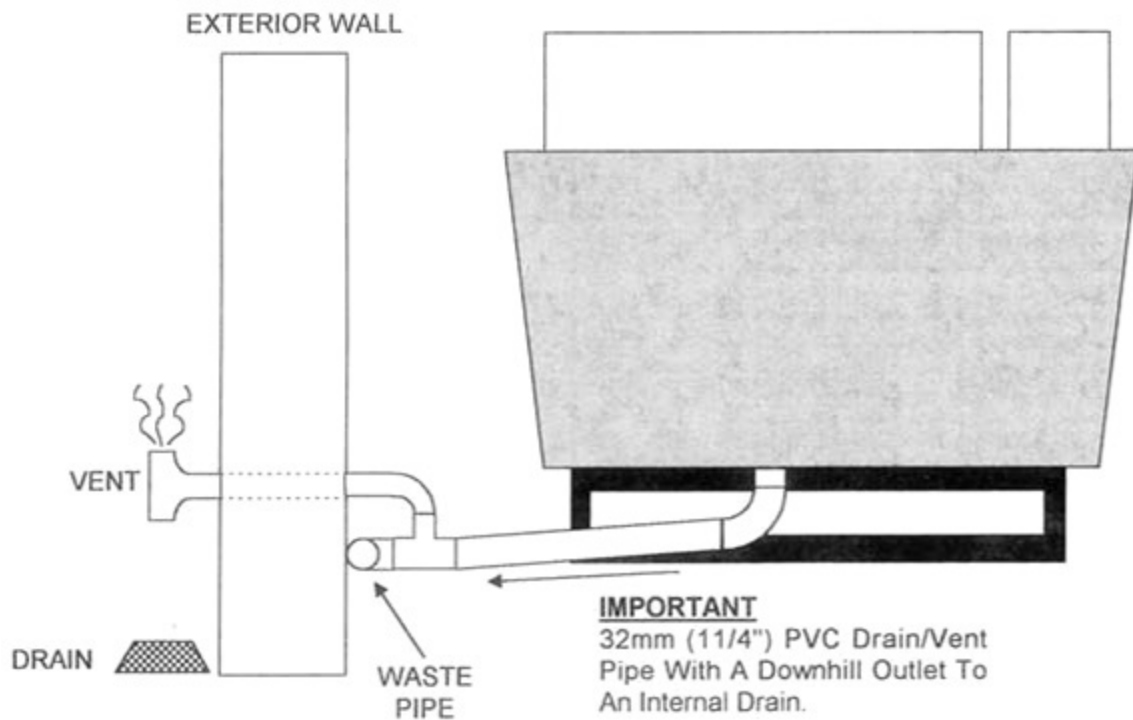
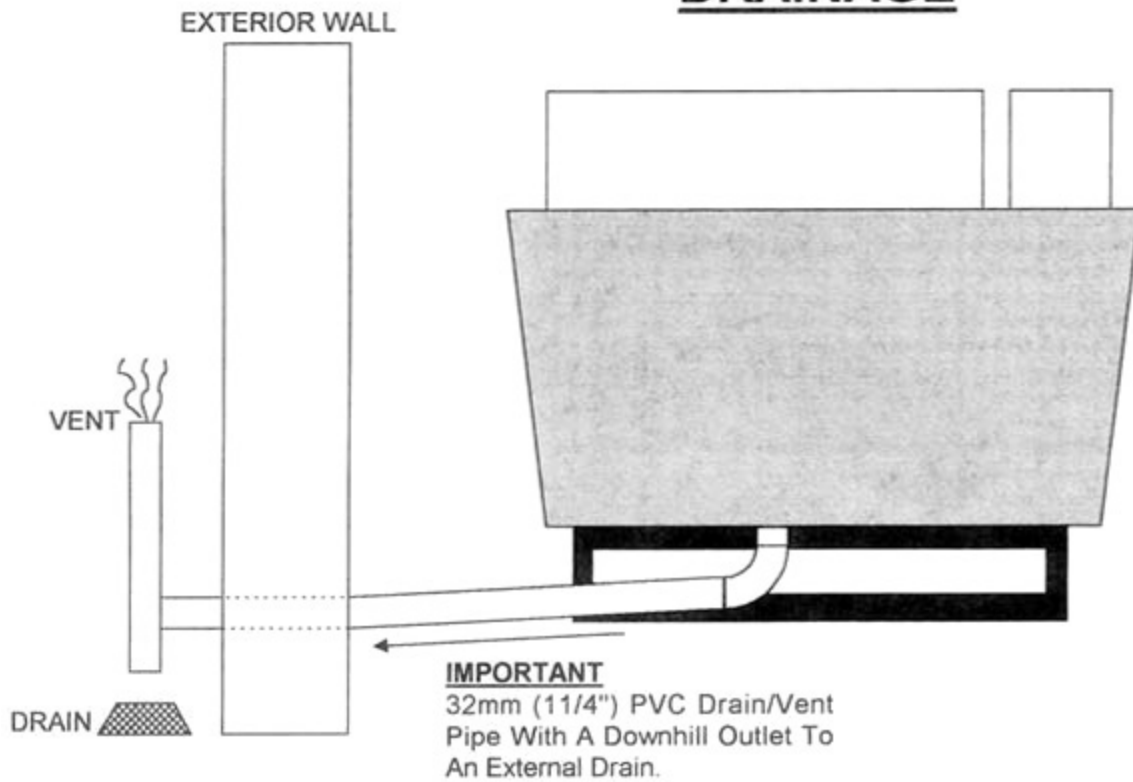

METHODS FOR DRAINAGE

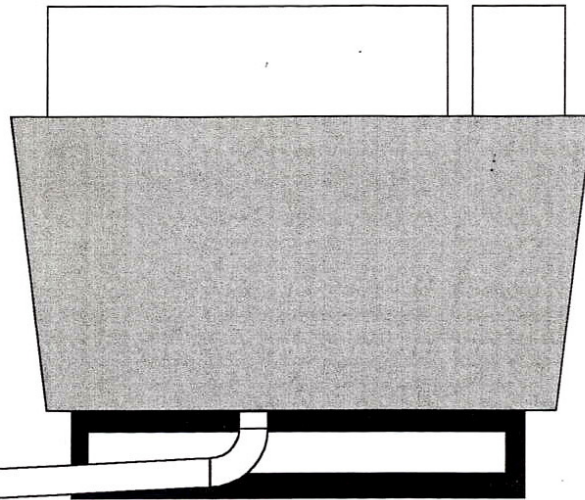
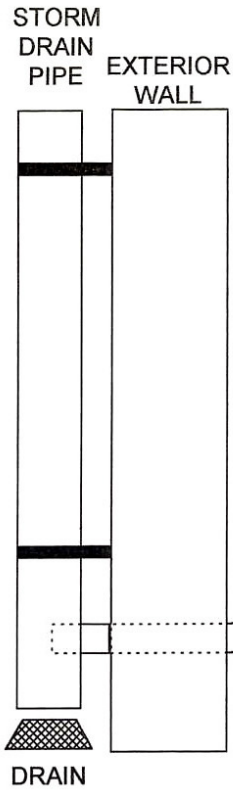

IMPORTANT
32mm (1 1/4") PVC Drain/Vent Pipe With A Downhill Outlet To An External Drain.

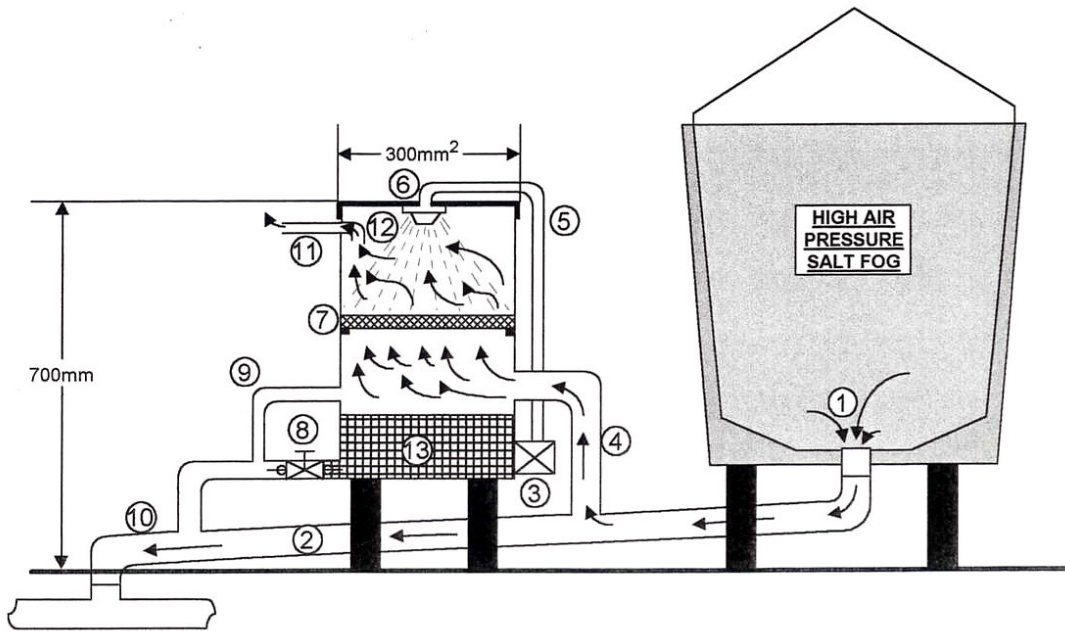

- | | | |
|---|-----------------|---------------------|
| 1 Combined Liquid Drain And Air Escape. | 6 Spray Nozzle. | 11 Clean Air Vent. |
| 2 Drain To Waste. | 7 Filter Bed. | 12 Baffle. |
| 3 Electric Pump. | 8 Drain Tap. | 13 Water Reservoir. |
| 4 Vent Breather Pipe. | 9 Overflow. | |
| 5 Water Spray Line | 10 Drain | |

Essential

It is essential that a T section is inserted into the 1¼" p.v.c. pipe within 1 metre from the test chamber with a rising pipe "**VENT**" being incorporated and routed to an exterior location. This in turn allows any build up of pressure inside the test chamber to vent to atmosphere.

A second drain from the test chamber drains the water from the humidity generator water baths. This should be connected to your 1¼" p.v.c. pipe and allowed to run to your foul water drain system.

CABINET POSITIONING

The test chamber and control module should be placed in a convenient position close to all services (Power, Air, Water and Drain) on a level surface and away from any external heating influence i.e. radiators, heaters, and direct sunlight.

The power input cables should be connected into the "Power In" cable gland on the bottom left hand panel of the control module and connected to terminals 1, 2 and 3 on the Power Chassis (bottom chassis) in the control module.

The connecting leads from the test chamber should be connected into the control module in the same way "Side Wall Heat" "Sink Heat".

The air supply is connected via a hose fitting on the rear right hand side of the test chamber, labeled "AIR INLET".

The water supply is connected via a hose fitting on the rear left hand side of the test chamber, labeled "WATER INLET".

The 1¼" p.v.c. drain/vent pipe exhausts at the rear lower region of the test chamber.

3. TECHNICAL INFORMATION

TEST CHAMBER	100 Litre	200 Litre	450 Litre	750 Litre	1000 Litre	2000 Litre
External Dimensions						
Length	1000 mm	1030 mm	1370 mm	1740 mm	1960 mm	2400 mm
Width	600 mm	700 mm	930 mm	1230 mm	1335 mm	1200 mm
Height	645mm	1050 mm	1130 mm	1365 mm	1410 mm	1645 mm
Internal Dimensions						
Length	600 mm	610 mm	825 mm	1120 mm	1465 mm	2000 mm
Width	450 mm	510 mm	635 mm	870 mm	1040 mm	1000 mm
Height without lid	375 mm	455 mm	620 mm	780 mm	720 mm	850 mm
Height with lid no apex	565 mm	660 mm	875 mm	1070 mm	1065 mm	1175 mm
Panel Capacity						
150mm x 100mm	72	80	132	210	344	516

4. CONSTRUCTION

The outer cabinet is molded from glass reinforced plastic using high temperature polyester resin, colour pale blue. This houses the air humidifier, variable flow pump and the rate of flowmeter. The whole being mounted on load bearing supports for floor mounting.

The internal chamber is molded from self coloured glass reinforced plastic with strengthened sides and floor to carry the sample holders or special fixtures. The floor is capable of carrying considerable weight and will support loads of up to 60 Kilo when distributed over the total area.

The transparent apex roof is of welded construction from polycarbonate sheet with an angle of approximately 115 degrees. Gas springs and hinges make for easy opening and closing. When closed the lid sits in a water trap that is self generating when salt fog or humidity cycles are operated. This water seal prevents the leakage of corrosive material from the test chamber and it holds sufficient liquid to maintain the seal on other cycles of the system program.

5. HEATING SYSTEM

SAMPLE CHAMBER

Panel heaters are mounted onto the outside of the test chamber and insulated from the outer cabinet by low thermal conductive material. This makes for an efficient form of heating with low loss to the outer cabinet wall.

SAT RH GENERATION

In the event of a humidity sequence being called for by the computer then the humidity generator is filled with water. Heaters in the water bath raise the temperature of the sample chamber and keep either a constant or cyclic temperature at humidity levels of between 90% and 98%.

AIR HUMIDIFIER

An immersion heater enclosed in the humidifier tower controlled from a digital temperature controller and on a salt fog cycle holds the humidifier to the preset temperature called for in the testing requirements. This heater can also be controlled from a switch on the main control panel should cool humidified air be called for.

TEMPERATURE CONTROL, SAMPLE CHAMBER

Close control of the sample chamber temperature is obtained from a programmer/controller.

This controller manages the wall heaters and the heaters in the humidity generator, it looks after the rate of change in temperature ramps and the time dwell at each test in the cycle. The outputs from the controller are used to control the ancillary functions associated with the above main functions. A built in protection system prevents the humidity generator heating from being applied in the event of little or no water in the generator reservoirs but maintains the cabinet temperature by use of the side wall heating.

PROCEDURE TO EXTRACT INFORMATION FROM NANODAC RECORDER

1. Plug a memory stick into the USB port on the side of the cabinet.
2. Press the "Page" key on the Recorder.
3. Press the "Down" key until "Log in" is highlighted.
4. Press the "Scroll" key.
5. Press the "Up" key until "Engineer" is highlighted.
6. Press the "Scroll" key until "Password" appears.
7. Press the "Scroll" key.
8. The password is **100**. Scroll until "Numeric" is highlighted then press the "Scroll" key, type in 100 using the numbers on the screen, use the "Scroll" key to enter the password.
9. Press the "Scroll" key then the "Up" key until "Yes" is highlighted, then press the "Scroll" key.
10. Press the "Page" key, then the "Up" or "Down" key until "Demand archiving" is highlighted, then press the "Scroll" key.
11. Press the "Down" key until archive none is highlighted.
12. Press the "Scroll" key, then you can select the archive you want to extract, e.g. last week, last month, all etc.
13. When desired time is set press the "Scroll" key and it will save it to the USB memory stick. When done it will say "Completed".
14. Remove memory stick.
15. To display the saved information on your computer you must first load onto your computer the Eurotherm Product Tools DVD supplied with the machine. The section on the main menu you need for this is the "Review" program.
16. Plug the USB memory stick into your computer and with the "Review" program you should be able to follow the on screen instructions to view or print your temperature and humidity charts. The downloaded file can be converted into a .csx file, for use in Excel, using the software.

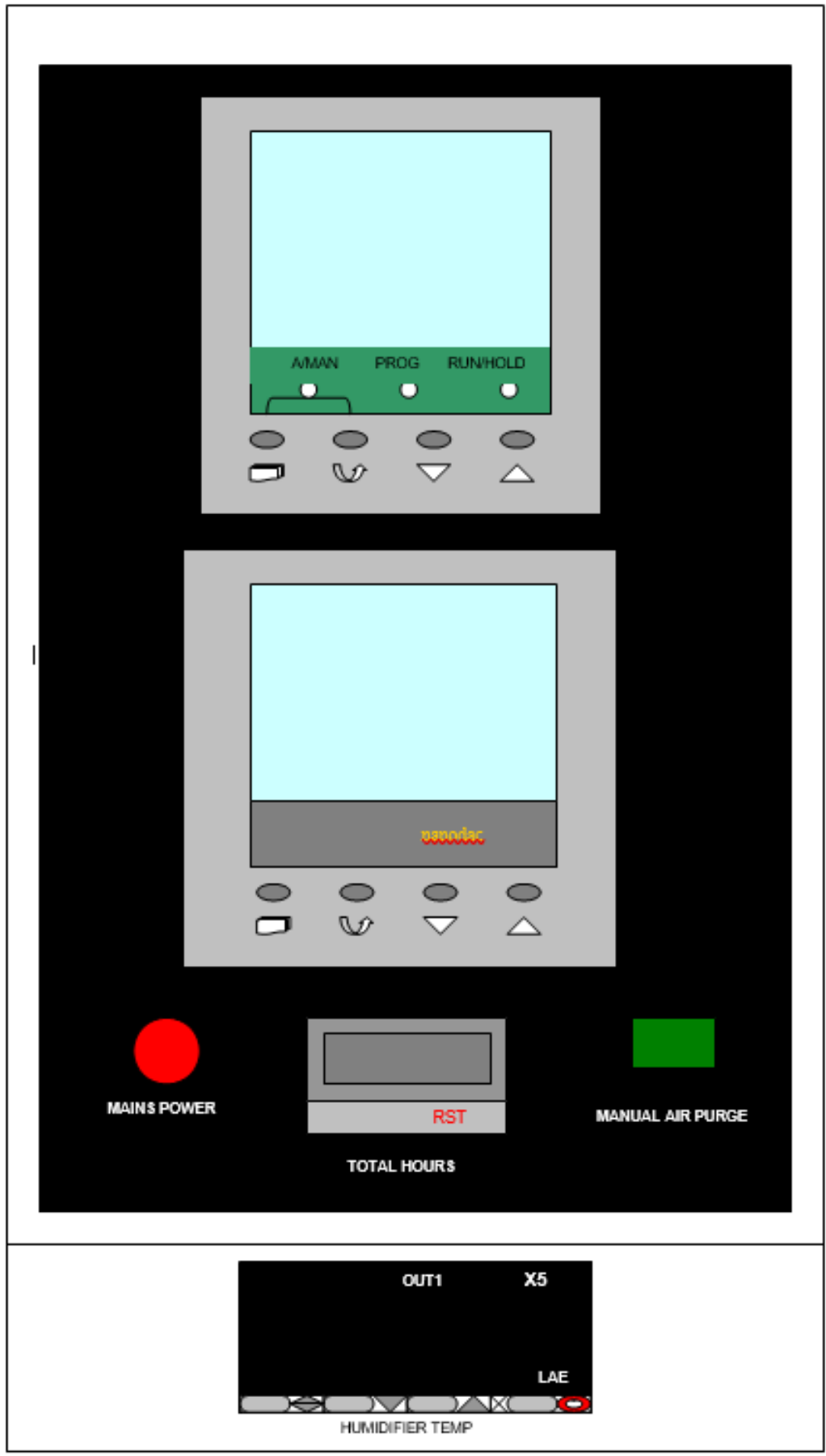

Normal Operation

Switch on the controller. Following a brief self-test sequence, the controller will start up in AUTO mode and show the 'HOME' display in Operator Level 2 (following Quick Start).

If the controller is configured as a dual loop instrument the start up view shows a summary of the two loops.

Note: Views shown in this guide are for 3504 and represent typical examples.

Operator Buttons

A/MAN This button can be disabled	Toggles the selected loop between Auto and Manual operation. In Manual the controller output power is adjusted by the user using buttons. The input sensor is still connected and reading the PV but the control loop is open. 'MAN' will be indicated. In Auto the controller automatically adjusts the output to maintain control, ie the loop is closed. The controller will power up in the mode it was in when it was powered down.	
PROG	To select the programmer summary page	
RUN/HOLD This button can be disabled	Press once to select a program. Press again to run the selected program. 'RUN' will be indicated in the top banner of the display. Press again to hold a program. 'HLD' will be indicated. Press and hold for at least two seconds to reset a program. 'RUN' will flash at the end of a program. 'HLD' will flash during holdback.	
	'ACK'. Press these buttons together to acknowledge an alarm.	
	Press to select new PAGE headings	
	Press to select a new parameter in the page	
	Press to decrease an analogue value, or to change the state of a digital value.	(Any parameter value can be changed if it is preceded by
	Press to increase an analogue value, or to change the state of a digital value	

Shortcut Key Presses

Backpage	Press followed by . With held down continue to press or to scroll page headers backwards or forwards.
Backscroll	When in a list of parameters, press followed by . With held down continue to press or to scroll parameters backwards or forwards.
Jump to HOME display	Press +

Typical Home Display

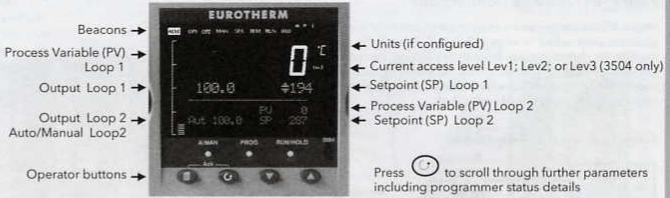

If the controller is configured as a dual loop the HOME displays will vary as shown here:-



Beacons

OP1	illuminates when output 1 is ON (normally heating)
OP2	illuminates when output 2 is ON (normally cooling or alarm)
MAN	illuminates when manual mode active. If the HOME display is showing the dual loop overview, MAN illuminates if Loop 1 is in manual. If the Loop 1 or Loop 2 overviews are being displayed MAN applies to the loop being displayed.
REM	illuminates when alternative setpoint is active
SPX	illuminates when setpoint 2 is active
ALM	If an alarm occurs the red alarm beacon flashes together with a message showing the source of the alarm, for example 'AnAlm1 - Abs Hi' (the latter can also be a customised message). When acknowledged the alarm message disappears. If the alarm condition is still present the beacon lights continuously. For non-latched alarms it will extinguish when the alarm is cleared.
RUN	illuminates when the programmer running - flashing indicates End
HLD	illuminates when the programmer is in Hold (frozen)
J	Flashes when J Channel digital communications is active
H	Flashes when H Channel digital communications is active
IR	On when infra red communications is enabled and flashes when infra red communications is active

To Set The Required Temperature (Setpoint)

In the view above, press or to lower or raise the setpoint value of Loop 1.

The new setpoint is accepted when or is released and is indicated by a brief flash of the setpoint value.

To change Loop 2 setpoint, press . Loop 2 SP value is preceded by . Press or as above to change the value.

A momentary press of either button will show the setpoint in use, e.g. SP1.

Example: To Create or Edit a Program

This example shows how the operator buttons are used to set up a program.

The principle is the same for all features.

A program can only be edited when it is in Reset or Hold.

Select a program	Press to select the 'Program Edit' page Press or to select the program number
Set up a holdback value *	Press to select 'Ch1/2HldBkVal' Press or to set the value
Set up the number of times a program repeats *	Press again to select 'Cycles' Press or to choose the number of cycles
Set up or edit a segment	Press to select 'Segment' Press or to choose the segment number
Set up the segment type	Press to select 'Segment Type' Press or to choose the segment type
The parameters which follow depend on the segment type chosen.	
Set up the value of SP required at the end of the segment	Press to select 'Target SP' for Ch1 and Ch2. Press or to choose the value
Set up the segment time	Press to select 'Duration'. Press or to choose the value
Set up 'Holdback Type' *	Press to select 'Ch1/2HldBck Type'. Press or to choose the value
Set up which events operate in the segment *	Press to select 'Event Outs'. Press or to turn the event on or off.

* These parameters are only shown if the feature has been configured. See the Engineering manual HA0278988 for further information. Repeat the above procedure for further segments required in the program. The final segment should be configured as 'End'. You can then set up the action required at the end of the program. This may be 'Dwell', 'Reset' or 'SafeOP'.

♦ The following choices are available, depending on programmer type. For example SyncAll offers Wait, Time and End only:-

Rate	Rate of change of setpoint
Time	Time to target
Dwell	Soak at constant setpoint
Step	Step change to new setpoint
Wait	Wait for pre-determined condition
GoBack	Repeat previous segments
Call	Insert a new program
End	Final segment

Holdback freezes the program if the process value (PV) does not track the setpoint (SP) by more than a user defined amount. The instrument will remain in HOLDBACK until the PV returns to within the requested deviation from setpoint. The display will flash the HOLD beacon.

Holdback Type may be selected from:-

Off	No holdback
Band	Deviation high & low
High	Deviation high
Low	Deviation low

Example: To Select and Run a Program

This example assumes the program has been entered as described.

Press	Select a program	Press or to choose the program number to be run
Press	Run the selected program	Press again
Press	Hold a program	Press
Press and hold	Reset a program	Press and hold for at least 3 seconds

Alternatively, run, hold or reset a program by scrolling to 'Program Status' using and select 'Run', 'Hold' or 'Reset' using or .

The button (3504 only) provides a short cut to the Program Status page from any view.

To inspect/change the status of a running program, press to select the 'Program Status' list and to select parameters.

Access Levels

Parameters are available in deeper levels of access protected by different levels of security.

Lev1 and Lev2 are intended for day to day operation. It is possible to configure a limited number of parameters in either level.

Lev3 provides a much greater access to parameters. Typically these are parameters used when commissioning a system.

Config. To change the fundamental characteristics of the instrument. Each level (except 1) is protected by a security code. The security codes can be changed in Configuration level as described in the Engineering Handbook HA027988.

To Select an Access Level

Press and hold until the display shows 'Access'.

Press or to 'Goto' the required access level

Press or to enter a security code. For level 2 the default is 2. When the correct pass code has been entered 'Pass' is displayed momentarily and the controller returns to the HOME display in the level of operation selected.

It is not necessary to enter a pass code when going from a higher level to a lower level.

PROGRAM EVENTS

1. **SALT SPRAY**
2. **SATURATED HUMIDITY**
3. **VARIABLE HUMIDITY**
4. **AIR PURGE**
5. **DRAIN SINKS**
6. **SPARE**

6. CCT CABINET WITH VARIABLE HUMIDITY

MODELS SF/450/CCT/VH AND SF/1000/CCT/VH

The CCT Cabinet with Variable Humidity retains all the original features of the conventional CCT Cabinet, allowing testing with Salt Spray, Dry Heat Cycles, Cyclic Prohesion and Humidity with both constant temperature or cycling temperature and with any humidity level set point between 15% and 95% at temperatures between ambient and 60°C.

The standard features still include:-

- The high chemical resistant GRP test chamber.
- An independent control console allowing full access for installation and servicing.
- An apex roof unit supported by gas springs for smooth operation, resting in the self fitting seal.
- The heavy duty variable speed Peristaltic Pump allows a constant flow of salt solution to the spray jet nozzle.
- A flush mounted Flowmeter monitors the flow of salt solution to the spray jet nozzle.
- The Air Regulator and Air Gauge control and monitor the air pressure at the spray jet nozzle.
- The internal Humidifier Tower together with its air and water valve circuitry protects against overheating and allows automatic water level control, enabling moist (humid) air to be achieved and so complies to all the major specified Salt Spray Standards.
- An external Salt Solution Reservoir of 114 litre capacity, mounted on hard wearing nylon castors allows long uninterrupted testing and accessibility for filling and cleaning.
- A Dual Loop Controller/Programmer allows for dual control of both temperature and humidity. This microprocessor based Controller/Programmer gives full P.I.D. terms for accurate stable control.

A possible 25 programs are available and can be stored in the memory until required.

HUMIDITY CONTROL AND PRODUCTION

A) Variable Humidity

The cabinets are supplied with a “Condenser Unit” which sits next to the test cabinet and is connected by “Flow” and “Return” ducting pipes, through which conditioned air is introduced into the test chamber, and cabinet air which requires re-conditioning is returned to the condenser unit.

The Condenser Unit consists of the following:-

1. **Air Flow Heater** – This heats the air to the required set point prior to the introduction to the test chamber.

2. Humidification System – The humidification system consists of ultra sonic transducers mounted in a stainless steel box and submerged in water. When activated the ultra sonic transducers charge the water molecules into a fine mist which is then introduced into the main air stream and transported into the chamber. The on/off action is controlled via the humidity sensor located inside the test area. The water level in the humidification system is automatically controlled by a liquid level sensor which activates a water solenoid valve when on low water. The mist generated by the ultra sonic system is introduced into the “flow in” ducting and then into the chamber.

3. Condenser Cooling Coil – The condenser cooling coil is positioned so that the air returning from the test chamber passes over the refrigerated coil and if the moisture content (RH humidity level) of the air is the set point humidity required, the excess moisture is removed from the air to produce the level of humidity required.

For example:

Humidity level set point is 60% RH
Air Temperature set point is 50°C

If the humidity level is only 50% RH the “ultra sonic” humidifier will be on to humidity to bring it up to the 60% RH set point.

If the air temperature is only 45°C then the air flow heater will be on to increase the air temperature to the required set point of 50°C.

If the humidity level in the test chamber is 64% RH then the condenser cooling coil will be on to condense the moisture (remove the excess moisture) that it drops to the set point of 60% RH.

If the air temperature is 54°C then the condenser coil will, because it is cool, lower the temperature down to the set point.

4. RH Sensor and Temperature Sensor – Inside the test chamber there is a RH Humidity Sensor and a Temperature Sensor.

5. Flow and Return Duct Valves – In both the “flow in” and “return” ducts there are pneumatic valves which are opened automatically when the condenser unit is in operation. These valves prevent the air borne corrosive salts produced during a salt spray cycle from entering the condenser unit.

B) Constant High Humidity

When humidity levels of 93% to 100% RH are required then the water baths situated in the base of the cabinet are automatically filled with water. The water is then heated to generate steam and a high level of humidity to saturation.

The CCT Cabinets with Variable Humidity will perform all of the major Cyclic Corrosion Test Standards, Humidity Standards and Salt Spray Standards.

The temperature range for Salt Spray is 70°C max.

The humidity level uncontrolled is 95% to 100% saturation.

The controlled humidity levels are between 15% RH and 95% RH at temperatures between ambient and 60°C.

The dry heat temperature is 80°C max.

The CCT-VH models will also perform the following tests:

- MIL-STD-810 F/G + DO-160F Humidity and Salt Spray Sections
- VW – PVW 1210
- VDA – VDA 621-415
- FORD – APGT B1 123-01
- VOLVO – VICT STD 1027-1375
- GENERAL MOTORS 9540 P GMW 14872
- BMW AAP 174
- JS G810-879
- HONDA B801
- NISSAN M0007
- SAE J 2334
- TOYOTA TSH 1555G

NOTE: There are many National, International and Corporate test methods for Salt Spray, Humidity and CCT, we try and keep informed about these and our library is extensive. If the test method or standard that you use is not listed it does not mean that our cabinet will not perform it. Please ask.

AIR HUMIDIFIER CONTROL

The temperature of the air humidifier system is derived from a sensor mounted in the immersion heater thermostat pocket and connected to a simple accurate digital readout control system. The system controls the water temperature to within $\pm 1^{\circ}\text{C}$ adequate for the requirements of this part of the system. Protection of the humidifier in the event of low or no water is as follows. Air is diverted from the system and the immersion heater is switched off. When low water is detected, an air relief valve opens and water is let into the container until it is topped up, air and heating are then restored and humidified air is again used to create the salt fog spray.

CABINET PROTECTION

In the event of any electrical parts failing, protection of the cabinet is by a series of fuses or over current cutouts, these protect the heaters, the control equipment, the air humidifier system and the cooling fans. The controllers are open circuit sensor protected, the immersion heaters in the humidifier generators are protected by a low water float switch and by thermal fuses. Over temperature protection of the sample chamber is by an alarm signal releasing a relay in series with the heating conductors and thus switching off the heating until the alarm is released either by the operator or when the fault conditions have cleared.

7. TABLE OF SALT SPRAY STANDARDS - ALL MODELS

Our cabinets meet the requirements for testing according to the following standards:

Standard	Spray Cycle	Atomiser Air	Cabinet Temp	Fall out (ml) per <u>80cm²/hr</u>
----------	-------------	--------------	--------------	--

BRITISH

BS 2011:Part 2.1Ka	Continuous	-	35°C	0.5 to 3.0
BS 3900 F4	Continuous	-	20°C	-
BS 3900 F12 (ISO 7253 1984)	Continuous	95 - 98% RH	35°C	0.1 to 2.0
BS 5466 Part 1(ISO 3768 1976) Part 2(ISO 3769 1976) Part 3(ISO 3770 1976)	Continuous	95 - 98% RH	35°C	-
BS AU148 Part 2	Continuous	-	+25°C	1.0 to 2.0
DEF 133	Continuous	-	+35°C	-
DEF 1053 Method 24	Continuous	-	35°C	-
DEF 1053 Method 36	Intermittent 10 mins/hour	-	-	-

AMERICAN

ASTM B117	Continuous	95 - 98% RH	35°C	1.0 to 2.0
ASTM B287	Continuous	95 - 98% RH	35°C	0.75 to 2.0
ASTM B368 CASS	Continuous	95 - 98% RH	49°C	1.0 to 2.0
MIL STD 202E	Continuous	95 - 98% RH	35°C	0.5 to 3.0
MIL STD 810C	Continuous	-	35°C	0.5 to 3.0

GERMAN

DIN 50.907	Intermittent 5 mins/hour	-	20°C	-
SS DIN 50.021	Continuous	95 - 98% RH	35°C	-
ESS DIN 50.021	Continuous	95 - 98% RH	35°C	1.5
CASS DIN 50.021	Continuous	95 - 98% RH	50°C	1.5
DIN 40.046	Continuous	-	35°C	0.5 to 3.0
VG 95210	Continuous	-	35°C	0.5 to 3.0
VG 95332	Continuous	-	35°C	2.0

FRENCH

CCT U01 01A	Continuous	-	35°C	0.5 to 3.0
PN-X 14-002	Continuous	84 - 90% RH	35°C	0.5 to 3.0

Mebon Prohesion® Test - Cabinet Model No. SF/MP4 will carry out all the above standards and the Mebon Prohesion Test.

®Prohesion is the Registered Trade Mark of Mebon Paints Plc

8. CABINET VARIATIONS

The following facilities could be fitted to the basic CCT/VH Cabinets during the initial build. If you require an option at a later stage please contact your sales representative.

A. WALL RINSING FACILITY

1. Standards and Test Methods Applicable

Renault D17-2028/--C (ECC1)

2. Equipment

Fixed around the top inside wall of the cabinet is a plastic pipe which has 1mm holes evenly spaced, directed at the inner wall. A supply of demineralised water is connected to the rear of the cabinet by means of a 10mm ID plastic pipe. The pressure of the water supply should be 3 Bar and it must be constantly available to meet the cyclic requirements of the test method.

3. Function

All the cabinet walls are rinsed according to the test method. When programmed a solenoid valve opens allowing the supply of demineralised water to be forced around the plastic pipe system and directed onto the cabinet walls. At the end of the wall rinsing phase the solenoid valve closes and the supply of water is stopped.

4. Action

The action of the "Wall Rinse Phase" removes sodium chloride salts deposited on the cabinet walls during the salt spray phase. The wall rinse phase prevents the accumulation of salts during the cyclic action of the cabinet as it has been found that a concentration of salts can influence the profile of the Relative Humidity during the controlled humidity cycles.

5. Duration

The wall rinse phase can be programmed from 5 minutes to continuous in any sequence.

B. ROOF SPRAY SYSTEM FACILITY

1. Standards and Test Methods Applicable

FORD CETP 00.00-L-467
VOLVO STD 423-0014

2. Equipment

Mounted on the internal apex of the cabinet roof is a "Swaying Tube" which rotates automatically front to back, back to front to distribute salt solution uniformly over the test area. Mounted to the "Swaying Tube" are nozzles that produce a fan plume which is overlapping, ensuring that test samples are all totally wetted. These nozzles will need to be cleaned at regular intervals to prevent blocking and they should be checked every month or between tests.

3. Function

The target average precipitation (wetting) rate distributed over the cabinet is between 5L/m² and 10L/m² over a 6 hour wet period.

4. Action

The action of the roof spray is activated by the program controller. When required a high pressure flow pump which is connected to a 114 litre reservoir containing the required salt solution (5%), is automatically switched on to wet the samples. The filter in this reservoir should be changed every 12 months but checked every 3 months.

5. Duration

Roof spray cycles are programmed as per the standard from 3 minutes to 10 minutes.

Cylindrical beakers 6cm to 10cm diameter should be positioned in the base of the cabinet.

Collection rates between 50ml and 100ml total collection per beaker.

Example of spraying device

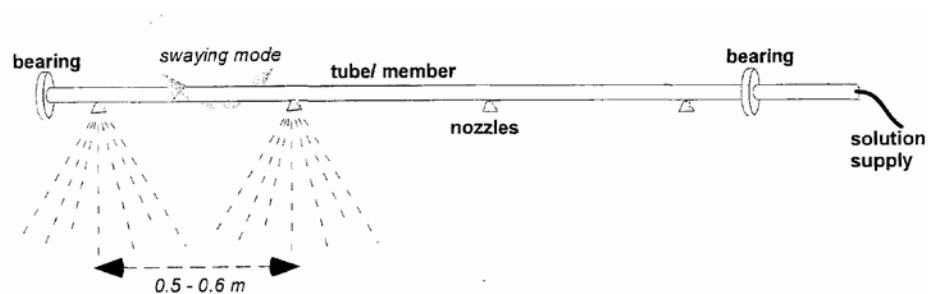

6. There is a "Low Level Solution" cut off switch in the reservoir which will automatically switch off the power supply to the pump when low reservoir levels are reached.

ALWAYS CHECK RESERVOIR IS FULL BEFORE STARTING TESTS AND DURING TESTING. THE RESERVOIR WILL LAST 7 DAYS CONTINUOUS OPERATION.

7. The high pressure flow pump is located inside the condensing unit, access via front grill to lower shelf.

9. PROFILE CONTROLLER

AIR PURGE FUNCTION

Air Purge can be programmed to automatically operate as part of cyclic program or there is a manual purge button on the front console which enables users to purge the cabinet before opening the lid.

SAMPLE PROGRAM CCT-VH-E

PROGRAM 1 – FORD BI 123-03

NOTE: PROGRAM 1 MUST BE RESET BEFORE YOU CAN EDIT IT.

1. Press the Page Key until you come to "Program Edit" page.
2. Press the Up Key to select Program 1.
3. Press the Scroll Key to select "Cycles" and set to "Continuous".
4. Press the Scroll Key to select "Segment Type".
5. Press the Up Key to select "Time".
6. Press the Scroll Key to select "Ch1 Target sp".
7. Press the Up Key and set to 23°C.
8. Press the Scroll Key to select "Ch2 Target sp".
9. Press the Up Key and set to 50%.
10. Press the Scroll Key to select "Duration".
11. Press the Up Key and set to "00.1" (1 minute).
12. Press the Scroll Key to select "Events".
13. Press the Scroll Key until you reach the seventh box.
Press the Up Key to select Event 5 and 1 and fill the box.
14. Press the Scroll Key to select "Segment Type". This is Segment 2.
15. Press the Up Key and select "Time".
16. Press the Scroll Key to select "Ch1 Target sp".
17. Press the Up Key and set to 23°C.
18. Press the Scroll Key to select "Ch2 Target sp".
19. Press the Up Key and set to 50%.
20. Press the Scroll Key to select "Duration".
21. Press the Up Key and set to "00.4" (4 minutes).
22. Press the Scroll Key to select "Events".
23. Press the Scroll Key until seventh box, press the Up Key to select Event 1 and 5 and fill box
24. Press the Scroll Key to select "Segment Type".
25. Press the Up Key to select "Time".
26. Press the Scroll Key to select "Ch1 Target sp".
27. Press the Up Key and set to 23°C.
28. Press the Scroll Key to select "Ch2 Target sp".
29. Press the Up Key and set to 50%.
30. Press the Scroll Key to select "Duration".
31. Press the Up Key and set to "00.1" (1 minute).
32. Press the Scroll Key to select "Events".
33. Press the Scroll Key until you reach the seventh box.
Press the Up Key to select Event 5 and 1 and fill the box.
34. Press the Scroll Key to select "Segment Type".
This is Segment 3.
35. Press the Up Key and select "Time".
36. Press the Scroll Key to select "Ch1 Target sp".
37. Press the Up Key and set to 23°C.
38. Press the Scroll Key to select "Ch2 Target sp".
39. Press the Up Key and set to 50%.
40. Press the Scroll Key to select "Duration".

41. Press the Up Key and set to "00.4" (4 minutes).
42. Press the Scroll Key to select "Events".
43. Press the Scroll Key until seventh box, press the Up Key to select Event 1 and 5 and fill box
44. Press the Scroll Key to select "Segment Type".
45. Press the Up Key to select "Time".
46. Press the Scroll Key to select "Ch1 Target sp".
47. Press the Up Key and set to 23°C.
48. Press the Scroll Key to select "Ch2 Target sp".
49. Press the Up Key and set to 50%.
50. Press the Scroll Key to select "Duration".
51. Press the Up Key and set to "00.1" (1 minute).
52. Press the Scroll Key to select "Events".
53. Press the Scroll Key until you reach the seventh box.
Press the Up Key to select Event 5 and 1 and fill the box.
54. Press the Scroll Key to select "Segment Type". This is Segment 4.
55. Press the Up Key and select "Time".
56. Press the Scroll Key to select "Ch1 Target sp".
57. Press the Up Key and set to 23°C.
58. Press the Scroll Key to select "Ch2 Target sp".
59. Press the Up Key and set to 50%.
60. Press the Scroll Key to select "Duration".
61. Press the Up Key and set to "00.4" (4 minutes).
62. Press the Scroll Key to select "Events".
63. Press the Scroll Key until seventh box, press the Up Key to select Event 1 and 5 and fill box
64. Press the Scroll Key to select "Segment Type".
This is Segment 5.
65. Press the Up Key and select "Time".
66. Press the Scroll Key to select "Ch1 Target sp".
67. Press the Up Key and set to 23°C.
68. Press the Scroll Key to select "Ch2 Target sp".
69. Press the Up Key and set to 50%.
70. Press the Scroll Key to select "Duration".
71. Press the Up Key and set to "00.01" (1 minute).
72. Press the Scroll Key to select "Events".
73. Press the Scroll Key until you reach the seventh box.
Press the Up Key to select Event 1 and 5 fill the box.
74. Press the Scroll Key to select "Segment Type". This is Segment 6.
75. Press the Up Key and select "Time".
76. Press the Scroll Key to select "Ch1 Target sp".
77. Press the Up Key and set to 23°C.
78. Press the Scroll Key to select "Ch2 Target sp".
79. Press the Up Key and set to 50%.
80. Press the Scroll Key to select "Duration".
81. Press the Up Key and set to "00.04" (4 minutes).
82. Press the Scroll Key to select "Events".
83. Press the Scroll Key to Select Events 1, 4 and 5 fill the box.
84. Press the Scroll Key to select "Segment Type". This is Segment 7.
85. Press the Up Key and select "Time".
86. Press the Scroll Key to select "Ch1 Target sp".
87. Press the Up Key and set to 55°C.
88. Press the Scroll Key to select "Ch2 Target sp".
89. Press the Up Key and set to 10%.
90. Press the Scroll Key to select "Duration".
91. Press the Up Key and set to "00.05" (5 minutes).
92. Press the Scroll Key to select "Events".
93. Press the Scroll Key until you reach the seventh box.
Press the Up Key to select Event 4 and 5 and fill the box.
94. Press the Scroll Key to select "Segment Type".
This is Segment 8.

95. Press the Up Key and select "Time".
96. Press the Scroll Key to select "Ch1 Target sp".
97. Press the Up Key and set to 55°C.
98. Press the Scroll Key to select "Ch2 Target sp".
99. Press the Up Key and set to 10%.
100. Press the Scroll Key to select "Duration".
101. Press the Up Key and set to "00.10" (10 minutes).
102. Press the Scroll Key to select "Events".
103. Select no events.
104. Press the Scroll Key to select "Segment Type".
This is Segment 9.
105. Press the Up Key and select "Time".
106. Press the Scroll Key to select "Ch1 Target sp".
107. Press the Up Key and set to 55°C.
108. Press the Scroll Key to select "Ch2 Target sp".
109. Press the Up Key and set to 10%.
110. Press the Scroll Key to set "Duration".
111. Press the Up Key and set to "00.15" (15 minutes).
112. Press the Scroll Key to select "Events".
113. Press the Scroll Key until you reach the seventh box.
Press the Up Key to select Event 3 fill the box.
114. Press the Scroll Key to select "Segment Type".
This is Segment 10.
115. Press the Up Key to select "time".
116. Press the Scroll Key to select "Ch1 Target sp".
117. Press the Up Key and set to 55°C.
118. Press the Scroll Key to select "Ch2 Target sp".
119. Press the Up Key and set to 10%.
120. Press the Scroll Key to set "Duration".
121. Press the Up Key and set to "02.30" (2 hours 30 minutes).
122. Press the Scroll Key to select "Events".
123. Press the Scroll Key until you reach the third box.
Press the Up Key to select Event 3 and fill the box.
124. Press the Scroll Key to select "Segment Type". This is Segment 11.
125. Press the Up Key and select "Time".
126. Press the Scroll Key to select "Ch1 Target sp".
127. Press the Up Key and set to 50°C.
128. Press the Scroll Key to select "Ch2 Target sp".
129. Press the Up Key and set to 85%.
130. Press the Scroll Key to set "Duration".
131. Press the Up Key and set to "00.05" (5 minutes).
132. Press the Scroll Key to select "Events".
133. Press the Scroll Key until you reach the third box.
Press the Up Key to select Event 2 and 3 and fill the box.
134. Press the Scroll Key to select "Segment Type".
This is Segment 12.
135. Press the Up Key and select "Time".
136. Press the Scroll Key to select "Ch1 Target sp".
137. Press the Up Key and set to 50°C.
138. Press the Scroll Key to select "Ch2 Target sp".
139. Press the Up Key and set to 85%.
140. Press the Scroll Key to set "Duration".
141. Press the Up Key and set to "00.25" (25 minutes).
142. Press the Scroll Key to select "Events".
143. Press the Scroll Key until you reach the third box.
Press the Up Key to select Event 2 and 3 and fill the box.
144. Press the Scroll Key to select "Segment Type".
This is Segment 13.
145. Press the Up Key and select "Time".

146. Press the Scroll Key to select "Ch1 Target sp".
147. Press the Up Key and set to 50°C.
148. Press the Scroll Key to select "Ch2 Target sp".
149. Press the Up Key and set to 85%.
150. Press the Scroll Key to set "Duration".
151. Press the Up Key and set to "20.15" (20 hours 15 minutes).
152. Press the Scroll Key to select "Events".
153. Press the Scroll Key until you reach the third box.
Press the Up Key to select Event 2 and 3 and fill the box.
154. Press the Scroll Key to select "Segment Type".
This is Segment 14.
155. Press the Up Key to select "Go back".
156. Press the Scroll Key to select "Go back seg".
157. Press the Up Key to Select "1" (go back to segment 1).
158. Press the Scroll Key to select "Go back cycles".
159. Press the Up Key to select "5".
It will now repeat Segment 1 to 12, 4 times.
160. Press the Scroll Key to select "Segment Type".
This is Segment 15.
161. Press the Up Key to select "Time".
162. Press the Scroll Key to select "Ch1 Target sp".
163. Press the Up Key and set to 50°C.
164. Press the Scroll Key to select "Ch2 Target sp".
165. Press the Up Key and set to 85%.
166. Press the Scroll Key to select "Duration".
167. Press the Up Key and set to "48.00" (48 hours).
168. Press the Scroll Key to select "Events".
169. Press the Scroll Key until you reach the third box.
Press the Up Key to select Event 2 and 3 and fill the box.
170. Press the Scroll Key to select "Segment Type".
This is Segment 16.
171. Press the Up Key and select "END".
172. The Program can now be run.
173. Press the "Run" Key.
174. Press the Up Key and select "1".
175. Press Run to run Program 1.

10. CHECK LIST

1. Samples are placed in the test chamber so that they do not obstruct the flow and return air ports.
2. The cabinet lid seals correctly i.e. sufficient water in trap and seal not damaged.
3. Humidity level required is set on the program controller.
4. Temperature level required is set on the program controller.
5. Water reservoir is connected and the pipe is not twisted or folded which could restrict the flow.
6. The water reservoir is filled with de-ionised water and the filter is in position.
7. The peristaltic pump head is rotating and there is the required flow showing on the flowmeter.
8. The drains from the cabinet and from the condenser are connected.
9. The flexible flow and return pipes between the condenser unit and the test chamber are connected and sealed.

11. SCHEDULED MAINTENANCE

1. After approximately 1000 hours it is recommended that the tubing in the pump head is replaced (see drawing instruction page).

The silicone tubing used is a tough tubing, however, if it is not replaced at the suggested intervals it will eventually wear and split, depositing salt solution onto the pump motor and surrounding area.

2. At least once every 10 weeks the disposable salt solution filter in the salt solution reservoir should be replaced. It may be necessary to replace this filter more frequently depending on the quality of water used.
3. It is policy for our service engineers to exercise the above procedure should you employ our service and calibration contract offered on an annual basis 12 months after delivery of your cabinet.

HOW TO CHANGE THE TUBING ON A PERISTALTIC PUMP

1. Twist the pump cover 30° anti-clockwise until it unlocks. See Fig. 2
2. Remove pump cover from grey pump housing. See Fig. 3
3. Unclip grey clips from bottom of inside of pump cover. See Fig. 4
4. Remove tube and grey locking clips from pump cover. See Fig. 5
5. Remove grey locking clips from tubing. See Fig. 5
6. Unscrew blue locking caps on pump panel to allow old tube to be pulled off. Remove old tubing and discard. Clean off old dust or debris from pump head. See Fig. 6
7. Cut new length of silicone tube at least 600mm long. See Fig. 7
8. Place flat blade screwdriver in location position in centre white pump rotation drum and turn slowly clockwise to feed the new tube into the channel between the pump rotation drum and the pump cover. See Fig. 7
9. Attach grey locking clip onto tube on both sides and push back into position on pump cover. Ensure the correct fitment of the locking clips when attaching to the pump head, as incorrect fitment will damage the pump and invalidate any warranty. See Fig. 7 / 8
10. Put blue locking caps back onto the tube and reconnect the tube onto the blue fittings on the pump panel and tighten. See Fig. 8, 9 & 10
11. Reposition pump cover locating the centre onto the white plastic drive shaft and lock cover by turning clockwise onto the grey housing. See Fig. 11 & 12.
12. Finished! See Fig. 1

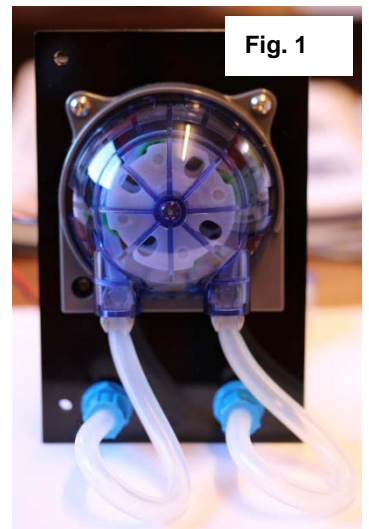

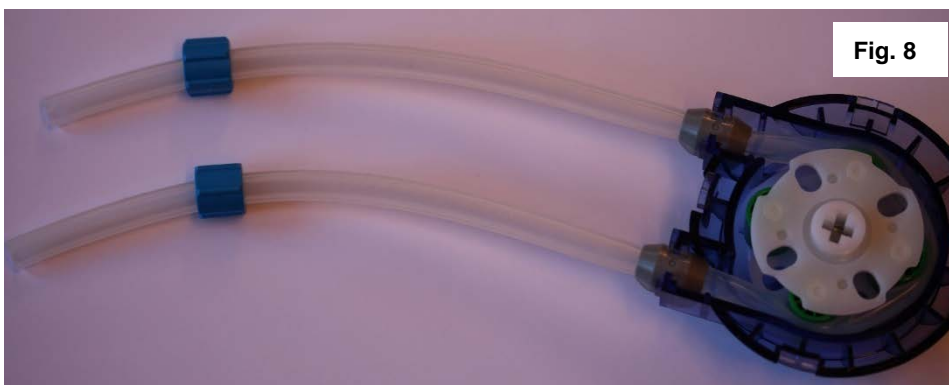
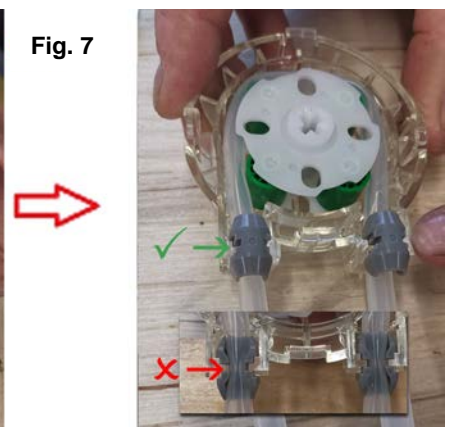
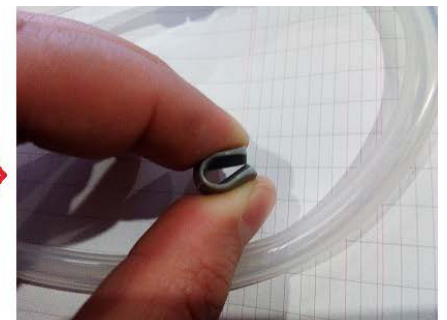
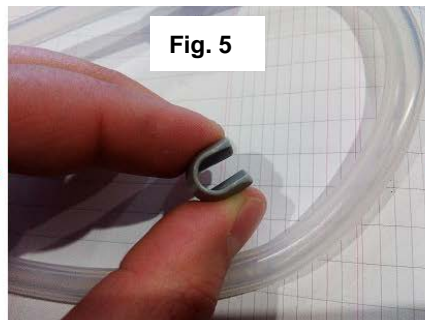
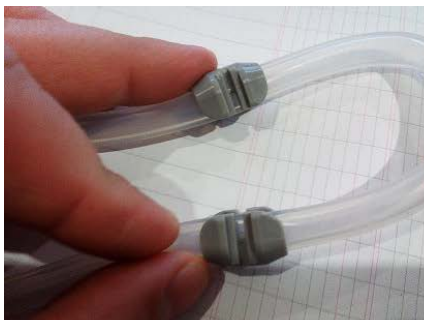
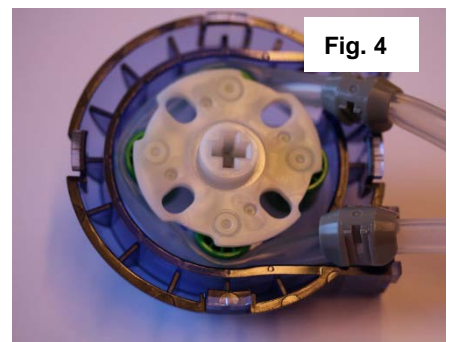
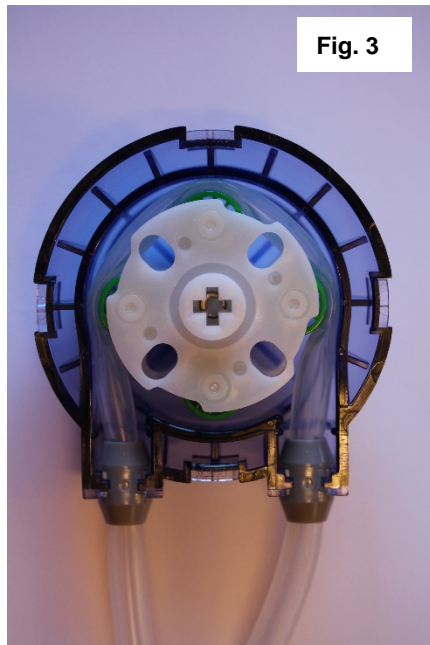
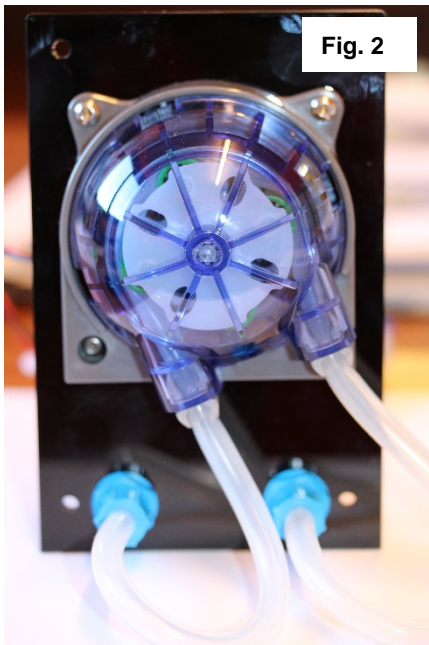

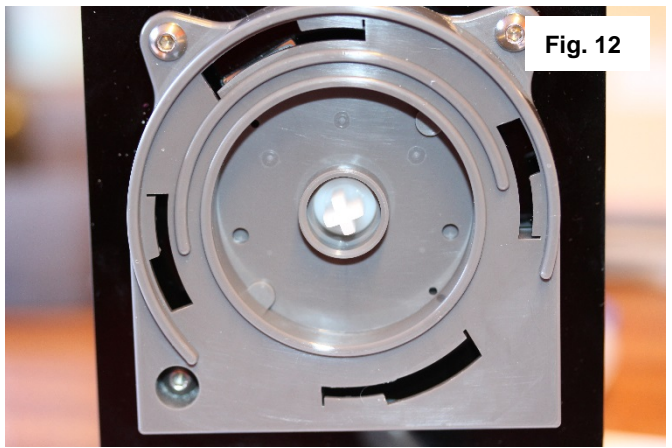
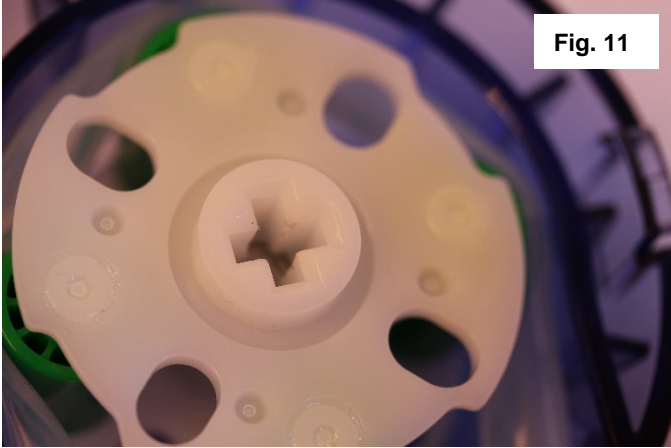

INTERNAL VIEW OF THE HUMIDIFIER

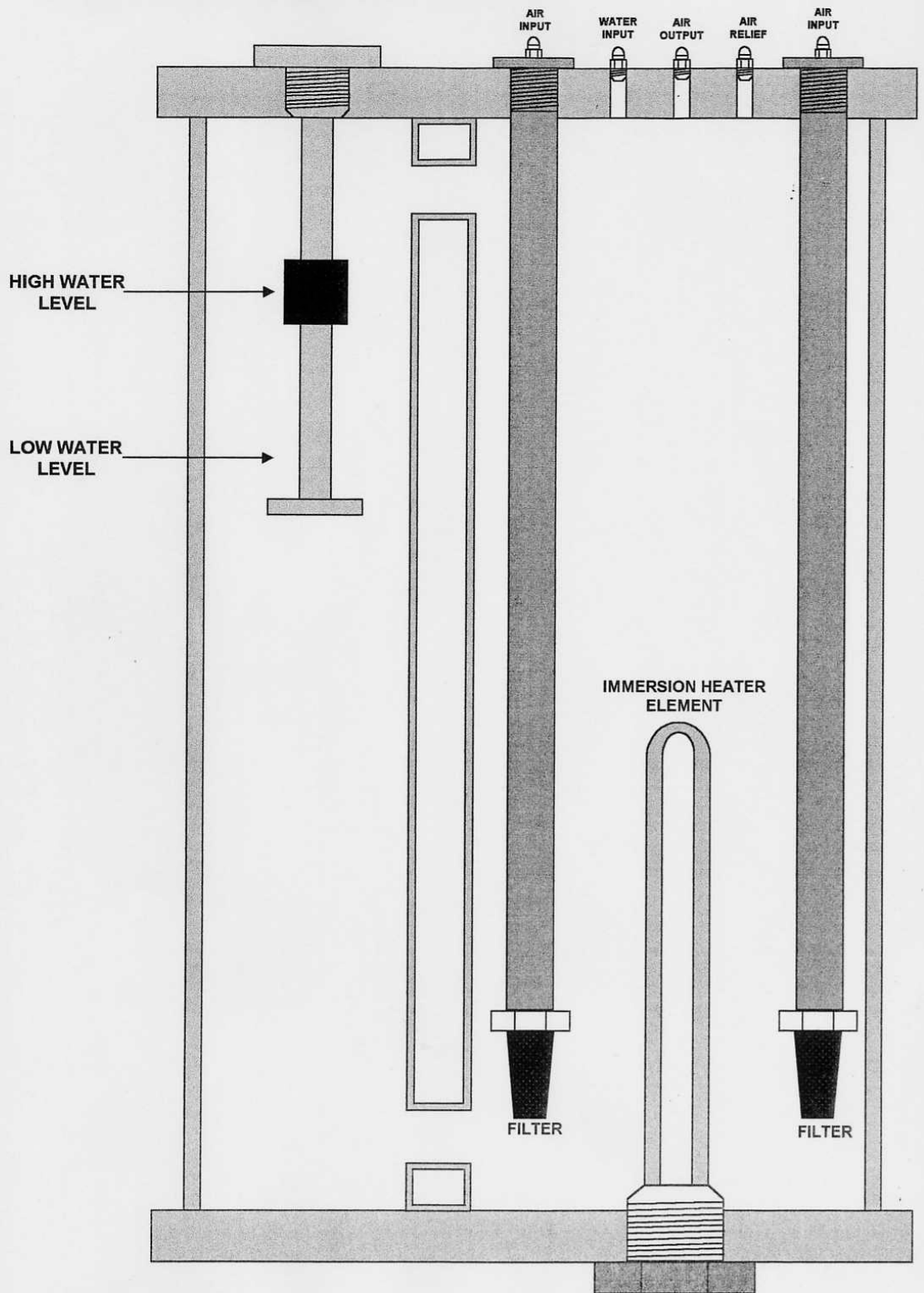

12. TROUBLE SHOOTING

Below are listed several helpful diagnosis hints, should you experience any errors that may interfere with your testing.

NO HUMIDITY

1. Remove the fan trunking between the cabinet and condenser unit and observe if a mist is being generated. It will flow from the condenser unit
2. Check that the air and water connections between the cabinet and condenser unit are connected and turned on at the rear of the cabinet, also to the cabinet services panel
3. Check that VH has been selected through the controller. Event 3

NO HEAT

1. Check that the power to the cabinet is switched on.
2. Check the temperature setting (degrees centigrade) set in the program controller is set at the required level and compare to the actual reading in the chamber.

13. OPERATING

Once all the services are connected and the salt solution reservoir is filled with salt solution you may commence testing.

Place your test samples on the sample racks inside the test chamber.

NOTE: Care must be taken when positioning the sample racks not to obstruct the jet nozzle spray path, or overhang the fallout collection vessels (minimum of 2 vessels required).

Close the lid

If operating to ASTM B117 the chamber requires a humidity level of 95-98% RH during testing.

The required temperature of the water inside the humidifier tower depends on the air pressure at the spray jet nozzle.

ASTM B117 table X1.2 states

Air Pressure (p.s.i.)	14	16	18
Humidifier Temperature (°C)	47	48	49

STARTING TO TEST - NEUTRAL SALT SOLUTION TEST

Allow 10 minutes for the salt solution to be drawn from the salt solution reservoir and be pumped to the spray jet nozzle.

This procedure may be accelerated by increasing the pump speed. To alter the pump speed, turn the adjuster knob positioned between the pump and the flowmeter.

Once the salt solution has reached the jet nozzle, set the flowrate on the flowmeter (by increasing or decreasing the air regulator on the control panel) to the value shown in the table below.

	Air Pressure	Flowrate
200 Litre Cabinet	1.0 - 1.2 Bar	0.3 – 0.4 L/hr
450 Litre Cabinet	1.0 - 1.2 Bar	0.3 – 0.4 L/hr
750 Litre Cabinet	1.1 - 1.3 Bar	0.6 – 0.8 L/hr
1000 Litre Cabinet	1.2 - 1.3 Bar	0.7 – 0.8 L/hr
2000 Litre Cabinet	1.5 - 1.8 Bar	1.0 – 1.2 L/hr

Using the settings shown in the above table should enable you to achieve a good even salt fog distribution, with fallout collection rates of 1-2 ml per 80cm of horizontal area.

Having followed all of the above instructions the cabinet will now operate fully automatically and function to your test specification.

14. GAS SPRINGS - SAFETY REQUIREMENTS

Gas Springs are filled with Nitrogen at very high pressures, and under no circumstances should they be opened, tampered with, or subjected to excessive heat or tension.

Gas Springs should always be treated with respect in the knowledge of the pressure internally.

As a pressurised item, it is recommended that they be returned to the supplier for safe disposal at the end of their useful life.

As the nature of a Gas Spring is to lose its force over a long period of time, it is advisable to periodically check its ability to operate as initially intended, preferably forming part of planned maintenance structure. Replace if, and when, necessary.

INSTALLATION INSTRUCTIONS

For standard compression Gas Springs, we advise the use of ball joints to alleviate possible side loads.

Generally fit with piston rod down, preferably within 60 degrees to the vertical, and avoid the spring travelling through a large arc. It is advisable to keep the spring in a single plane of movement. Failure to adhere to this advice may result in reduced life of the Gas Spring.

Further information and advice can be obtained from:



C&W Specialist Equipment
Unit 2, Burnside Court
Brunel Road
Leominster
Herefordshire
HR6 0LX United Kingdom

Phone: +44 (0) 2039 3635 65
E-mail: sales.service@cw-spec.com

www.cw-spec.com