



November 2017

Revision W

Copyright © 2017  
by AMETEK Programmable Power.  
All rights reserved.  
**P/N 4994-970**

***California Instruments***  
**i / iX / iM Series II**  
**AC Power Source**  
**User Manual**

User's Manual  
California Instruments AC Power Source  
By AMETEK Programmable Power.

Models :

- . 3001iM
- . 5001iM
- . 10001iM
- . 15001iM
- . 15003iM
  
- . 3001i
- . 5001i
- . 5001i-400
- . 9003i
- . 10001i
- . 10001i-400
- . 10002i
- . 10002i-400
- . 15001i
- . 15001i-400
- . 15003i
- . 15003i-400
- . 30003i
- . 30003i-400
  
- . 3001iX
- . 5001iX
- . 5001iX-400
- . 9003iX
- . 10001iX
- . 10001iX-400
- . 10002iX
- . 10002iX-400
- . 15001iX
- . 15001iX-400
- . 15003iX
- . 15003iX-400
- . 30003iX
- . 30003iX-400

© Copyright 2017 AMETEK Programmable Power. Rev W, November 2017.

## About AMETEK

AMETEK Programmable Power, Inc., a Division of AMETEK, Inc., is a global leader in the design and manufacture of precision, programmable power supplies for R&D, test and measurement, process control, power bus simulation and power conditioning applications across diverse industrial segments. From bench top supplies to rack-mounted industrial power subsystems, AMETEK Programmable Power is the proud manufacturer of Elgar, Sorensen, California Instruments and Power Ten brand power supplies.

AMETEK, Inc. is a leading global manufacturer of electronic instruments and electromechanical devices with annualized sales of \$2.5 billion. The Company has over 11,000 colleagues working at more than 80 manufacturing facilities and more than 80 sales and service centers in the United States and around the world.

## Trademarks

AMETEK is a registered trademark of AMETEK, Inc. California Instruments is a trademark owned by AMETEK, Inc. Other trademarks, registered trademarks, and product names are the property of their respective owners and are used herein for identification purposes only.

## Notice of Copyright

*iM/j/iX Series User Manual* © 2017 AMETEK Programmable Power, Inc. All rights reserved.

## Exclusion for Documentation

UNLESS SPECIFICALLY AGREED TO IN WRITING, AMETEK PROGRAMMABLE POWER, INC. ("AMETEK"):

- (a) MAKES NO WARRANTY AS TO THE ACCURACY, SUFFICIENCY OR SUITABILITY OF ANY TECHNICAL OR OTHER INFORMATION PROVIDED IN ITS MANUALS OR OTHER DOCUMENTATION.
- (b) ASSUMES NO RESPONSIBILITY OR LIABILITY FOR LOSSES, DAMAGES, COSTS OR EXPENSES, WHETHER SPECIAL, DIRECT, INDIRECT, CONSEQUENTIAL OR INCIDENTAL, WHICH MIGHT ARISE OUT OF THE USE OF SUCH INFORMATION. THE USE OF ANY SUCH INFORMATION WILL BE ENTIRELY AT THE USER'S RISK, AND
- (c) REMINDS YOU THAT IF THIS MANUAL IS IN ANY LANGUAGE OTHER THAN ENGLISH, ALTHOUGH STEPS HAVE BEEN TAKEN TO MAINTAIN THE ACCURACY OF THE TRANSLATION, THE ACCURACY CANNOT BE GUARANTEED. APPROVED AMETEK CONTENT IS CONTAINED WITH THE ENGLISH LANGUAGE VERSION, WHICH IS POSTED AT [WWW.PROGRAMMABLEPOWER.COM](http://WWW.PROGRAMMABLEPOWER.COM).

## Date and Revision

November 2017 Revision W

## Part Number

4994-970

## Contact Information

Telephone: 800 733 5427 (toll free in North America)  
858 450 0085 (direct)



Fax: 858 458 0267

Email: [sales.ppd@ametek.com](mailto:sales.ppd@ametek.com)  
[service.ppd@ametek.com](mailto:service.ppd@ametek.com)

Web: [www.programmablepower.com](http://www.programmablepower.com)

# Important Safety Instructions

Before applying power to the system, verify that your product is configured properly for your particular application.

 WARNING	<b>Hazardous voltages may be present when covers are removed. Qualified personnel must use extreme caution when servicing this equipment. Circuit boards, test points, and output voltages also may be floating above (below) chassis ground.</b>
 WARNING	<b>The equipment used contains ESD sensitive parts. When installing equipment, follow ESD Safety Procedures. Electrostatic discharges might cause damage to the equipment.</b>

Only *qualified personnel* who deal with attendant hazards in power supplies, are allowed to perform installation and servicing.

Ensure that the AC power line ground is connected properly to the Power Rack input connector or chassis. Similarly, other power ground lines including those to application and maintenance equipment *must* be grounded properly for both personnel and equipment safety.

Always ensure that facility AC input power is de-energized prior to connecting or disconnecting any cable.

In normal operation, the operator does not have access to hazardous voltages within the chassis. However, depending on the user's application configuration, **HIGH VOLTAGES HAZARDOUS TO HUMAN SAFETY** may be normally generated on the output terminals. The customer/user must ensure that the output power lines are labeled properly as to the safety hazards and that any inadvertent contact with hazardous voltages is eliminated.

Guard against risks of electrical shock during open cover checks by not touching any portion of the electrical circuits. Even when power is off, capacitors may retain an electrical charge. Use safety glasses during open cover checks to avoid personal injury by any sudden component failure.

Neither AMETEK Programmable Power Inc., San Diego, California, USA, nor any of the subsidiary sales organizations can accept any responsibility for personnel, material or inconsequential injury, loss or damage that results from improper use of the equipment and accessories.

**SAFETY SYMBOLS**



**WARNING**  
Risk of Electrical Shock



**CAUTION**  
Refer to Accompanying Documents



Off (Supply)



Direct Current (DC)



Standby (Supply)



Alternating Current (AC)



On (Supply)



Three-Phase Alternating Current



Protective Conductor Terminal



Earth (Ground) Terminal



Fuse



Chassis Ground

**Product Family: iM /i / iX Series AC Power Source**  
**Warranty Period: 1 Year**

**WARRANTY TERMS**

AMETEK Programmable Power, Inc. (“AMETEK”), provides this written warranty covering the Product stated above, and if the Buyer discovers and notifies AMETEK in writing of any defect in material or workmanship within the applicable warranty period stated above, then AMETEK may, at its option: repair or replace the Product; or issue a credit note for the defective Product; or provide the Buyer with replacement parts for the Product.

The Buyer will, at its expense, return the defective Product or parts thereof to AMETEK in accordance with the return procedure specified below. AMETEK will, at its expense, deliver the repaired or replaced Product or parts to the Buyer. Any warranty of AMETEK will not apply if the Buyer is in default under the Purchase Order Agreement or where the Product or any part thereof:

- is damaged by misuse, accident, negligence or failure to maintain the same as specified or required by AMETEK;
- is damaged by modifications, alterations or attachments thereto which are not authorized by AMETEK;
- is installed or operated contrary to the instructions of AMETEK;
- is opened, modified or disassembled in any way without AMETEK’s consent; or
- is used in combination with items, articles or materials not authorized by AMETEK.

The Buyer may not assert any claim that the Products are not in conformity with any warranty until the Buyer has made all payments to AMETEK provided for in the Purchase Order Agreement.

**PRODUCT RETURN PROCEDURE**

Request a Return Material Authorization (RMA) number from the repair facility (**must be done in the country in which it was purchased**):

- **In the USA**, contact the AMETEK Repair Department prior to the return of the product to AMETEK for repair:  
Telephone: 800-733-5427, ext. 2295 or ext. 2463 (toll free North America)  
858-450-0085, ext. 2295 or ext. 2463 (direct)
- **Outside the United States**, contact the nearest Authorized Service Center (ASC). A full listing can be found either through your local distributor or our website, [www.programmablepower.com](http://www.programmablepower.com), by clicking Support and going to the Service Centers tab.

When requesting an RMA, have the following information ready:

- Model number
- Serial number
- Description of the problem

**NOTE:** Unauthorized returns will not be accepted and will be returned at the shipper’s expense.

**NOTE:** A returned product found upon inspection by AMETEK, to be in specification is subject to an evaluation fee and applicable freight charges.

## Table of Contents

---

<b>1. Introduction .....</b>	<b>13</b>
1.1 General Description .....	13
1.2 Model Series I and Series II .....	14
<b>2. Specifications .....</b>	<b>15</b>
2.1 Electrical .....	15
2.2 Mechanical .....	26
2.3 Environmental .....	26
2.4 Regulatory .....	27
2.5 Front Panel Controls .....	27
2.6 Special Features, Options and Accessories .....	28
2.7 Supplemental Specifications .....	29
<b>3. Unpacking and Installation .....</b>	<b>31</b>
3.1 Unpacking .....	31
3.2 Power Requirements .....	31
3.3 Mechanical Installation .....	32
3.4 Input Wiring – TB1 .....	32
3.5 Output Power Connections – TB2 .....	32
3.6 Connectors - Rear Panel .....	34
3.7 Single-Phase and Three Phase Multiple Box System Configurations .....	46
3.8 Output Voltage Ranges .....	46
3.9 Functional Test .....	46
<b>4. Front Panel Operation .....</b>	<b>58</b>
4.1 Tour of the Front Panel .....	58
4.2 Menu Structure .....	64
4.3 Output Programming .....	99
4.4 Waveform Management [ <i>iX Series only</i> ] .....	101
4.5 Standard Measurements .....	105
4.6 Advanced Measurements [ <i>iX Series only</i> ] .....	107
4.7 Transient Programming .....	115
<b>5. Principle of Operation .....</b>	<b>122</b>
5.1 General .....	122
5.2 Overall Description .....	122
5.3 Oscillator Assembly .....	123
5.4 Current Limit Board .....	125
5.5 Auxiliary Power Supply .....	125
5.6 DC-DC Power Converter .....	126
5.7 AC Control Logic .....	126
5.8 AC Power Board .....	129
5.9 Input/Output Board .....	129
<b>6. Calibration .....</b>	<b>133</b>
6.1 Calibration Equipment .....	133
6.2 Calibration Screen Access .....	133
6.3 Routine Measurement Calibration .....	134
6.4 Routine Output Calibration .....	138
6.5 Output Impedance Calibration .....	140
6.6 Non-Routine Calibration .....	142

---

<b>7. Service .....</b>	<b>144</b>
7.1 Cleaning .....	145
7.2 General .....	145
7.3 Basic operation .....	146
7.4 Advanced Troubleshooting.....	148
<b>8. Top Assembly Replaceable Parts .....</b>	<b>152</b>
8.1 Sub assemblies .....	152
8.2 Fuses .....	153
<b>9. Options .....</b>	<b>154</b>
9.1 RTCA/DO-160 Option .....	154
9.2 IEC 61000-4-11 Option .....	171
9.3 IEC 61000-4-13 Option .....	179
9.4 EOS Option .....	191
9.5 Mode iX Option .....	206
9.6 Omni Options .....	214
9.7 LNS Option and XLS Option .....	225
9.8 Option –704: MilStd704 Tests .....	231
9.9 ABD Option: Airbus ABD0100.1.8 Test.....	243
9.10 AMD Option: Airbus AMD24C Test .....	243
9.11 A350 Option: Airbus A350 (ABD0100.1.8.1) Test .....	243
9.12 787 Option: Boeing B787-0147 Test .....	243
9.13 WHM Option.....	244
<b>10. Error Messages.....</b>	<b>247</b>
<b>11. Index.....</b>	<b>252</b>



## List of Figures

Figure 2-1: 3001iX / 9003iX - Voltage Current rating, AC mode .....	18
Figure 2-2: 3001iX / 9003iX - Voltage Current Rating, DC mode .....	18
Figure 2-3: 5001iX / 15003iX - Voltage Current rating, AC mode .....	19
Figure 2-4: 5001iX / 15003iX - Voltage Current rating, DC mode .....	19
Figure 2-5: 10001iX / 30003iX - Voltage Current rating, AC mode .....	20
Figure 2-6: 10001iX / 30003iX - Voltage Current rating, DC mode .....	20
Figure 2-7: 15001iX - Voltage Current rating, AC mode .....	21
Figure 2-8: 15001iX - Voltage Current rating, DC mode .....	21
Figure 2-9: Maximum RMS voltage versus frequency rating in 300V AC range .....	22
Figure 3-1: The 5001iX Power Source .....	31
Figure 3-2: RS232C Cable for PC Connection wiring diagram – Units without USB .....	38
Figure 3-3: USB Connector pin orientation .....	38
Figure 3-4: Function Strobe Connection .....	40
Figure 3-5: Function Strobe / Trigger Output Accessory .....	40
Figure 3-6: Rear Panel View for the 3001i/3001iX (Series II) .....	42
Figure 3-7: Rear Panel View for the 3001i/3001iX (Series I, no USB) .....	43
Figure 3-8: Rear Panel View for the 5001i/5001iX (Series II) .....	43
Figure 3-9: Rear Panel View for the 5001i/5001iX (Series I, no USB) .....	45
Figure 3-10: Connection For Single Power Source (5001iX/i, 3001iX/i) .....	48
Figure 3-11: Functional Test Setup .....	49
Figure 3-12: Single Phase 10000 VA System (10001iX/i) .....	50
Figure 3-13: Two Phase 10000 VA System (10002i/iX – One Controller) .....	51
Figure 3-14: Three Phase 15000 VA System (15003iX/i-LK Three Controllers) .....	52
Figure 3-15: Single Phase 15000 VA System (15001iX/i) .....	53
Figure 3-16: Three-Phase 15000 VA system (15003iX/i - One Controller) .....	54
Figure 3-17: Connection With MODE Option .....	55
Figure 3-18: Two Phase 10000 VA System (10002i-LK Two Controllers) .....	56
Figure 3-19: Three-Phase 9000 VA System (9003iX/i – One Controller) .....	57
Figure 4-1: Shuttle Knob .....	59
Figure 4-2: FUNCTION keypad .....	60
Figure 4-3: Entering value from decimal keypad .....	61
Figure 4-4: Cursor UP key movement .....	61
Figure 4-5: Cursor DOWN key movement .....	62
Figure 4-6: Main Menu 1 screen .....	63
Figure 4-7: Menu 1 through 3 .....	64
Figure 4-8: PROGRAM Menu .....	68
Figure 4-9: MEASUREMENTS Screen, single phase and three phase modes .....	70
Figure 4-10: HARMONICS/TRACE ANALYSIS screen .....	72
Figure 4-11: TRANSIENTS menu .....	75
Figure 4-12: VOLTAGE SURGE/SAG SETUP screen .....	75
Figure 4-13: VOLTAGE SWEEP/STEP SETUP screen .....	77
Figure 4-14: FREQUENCY SWEEP/STEP SETUP screen .....	79
Figure 4-15: VOLTAGE/FREQUENCY SWEEP/STEP SETUP screen .....	80
Figure 4-16: START/VIEW TRANSIENT SEQUENCE screen .....	80
Figure 4-17: WAVEFORMS menu .....	81
Figure 4-18: APPLICATIONS menu .....	84
Figure 4-19: SETUP REGISTERS menu .....	85
Figure 4-20: UTILITY menus .....	86
Figure 4-21: GPIB/RS232 SETUP menu .....	89
Figure 4-22: VOLTAGE/CURRENT CONTROL SETUP menu .....	90
Figure 4-23: INITIAL SETUP menus .....	91
Figure 4-24: LIMIT SETUP menu .....	93
Figure 4-25: CONFIGURATION SETUP Menus .....	94
Figure 4-26: OUTPUT IMPEDANCE menu .....	96
Figure 4-27: MEASUREMENT CAL FACTORS menu .....	97
Figure 4-28: OUTPUT CAL FACTORS menu .....	98
Figure 4-29: Selecting a waveform .....	101
Figure 4-30: Selecting waveforms for single phase or all phases .....	101
Figure 4-31: Custom waveform creation with GUI program .....	102
Figure 4-32: Waveform crest factor affects max. rms voltage .....	103

Figure 4-33: Waveform frequency domain view mode .....	104
Figure 4-34: Scrolling through tabular FFT data.....	108
Figure 4-35: Scrolling through bar chart FFT data .....	108
Figure 4-36: Scrolling through acquired waveform data.....	110
Figure 4-37: SET VOLT trigger source acquisition.....	112
Figure 4-38: Positive trigger delay (Post trigger data).....	113
Figure 4-39: Negative trigger delay (Pre-trigger data).....	114
Figure 4-40: Pulse Transients .....	116
Figure 4-41: List Transients .....	117
Figure 4-42: Switching waveforms in a transient list .....	120
Figure 4-43: START/VIEW TRANSIENT SEQUENCE menu.....	121
Figure 5-1: AC Power System Block Diagram .....	122
Figure 5-2: Power Source Module Block Diagram .....	124
Figure 5-3: 5001i Internal Layout .....	127
Figure 5-4: Logic Board LED's .....	128
Figure 5-5: AC Power Stage Layout.....	130
Figure 5-6: AC Control Logic Block Diagram .....	131
Figure 6-1: Test Equipment Hook-up for Measurement Calibration .....	135
Figure 6-2: Test Equipment Hookup for Routine Output Calibration .....	139
Figure 6-3: Adjustment Location .....	144
Figure 9-1: Application Menu .....	156
Figure 9-2: DO160 Main Menu.....	156
Figure 9-3: Normal state .....	157
Figure 9-4: Voltage Modulation .....	159
Figure 9-5: Frequency Modulation .....	160
Figure 9-6: Power Interrupt .....	161
Figure 9-7: Power Interrupt for Group 2 and 3 .....	162
Figure 9-8: Emergency Screen .....	163
Figure 9-9: Abnormal Screen .....	165
Figure 9-10: DO-160 DC Main Menu .....	167
Figure 9-11: Normal State.....	167
Figure 9-12: Abnormal State .....	169
Figure 9-13: Application menu .....	173
Figure 9-14: IEC1000-4-11 Menu.....	173
Figure 9-15: IEC Dips and Interrupts.....	174
Figure 9-16: Voltage Variation screen.....	176
Figure 9-17: EN 61000-4-11 Voltage Variation specification- Edition 1.0.....	177
Figure 9-18: EN 61000-4-11 Voltage Variation specification- Edition 2.0.....	177
Figure 9-19: IEC 61000-4-11 GUI screen. ....	178
Figure 9-20: Application menu .....	180
Figure 9-21: IEC 61000-4-13 Menu.....	180
Figure 9-22: IEC 61000-4-13 FCurve.....	182
Figure 9-23: IEC 61000-4-13 OSwing.....	182
Figure 9-24: IEC 61000-4-13 Sweep.....	183
Figure 9-25: IEC 61000-4-13 Harmonics .....	184
Figure 9-26: IEC 61000-4-13 Inter harmonics.....	185
Figure 9-27: IEC 61000-4-13 Meister Curve .....	186
Figure 9-28: IEC 61000-4-13 Test Flowchart Class 1 and 2 .....	187
Figure 9-29: IEC 61000-4-13 Test Flowchart Class 3 .....	188
Figure 9-30: MENU 2 SCREEN .....	190
Figure 9-31: INTERHARMONICS SCREEN .....	190
Figure 9-32: Example Connection With 5001iX and EOS-1.....	197
Figure 9-33: Example Connection With Compliance Test System and EOS-1 .....	198
Figure 9-34: 15003iX-CTS-EOS3-LR3.....	199
Figure 9-35: 15003iX/3-EOS3 .....	200
Figure 9-36: EOS3 Location of 70/80 Taps for each phase. ....	204
Figure 9-37: Example Connection With MODE iX.....	210
Figure 9-38: Example Connections With OMNI 1-18i.....	218
Figure 9-39: Example Connections With OMNI 3-18i.....	219
Figure 9-40: Schematic Showing OMNI 1-37i and1-37iJ Connected to 5001iX System .....	220
Figure 9-41: Schematic Showing OMNI 3-37i Connected to 30003iX System.....	221
Figure 9-42: Applications Screen .....	222

---

Figure 9-43: OMNI Control Screen .....	223
Figure 9-44: OMNI Control Screen .....	223
Figure 9-45: XLS Module Dimensions .....	227
Figure 9-46: XLS Connection on Low Range .....	228
Figure 9-47: XLS Connection on High Range .....	229
Figure 9-48: Application Menu.....	233
Figure 9-49: MIL704 Menu .....	233
Figure 9-50: Steady State Menu.....	234
Figure 9-51: Transient Menu .....	236
Figure 9-52: Emergency Menu .....	237
Figure 9-53: Abnormal Screen.....	238
Figure 9-54: MIL704 DC Menu .....	239
Figure 9-55: Steady State DC.....	239
Figure 9-56: Transient Menu .....	240
Figure 9-57: Abnormal Test Screen.....	241
Figure 9-58: Emergency Test .....	242
Figure 9-59: Application Screen .....	244
Figure 9-60: Watt-Hour Meter Screen .....	244
Figure 9-61: WH-Meter Screen With Function Active .....	244

## List of Tables

---

Table 3-1: Wire Sizes .....	33
Table 3-2: System Interface Connector (J22) .....	34
Table 3-3: Remote Sense Connector – TB3 .....	36
Table 3-4: RS232 Connector pin out – Units with RS232 and USB .....	37
Table 3-5: RS232C Connector – Units with RS232 but no USB .....	37
Table 3-6: USB Connector pin out .....	38
Table 3-7: RJ45 LAN Connector pin out .....	39
Table 5-1: Logic Board LED's .....	129
Table 6-1: Calibration Load For Each Phase .....	134
Table 6-2: Measurement Calibration Table .....	137
Table 6-3: Output Calibration Table .....	138
Table 6-4: Programmable Z adjustment pots .....	141
Table 6-5: Formulas to calculate R and L .....	141
Table 7-1: Basic Symptoms .....	146
Table 7-2: Auxiliary Power Supply Fuse Ratings .....	150
Table 8-1: Replaceable Parts .....	152
Table 8-2: Fuses .....	153
Table 9-1: Normal Voltage and Frequency minimum .....	157
Table 9-2: Normal Voltage and Frequency Maximum .....	157
Table 9-3: Normal Voltage Unbalance .....	158
Table 9-4: Normal Voltage Surge Sequence .....	162
Table 9-5: Normal Frequency Transient Sequence .....	163
Table 9-6: Normal Frequency Variation Sequence .....	163
Table 9-7: Emergency Voltage and Frequency Minimum .....	164
Table 9-8: Emergency Voltage and Frequency Maximum .....	164
Table 9-9: Emergency Voltage Unbalance .....	164
Table 9-10: Abnormal Voltage Minimum .....	165
Table 9-11: Abnormal Voltage Maximum .....	165
Table 9-12: Abnormal Frequency Transient .....	166
Table 9-13: Normal Voltage Minimum .....	167
Table 9-14: Normal Voltage Maximum .....	168
Table 9-15: Voltage Surge .....	168
Table 9-16: Abnormal Voltage Surge .....	170
Table 9-17: Phase mapping .....	172
Table 9-18: IEC 61000-3-34 Table C.2 .....	172
Table 9-19: Dips and Interruptions Tests Performed During RUN ALL .....	175
Table 9-20: Voltage Variations Test Performed During RUN ALL .....	176
Table 9-21: EOS Versions .....	191
Table 10-1: Error Messages .....	251

---

## 1. Introduction

---

This instruction manual contains information on the installation, operation, calibration and maintenance of all power systems that use the 3001i, 5001i, 3001iX, and 5001iX power sources with the second generation (Series II) programmable controller (P/N 7003-718).

This user manual also covers higher power configurations consisting of multiple units operated in parallel. Such models are 10001iX, 10002iX, 15003iX and 30003iX.

This manual also covers the manual operation mode only iM models. The iM models are similar to the i Models except they can only be operated from the front panel and lack measurement functions and transient capabilities. The iM Series II replaces the original iM Series with analog oscillator which is no longer available.

---

### 1.1 General Description

---

The 3001i, 5001i, 3001iX, and 5001iX are high efficiency, lightweight AC power sources that provide a precise output with low distortion. The i/iX Series offers a 0-150/0-300 AC voltage range and a 200/400 V DC range. Full power is available from 135/270V to full-scale voltage using a constant power mode of operation.

Two or three 5001i/iX units can be connected in parallel as a single-phase system for 10 kVA or 15 kVA respectively.

Three or six units can be connected as a three-phase system. They can be operated with AC or DC output.

The iX Series also offers AC+DC output mode.

The iM Series is a subset of the i Series and lacks load measurement functions and transient programming. For operating information on the iM Series models, refer to the equivalent i Series models in this user manual.

#### **USB and LAN Interfaces**

Models shipped after July 2007 (Top assembly P/N 7000-485 and P/N 7000-486) are equipped with GPIB, RS232 and USB interfaces. Older models did not have the USB interface. These newer models also support a LAN (Ethernet) interface option.

## 1.2 Model Series I and Series II

There are several generations of the *i*/X/*i*M Series product, Series I and Series II. This user manual covers model Series II with top-level assembly part numbers: .

<u>Top Assy. No USB</u>	<u>Top Assy incl. USB</u>	<u>Model</u>
7000-482-1	7000-485-1	3001iX
7000-482-4	7000-485-4	3001i / 3001iM
7000-474-1	7000-486-1	5001iX, 208 VAC INPUT
7000-474-2	7000-486-2	5001iX, 400 - 480 VAC INPUT
7000-474-3	7000-486-3	5001i / 5001iM, 208 VAC INPUT
7000-474-4	7000-486-4	5001i / 5001iM, 400-480 VAC INPUT

The difference between the Series *i* and the Series II is the controller used. The Series II uses a more advanced controller but retains functional backward compatibility with the Series I products. Series II models have a "Series II" designation shown in the lower right hand corner of the front panel for easy identification. The actual top assembly part number is shown on the model / serial number tag on the back of the *i*/X/*i*M series.

All Series II will have a firmware revision of 4.0 or higher. The firmware revision is displayed briefly at power up on the LCD display and can also be queried over the bus by using the \*IDN? command.

Differences between the two model series are:

- Dual voltage range pairs of 135/270 and 150/300 on Series I has been replaced by single 150/300 voltage range pair and constant power mode of operation.
- In DC mode, the voltage ranges have been increased to 200Vdc and 400Vdc.
- Auto level control (ALC) mode has been added to Series II models to obtain improved voltage accuracy and load regulation.
- The maximum frequency has been extended to 1000 Hz although the output voltage derates from 300 Vrms at 500 Hz to 150 Vrms at 1000 Hz.
- Reduced number of calibration coefficients on Series II.
- Increased measurement sampling rate on Series II.
- Maximum DC offset range in AC+DC mode is 250Vdc on Series I, 220Vdc on Series II
- Clock and Lock operation is not supported between Series I and Series II controllers. Thus, for the –LKM and –LKS options, both power sources must have the same controller type.

Differences between the 7000-482/-474 and 7000-485/-486 model series are:

- 7000-482/-474 models include GPIB, RS232
- 7000-485/-486 models include GPIB, RS232 and USB with optional available Ethernet (LAN) interface.

For information on *i*/X Series I, refer to user manual P/N 7000-970 instead of this user manual. Both manuals are distributed in Adobe PDF format on the same distribution CD.

## 2. Specifications

All specifications are for a single i or iX Series II unit and  $25 \pm 5^\circ\text{C}$  sine wave output with a resistive load unless noted otherwise.

### 2.1 Electrical

#### 2.1.1 Input

Parameter	3001i / iX / iM	5001i / iX / iM
Line Voltage:	208-240 $\pm 10\%$ VAC, single phase	208-240 $V_{LL} \pm 10\%$ , (Standard) 400-440 $V_{LL} \pm 10\%$ , (-400) 400-480 $V_{LL} \pm 10\%$ , (-400) 3 phase, 3 wire + ground
Line VA:	5000VA	8000VA
Line Current:	25 A RMS max. (Per Box)	23 A RMS max. at 208-240 VAC 12 A RMS max. at 400-440 VAC and 400-480 VAC (Per Box)
Line Frequency:	50-60 Hz $\pm 10\%$	
Efficiency:	80% (typical) depending on line and load	
Power Factor:	0.7 (typical)	0.9 (typical)
Inrush Current:	100 A <sub>pk</sub> for 100 $\mu\text{s}$	100 A <sub>pk</sub> for 100 $\mu\text{s}$ at 208-240V 50 A <sub>pk</sub> for 100 $\mu\text{s}$ at 400-440 VAC and 400-480 VAC
Hold-Up Time:	15 ms	
Isolation Voltage:	2200 VAC input to output 1350 VAC input to chassis	

## 2.1.2 Output

**(ALL SPECIFICATIONS ARE FOR AC AND DC UNLESS NOTED OTHERWISE)**

Output Parameter	iM Series	I Series	iX Series
<b>Modes:</b>	AC	AC, DC	AC, DC, AC+DC
<b>Voltage:</b>			
Ranges (L-N):			
AC Mode	Low: 0 - 150 VAC <a href="#">High[1]: 0 - 300 VAC</a>		
DC Mode	N/A	Low: 0 - 200 VDC High: 0 - 400 VDC	
AC+DC Mode iX Models only.	N/A		AC: Low: 0 - 150 V / High: 0 - 300 V (See footnote 1)
			DC Offset: Low 0 - 150 V / High; 0 - 225 V
<b>Programming Resolution:</b>			
AC Mode	0.1 V		
DC Mode	N/A	0.1V	
AC+DC Mode iX Models only.			AC: 0.1 V
			DC Offset: 0.1 V
<b>Voltage Accuracy:</b>			
AC mode	±0.5% of range, 16 to 400 Hz.		
DC mode	N/A	±0.5% of range	
<a href="#">Voltage Distortion [2]:</a> (linear load)	1% max THD at 50/60 Hz 2% max THD at 400 Hz 3% max THD at 1000 Hz		
<b>Load Regulation (% FS Vrange):</b>			
ALC on	± 0.2%		
ALC off	± 2.2% to 1000 Hz (Low range) ± 0.6% to 1000 Hz (High range)	± 0.5% DC to 100 Hz ± 2.2% to 1000 Hz (Low range)	



		± 0.6% to 1000 Hz (High range)
Line Regulation:	0.1% for 10% input line change	
Power: (per phase, either range, at full scale voltage)		
3001, 9003 5001, 15003 10001 15001	3000VA AC 5000VA AC 10000 VA AC 15000 VA AC	3000 VA AC, 2100 W DC 5000 VA AC, 3500 W DC 10000 VA AC, 7000 W DC 15000 VA AC, 10500 W DC
Current, maximum amps per phase:		
3001iM/i/iX	22.2 Arms @ 135 VAC in 150 Vrange 11.1 Arms @ 270 VAC in 300 Vrange	
3001i/iX	15.5 Adc @ 135 VDC in 200 Vrange 7.77 Adc @ 270 VDC in 400 Vrange	
5001 /15003iM/i/iX per phase	37.0 Arms @ 135 VAC in 150 Vrange 18.5 Arms @ 270 VAC in 300 Vrange	
5001/15003i/iX per phase	25.9 Adc @ 135 VDC in 200 Vrange 12.95 Adc @ 270 VDC in 400 Vrange	
10001iM/i/iX	74.0 Arms @ 135 VAC in 150 Vrange 37.0 Arms @ 270 VAC in 300 Vrange	
10001i/iX	51.8 Adc @ 135 VDC in 200 Vrange 25.9 Adc @ 270 VDC in 400 Vrange	
15001iM/i/iX	111 Arms @ 135 VAC in 150 Vrange 55.5 Arms @ 270 VAC in 300 Vrange	
150001i/iX	77.7 Adc @ 135 VDC in 200 Vrange 38.8 Adc @ 270 VDC in 400 Vrange	
<p>Current derates at higher voltage settings along constant power curve. See Figures Figure 2-1 through Figure 2-8 for voltage current ratings per phase or output by model.</p> <p>Maximum current for which specifications apply is derated linearly from 50% of voltage to 10% of specified current at 5% of voltage range as shown. Higher currents are available but not all specification will apply under these conditions.</p> <p>Note: For the iX series, the current output in the AC &amp; DC mode is equal to the current in the AC mode if the DC voltage is less than 20% of the full scale voltage. It is equal to the DC current for DC voltages more than 20% of full scale</p>		
<p>[1] Maximum RMS voltage in high voltage range is a function of programmed frequency. For frequencies above 500 Hz, the maximum available <math>V_{rms} = 1.5 E+4 / F</math>. See Figure 2-9 for V-F rating.</p>		
<p>[2] The distortion specification for the 3001i and iX is valid for an input voltage range of 197-264 V.</p>		

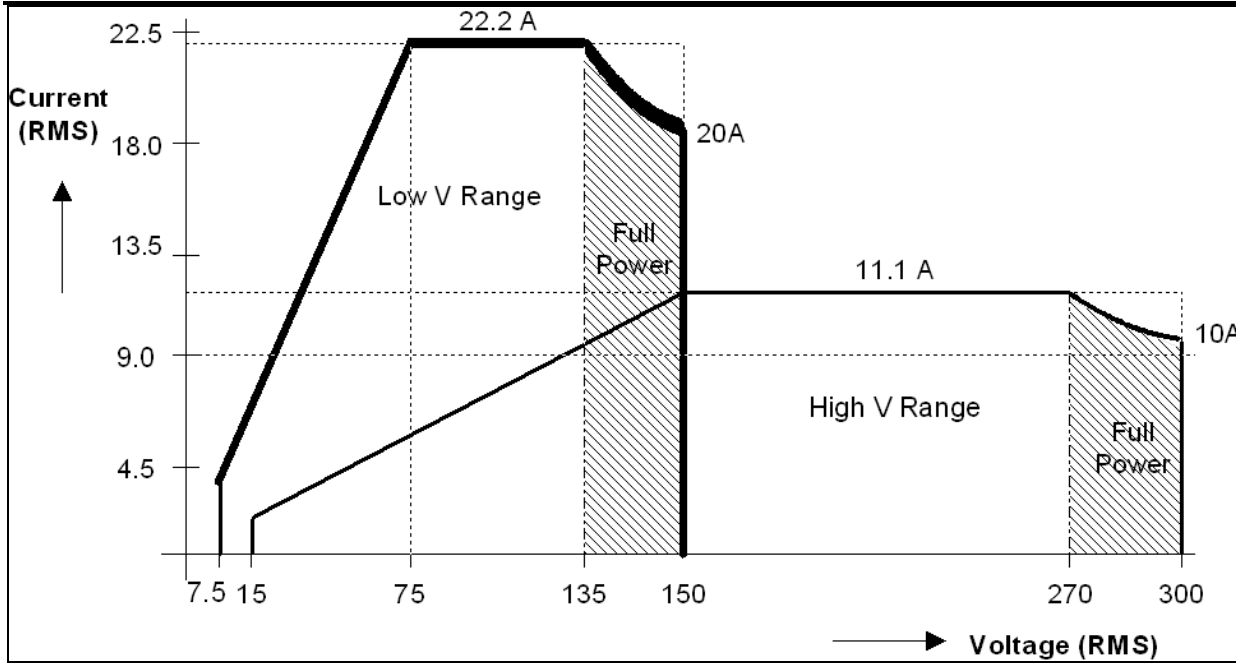

Figure 2-1: 3001iX / 9003iX - Voltage Current rating, AC mode

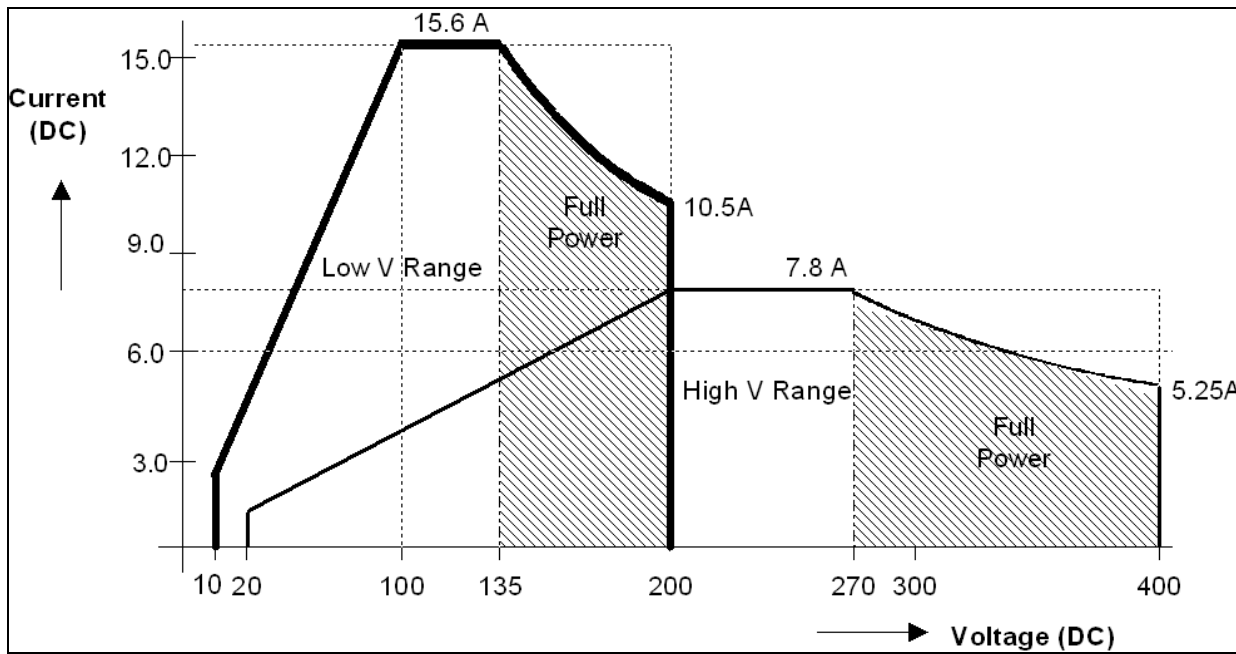

Figure 2-2: 3001iX / 9003iX - Voltage Current Rating, DC mode

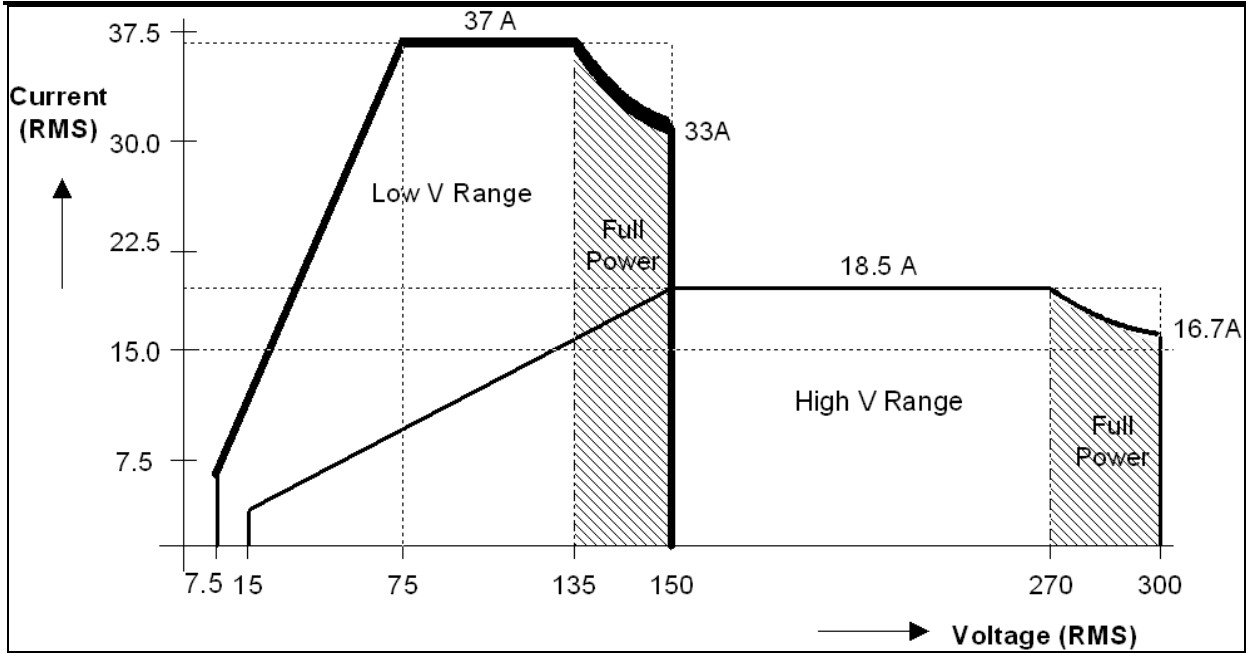

Figure 2-3: 5001iX / 15003iX - Voltage Current rating, AC mode

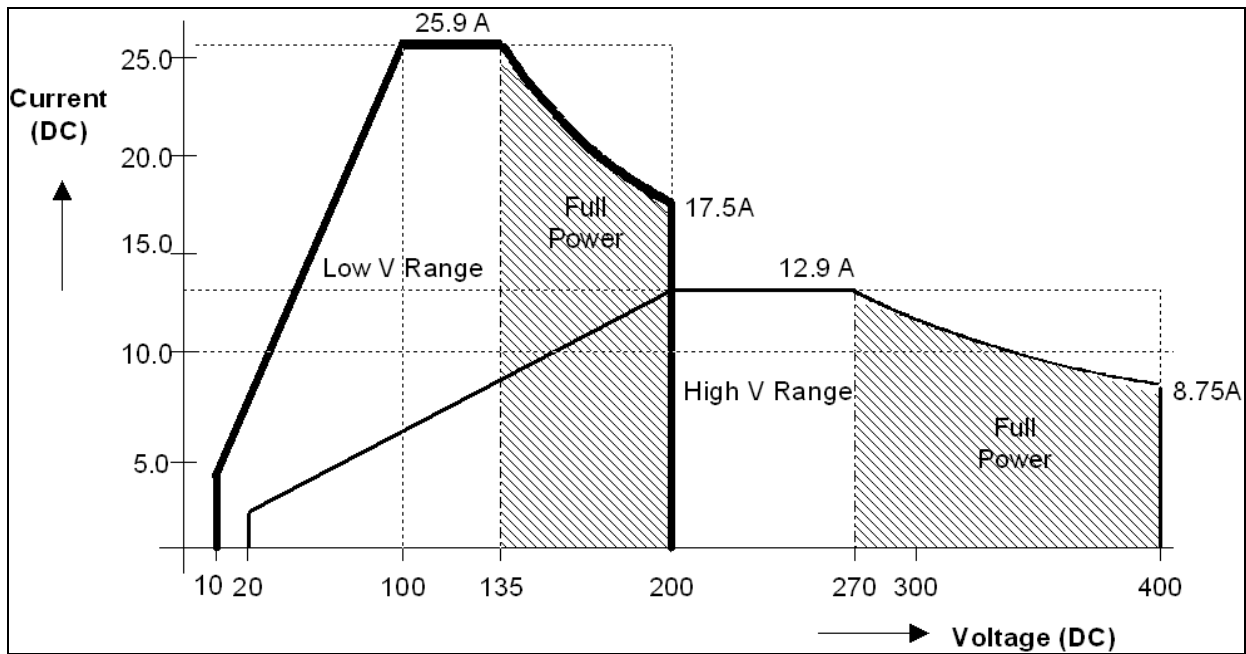

Figure 2-4: 5001iX / 15003iX - Voltage Current rating, DC mode

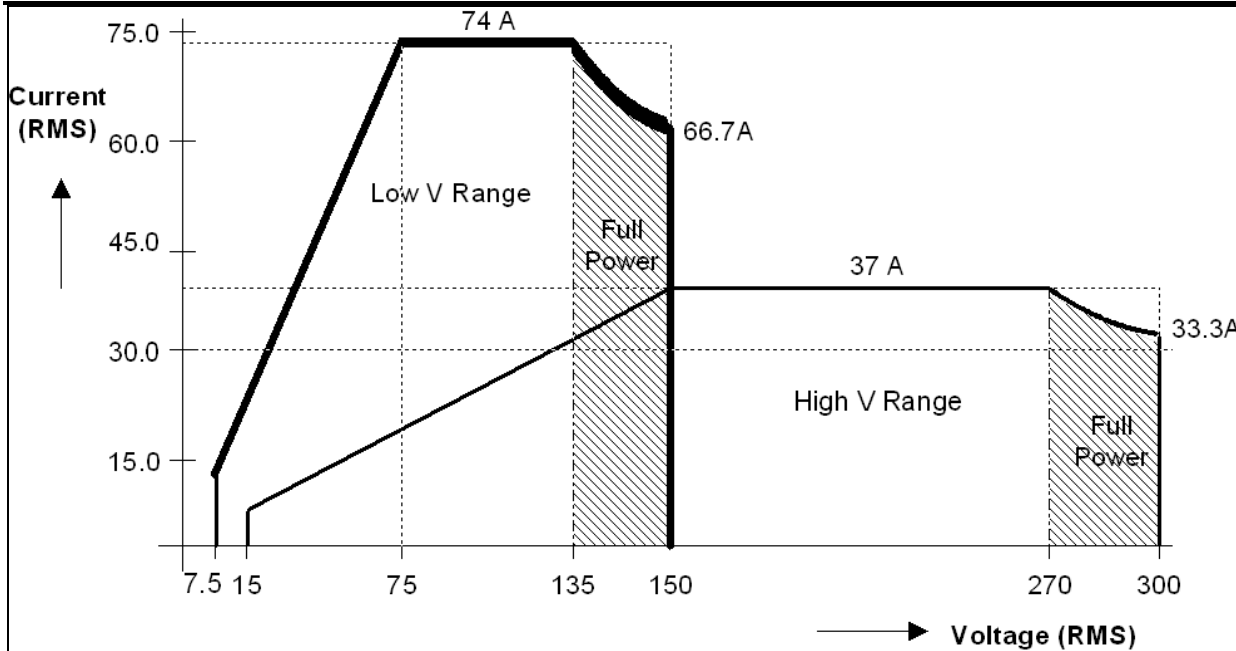

Figure 2-5: 10001iX / 30003iX - Voltage Current rating, AC mode

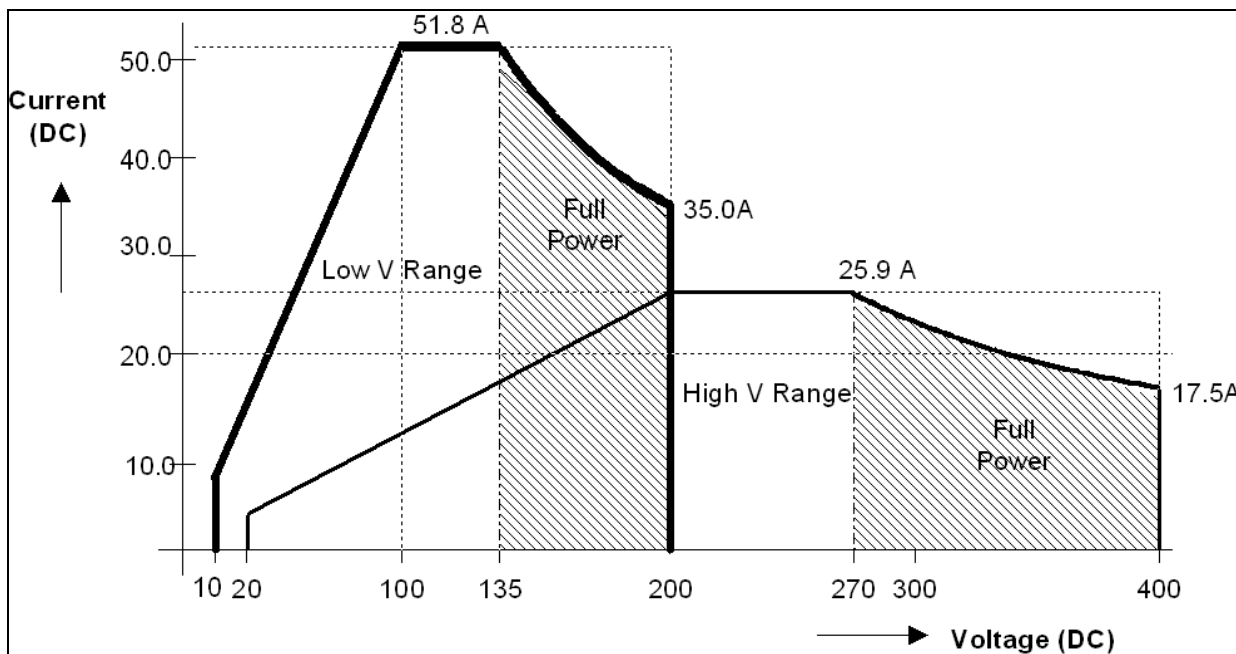

Figure 2-6: 10001iX / 30003iX - Voltage Current rating, DC mode

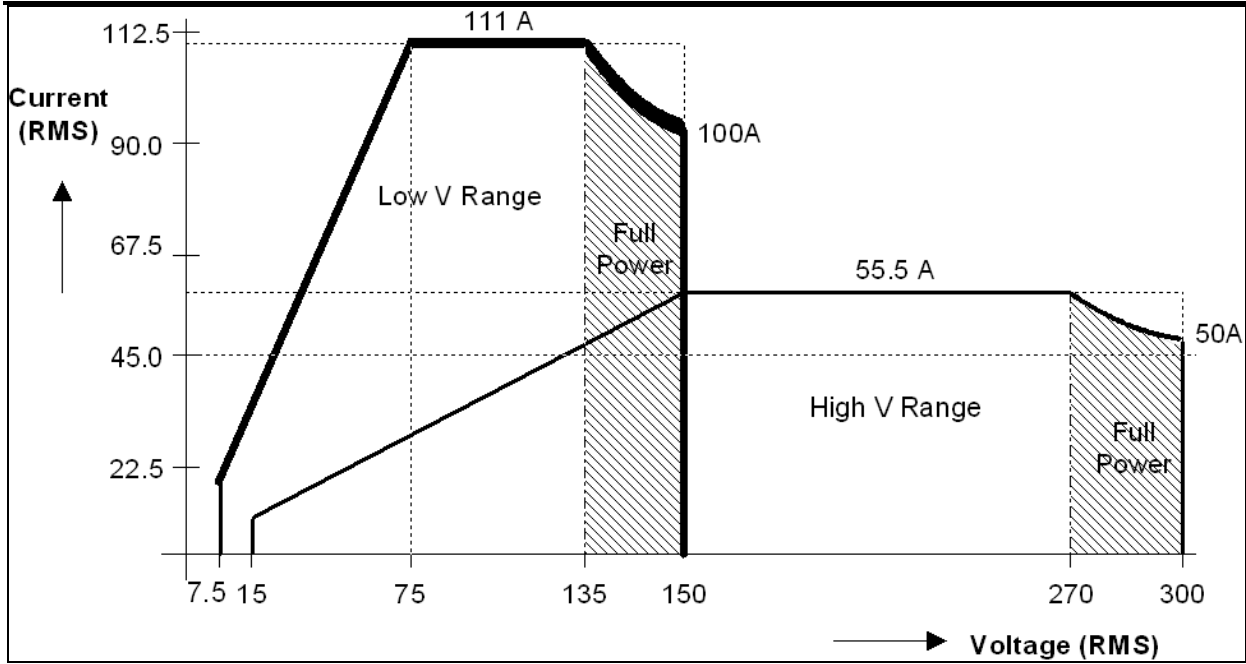

Figure 2-7: 15001iX - Voltage Current rating, AC mode

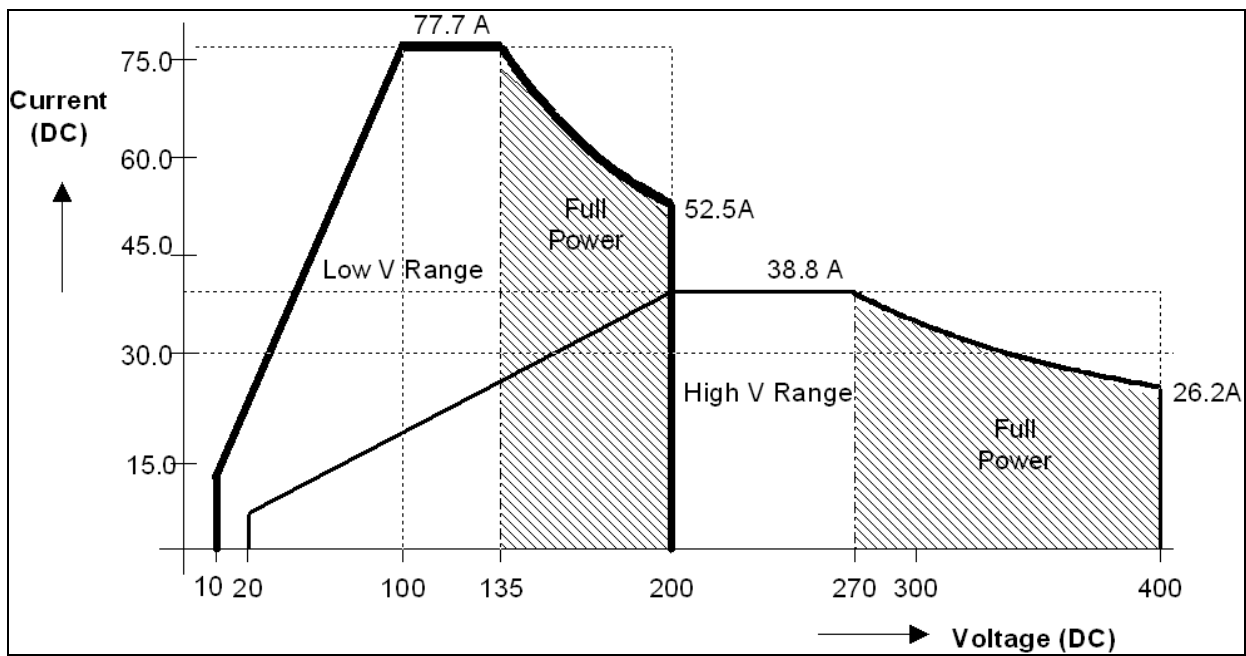

Figure 2-8: 15001iX - Voltage Current rating, DC mode

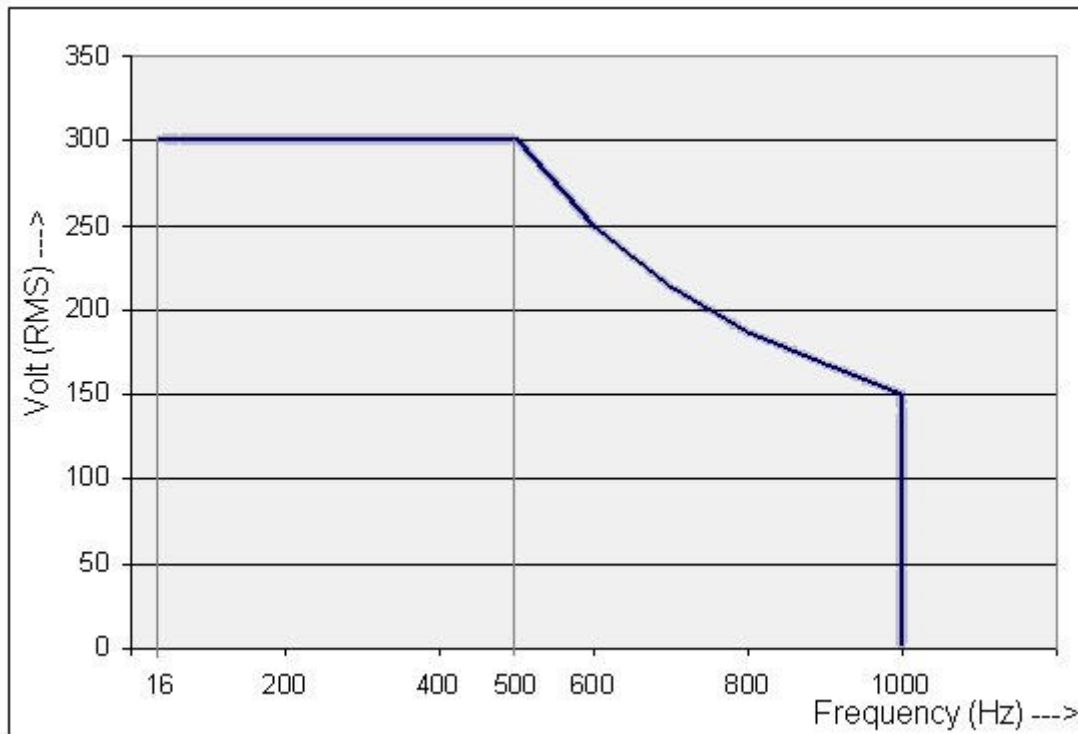

Figure 2-9: Maximum RMS voltage versus frequency rating in 300V AC range.

Output Parameter	i / iM Series	iX Series
Current Limit		
Range	Programmable 0 to 100% of range for all ranges	
Resolution	0.1 Arms	
Accuracy	± 0.5A	
Frequency Range:	16.00 - 81.91 Hz (0.01 Hz resolution) 81.0 – 819.1 Hz (0.1 Hz resolution) 820 – 1000 Hz <sup>1</sup> (1 Hz resolution)	
Frequency Accuracy:	± 0.01% of programmed value ±0.25% for the FC option	
DC Offset Voltage:	Less than 20 mV with linear load.	
Output Impedance		
Range:	n/a	R <sub>min</sub> to 1000 mΩ L <sub>min</sub> to 1000 μH
Resolution:	n/a	4 mΩ 4 μH
Accuracy:	n/a	± 2% F.S. at 796 μH and 400 mΩ
Output Noise: (20 kHz to 1 MHz)	<250 mV rms (typ), <500 mV rms (max)	<250 mV rms (typ), <500 mV rms (max)

<sup>1</sup> Note: AC voltage in 300V range derates from 300 Vrms max. at 500 Hz to 150 Vrms max. at 1000 Hz. See V-F rating chart figure Figure 2-9.

Output Parameter	i / iM Series	iX Series
Peak Rep AC Current:		
3001iM/i/iX 5001iM/i/iX 9003iM/i/iX 15003iM/i/iX	110 A for 150 V range, 92 A for 300 V range	110 A for 150V range, 92 A for 300 V range,
10001iM/i/iX	220 A for 150 V range, 184 A for 300 V range	220 A for 150 V range, 184 A for 300 V range
15001iM/i/iX	330 A for 150 V range, 276 A for 300 V range	330 A for 150 V range, 276 A for 300 V range
Crest Factor:	Up to 5:1	Up to 5:1

### 2.1.3 AC Measurements

Note: Measurements are not available on iM Series II models.

Parameter	Range	Accuracy ( $\pm$ )	Resolution
Frequency	16.00 - 1000 Hz	2 counts	0.01: 16 to 81.91 Hz 0.1: 82.0 to 819.0 Hz 1: 820 to 1000 Hz
RMS Voltage	0 - 300 Volts	0.25V + 0.1%, <100 Hz 0.25V + 0.2%, 100-1000 Hz	0.01 Volt
RMS Current	0 - 40 Amps	0.25A + 0.1%, <100 Hz 0.25A + 0.2%, 100-1000 Hz	0.001 Amp
Peak Current	0 - 119 Amps	0.5A + 0.2%, <100 Hz 0.5A + 0.5%, 100-1000 Hz	0.01 Amp
VA Power	0 – 6000 VA	10 VA + 0.1%, <100 Hz 20 VA + 0.2%, 100-1000 Hz	1 VA
Real Power	0 – 6000 W	10 W + 0.1%, <100 Hz 20 W + 0.2%, 100-1000 Hz	1 W
Power Factor (>0.2kVA)	0 - 1.00		0.01
Accuracy specifications apply above 100 counts. Current and Power Accuracy specifications are times two for 10001iX and times three for 15001iX. For 10001iX and 15001iX, resolution decreases by factor of 10, ranges for current and power increases by factor of three. Measurement bandwidth is limited to 16 KHz.			

### 2.1.4 DC Measurements

Note: Measurements are not available on iM Series II models.

Parameter	Range	Accuracy ( $\pm$ )	Resolution
Voltage	0 – 400 Volts	0.4 Volts	0.01 Volt
Current	0 – 40 Amps	0.1 Amps	0.001 Amp
Power	0 – 6000 W	20 W	1 W
Accuracy specifications apply above 100 counts. Current and Power Accuracy specifications are times two for 10001iX and times three for 15001iX. For 10001iX and 15001iX, resolution decreases by factor of 10, ranges for current and power increases by factor of three.			

## 2.1.5 Harmonic Measurements (iX series)

Parameter	Range	Accuracy ( ± )	Resolution
Frequency fundamental	16.00 - 1000 Hz	2 counts	0.01 Hz to 1 Hz
Frequency harmonics	32.00 Hz - 16 kHz	2° typ.	0.5°
Voltage	Fundamental	0.25V	0.01V
	Harmonic 2 - 50	0.25V + 0.1% + 0.1%/kHz	0.01V
Current	Fundamental	0.05A	0.01A
	Harmonic 2 - 50	0.05A + 0.1% + 0.1%/kHz	0.01A

Accuracy specifications are times three for three phase mode. Harmonics frequency range in three-phase mode is 32 Hz - 16 kHz. Resolution decreases by factor of 10 for 1000iX and 1500iX.

## 2.1.6 System Specification

Parameter	Specification
External Modulation:	0 to 10%
Synchronization Input:	Isolated TTL input for external frequency control. Requires 5V at 5 ma for logic high.
Trigger Output:	400 μs pulse for voltage or frequency change. Isolated output that requires a pull-up resistor, 22K Ω, to + 5 VDC.
Non volatile memory storage:	16 complete instrument setups and transient lists, 100 events per list.
Waveforms	Sine (i series) Sine, square, clipped, user defined (iX series)
Transients (i/iX only)	Voltage: drop, step, sag, surge, sweep
	Frequency: step, sag, surge, sweep
	Voltage and Frequency: step, sweep
IEEE-488 Interface: (i/iX only)	SH1, AH1, T6, L3, SR1, RL2, DC1, DT1 IEEE 488.2 and SCPI Response time is 10 ms (typical)
RS232C Interface:	Bi-directional serial interface 9 pin D-shell connector Handshake: CTS, RTS Data bits: 7, 8 Stop bits: 1,2 Baud rate: 9600, 19200, 38400 (Models without USB I/F) Baud rate: 9600, 19200, 38400, 57600, 115200, 230400, 460800 IEEE 488.2 and SCPI. <b>Note:</b> Disconnect any USB connection when using the RS232 interface.
USB Interface:	Standard USB 1.1 peripheral. Data transfer rate: 460,800 bps Syntax: IEEE 488.2 and SCPI.  <b>Note:</b> Use of the USB port to control more than one power source from a single PC is not recommended, as communication may not be reliable. Use GPIB interface for multiple power source control.
LAN Interface:	Option –LAN. When the LAN interface is installed, the RS232 interface is disabled.



Parameter	Specification
	RJ45 Connector, 10BaseT, 100BaseT or 1000BaseT, Data transfer rate: 460,800 bps Protocol: TCP/IP. Syntax: IEEE 488.2 and SCP <b>Note:</b> Disconnect any USB connection when using the LAN interface.
Current Limit Modes:	Two selectable modes of operation. Constant current and constant voltage with hold-off time and trip.
Function Strobe	Isolated open collector output available between pin 31 (High) and pin 14 (Low) of the System Interface connector (J22). Negative going pulse on any programmed voltage or frequency change. Function strobe output can be reassigned as trigger output when running list transients. This output requires a external DC supply and pull-up resistor.
Remote Inhibit	Also referred to as Remote On/Off. Digital input available on pin 36 and pin 27 (D-Common) of the System Interface connector (J22). The Remote inhibit input can be used to open the output relay. The output relay state is not latching so will return to the closed state when the input is removed.

### 2.1.7 Unit Protection

Parameter	Specification
Input Overcurrent:	Circuit breaker with shunt trip control.
Input Overvoltage:	Automatic shunt trip of input circuit breaker.
Input Overvoltage Transients:	Surge protection to withstand EN50082-1 (IEC 801-4, 5) levels.
Output Overcurrent:	Adjustable level constant current mode with a maximum set point between 0% and 10% above programmed value.
Output Short Circuit:	Peak and rms current limit.
Overtemperature:	Automatic shutdown.

## 2.2 Mechanical

Parameter	Specification
Dimensions:	19" (483 mm) wide x 7" (178 mm) high x 24" (610 mm) deep chassis size which is available in a rack mount or stand-alone configuration.
Unit Weight:	61 lb. (28 kg)
Material:	Aluminum chassis, panels and cover.
Finish:	Light textured painted external surfaces. Front and rear panels semi-gloss polyurethane color no. 26440 (medium gray) Top, bottom and sides semi-gloss polyurethane color no. 26622 (light gray).
Cooling:	Fan cooled with air intake on the sides and exhaust to the rear.
Internal Construction:	Modular sub assemblies.
Rear Panel Connections:	(see section 3 for description of connections) Input terminal block with cover Output terminal block with cover Remote voltage sense terminal block System interface (not for table top use, use only in rack enclosed systems) Clock and Lock (not for table top use, use only in rack enclosed systems) RS232, GPIB, USB, LAN (option)

## 2.3 Environmental

Parameter	Specification
Operating Temp:	0 to +40 °C.
Storage Temp:	-40 to +85 °C.
Altitude:	< 2000 m
Relative Humidity:	80% maximum for temperatures up to 31°C decreasing linearly to 50% at 40°C.
Installation/Over voltage Category:	II
Pollution Degree:	2
Indoor Use Only	
Vibration:	Designed to meet NSTA 1A transportation levels.
Shock:	Designed to meet NSTA 1A transportation levels.

## 2.4 Regulatory

Electromagnetic Emissions and Immunity:	Designed to meet EN50081-2 and EN50082-2 European Emissions and Immunity standards as required for the “CE” mark.
Acoustic Noise:	65 dBA maximum at 0% to 50% load, 75 dBA maximum greater than 50% load to 100% load. Measured at one meter.
Safety:	Designed EN61010-1 European safety standards as required for the “CE” mark.

## 2.5 Front Panel Controls

<b>Controls:</b>	
Shuttle knob:	Allows continuous change of all values including output calibration and range change.
Decimal keypad:	A conventional decimal keypad facilitates quick entry of numerical values such as voltage, current limit, etc. The large blue enter key will make the value you enter effective. Using the SET key allows the user to preset all parameter values and update them all at once by pressing the Enter key.
Up/down arrow keys:	A set of up and down arrow keys is used to move the cursor position in all menus. This allows quick selection of the desired function or parameter.
Function keys:	Measure key will display most measurement values. Program key will show all program parameters. Output on/off key for output relay control. Phase key will switch display to show program and measured values for each phase.
<b>Displays:</b>	
LCD graphics display:	A large high contrast LCD display with backlight provides easy to read guidance through all setup operations. An adjustable viewing angle makes it easy to read from all practical locations.
Status indicators:	Large and bright status indicators inform the user of important power source conditions. The Remote lamp informs the user that the unit is under remote control. The Overload lamp indicates that excessive current is being drawn at the output. The Over temperature lamp illuminates when internal heat sink temperatures are too high. The Hi Range indicator is lit any time the unit is switched to high output voltage range. The Output On/Off indicator is on when the power source output relays are closed.

## 2.6 Special Features, Options and Accessories

Feature	Description
Programmable Impedance.	Output impedance programming available on models 3001iX, 5001iX, 9003iX and 15003iX only.
Parallel Operation:	Up to three units can be paralleled in a single-phase configuration (with one master controller and one or two slave units). (10001iX and 15001iX).
Three Phase Output:	Three units (all with single-phase controllers) can be connected in a three-phase configuration using CLOCK and LOCK connections. Requires –LKM option in master and –LKS option in auxiliary units. Recommended is use of 9003iX, 15003iX or 30003iX three phase system however. <b>Note:</b> Clock and lock operation is not supported between Series I and Series II controller types. For this mode of operation, both models have the have the same controller type.
Controller:	Programmable controller front panel assembly.
Output Relay:	Standard output relay feature to isolate AC source from the load.
Output On/Off:	The output relay can be used to quickly disconnect the load. A green status indicator displays the status of the output relay.
Three-Phase Output 9003iX/15003iX	Three power sources with one controller in the Phase A power source. The one controller controls all three outputs.
15003iX – LKM/-LKS	Three power sources each with a controller for 3-phase output
Option	Description
Note	Avionics and IEC test options not available on iM Series models.
- 704	Mil Std 704D & E test firmware.  Mil Std 704A, B, C, & F test software (refer to Avionics Software Manual P/N 4994-971 for details). Note: Requires use of CIGuiSII Windows application software provided on CD ROM CIC496.
- 787	Boeing 787 Test software (refer to Avionics Software Manual P/N 4994-971 for details). Note: Requires use of CIGuiSII Windows application software provided on CD ROM CIC496.
- 160	RTCA/DO-160D test firmware  RTCA/DO-160E test software (refer to Avionics Software Manual P/N 4994-971 for details).. Note: Requires use of CIGuiSII Windows application software provided on CD ROM CIC496.
- 411	IEC 1000-4-11 test firmware
- 413	IEC 1000-4-13 test hardware and firmware
-ABD	Airbus ABD0100.1.8 Test software (refer to Avionics Software Manual P/N 4994-971 for details).. Note: Requires use of CIGuiSII Windows application software provided on CD ROM CIC496.
-AMD	Airbus AMD24C Test software (refer to Avionics Software Manual P/N 4994-971 for details).. Note: Requires use of CIGuiSII Windows application software

	provided on CD ROM CIC496.
-EOS1 / -EOS3	Electronic output switch for IEC 61000-4-11 testing. Includes –411 firmware option. Single or three phase versions. (i/iX Only)
-LAN	Adds Ethernet interface (RJ45 connector) for local area network connection. (Available on P/N 7000-485 and 7000-486 models only).
-LF	Limits maximum output frequency to 500 Hz.
-FC	Sweep the output frequency to $\pm 0.25\%$ of program value
-LNS	Line sync option to synchronize output frequency to input mains line frequency
-MODE-iX	Available for 9003iX and 15003iX configurations only. Switches output configurations between single-phase and three-phase mode of operation. Note that programmable impedance function on systems with –MODE-iX option is only available when in 3 phase mode.
-RMS	Rack mounting kit with slides. Removable rack ears/handles standard.
<b>Lumped Impedances</b>	Available in different power levels and no. of phases as listed.
-OMNI-1-18i	Single phase lumped reference impedance network of IEC1000-3-3 Flicker test
-OMNI-1-37i	Single phase lumped reference impedance network of IEC1000-3-3 Flicker test – High current.
-OMNI-3-18i	Three phase lumped reference impedance network of IEC1000-3-3 Flicker test
-OMNI-3-37i	Three phase lumped reference impedance network of IEC1000-3-3 Flicker test – High current.
<b>Accessories</b>	<b>Description</b>
-TI	Function strobe break out box. Function strobe / Trigger Output connection break out box. Provides BNC output with internal 9Vdc pull up for connection to external equipment such as oscilloscope. Compatible with 3001i/iX and 5001i/iX. Refer to section 3.6.7.
-TIS	Function strobe break out box for systems. Function strobe / Trigger Output connection break out box. Provides BNC output with internal 9Vdc pull up for connection to external equipment such as oscilloscope. Compatible with multi-chassis i/iX Series configurations. Refer to section 3.6.7.

## 2.7 Supplemental Specifications

Supplemental specifications are not warranted and generally reflect typical performance characteristics. These characteristics have been checked on a type test basis only and are not verified on each unit shipped. They are provided for reference only.

### 2.7.1 Output

Output Parameter	
<b>Voltage:</b>	
Slew rate:	> 0.5 V/micro sec
Stability:	0.25 % over 24 hour period at constant line, load and temperature.

---

<b>Output Parameter</b>	
Settling time:	< 0.5 msec
<b>Frequency:</b>	
Temperature coefficient:	$\pm 5$ ppm per degree C
Stability:	$\pm 15$ ppm per year

## 3. Unpacking and Installation

### 3.1 Unpacking

Inspect the unit for any possible shipping damage immediately upon receipt. If damage is evident, notify the carrier. **DO NOT** return an instrument to the factory without prior approval. Do not destroy the packing container until the unit has been inspected for damage in shipment.



**WARNING:** This power source weighs 61 lb (28kg). Obtain adequate help when moving or mounting the unit.

### 3.2 Power Requirements

The 3001iX AC Power Source has been designed to operate from a single-phase 208 to 240 volt AC line. The 5001iX AC Power Source and its systems have been designed to operate from a three-phase AC line voltage. Three three-phase input models are available for inputs of 208-240 V<sub>LL</sub>, 400-440 V<sub>LL</sub> (option -400), or 400-480 V<sub>LL</sub> (option -400).



**CAUTION:** Do not connect 400-480V into the 208-240V unit, the result could be a severely damaged unit.

Figure 3-1: The 5001iX Power Source

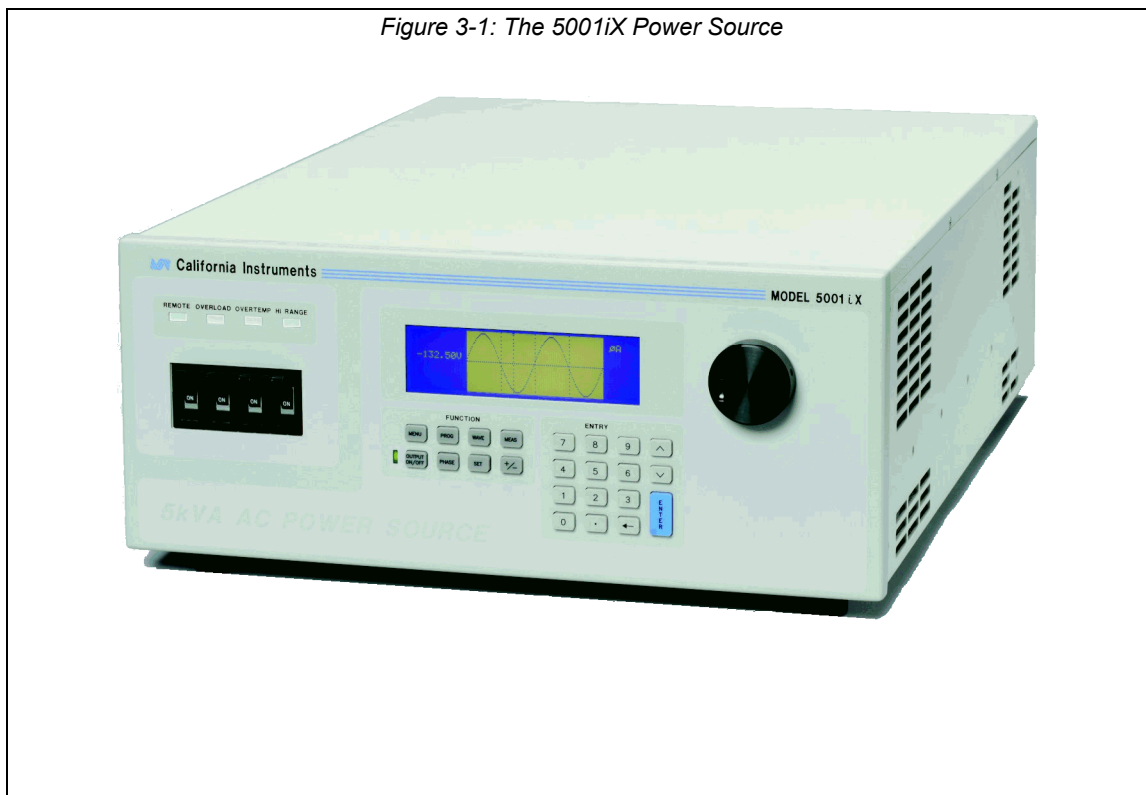

---

### 3.3 Mechanical Installation

---

The 3001i/iX and 5001i/iX are completely self-contained power sources. They may be used free standing on a bench top or rack mounted using the optional rack mount/handle kit. The units are fan cooled, drawing air in from the sides and exhausting at the rear. The sides of each unit must be kept clear of obstruction and a 6" clearance must be maintained to the rear. Special consideration of overall air flow characteristics and the resultant internal heat rise must be allowed for with systems installed inside enclosed cabinets to avoid self heating and over temperature problems.

---

### 3.4 Input Wiring – TB1

---

The input terminal block, TB1, is located at the rear of the unit. Ground (earth) wire must be connected to the chassis of the AC power system. The mains source must have a current rating equal to or greater than the input circuit breaker and the input wiring must be sized to satisfy the applicable electrical codes. The input terminal block cover and strain relief must be installed in table top applications to maintain protection against hazardous voltages.



**CAUTION:** *Capacitors in the power source may hold a hazardous electrical charge even if the power source has been disconnected from the mains supply. Allow capacitors to discharge to a safe voltage before touching exposed pins of mains supply connectors.*

---

---

### 3.5 Output Power Connections – TB2

---

The output terminal block, TB2, is located at the rear of the unit. The external sense inputs allow the power system output voltages to be monitored directly at the load and must be connected either at TB2 or the load when the sense is programmed for external. The external sense input does not have to be connected when Internal Sense is programmed. The external sense wires are to be connected to TB3 on the rear panel and should be run as a twisted pair for short lengths. Sense leads over three (3) feet long should be run as a twisted shielded pair. Refer to Figures 3-2 through 3-12 for all connections.

---

**Note:** *The output of the power source is isolated from the input line and floating from chassis ground. If needed, either side (HI or LO) may be grounded.*

---



The output power cables must be large enough to prevent a total voltage drop exceeding 1% of the rated output voltage between the power source and the load. Table 3-1 shows the AWG size of the cables that may be used. Cable lengths must not exceed twenty-five (25) feet. For lengths greater than 25 feet, calculate the voltage drop from the following formula:

$$2 \times \text{DISTANCE} \times \text{CABLE RESISTANCE PER FT.} \times \text{CURRENT} = \text{VOLT DROP}$$

Table 3-1: Wire Sizes

LOAD CURRENT	WIRE GAGE
22 AMPS	10 AWG
37 AMPS	8 AWG
74 AMPS	4 AWG
111 AMPS	2 AWG

## 3.6 Connectors - Rear Panel

A number of connectors are located along the top rear covers. These connectors are in a recessed area to protect them from shipment damage.

### 3.6.1 System Interface, Clock and Lock Connectors



**WARNING:** The system interface connector and Clock and Lock connectors may be at hazardous voltages. These connections may not be used in table top applications. In table top applications the safety cover must be in place. These connections may only be used when the equipment is enclosed in a rack, only within one rack, only with California Instruments supplied cables, and only between California Instruments equipment.

J21 and J20 are the Clock and Lock connectors and are used to synchronize and control the phase shift between the three outputs when 3 units are operating as a three-phase system with the 15003iX - LK option.

The System Interface connector, J22, is used to connect the slave power sources to the Master power source (the one with the controller) in multiple box systems. The connector is also used for the external sync input, external modulation input and trigger output.

Table 3-2: System Interface Connector (J22)

J22	Description
1	Analog Common: analog signal common
2	MR B: Phase B master signal
3	Analog Common
4	CS B: Phase B current sum
5	CT Common: Current transformer common
6	OSC B: Phase B oscillator output
7	Analog Common
8	CL B: Phase B current limit reference
9	EXT MOD: External modulation input. A 10 volt input will modulate the output 10%. Original versions of iX power sources required a 100 volt input to modulate the output by 10%. If you experience problems using the external modulation input, contact California Instruments customer service.
10	$\overline{\text{OVR TEMP}}$ : A logic low output to indicate an over temperature condition.
11	$\overline{\text{CNF}}$ : Output relay state: Logic HI = open, LOW = closed.
12	FLT C: Phase C current limit fault control
13	FLT A: Phase A current limit fault control
14	F STB LO: Function Strobe / Trigger output Low signal. This is the emitter lead of an optically isolated NPN transistor. The internal power controller turns this transistor on to indicate a change of programmed values. See section 3.6.7 for details.
15	EX SYNC LO: External Sync Low signal. This is the ground return for the TTL external sync input. It connects to the cathode of an LED at the input of an opto coupler. Refer to J22-32.
16	AMP SHARE B
17	PARALLEL
18	CL ENA

J22	Description
19	MR C: Phase C master signal
20	MR A: Phase A master signal
21	CS C: Phase C current sum
22	CS A: Phase A current sum
23	OSC C: Phase C oscillator output
24	OSC A: Phase A oscillator output
25	CL C: Phase C current limit reference
26	CL A: Phase A current limit reference
27	D COM: Digital Common
28	RNG HI: Voltage range state: Logic HI = high range, LOW = low range
29	Overload
30	FLT B: Phase B current limit fault control
31	F STB HI: Function Strobe / Trigger output HI. A low-going pulse, >400 $\mu$ s, that indicates voltage or frequency change. Isolated output that requires a pull-up resistor, 22K $\Omega$ , to +5 VDC. Use J22 pin 14 (F STB LO) for common. See section 3.6.7 for details.
32	EX SYNC HI, External Sync input HI. This is an input that can be used to synchronize the outputs of the AC Power System. This input requires a logic high level of at least +4.5 VDC at 5 mA. The input should have a duty cycle 50 $\pm$ 30%. J22-15 is the common input. The External Sync input is optically isolated. It must be enabled from the SNC screen.
33	AMP SHARE C
34	AMP SHARE A
35	FLICKER / BYPASS
36	REMOTE ON: This is a logic input that can be used to remove the programmed output voltage. A logic low on this pin will cause the output voltages to be programmed to 0.0 volts and the output relays to open. A logic high will cause the programmed output voltage to be restored at the output terminals. A contact closure between this pin and J22-27 (D COM) will simulate a logic low state.

### 3.6.2 Remote Sense Connector TB3

When selecting external sense mode, it is important that the remote sense connections are hooked up at the EUT or at the sense point. For single-phase systems, connect Phase A to phase A and neutral to neutral. For three-phase system configurations, connect all three phase.

---

**NOTE: Do not reverse or swap sense connection phasing or damage to the unit may result.**

---



---

**NOTE: Do not disconnect the external sense connection if external sense mode is selected. Doing so will cause the output voltage to go to its maximum value and could potentially damage an EUT.**

---

All 3001iX and 5001iX AC Sources are shipped with the sense connections wired to the output terminals. This will prevent a voltage fault when the external sense mode is selected. On systems consisting of multiple 3001iX or 5001iX chassis, the end user has to connect the external sense inputs to allow the system to operate. Some system configuration do not support Internal sense mode in which case the sense connection must always be present at TB3.

To prevent an excessive output voltage caused by an open external sense condition on single chassis i/iX systems (3001,5001), a set of 10Kohm, 10 Watt resistors can be used to connect the output terminal block (TB2) to the external sense connection. This will cause a 0.2% error if the sense lines are not connected. The 10 Watt rating will keep the resistor from burning if the sense lines connected to the load but the output wiring becomes disconnected. On three phase systems, the output of all phase output terminals must be connected to the master sense connector of the master unit to accomplish the same.

*Table 3-3: Remote Sense Connector – TB3*

Pin	Description
A	Phase A sense
B	Phase B sense
C	Phase C sense
N	Neutral sense

### 3.6.3 RS232C Serial Interface Connector – J18

Note that two versions of the RS232 exist on the iX/i model Series II depending on the age of the unit. Older models can be identified by the fact that they will not have a USB interface.

Pin	Name	Direction
1	N/C	
2	TxD	Output
3	RxD	Input
4	N/C	
5	Common	Common
6	N/C	
7	CTS	Input
8	RTS	Output
9	N/C	

Table 3-4: RS232 Connector pin out – Units with RS232 and USB.

Pin	Name	Direction
1	N/C	
2	RxD, Receive data	Output
3	TxD, Transmit data	Input
4	DTR, Data Terminal Ready	DTR, Data Terminal Ready
5	Common	Common
6	N/C	N/C
7	RTS, Request to Send	Output
8	N/C	N/C
9	N/C	N/C

Table 3-5: RS232C Connector – Units with RS232 but no USB.

On i/iX models without a USB interface, a special RS232 cable is required to connect to a PC. With these models, a special 6 foot / 2 meter long cable (CI P/N 7000-263-1) is supplied in the i/iX Series ship-kit. The wiring diagram for this cable is shown below in case a longer cable has to be constructed. Alternatively, a generic straight thru DB9 male to DB9 female cable can be used to extend the supplied cable.

The i/iX models that have both RS232 and USB interface use a regular straight through DB9 male to DB9 female serial cable, which is supplied in the i/iX ship kit for these models. To connect the 5001iX to a PC's 9-pin DB9 serial port, a special RS232 cable is required.

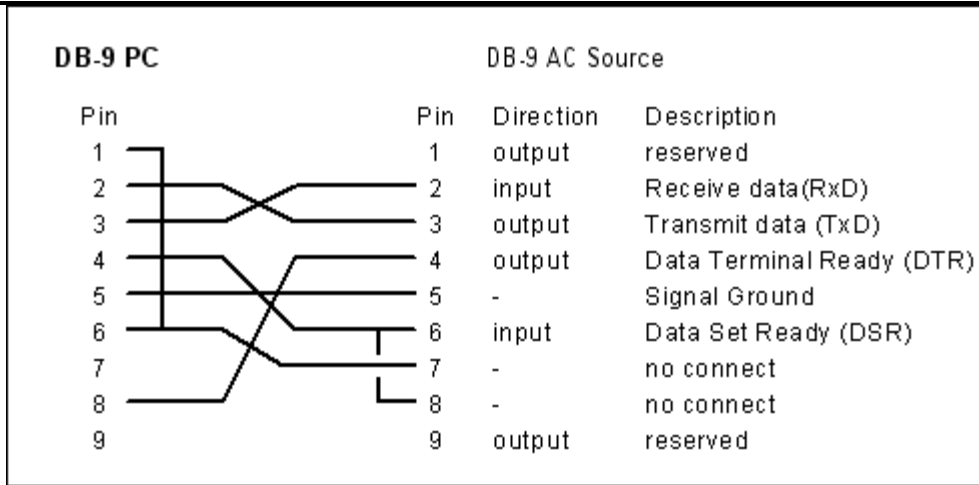

Figure 3-2: RS232C Cable for PC Connection wiring diagram – Units without USB.

### 3.6.4 USB Interface

A standard USB Series B device connector is located on the rear panel for remote control. A standard USB cable between the AC Source and a PC or USB Hub may be used.

**Note:** Use of the USB port to control more than one power source from a single PC is not recommended, as communication may not be reliable. Use GPIB interface for multiple power source control.



Figure 3-3: USB Connector pin orientation.

Pin	Name	Description
1	VBUS	+5 VDC
2	D-	Data -
3	D+	Data +
4	GND	Ground

Table 3-6: USB Connector pin out.

**3.6.5 LAN Interface – RJ45**

An optional RJ45 Ethernet 10BaseT connector is located on the rear panel for remote control. A standard RJ45 UTP patch cord between the AC Source and a network Hub may be used to connect the AC source to a LAN. For direct connection to a PC LAN card, a crossover RJ45 cable is required. Consult your network administrator for directions on connecting the AC source to any corporate LAN.

If the –LAN Ethernet interface option is present, the MAC Address (Media Access Control) of the Ethernet port is printed on the serial tag of the power source. The serial tag is located on the rear panel of the unit.

For information on how to set up a network connection or a direct PC connection using the LAN interface, refer to the iX Series Programming Manual P/N 7000-982 distributed in Adobe PDF format on CD ROM CIC496.

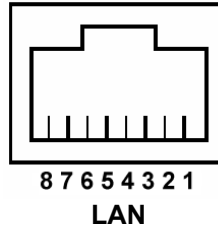

Pin	Ethernet TPE 10BaseT/100BastT/1000BaseT	EIA/TIA 568A	EIA/TIA 568B Crossover
1	Transmit/Receive Data 0 +	White with green stripe	White with orange stripe
2	Transmit/Receive Data 0 -	Green with white stripe or solid green	Orange with white stripe or solid orange
3	Transmit/Receive Data 1 +	White with orange stripe	White with green stripe
4	Transmit/Receive Data 2 +	Blue with white stripe or solid blue	Blue with white stripe or solid blue
5	Transmit/Receive Data 2 -	White with blue stripe	White with blue stripe
6	Transmit/Receive Data 1 -	Orange with white stripe or solid orange	Green with white stripe or solid
7	Transmit/Receive Data 3 +	White with brown stripe or solid brown	White with brown stripe or solid brown
8	Transmit/Receive Data 3 -	Brown with white stripe or solid brown.	Brown with white stripe or solid brown

Table 3-7: RJ45 LAN Connector pin out.

**3.6.6 I/O Option – J58**

This connector is reserved for control of the EOS option. Do not connect anything else to this connector.

**3.6.7 Function Strobe / Trigger Out – J22-31 / J22-14**

A function strobe output is available on the System Interface connector. This open collector output may be used to trigger external equipment when voltage or frequency change occurs on the AC source.

This output generates a low-going pulse, > 400µs in duration, that indicates voltage or frequency change. Since this is an isolated output, an external DC supply and pull-up resistor, 22KΩ, 1/8 W is required. To create a TTL level output, a +5V or +3.3V DC supply is required. To create a signal for viewing on a scope, a higher DC voltage such as a 9V battery may be used.

Connect the DC supply and pull-up resistor as shown.

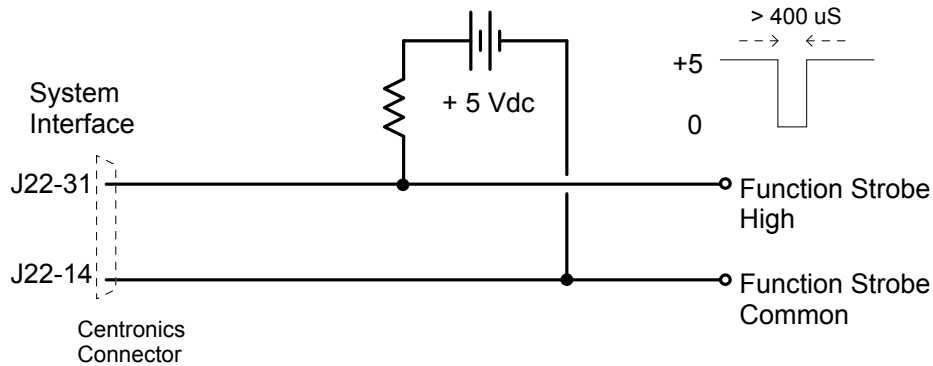

Figure 3-4: Function Strobe Connection.

When running list transients on the AC source, the LIST:TTLTrigger SCPI command may be used to reassign the operation of the Function Strobe output as a trigger output. An output pulse is generated for each logic “1” in the TTLTrigger list. See the iX/i Series Programming Manual P/N 7000-982 for details on the transient list system.

**Trigger BNC Breakout Box**

A convenient trigger BNC breakout box is available from California Instruments which facilitates connection to the Function Strobe / Trigger Output signal on the system interface connector. A 9V DC battery is used to provide the required DC supply. This small box can be ordered through customer service or sales under P/N 7000-481-1 (for 3001i/iX and 5001i/iX) or P/N 7000-481-2 (for all multi-chassis i/iX systems).

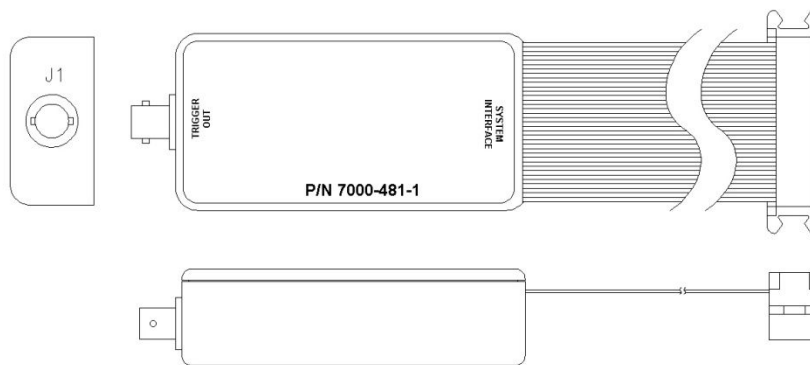

Figure 3-5: Function Strobe / Trigger Output Accessory.



---

**3.6.8 Remote Inhibit – J22-36 / J22-27**

---

The Remote Inhibit input J22 pin 36 can be used to open and close the output relay of the AC power source. This input overrides the state of the output relay programmed from the front panel or the bus. It may be used for safety interlock purposes.

The default level for remote inhibit is a logic low or contact closure between pin J22-36 and pin J22-27 (D COM). This will cause the output voltage to be programmed to 0.0 volts and the output relays to open.

The mode of operation of the remote inhibit can be changed using the Output mode bus command. This command selects the mode of operation of the Remote Inhibit protection. The following modes can be selected:

- |          |                                                                                                                                      |
|----------|--------------------------------------------------------------------------------------------------------------------------------------|
| LATCHing | A TTL low at the RI input latches the output in the protection shutdown state, which can only be cleared by OUTPUT:PROTECTION:CLEAR. |
| LIVE     | The output state follows the state of the RI input. A TTL low at the RI input turns the output off; a TTL high turns the output on.  |
| OFF      | The instrument ignores the RI input.                                                                                                 |

The RI output state is saved at power down. The factory default state is LIVE.

For details on programming the remote inhibit function, refer to the iX programming manual (P/N 7000-982).

Figure 3-6: Rear Panel View for the 3001iM/iX (Series II)

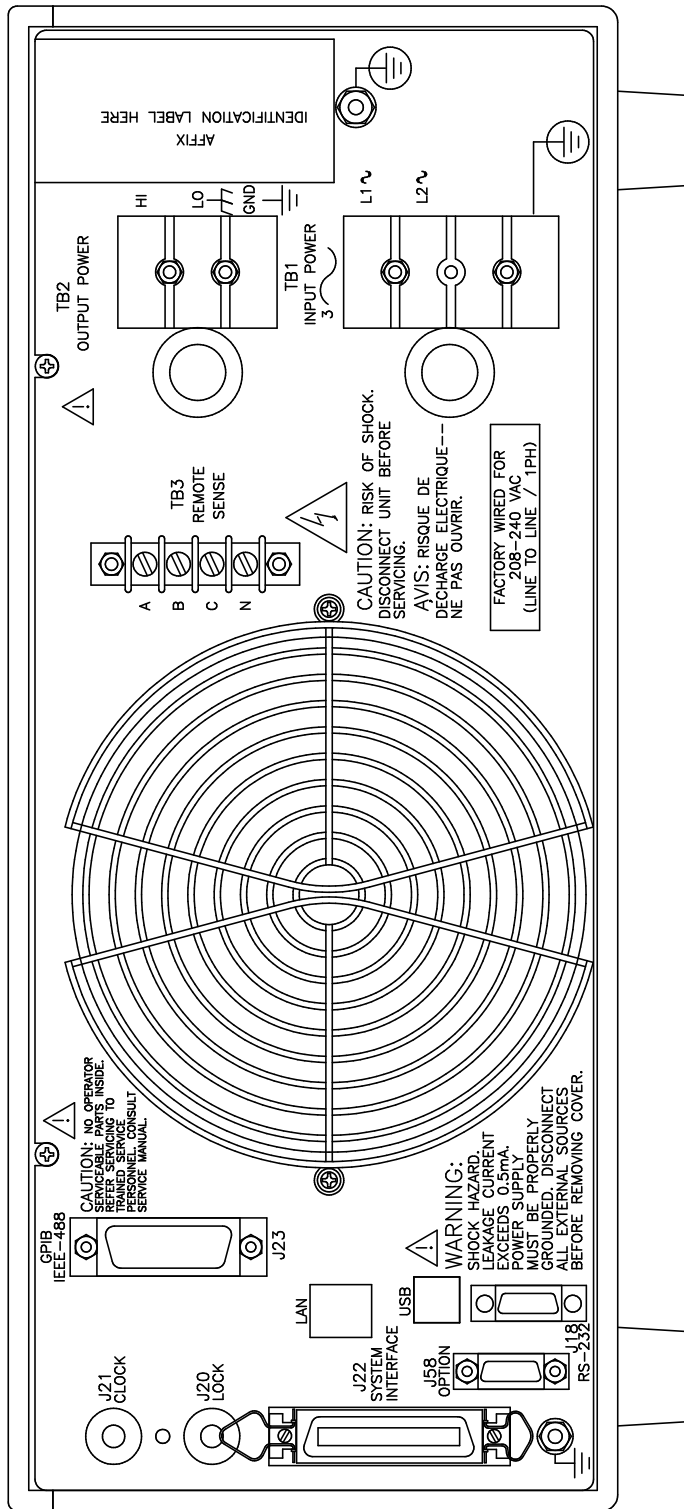
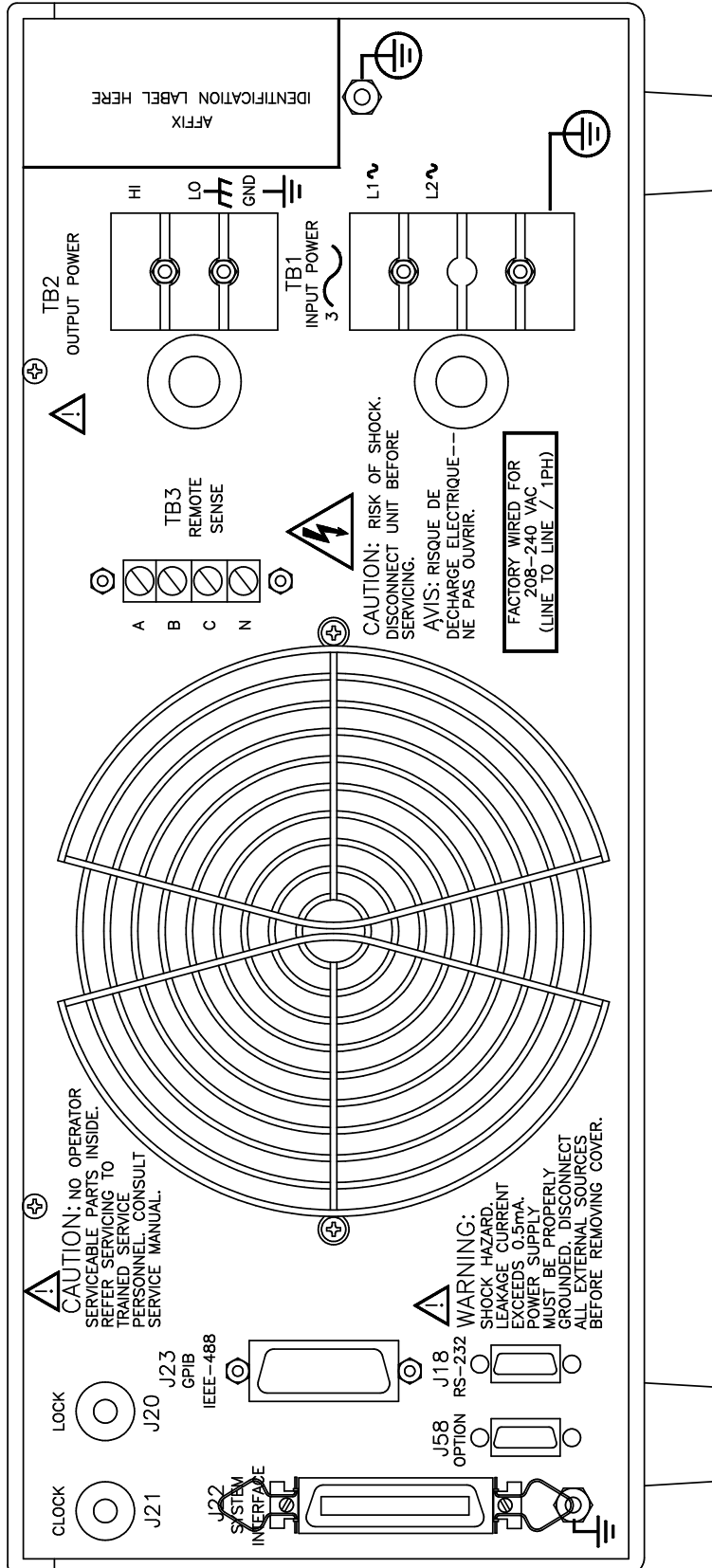

Figure 3-7: Rear Panel View for the 3001i/3001iX (Series I, no USB)



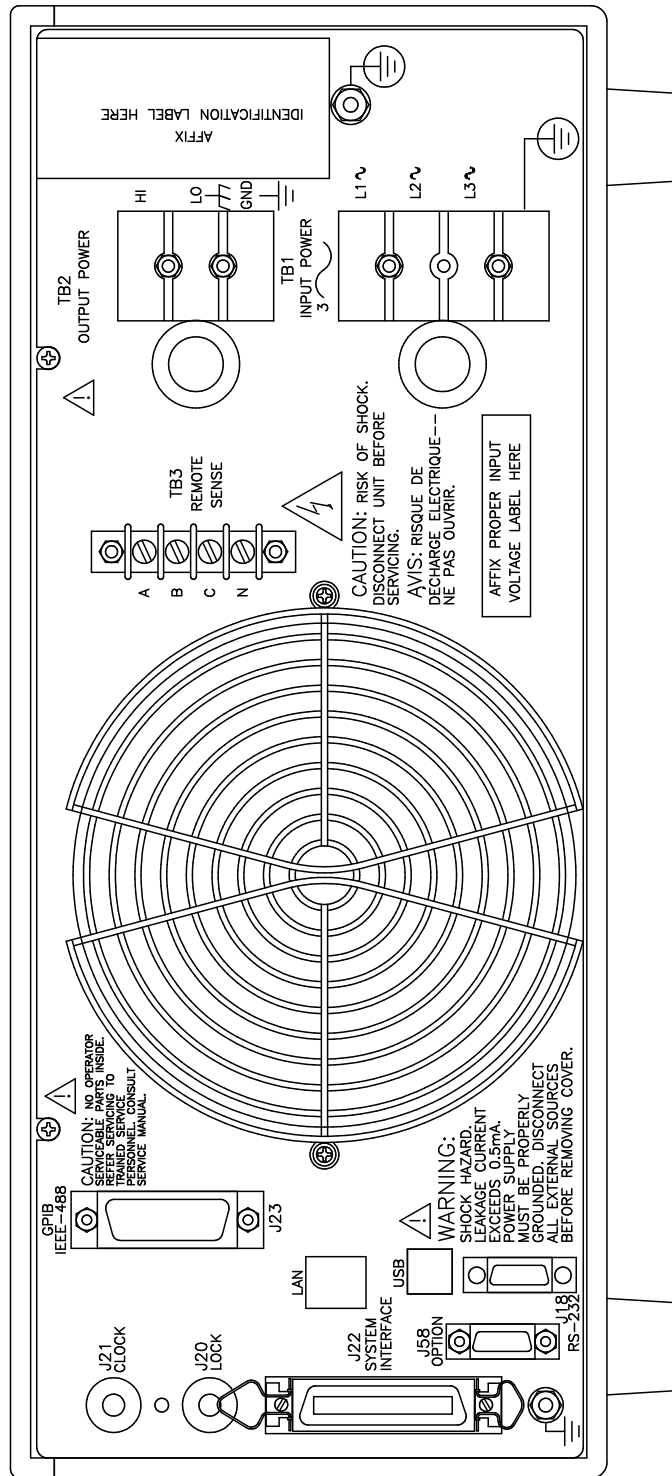
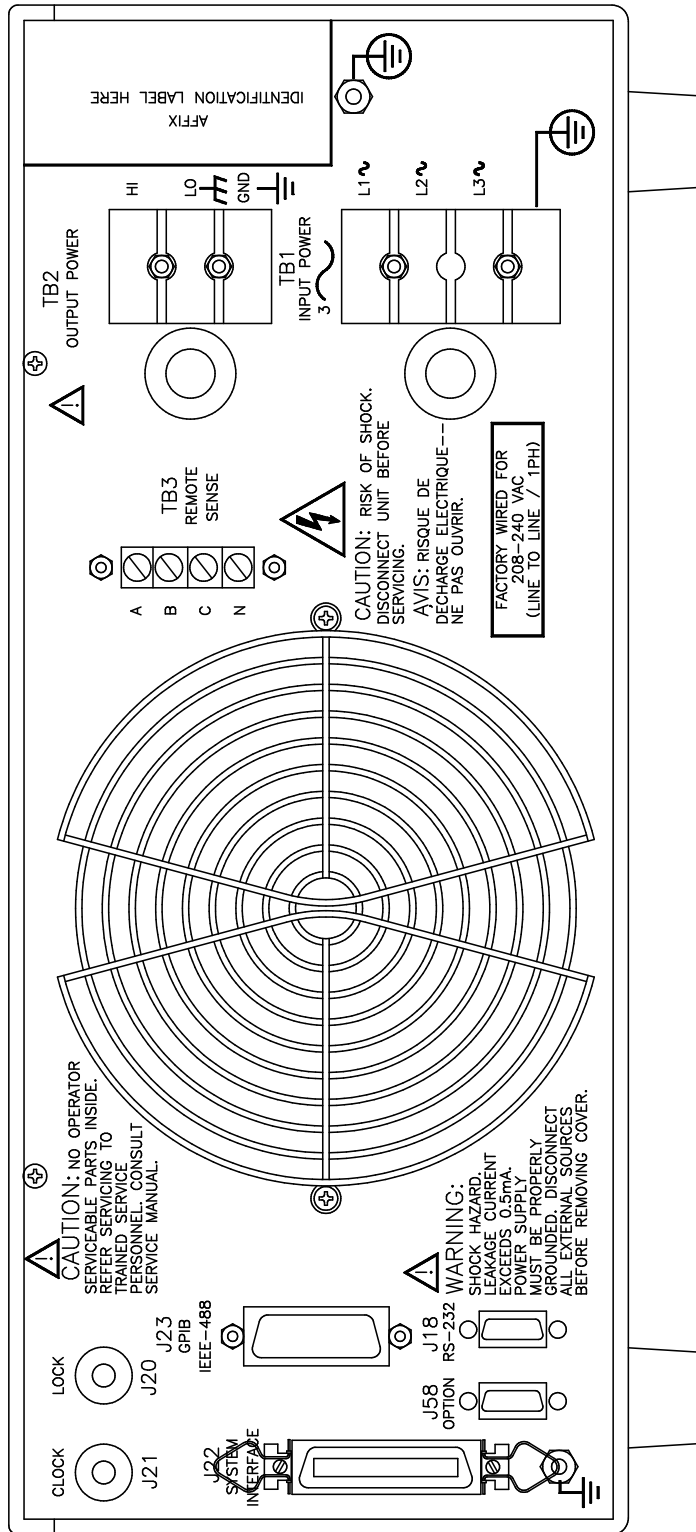

Figure 3-9: Rear Panel View for the 5001i/5001iX (Series I, no USB)



### 3.7 Single-Phase and Three Phase Multiple Box System Configurations

#### Three Phase System:

The three phase system will be configured ready for use when ordered as such from the factory. One unit, with the controller, will be identified as Phase A on the serial number tag. The other two units will be identified on their serial number tags as either Phase B or Phase C. The power sources **must** be installed in the system according to the phase markings on the serial number tags. There will be one master unit that will have a full controller and the slaves will have blank front panels except for the circuit breaker and indicator lights.

The three units must be interconnected using the system Interface cable. The three **LO** outputs must also be connected together before applying power.

If the units were purchased as single phase units and have not been configured for a three phase system please consult the factory.

#### Single Phase System:

In a single phase system consisting of two or three units there will be one master unit that will have a full controller and the slaves will have blank front panels except for the circuit breaker and indicator lights.

The units must all be connected with the system interface cable, **but not the clock and lock cables**. The HI outputs on all the terminal blocks should be connected together. The LO outputs should all be connected together and a heavy duty cable run to the load from the HI and LO outputs. See Table 3-1 for cable sizing.

The appropriate jumpers have been installed at the factory before shipment. If it becomes necessary to change the system to three phase output, please consult the factory.

### 3.8 Output Voltage Ranges

The iX Series II power sources have two AC voltage ranges (150Vrms and 300Vrms) and two DC voltage ranged (200Vdc and 400Vdc). The maximum available load current is a function of both the mode of operation (AC, DC or AC+DC mode) and the selected voltage range (high or low).

### 3.9 Functional Test



**CAUTION:** *Work carefully when performing these tests, hazardous voltages are present on the input and output during this test.*

Refer to Figure 3-11 for the test set up.

1. Connect an oscilloscope, voltmeter and/or distortion analyzer to the AC source output at the output terminal block (TB2).
2. With the AC mains verified as being off, apply the correct three phase AC power input voltage connections to the AC source input terminals barrier (TB1). Apply the AC mains power and turn on the main circuit breaker on the AC source front panel.
3. Verify the front panel LCD display lights up with the initial start up screen showing the unit ID and serial number. A self check routine screen will follow and finally the system will display the main "Menu 1" screen with the cursor highlighting the "Program" selection.
4. Press "ENTER" and the unit will display the Program selection screen. Set the following output parameters: output voltage = 150 volts, frequency = 60 Hz, voltage range = 150 volts, and current limit = 20.0 amps (300iX) or 33.3 amps (500iX). Press "ENTER".

- 
5. Enable the output by pressing the output “on/off” button below the front panel display screen. The green LED next to the button will light green when the output is on. The output should be a clean 150 volt AC sinewave having less than 1% distortion.
  6. Apply full load to the output of the source and verify the output remains within 2% of the initial 150 volt value. The output should still be clean and the distortion should still be less than 1% at 60 Hz.
  7. Using the PROGRAM screen set the output current limit value to 17 amps. The system should go into current limit. Return the current value to 20.0 amps (3001iX) or 33.3 amps (5001iX) and press the output on/off button to turn the output off. Disconnect the load.
  8. Repeat steps 4 through 7 but set the output for the following: output voltage = 300 volts, output range = 300 volts, current limit = 10.0 amps (3001iX) or 16.7 amps (5001iX). For step 7, the current limit value can be set to 8 amps.

In the unlikely event the power source does not pass the functional test, refer to the calibration procedure in Section 6 or call California Instrument’s customer satisfaction department for further assistance.

Figure 3-10: Connection For Single Power Source (5001iX/i, 3001iX/i)

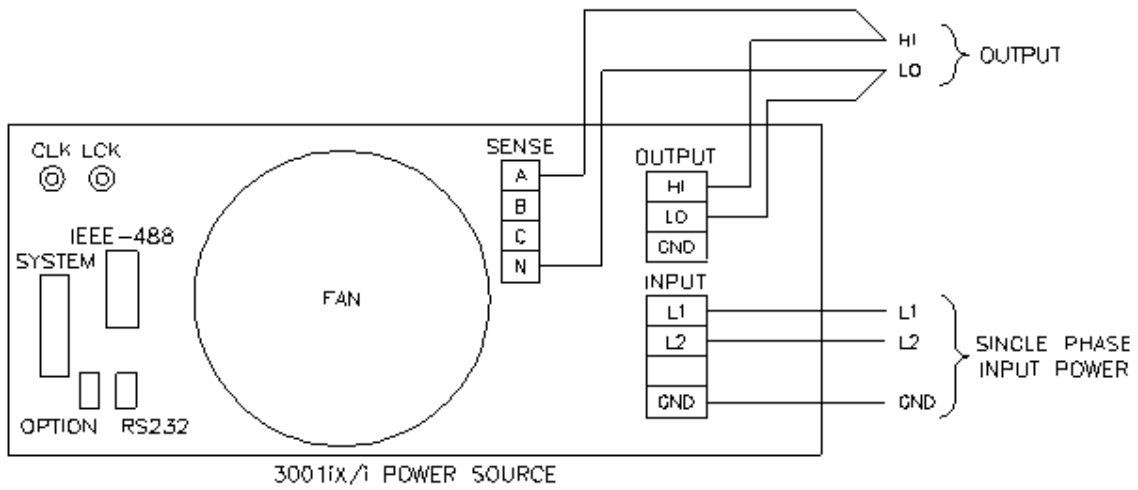
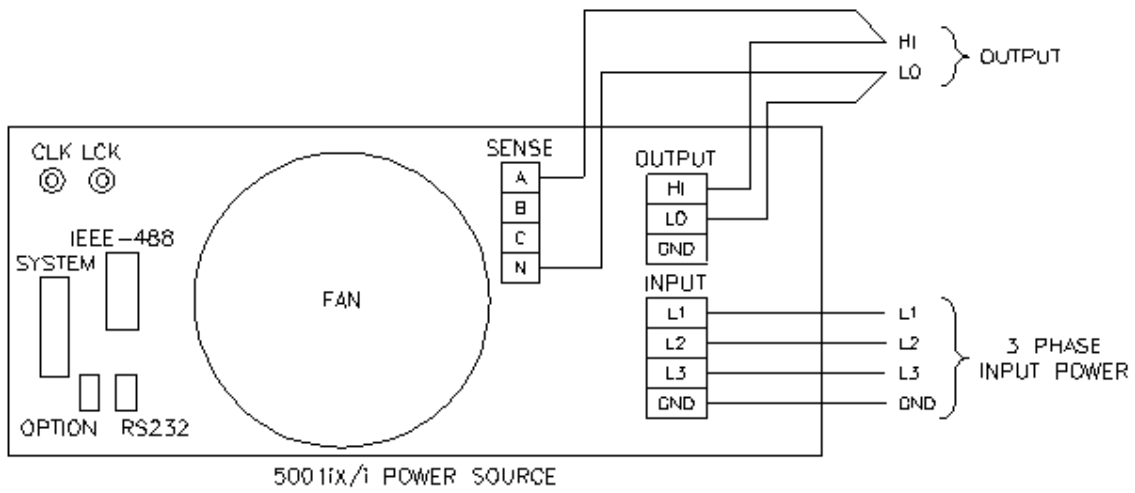



Figure 3-11: Functional Test Setup

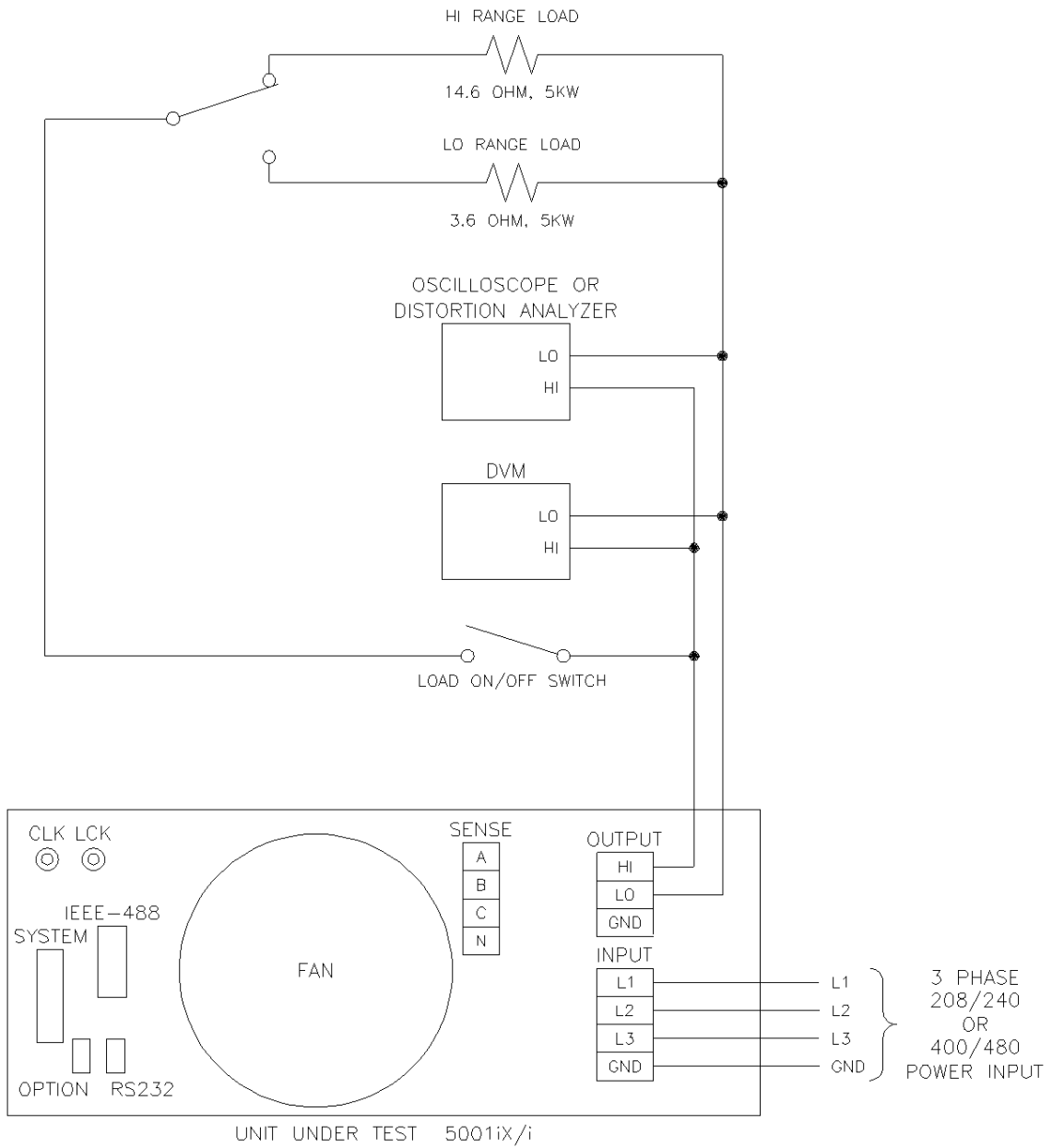

Figure 3-12: Single Phase 10000 VA System (10001iX/i)

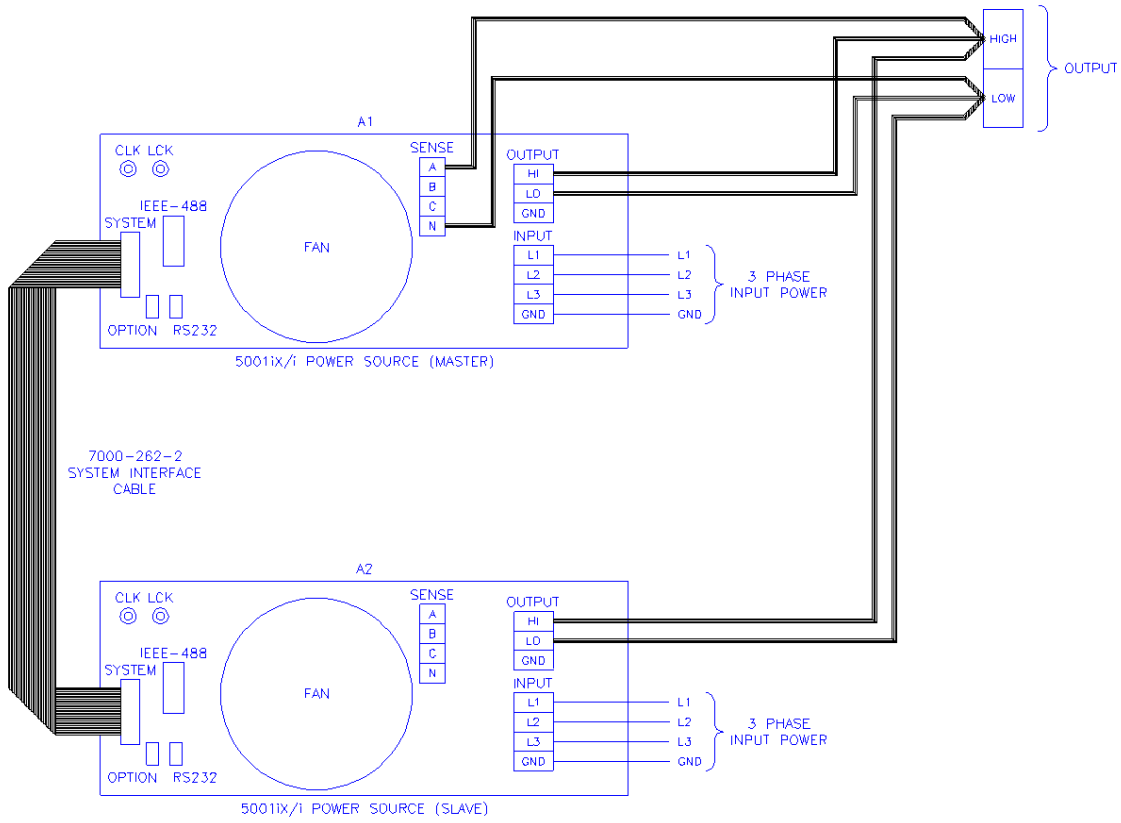

Figure 3-13: Two Phase 10000 VA System (10002i/iX – One Controller)

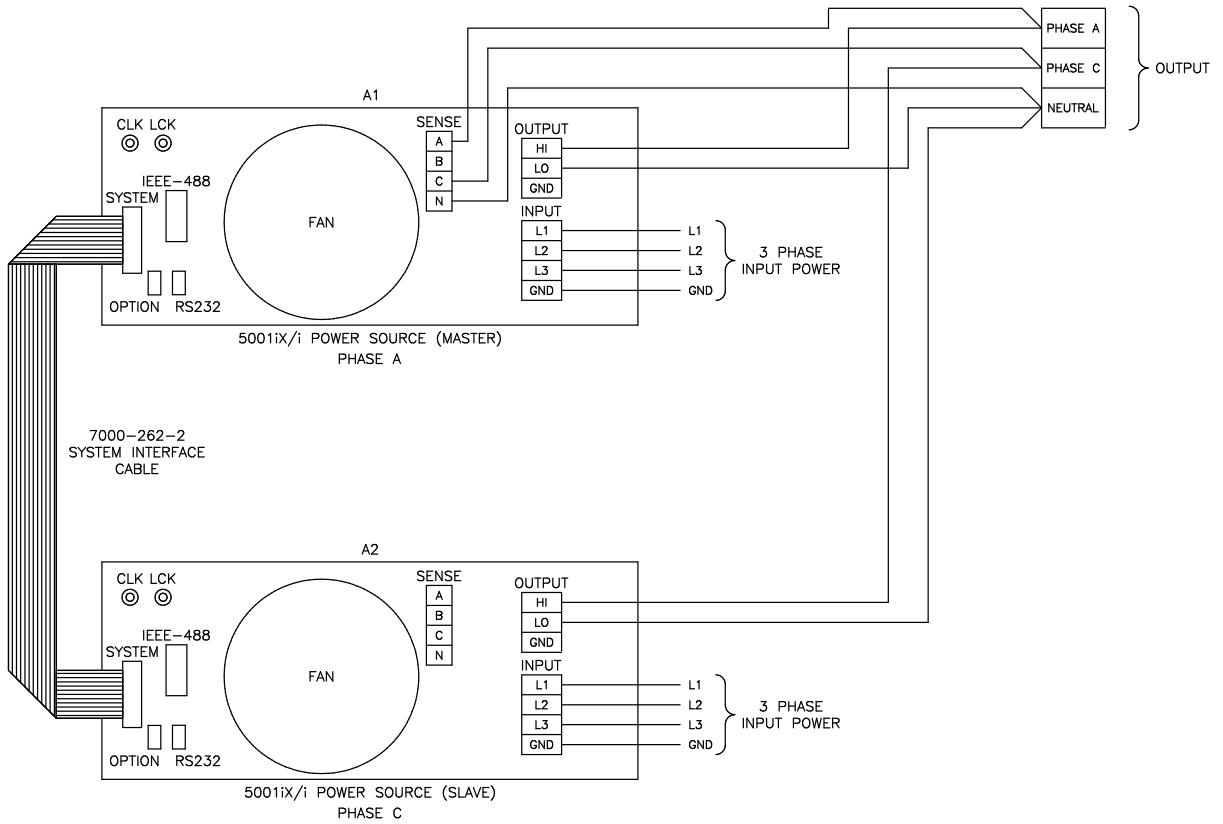

Figure 3-14: Three Phase 15000 VA System (15003iX/i-LK Three Controllers)

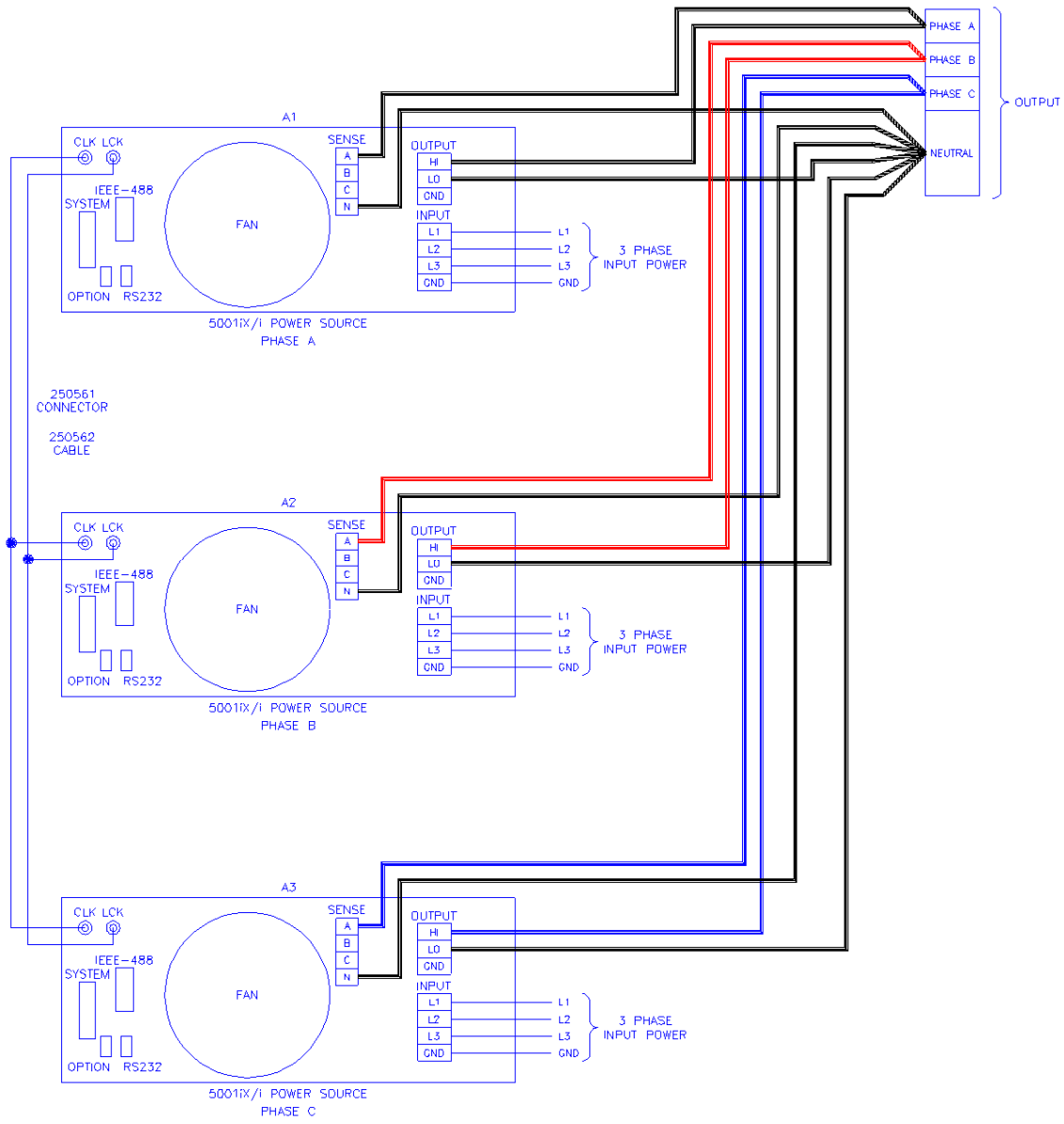

Figure 3-15: Single Phase 15000 VA System (15001iX/i)

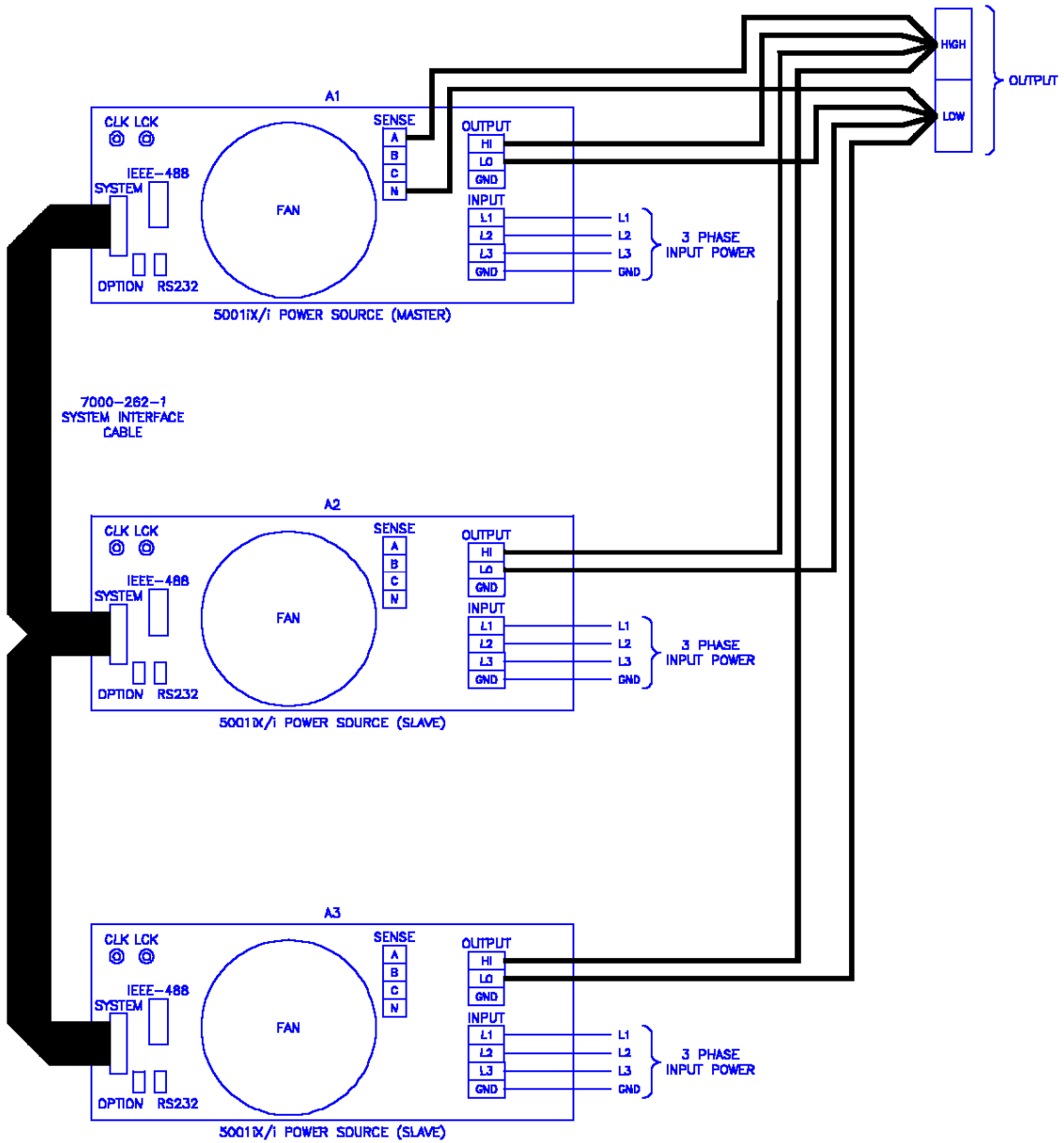

Figure 3-16: Three-Phase 15000 VA system (15003iX/i - One Controller)

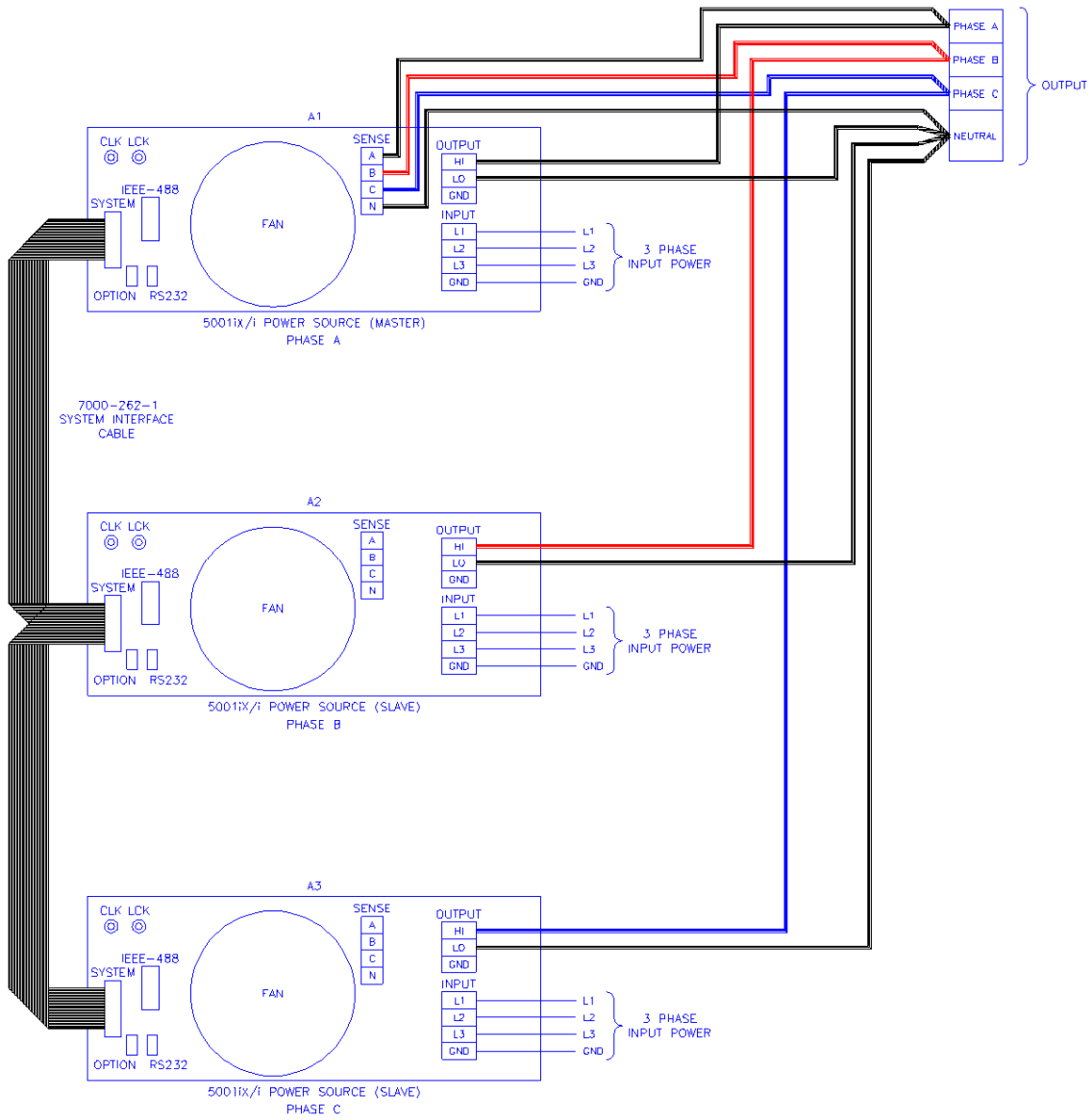

Figure 3-17: Connection With MODE Option

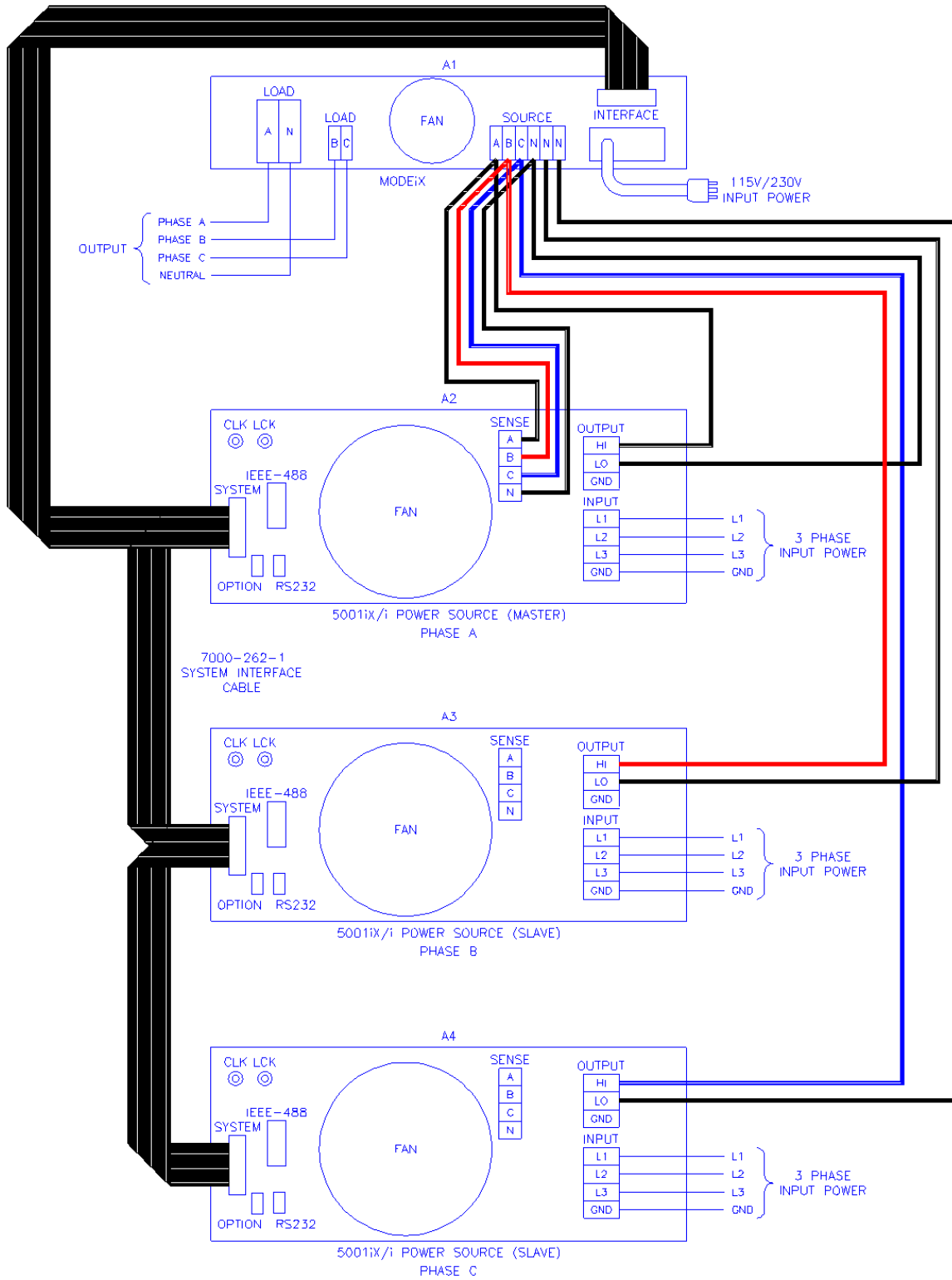

Figure 3-18: Two Phase 10000 VA System (10002i-LK Two Controllers)

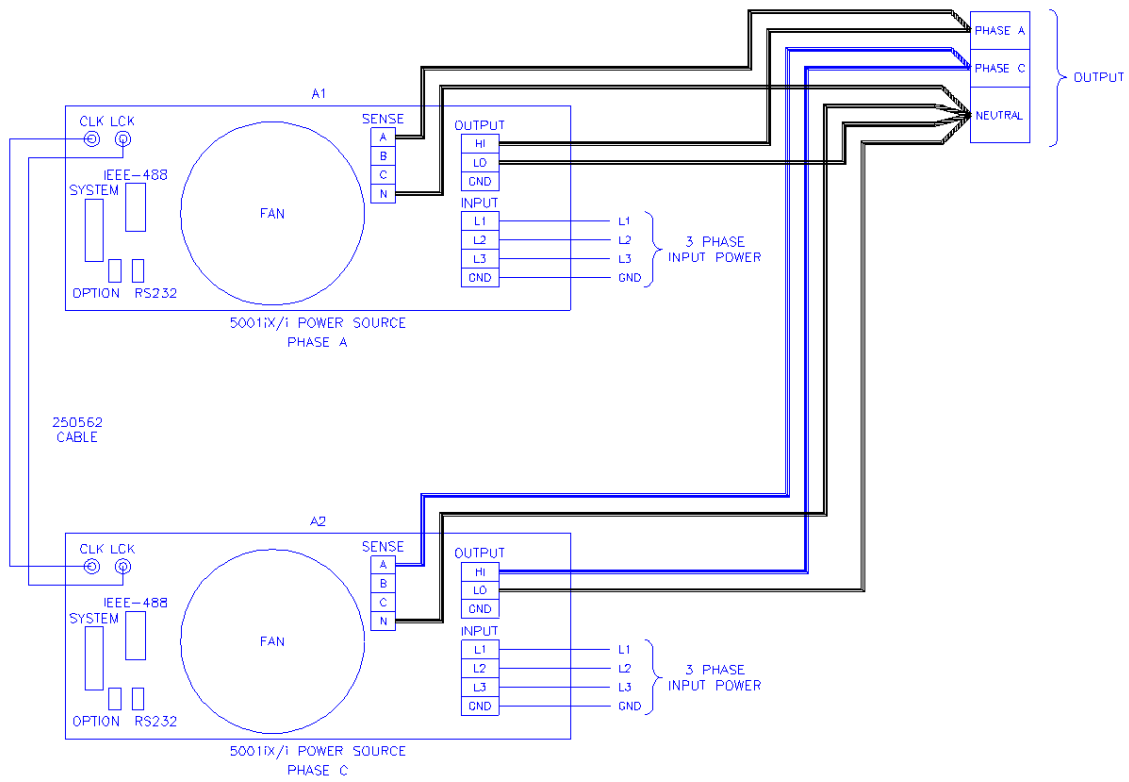
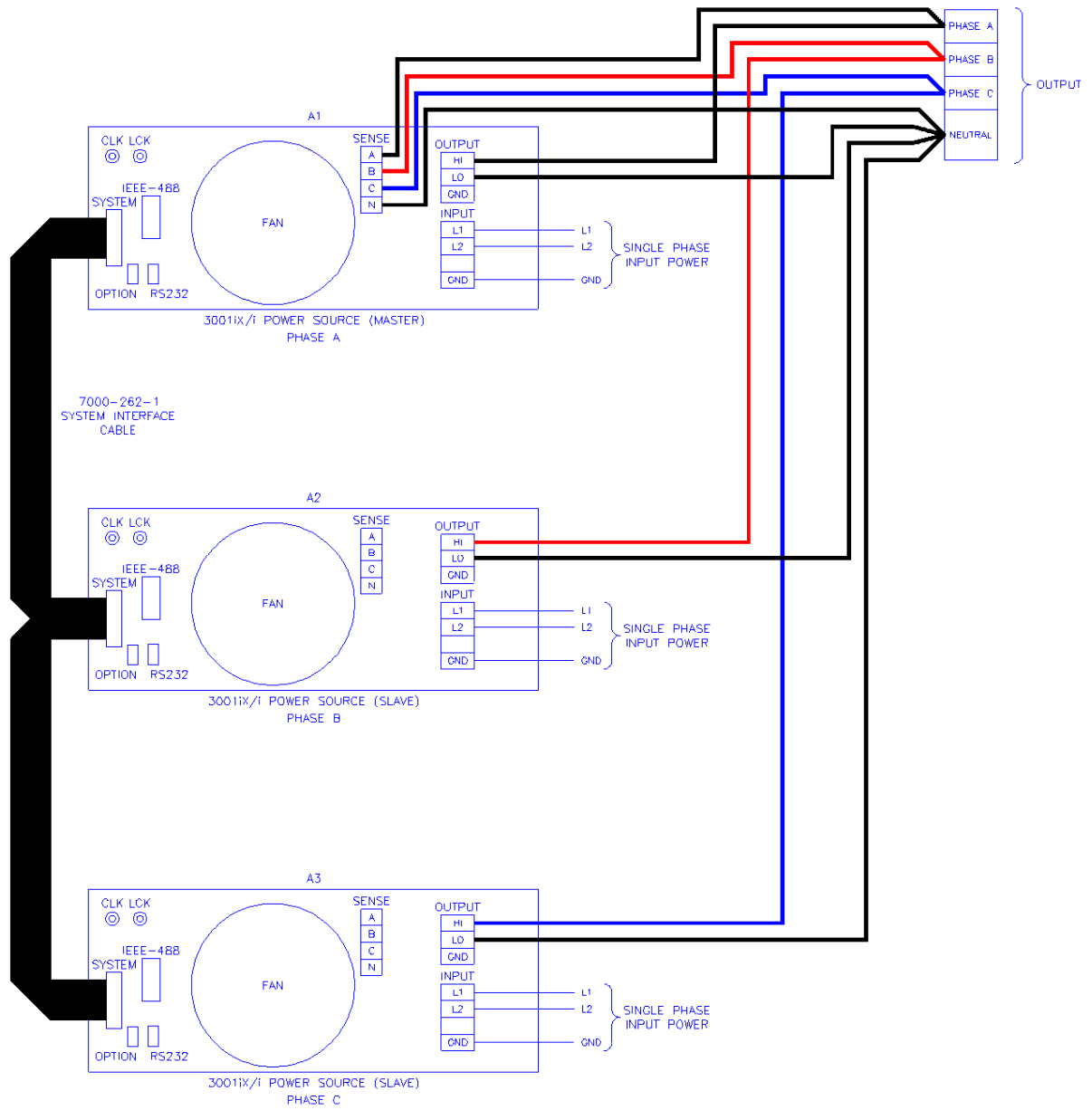



Figure 3-19: Three-Phase 9000 VA System (9003iX/i – One Controller)



## 4. Front Panel Operation

---

### 4.1 Tour of the Front Panel

---

The i, iM and iX Series front panels are identical although some of the keys found on the front panel are only used by i Series or iX Series models. If your unit is an i Series or iM Series, these keys will act as don't cares. This chapter provides information on operating the i, iX and iM Series AC sources from the front panel keyboard.

Before operating the AC source using the front panel, it helps to understand the operation of the front panel controls. Specifically, the operation of the knob, keyboard and the menu layout are covered in the next few paragraphs.

#### 4.1.1 Front Panel Controls and Indicators

---

The front panel can be divided in a small number of functional areas:

- Mains circuit breaker
- Status Indicator lights
- Shuttle knob
- LCD display
- FUNCTION keypad
- DATA ENTRY keypad

#### 4.1.2 Mains Circuit Breaker

---

The circuit breaker located on the bottom left side of the front panel disconnects the AC source from the three phase Line input. It will automatically trip when the input current rating of the unit is exceeded due to some component failure. The contrasting black color and large size throw bar make it easy to locate in case of an emergency.

#### 4.1.3 Status Indicator Lights

---

Four LED status indicators are located directly above the mains circuit breaker. These LED's correspond to the following conditions:

REMOTE	The REMOTE LED indicates that the unit is in remote control mode. If the IEEE-488 interface is used, this indicator will be lit whenever the REM line (REMOTE ENABLE) line is asserted by the IEEE controller. If the RS232C, USB or LAN interface is used, the REMOTE state can be enabled by the controller using the SYST:REM command. Any time the REMOTE LED is lit, the front panel of the i Series unit is disabled. There is no LOCAL button that allows the user to regain control of the front panel. This prevents accidental change of settings in ATE applications.
OVERLOAD	The OVERLOAD LED indicates an output overload condition. This condition can be controlled by setting the current limit value in the PROGRAM menu. Removing the load using the OUTPUT ON/OFF button will recover from an overload condition.
OVER TEMPERATURE	The OVER TEMPERATURE LED indicates an overheating problem inside the unit. This is an abnormal condition, which will cause the unit to shut off. Check the air openings to make sure they are not blocked.
HI RANGE	The HI RANGE LED is on when the high voltage output range has been selected.

#### 4.1.4 The Shuttle Knob

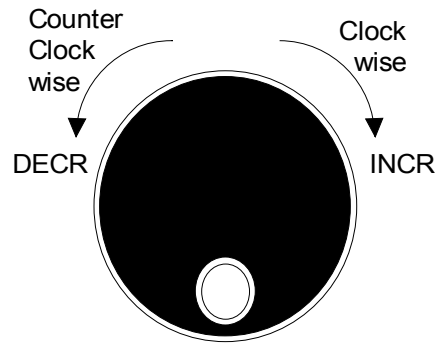

Figure 4-1: Shuttle Knob

The shuttle knob is located to the right of the LCD screen and is used to change setup parameters. Note that it cannot be used to move the cursor position between menu fields. Use the UP and DOWN arrow keys in the FUNCTION keypad for this.

The shuttle knob can operate in one of two distinct modes of operation:

<b>MODE</b>	<b>DESCRIPTION</b>
IMMEDIATE mode	Any time the ENTER key is pressed, the i/iX Series returns to its normal mode of operation. In this mode, changes made with the shuttle knob or the data entry keypad will take immediate effect. The IMMEDIATE mode is useful for slewing output values such as voltage and frequency and observing the effect on the load.
SET mode	When the SET key located in the FUNCTION keypad is pressed, changes made with the shuttle to any output parameter will not take effect until the ENTER key is pressed. In this mode, any changes made to a setup menu will be blinking to indicate the pending change condition. This mode allows changes to be made to all output parameters and executing them all at once by pressing the ENTER key.

### 4.1.5 FUNCTION Keypad

The function keypad provides access to all menus and measurement screens. The following keys are located in the FUNCTION keypad:

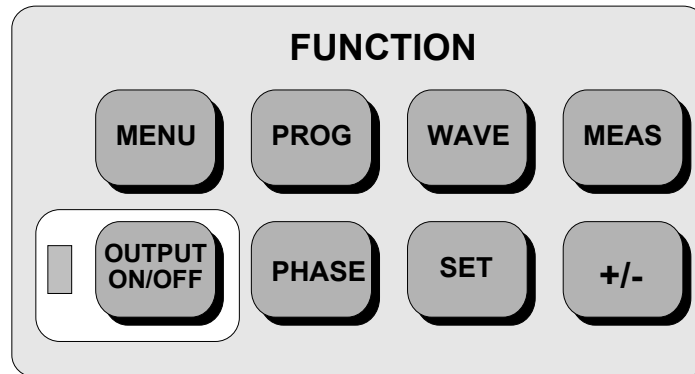

Figure 4-2: FUNCTION keypad

KEY	DESCRIPTION
MENU	The top level menu is accessed by pressing the MENU key. Three shortcut keys are used to provide direct access to the PROGRAM, WAVEFORM, and MEASUREMENT screens as these are among the most frequently used screens. Thus, instead of going through the main menu to reach the PROGRAM, WAVEFORM, and MEASUREMENT screens, they can be accessed directly by pressing the PROG, WAVE, and MEAS keys respectively. A map of the Main menus is provided on the next few pages. There are three top-level menus in the i/iX Series.
PROG	The PROG key is a shortcut to access the PROGRAM menu directly. The PROGRAM menu is one of the most frequently used menus. Thus, instead of going through the main menu to reach the PROGRAM menu, it can be accessed directly by pressing the PROG key.
WAVE	The WAVE key is a shortcut to access the WAVEFORM screen directly. The WAVEFORM screen is used to select a user defined arbitrary waveform. <b>(iX Series only)</b>
MEAS	The MEAS key is a shortcut to access the MEASUREMENT screen directly. The MEASUREMENT screen is one of the most frequently used screens. Thus, instead of going through the main menu to reach the MEASUREMENT screen, it can be accessed directly by pressing the MEAS key. The MEAS key has no function on iM Series models.
OUTPUT ON/OFF	The OUTPUT ON/OFF key toggles the output relay on or off. The state of the output relay is reflected by the green LED located directly to the left of the OUTPUT ON/OFF key. If the green LED is lit, the output relay is enabled (closed) and the programmed output voltage is present at the output terminals. If the green LED is off, the output relay is open and both the HIGH and LO terminal of the output terminal block are disconnected from the power source. In this mode, the output is floating. The ON/OFF button provides a convenient way to disconnect the load without having to remove any wires.
PHASE	The PHASE key is used to select the phase on a three-phase 9003iX or 15003iX unit. Pressing the PHASE key will toggle phase A, B, C or ABC. Some screens may not support the ABC or show all phase information in which case this mode is skipped. <b>(iX Series with three phase controller only)</b>

SET	The SET key is used to select the mode of operation of the shuttle. Refer to section 4.1.1 for details on its operation and the use of the SET key.
+/-	The +/- key can be used to toggle the sign for those parameters for which it is relevant. This is typically the output voltage when in DC mode of operation. For fields that have only two possible values such as the voltage range field, the +/- key can be used to toggle between these two values.

**4.1.6 DECIMAL KEYPAD**

The decimal keypad may be used to enter any numeric parameter required in any of the menu fields. Several fields accept input from either the keypad or the knob. Data entered from the keypad is normally accepted once the ENTER key is pressed unless the front panel mode is in the SET mode. The following keys are available on the decimal keypad:

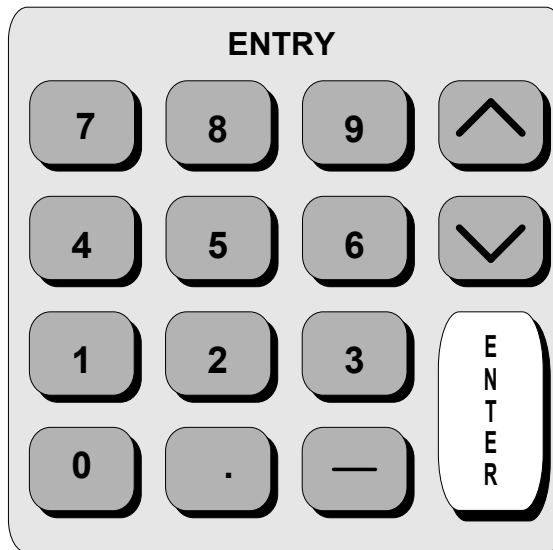

Figure 4-3: Entering value from decimal keypad

**CURSOR UP**

The UP key moves the cursor position upwards one position to the previous available cursor position. If the present cursor position is at the top of the right hand column, the cursor is moved to the bottom position of the left hand column. If the present cursor is at the top of the left hand column, the cursor is moved to the bottom of the right hand column. Figure 4-4 depicts the cursor movement through a two-column menu.

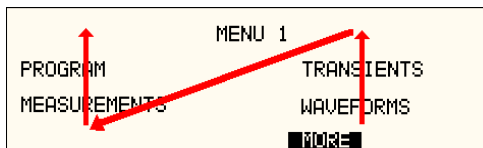
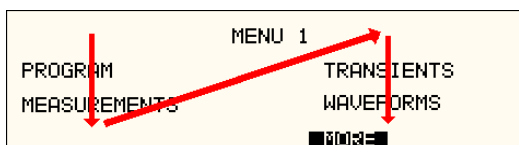

Figure 4-4: Cursor UP key movement

**CURSOR DOWN**

The DOWN key moves the cursor position downwards one position to the next available cursor position. If the present cursor position is at the bottom of the left hand column, the cursor is moved to the top position of the right hand column. If the present cursor is at the bottom of the right hand column, the cursor is moved to the top of the left hand column. Figure 4-5 depicts the cursor movement through a two column menu.



---

*Figure 4-5: Cursor DOWN key movement*

The decimal keypad can be used at any time in lieu of the shuttle knob to change output parameters. Direct data entry is often faster to effect large changes in values than using the shuttle knob. Note that pressing the ENTER key while in SET mode of operation will cause the AC source to revert back to IMMEDIATE mode. Thus, to change all parameters in SET mode, enter a value for each field and then proceed to the next field without pressing the ENTER key.

0 through 9

The numeric keys provide all decimal number for entry of parameters.

DECIMAL POINT

The decimal point key is used to enter fractional parts of values for fields that have a resolution less than 1. The amount of resolution for each menu field is normally visible on the LCD. If more digits are entered after the decimal point than can be accepted by a field, the value is automatically rounded to the available resolution when the ENTER key is pressed.

BACKSPACE

The BACKSPACE (←) key can be used to erase one digit at a time if you make a data entry error.

---

### 4.1.7 LCD Display

---

The LCD display of the i and iX Series AC power source provides information on instrument settings and also guides the user through the various menus. To ease reading of the displayed information, most screens are widely spaced. A sample of the main menu 1 screen that appears when the i Series AC source is powered up is shown in Figure 4-6. Due to the amount of space available on each screen, some menus have been split into parts. The MORE selection located at the bottom right hand side provides access to menu choices at the same level that did not fit on a single screen. Thus, to access MENU 2, the cursor should be placed on the 'MORE' selection followed by pressing the 'ENTER' key. Alternatively, the MENU key may be pressed to move to the MENU 2 screen.

The present cursor position is always shown with a inverse bar. The cursor is located on the 'MORE' selection in Figure 4-6. Pressing ENTER would cause MENU 2 to be displayed.

The cursor position can be moved by using the UP and DOWN keys located in the **DECIMAL** keypad.

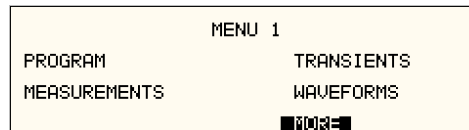

*Figure 4-6: Main Menu 1 screen*

## 4.2 Menu Structure

The next few pages show a map of the available menus in the i/iX Series. There are three main level (level 1) menus from which all other menus can be reached. Frequently used (level 2) menus have a short cut key that provides direct access. Examples of such menus are Program, Measurements, and Waveform. In any case, there are never more than three levels of menus although some menus may be spread across more than one screen.

### 4.2.1 MAIN Menus

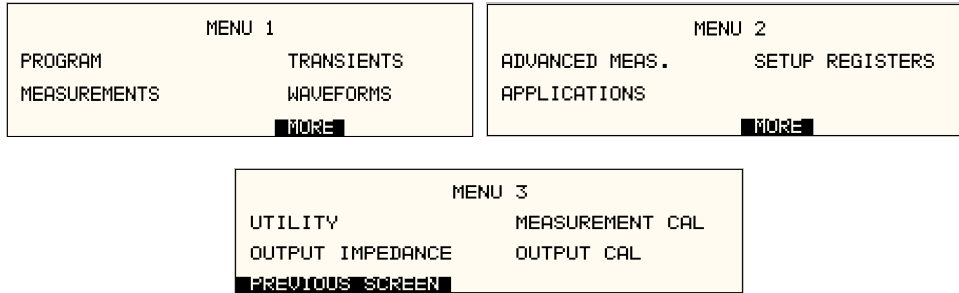

Figure 4-7: Menu 1 through 3

The top-level menu is split in three parts, MENU 1 through MENU 3 to allow spacing between menu entries. MENU 2 and 3 can be reached from MENU 1 by selecting the MORE entry or by pressing the MENU key repeatedly, which will toggle from MENU 1 to 2 to 3 and back to 1. The division of menu choices between the two screens is graphically illustrated in sections 4.2.2 and 4.2.3 by the boxes in level 1. Each box represents one screen. Subsequent screens can be reached using the MORE entry.



The following top-level menu choices can be accessed from the MENU key:

<b>Entry</b>	<b>Description</b>
<b>MENU 1</b>	
PROGRAM	The PROGRAM menu allows output parameters to be changed.
MEASUREMENTS	The MEASUREMENTS screens are not menus in that no user entries are required.
TRANSIENTS	The TRANSIENTS menu allows output transients to be programmed. <b>(i and iX Series only)</b>
WAVEFORMS	The WAVEFORMS menu allows different waveforms to be selected from the waveform library. <b>(iX Series only)</b>
MORE	The MORE selection causes the second part of the MENU screen to be displayed. (MENU 2)
<b>MENU 2</b>	
ADVANCED MEAS.	The ADVANCED MEAS. screens are for display only. No user entries are required. <b>(iX Series only)</b>
APPLICATIONS	The APPLICATIONS menu provides access to the optional firmware application programs that may be installed in the i/iX Series AC source.
SETUP REGISTERS	The SETUP REGISTERS menu allows complete instrument settings and transient list programs to be saved to nonvolatile memory.
MORE	The MORE selection causes the third part of the MENU screen to be displayed. (MENU 3)
<b>MENU 3</b>	
UTILITY	The UTILITY menu provides access to less commonly used setup screens such as those for the GPIB and RS232C (also applies to USB and LAN) interface settings, initial startup values, etc.
OUTPUT IMPEDANCE	The OUTPUT IMPEDANCE menu provides control of the AC source output impedance. (Available only on 3001iX, 5001iX, 9003iX and 15003iX models. On systems with –MODE-iX option, only available when in 3 phase mode.)
MEASUREMENT CAL	The MEASUREMENT CAL menu allows for calibration of the AC source measurement system.
OUTPUT CAL	The OUTPUT CAL menu allows for calibration of the AC source output.

Following the Menu overview pages is a detailed description of each menu and sub menu.

4.2.2 Overview of Menu 1

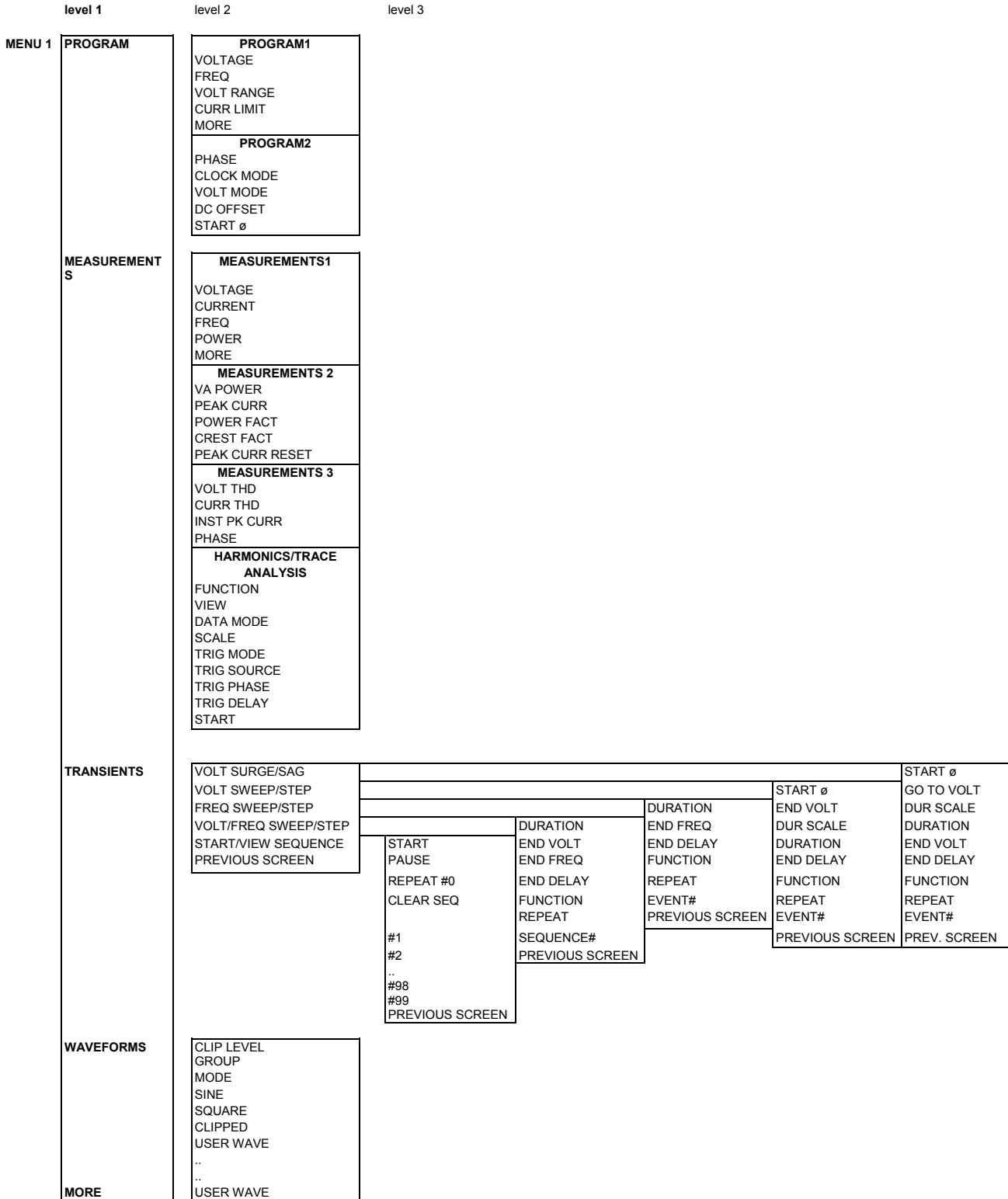

4.2.3 Overview of Menu 2 and 3

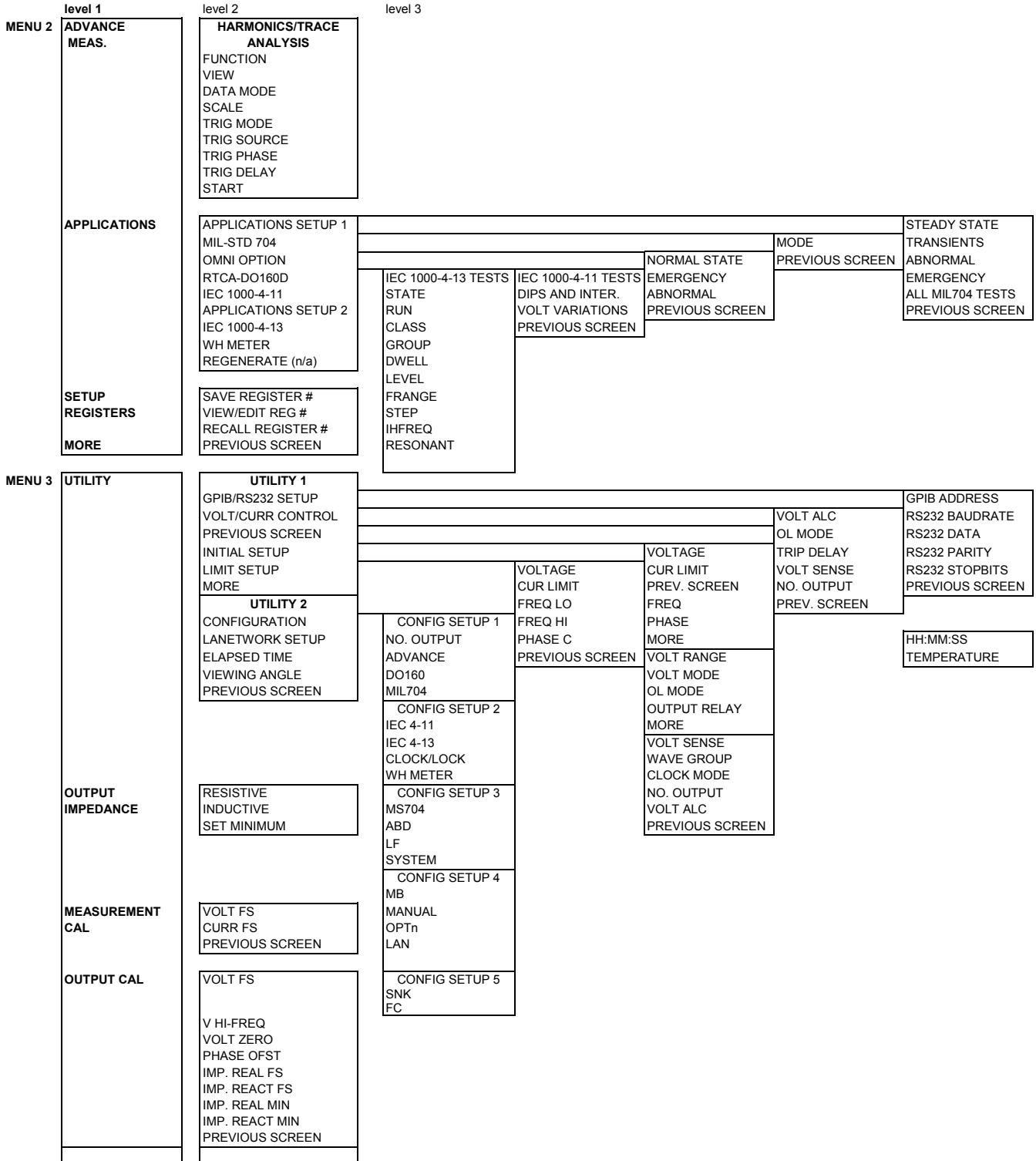

## 4.2.4 PROGRAM Menu

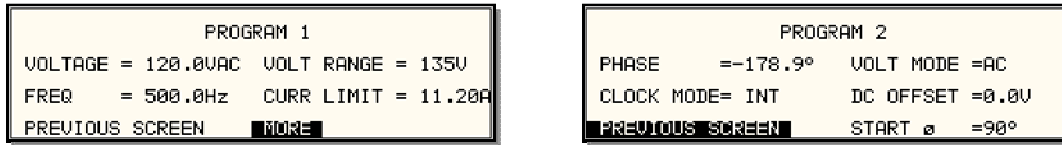

Figure 4-8: PROGRAM Menu

The PROGRAM menu is shown in Figure 4-8. It can be reached in one of two ways:

1. by selecting the PROGRAM entry in the MENU screen and pressing the ENTER key
2. by pressing the PROG key in the FUNCTION keypad

The PROGRAM menu is used to change output parameters. The most commonly used parameters are all located in PROGRAM 1. The PREVIOUS SCREEN entry, when selected, will return the user to the most recently selected menu. This is normally the MENU screen unless the PROGRAM menu was selected using the PROG key on the FUNCTION keypad. Less frequently used parameters are located in PROGRAM 2, which can be reached from the PROGRAM 1 screen using the MORE selection, or by pressing the PROGRAM key twice.

The following choices are available in the PROGRAM menus:

Entry	Description
<b>PROGRAM 1</b>	
VOLTAGE	Programs the output voltage in rms. when in AC mode or absolute voltage when in DC mode. In DC mode, negative values can be entered.
FREQ	Programs the output frequency when in AC mode. If the unit is in DC mode, the value for FREQ will be set to DC and cannot be changed until AC mode is selected. When in AC mode, the frequency can be changed from 16 Hz to 500 Hz. Values entered that fall outside this range will generate a -200 RANGE ERROR and will not be accepted.
VOLT RANGE	Selects 150V or 300V range in AC mode and 200V or 400V range in DC mode. The actual range values may be different depending on the configuration. The value of this field can only be changed with the shuttle or the +/- key. <b>Note</b> that the voltage range is coupled with the output relay state. If the output relay is closed (OUTPUT ON), the voltage range cannot be changed.
CURR LIMIT	Sets the current limit value for the current detection system. When the load current value exceeds the set current limit, a fault condition is generated. The actual response of the AC Source to a current limit fault is determined by the protection mode selected in the CONFIGURATION menu. (CC = Constant Current, CV = Constant Voltage).

**PROGRAM 2**

PHASE	Selects the phase angle between the external clock and the output of the AC source. If the clock source is internal, this parameter has no effect.
CLOCK MODE	Selects internal or external clock source. The i/iX Series uses an open air crystal timebase with an accuracy of 100 ppm. To improve output frequency stability and accuracy, an external clock generator may be used.
VOLT MODE	The iX Series offers three output modes, AC, DC and AC+DC. The VOLT MODE field can be used to toggle between these three output modes. Both the Knob and the +/- key may be used to toggle through these three selections. In DC mode, no frequency selection is possible and all maximum current and power ratings are divided by two. The i/iX Series offers AC or DC modes and the iM Series offers AC only
DC OFFSET	When the AC+DC mode is selected, the VOLTAGE field in the PROGRAM 1 screen is used to set the AC portion of the output voltage. The DC OFFSET field in the PROGRAM 2 screen can be used to set the DC offset level. Either the knob or the decimal keypad may be used to set the DC offset level.
START $\emptyset$	Selects the start phase angle for output changes made to either voltage or frequency. This allows changing the output at a specific phase angle. The output on key also uses this phase angle setting to program the output voltage up to the set level after the output relay is closed. The default value for this field is RANDOM.

**4.2.5 MEASUREMENTS Screens**

The i/iX Series uses a DSP based data acquisition system to provide extensive information regarding the output of the Source. This data acquisition system digitizes the voltage and current waveforms and calculates several parameters from this digitized data. The result of these calculations is displayed in a series of measurement data screens. The actual digitized waveforms can also be displayed by selecting the Harmonics/Trace Analysis screen. A total of four measurement screens are used to display all this information (iX series only). The iM Series offers no measurement functions.

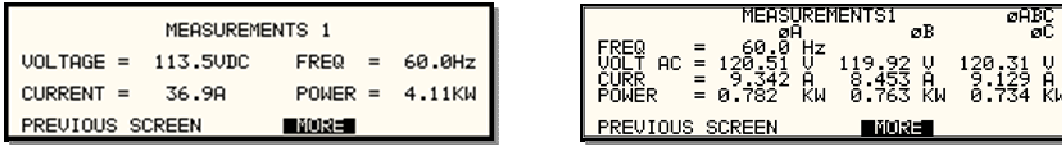

Figure 4-9: MEASUREMENTS Screen, single phase and three phase modes

The first three Measurement screens available on the iX Series are not menus in that no changes can be made anywhere. Instead, these three screens provide load parameter readouts. The fourth measurement screen provides access to the advanced measurements and does offer several user accessible fields (iX Series only). The measurement screens can be reached by successively pressing the MEAS key, which will toggle to all four available screens.

In three-phase configuration iX Series, measurements are available for each phase individually. To select the desired phase, use the PHASE key to toggle through phase A, B, C, or ABC. The ABC mode displays the data for all three phases simultaneously.

The following parameters are available in the first three measurement screens:

<u>Entry</u>	<u>Description</u>
<b>MEASUREMENT 1 [i and iX Series only]</b>	
VOLTAGE	When in AC or AC+DC mode, this value is the true rms output voltage measured at the voltage sense lines. In DC only mode, the voltage is the DC voltage including polarity.
CURRENT	When in AC or AC+DC mode, this value is the true rms output current drawn by the load. In DC only mode, the current is the DC current including polarity.
FREQ	When in AC or AC+DC mode, the output frequency is measured at the sense lines. When in DC only mode, this value always reads "DC".
POWER	In both AC and DC mode, this value is the real rms. power consumed by the load.
<b>MEASUREMENT 2 [i and iX Series only]</b>	
VA POWER	In AC or AC+DC mode, this value is the apparent rms. power consumed by the load. In DC mode, this value is always the same as the POWER readout.
PEAK CURR	This readout reflects the peak current value detected at the output. To measure inrush current for a unit under test, open the output relay and reset the peak current value using the PEAK CURR RESET entry. Then program the output voltage and frequency and turn on the output relay. The peak current measurement will continuously track the maximum current value detected until reset.
POWER FACTOR	This readout shows the power factor of the load.
CREST FACTOR	This readout displays the ratio between peak current and rms current.
<b>MEASUREMENT 3 [iX Series only]</b>	

---

VOLT THD	This readout displays the total voltage distortion for the selected phase. The distortion calculation is based on the H2 through H50 with the fundamental voltage (H1) in the denominator. Note that other common definitions of THD use the RMS value of the voltage as the denominator. This may result in different readings between instruments depending on the implementation chosen. The mode used by the power source is selectable over the bus.
CURR THD	This readout displays the total current distortion for the selected phase. The distortion calculation is based on the H2 through H50 with the fundamental current (H1) in the denominator. Note that other common definitions of THD use the RMS value of the current as the denominator. This may result in different readings between instruments depending on the implementation chosen. The mode used by the power source is selectable over the bus.
INST PK CURR	This readout reflects the instantaneous peak current value detected at the output. This value is updated continuously and does not require a reset operation like the PEAK CURR readout. The instantaneous peak current does not use a track and hold mechanism like the PEAK CURR measurement in the MEASUREMENT 2 screen. Instead, it tracks the peak current on a cycle by cycle basis. The INST PK CURR typically tracks the rms current and the crest factor.

---

### **Update Program Functions from Measurement Screen**

---

The Shuttle can be used to update program parameters such as voltage, frequency or current from the measurement screen. This can be achieved with the following sequence:

1. Select the program 1 screen using the PROG key.
2. Use the up and down key to select the desired function to update. (Selects parameter that will be changed by the shuttle once in the MEAS1 screen)
3. Select the measurement 1 screen by pressing the MEAS key.

The pointer symbol ( ► ) points to the programmed parameter (V,F or CL) that will be affected by turning the shuttle.

HARMONICS/TRACE ANALYSIS Screen **[iX Series only]**

The fourth measurement screen is dedicated to the advanced measurements available on the iX Series only. This screen is not available on the i Series. The Harmonics/Trace Analysis measurement screen is a true menu screen offering several user accessible fields. These fields are used to select the desired acquisition trigger and display mode. The actual data is displayed whenever the ENTER key is pressed while the cursor is on the VIEW or START field. The following fields are available on this menu:

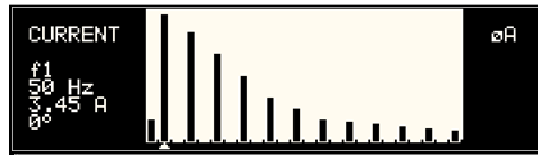

Figure 4-10: HARMONICS/TRACE ANALYSIS screen

Entry	Description
FUNCTION	Selects Voltage, Current or Both parameters for display.
VIEW	Available display modes are TABLE, BAR and TRACE.

TABLE mode: displays the first 50 harmonics in a tabular text format.

BAR mode: displays the first 50 harmonics in a graphical bar chart display.



TRACE mode: displays the selected Function in a time domain (waveform) graphical display.

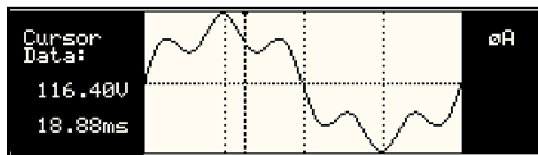

DATA MODE Selects absolute or relative harmonics display for TABLE and BAR view modes. In relative mode, all harmonics are shown in a percentage of the fundamental which is normalized at 100 %. In absolute mode, the harmonic amplitudes are shown in absolute volts or amperes.

This mode does not apply to the TRACE view display mode and is ignored when this mode is selected.

SCALE Sets the horizontal time axis for the TRACE view display mode. The fields range is 4 ms to 42 ms in single-phase mode or 12 ms to 128 ms in three phase mode.



---

	<p>This parameter is ignored when the TABLE or BAR view display mode is selected.</p>
TRIG MODE	<p>This field sets the trigger mode for the acquisition. Available options are SINGLE (single shot acquisition) or CONT (continuous acquisition). In SINGLE shot mode, the acquisition is triggered once each time the START field is selected and the ENTER key is pressed. The selected trigger source is used to determine the trigger point. Once the acquisition has been triggered, the data are displayed and do not change until the next acquisition is triggered. This mode is most appropriate for single shot events such as start up currents.</p> <p>In the CONT mode, acquisitions occur repeatedly and the data is updated on screen after each trigger occurs. This provides a continuous update of the data and is most appropriate for repetitive signals.</p>
TRIG SOURCE	<p>The trigger source selects the event that will trigger a measurement acquisition. Available options for this field are IMM (immediate), PHASE A or SET VOLT. The IMM trigger source causes the acquisition to trigger immediately when the ENTER key is pressed on the START field. Essentially, this is an asynchronous trigger event. The acquisition will always be triggered in this mode and data is available immediately.</p> <p>The PHASE A source will cause the acquisition to trigger on the occurrence of a set phase angle for the voltage on phase A. The trigger source is always phase A when in this mode, regardless of the phase selection shown in the top right corner of the display. When the acquisition is started, the acquisition system waits for the specified phase angle to occur before triggering the acquisition. This mode allows exact positioning of the acquisition data window with respect to the voltage waveform.</p> <p>The SET VOLT mode causes the acquisition to trigger at the specified voltage. This mode also programs the selected phase or all three phases when the measurement is started from the START field. As such, this trigger source selection also programs the output voltage to the selected rms level.</p>
TRIG PHASE / SET VOLT	<p>This field changes purpose, depending on the trigger source selected immediately above it. If the trigger source equals IMM or PHASE A, this field can be used to program the trigger phase angle (TRIG PHASE). In IMM mode, the value of this field is ignored.</p> <p>If the trigger source is set to SET VOLT, this field can be used to specify the rms voltage to program the output to and trigger the measurement on. The voltage value set here should not exceed the maximum voltage range selected or the rms capability for the waveshape selected on the phase or phases programmed.</p>
TRIG DELAY	<p>The trigger delay field allows the trigger point to be positioned anywhere in the acquisition window. A negative value will provide pre-trigger information on data leading up to the trigger event. The pre-trigger delay cannot exceed the length of the acquisition buffer See paragraph 4.6.3.3 for details. A positive trigger delay positions the data window after the trigger event. Positive trigger delays can exceed the length of the acquisition buffer in which case the trigger event itself will not be in the buffer any more. The maximum value of the trigger delay is 1000 ms. The default trigger delay value is 0.0 ms which puts the trigger event at the beginning of the acquisition window.</p>
START	<p>The START field is used to start a new acquisition run. To start an acquisition, place the cursor on the START field and press the ENTER key. Once the ENTER key is pressed, the display toggles to the data display mode selected in the VIEW field as soon as the selected trigger event occurs. To return to the HARMONICS/TRACE ANALYSIS menu, press the ENTER key while in the data display mode.</p>

To change display modes without triggering a new acquisition, make the desired changes in the menu and move the cursor to the VIEW field. Once on the VIEW field, press the ENTER key. This will not trigger a new acquisition, which means the original data is retained.

4.2.6 TRANSIENTS Menu



Figure 4-11: TRANSIENTS menu

The transient menu provides access to the transient list data. The iM Series does not support transient programming. Both the i and the iX Series II have a transient list of up to 100 data points. This is represented by 100 transient step numbers from 0 through 99. From the Transient menu, the desired transient step type can be selected. Based on the user's choice, the relevant transient type sub menu will be shown. The START/EDIT SEQUENCE sub menu allows the user to review and change any transient step or execute the transient list. When executing a transient list, transient steps are executed in a ascending numerical order. Steps that are not defined are skipped.

The following entries can be found in the TRANSIENTS menu:

Entry	Description
VOLT SURGE/SAG	Voltage surges and sags are temporary changes in amplitude. The output voltage will change from its present value to a user specified value for a specified duration. (Sag if the value is lower, surge if the value is higher.) After this period has expired, the output voltage returns to a user specified end value. This value may or may not be the same as the value present prior to the start of the sag or surge.
VOLT SWEEP/STEP	Voltage sweeps cause the output voltage to change from the present value to a user specified end value at a specified rate of change. A voltage step on the other hand is an instantaneous change in output voltage. The new value will be held for the duration period specified by the user. The final output voltage value of a sweep and a step transient step should be different than the value at the start of the transient step or no change in output value will occur.
FREQ SWEEP/STEP	This transient type is similar to a voltage sweep/step except it affects the frequency. Refer to the previous paragraph.
VOLT/FREQ SWEEP/STEP	This transient type combines the previous two types into a single step. The effect is that of changing the output voltage and frequency simultaneously.  Note: While this transient is programmed as a single transient step, two list entries are required to store this information. As such, every VOLT/FREQ SWEEP/STEP used will consume two list entries at a time.
START/VIEW SEQUENCE	This entry allows the user to switch to the transient execution menu. This menu provides a list of all available transient list steps and their sequence numbers. From this menu, transient list execution can be started.  The same menu can be used to view or edit any available transient list step or erase a step using the backspace key.

4.2.6.1 VOLT SURGE/SAG sub menu

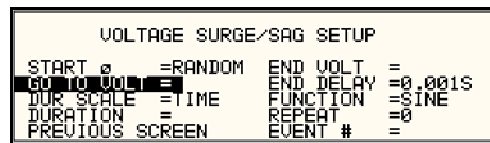

Figure 4-12: VOLTAGE SURGE/SAG SETUP screen

The Voltage surge and sag screen shown in Figure 4-12 can be reached from the transient screen as follows:

1. Scroll to the VOLT SURGE/SAG entry using the up and down cursor keys.
2. Press the ENTER key to bring up the VOLT SURGE/SAG screen.

The VOLT SURGE/SAG screen has several data fields. All data fields that are blank to the right of the equal sign must be filled or an error message will occur when trying to leave this screen. The EVENT # is the last data field to be filled. Entering the event data field will cause the display to return to the TRANSIENT screen where a new selection can be made.

The VOLT/SURGE/SAG screen has the following fields:

START $\emptyset$	This field will show the start phase angle of the voltage transient in degrees. Only one start phase angle per transient sequence is allowed. The start phase angle must be in the first transient event in the list. The start phase angle is not valid for DC transients. If no start phase angle is required, this field can be set to RANDOM by pressing the BACKSPACE (<-) key on the decimal keypad.
GO TO VOLT	This field will set the voltage level during the transient duration in volts
DUR SCALE	Duration scale default is time in seconds. Use the Shuttle knob to select CYCLES if desired. Note that durations expressed in cycles may cause rounding errors if the period of the selected frequency setting is not an integer number of mss. Thus, for 50 Hz applications, no rounding errors occur but for 60 Hz, the 16.6 $\bar{6}$ ms period will cause a rounding error when converted. The Duration scale selection affects both the DURATION and END DELAY parameters.
DURATION	Duration is the time the output voltage level will dwell at the GO TO VOLT level. The DUR SCALE defines the time scale of this parameter in CYCLES or SECONDS
END VOLT	This is the output voltage level at the end of the transient EVENT and after a time specified by the DURATION
END DELAY	This is the time delay the voltage level will stay at the END VOLT level before it proceeds with the next transient event or completes the transient.
FUNCTION	[iX Series only] This field can be used to select the waveshape to be used during this step of the transient sequence. Each step can use a different waveshape from the available library of 50 user defined waveforms or the three standard waveforms. The output waveshape changes upon entry into each step and remains in effect for the duration of the step. The default waveshape is always the SINE (sinewave).
REPEAT	This is the number of times the SURGE/SAG transient event will repeat before it will proceed to the next event or exit the transient program. Note that the number of times the transient event is generated is equal to the REPEAT + 1. Leave this value at zero if only one execution of this event in the list is required.
EVENT #	This must be the last item in the transient edit screen. All data fields must be entered before inserting the EVENT #. The EVENT # takes a value from 1 to 99. The EVENT # defines the order of execution of the transient events in a multiple event transient. It is a good practice to enter spaced EVENT #'s to allow insertion of an EVENT later if needed. (For example, space them by 5.) Entry of a sequence EVENT # number will cause the display to return to the TRANSIENT screen.

#### 4.2.6.2 VOLTAGE SWEEP/STEP sub menu



Figure 4-13: VOLTAGE SWEEP/STEP SETUP screen

The Voltage sweep and step screen shown in Figure 4-13 can be reached from the transient screen as follows:

1. Scroll to the VOLT SWEEP/STEP entry using the up and down keys.
2. Press the ENTER key to bring up the VOLTAGE SWEEP/STEP screen.

The VOLTAGE SWEEP/STEP screen has several data fields. All data fields that are blank to the right of the equal sign must be filled or an error message will occur when trying to leave this screen. The EVENT # is the last data field to be filled. Entering the event data field will cause the display to return to the TRANSIENT screen where a new selection can be made.

The VOLTAGE SWEEP/STEP screen has the following fields:

START	This field will show the start phase angle of the voltage transient in degrees. Only one start phase angle per transient sequence is allowed. The start phase angle must be in the first transient event in the list. The start phase angle is not valid for DC transient.
END VOLT	This is the output voltage level at the end of the transient event in volts.
DUR SCALE	Duration scale default is time in seconds. Use the Shuttle knob to select CYCLES if desired. Note that durations expressed in cycles may cause rounding errors if the period of the selected frequency setting is not an integer number of mss. Thus, for 50 Hz applications, no rounding errors occur but for 60 Hz, the 16.6 $\bar{6}$ ms period will cause a rounding error when converted. The Duration scale selection affects both the DURATION and END DELAY parameters.
DURATION	Duration is the time it will take for the output voltage to reach the END VOLT level. As such, "Duration" will define the slew rate of the output voltage for the event. A duration of 0 seconds will cause the output voltage to reach the end voltage immediately. The DUR SCALE defines the time parameter CYCLES or SECONDS
END DELAY	This is the time delay the voltage level will stay at END VOLT before it proceeds with the next transient event or completes the transient.
FUNCTION	[iX Series only] This field can be used to select the wave shape to be used during this step of the transient sequence. Each step can use a different wave shape from the available library of 50 user-defined waveforms or the three standard waveforms. The output wave shape changes upon entry into each step and remains in effect for the duration of the step. The default wave shape is always the SINE (sine wave).
REPEAT	This is the number of times the VOLTAGE SWEEP/STEP transient event will repeat before it will proceed to the next event or exit the transient program. Note that the number of times the transient event is generated is equal to the REPEAT + 1. Leave this value at zero if only one execution of this event in the list is required.

---

**EVENT #**

This must be the last item in the transient edit screen. All data fields must be entered before inserting the EVENT #. The EVENT # takes a value from 1 to 99. The EVENT # defines the order of execution of the transient events in a multiple event transient. It is a good practice to enter spaced EVENT #'s to allow insertion of an EVENT later if needed. (For example, space them by 5.) Entry of a sequence EVENT # number will cause the display to return to the TRANSIENT screen.

### 4.2.6.3 FREQUENCY SWEEP/STEP sub menu



Figure 4-14: FREQUENCY SWEEP/STEP SETUP screen

The Voltage sweep and step screen shown in Figure 4-14 can be reached from the transient screen as follows:

1. Scroll to the FREQ SWEEP/STEP entry using the up and down cursor keys.
2. Press the ENTER key to bring up the FREQ SWEEP/STEP screen.

The FREQ SWEEP/STEP screen has several data fields. All data fields that are blank to the right of the equal sign must be filled or an error message will occur when trying to leave this screen. The EVENT # is the last data field to be filled. Entering the event data field will cause the display to return to the TRANSIENT screen where a new selection can be made.

The FREQ SWEEP/STEP screen has the following fields:

DURATION	Duration is amount of the time the output frequency will take to reach the END FREQ level. Duration will define the slew rate of the output frequency for the event. A duration of 0 seconds will cause the output frequency to reach the end frequency immediately.
END FREQ	This is the output frequency at the end of the transient event in Hz.
END DELAY	This is the time delay the frequency will stay at END FREQ before it proceeds with the next transient event or completes the transient.
FUNCTION	[iX Series only] This field can be used to select the waveshape to be used during this step of the transient sequence. Each step can use a different waveshape from the available library of 50 user defined waveforms or the three standard waveforms. The output waveshape changes upon entry into each step and remains in effect for the duration of the step. The default waveshape is always the SINE (sinewave).
REPEAT	This is the number of times the FREQUENCY SWEEP/STEP transient will repeat before it will proceed to the next event or exit the transient. The number of times the transient event is generated is equal to the REPEAT + 1. Leave this value at zero if only one execution of this event in the list is required.
EVENT #	This must be the last item in the transient edit screen. All data fields must be entered before inserting the EVENT #. The EVENT # takes value from 1 to 99. The EVENT # defines the order of execution of the transient events in a multiple event transient. It is a good practice to enter spaced EVENT #'s to allow insertion of an EVENT later if needed. (For example, space them by 5.) Entry of a sequence EVENT # number will cause the display to return to the TRANSIENT screen.

#### 4.2.6.4 VOLTAGE/FREQUENCY SWEEP/STEP sub menu

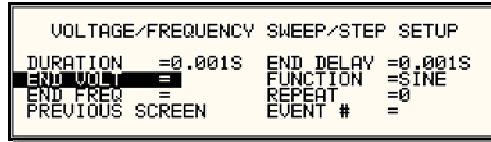

Figure 4-15: VOLTAGE/FREQUENCY SWEEP/STEP SETUP screen

The Volt/freq sweep/step screen shown in Figure 4-15 can be reached from the transient screen as follows:

1. Scroll to the VOLT/FREQ SWEEP/STEP entry using the up and down cursor keys.
2. Press the ENTER key to bring up the VOLT/FREQ SWEEP/STEP screen.

The VOLT/FREQ SWEEP/STEP screen has several data fields. All data fields that are blank to the right of the equal sign must be filled or an error message will occur when trying to leave this screen. The EVENT # is the last data field to be filled. Entering the event data field will cause the display to return to the TRANSIENT screen where a new selection can be made.

The VOLT/FREQ SWEEP/STEP screen has the following fields:

DURATION	Duration is the amount of time the output voltage and frequency will take to reach the END FREQ and END VOLT levels. Duration will define the slew rate of the output voltage and frequency for the event. A duration of 0 seconds will cause the output voltage and frequency to reach their end value immediately.
END FREQ	This is the output frequency at the end of the transient event in Hz.
END VOLT	This is the output voltage at the end of the transient event in volts.
END DELAY	This is the time delay the output frequency and voltage will stay at END FREQ and END VOLT before proceeding with the next transient event or completing the transient.
FUNCTION	[iX Series only] This field can be used to select the wave shape to be used during this step of the transient sequence. Each step can use a different wave shape from the available library of 50 user defined waveforms or the three standard waveforms. The output wave shape changes upon entry into each step and remains in effect for the duration of the step. The default wave shape is always the SINE (sine wave).
REPEAT	This is the number of times the VOLTAGE/FREQUENCY SWEEP/STEP transient will repeat before it will proceed to the next event or exit the transient. The number of times the transient event is generated is equal to the REPEAT + 1. Leave this value at zero if only one execution of this event in the list is required.
EVENT #	This must be the last item in the transient edit screen. All data fields must be entered before inserting the EVENT #. The EVENT # takes value from 1 to 99. The EVENT # defines the order of execution of the transient events in a multiple event transient. It is a good practice to enter spaced EVENT #'s to allow insertion of an EVENT later if needed. (For example, space them by 5.) Entry of a sequence EVENT # number will cause the display to return to the TRANSIENT screen.

#### 4.2.6.5 START/VIEW TRANSIENT SEQUENCE sub menu

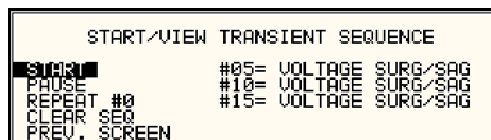

Figure 4-16: START/VIEW TRANSIENT SEQUENCE screen



The START/VIEW TRANSIENT SEQUENCE screen is used to control transient execution. It also provides an overview of available transient list events. This list appears in the order they were assigned event numbers. Editing an existing event can be accomplished from this screen by positioning the cursor on the event to be edited and pressing the ENTER key. This method can also be used to review the parameters of a previously entered event.

The START/VIEW TRANSIENT SEQUENCE screen has the following fields:

START / ABORT	The START field is used to start a transient execution. When the cursor is positioned on the START field and the ENTER key is pressed, transient execution starts. The output relay must be closed or an error message will appear and the transient will not start.  Once a transient is in progress, this field changes to ABORT and can be used to abort a transient in progress. If the transient completes execution, the field reverts back to START.
PAUSE / RESUME	The PAUSE field may be used to suspend execution of a transient list in progress. If the cursor is on the PAUSE field and the ENTER key is pressed, the transient is suspended and this field changes to RESUME. Pressing the ENTER key again will cause the transient list to resume execution from the point where it was suspended.
REPEAT #	This field determines the number of times a transient list is repeated. The default value is zero, which means the programmed list runs only once. The range for this field is from 0 through 99999. This repeat function should not be confused with the REPEAT function available for individual events. The event specific repeat value will cause only that event to be repeated, not the entire list.
CLEAR SEQ	Moving the cursor to this field and pressing the ENTER key will cause the entire programmed transient list to be erased. Be careful not to press ENTER accidentally while on this field as you will lose the programmed transient list. Note that a list may be stored as part of the front panel setup in the nonvolatile memory registers.

#### 4.2.7 WAVEFORMS Menu [iX Series only]



Figure 4-17: WAVEFORMS menu

The WAVEFORMS menu is available on the iX Series only. If your unit is an i Series, pressing the WAVE key on the front panel function keypad has no effect. The WAVEFORMS menu allows selection of the wave shape for each phase individually or all phases at once. For three phase versions of the iX Series, the mode is determined by the phase coupling. If only a single phase is selected in the top right corner of the display (øA, øB or øC), the selected wave shape will be applied to that phase. If all phases are selected (phase coupling), the selected waveform will apply to all three phases.

For single-phase versions of the iX Series, the phase coupling is always set to phase A, so pressing the PHASE button has no effect.

The following fields are available in the WAVEFORMS menu:

CLIP LEVEL	This parameter determines the amount of total harmonic distortion of the built-in CLIPPED sine wave waveform. The range is 0 % through 20 % THD.  Note that changing the distortion level of the CLIPPED sine wave while the CLIPPED sinewave is used on the output of one or more phases, forces the output of the AC Source to be dropped momentarily. To avoid this, make sure none of the phases is using the CLIPPED sinewave function when changing the clip level.
------------	---------------------------------------------------------------------------------------------------------------------------------------------------------------------------------------------------------------------------------------------------------------------------------------------------------------------------------------------------------------------------------------------------------------------------------------------------------------------------------

**GROUP** The group field displays the currently selected waveform group. The iX Series provides four groups of 50 user defined waveforms each for a total of 200 waveforms. Only one group can be active at a time however. This field only displays the selected waveform group. It cannot be used to change the actual group selected. Group selection must occur at power up and is done from the INITIAL SETUP 3 screen. See section 4.2.11.3 for details.

**MODE** The mode field determines the operation mode of the WAVEFORMS display screen. Available options for this field are:

**PROG:** This mode is used to change the programmed wave shape function on the selected phase. This is also the default mode of operation.

**VIEW(T):** This mode can be used to display any of the available user defined waveforms in a time domain display. Previewing a waveform can be useful if you are unsure about the nature of the waveform that was stored.

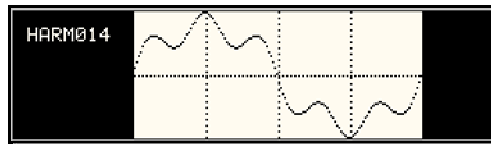

**VIEW(F):** This mode can be used to display any of the available user defined waveforms in a frequency domain display. Waveform data is shown by harmonic amplitude and phase relative to the fundamental frequency. Previewing a waveform can be useful if you are unsure about the nature of the waveform that was stored.

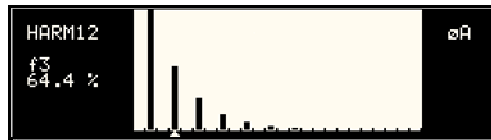

**SINE** The SINE is a standard waveform that is always available. It does not consume any of the user defined waveform registers and is always displayed in the waveform list. A right arrow indicates the waveform is presently selected for the phase. If the cursor is moved to this field, the ENTER key will execute the selected MODE. If the mode is set to PROG, pressing ENTER while the cursor is on the SINE entry will select the sine wave for the phase shown in the top right corner of the display.

Note that the VIEW modes are not available for any of the three standard waveforms.

**SQUARE** The SQUARE is a standard waveform that is always available. It does not consume any of the user defined waveform registers and is always displayed in the waveform list. A right arrow indicates the waveform is presently selected for the phase. If the cursor is moved to this field, the ENTER key will execute the selected MODE. If the mode is set to PROG, pressing ENTER while the cursor is on the SQUARE entry will select the square wave for the phase shown in the top right corner of the display.

Note that the VIEW modes are not available for any of the three standard waveforms.

---

**CLIPPED**

The CLIPPED is a standard waveform that is always available. It does not consume any of the user defined waveform registers and is always displayed in the waveform list. A right arrow indicates the waveform is presently selected for the phase. If the cursor is moved to this field, the ENTER key will execute the selected MODE. If the mode is set to PROG, pressing ENTER while the cursor is on the CLIPPED entry will select the clipped sine wave for the phase shown in the top right corner of the display. The amount of clipping is determined by the CLIP LEVEL field.

Note that the VIEW modes are not available for any of the three standard waveforms.

**USER DEFINED**

A list of user defined waveforms appears immediately below the three standard waveforms. If no user-defined waveforms were downloaded to the iX Series AC source, this list will be blank. User defined waveforms can be given a symbolic name of up to twelve characters. The use of any of the three standard waveform names (SINE, SQUARE and CLIPPED) should be avoided, as it will be rejected by the iX controller.

A right arrow indicates the waveform is presently selected for the phase. If the cursor is moved to this field, the ENTER key will execute the selected MODE. If the mode is set to PROG, pressing ENTER while the cursor is on the user defined entry will select the custom waveform for the phase shown in the top right corner of the display.

If the MODE is set to either VIEW option, the waveform data under the cursor will be displayed when the ENTER key is pressed. Press the ENTER key again to return to the WAVEFORMS menu.

## 4.2.8 ADVANCE MEAS. Menu [iX Series only]

This entry in the MENU 2 screen displays the HARMONICS/TRACE ANALYSIS screen which is covered in section 0. This field can be used in lieu of the MEAS key to directly bring up the advanced measurements screens.

## 4.2.9 APPLICATIONS Menu



Figure 4-18: APPLICATIONS menu

The APPLICATIONS menu provides access to the optional application specific pre-programmed test sequences. Since these test sequences are optional, this menu may have no choices if none of the options are installed. The following entries may be found in the APPLICATIONS menu:

Entry	Description
MIL-STD 704	Test sequence for MIL standard 704 AC and DC tests.
OMNI OPTION	This entry selects the OMNI control menu. The OMNI option provides a lumped reference impedance for use in IEC 1000-3-3 Flicker test applications. The iX Series also provides programmable impedance, so, in most cases, the OMNI option is not required. For the i Series, the OMNI impedance is available as an option. If the OMNI option is installed, this screen allows the impedance to be ENGAGED or BYPASSED.
RTCA/DO-160	Test sequence for RTCA DO160 commercial aviation AC and DC tests.
IEC-1000-4-11	Test sequences for IEC 1000-4-11 Voltage Dips and Variations test standard.
IEC-1000-4-13	Test sequence for IEC 1000-4-13 Harmonics and Inter harmonics test standard.
WH METER	Watt Hour meter measurement option. Tracks energy usage over a period of time and calculates Watt Hours used.

#### 4.2.10 SETUP REGISTERS Menu



Figure 4-19: SETUP REGISTERS menu

The SETUP REGISTERS menu allows the user to store and recall complete instrument setups, including transient program lists. A total of 16 non-volatile setup registers is available, numbered sequentially from 0 through 15.

The following entries can be found in the SETUP REGISTERS menu:

<b>Entry</b>	<b>Description</b>
SAVE REGISTER	Save present instrument setup to a register number selected by the user. The numeric data entry keypad should be used to enter a number between 0 and 15. Once the ENTER key is pressed, all settings are saved. A message will appear at the bottom of the screen to confirm the save operation.
RECALL REGISTER	Recall instrument setup from a register number selected by the user. The numeric data entry keypad should be used to enter a number between 0 and 15. Once the ENTER key is pressed, all settings are recalled. A message will appear at the bottom of the screen to confirm the recall operation.
VIEW/EDIT REGISTER	The View/Edit entry can be used to display the contents of a setup register before it is recalled. After the user enters a register number to view or edit and presses the ENTER key, the PROGRAM screen will appear. All parameters that will be changed by recalling the register will be blinking. If ENTER is pressed again, the register will be recalled and the new values take effect. To edit the register content, change all parameters that need to be changed. Pressing ENTER will save the new values and make them active.

## 4.2.11 UTILITY Menus

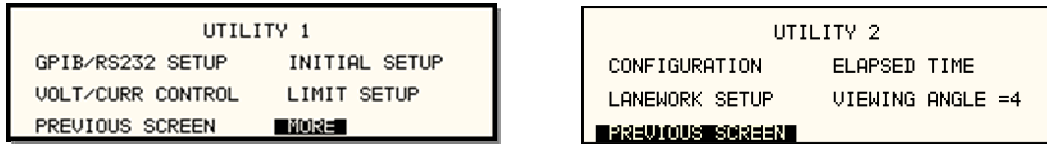

Figure 4-20: UTILITY menus

The UTILITY menus provide access to less frequently used setup items. There is no connection between the various entries in the UTILITY menu other than there is no other logical place to put them. The following entries can be found in the UTILITY menu:

Entry	Description
<b>UTILITY 1</b>	
GPIB/RS232 SETUP	This entry provides access to the setup parameters for either the IEEE-488, RS232C, USB or LAN interface. All parameters are saved in non-volatile memory so there is rarely a need to change these values.
VOLT/CURR CONTROL	<p>The voltage and current control menu can be used to select the voltage range pair, the current limit method, the voltage sense source, and the number of output phases (only in three phase systems with Mode-iX option).</p> <p>The standard available voltage range pairs are 150 Vac and 300 Vac in AC mode or 200 Vdc and 400 Vdc in DC mode.</p> <p>The two current limit choices are Constant Voltage and Constant Current. Constant Voltage mode will maintain the set voltage at the output until the load current exceeds the current limit setting at which time the voltage will be dropped to zero. This effectively shuts off the AC source output in case of an overload condition. This mode has user programmable trip delay which is located in the same menu.</p> <p>Constant Current mode will maintain the load current at the maximum level set by the current limit value, even if the maximum power level is exceeded. This is done by reducing the voltage as needed. As such, the voltage will be reduced from the set level down to zero depending on the load requirement. This mode is useful for starting up motor or capacitor loads that may require a high inrush current. This mode also has a user programmable trip delay.</p> <p>Voltage sensing for regulation and measurement can be selected for internal or external. External voltage sensing can compensate for voltage drops caused by load cable impedance. To achieve the best output regulation select external sense and connect the voltage sense wires at the load.</p> <p>The number of outputs in a multibox system with the Mode-iX option can be switched between one for 15000 VA single phase, and three for 5000 VA per phase, three phase. If the Mode-iX option is not installed, the number of outputs is fixed.</p>
INITIAL SETUP	The initial setup menu can be used to determine the AC source settings at power up. CAUTION: The initial setup can be used to power up the AC source with the output on and a high voltage present at the output. For normal situations, this is not recommended due to the potential danger to operators. It is recommended that the initial voltage be set low and/or the output relay be programmed to OFF for most situations.

LIMIT SETUP

The Limit menu shows the frequency, voltage and current limit capabilities of the AC source. Any attempt to program the output beyond these limits will result in a “-222 Data Out of Range error”. Note that these limits are hardware determined and cannot be changed by the user. They are shown for reference only.

**UTILITY 2**

CONFIGURATION

The Configuration menu shows the installed options. This screen is for reference only and no fields can be changed by the user.

LANNETWORK SETUP

Displays or sets LAN interface settings. If the LAN option is present, this screen may be used to view or change LAN parameters. The MAC address is fixed and cannot be changed. IP and Gateway addresses are normally assigned by the network DHCP server. Changes to the other fields can be made by pressing the SET button first. The indicator in the top right hand of the screen will change from “NC” to “SET”. Note that any setting changes made won’t take effect till after the unit has been powered down and back up.

To set the LAN interface to AUTO IP mode, set the IP and Gateway address to all zeros. This will cause the IP to be requested from the network the next time power is cycled. To manually set the IP and Gateway address, enter the address from the keypad.

The Port address is normally set to 5025. The number of host bits is a function of the network address range.

```

LANetwork Setup          NC
MAC Address =00:00:00:00:00:00
IP Address   =69.35.221.81
GWAddress   =27.205.119.223
PORT Address =5025      HostBits =24
PREVIOUS SCREEN
    
```

To reset the LAN to its default configuration, select the MAC Address and press the SET key followed by ENTER key. Confirm with the ENTER key.

```

LANDefault? Yes = ENTER NO = BackSpace
LANetwork Setup          Set
MAC Address = 00:20:4A:36:A4:47
IP Address   =10.11.26.163
GWAddress   =10.11.0.1
PORT Address =5025      HostBits = 16
PREVIOUS SCREEN
    
```

---

**ELAPSED TIME**

The elapsed time screen, when selected from the UTILITY menu, will appear for about 3 seconds. The elapsed time shown is the cumulative amount of time the power source has been on from its initial build. This value is read only and cannot be changed by the user.

The same screen also displays the internal AC source ambient temperature in degrees C.

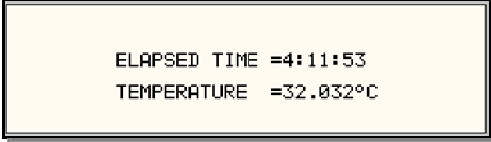

```
ELAPSED TIME =4:11:53
TEMPERATURE  =32.032°C
```

**VIEWING ANGLE**

The viewing angle can be used to change the contrast ratio of the LCD display. The range of the viewing angle parameter is from -10 to +10. Setting the right viewing angle is matter of personal taste. Set this parameter to a value that is most comfortable for the user.



#### 4.2.11.1 GPIB/RS232 (incl. USB/LAN) SETUP menu

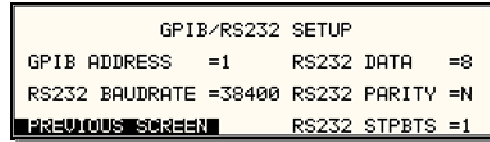

Figure 4-21: GPIB/RS232 SETUP menu

The GPIB/RS232 SETUP menu may be used to change the interface parameter settings for both the IEEE-488 interface and the RS232, USB or LAN serial interface. The number of interfaces available will depend on the specific model and options as well as the time of manufacture. Older i/iX models do not offer USB or LAN interfaces. Newer models can be equipped with as many as 4 different interfaces although only one can be used at the same time.

Refer to the iX Series Programming Manual P/N 7000-982 distributed in Adobe PDF format on the same CD ROM as this user manual for more details on using the RS232, USB or LAN interface.

The following parameters can be set from this menu:

GPIB ADDRESS	Sets the IEEE-488 address used by the AC source. The address value can be set from 0 through 31. Address 0 is often reserved for the IEEE-488 controller. The factory setting is address 1. Once changed, the IEEE-488 address is retained in nonvolatile memory.
RS232 BAUDRATE	This field can be used to set the RS232 baud rate to either 9600, 19,200, 38,400, 57600 or 115,200 baud. The baud rate set on the AC source must match the one programmed for the communications port of the controller. Baud rates higher than 115200 are provided for the USB and LAN interface modes only. The same setting is used for USB and LAN modes. For use with either USB or LAN, the baud rate in this screen must be set to <b>460800</b> . See UTILITY 2 screen for other LAN setup parameters.
RS232 DATA	This field is used to set the number of data bits to either 7 or 8. Factory setting is 8 bits. This value must match the number of data bits set on the communications port of the controller.
RS232 PARITY	This field is used to set the parity. Available options are Even (E), Odd (O) or no parity (N). Factory setting is No parity. This value must match the parity set on the communications port of the controller. For USB or LAN use, always use factory settings.
RS232 STPBITS	This field is used to set the number of stop bits used on the serial port. Available options are 1 or 2 bits. Factory setting is 1 stop bit. This value must match the parity set on the communications port of the controller. For USB or LAN use, always use factory settings.

The number of start bits is always fixed to 1 bit.

#### 4.2.11.2 VOLTAGE/CURRENT CONTROL SETUP menu

```

VOLTAGE/CURRENT CONTROL SETUP
ALC MODE =ON      TRIP DELAY =0.10S
OL MODE  =CC      VOLT SENSE =INT
PREVIOUS SCREEN NO. OUTPUT =THREE

```

Figure 4-22: VOLTAGE/CURRENT CONTROL SETUP menu

The VOLTAGE/CURRENT CONTROL SETUP menu may be used to set output voltage and current control parameters. These parameters are not frequently changed in the normal operation of the AC source and are thus located on the UTILITY rather than the PROGRAM menu.

The following options are available in this menu:

**ALC MODE** Automatic Level Control of programmed output voltage. This mode will use the internal voltage measurements to adjust the output voltage continuously as needed. This effectively increases the output accuracy and regulation beyond what is possible with ALC off.

There are three settings for the ALC mode, ON, REG and OFF. **ON:** If ALC is ON, any event or load condition that prevents the power source from regulating the programmed voltage will cause it to trip the output off and generate a -801, "Output Voltage Fault". There may be situations where it is desirable to continue driving the load even if the programmed voltage cannot be maintained.

**REG:** In the REG (Regulate) mode ALC will regulate the output but not trip the output if for some reason it can't.

**OFF:** If the ALC is set OFF, no additional regulation is performed by the controller other than the hardware control loop.

Note that if the current limit mode is set to CC (Constant Current) and the ALC is ON, the output will not trip off if the load current is at the programmed current limit forcing the unit into the cc operating mode which requires the voltage to be reduced from the set value.

---

**Note: The Automatic Voltage Level Control (ALC) mode is mutually exclusive with the Programmable Impedance function of the iX. One must be turned off the enable the other.**

---

**OL MODE** This field is used to select constant current (CC) or constant voltage (CV) mode. The constant current mode will limit the maximum amount of current drawn by the load to the set value. The voltage will be reduced as needed after the trip delay time to maintain the level of programmed current.

The constant voltage mode will maintain the set voltage as long as the current drawn by the load does not exceed the current limit programmed. If the current limit is exceeded, the output will be shut off after the trip delay time.

**TRIP DELAY** The trip delay field may be used to set the amount of time to hold off the current limit trip point. The minimum amount of time is 100 ms or 0.1 sec. The maximum amount of time is 5.00 sec.

**VOLT SENSE** This field selects the internal or external sense line inputs. Internal sense does not require the external sense lines to be connected as sensing occurs at the output relay of the AC source. For best results, connect the external sense lines and select the EXT sense mode in this field. This will compensate for voltage drop in the cables to the load. The measurements are also taken at the sense points, so the external sense mode should be used for best measurement results.

**NO. OUTPUT** This field is only accessible if the phase mode option is installed. It allows the number of output phases to be toggled between single and three-phase mode. In single-phase mode, all power is available on phase A. The Mode-iX option is available to route all power to a single output terminal pair.

4.2.11.3 INITIAL SETUP menu

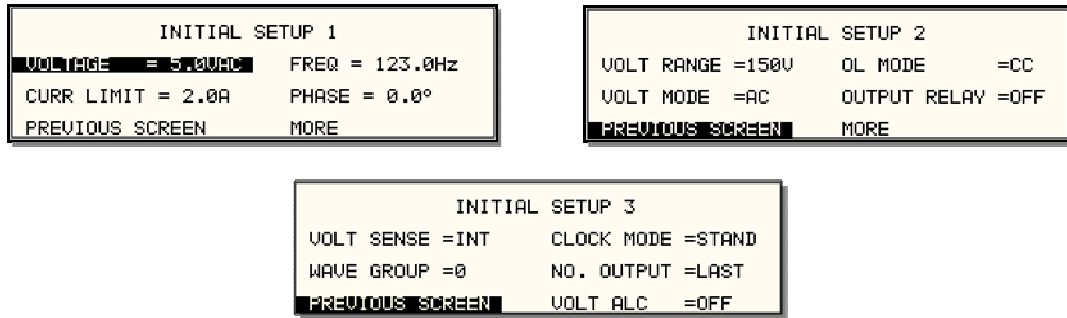

Figure 4-23: INITIAL SETUP menus

Any time the AC source is powered up, the output will reflect the values stored as the INITIAL setup values. This allows the unit to be powered up in a known state at all times. The INITIAL values can be set in the INITIAL SETUP menus.

The initial setup can be used to power up the AC source with the output on and a high voltage present at the output. For normal situations, this is not recommended due to the potential danger to the operator. It is recommended that the initial voltage be set low and/or the output relay be programmed to OFF for most situations.

The following fields are provided in the INITIAL SETUP menus:

Entry	Description
<b>INITIAL SETUP 1</b>	
VOLTAGE	Sets the power-on AC voltage for AC and AC+DC modes or the DC voltage for DC mode.
CURR LIMIT	Sets the power-on current limit value.
FREQ	Sets the power-on frequency value.
PHASE	Sets the power-on frequency for phase A with respect to an external sync signal. If the internal oscillator is used (default) this setting has no effect.
<b>INITIAL SETUP 2</b>	
VOLT RANGE	Sets the power-on voltage range value. The available choices are determined by the VOLT PAIR selected in the VOLTAGE/CURRENT CONTROL SETUP menu.
VOLT MODE	Sets the power-on voltage mode. Available settings are AC mode, DC mode or AC+DC mode [ <i>iX Series only</i> ].
OL MODE	Sets the power-on overload mode. Available settings are Constant Current (CC) or Constant Voltage (CV) mode.
OUTPUT RELAY	Sets the power-on state of the output relay. Available settings are ON or OFF.
<b>INITIAL SETUP 3</b>	
VOLT SENSE	Sets the power-on state of the voltage sense mode. Available settings are Internal (INT) or External (EXT).
WAVE GROUP	[ <i>iX Series only</i> ] Sets the user defined waveform group that will be loaded at power on. Available groups are 0, 1, 2 and 3. Each group can contain up to 50 user-defined waveforms. A waveform group can only be loaded at power up. To change groups, you must change this field to the desired new group and cycle the power to the AC source or issue a *RST command over one bus.

---

CLOCK MODE	Sets the clock source used at power up. Available settings are Stand Alone (STAND), MASTER, and SLAVE.
NO. OUTPUT	<i>[iX Series only]</i> Sets the phase mode at power up. Available options are determined by the presence of the phase mode option. If the phase mode option is installed, available options are single phase mode (ONE), three phase mode (THREE) or last used phase mode (LAST). If the phase mode option is not installed, this field is either fixed to ONE or THREE.
VOLT ALC	Determines ALC mode at power on. The ALC mode adjusts the output voltage based on internal voltage measurement system and provides enhanced output regulation and accuracy. Available settings are ON, OFF or REG.

#### 4.2.11.4 LIMIT SETUP screen



Figure 4-24:LIMIT SETUP menu

The limit setup screen is not a menu but only serves to inform the user of the hardware capabilities of the AC source. The cursor can be moved to any of the fields in this screen but none of these fields can be changed. The following information is provided on this screen:

<b>Entry</b>	<b>Description</b>
VOLTAGE	Maximum AC rms or DC voltage available in the high voltage range.
CUR LIMIT	Maximum AC rms current limit available in the low voltage range.
FREQ LO	Lowest possible fundamental frequency that can be programmed.
FREQ HI	Highest possible fundamental frequency that can be programmed.
PHASE C	Phase angle of phase C with respect to phase A in three phase mode. If the AC source is a single phase model, this field will shown 0°. If the AC source is a split phase model, this field will shown 180°.

### 4.2.11.5 CONFIGURATION SETUP screens

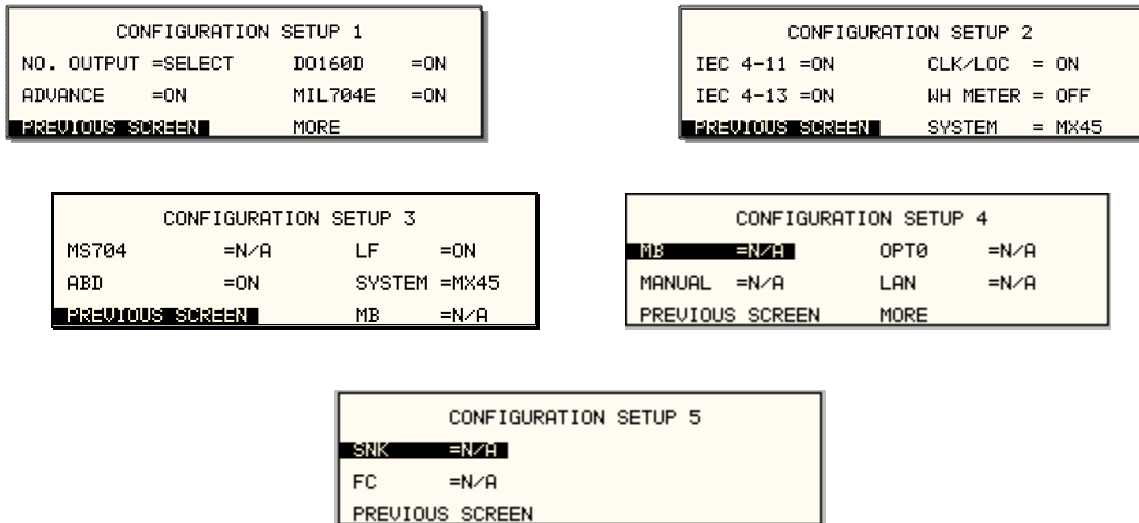

Figure 4-25: CONFIGURATION SETUP Menus

The configuration setup screen is not a menu but only serves to inform the user of the software options installed in the AC source. The cursor can be moved to any of the fields in this screen but none of these fields can be changed. The following information is provided on this screen:

Entry	Description
<b>CONFIGURATION SETUP 1</b>	
NO. OUTPUT	Displays the phase mode option. SELECT indicates the phase mode option is installed and the user can select between single and three phase modes of operation.  FIXED indicates the phase mode option is not installed and only single phase or three phase mode of operation is possible.
ADVANCE	[iX models only] This field indicates the presence of advanced capabilities for waveform generation and measurement analysis are present.
DO160	Indicates the presence of the RTCA DO160 test option. If this option is installed, this field will show ON. If this option is not installed, this field will show N/A (not available).
MIL704	Indicates the presence of the MIL/STD-704 Revision D and E test option. If this option is installed, this field will show ON. If this option is not installed, this field will show N/A (not available).
<b>CONFIGURATION SETUP 2</b>	
IEC 4-11	Indicates the presence of the IEC 61000-4-11 test option. If this option is installed, this field will show ON. If this option is not installed, this field will show N/A (not available).
IEC 4-13	Indicates the presence of the IEC 61000-4-13 test option. If this option is installed, this field will show ON. If this option is not installed, this field will show N/A (not available).
CLOCK/LOCK	Indicates the presence of the -LKS clock and lock auxiliary option. For units without -LKS, this field is set to N/A. For units with the -LKS option installed, this field is set to ON. Note that master unit (with -LKM) also has this field set to N/A.
WH METER	Indicates the presence of the Watt Hour Meter option.

### CONFIGURATION SETUP 3

MS704	Indicates the presence of the MIL/STD-704 Revision A through F test option. If this option is installed, this field will show ON. If this option is not installed, this field will show N/A (not available). This field is available on Series II i/iX systems only.
ABD	Indicates the presence of the ABD0100.1.8 test option. If this option is installed, this field will show ON. If this option is not installed, this field will show N/A (not available).
LF	Indicates the presence of the Low Frequency limit option. If this option is set, the maximum frequency that can be programmed is 500 Hz.
SYSTEM	This field sets the controller for the correct multi box system model configuration. If this field is set incorrectly, the current limit scaling and current measurement will be off by a factor of three. This field is protected and cannot be changed unless the optional MB configuration has been enabled.
MB	Indicates the presence of the Multi-box option. If this option is set, the SYSTEM field (above) can be changed to accommodate reconfiguration of the iX system. If this option is not set, the SYSTEM configuration is fixed and cannot be changed by the user.

---

**NOTE: If the MB option is enabled, great care MUST be taken to set the correct SYSTEM setting for the configured hardware. Failing to do so will result in incorrect operation of the iX power system and could even result in damage of iX or the equipment under test.**

---



---

**NOTE: Options –A350, AMD24 and –B787 are only visible using the \*OPT? Bus command and do not have a visible field in the configuration screen for firmware revisions lower than 4.60. For FW revision of 4.60 or higher, see CONFIGURATION SETUP 4 screen.**

---

#### **CONFIGURATION SETUP 4**

*(Models with FW 4.60 or higher only)*

Note that the fourth configuration screen is only available on models with firmware revision 4.60 or higher. For units with older models, refer to the CONFIGURATION SETUP 3 screen.

MB	This entry was moved from CONFIGURATION SETUP 3 to CONFIGURATION SETUP 4. Its purpose remains the same. For details, see CONFIGURATION SETUP 3 manual section on previous page.
MANUAL	This field is ON for iM models only. For i and iX models, it is set to N/A.
OPT0, OPT1, OPT2	This field indicates the presence of the following three options: OPT0 = A350 Avionics option (-A350) OPT1 = AMD24 Avionics option (-AMD) OPT2 = B787 Avionics option (-B787) The scroll through the three available OPTn fields, use the shuttle. ON indicates the option is present, N/A indicates the option is not installed.
LAN	This field indicates the presence of the LAN Ethernet interface option. ON indicates the option is present, N/A indicates the option is not installed.
SNK	This field indicates the presence of the Current Sink regenerative mode option. This field does not apply to iM/i/iX series models and is always set to N/A.

**4.2.12 OUTPUT IMPEDANCE Menu [iX Series only]**

Figure 4-26: OUTPUT IMPEDANCE menu

The iX Series offers programmable output impedance on selected models. This allows the user to simulate line impedance conditions by programming resistive and inductive elements of the AC source's output impedance.

Models on which this function is available are:

3001iX, 5001iX, 9003iX, 15003iX.

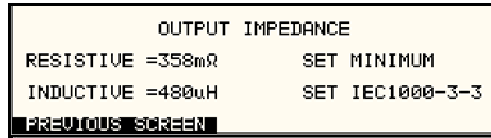
---

**Note: On 9003iX-MODE and 15003iX-MODE systems, programmable impedance function is only available in 3 phase mode of operation.**

---

Alternative, one of the available OMNI lumped reference impedance options may be used to increase the AC source output impedance for applications such as IEC 61000-3-3 Flicker testing.

The OUTPUT IMPEDANCE menu can be accessed from MENU 3. The following fields are available in this menu:

<b>Entry</b>	<b>Description</b>
RESISTIVE	Sets the resistive component of the output impedance. This value can be set from 17 mΩ to 1000 mΩ.  (The lower limits for the resistive and inductive components may vary on different AC source models and are set as part of the source calibration.)
INDUCTIVE	Sets the inductive component of the output impedance. This value can be set from 230 μH to 1000 μH.  (The lower limits for the resistive and inductive components may vary on different AC source models and are set as part of the source calibration.)
SET MINIMUM	Selecting this field and pressing the ENTER key sets both impedance components to their minimum values.
SET IEC1000-3-3	Selecting this field and pressing the ENTER key sets the output impedance to the IEC 725 reference impedance values required for IEC 1000-3-3 flicker testing.



---

**4.2.13 MEASUREMENT CAL FACTORS Menu**

---

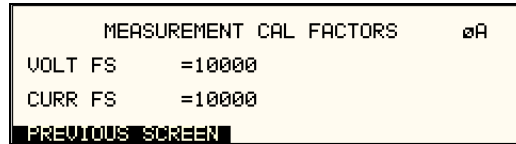

Figure 4-27: MEASUREMENT CAL FACTORS menu

The MEASUREMENT CAL FACTORS menu provides access to the measurement calibration parameters. The parameters shown are for the mode of operation (AC or DC) selected. For three phase configurations, the PHASE keys toggle between the three calibration screens for each phase. These parameters are password protected and can only be changed after the calibration password has been entered. Refer to the calibration section in this manual for details on performing a calibration.

The following calibration factors are available from this menu:

<b>Entry</b>	<b>Description</b>
VOLT FS	Full scale voltage measurement calibration factor. AC or DC mode.
CURR FS	Full scale current measurement calibration factor. AC or DC mode.

#### 4.2.14 OUTPUT CAL FACTORS Menu



Figure 4-28: OUTPUT CAL FACTORS menu

The OUTPUT CAL FACTORS menu provides access to the output calibration parameters. These parameters are password protected and can only be changed after the calibration password has been entered. For three phase configurations, the PHASE keys toggle between the three calibration screens for each phase. Refer to the calibration section in this manual for details on performing a calibration.

The following calibration factors are available from this menu:

<b>Entry</b>	<b>Description</b>
VOLT FS	Full scale voltage output calibration factor.
V HI-FREQ	High frequency full-scale voltage output calibration factor.
VOLT ZERO	Zero offset voltage calibration factor.
PHASE OFST	Phase offset calibration factor. Compensates for phase shift caused by AC amplifier.
IMP. REAL FS	Full scale resistive output impedance calibration factor.
IMP. REACT FS	Full scale inductive output impedance calibration factor.
IMP. REAL MIN	Minimum resistive AC source output impedance. The AC source has an output impedance greater than zero. This value determines the minimum resistive component of the AC source output impedance.
IMP. REACT MIN	Minimum reactive AC source output impedance. The AC source has an output impedance greater than zero. This value determines the minimum inductive component of the AC source output impedance.

## 4.3 Output Programming

### 4.3.1 Set the Output

Output parameters are all set from the PROGRAM screen.

1. Use the MENU key and select the PROGRAM entry.
2. Press the ENTER key to bring up the PROGRAM menu.

or

2. Use the PROG key to directly bring up the PROGRAM menu.

There are two methods for programming output parameters:

IMMEDIATE mode

SET mode

### 4.3.2 Slewing Output Values with the Knob in IMMEDIATE Mode

The default mode of operation is an immediate mode in which changes to output parameters made with the knob or the entry keypad are immediately reflected at the output.

To change the output voltage:

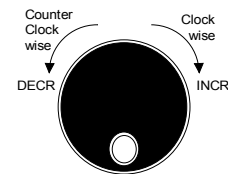
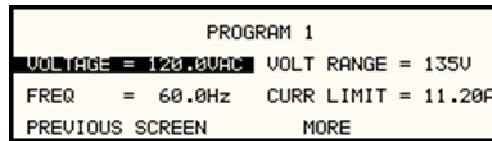

1. Place the cursor on the VOLTAGE entry
2. Rotate the knob clockwise to increase the value, counterclockwise to decrease the value

These changes take effect immediately.

To change the output frequency:

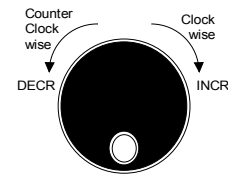
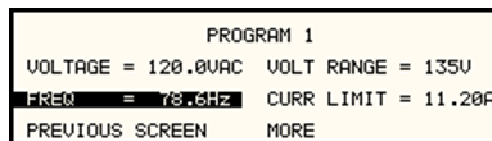

1. Place the cursor on the FREQ entry
2. Rotate the knob clockwise to increase the value, counterclockwise to decrease the value

These changes take effect immediately.

### 4.3.3 Change Output Values with the Knob in SET Mode

The SET mode of operation is a mode in which changes to output parameters made with the knob or the entry keypad do not affect the output until the ENTER key is pressed. The AC source is put in this SET mode by pressing the SET key.

To change the output voltage:

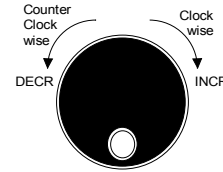
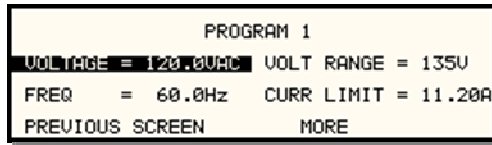

1. Press the SET key
2. Place the cursor on the VOLTAGE entry
3. Rotate the knob clockwise to increase the value, counterclockwise to decrease the value
4. The VOLTAGE field will be blinking to indicate a change in settings but the output remains unchanged.
5. Place the cursor on the FREQ entry
6. Rotate the knob clockwise to increase the value, counterclockwise to decrease the value
7. The FREQ field will be blinking to indicate a change in settings but the output remains unchanged.
8. Press the ENTER key.

Both new voltage and frequency output values are now present at the output. The unit has returned to immediate mode of operation until the SET key is pressed again.

## 4.4 Waveform Management [iX Series only]

The iX Series employs independent arbitrary waveform generators for each phase. This allows the user to create custom waveforms. In addition, the iX offers three standard waveforms that are always available. This chapter covers issues that relate to defining, downloading and managing custom waveforms.

### 4.4.1 Standard Waveforms

For many AC applications, a sine wave shape is used. The sine wave is one of the standard waveforms provided on the iX Series. The standard sine wave is always available and is the default waveform at power-on. In addition to the sine wave, two more standard waveforms are available, square and clipped.

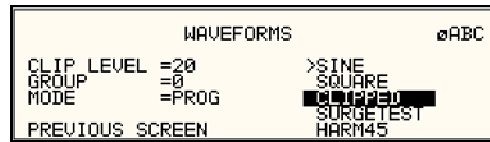

Figure 4-29: Selecting a waveform

The square wave provides a high frequency content waveform with relative fast rise and fall times. Due to AC amplifier bandwidth limitations, the frequency content of the standard square wave has been kept within the amplifier's capabilities. As the fundamental frequency is increased, the relative contribution of higher harmonics is reduced.

The clipped sine wave may be used to simulate voltage distortion levels to the unit under test. The total harmonic distortion level may be programmed in percent using the CLIP LEVEL field of the WAVEFORMS menu. Changing the distortion level of the CLIP waveform forces the AC source to regenerate the CLIPPED sine wave's data points and reload the waveform register with the newly requested data. This process requires the output to be dropped briefly. To avoid interrupting the voltage output to the unit under test, select a different waveform such as the standard sine wave first, change the clip level and change the waveform back to the CLIPPED sine wave. This will avoid any output interruption.

### 4.4.2 Phase Selection



Figure 4-30: Selecting waveforms for single phase or all phases

If the 9003iX or 15003iX, different waveforms may be selected for each phase. The number of custom waveforms from which to select remains 50 but each phase can be assigned a different custom or standard waveform. The specific output phase for which the wave shape is programmed is selected with the PHASE key on the front panel. The selected phase is always shown in the top right hand corner of the WAVEFORMS display.

To select the same wave shape for all three phases in a three phase configuration, press the PHASE key until the  $\emptyset$ ABC enunciator appears in the top right corner of the WAVEFORMS menu. Waveform selections made in this mode will apply to all three phases.

### 4.4.3 Creating Custom Waveforms

The iX Series provides four groups of 50 custom defined waveforms each for a total of 200 waveforms in addition to the 3 standard waveforms. Of these four groups, one may be active at a time. The active group is selected in the INITIAL SETUP menu.

Custom waveforms cannot be created from the front panel of the iX Series. Rather, they have to be downloaded through the IEEE-488 or RS232C interface. A Windows based program is included with the iX Series that allows waveforms to be created and downloaded easily. This Graphical User Interface program allows waveforms to be created by specifying harmonic amplitudes and phase angles with respect to the fundamental. It also offers an arbitrary waveform data entry mode that allows individual data points to be specified.

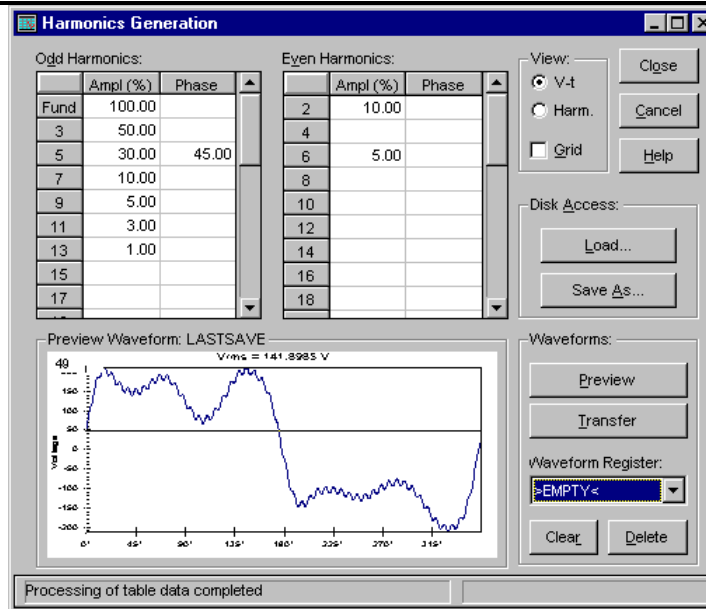

Figure 4-31: Custom waveform creation with GUI program

Once downloaded, waveforms remain in non-volatile memory and will be visible in the WAVEFORMS menu for selection. The user can assign a 12-character name to each custom waveform. Avoid using any of the standard waveform names (SINE, SQUARE or CLIPPED) as these names will not be accepted.

Waveforms may be deleted using the IEEE-488 or RS232C interface as well. Custom waveforms cannot be deleted from the front panel however to avoid accidental erasure.

#### 4.4.4 Waveform Groups

Waveform groups extend the number of available custom waveform to 200. Each group can contain up to 50 user defined waveforms. Groups are numbered 0 through 3 and may be selected from the INITIAL SETUP 3 menu. To switch waveform groups, proceed as follows:

1. Press the MENU key three times to select the MENU 3 screen.
2. Move the cursor to the UTILITY entry and press ENTER. You are now in the UTILITY 1 menu.
3. Move the cursor to the INITIAL SETUP field and press ENTER. You are now in the INITIAL SETUP 1 menu.
4. Move the cursor to the MORE field at the end of this menu and press the ENTER key. You are now in the INITIAL SETUP 2 menu.
5. Move the cursor to the MORE field at the end of this menu and press the ENTER key. You are now in the INITIAL SETUP 3 menu.
6. Move the cursor to the WAVE GROUP = field. You can now use the knob or the 0 through 3 key on the front panel to select a different waveform group.
7. Press ENTER to confirm your new selection.
8. To activate your new selection, YOU MUST CYCLE THE POWER so the AC source re-initializes. If the source is operated over the bus, a IEEE-488 Device Clear or reset command (\*RST) command will have the same effect.

The new wave group will be active after you turn the power to the unit back on.

#### 4.4.5 RMS Amplitude Restrictions

The output of a sinewave may be programmed to the full rms value of the voltage range selected. If the AC source is in the 300 V range, the maximum programmable rms voltage is 300 Volt. If a custom waveform is used however, the maximum programmable rms voltage may be less than the maximum range value. The voltage range limit is based on the use of a sine wave with a 1.414 crest factor. A 300 V rms sine wave has

a 424 Volt peak voltage. The AC source has a maximum peak voltage capability that is determined by the selected voltage range. If the user selects a custom waveform with a crest factor that is higher than 1.414, the peak voltage would exceed this maximum if the rms voltage were to be programmed at 300 V rms.

The iX Series automatically limits the maximum allowable programmed rms voltage of a any custom waveform by calculating the crest factor of the selected waveform and controlling the rms limit accordingly. Thus, each custom waveform may have a different maximum rms value. The iX controller will prevent the user from programming the rms voltage above this limit. If a value is entered in the PROGRAM 1 menu above this value, a "Voltage peak error" message is generated.

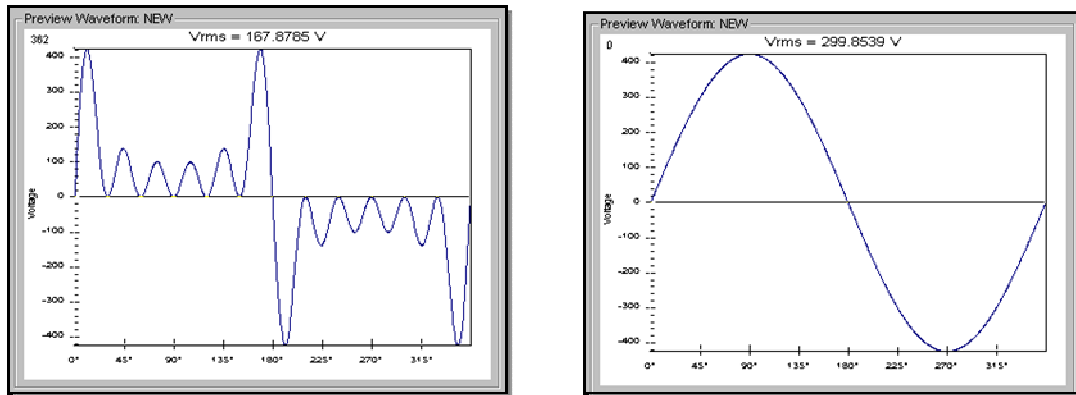

Figure 4-32: Waveform crest factor affects max. rms voltage

The figure shown here illustrates the relationship between the crest factor of the wave shape (or its "peakiness") and the maximum peak voltage allowed for a given voltage range. Since the peak voltage cannot exceed the AC source's capabilities, the programmable rms voltage has to be restricted, in this case to only 167.8785 volt for the waveform on the left. The sine wave on the right can be programmed to the full 300 V rms as this still falls within the same peak voltage limitation of the AC source.

If the iX Series is used through the bus, the :VOLT? MAX query can be used to determine the maximum allowable rms voltage for the selected waveform. Using the returned value as part of a program will prevent range errors.

#### 4.4.6 Frequency Response Restrictions

The user may create a waveform that contains any number of harmonic frequencies of the fundamental. The AC Source itself however has a finite signal bandwidth and will attenuate higher frequency components of the signal. To limit the maximum frequency component of the output signal, the iX controller automatically applies a band-pass filter to all custom waveforms as they are downloaded.

The controller implements the following process for user-defined waveforms:

Each down loaded waveform will have a computed frequency limit that is less than or equal the maximum frequency limit of the AC source. The frequency limit is a function of the harmonics content of the waveform and will follow the equation below.

$$F_{max_n} = F_{max}/(\text{level} * h_n)$$

If  $F_{max_n}$  is below the minimum frequency limit, the waveform will be rejected at down load time and the label will be deleted from the waveform catalogue.

If the power source is used over the bus, the ":FREQ? MAX" query command can be used to determine the maximum allowable fundamental frequency for the selected waveform. Using the returned value as part of a program will prevent range errors.

Limits assume a program of full-scale voltage. No adjustments for voltage setting are made below the full-scale value.

Waveform selection and frequency programming will be subject to the above limit. An error message will be generated to reflect this type of error:

"22,Waveform harmonics limit"

Transient editing will also generate the above error during keyboard entry. Remote transient entry will not check for the error until transient execution.

The frequency domain VIEW mode in the WAVEFORMS menu may be used to visualize the content of each custom waveform register on the LCD.

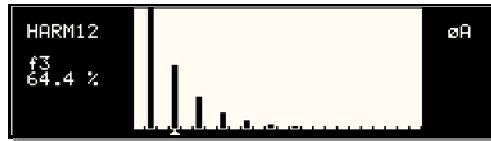

Figure 4-33: Waveform frequency domain view mode

#### 4.4.7 Switching Waveforms

Waveforms can be switched as part of the transient system. Each transient type setup menu has a FUNCTION field. This field allows selection of any of the standard or custom waveforms available in the selected group. Refer to the section on transients for more details on using transient list to switch output waveforms.



## 4.5 Standard Measurements

Standard measurements are always available through the MEAS key on the front panel. These measurements are spread across two to four screens to enhance readability. Switching between these screens can be done by successively pressing the MEAS button on the front panel. This will cause the screen to cycle through all available measurement screens.

### 4.5.1 i Series Measurements

For i Series units, the following two measurement screens are available:

Mode	AC	DC	
MEASUREMENTS 1			
VOLTAGE	AC rms voltage	DC Voltage	
CURRENT	AC rms current	DC Current	
FREQUENCY	Frequency	n/a	
POWER	Real power	power	
MEASUREMENTS 2			
VA POWER	Apparent power	power	
PEAK CURR	Highest AC current found	Highest DC current found	
POWER FACT	Power factor	n/a	
CREST FACT	Crest factor	n/a	

### 4.5.2 iX Series Measurements

For iX Series, the following four measurement screens are available:

Mode	AC	DC	AC+DC
MEASUREMENTS 1			
VOLTAGE	AC rms voltage	DC Voltage	AC rms voltage
CURRENT	AC rms current	DC Current	AC rms current
FREQUENCY	Frequency	n/a	Frequency
POWER	Real power	n/a	n/a
MEASUREMENTS 2			
VA POWER	Apparent power	power	Apparent power
PEAK CURR	Highest AC current found	Highest DC current found	Highest AC current found
POWER FACT	Power factor	n/a	Power factor
CREST FACT	Crest factor	n/a	Crest factor
MEASUREMENTS 3			
VOLT THD	Voltage distortion	n/a	Voltage distortion
CURR THD	Current distortion	n/a	Current distortion
INST PK CURR	Instantaneous peak current	Highest DC current found	Instantaneous peak current
PHASE	Phase angle	n/a	Phase angle

The iX Series has a fourth measurement screen for harmonics and trace analysis measurements. This subject is covered in the next chapter.

Measurements are always running in the background. When the user selects a measurement screen for display, the AC source first updates all the measurement parameters before displaying the requested screen. This process may take up to a second. Consequently, pressing the MEAS key may not always bring up the selected screen immediately. There will be a perceptible delay. This will prevent the screen from appearing with invalid or blank readouts.

The measurement method for voltage and current will depend on the power source operating mode. The following table shows the return value type (rms or average) and method of coupling when the measurement command is initiated with a different extension at various operating modes (AC, DC or AC + DC).

Measurement Extension and Coupling	Operating Mode		
	AC	DC	AC + DC
AC	rms	rms	rms
DC	rms	rms	average
Coupling	AC	DC	DC

### 4.5.3 Accuracy Considerations

Any measurement system has a finite accuracy specification. Measurement specifications are listed in Section 2. When using the AC source for measurement purposes, always consider these specifications when interpreting results. Measurement inaccuracies become more pronounced as the signal being measured is at the low end of the measurement range. This is particularly relevant for low current measurements. The i and iX Series are high power AC sources optimized for providing and measuring high load currents. When powering low power loads, measurement inaccuracies on rms and peak current measurements will greatly affect derived measurements such as power, power factor and crest factor.

The measurement system on the i and iX Series II uses a data acquisition system with a 16 kHz bandwidth. This means that high frequency components of the measured signal are filtered out. Any contribution to the rms value of voltage and current above this cutoff frequency will not be reflected in the i and iX Series measurements. When using an external measurement reference, this may account for discrepancies in readings.

---

## 4.6 Advanced Measurements [iX Series only]

---

The iX Series offers advanced power analyzer measurement capabilities. These functions may be accessed from the MEAS button or the MENU 2 screen. The phase for which the analysis or waveform acquisition is done may be selected using the PHASE key in three phase configurations. This chapter covers the use and application of these advanced measurement functions.

### 4.6.1 Harmonic Analysis

---

The iX power analyzer performs fast fourier transformation on both voltage and current on each available phase. The resulting frequency spectrum can be displayed on the LCD display in a tabular as well as a graphical mode.

#### 4.6.1.1 Acquiring FFT data

---

To perform an FFT analysis on the output of the AC source, proceed as follows:

1. Press the MEAS button four times or until the HARMONICS/TRACE ANALYSIS screen appears.
2. Move the cursor to the FUNCTION field and select VOLT or CURR. (The BOTH selection will default to CURR as only one FFT result can be displayed at a time.)
3. Move the cursor to the VIEW field and select the TABLE or BAR display mode. The TRACE display mode does not apply to FFT results.
4. Move the cursor to the DATA MODE field and select ABS or REL. Absolute display mode will show all harmonic components in volts or amps. Relative display mode will use the fundamental as a 100 % reference and display all harmonics as a percentage of the fundamental. Phase angles are always shown with respect to the fundamental frequency. The phase angle of the fundamental is always shown with respect to phase A.
5. Skip the SCALE field as it only applies to the TRACE display mode.
6. Move the cursor to the TRIG MODE and select SINGLE or CONT. The SINGLE mode will acquire the data once and show the result. If you select CONT, the data will be updated continuously.
7. Move the cursor to the TRIG SOURCE field and select IMM. We will cover additional trigger modes later.
8. Move the cursor to the START field and press the ENTER key. The display that you selected will be shown. If you are in CONT trigger mode, the data will be updated about once per second.

You can return to the HARMONICS/TRACE ANALYSIS screen by pressing the ENTER key. To display the data in a different format, change to the selections you want and move the cursor to the VIEW field. Pressing the ENTER key will re-display the data without triggering a new acquisition. (This is true even if you were in CONT trigger mode.) To start a new acquisition, you must go through the START field instead.

**4.6.1.2 Analyzing FFT data**

The data displays available for FFT data allow you to scroll through the entire data set. For table displays, the UP and DOWN arrow keys may be used to scroll through the table data vertically. The knob has no function while in this display mode. The triangle on the left edge of the LCD screen points to the current position in the table.

Arrow indicator can be moved up or down using UP/DOWN cursor keys.

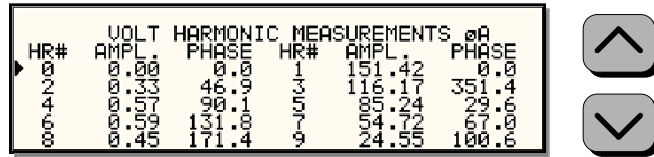

Figure 4-34: Scrolling through tabular FFT data

Bar chart format FFT data displays show the same data in a graphical format. While the amplitude information is shown graphically, phase data is only displayed in numeric form to the left for the currently selected harmonic component. The display can show up to 24 components at a time. The triangle at the bottom of the display shows the currently selected component for which numeric data is shown on the left. This data includes the harmonic number (DC through 50), the absolute or relative amplitude (depending on selected VIEW mode) and the phase angle with respect to the fundamental. The knob can be used to scroll through the display horizontally. The UP and DOWN cursor keys have no effect in this display mode.

Arrow indicator points to harmonic for which readout is shown on the left. Can be moved with knob.

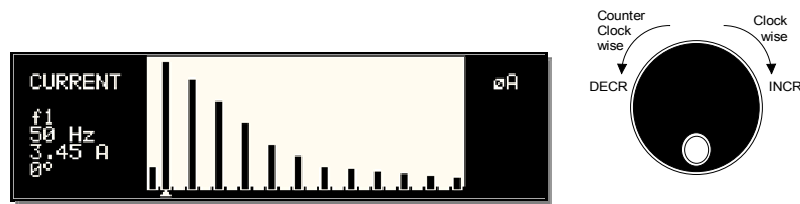

Figure 4-35: Scrolling through bar chart FFT data

---

## 4.6.2 Waveform Acquisition

---

The waveform acquisition mode allows voltage and/or current data waveforms to be captured and displayed. This mode is selected by choosing the VIEW =TRACE mode in the HARMONICS/TRACE ANALYSIS screen. Voltage and current may be viewed separately or combined into a single display using the FUNCTION field.

---

### 4.6.2.1 Acquiring waveform data

---

To perform a waveform acquisition on the output of the AC source, proceed as follows:

1. Press the MEAS button four times or until the HARMONICS/TRACE ANALYSIS screen appears.
2. Move the cursor to the FUNCTION field and select VOLT, CURR or BOTH.
3. Move the cursor to the VIEW field and select the TRACE display mode.
4. Skip the DATA MODE field as it only applies to the TABLE and BAR display modes.
5. Move the cursor to the SCALE field and select a horizontal time base value to allow you to see at least one cycle of the output waveform. If the output is programmed at 50 Hz, a 20 ms scale would display exactly one signal period.
6. Move the cursor to the TRIG MODE and select SINGLE or CONT. The SINGLE mode will acquire the data once and show the result. If you select CONT, the data will be updated continuously.
7. Move the cursor to the TRIG SOURCE field and select IMM. We will cover additional trigger modes later.
8. Move the cursor to the START field and press the ENTER key. The display that you selected will be shown. If you are in CONT trigger mode, the data will be updated about once per second.

You can return to the HARMONICS/TRACE ANALYSIS screen by pressing the ENTER key. To display the data in a different format or to select voltage instead of current or current instead of voltage, change to the selections you want and move the cursor to the VIEW field. Pressing the ENTER key will re-display the data without triggering a new acquisition. (This is true even if you were in CONT trigger mode.) To start a new acquisition, you must go through the START field instead.

### 4.6.2.2 Analyzing waveform data

The data displays available for acquired waveform data allow you to scroll through the entire acquisition buffer. For waveform displays, the knob can be used to scroll through the display horizontally. The UP and DOWN cursor keys have no effect in this display mode.

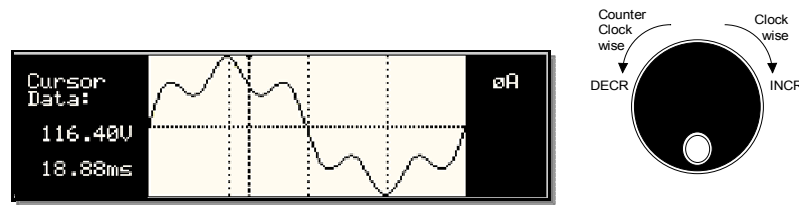

Readouts on the left track the vertical cursor position on the waveform. Trigger point is at 0.0 ms.

Figure 4-36: Scrolling through acquired waveform data

The acquisition buffer may be longer than the selected horizontal scale in which case only a portion of the acquisition window will be visible. The left portion of the LCD display is used to read out the data under the vertical cursor. This cursor is a dotted line that can be moved using the knob. If the left or right edge of the display window is reached, the entire display will shift so the cursor always remains visible. The time from the trigger point to the vertical cursor is displayed in the left hand portion of the LCD in ms. Also displayed here are the absolute voltage and/or current value under the cursor.

To change the horizontal display scale without re-triggering an acquisition, press the ENTER key to return to the HARMONICS/TRACE ANALYSIS screen, change the SCALE value, move the cursor to the VIEW field and press ENTER. This will display the same data set at the new scale without triggering a new acquisition.

### 4.6.3 Triggering Measurements

---

Both FFT results and waveform acquisitions may have to be positioned at a specific moment in time. To allow the data acquisition to coincide with user specified events, the measurement system can be triggered in different ways. Trigger modes are available from both the bus and the front panel. If the IEEE-488 or RS232C bus is used, acquisitions may also be triggered from the transient list system. Refer to the programming manual for details on this mode of operation.

#### 4.6.3.1 Trigger mode

---

The following trigger modes are supported by the iX Series:

Single (SINGLE)	<p>This mode causes the acquisition system to be armed only once. The iX source waits for the user to press the ENTER key while on the START field. As soon as the trigger event specified occurs, data is acquired and the acquisition system is put in an idle state. A new user initiated START event must be given to trigger a new acquisition.</p> <p>This mode is appropriate for capturing events that occur only once such as the inrush current when turning on a load.</p>
Continuous (CONT)	<p>This mode causes the trigger system to re-arm itself after each trigger event. Every time a new trigger event occurs, new data is acquired and the LCD display is updated. No user intervention is required after the initial START event.</p> <p>This mode is appropriate for capturing repetitive events or to monitor the source output continuously. Display updates will occur about once per second.</p>

#### 4.6.3.2 Trigger source

---

The iX Series offers a choice of trigger sources in front panel operation mode. The following trigger sources are available from the HARMONICS/TRACE ANALYSIS, TRIG SOURCE field:

Immediate (IMM)	<p>This mode causes a trigger to occur as soon as the ENTER key is pressed with the cursor on the START field. No trigger source needs to be specified for this trigger mode. This mode is equivalent to the INIT:IMM:ACQ bus command.</p> <p>This trigger source is appropriate if no trigger condition is known or desired. When using this trigger source, the acquisition is always triggered.</p>
Phase (PHASE A)	<p>This mode causes the iX acquisition system to wait for a specified phase angle on the phase A voltage output. This allows the acquisition to be positioned in time with respect to any phase angle on phase A, B or C. Note that phase A, B and C are typically at 0°, 240° and 120° with respect to the specified trigger phase in this field. An example of this trigger source mode is shown in Figure 4-38.</p> <p>When selecting this trigger source, the field below the TRIG SOURCE field changed to "TRIG PHASE =". Use this field to enter the desired voltage phase angle to trigger the measurement on.</p> <p>This mode is appropriate when capturing analyzing events at a specific phase angle such as the zero crossing of the voltage. Note that the phase angle of the current with respect to the voltage is determined by the load, so triggering at a specific phase current angle is not possible as it is not controlled by the AC source. However, when capturing current waveform data, the phase relationship to the voltage can be determined easily by triggering at the 0° point on the voltage.</p>
Voltage step (SET VOLT)	<p>This mode performs two functions. It programs the output voltage for the selected phase or phases to the rms or DC value specified and it triggers the measurement acquisition at the same moment in time.</p>

When selecting this trigger source, the field below the TRIG SOURCE field changed to "SET VOLT =". Use this field to enter the desired voltage to program the output to and trigger the measurement on. If only one phase in a three phase system is selected, only that phase's output will be programmed. If all phases are selected, all three phases' outputs will be programmed. Use the PHASE key to select the desired phase or all phases. Figure 4-37 shows an example of using the SET VOLT trigger source to capture the turn-on of the voltage. In this case, a negative trigger delay was specified and the voltage start phase angle was set to  $90^\circ$  in the PROGRAM 2 screen.

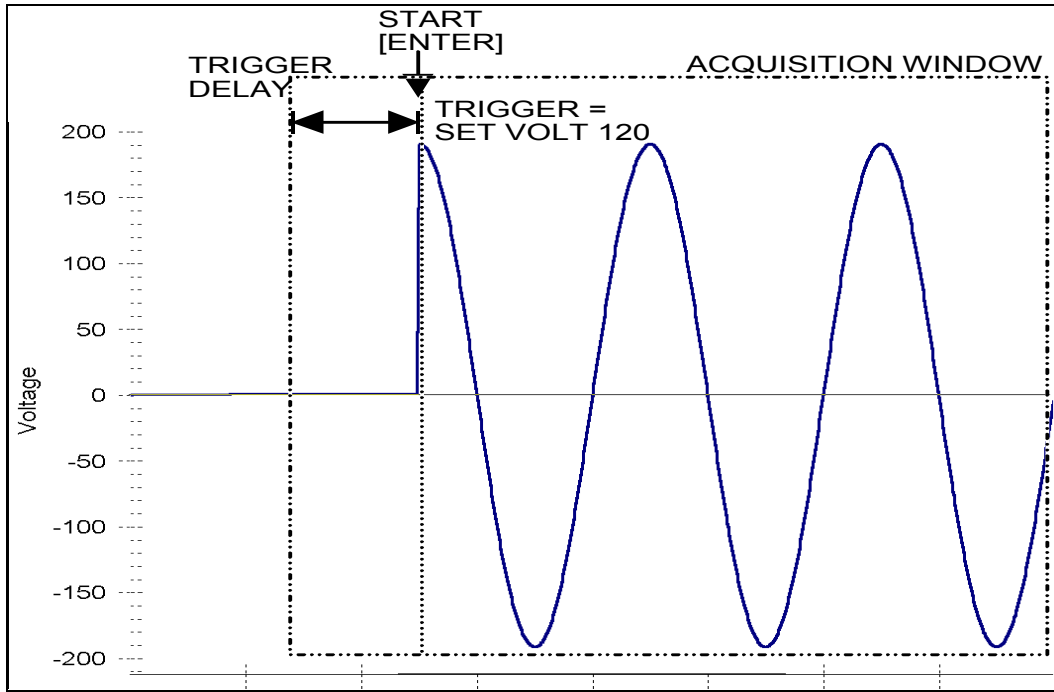

Figure 4-37: SET VOLT trigger source acquisition

This mode is appropriate for capturing the inrush current of a load by programming the voltage to a specified value and capturing the voltage and current at that moment in time. A further refinement can be made by specifying the voltage start phase angle in the PROGRAM 2 screen. If this field is changed from RANDOM to  $90^\circ$ , the inrush current can be captured under worst case conditions. In this case, the voltage should be programmed to 0 volt before triggering the acquisition using the START field.

**Note:** When using the SET VOLT trigger source, the output relay MUST be closed to generate a trigger. If the output is open, the acquisition will be armed when the START [ENTER] key is pressed but will wait for the trigger event. Closing the output relay will generate the trigger event. If the output relay was already closed when the START [ENTER] key is pressed, the trigger will occur immediately.



### 4.6.3.3 Trigger delay

The trigger delay field allows the user to set the amount of pre- or post-trigger data that should be used when positioning the data acquisition window with respect to the trigger moment.

#### POST-TRIGGER DELAY

A positive trigger delay value means the acquisition window is delayed by the amount of time specified. In this case, the actual trigger moment itself is no longer present in the acquisition buffer. This situation is shown in Figure 4-38 where a 20 ms trigger delay is used after triggering on phase A = 180°. The fundamental frequency of the output is 50 Hz. The trigger point is indicated by the dashed line. It occurs on the first 180 degree point that occurs after the user presses the ENTER key while on the START field. Once the trigger occurs, the acquisition holds off the specified 20 ms at which point the data requested is captured. Using a positive trigger delay value always yields post trigger data.

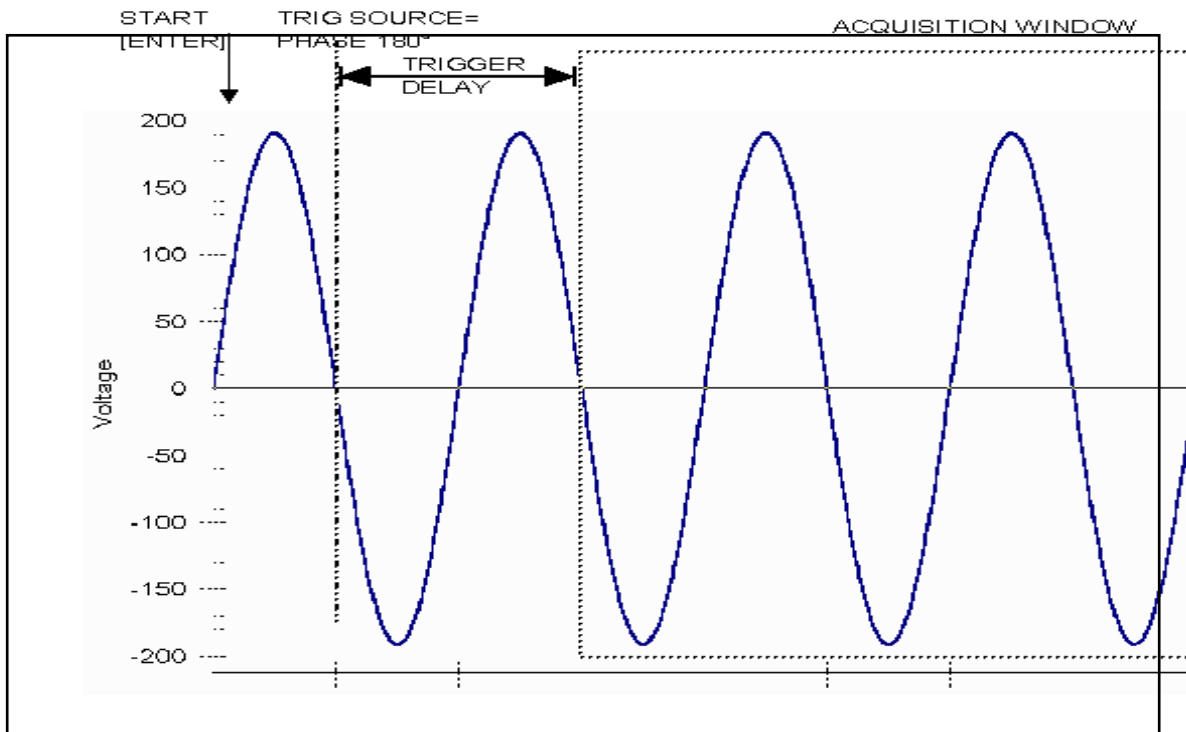

Figure 4-38: Positive trigger delay (Post trigger data)

Positive trigger delay values may be set from 0.0 ms to 1000.0 ms (1 second) in 0.1 ms increments. The value may be entered directly from the keyboard or using the knob.

## PRE TRIGGER DELAY

Alternatively, a negative trigger delay value may be specified up to the maximum time window depth of the acquisition window. The value may be entered directly from the keyboard or using the knob. The following time interval range is available:

Single-phase mode: 42.6 msec to 426 msec.

Three-phase mode: 128 msec to 1280 msec.

This situation is shown in Figure 4-39. The example shows a similar scenario as before, only this time the trigger delay was set a -20 ms. Notice that the data acquisition window now contains data that occurred before the user pressed the ENTER key to start the acquisition.

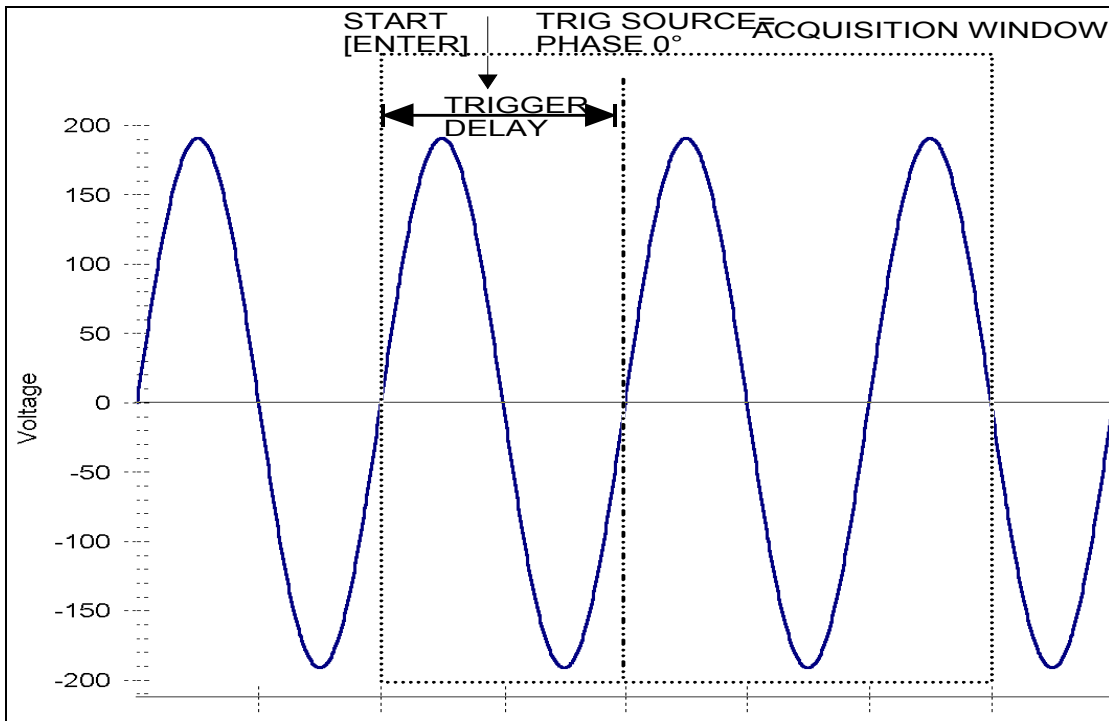

Figure 4-39: Negative trigger delay (Pre-trigger data)

---

## 4.7 Transient Programming

---

### 4.7.1 Introduction

---

Transient programming provides a precise timing control over output voltage and frequency changes. This mode of operation can be used to test a product for susceptibility to common AC line conditions such as surges, sags, brownouts and spikes. By combining transient programming with custom waveforms [*iX Series only*], virtually any AC condition can be simulated on the output of the AC source.

The default voltage mode is FIXED which means the output voltage is constant and remains at the level set by the user. Changes made to the output voltage made from the PROGRAM 1 menu take effect immediately. In front panel operation mode, the voltage and frequency slew rates (rate of change) are always at their maximum of 9.9E37 V/s and 9.9E37 Hz/s or MAX. Slew rate programming is only possible over the IEEE-488 or RS232C bus. On power up, the AC source always reverts to the maximum slew rate for both voltage and frequency.

### 4.7.2 Using Transient Modes

---

The voltage can be programmed in the following transient operating modes:

- STEP causes the output to permanently change to its triggered value.
- PULSE causes the output to change to its triggered value for a specific time, as determined by the Pulse menu parameters.
- LIST causes the output to sequence through a number of values, as determined by points entered in the List menu.
- FIXED disables transient operation for the selected function.

### 4.7.3 Step Transients

---

Step transients let you specify an alternate or triggered voltage level that the AC source will apply to the output when it receives a trigger. Because the default transient voltage level is zero volts, you must first enter a triggered voltage before you can trigger the AC source to change the output amplitude. Step transients can only be programmed through the bus, not the front panel. Refer to the SCPI Programming Manual for more information about programming Step transients and triggers.

#### 4.7.4 Pulse Transients

Pulse transients let you program the output to a specified value for a predetermined amount of time. At the end of the Pulse transient, the output voltage returns to its previous value. Parameters required to set up a Pulse transient include the pulse count, pulse period, and pulse duty cycle. An example of a Pulse transient is shown in Figure 4-40. In this case, the count is 4, the pulse period is 16.6 ms or 60 Hz and the duty cycle is 33%.

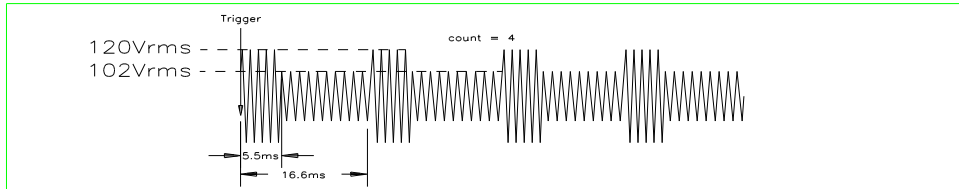

Figure 4-40: Pulse Transients

Note that Pulse transients can only be programmed over the bus, not the front panel. Refer to the SCPI Programming Manual for more information about programming Pulse transients and triggers.

### 4.7.5 List Transients

List transients provide the most versatile means of controlling the output in a specific manner as they allow a series of parameters to be programmed in a timed sequence. The following figure shows a voltage output generated from a list. The output shown represents three different AC voltage pulses (160 volts for 33 milliseconds, 120 volts for 83 milliseconds, and 80 volts for 150 milliseconds) separated by 67 millisecond, zero volt intervals.

Transient list programming is supported from the front panel and may be accessed by selecting the TRANSIENTS entry in the MENU 1 screen. Transient lists can also be programmed over the bus. Refer to the SCPI Programming Manual for more information about programming List transients and triggers over the bus.

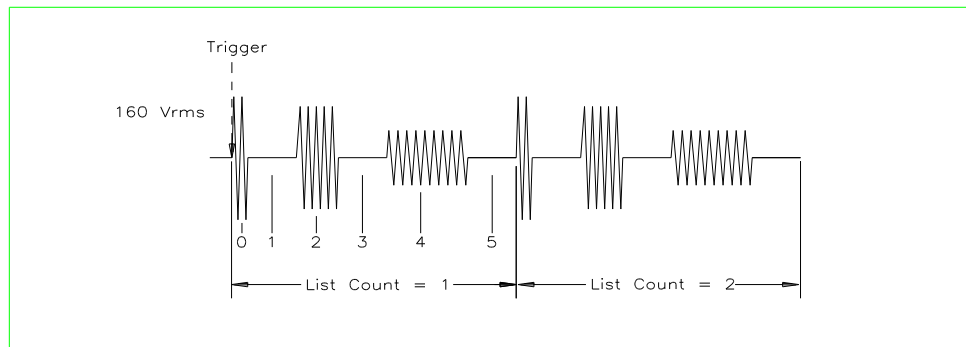

Figure 4-41: List Transients

The list specifies the pulses as three voltage points (point 0, 2, and 4), each with its corresponding dwell point. The intervals are three zero-voltage points (point 1, 3, and 5) of equal intervals. The count parameter causes the list to execute twice when started by a single trigger.

To set up this type of transient list, proceed as follows:

1. Press the PROG key to bring up the PROGRAM 1 menu.
2. Move the cursor to the VOLTAGE field and enter 0 Volt. Press ENTER to confirm your setting.
3. Make sure you are in the HIGH voltage range as we will program a surge to 160 V rms. The low range would only allow 150 V rms.



4. Press the MENU key to bring up MENU 1.
5. Move the cursor to the TRANSIENTS entry and press the ENTER key. You are now in the TRANSIENTS menu.
6. Move the cursor to the VOLT SURGE/SAG entry and press the ENTER key. You are now in the VOLT SURGE/SAG SETUP menu.
7. If you have a three phase configuration and are in the three phase mode, use the PHASE key to select all three phases. (∅ABC will be displayed in the top right corner of the screen.)
8. The START ∅ may be left at RANDOM as we are not interested in starting at a specific phase angle. If a number is already present in this field, use the BACKSPACE (<-) key to clear it.
9. Move the cursor to the GO TO VOLT field and enter 160.0
10. Move the cursor to the DUR SCALE field and set this field to TIME. We will be entering delays in time rather than cycles since this example was stated in ms.

11. Move the cursor to the DURATION field and enter 0.033 seconds. Be sure not to enter 33 as this field is specified in seconds, not milliseconds. The highest time resolution available for list transients is 1 ms or 0.001 s.
12. Move to the END VOLT field and enter 0.0. We want the voltage to return to 0 Volt after the first burst.
13. Move the cursor to the END DELAY field and enter 0.067 for a interval delay of 67 ms. Notice that we effectively combined steps 0 and 1 from Figure 4-41 into a single list event.
14. If you have an iX Series AC source, move down to the FUNCTION field and use the knob to select SINE. The knob will allow you to scroll through all available wave shapes in the active WAVE GROUP. If you have an i Series AC Source, this field will not be visible.
15. Move the cursor to the REPEAT field and enter 0. This means this event will be executed once and not repeated. Do not confuse this event level repeat capability with the entire list level repeat field which we will use later.
16. Move the cursor down to the EVENT # field and enter a number from 1 through 99. The transient list will be executed in order of event number. Leaving a gap between event numbers allows you to insert events at different places later in the sequence. Deleting events is always possible regardless of the event number. For the purpose of this exercise, we will start with EVENT # 5. Enter 5 and press the ENTER key. This brings you back to the TRANSIENTS menu.

```

      VOLT SURGE/SAG SETUP      @ABC
START @ =RANDOM      END VOLT =0.0
GO TO VOLT=160.0    END DELAY =0.067S
DUR SCALE =TIME     FUNCTION =SINE
DURATION =0.033S    REPEAT =0
PREVIOUS SCREEN    EVENT # =5
  
```

17. Repeat steps 6 through 16 two more times using 120 V, 83 ms and 80 V, 150 ms as values for EVENT # 10 and EVENT #15.
18. Once you have programmed these three events, move the cursor in the TRANSIENTS menu to the START/VIEW SEQUENCE field and press the ENTER key. This will get you to the START/VIEW TRANSIENT SEQUENCE menu from which you can run transient programs. This screen shows all available events in the transient list on the right hand side. If more than five events are programmed, you can scroll through the list using the UP and DOWN arrow keys. To edit an existing event, move the cursor to the relevant event number and press the ENTER key.
19. Move the cursor to the REPEAT #0 field and enter 1. This will cause the transient program to repeat once and thus run two times total. Do not confuse this global list level repeat capability with the list event level repeat field we skipped in step 15.
20. Make sure the output relay is closed using the OUTPUT ON/OFF key. If you start a transient program with the relay open, an error message will appear.
21. Move the cursor to the START field and press the ENTER key. The transient program you just created will execute two times. If you have an oscilloscope connected to the output, you may be able to see the output voltage change per Figure 4-41.

```

      START/VIEW TRANSIENT SEQUENCE
START #          #05= VOLTAGE SURG/SAG
PAUSE #         #10= VOLTAGE SURG/SAG
REPEAT #0      #15= VOLTAGE SURG/SAG
CLEAR SEQ
PREV. SCREEN
  
```

---

**Note:** *The AC source output remains at the last programmed values at the completion of the list.*

---

In three-phase mode, the voltage lists are phase selectable. You can set up a different voltage list for each phase. To do this, use the PHASE key to choose the desired phase, as described in the example. Note that fields common to all phases such as DURATION, END DELAY and REPEAT always apply to all three phases in three-phase mode. When the cursor is moved to any of these fields, the phase enunciator in the top right-hand corner always reverts to @ABC. Frequency transients are identical to voltage transients except they apply to all three phases at all times in a three-phase configuration.

---

#### 4.7.6 Programming Slew Rates

---

As shown in the previous examples there are a number of ways that you can generate custom waveforms. Programmable slew rates provide additional flexibility when customizing waveforms. Slew rates determine how fast the voltage or frequency is changed by the controller when a step, pulse, or list transient is triggered. Slew rates cannot be programmed from the front panel and are always set to their maximum values at power on. To use programmable slew rates, the AC source must be programmed over the bus. Refer to the SCPI Programming Manual for more information about programming slew rates.

---

**4.7.7 Switching Waveforms**

---

The FUNCTION field available in each transient list event setup menu may be used to dynamically switch waveforms during transient execution. This allows different waveforms to be used during transient execution. Waveforms may be switched without the output of the source being turned off. For three phase configurations, each phase has its own waveform list so different waveforms may be programmed on different phases during transient execution.

Figure 4-42 illustrates the concept of using different waveforms at different steps in a transient list. In this case, the change was programmed to occur at the zero crossing. Any phase angle can be used to start a transient step however.

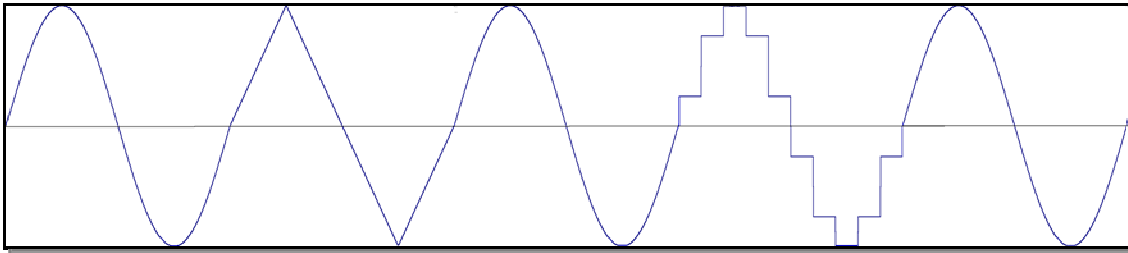

*Figure 4-42: Switching waveforms in a transient list*



## 4.7.8 Transient Execution

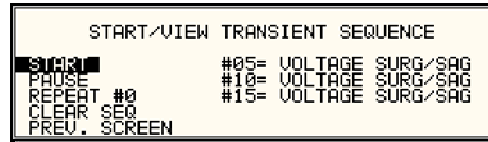

Figure 4-43: START/VIEW TRANSIENT SEQUENCE menu

A transient list can be executed from the START/VIEW TRANSIENT SEQUENCE menu. To start a transient list, position the cursor on the START field as shown in Figure 4-43 and press the ENTER key. Transients may be aborted by pressing the ENTER key again while on the same field as the field changes to ABORT while a transient execution is in progress. For short duration transients, this will likely not be visible, as the transient will complete before the screen is updated. Longer duration transients however may be aborted in this fashion.

Longer duration transients may also be suspended using the PAUSE field located below the START/ABORT field. Pressing the ENTER key while on the PAUSE field will suspend the transient execution. Once suspended, it can be resumed using the same field as the field changes to RESUME while the transient execution is suspended. Suspending a transient may be useful when running slowly changing output transients to 'hold' the output at a specific setting while observing the effect on the unit under test.

## 4.7.9 Saving Transient List Programs

When the AC source is turned off, the transient list that was programmed is not automatically retained. Thus, if you turn the unit off, you will lose your programmed transient list. However, transient programs may be saved in nonvolatile memory for later recall. This allows multiple transient list programs to be recalled quickly without the need to enter all parameters each time. Transient lists are stored as part of the overall instrument front panel setup in any of the available setup registers.

To save the transient list you created in the previous example, proceed as follows:



1. Press the MENU key two times to bring up the MENU 2 screen.
2. Move the cursor to the SETUP REGISTERS entry and press the ENTER key.
3. The cursor will default to the SAVE REGISTER # position. Enter a number from 0 through 15 and press the ENTER key.
4. A message will appear at the bottom of the screen indicating that the front panel settings and the transient list data have been saved in the setup register you selected.

## 5. Principle of Operation

### 5.1 General

An explanation of the circuits in the 3001iX and 5001iX is given in this section. Refer to Figure 5-1 for a block diagram of the system. Figure 5-2 shows the system interconnect schematic.

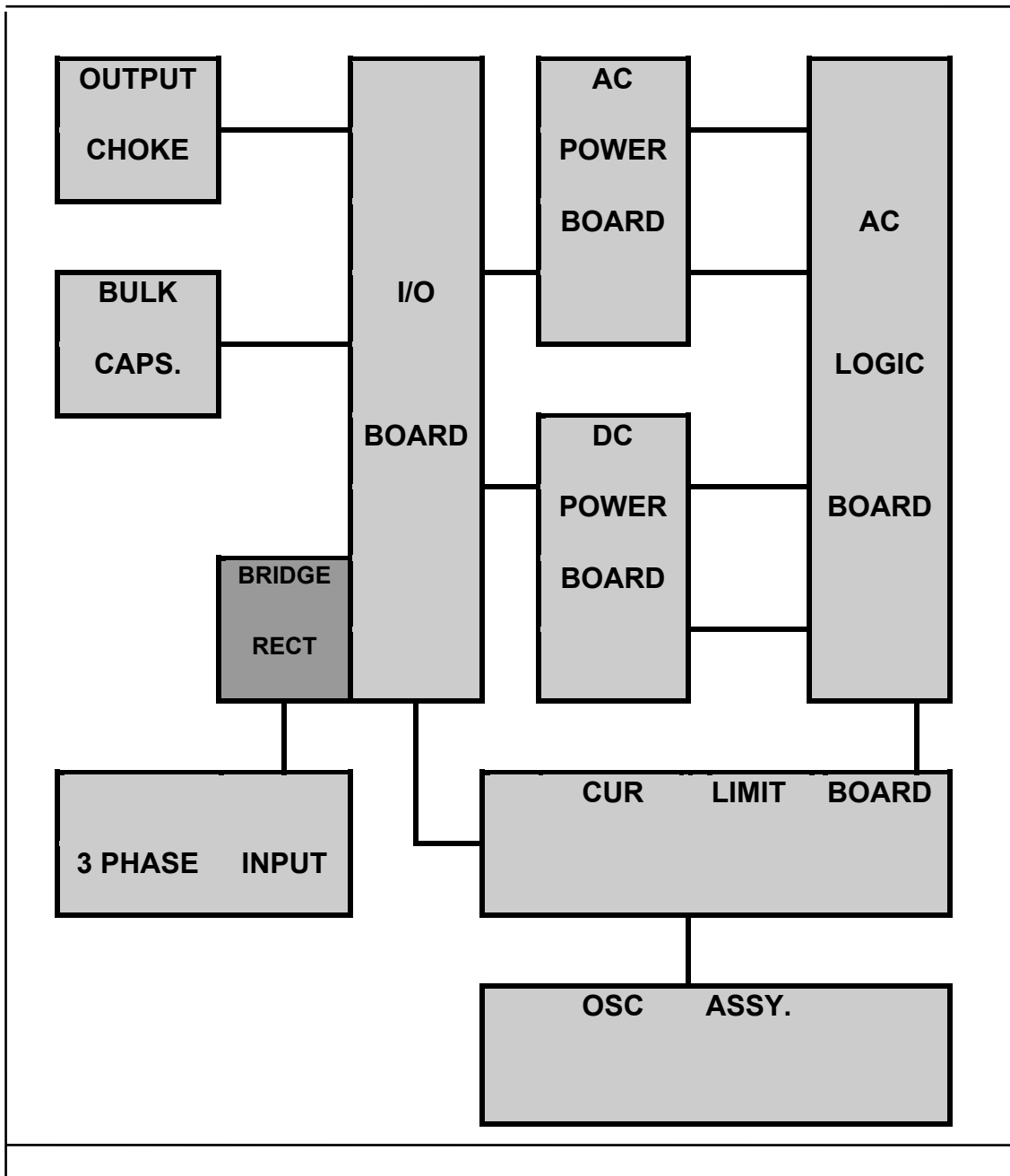

Figure 5-1: AC Power System Block Diagram

### 5.2 Overall Description

Three or single phase input power is routed in from the back panel through an EMI filter and the circuit breaker to the input bridge rectifier. The DC output from the bridge rectifier is smoothed by a small amount of capacitance in order to keep the input power factor as high as possible. This DC output supplies the converter on the DC power board.

The DC converter turns the unregulated rectified AC into a smoothed, isolated, tightly regulated DC supply. Also mounted on the DC power board is the auxiliary power supply. The auxiliary power supply creates low voltages to operate the control logic board, the oscillator board, the AC power board, and the fan. The output of the DC converter is fed to two large electrolytic capacitors on the I/O board. These capacitors also provide holdover storage energy to ride through line dropouts.

The AC power board takes the DC input and puts out isolated, direct coupled, AC power.

The DC bus is regulated at 250 volts for the 135/150 VAC output and 500 volts for the 270/300 VAC output.

The oscillator assembly generates the reference waveforms and provides frequency, amplitude, and impedance control. The current limit board, in conjunction with the oscillator board, provides the current limit function.

The assemblies are described in more detail in the following paragraphs. Refer to Figure 5-1 for an overall block diagram.

## **5.3 Oscillator Assembly**

---

The oscillator assembly consists of three printed circuit board assemblies connected by a ribbon cable. The oscillator generates the sine wave signal setting the frequency, amplitude and current limit level. It also senses the output voltage to provide closed loop control of the output.

### **5.3.1 CPU Board**

---

This board assembly, A7, consists of the components for the CPU (DSP), generating the Phase waveform signals to the power amplifiers, programmable impedance (iX models only) and all of the program, waveform and data memory. In addition, the waveform board contains the circuits for all measurements. The clock and lock circuit required to support the clock and lock mode of operation of multiple i/iX units is also on this board assembly. For three phase i/iX models, all three phases are contained on the same board assembly 7003-718-3 (1 phase) or 7003-718-1 (3 phase). If the -413 option is present, a separate inter harmonic generator board is connected to the CPU board.

### **5.3.2 Keyboard/Display Board**

---

The keyboard/display assembly is assembly A9. It is mounted to the front panel and holds the 23 rubber keys. It also has the LCD graphics display. A shaft encoder is mounted on the board that is used for a shuttle input.

### **5.3.3 GPIB / RS232 or GPIB / RS232 / USB / LAN IO Board**

---

This board assembly is identified as A10. It has the IEEE 488, RS232 and USB transceivers and optionally an Ethernet interface (-LAN option). USB and LAN are available on top assembly 7000-485 and 7000-486 iX/i models only. It also has isolators to provide safety isolation for all control interfaces.



Figure 5-2: Power Source Module Block Diagram

---

## 5.4 Current Limit Board

---

The current limit board, A6, receives the oscillator signal and passes it through to the amplifier. All current limit functions are handled by the 7003-718 CPU board.

When two or three units are connected as a single-phase system the MRA output from the master oscillator amplifier drives all the power amplifiers over the system interface cable.

An over current condition on any amplifier will act to reduce the output voltage and put the entire system into the constant current mode.

---

## 5.5 Auxiliary Power Supply

---

The auxiliary power supply is mounted on the DC-DC power board. This assembly generates nine low voltage outputs. These outputs from the auxiliary power supply provide logic power to all the modules.

- a) +/- 18V to the AC logic board and the oscillator.
- b) +8V to the oscillator.
- c) + 15V to the DC-DC converter.
- d) Three + 18V supplies to the AC power amplifier gate drives.
- e) +24V for the fan and relay power.
- f) +8V for the digital front panel meter or GPIB/RS232 board.

All the supplies a), b) and e) have a common ground. The supplies in c) and d) are all isolated from each other and from a), b) and e). LED's on the AC logic board and the AC power board are lit when each output is in regulation. If an overload condition causes the output to drop more than 10% or the output has failed, the corresponding LED will extinguish. This feature is helpful in troubleshooting the unit. See Service section 7.

## 5.6 DC-DC Power Converter

---

The DC-DC power converter, A3, is powered from the rectified AC input. The converter is a PWM (pulse width modulated) full bridge type that uses IGBT's as the power switches. The control logic supply for the DC-DC converter is derived from the auxiliary power supply so the DC-DC converter does not start switching until after the auxiliary power supply has started up and comes into regulation. This feature ensures a smooth start up.

The output of the DC converter is automatically selected for 250 VDC or 500 VDC output depending on whether the low range output (150 Vac) or high range output (300 Vac) is selected. The 250/500 VDC range selection is made by a relay that selects one of two taps on the DC output transformer. The converter is fully protected with input current limit and overvoltage protection. When the output of the DC converter is up and in regulation, the LED on the input/output board will be lit. The LED can only be seen by looking directly down between the large storage capacitors and the input/output board. (See Figure 5-3)

## 5.7 AC Control Logic

---

The main function of the control board, A4, is to generate the gate drive signals for the AC power stage. This board also includes the circuit for the current limit and when two or three units are operated in parallel, the load sharing circuit. (See Figure 5-6)

The signal from the oscillator is fed through a low pass filter circuit and sent to the reference input of the error amplifier. The voltage output of the unit is differentially sensed and fed back to the error amplifier thereby completing the control loop. The output of the error amplifier drives a 37.5 kHz pulse width modulator. The modulator output is sent to four gate drivers which drive the IGBT's on the AC power board after going through opto couplers that provide the necessary isolation.

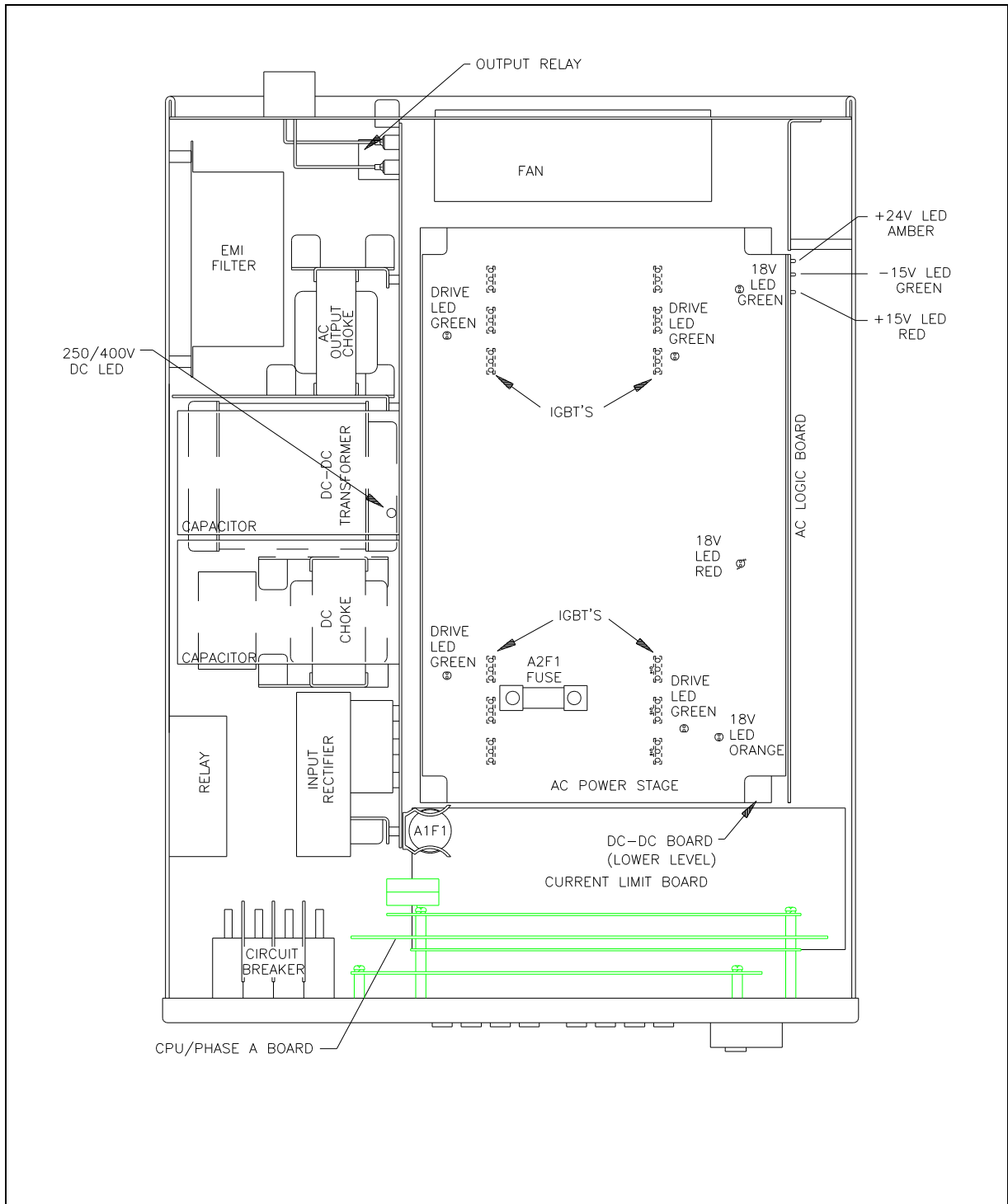

Figure 5-3: 5001i Internal Layout

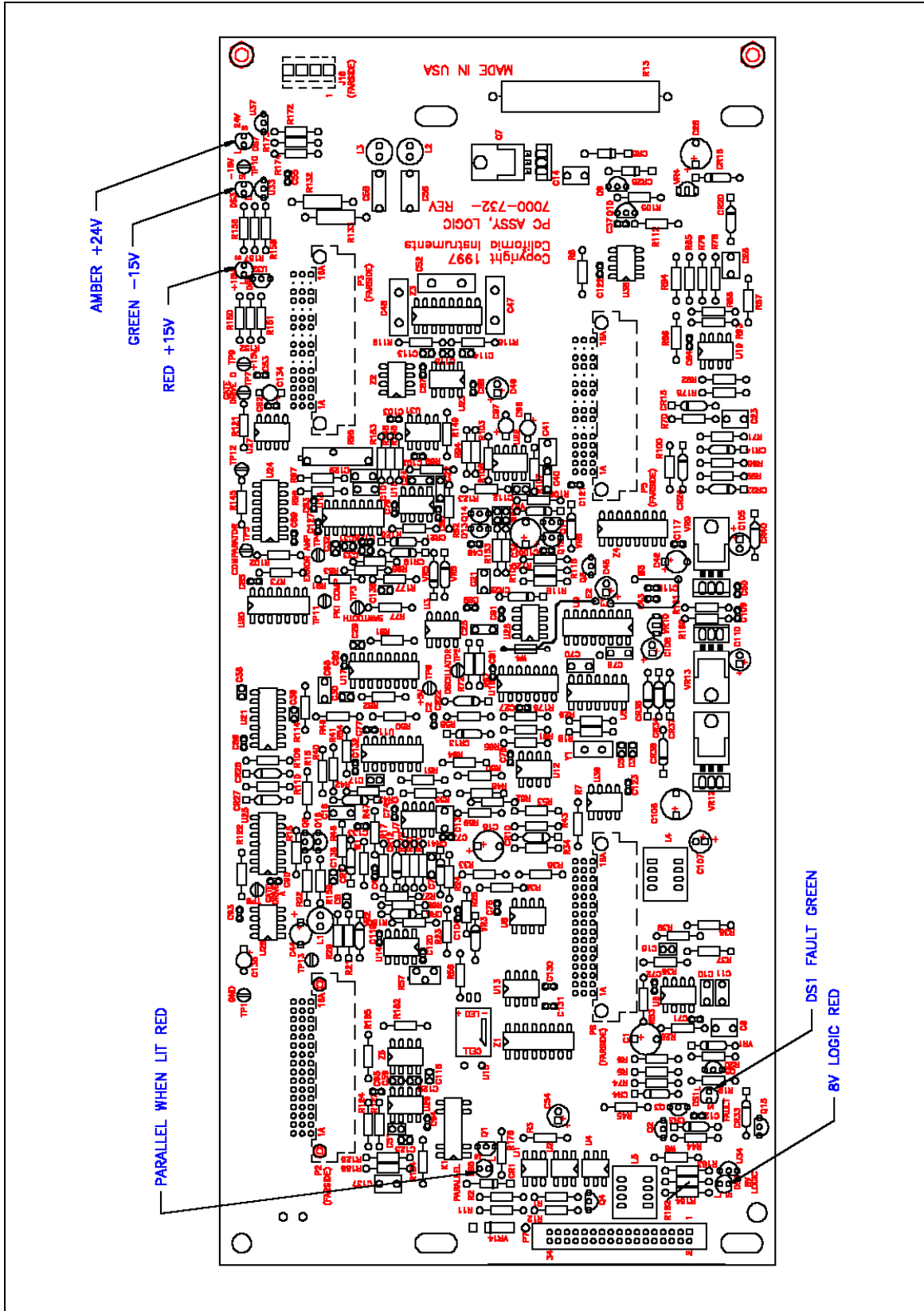

Figure 5-4: Logic Board LED's



There are six LED indicators on the logic board. Their positions are shown in Figure 5-4. The LED functions are listed in Table 5-1.

Table 5-1: Logic Board LED's

LED#	FUNCTION	COMMENTS
DS2	+15V	+15V logic supply
DS3	-15V	-15V logic supply
DS4	+8V	+8V oscillator supply
DS7	+24V	+24V supply for relays and logic.
DS5	PARALLEL	LED should be lit when units are paralleled and K1 is closed.
DS1	FAULT	LED is lit - unit normal. No light indicates pwr. stage failed

## 5.8 AC Power Board

The AC power assembly takes a 250V/500V DC input and generates a 150V/300V AC direct coupled output. The AC power amplifier is a full bridge inverter with three paralleled IGBT's in each leg for a total of twelve IGBT's. The switching frequency of the bridge is 37.5 kHz and this frequency is smoothed out by two inductors that are mounted behind the input/output board and several smoothing capacitors on the AC power board to provide a precision low frequency (16-500 Hz) output. (See Figure 5-3 and Figure 5-5)

Three isolated 18V supplies provide power for the gate drives. The 18V is regulated down to 15V by three TO220 regulators that are mounted on three discrete sheet metal heat sinks. If the 15V is in regulation, an LED will be lit in front of each heat sink. There is a red, a green and an orange LED, one for each supply. The other four green LED's will be lit when there is gate drive present at the IGBT's. If the green LED's are not lit there will be no gate drive and hence no output.

## 5.9 Input/Output Board

The input/output board holds a lot of the large components and provides interconnection between the AC input, the DC-DC board, the AC power board and the output without the use of heavy cables. The output relay and the output current metering circuit are also mounted on this board. The output AC inductors, the DC-DC transformer and the DC output choke are mounted on brackets behind the input/output board. These brackets also provide support for the input/output board.

Figure 5-5: AC Power Stage Layout

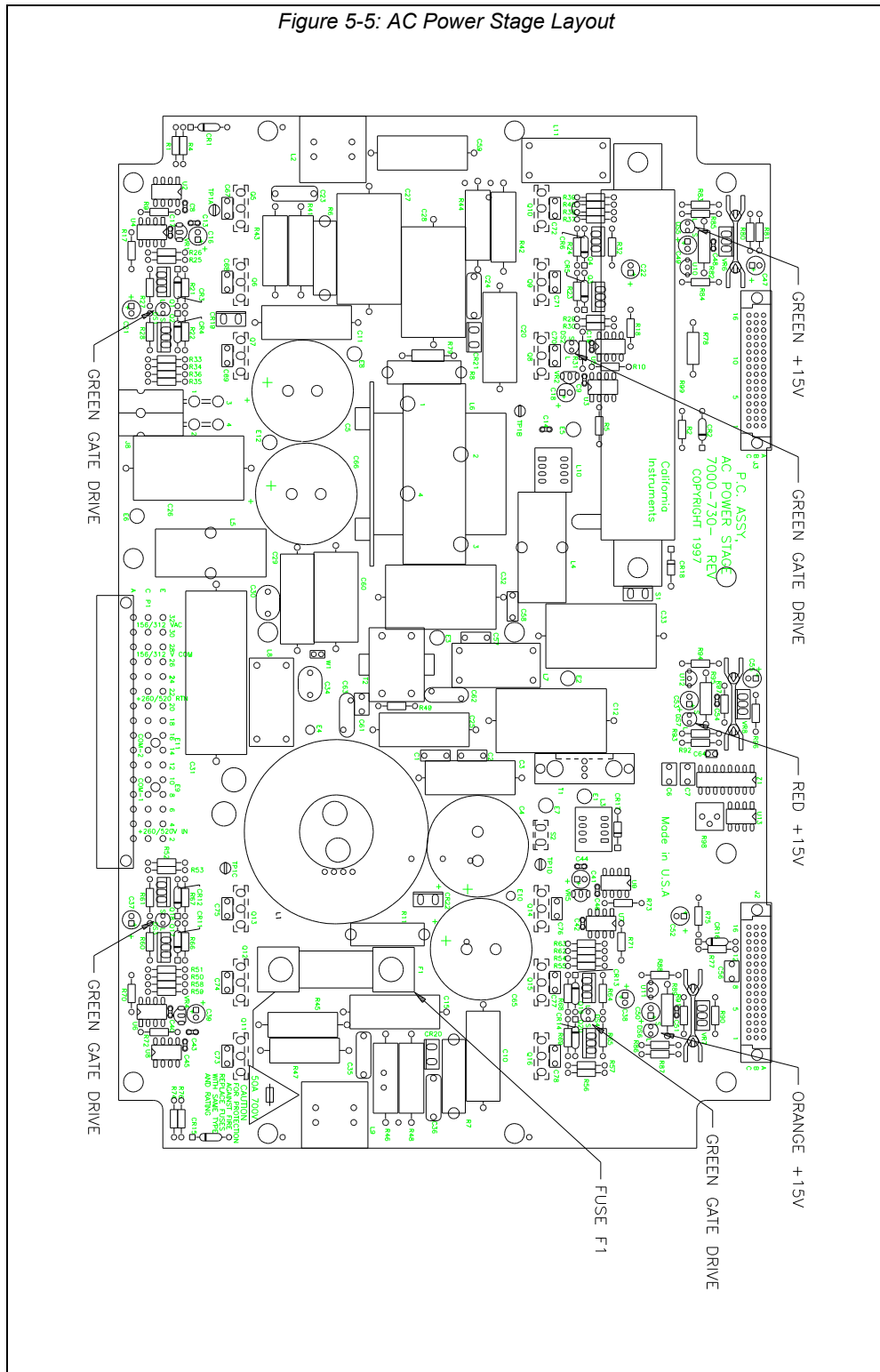
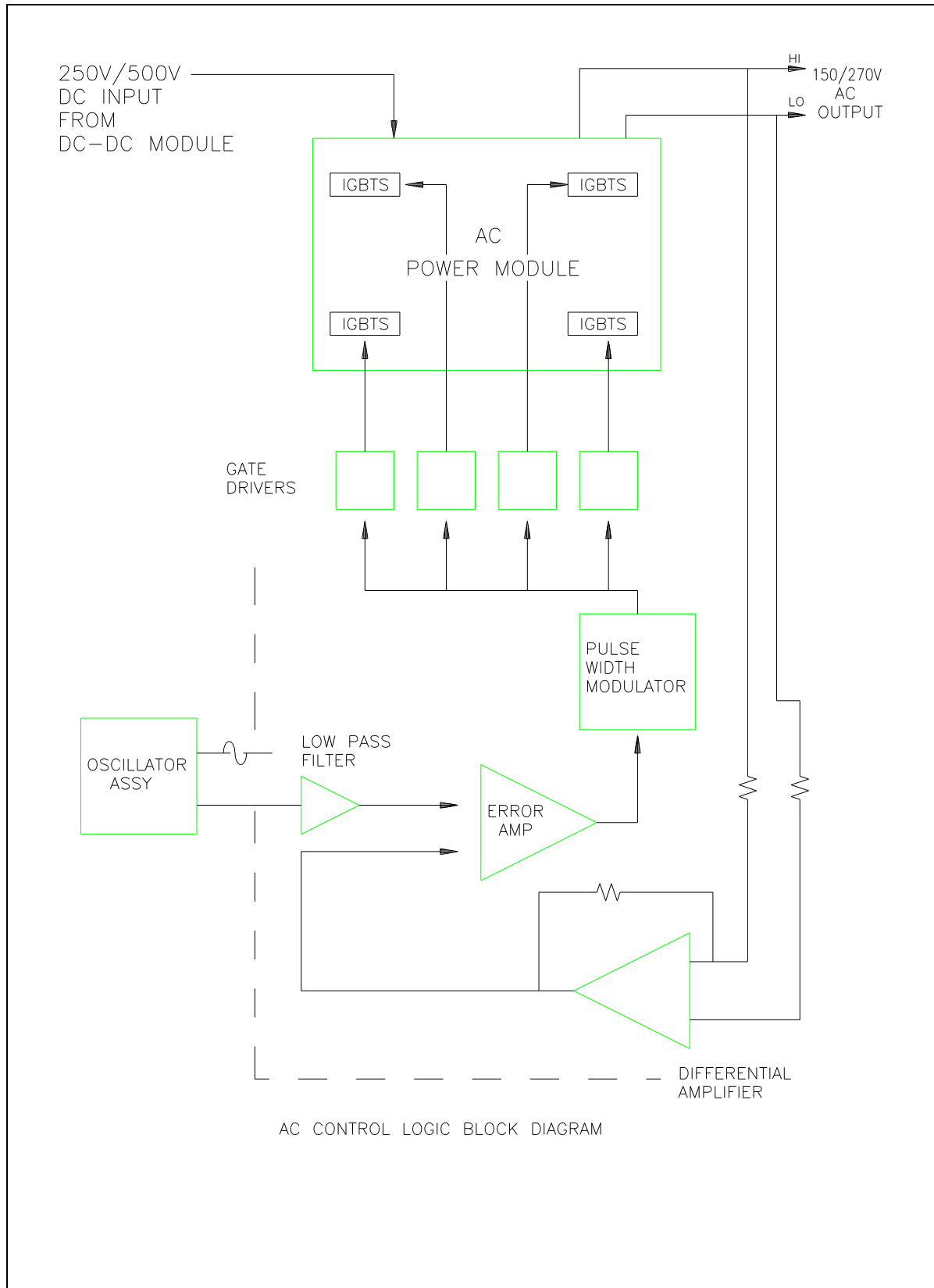
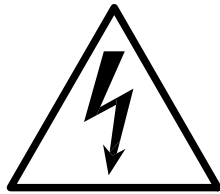

Figure 5-6: AC Control Logic Block Diagram





## **CAUTION**

**VOLTAGES UP TO 480 VAC AND 700 VDC ARE PRESENT IN CERTAIN SECTIONS OF THIS POWER SOURCE. THIS EQUIPMENT GENERATES POTENTIALLY LETHAL VOLTAGES.**



## **DEATH**

**ON CONTACT MAY RESULT IF PERSONNEL FAIL TO OBSERVE SAFETY PRECAUTIONS. DO NOT TOUCH ELECTRONIC CIRCUITS WHEN POWER IS APPLIED.**

## 6. Calibration

---

The Routine Calibration should be performed every 12 months. Non-routine Calibration is only required if a related assembly is replaced or if the periodic calibration is unsuccessful.

All standard models and configurations of the iX /i / iM Series may be calibrated using a PC running Windows 2000/XP, and the latest version of the CIGuiSII AC source control software. Refer to the CIGuiSII online help file of the CIGUISII software for additional procedures and guidance. To download the latest version of the CIGUISII, visit [www.programmablepower.com](http://www.programmablepower.com).

For iM Series II model calibration, refer to the I Series II model information in this chapter.

### 6.1 Calibration Equipment

---

Digital Phase Meter:	Krohn-Hite, Model 6620 or equivalent. (0.01° resolution, 0.02° accuracy.)
Digital Multimeter:	Fluke 8506A or equivalent. HP 34401A
10 milliohm Current Shunt:	Isotek Model RUG-Z-R010-0.1 or equivalent
1 milliohm Current Shunt: (10001i/iX, 15001i/iX and 15003iX-MODE):	Isotek Model RUG-Z-R001-0.1
Load Bank:	Various high power load resistors will be needed.
Computer (Optional)	PC to operate California Instruments GUI.

### 6.2 Calibration Screen Access

---

#### Output

To access the OUTPUT CALIBRATION screen for the first time press the MENU key twice to display the MENU 3 screen. Press the ↑ or ↓ key several times to highlight OUTPUT CAL. Press the ENTER key.

Type 5000 and press the ENTER key to show the OUTPUT CALIBRATION screen.

Press the PHASE key to select the phase to be calibrated for a 9003i/iX , 10002i/iX or 15003i/iX power system.

#### Measurements

To show the MEASUREMENT CALIBRATION screen follow the steps in paragraph 6.2.

Select the MEASUREMENT CAL function instead of OUTPUT CAL from the MENU 2 screen.

If another CALIBRATION screen has been accessed since power-up no password is needed. If prompted for a password, use the value 5000.

### 6.3 Routine Measurement Calibration

**Note: The Fluke 8506A Digital Multimeter must be used for the following calibration. The 8506A must be set to the AC HI ACCUR mode for all AC measurements.**

Connect the test equipment to the power source as shown in Figure 6-2. If the power system is a multi-phase system with one controller, the DVM for calibrating the measurement voltage should always be connected to the Remote Sense connector (TB3) on the Phase A power source.

The shunt must be connected to the power source as shown in Figure 6-1. If the Current measurement can't be successfully performed, adjust the Current Measurement Pot. This adjustment is described in the Non-routine Calibration section of this manual. If the DC current measurement displays more than 70 counts on the display, perform the non-routine current monitor adjustment.

Connect the load to the output. Recommend current shunt values are 0.010 ohm for 3001/5001/9003/15003 and 0.001 ohm for 10001, 15001.

To calibrate all measurement functions, the desired value for the measurement value of current or voltage must be entered for the corresponding calibration value. Make the indicated adjustments by typing in the desired display value. This should be the value indicated by the external DVM. If a 10 milliohm current shunt is used for current, 300 mV represents 30 amps.

The Measurement Calibration Table is a summary of the measurement calibration procedure. The following text is a detailed explanation of the procedure.

PARAMETER	POWER SYSTEM			
	3001 / 9003	5001 / 15003	10001 / 30003	15001
AC Current Full-Scale	6.0 $\Omega$ , 3 KW	3.6 $\Omega$ , 5 KW	1.8 $\Omega$ , 10 KW	1.3 $\Omega$ , 15 KW
DC Current Full-Scale	13.5 $\Omega$ , 1.5 KW	4.8 $\Omega$ , 3.5 KW	2.4 $\Omega$ , 7 KW	1.6 $\Omega$ , 10.5 KW

Table 6-1: Calibration Load For Each Phase

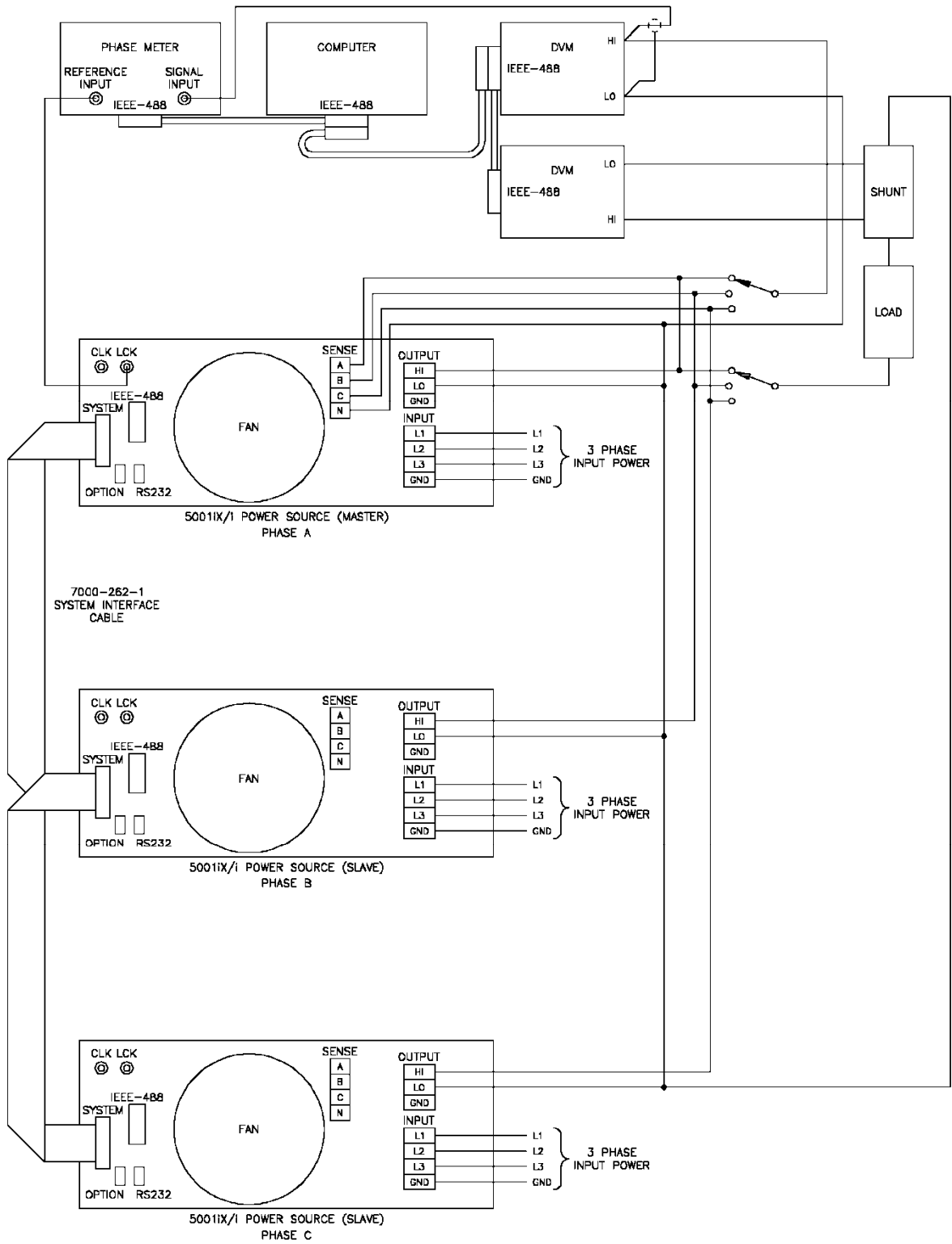

Figure 6-1: Test Equipment Hook-up for Measurement Calibration

---

**Note: The Fluke 8506A Digital Multimeter must be used for the following calibration. The 8506A must be set to the AC HI ACCUR mode for all AC measurements.**

---

**AC Volt Full-scale:**

1. Select the AC mode of operation.
1. Program the output to the 300 VAC range. Close the output relay.
2. Program the output to 240 volts and 60 Hz.
3. Go to the MEASUREMENT CALIBRATION screen.
4. Enter the actual AC output voltage for the VOLT FS parameter and press the ENTER key.
5. Allow the controller to complete the calibration cycle. This may take several minutes.
6. When completed, the new cal coefficient will be displayed.
7. Press the SET key to save the new calibration coefficients.

**AC Current Full-scale:**

2. Select the AC mode of operation.
3. Apply a load to the output. Refer to Table 6-1.
4. Program the output to 135 VAC and 60 Hz on the 150 Volt AC range.
5. Observe the actual output current and enter this value for the CURR FS parameter. Press the ENTER key.
6. Allow the controller to complete the calibration cycle. This may take several minutes.
7. When completed, the new cal coefficient will be displayed.
8. Press the SET key to save the new calibration coefficients.

**DC Volt Full-scale:**

1. Select the DC mode of operation.
2. Program the output to the 400 VDC range. Close the output relay.
3. Program the output to 320 volts DC.
4. Go to the MEASUREMENT CALIBRATION screen.
5. Enter the actual DC output voltage for the VOLT FS parameter and press the ENTER key.
6. Allow the controller to complete the calibration cycle. This may take several minutes.
7. When completed, the new cal coefficient will be displayed.
8. Press the SET key to save the new calibration coefficients.

**DC Current Full-scale:**

1. Select the DC mode of operation.
2. Apply a load to the output. Refer to Table 6-1.
3. Program the output to 120 VDC on the 200 Volt DC range.
4. Observe the actual output current and enter this value for the CURR FS parameter. Press the ENTER key.
5. Allow the controller to complete the calibration cycle. This may take several minutes.



6. When completed, the new cal coefficient will be displayed.
7. Press the SET key to save the new calibration coefficients.

TITLE	PROGRAM / LOAD PARAMETERS	PARAMETER	ADJUST TO
AC Volt Full-scale	240 VAC, 60 Hz	VOLT FS	$V_{ac}$
AC Current Full-scale	150 Range, 135 VAC, full load	CURR FS	$I_{ac}$
DC Volt Full-scale	320 VDC	VOLT FS	$V_{dc}$
DC Current Full-scale	200 Range, 120 VDC, full load	CURR FS	$I_{dc}$

*Table 6-2: Measurement Calibration Table*

For a multi-phase power system that uses one controller, 9003i/iX, 10002i/iX, 15003i/iX or 30003i/iX, repeat paragraph 6.3 for each phase. Move the external test equipment to the phase that is being calibrated. Refer to Figure 6-1.

While viewing the calibration screen, press the PHASE key to select the respective phase.

## 6.4 Routine Output Calibration

Connect the test equipment to the power source as shown in Figure 6-2. If any output parameter can't be calibrated refer to the Power Source Gain Adjustment in the Non-routine Output Calibration section of the manual.

The AC output calibration does not require an AC DVM operating with the highest accuracy. Either a Fluke 8506A or a HP 34401A may be used. If a HP 34401A is used it must be put into the slow filter mode.

1. Connect the DVM across the Phase A output terminals and set to VDC mode.
2. To show the **OUTPUT CALIBRATION** screen for the first time, choose **OUTPUT CAL** from the **MENU** screen.
3. Type **5000** as the password.
4. Press the **PHASE** key to select the phase to be calibrated.
5. All output adjustments will be made in the **OUTPUT CALIBRATION** screen.
6. If the VOLT FS coefficient for the selected phase is considerably different from 21000, enter 21000 using the numeric keypad.
7. Program the power source to the AC mode, ALC OFF, 300V AC range and 0.0 V.
8. Close the output relay (Output ON)
9. Adjust the VOLT ZERO for minimal DC offset.
10. Change the DVM to VAC mode and program 240VAC, 60 Hz.
11. Adjust the VOLT FS cal coefficient up or down until the DVM reads 240Vac  $\pm$  0.10 VAC.
12. Press the SET key to save the new coefficient values.
13. Repeat this test for the Phase B and C outputs respectively.

Summary output calibration table:

TITLE	PROGRAM VALUES	CALIBRATION VALUE	ADJUST TO
High VAC range DC Zero	300V range, 0.0 V	VOLT ZERO	0 $\pm$ 15 mv DC
High VAC range Volt FS	240.0 V, 60 Hz	VOLT FS Hint: This value should be around 21000. For a quick adjustment first program this value with the keypad.	240 $\pm$ 0.10 VAC

Table 6-3: Output Calibration Table

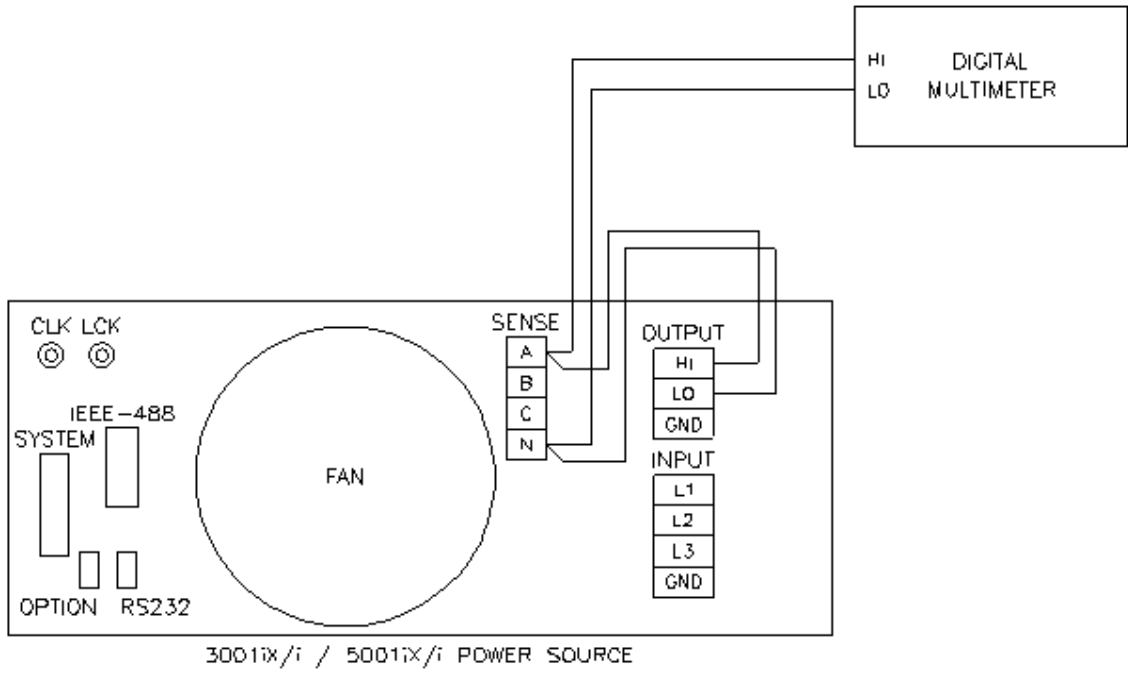

Figure 6-2: Test Equipment Hookup for Routine Output Calibration

## 6.5 Output Impedance Calibration

---

**Note: Applies to 3001iX, 5001iX, 9003iX, and 15003iX models only.**

---

For the output impedance calibration, one or two HP 34401A DMM's or equivalent may be used. The following modes must be programmed: 6 digits, AC Filter, slow: 3 Hz and 6 digits. One DMM is used to measure the output voltage, one to measure the load current using a suitable CT. A single DMM may be switched between front and rear inputs to toggle between voltage and current measurements.

The calibration should be done for each phase individually. Furthermore, an accurate phase meter with at least  $0.01^\circ$  resolution is needed. (See equipment list section 6.1). The reference input of the phase meter must be connected to the LOCK output of the controller at the rear panel of the master 5001iX chassis. This is a square wave TTL signal. Select Square wave input on the phase meter. The other input of the phase meter must be connected at the AC source output of the phase being calibrated. Select Sine wave input on the phase meter for this input. Note that this is a 230 Vrms signal so the Phase Meter must have sufficient input range on this input. The phase meter is used to determine the phase shift between no load and full load conditions ( $\Delta\Phi$ ).

The readings from the DMM's and Phase meter should be written down to aid with calculations. A calculator is used to calculate the R and L portions of the impedance using the formulas shown in Table 6-5.

To verify or adjust the programmable impedance function, proceed as follows for each phase:

1. Program the power source to 230.0VAC and 50Hz.
2. Program the output impedance resistance and inductance to the lowest values from the OUTPUT IMPEDANCE screen. This will be the IMP. REAL MIN and IMP. REACT MIN values that have been set in the OUTPUT CAL screen. Press the PHASE key to select the phase to be calibrated. (A, B or C).
3. Measure the output voltage of the power source with no load and record this value ( $V_{NL}$ ).
4. Using a resistive load bank, load the output of the power source to about 16 amps. Measure the output voltage of the power source under load and record this value ( $V_L$ ). Also measure the load current and record this value. (I).
5. Calculate the resistive and inductive component R and L using the formulas shown in Table 6-5.
6. Enter these values, in the OUTPUT CAL screen for the IMP. REAL MIN and IMP. REACT MIN value respectively. Make sure the correct phase is selected or use the PHASE key if not.
7. Remove or turn off the load.
8. From the MENU 3 screen, select OUTPUT IMPEDANCE. Press the PHASE key to select the phase to be calibrated. Program the output inductance to 796  $\mu$ H and the resistance to 400 mOhms.
9. Select the Calibration, Output screen and move the cursor to the IMP REAL FS field. Measure the R and L by removing and applying the load as described before and calculating the R and L using the formula's in Table 6-4.  
Adjust the resistive output impedance using the shuttle until the measured output is as close as possible to 400 mOhm. Make sure the correct phase is selected or use the PHASE key if not. Do the same with the IMP REACT FS field. Note that the adjustment range for R is 0 to 100, for L is 0 to 300.
10. If there is not enough range in the full-scale calibration coefficient for either resistive or inductive portion, it may be necessary to tweak the adjustment pots on the iX controller.

These pots were originally adjusted at the factory and normally do not have to be adjusted again. The Full Scale calibration coefficients should have enough adjustment range. Double check the connections and phase measurements if this is not the case to make sure the measurement readings you get are indeed correct.

If it is necessary to adjust the pots, see Table 6-4 for the corresponding pot designators. The top cover has to be removed to access these pots. They are located along the top edge of the 7003-718 controller board.

11. Repeat steps 2 through 10 for phase B and C. (except on single phase only models.)

Phase / Board Assembly #	R resistive	XI inductive
Phase A (7003-718-1 / 7003-718-3)	R121	R122
Phase B (7003-718-1)	R112	R111
Phase C (7003-718-1)	R114	R115

Table 6-4: Programmable Z adjustment pots

Definitions:

$V_{NL}$  = Measured RMS voltage under no load.

$V_L$  = Measured RMS voltage under load

$I$  = Measured RMS current.

$F$  = Source frequency (50 Hz).

$\Delta\Phi$  = Phase angle shift between load and no load conditions. Record phase angle from phase meter under NL and L condition and determine phase shift.

Formulas to calculate R and L component of output impedance:

$$R = (V_{NL} * \cos(\Delta\Phi) - V_L) / I$$

$$X_L = (V_{NL} * \sin(\Delta\Phi)) / I$$

$$L = X_L / (2 * \text{Pi} * F)$$

Table 6-5: Formulas to calculate R and L

---

## 6.6 Non-Routine Calibration

---

All internal adjustments are set at the factory at the time of original shipment. As such, non-routine calibration is generally not required unless one or more amplifier assemblies have been replaced in the field. In this case, perform the following sections in the order shown.

The non-routine calibration involves removing the top cover from the power source. Remove the line power from the power source before removing the top cover. Most of the adjustments are on the Current Limit Assembly. One adjustment is on I/O Board Assembly. Refer to Figure 6-3 for the location of the adjustments.

---

### 6.6.1 DC Offset Adjustment

---

1. Turn off the AC input power to the power source using the front circuit breaker. Not that AC voltage is still present inside the unit so **DO NOT** touch the contacts of the circuit breaker inside the unit.
2. Connect a 22  $\mu$ F tantalum capacitor in series with a 100k $\Omega$  1% resistor across the output.
3. Connect a DVM to read DC volts across the capacitor.
4. Short test point TP1 to test point TP6 on the Current Limit Board using a jumper wire.
5. Power up the unit in AC mode, 150 VAC range, 0.0 V programmed and close the output relay. Adjust the DC offset to 0.0 mVDC  $\pm$ 5.0 mVDC using R95 on the AC Logic Board.
6. Remove short on the Current Limit Board.
7. Open the output relay when done.

---

### 6.6.2 Current Monitor Offset Adjustment

---

1. Select Phase A.
2. Program the 300 VAC range, 0.0 volts, and turn the Output ON.
3. On the current limit board, monitor test point TP5 with respect to test point TP1 (common) using a DMM in VDC mode.
4. Adjust R23 on the input/output board for 0.0 mVDC  $\pm$  0.5 mVDC on TP5.
5. Cycle the AC input power using the front panel circuit breaker.

---

**CAUTION:** Use extreme care in adjusting R23. Do not touch any connections on the Input/Output Board Assy. Dangerous voltages exist on most exposed connections.

---

---

**6.6.3 Power Source Gain Adjustment:**

---

To make this adjustment the top cover must be removed and voltages must be monitored at various test points. The test point used depends upon the phase (chassis) to be adjusted. The adjustment is R14 on the Current Limit Board. Refer to Figure 6-3 for the location R14 on the Current Limit Board.

1. Monitor the AC output of the Phase A power source using a DMM in VAC mode.
2. Turn the ALC mode OFF in the UTILITY, VOLTAGE CURRENT control screen of the master power source. The ALC mode would interfere with this adjustment if left ON.
3. Select AC mode, high voltage range and program 240 VAC.
4. Program the frequency to 60 Hz.
5. Record the output voltage with the external AC DVM. Make no adjustment at this point.
6. Now program 400 Hz and adjust R14 to the AC output recorded in step 5.
7. Repeat steps 4 through 6 until the voltage at 400 Hz is within  $\pm 1.0$  VAC of the voltage at 60 Hz.

For multiphase power systems with one controller, 9003i/iX, 10002i/iX or 15003i/iX, the adjustment for Phase B and C must be made to R14 on the Current Limit Board for the power source chassis of the respective phase.

For 30003i/iX systems, the adjustment must be made to all six chassis' current limit boards.

---

**6.6.4 Output Adjustment:**

---

Connect the test equipment to the power source as shown in Figure 6-2. The AC output calibration does not require an AC DVM operating with the highest accuracy. Either a Fluke 8506A or a HP 34401A may be used. If a HP 34401A is used it must be put into the slow filter mode.

Proceed as follows:

1. Program the power source to the AC mode, ALC OFF,
2. Select the Low AC voltage range (150VAC range)
3. Program 10VAC and 60 Hz.
4. Connect the AC DVM across the Phase A output terminals.
5. Close the output relay (Output ON)
6. Adjust R234 on the Controller to obtain a 10 VAC reading on the DVM.
7. Repeat this test for the Phase B and C output terminals but adjust R235 for Phase B and R236 for Phase C. The DMM connections must be moved to phase B and phase C respectively.

Next, perform the output calibration as shown in 6.4.

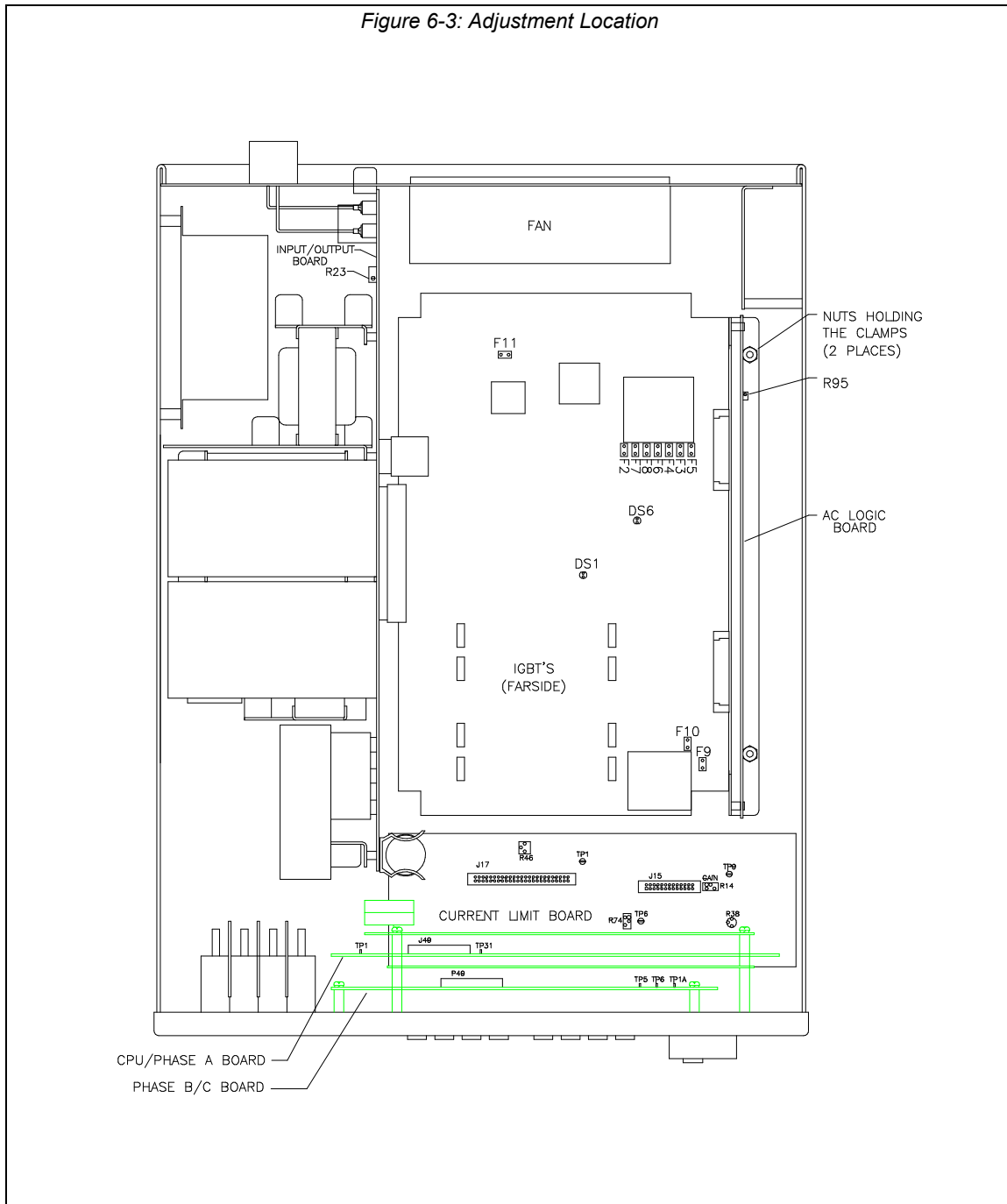

### 6.7 Inter Harmonics Generator Option (-413 OPTION)

Refer to **Error! Reference source not found.** for the locations of the adjustment pots on the Aux. Waveform Generator. (CI P/N 7003-719-1).

1. Program the output to 0.0 VAC with output relay closed. Verify that after first initial start-up, voltage is zero with no modulation on the output waveform.



2. Select **INTER HARMONICS** the **MENU 2** screen. The following values will be displayed:

INTER HARMONICS	
REF. VOLT = 0.0 VAC	FREQUENCY = 400 Hz
VOLTAGE = 0.0 %	REF. COUPL = OFF
	REFERENCE = OFF

3. Select **REFERENCE** and program **ON** with the shuttle.
4. Select **REF VOLT** and program 230.0.
5. Select **VOLTAGE** and program 8.7%.
6. Select **FREQUENCY** and program 400 Hz. This combination of values should generate a 20.0 volt output from the **AUX.** Generator.
7. Adjust the respective pot for the output phase being calibrated for a 20.0 volt output on the external **AC DVM.**

PHASE	ADJUSTMENT POT
A	R9
B	R10
C	R11

8. For LF and FC option, Select the program screen and set all three phases current limit to 0.3A
9. Select **FREQUENCY** in the **INTER HARMONIC** screen and program the frequency to 1500 Hz.
10. Select the **OUTPUT CALIBRATION** screen.
11. Select the **INTER HARM FS** value.
12. Use the shuttle to calibrate the output voltage to 20.00 volts rms.
13. Record the output voltage for Phase A, and B and C if applicable.
14. Select the frequency in the INTER HARMONIC screen and set to 500 Hz or lower. Select **REFERENCE** and program **OFF** with the shuttle.
15. Select the PROGRAM Screen and set the current limit its nominal value.

## 7. Service

---

### 7.1 Cleaning

---

The exterior of the power source may be cleaned with a cloth dampened with a mild detergent and wrung out. Disconnect mains power to the source before cleaning. Do not spray water or other cleaning agents directly on the power source.

### 7.2 General

---

This section describes the suggested maintenance and troubleshooting procedures. The troubleshooting procedure is divided into two sections. The first section deals with basic operation and connection of the equipment. The second section requires opening the unit and

using the LED indicators and a simple multimeter to troubleshoot the unit down to the module level. Only a qualified electronic technician should attempt this level troubleshooting.

### 7.3 Basic operation

Table 7-1: Basic Symptoms

PARAGRAPH	PROBLEM
7.3.1	Excessive Output Voltage
7.3.2	Poor Output Voltage Regulation
7.3.3	Overload Light On
7.3.4	Distorted Output
7.3.5	Unit Shuts Down After 1-2 Seconds
7.3.6	No Output and no lights on front panel
7.3.7	No output but "power on" LED on front panel is lit.

#### 7.3.1 Excessive Output Voltage

CAUSE	SOLUTION
External sense not connected	Connect the external sense to the AC power outlet TB2.

#### 7.3.2 Poor Output Voltage Regulation

CAUSE	SOLUTION
Unit is overloaded	Remove overload
Unit is programmed to wrong voltage range.	Select correct voltage range.
Input line has fallen below spec. limit.	Check supply voltage.

#### 7.3.3 Overload Light is On

CAUSE	SOLUTION
Unit is overloaded	Remove overload
Unit is switched to high voltage range.	Select correct voltage range.

#### 7.3.4 Distorted Output

CAUSE	SOLUTION
Power source is grossly overloaded.	Reduce load
The crest factor of the load exceeds 3:1 on the low range or 5:1 on the high range.	Reduce load current peaks by reducing load.

#### 7.3.5 Unit Shuts Down after 1-2 Seconds

CAUSE	SOLUTION
Output shorted	Remove output short
Output grossly overloaded.	Remove overload.
Operating load with too high inrush or start	Consult factory for application advice.

CAUSE	SOLUTION
up currents.	

### 7.3.6 No Output and No Lights on Front Panel

---

CAUSE	SOLUTION
Input circuit breaker switched off.	Switch the breaker on.
No input power to TB3.	Ensure 3 phase power is getting to TB3.
Unit tripped on overvoltage or overcurrent.	Turn circuit breaker off - wait five seconds - turn circuit breaker back on.

### 7.3.7 No Output But “Power On” LED on Front Panel is Lit

---

CAUSE	SOLUTION
“OUTPUT ON” switch is turned off.	Turn OUTPUT ON switch to “ON”.
REMOTE SHUTDOWN logic line at J22 pin 36 is shorted to D COM or A COM.	Remove connection from J22 pin 3.
Current limit programmed down or to zero.	Program current limit higher.
Voltage programmed down or to zero.	Turn amplitude control up.
Unit tripped on overvoltage or overcurrent.	Turn circuit breaker off - wait five seconds - turn circuit breaker back on.

---

## 7.4 Advanced Troubleshooting.

---



**WARNING:** Do not connect 400-480V into the 208-240V unit, the result could be a severely damaged unit.

---



**CAUTION:** VOLTAGES UP TO 480 VAC AND 700 VDC ARE PRESENT IN CERTAIN SECTIONS OF THIS POWER SOURCE.

---



**WARNING:** THIS EQUIPMENT GENERATES POTENTIALLY LETHAL VOLTAGES. DEATH ON CONTACT MAY RESULT IF PERSONNEL FAIL TO OBSERVE SAFETY PRECAUTIONS. DO NOT TOUCH ELECTRONIC CIRCUITS WHEN POWER IS APPLIED

---

### 7.4.1 Switch Off Unit

---

Switch of the unit at the circuit breaker on the front panel as well as removing the input power from the unit.

---



**WARNING:** Wait 10 minutes for all internal capacitors to discharge.

---

### 7.4.2 Removing Top Cover

---

Remove the screws securing the top cover and remove the top cover.

### 7.4.3 Initial Inspection

---

Make a visual inspection of the unit and ensure all the connectors are properly mated and there are no loose or broken wires.

---

#### 7.4.4 Fuse Check

---

See Figure 5-3 and Figure 5-5. Check the fuse F1 on the AC power board at the top of the unit using the ohmmeter. If the fuse is open do not replace but check all the IGBT's. To check the IGBT's connect the positive lead of the ohmmeter to the collector (center leg) and measure the resistance to the gate and the emitter (outside legs) of each IGBT. If the resistance reading is lower than 1000 ohms it indicates a blown IGBT. The IGBT's are not field replaceable and the module should be returned to the factory for exchange or repair. See paragraph 7.4.6. for disassembly instructions. If a low resistance reading is not found, replace the fuse and proceed with the check procedure.

Check the fuse F1 on the end of the input/output board. If the fuse is blown do not replace but proceed to paragraph 7.4.6 for disassembly instructions and remove the AC power board. With the AC power board removed check the IGBT's Q2 through Q9 using the procedure detailed in the paragraph above. See Figure 6-1: Internal Top View of DC-DC Converter Board.

If one or more IGBT's show a low resistance reading do not replace the fuse but return the module to the factory for exchange or repair. If a low resistance is not found, replace the fuse and carry on with the check procedure.

---

#### 7.4.5 Power-on Troubleshooting Using the LED's.

---

If no fuses were blown or if fuses were found blown but all the IGBT's checked out as good, replace blown fuses and reconnect power to the unit.



**WARNING:** *Do not touch any parts inside the unit during this test as they will be live and dangerous. Always wear safety glasses.*

---

**Auxiliary PS:** Turn the main breaker on and check the LED's on the AC logic board.(see Figure 5-4). The +15V (DS2-red), -15V (DS3-green), and the 24V (DS7-amber) LED's located at the top right of the board should all be lit. The 8V logic supply LED (DS4- red) should be lit. On the AC power board (see Figure 5-5) the three gate drive power supply lights, DS5-green, DS6-amber, and DS7-red, should all be lit. If any of these LED's are not lit then the most likely cause is a blown fuse. These logic power fuses are all located on the DC-DC board. Switch the unit off at the front panel breaker **and** remove the input power.

***Wait 10 minutes to allow the capacitors to discharge before attempting to disassemble the unit.***

Proceed to paragraph 7.4.6. for disassembly instructions. Remove the AC power board and locate the P.C. mount fuses F2 through F10 (see Table 7-2 for fuse functions). Replace any blown fuses. Always replace fuses with same type and rating. (See Table 8-2.)

FUSE #	FUNCTION	FUSE VALUE
F2	DC-DC Converter logic	1 amp
F3	18V - AC gate drive (2)	1 amp
F4	18V - AC gate drive (3)	1 amp
F5	18V - AC gate drive (1)	1 amp
F6	24V Fan and relay power.	3 amp
F7	+15V logic power	1 amp
F8	-15V logic power	1 amp
F9	8V Front panel meter power	1 amp
F10	+8V logic power	3 amp
F11	Auxiliary power supply input fuse.	10 amp

Table 7-2: Auxiliary Power Supply Fuse Ratings

Fuse F9 supplies power to the front panel meter. If F9 blows then there is no readout. If no LED's are on at all, then the auxiliary power supply may have failed. Check F11 and replace if necessary. If none of these fuses has blown proceed to the next step.

**DC-DC Converter:** The output of the DC-DC converter 250V/500V will light the LED that is located directly down between the large storage capacitor and the input/output board (see Figure 5-3). This LED should be lit. If this LED is not lit, but the other auxiliary power supply LED's are lit, then check F2 on the DC-DC board. See Table 7-2 and the preceding paragraph.

If no failures have been found to this point, then the AC power board has high power input and gate drive power. The gate drives on the AC power board should all be present (see Figure 5-5). These are the green LED's DS1 through DS4. They should all be lit. If they are not lit then the gate drive has been inhibited. Recheck paragraph 7.3.7.

**Oscillator:** If the LED's DS1 through DS4 on the AC Power Board are lit and there is still no output then there may be no output from the oscillator. To check the oscillator output, turn off the unit at the main breaker. Set the DVM to AC volts and connect the meter to Test Point 2 (TP2) with the return on TP1. See Figure 5-4. TP2 is in the center of the AC logic board and TP1 is at the top left. Turn the breaker back on. There should be a reading on the meter which can be varied from 0 to 5 volts by programming the output from zero to 300V. If no reading is present, check the output at the CPU/Phase A Board. Check the signal between TP29 and TP1 (return) on the CPU/Phase A Board. **Switch power to the unit off before relocating probes.**

If a signal is present at the CPU/Phase A Board but not at the AC Logic Board then the fault is in the wiring or the current limit board. Check the continuity of cables from the oscillator to the AC logic board. If there is no signal at TP29 then recheck the inhibit at paragraph 7.3.7 or replace the oscillator assembly. The presence of the oscillator signal at the AC logic board would indicate a fault in the output relay or output wiring. See Figure 5-2.

**AC output: Switch unit off** - Check that P1 on the AC power board is making good contact with its mating half and J8 (the output to the AC smoothing inductors) is firmly engaged. Switch the unit back on and operate the power on/off switch on the front panel. Listen to hear if the relay operates. If the relay does not operate replace the input/output board. If it does, check the continuity of the output wiring.

If the problem with the unit has not been isolated, contact the factory for assistance.

#### 7.4.6 Disassembly Procedure

---

Disconnect mains power to the source and ***wait 10 minutes to allow the capacitors to discharge before attempting to disassemble the unit.*** Remove the top cover, unplug P7 from the current limit board, and unplug the fan from the AC logic board connector. Then carefully unplug the AC logic board from the AC and the DC power boards. The AC logic board can then be lifted from the unit.

Using a 5/16 inch socket driver remove the four bolts that hold the AC power module heat sink. There is one bolt at each corner. Carefully remove all the hardware from the unit. The AC power module can now be unplugged from the input/output board and removed from the unit.

The DC - DC module can be unplugged by first removing the two nuts holding the clamp that secures the heat sink to the chassis. See figure 5.3. Care must be taken in unplugging the two connectors P4 and J12.

To reassemble, reverse the above procedure, taking care to ensure J12 on the DC-DC board and J8 on the AC board are properly mated. This may entail supporting the connector from behind with a screwdriver.

## 8. Top Assembly Replaceable Parts

<u>Top Assy. No USB</u>	<u>Top Assy incl. USB</u>	<u>Model</u>
7000-482-1	7000-485-1	3001iX
7000-482-4	7000-485-4	3001i / 3001iM
7000-474-1	7000-486-1	5001iX, 208 VAC INPUT
7000-474-2	7000-486-2	5001iX, 400 - 480 VAC INPUT
7000-474-3	7000-486-3	5001i / 5001iM, 208 VAC INPUT
7000-474-4	7000-486-4	5001i / 5001iM, 400-480 VAC INPUT

### 8.1 Sub assemblies

#	CI PART #	DESCRIPTION	VENDOR	QTY
A1	7000-725-1	240V - I/O PC ASSEMBLY	CI	1
A1	7000-726-1	480V - I/O PC ASSEMBLY	CI	1
A2	7000-419-1	AC POWER MODULE, 3001iX	CI	1
A2	7000-419-2	AC POWER MODULE, 5001iX	CI	1
A3	7000-420-1	240V - DC - DC POWER MODULE, 5001i/iX	CI	1
A3	7000-420-2	240V - DC - DC POWER MODULE, 3001i/iX	CI	1
A3	7000-479-1	480V - DC - DC POWER MODULE	CI	1
A4	7000-732-1	LOGIC BOARD PC ASSEMBLY , 3001iX	CI	1
A4	7000-732-2	LOGIC BOARD PC ASSEMBLY , 5001iX	CI	1
A6	7000-724-3	CURRENT LIMIT PC ASSEMBLY	CI	1
2	7000-474-11 THRU -30	PROGRAMMABLE OSC. FRONT PANEL ASSY.	CI	1
A10	7000-727-1	IEEE 488/RS232 BOARD, REV C or higher. (For P/N 7000-474 and 7000-482)	CI	1
A10	7000-741-1	IEEE 488/RS232/USB BOARD. (For P/N 7000-485 and 7000-486)	CI	1
A10	7000-741-2	IEEE 488/RS232/USB & -LAN BOARD (For P/N 7000-485 and 7000-486)	CI	1
B1	241183	FAN 6 INCH--JD24B2	Rotron	1
F1	270199	FUSE 50A, 700V, AC BOARD	Bussman FWP-50A14F	1
F1	270184	FUSE 30A 700V I/O BOARD	Bussman-KPB30	1
K1	245217	RELAY ON CHASSIS. KUHP-5DT1-24	Potter & Brumfield	1
F <sub>MISC</sub>	270183	P.C. FUSES ON DC-DC BD, 3A F <sub>6</sub> ,F <sub>10</sub>	Bussman PCC-3	3
F <sub>MISC</sub>	270174	P.C. FUSES ON DC-DC BD, 1A F <sub>2</sub> -F <sub>5</sub> , F <sub>7</sub> -F <sub>9</sub>	Bussman PCC-1	6
CB1	270186	INPUT CIRCUIT BREAKER 35A (240V), 5001i/iX	AIRPAX 205-1111- 28051-2	1
CB1	270196	INPUT CIRCUIT BREAKER 35A (250V), 3001i/iX	AIRPAX IELK21- 28851- 1-V	1
CB1	270207	INPUT CIRCUIT BREAKER 15A (480V), 5001i/iX	AIRPAX IELHK-1111- 30431-1-V	1

Table 8-1: Replaceable Parts



## 8.2 Fuses

SEQ#	CI PART #	DESCRIPTION
<b>DC - DC POWER ASSY. 7000-729 AND 7000-731</b>		
F2	270174	1 amp, 250 vac, quick acting
F3	270174	1 amp, 250 vac, quick acting
F4	270174	1 amp, 250 vac, quick acting
F5	270174	1 amp, 250 vac, quick acting
F6	270183	3 amp, 250 vac, quick acting
F7	270174	1 amp, 250 vac, quick acting
F8	270174	1 amp, 250 vac, quick acting
F9	270174	1 amp, 250 vac, quick acting
F10	270183	3 amp, 250 vac, quick acting
F11	270182	10 amp, 250 vac, time lag
<b>AC POWER ASSY. 7000-730</b>		
F1	270199	50 amp, 700 vac, very quick acting
<b>240 VOLT I/O ASSY. 7000-725</b>		
F1	270184	30 amp, 700 vac, very quick acting
F2	270183	3 amp, 250 vac, quick acting
F3	270183	3 amp, 250 vac, quick acting
<b>400 VOLT I/O ASSY, 7000-726</b>		
F1	270185	15 amp, 700 vac, very quick acting
F2	270183	3 amp, 250 vac, quick acting
F3	270183	3 amp, 250 vac, quick acting
F4	270183	3 amp, 250 vac, quick acting

Table 8-2: Fuses

## 9. Options

---

### 9.1 RTCA/DO-160 Option

---

The RTCA/DO-160 Option is made up of both firmware that resides in the power source and the CIGuiSII Windows application program. The firmware covers revision D, and the GUI covers revision E.

The user interface for each implementation is different however. The revision D tests can be operated directly from the power source's front panel or through the supplied GUI program. The Revision E tests can only be operated through the GUI windows software. Thus, for Rev E use, a Windows PC and interface is required.

Section 9.1.1 covers operation of the firmware based revision D tests.

For information regarding the operation of the DO160 revision E tests with the CIGuiSII, please refer to the Avionics Software Manual (CI part no. 4994-971 included on CDROM). Note that future updates of the CIGuiSII may include overlapping coverage for revision D in the software as the CIGuiSII program is designed to support all revisions. For now, revision D has no associated data files in the CIGuiSII but does have it's own user interface control screen.

#### 9.1.1 Option –160: RTCA/DO160 rev D Tests (Firmware)

---

##### 9.1.1.1 General

---

The RTCA/DO-160D option is capable of performing all sections of RTCA/DO-160D, Section 16 and EUROCAE-14D / RTCA DO160D, Section 16 for the AC Source signal. A selection is made available to specify the type of standard, and groups.

Throughout this document, Groups 1 through 3 will be used to refer to EUROCAE-14D standard.

##### 9.1.1.2 Initial Setup

---

Nominal parameters for the AC Power source are as follows:

Output Voltage	115V L-N or 230V L-N
Output Frequency	360 Hz to 800 Hz

Nominal parameters for the DC Power source are as follows:

Output Voltage	28V or 14V L-N
----------------	----------------

A setting outside these nominal values will disable the test and will prevent accessing to its Menu screens. To access the test for the 230V L-N, the power source must be capable of programming 360V.

---

**9.1.1.3 Tests Performed**

---

**9.1.1.3.1 NORMAL STATE****AC Source:**

1. Normal State Voltage and Frequency test
2. Voltage unbalance test
3. Waveform Distortion test
4. Voltage Modulation test
5. Frequency Modulation test
6. Momentary Power Interrupt (Undervoltage) test
7. Voltage Surge (Overvoltage) test
8. Frequency Transients test(Group 1 only)  
Frequency Variation test (Group 2 and 3 only)

**DC Source:**

1. Normal State Voltage test
2. Momentary Power Interrupt (Undervoltage) test
3. Voltage Surge and Under

**9.1.1.3.2 EMERGENCY TEST****AC Source:**

1. Emergency Voltage and Frequency minimum
2. Emergency Voltage and Frequency maximum
3. Voltage unbalance

**DC Source:**

1. Emergency Voltage

**9.1.1.3.3 ABNORMAL TEST****AC Source:**

1. Abnormal Voltage minimum
2. Abnormal Voltage maximum
3. Voltage Drop
4. Voltage Surge
5. Frequency Transients test (group 1 only)

**DC Source:**

1. Abnormal Voltage minimum
2. Abnormal Voltage maximum
3. Abnormal Voltage low
4. Voltage Drop
5. Voltage Surge

#### 9.1.1.4 Front Panel Entry

To perform a test from the keyboard, from the MENU 2 screen, select the APPLICATIONS screen. The APPLICATIONS screen will appear as shown in Figure 9-1.

APPLICATIONS SETUP	
MIL-STD-704	<b>RTCA/DO-160D</b>
OMIN OPTION	IEC 1000-4-11
PREVIOUS SCREEN	IEC 1000-4-13

Figure 9-1: Application Menu

Scroll to the RTCA/DO-160D entry using the up and down cursor keys. Press the ENTER key to select the RTCA/DO 160D main menu. The screen will appear as shown in Figure 9-2.

**Note:** The user has to turn on the Output relay before starting a test.

RTCA/DO-160D AC	
STANDARD =RTCA	<b>NORMAL STATE</b>
GROUP =1	ABNORMAL
PREVIOUS SCREEN	EMERGENCY

Figure 9-2: DO160 Main Menu

**9.1.1.5 AC TESTS**

Note: Prior to test selection the standard and the group selection are required. Use the shuttle to select the standard and the group if applicable.

**9.1.1.5.1 Normal state test**

Scroll to the NORMAL STATE AC entry using the up and down cursor keys. Press the ENTER key to select the NORMAL STATE screens. The screen will appear as shown in Figure 9-3.



Figure 9-3: Normal state

The DO160 NORMAL 1 and NORMAL 2 screens have the following tests:

- 1 VOLT FREQ MIN
- 2 VOLT FREQ MAX
- 3 VOLT UNBALANCE
- 4 WAVEFORM DISTORTION
- 5 VOLT MODULATION
- 6 FREQ MODULATION
- 7 POWER INTERRUPT
- 8 VOLTAGE SURGE
- 9 FREQ TRANSIENT (group 1)  
FREQ VARIATION (group 2 & 3)

The above tests can be selected by scrolling to the highlighted selection using the up and down key and the ENTER key to start the selected test. For some of these tests, numeric data entry may be required to define the test number or the modulation rate.

**VOLT FREQ MIN**

Standard/Group		RTCA	Group1	Group2	Group3
Voltage	1	100	104	104	104
	3	101.5	105.5	105.5	105.5
Frequency		380	390	360	360

Table 9-1: Normal Voltage and Frequency minimum

Standard/Group		RTCA	Group1	Group2	Group3
Voltage	1	122	122	122	122
	3	120.5	120.5	120.5	120.5
Frequency		420	410	650	800

Table 9-2: Normal Voltage and Frequency Maximum

This test will set the voltage and frequency to levels defined by Table 9-1. The test will last for 30 minutes. The test will be repeated for the Group 2 and 3 using the Voltage setting from Table 9-2 and the frequency from Table 9-1. The ← key (backspace) will terminate the test at any time.

**VOLT FREQ MAX**

This test will set the voltage and frequency to levels defined by Table 9-2. The test will last for 30 minutes. The test will be repeated for the EURO standard using the Voltage setting from Table 9-1 and the frequency from Table 9-2. The CLR Key in local operation will terminate the test at any time. Group execute trigger will terminate the test remotely. The unselected phases will remain at 115 volts. The ← key (backspace) will terminate the test at any time.

**VOLT UNBALANCE**

Standard/Group	RTCA	Group1	Group2	Group3
Voltage offset	6	6	6	9
Frequency	400	400	360/650	360/800

*Table 9-3: Normal Voltage Unbalance*

This test will change the output voltage for each phase from 115 volts to 115V + offset. Refer to Table 9-3 for the offset value and the Frequency. The test will last 30 minutes. The test will be repeated for a second Frequency if applicable. The test can be terminated at any time. The ← key will terminate the test at any time.

**WAVEFORM DISTORTION**

This test will generate a 5% THD voltage distortion on the output voltage waveform. The distortion is generated by using a clipped sinewave. The test will last for 30 minutes. The ← key (backspace) will terminate the test at any time.

**VOLTAGE MODULATION**

This test requires a numeric value entry equal to the modulation rate in Hz. This entry value must be between 1 Hz and 200 Hz. The amplitude modulation is calculated based on the modulation rate as defined in Figure 9-4. This test will last for 2 minutes.

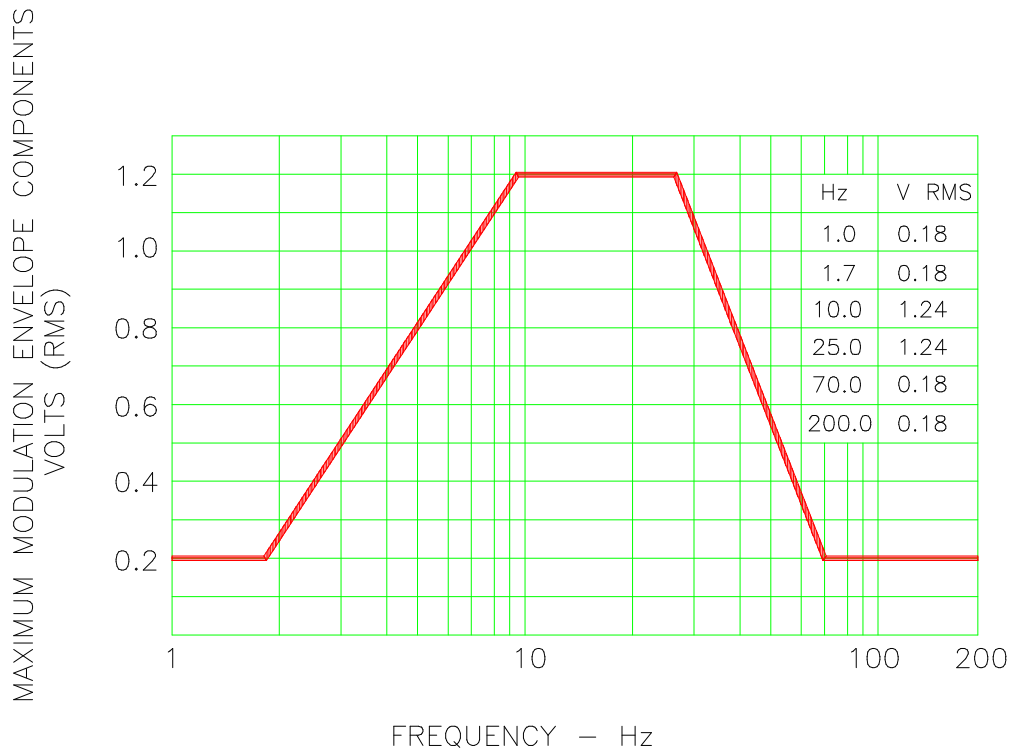

FREQUENCY CHARACTERISTICS OF AC VOLTAGE MODULATION ENVELOPE

*Figure 9-4: Voltage Modulation*

**FREQUENCY MODULATION**

This test requires a numeric value equal to the modulation rate in Hz. This value must be between 0.01 Hz and 100 Hz. The frequency modulation is calculated based on the modulation rate as defined in Figure 9-5. This test will last for a minimum of 2 minutes.

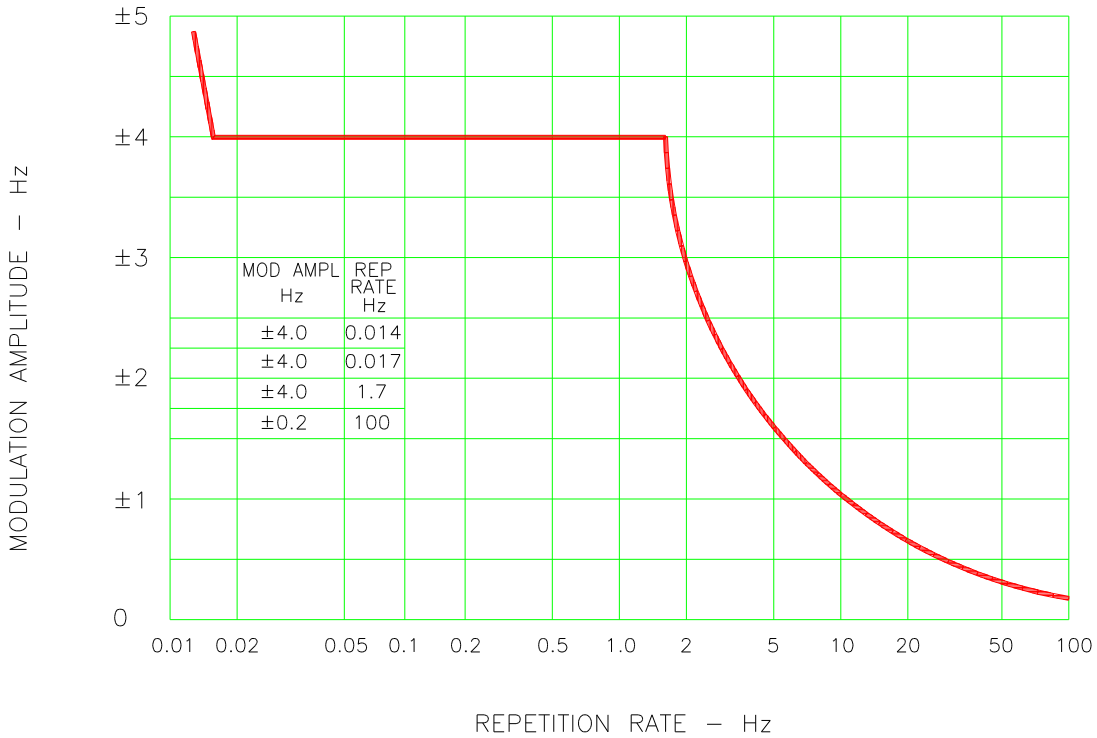

CHARTACTERISTICS OF AC FREQUENCY MODULATION

*Figure 9-5: Frequency Modulation*



**POWER INTERRUPT**

This test requires a numeric entry value equal to the test number. The tests are grouped as follows:

- Test numbers 1 through 15 are for all Standard and Groups. See Figure 9-6 for details of the tests.
- Test numbers 16 and 17 for all equipment that does not incorporate digital circuit. Test number 16 will drop the output to zero voltage for 50 ms. Test number 17 will drop the output to zero voltage for 200 ms. Test number 18 is used for DC equipment and will drop the output for 1 sec.
- Test numbers 21 through 26 are applicable for Groups 2 and 3 only. Output frequency will be set to the F1 value for 1 second prior to the test. The output frequency will remain set to the F2 value when the test is completed. This will allow the user to apply sequence of power interrupts. See Figure 9-7 for detail of the tests.

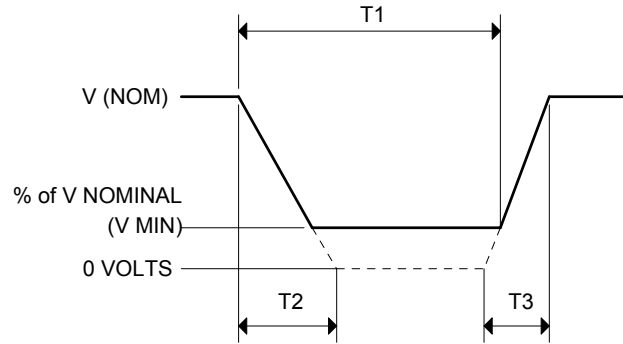

DO160 Table 16-1: Test conditions for equipment with digital circuits.

- NOTES
- 1: Definitions:
    - T1 Power interrupt time
    - T2 Time it would take for the applied voltage to decay from V (nom) to zero volts.
    - T3 Time it would take for the applied voltage to rise from zero to V (nom) volts.
    - V MIN The minimum level (expressed as a percentage of V NOMINAL) to which the applied voltage is permitted to decay.
  - 2: Tolerance to T1, T2, T3 = ± 10%
  - 3: Test condition numbers 8 and 15 are for category Z, dc powered equipment only.

Applicable Category:	A				A, Z			Z	A, B, Z			A, Z			Z
	1**	2	3	4	5	6	7	8	9	10	11	12	13	14	15
T1 (ms)	2**	10	25	50	75	100	200	1000	10	25	50	75	100	200	1000
T2 (ms)	<1	20*	20	20	20	20	20	20	50*	50*	50	50	50	50	50
T3 (ms)	<1	5	5	5	5	5	5	5	20	20	20	20	20	20	20
%V Nom. (V min)	0	50	15	10	5	0	0	0	80	50	0	15	5	0	0

\* Voltage will not reach zero in this test condition.

\*\* Equipment performance standards may require to repeat test n°1 with T1 varying from 5 to 200 ms by step defined in the test equipment performance standards (step typically comprised between 5 ms and 20 ms depending on equipment design).

Figure 9-6: Power Interrupt

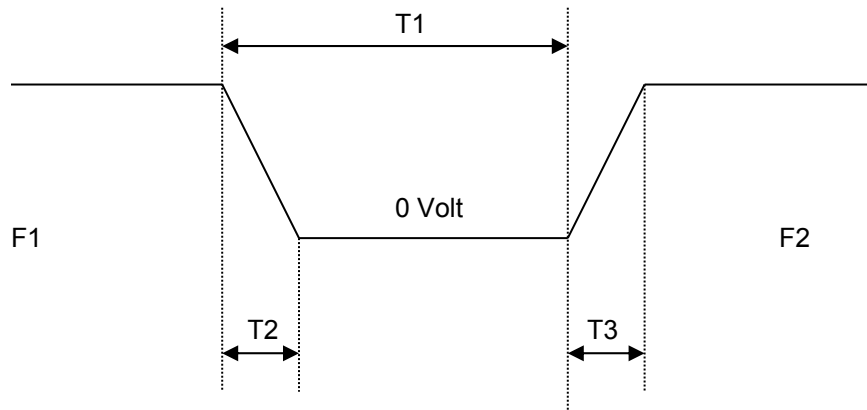

Test no.	21(I)	22(II)	23(III)	24(IV)	25(V)	26(VI)
T1 (ms)	50	50	100	100	200	200
F1 (Hz)	360	Fmax	360	Fmax	360	Fmax
F2 (Hz)	Fmax	360	Fmax	360	Fmax	360

Fmax = 650 Hz for Group 2  
 Fmax = 800 Hz for Group 3  
 T2 = 20 msec  
 T3 = 5 msec

Figure 9-7: Power Interrupt for Group 2 and 3

**VOLTAGE SURGE**

This test requires 160 volts output. If the power source is set at the low voltage range, the high voltage range will be selected before the test starts. At the end of the test, the power source will be switched back to the low range automatically

Seq. No.	Voltage				Time
	RTCA	Group 1	Group 2	Group 3	ALL
1	115	115	115	115	5 Minute
2	160	160	160	170	30msec
3	115	115	115	115	5 Sec.
4	60	70	70	70	30msec
5	115	115	115	115	5 Sec.

Table 9-4: Normal VoltageSurge Sequence

The output voltage will follow the sequence in Table 9-4. The above sequence will repeat itself three times. Each repeat will start from sequence two. US and Group 1 will run at 400 Hz. Group 2 and Group 3 will run at 360 Hz and 650 Hz for Group 2 and 800 Hz for Group 3. The frequency will return to the nominal setting when the test is completed. The ← key (backspace) will terminate the test at any time.

**FREQUENCY TRANSIENTS** (Group 1 only)

Seq. No	Frequency	Time
1	400	5 Minute
2	440	150msec
3	400	5Sec.
4	350	150msec
5	400	5Sec.

Table 9-5: Normal Frequency Transient Sequence

This test applies to Group 1 only. At 115 voltage, change the frequency per sequence listed in Table 9-5. The test will cycle 5 times starting from sequence 2.

**FREQUENCY VARIATION** (Group 2 and 3 only)

Seq. No	Initial Frequency		Slew rate Hz/Sec	Final Frequency	
	Group2	Group3		Group2	Group3
1	360	360	100	650	800
2	650	800	100	360	360
3	360	360	Pause 5 sec	360	360

Table 9-6: Normal Frequency Variation Sequence

This test will apply to Group 2 and 3 only. At 115 voltage, the frequency is set to 360Hz for 5 minutes. The frequency is slowed per sequence listed in Table 9-6. The test will cycle 3 times. The frequency will return to nominal after the test is completed.

**9.1.1.5.2 EMERGENCY TEST**

From the DO160 MENU scroll to the EMERGENCY AC entry using the up and down cursor keys. Press the ENTER key to select the EMERGENCY screens. The screen will appear as shown in Figure 9-8.

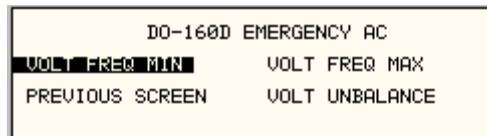

Figure 9-8: Emergency Screen

The EMERGENCY SCREEN has the following tests:

- 1 VOLT FREQ MIN
- 2 VOLT FREQ MAX
- 3 VOLT UNBALANCE

The above tests can be selected by scrolling to the highlighted selection using the up and down key and the ENTER key to start the selected test.

**VOLT FREQ MIN**

Standard/Group		RTCA	Group1	Group2	Group3
Voltage	1 $\Phi$	100	104	104	104
	3 $\Phi$	101.5	105.5	105.5	105.5
Frequency		360	360	360	360

*Table 9-7: Emergency Voltage and Frequency Minimum*

Standard/Group		RTCA	Group1	Group2	Group3
Voltage	1 $\Phi$	122	122	122	122
	3 $\Phi$	120.5	120.5	120.5	120.5
Frequency		440	440	650	800

*Table 9-8: Emergency Voltage and Frequency Maximum*

This test will set the voltage and frequency for a level defined by Table 9-7. The test will last for 30 minutes. The test will be repeated using the voltage from Table 9-8 and frequency from Table 9-7. The ← key (backspace) will terminate the test at any time.

**VOLT FREQ MAX**

This test will set the voltage and frequency for a level defined by Table 9-8. The test will last for 30 minutes. The test will be repeated using the voltage from Table 9-7 and frequency from Table 9-8. The ← key (backspace) will terminate the test at any time.

**VOLT UNBALANCE**

Standard/Group	RTCA	Group1	Group2	Group3
Voltage offset	8	8	8	12
Frequency	400	400	360/650	360/800

*Table 9-9: Emergency Voltage Unbalance*

This test will change the output voltage for each phase from 115 volts to 115V + offset. Refer to Table 9-9 for the offset value and the Frequency. The test will last 30 minutes. The test will be repeated for a second Frequency if applicable. The ← key (backspace) will terminate the test at any time.

**9.1.1.5.3 ABNORMAL TEST**

From the DO160 MENU Scroll to the ABNORMAL AC entry using the up and down cursor keys. Press the ENTER key to select the ABNORMAL screens. The screen will appear as shown in Figure 9-9.

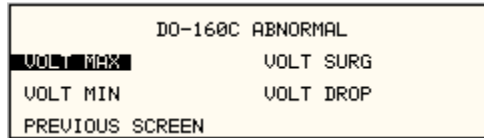

Figure 9-9: Abnormal Screen

The ABNORMAL SCREEN has the following tests:

- 1 VOLT MAX
- 2 VOLT MIN
- 3 VOLT SURG
- 4 VOLT DROP
- 5 FREQ TRANSIENTS

The above test can be selected by scrolling to the highlighted selection using the up and down key and the ENTER key to start the selected test.

**VOLT MAX**

Standard/Group		RTCA	Group1		Group2	Group3
Voltage	1	97	97	104	97	97
	3	98.5	98.5	105.5	98.5	98.5
Frequency		400	400	370	360	360

Table 9-10: Abnormal Voltage Minimum

Standard/Group		RTCA	Group1		Group2	Group3
Voltage	1	134	134	122	134	134
	3	120.5	132.5	120.5	132.5	132.5
Frequency		400	400	430	650	800

Table 9-11: Abnormal Voltage Maximum

This test will set the voltage and frequency to levels defined by Figure 9-10 for 5 minutes. The test will be repeated for Group1 only as indicated in Table 9-10 for voltage and Table 9-11 for frequency. All Groups will repeat the test using Table 9-10 for the voltage setting and Table 9-10 or Table 9-11 for the frequency setting. The ← key (backspace) will terminate the test at any time.

**VOLT MIN**

This test will set the voltage and frequency to levels defined by Table 9-11 for 5 minutes. The test will be repeated for Group1 only as indicated in Table 9-11. All Groups will repeat the test using Table 9-11 for the voltage setting and Table 9-10 for the frequency setting. The ← key (backspace) will terminate the test at any time.

**VOLT UNDER**

This test will drop the output voltage from 115 volts to 60 volts for 7 seconds.

**VOLT SURGE**

This test requires 180 volts output. If the power source is set at the low voltage range, the high voltage range will be selected before the test starts. At the end of the test the AC source will be switched back to the low range.

The output voltage will surge to 180 volts for 100 ms. followed by drop to 148 volts for 1 sec before it returns to 115 volts. The ← key (backspace) will terminate the test at any time.

**FREQUENCY TRANSIENTS (Group 1 only)**

Seq. No.	Frequency	Time
1	400	5 minutes
2	480	5 sec.
3	400	10 sec.
4	320	5 sec.
5	400	10 sec.

*Table 9-12: Abnormal Frequency Transient*

This test will set the voltage at 115V and will remain at this voltage through out the test. The test will cycle the frequency three times as shown in Table 9-12. Each repeat will start from sequence 2.

**9.1.1.6 DC TESTS**

If the output voltage is set for 24V DC or 14V DC the DO-160 DC Main selection screen will appear as seen in Figure 9-10.

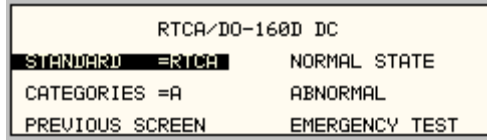

Figure 9-10: DO-160 DC Main Menu

Note: Prior to test selection the Standard selection and Category selection are required. Use the shuttle to select Standard RTCA or EUROCAE. Also, select equipment category A, B or Z.

**9.1.1.6.1 Normal State Test**

Scroll to the NORMAL STATE entry using the up and down cursor keys. Press the ENTER key to select the NORMAL STATE screen. The screen will appear as shown in Figure 9-11.

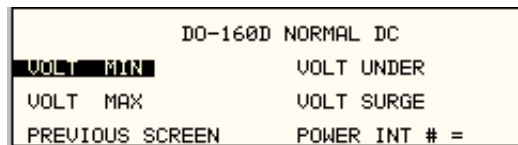

Figure 9-11: Normal State

The DO-160 NORMAL screen has the following tests:

1. VOLT MIN
2. VOLT MAX
3. VOLT UNDER
4. VOLT SURGE
5. POWER INTERRUPT

The above tests can be selected by scrolling to the highlighted selection using the up and down key and the ENTER key to start the selected test. For some of these tests, numeric data entry may be required to define the test number or the modulation rate.

**VOLT MIN**

Standard	Categories		
	A and Z	B 28V / 14V	
RTCA	22.0	22.0	11.0
EUROCAE	22.0	25.1	12.5

Table 9-13: Normal Voltage Minimum

This test will change the output voltage from 28V or 14V to 22V or 11V. The test will last for 30 minutes. The ← (backspace) will terminate the test at any time.

**VOLT MAX**

Standard	Categories		
	A and Z	B 28V / 14V	
RTCA	30.3	30.3	15.1
EUROCAE	30.3	29.3	14.6

Table 9-14: Normal Voltage Maximum

This test will change the output voltage from 28V or 14V to 30.3V or 15.1V. The test will last for 30 minutes. The ← (backspace) will terminate the test at any time.

**VOLT UNDER**

This test applies to category Z and 28 volt category B equipment. The output voltage will drop to 10 volts and will ramp up at a rate of 0.15 volt/sec for the US standard and at a rate of 0.30 volt/sec for EUROCAE standard for 30 seconds before it returns to nominal value.

**VOLT SURGE**

This test will surge and sag the voltage to a level and duration specified Table 9-15 with 5 seconds between transients. The test is repeated three times.

Category	Surge			Sags		
	Volt		Dwell(msec)	Volt		Dwell(msec)
	RTCA	EUR		US	EUR	
A	40	40	30	15	17	30
B	40	40	30	15	17	30
Z	50	50	50	12	12	30

Table 9-15: Voltage Surge

**POWER INTERRUPT**

Refer to section POWER INTERRUPT.



### 9.1.1.6.2 Abnormal Test

From the DO-160 MENU scroll to the ABNORMAL DC entry using the up and down cursor keys. Press the ENTER key to select the ABNORMAL screen. The screen will appear as shown Figure 9-12.

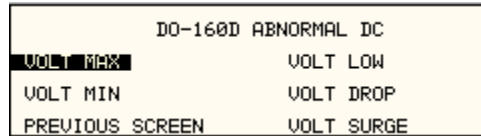

Figure 9-12: Abnormal State

The Abnormal Test has the following tests:

1. VOLT MIN
2. VOLT MAX
3. VOLT LOW
4. VOLT DROP
5. VOLT SURGE

The above tests can be selected by scrolling to the highlighted selection using the up and down key and the ENTER key to start the selected test.

#### **VOLT MIN**

This test will change the output voltage from 28V or 14V to 20.5V or 10V. The test will last for 30 minutes. The ← key (backspace) will terminate the test at any time.

#### **VOLT MAX**

This test will change the output voltage from 28V or 14V to 32.2V or 16V. The test will last for 30 minutes. The ← key (backspace) will terminate the test at any time.

#### **VOLT LOW**

This test applies for category B equipment.

This test will change the output voltage to the voltage minimum for one minute. The voltage will decay linearly to zero voltage in a ten minute period before returning to its nominal voltage.

#### **VOLT DROP**

This test will change the output to 12V from 28V or to 6V from 14V for seven seconds. The output voltage will return to nominal voltage after seven seconds.

## VOLT SURGE

This test will produce voltage surge defined by Table 9-16. This test will be repeated three times with ten seconds intervals. The voltage values are halved for 14.0V category B equipment.

Category	Surge 1		Surge 2	
	Volt	Dwell(msec)	Volt	Dwell(msec)
A	46.3	100	37.8	1000
B	60	100	40	1000
Z	80	100	48	1000

Table 9-16: Abnormal Voltage Surge

### 9.1.1.6.3 Emergency Test

The Emergency test is selected from the DO-160 DC Main Menu. This test will set the output voltage to 18V for 28V equipment and to 9V for 14V equipment. The test will last for 30 minutes. The ← key (backspace) will terminate the test at any time.

---

## 9.2 IEC 61000-4-11 Option

---

### 9.2.1 General

---

The IEC1000-4-11 option is capable of performing IEC1000-4 section 11 voltage dips, short interruptions and voltage variations immunity tests. On three-phase iX/i Configurations, the user can select one, two or all three phases to be active during the IEC1000-4-11 tests in this configuration.

### 9.2.2 Standard Revisions and EUT Classes

---

The -411 option supports both the first (1994-06) and the second edition (2004-03) of the IEC 61000-4-11 test standard. The desired standard revision can be selected when using the GUI Windows program. From the front panel, there is no need to select the revision but data values can be set that support either version of the standard.

Generic tests files are distributed with the GUI program for both editions of the test standard. Files applicable to Edition 2.0 have ED20 in their file name. Do not mix these files, as the data setup will not be correct if you do. To load a test file, select the Mode (Dips or Vars) and test standard revision first, then use the File, Open menu to load the test parameters. Test parameters can be a function of the EUT class. The different files provided with the program cover the various EUT classes. The relevant EUT class 1, 2, 3 or X is listed in the file names.

When using front panel operation, the user has to set levels for each individual test step in SINGLE mode.

### 9.2.3 Initial Setup

---

The user must set the operating frequency and voltage and close the output relay prior to the start of test. It is possible to change the normal voltage ( $U_t$ ) from the IEC1000-4-11 menus before running each test. To run any IEC 61000-4-11 test, the IEC411 state must be turned on. If an EOS1 or EOS3 is detected, it will be put in ACTIVE mode as long as the IEC411 state is ON.

### 9.2.4 Phase Selection

---

On three phase power source models, phase selection for individually executed dips or the preset RUN ALL selection can be made using the PHASE key on the front panel. The phase or phases selected will be displayed in the upper right hand corner of the LCD as either A, B, C, AB, AC, BC or ABD.

With the introduction of Edition 2.0, three phase voltage dips testing has been redefined for both Wye and Delta loads.

For Star (Wye) connected three-phase EUT's, voltage dips should be performed on both individual Line-to-Neutral voltages as well as on all three Line-to-Line voltages. Thus, each test should be run 6 times, each time selecting a different phase option: A, B, C, A+B, A+C and B+C.

For Delta connected three-phase EUT's, voltage dips, only Line-to-Line voltages dips have to be run. Thus, each test can be run 3 times, each time selecting a different phase A+B, A+C and B+C.

Note that the -411 option in iX Series AC sources with Firmware revision lower than 2.38 will not support 2 phase out of 3 selections. iX Series I systems with firmware revision 3.04 or higher and iX Series II systems with firmware revision 4.17 or higher support three phase dips testing using the preferred method referenced in figure 4b) (A) of IEC 61000-4-11, Edition 2.0. iX units with revisions prior to this will change the L-N amplitude by the set dip level but retain the

normally programmed phase angle relationship. For firmware upgrades, contact [service.ppd@ametek.com](mailto:service.ppd@ametek.com).

Note that required phase angles and amplitudes are automatically set for dips of 0, 40, 70, 80 and 100% to conform with method (A). For all other dip levels, method (A) can be used by programming the required phase angles to be used during the programmed dips. The amplitude and phase angles required to obtain the correct line-to-line voltage dip per method (A) for standard dip levels of 40, 70 and 80% are embedded in the firmware and conform to table C.2 of IEC 61000-4-34.

Since all phase programming on the iX series is referenced to phase A, voltage dip with a phase angle for A other than 0° are implemented by offsetting all three phases by the required number of degrees to get phase A at 0°. This is reflected in the actual output settings shown on the iX versus the data in table C.2 of the IEC61000-4-34. The actual output settings are shown in the last 3 columns.

### Phase Mapping

The phase rotation on the iX series is ACB. This means phase A is mapped to L1, phase B is mapped to L3 and phase C is mapped to L2. The required phase selection letter combination for the required Line-to-line dip is shown in table C.2 for reference.

IEC Tables	iX Reference
L1	A
L2	C
L3	B

Table 9-17: Phase mapping

To select the desired phase-to-phase dip, select the phase selection as shown in column 8 and either 80, 70 or 40 % dip level from the IEC411 screen or the Gui. Table C.2

	Line to Line			Line to Neutral			Phase	iX Setting		
	L1-L2	L2-L3	L3-L1	L1-N	L2-N	L3-N	Selection	A-N	C-N	B-N
<b>100% dip</b>	100 %	100 %	100 %	100 %	100 %	100 %	n/a	100 %	100 %	100 %
<b>(no dip)</b>	150°	270°	30°	0°	120°	240°		0°	120°	240°
<b>80% dip</b>	80%	100%	92%	72%	100%	100%	AC	72%	100%	100%
<b>L1-L2</b>	150°	270°	41°	14°	120°	240°		0°	106°	226°
<b>80% dip</b>	92%	80%	100%	100%	72%	230	BC	100%	72%	100%
<b>L2-L3</b>	161°	270°	30°	0°	134°	240°		0°	134°	240°
<b>80% dip</b>	100%	92%	80%	100%	100%	72%	AB	100%	100%	72%
<b>L1-L3</b>	150°	281°	30°	0°	120°	254°		0°	120°	254°
<b>70% dip</b>	70%	100%	89%	61%	100%	100%	AC	61%	100%	100%
<b>L1-L2</b>	150°	270°	47°	25°	120°	240°		0°	95°	215°
<b>70% dip</b>	89%	70%	100%	100%	61%	100%	BC	100%	61%	100%
<b>L2-L3</b>	167°	270°	30°	0°	145°	240°		0°	145°	240°
<b>70% dip</b>	100%	89%	70%	100%	100%	61%	AB	100%	100%	61%
<b>L1-L3</b>	150°	287°	30°	0°	120°	265°		0°	120°	265°
<b>40% dip</b>	40%	100%	87%	53%	100%	100%	AC	53%	100%	100%
<b>L1-L2</b>	150°	270°	67°	79°	120°	240°		0°	41°	161°
<b>40% dip</b>	87%	40%	100%	100%	53%	100%	BC	100%	53%	100%
<b>L2-L3</b>	187°	270°	30°	0°	199°	240°		0°	199°	240°
<b>40% dip</b>	100%	87%	40%	100%	100%	53%	AB	100%	100%	53%
<b>L1-L3</b>	150°	307°	30°	0°	120°	319°		0°	120°	319°

Table 9-18: IEC 61000-3-34 Table C.2

### Other Dip levels for 2 phase selections.

Note that any other dip level not listed in this table will result in voltage dips conform method (B) so both phases will dip by the actual dip percentage set.

To implement user defined three phase dips other than those listed in this table, the IEC411 phase setting for phases A, B and C may be used to set the desired phase angle for each dips. This setting is ignored if the dip levels is set to 80, 70 or 40 but otherwise controls the phase angle of the selected phase during the dip.

### 9.2.5 Tests Performed

#### DIPS AND INTERRUPTIONS

- |               |                                   |
|---------------|-----------------------------------|
| 1. Run All    | Run predefined sequence of tests. |
| 2. Run Single | Run user defined test.            |

#### VOLTAGE VARIATIONS

- |               |                                   |
|---------------|-----------------------------------|
| 1. Run All    | Run predefined sequence of tests. |
| 2. Run Single | Run user defined test.            |

### 9.2.6 Front Panel Entry

To perform a test from the keyboard, select the APPLICATIONS screen from the MENU 2 screen. The APPLICATIONS screen will appear as shown in Figure 9-13



Figure 9-13: Application menu

Scroll to the IEC 1000-4-11 entry using the up and down cursor keys. Press the ENTER key to select the IEC 1000-4-11 main menu. The screen will appear as shown in Figure 9-14.

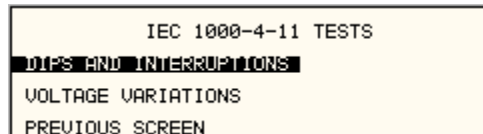

Figure 9-14: IEC1000-4-11 Menu

### 9.2.6.1 DIPS AND INTERRUPTIONS TEST

Scroll to the DIPS AND INTERRUPTIONS entry using the up and down cursor keys. Press the ENTER key to select the DIPS AND INTERRUPTIONS menu. The screen will appear as shown in Figure 9-15.

```

IEC 1000-4-11 DIPS/INTERRUPTIONS 0A
STATE = ON
RUN ALL NOMINAL Ut =230.0V
RUN SINGLE DIP TO =0.0%
EOS ST. =ACTIVE NO CYCLES =0.5
PREVIOUS SCREEN START ANGLE =0.0

```

Figure 9-15: IEC Dips and Interrupts

#### STATE

This field enables or disables the -411 test mode. If an EOS option is present, it will be engaged when the STATE is toggled on. This field may also be used to reset a fault condition occurring on the EOS option due to a temperature or over current fault.

#### EOS STATE

This field can have one of three values:

- |        |                                                                                                                                                                                                                                                                                                                                                                                                                                                                                        |
|--------|----------------------------------------------------------------------------------------------------------------------------------------------------------------------------------------------------------------------------------------------------------------------------------------------------------------------------------------------------------------------------------------------------------------------------------------------------------------------------------------|
| N/A    | Indicates no EOS option is present or the EOS option was not powered up when the STATE was enabled.                                                                                                                                                                                                                                                                                                                                                                                    |
| ACTIVE | The EOS option is active. When active, the -411 firmware will use the EOS for voltage dips at 0, 40 or 70% test levels. If a second generation EOS is used and the 70/80 Tap selection on the EOS is set to 80%, you must still program 70 as the DIP TO level to activate the 80% tap as the firmware only has one control code for this tap. Thus, the 70% programmed level will activate the 70/80 tap. The actual level will be determined by the setting of the EOS in this case. |
| OFF    | The EOS option is in Bypass mode.                                                                                                                                                                                                                                                                                                                                                                                                                                                      |

**RUN ALL**

The RUN ALL selection will cause the following automated test sequence suggested by the standard to be run:

Step	Output in % of $U_T$	No of Cycles	Start angle (degrees)	Repeat # times	Delay between repeats (s)
1	0	0.5	0	3	10
2	0	0.5	180	3	10
3	0	1	0,45,90	3 at diff $\emptyset$	10
4	0	5	45,90,135	3 at diff $\emptyset$	10
5	0	10	90,135,180	3 at diff $\emptyset$	10
6	0	25	180,225,270	3 at diff $\emptyset$	10
7	0	50	270,315,0	3 at diff $\emptyset$	10
8	40	0.5	0	3	10
9	40	0.5	180	3	10
10	40	1	0,45,90	3 at diff $\emptyset$	10
11	40	5	45,90,135	3 at diff $\emptyset$	10
12	40	10	90,135,180	3 at diff $\emptyset$	10
13	40	25	180,225,270	3 at diff $\emptyset$	10
14	40	50	270,315,0	3 at diff $\emptyset$	10
15	70	0.5	0	3	10
16	70	0.5	180	3	10
17	70	1	0,45,90	3 at diff $\emptyset$	10
18	70	5	45,90,135	3 at diff $\emptyset$	10
19	70	10	90,135,180	3 at diff $\emptyset$	10
20	70	25	180,225,270	3 at diff $\emptyset$	10
21	70	50	270,315,0	3 at diff $\emptyset$	10

Table 9-19: Dips and Interruptions Tests Performed During RUN ALL

The user can change the NOMINAL  $U_T$  voltage for this. The RUN ALL Command line will change to ABORT during the test. Selecting ABORT and pressing the ENTER key will terminate the test at any time and the output voltage will return to the nominal value.

**RUN SINGLE**

RUN SINGLE command will run a single test once. The Dip or Interrupt test is defined by the DIP TO, NO CYCLES, and START ANGLE parameters. These parameters must be set before starting the test. The following is a description of these parameters.

DIP TO: The dip voltage level as a percentage of the nominal voltage.

NO CYCLES: The dip duration in cycles.

START ANGLE: The start phase angle of the dip

Note: After each individual run, a 10 second delay is inserted.

### 9.2.6.2 VOLTAGE VARIATION TESTS

From the IEC1000-4-11 Main Menu screen shown in Figure 9-14, scroll to the VOLTAGE VARIATIONS entry using the up and down cursor keys. Press the ENTER key to select the VOLTAGE VARIATIONS menu. The screen will appear as shown in Figure 9-16.

IEC 1000-4-11 VOLTAGE VARIATIONS	
RUN ALL	NOMINAL $U_T$ =230.0V
RUN SINGLE	REDUCE TO =40.0%
	FALL TIME =2.0S
	HOLD TIME =1.0S
PREVIOUS SCREEN	RISE TIME =2.0S

Figure 9-16: Voltage Variation screen

#### RUN ALL

The RUN ALL selection will cause the following automated test sequence suggested by the standard to be run:

Step	Type	Start V in % of $U_T$	Dwell time	End V in % of $U_T$	Delay between steps (s)
1	VSweep	100	2	40	0
2	Hold	40	1	40	0
3	VSweep	40	2	100	10
4	VSweep	100	2	40	0
5	Hold	40	1	40	0
6	VSweep	40	2	100	10
7	VSweep	100	2	40	0
8	Hold	40	1	40	0
9	VSweep	40	2	100	10
10	VSweep	100	2	0	0
11	Hold	0	1	0	0
12	VSweep	0	2	100	10
13	VSweep	100	2	0	0
14	Hold	0	1	0	0
15	VSweep	0	2	100	10
16	VSweep	100	2	0	0
17	Hold	0	1	0	0
18	VSweep	0	2	100	10

Table 9-20: Voltage Variations Test Performed During RUN ALL

The user can change the NOMINAL  $U_T$  voltage for this test. The RUN ALL Command line will change to ABORT during the test. Selecting ABORT and pressing the ENTER key will terminate the test at any time and the output voltage will return to the nominal value.



**RUN SINGLE**

RUN SINGLE command will run the test once. The Variation test is defined by the REDUCE TO, FALL TIME, HOLD TIME and RISE TIME parameters. These parameters must be set before starting the test. The following is a description of these parameters.

- REDUCE TO: The lowest voltage level as a percentage of the nominal voltage. Thus, 0% is 0 Volts. 100% is full nominal voltage.
- FALL TIME: The time in seconds it will take the output to reach the REDUCE TO voltage. Values must be entered in seconds. A 0.000 sec time may be used for abrupt voltage drops instead of voltage sweeps to support Edition 2.0 of the test standard. This requires firmware 2.38 or higher however.
- HOLD TIME: The time in seconds the output will hold at the REDUCE TO voltage. Values must be entered in seconds.
- RISE TIME: The time in seconds the output will reach the NOMINAL voltage from the REDUCE TO voltage. Values must be entered in seconds.

The timing of voltage variations is different between editions 1.0 and 2.0 of the IEC 61000-4-11 test standard. While the original standard used voltage ramps on both sides of the variation test level, the Edition 2.0 standard calls out an abrupt drop to the test level, followed by a voltage ramp back to the nominal voltage. Thus, for Edition 2.0, the fall time must be set to 0.000 seconds.

Furthermore, where under Edition 1.0 rise and fall times were specified in seconds, they are specified in number of cycles in Edition 2.0. This is an effort to normalize both 50 Hz and 60 Hz voltage variations.

Refer to Figure 9-17 and Figure 9-18 for an illustration of how these parameters affect the V RMS output under the different standard revisions.

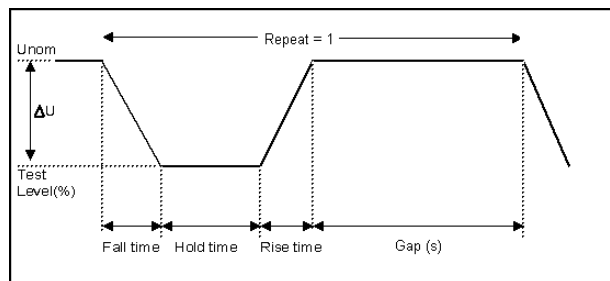

Figure 9-17: EN 61000-4-11 Voltage Variation specification- Edition 1.0

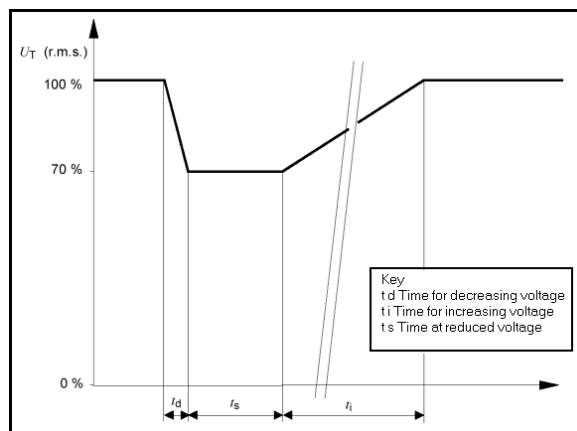

Figure 9-18: EN 61000-4-11 Voltage Variation specification- Edition 2.0

## 9.2.7 Using the GUI Windows Program for IEC 61000-4-11 Testing

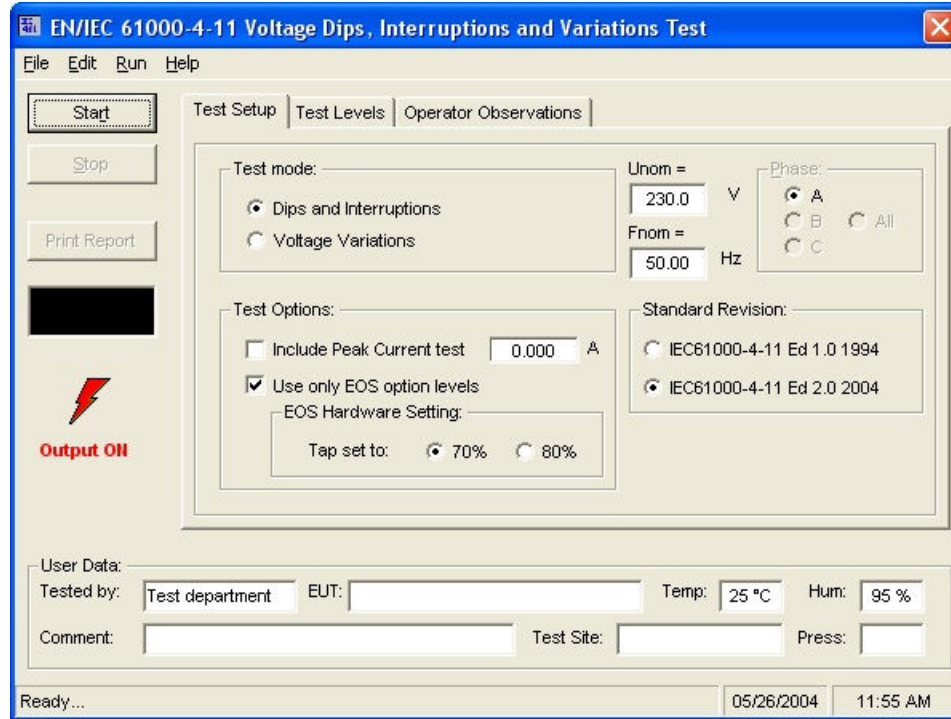

Figure 9-19: IEC 61000-4-11 GUI screen.

The GUI Windows control program will detect the presence of the –411 option on the iX/i AC power source. It will also detect the presence of an EOS1 or EOS3 and use the EOS for the appropriate test levels. Test reports can be generated at the end of a test for documentation purposes.

To support Edition 2.0 of the IEC 61000-4-11 test standard, version 2.0.0.0 of the CIGuiSII or higher is required. Older versions of the GUI will only support Edition 1.0 tests. The desired Edition can be selected by the user and provides the relevant data entry mode for the Edition selected.

Generic tests files are distributed with the GUI program for both editions of the test standard. Files applicable to Edition 2.0 have ED20 in their file name. Do not mix these files, as the data setup will not be correct if you do. To load a test file, select the Mode (Dips or Vars) and test standard revision first, then use the File, Open menu to load the test parameters. Test parameters can be a function of the EUT class. The different files provided with the program cover the various EUT classes. The relevant EUT class 1, 2, 3 or X is listed in the file names.

The user must select the desired test type before executing the test. Since both test types require a number of test parameters, the test sequence parameters must be entered in the data entry grid or loaded from disk using the File, Open menu entry.

For complete details on how to use the GUI –411 option test screen, refer to the on-line help of the GUI program available from the Help menu.

## 9.3 IEC 61000-4-13 Option

---

### 9.3.1 General

---

The IEC413 option is capable of performing IEC 61000-4 section 13 Harmonics and inter harmonics low frequency immunity tests. The tests are based on IEC 61000-4-13:2002-03, First Edition. It is assumed that the user has a copy of the test standard available. This manual section only cover operation of the –413 option from the front-panel of the iX Series power source.

**Note:** The –413 option is only available on iX Series AC power sources, not i Series. It is possible to upgrade most i Series AC source to an iX Series and add the –413 option. Contact the California Instruments service department for information. [service.ppd@ametek.com](mailto:service.ppd@ametek.com)

### 9.3.2 Initial Setup

---

The user must set the operating voltage and close the output relay prior to the start of test. The following set of parameters must be set before the start of test.

1. Frequency to 50 or 60 Hz.
2. Voltage mode to AC.
3. Waveform to sine wave.

### 9.3.3 Tests Performed

---

The IEC61000-4-13 test consists of several types of tests. These tests can be run individually or in sequence (ALL). The following tests are available:

1. Harmonic combination test flat curve and over swing.
2. Sweep in frequency and resonance frequency detection.
3. Individual harmonics and inter harmonics.
4. Meister curve test.

### Front Panel Entry

While it is possible to perform IEC 61000-4-13 testing from the front panel of the iX Series AC power source, it is recommended to use the provided GUI Windows program for report generation. This also provides a more convenient way to perform Class 1 and User class tests as test levels can be saved to disk.

To perform a test from the keyboard, select the APPLICATIONS screen from the MENU 2 screen. The APPLICATIONS screen will appear as shown in Figure 9-20.



Figure 9-20: Application menu

Scroll to the IEC 61000-4-13 entry using the up and down cursor keys. Press the ENTER key to select the IEC 61000-4-13 main menu. The screen will appear as shown in Figure 9-21.

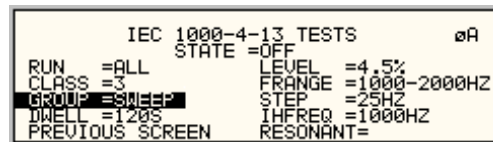

Figure 9-21: IEC 61000-4-13 Menu

#### 9.3.3.1 IEC 61000-4-13 Screen Parameters

The IEC 61000-4-13 screen has the following common fields for all IEC 61000-4-13 test groups.

##### STATE

The STATE field must be set to ON before the test can run. Initial setup conditions must be met to run the test.

##### RUN

The RUN field has the following selections:

1. ALL            Run all IEC 61000-4-13.
2. GROUP        Run the selected group.
3. RANGE        Run the selected range for the selected group.
4. POINT        Run the selected frequency for the selected range and selected group.

Note: The RANGE and POINT do not apply to all groups. See individual groups for details.

When the test is running, this field will have the following selection:

1. ABORT        The test will stop running and all parameters will return to the state prior to the start of the test.
2. PAUSE        The test will pause at the time the ENTER key is pressed while the PAUSE field is selected. The field will change to RESUME. When the ENTER key is pressed again, the test will resume from the point it stopped.

**EUT CLASS**

This field selects the desired product or EUT class. There are four EUT classes. Class 1, 2 and 3 are predefined by the standard and its level parameters cannot be changed. The user class can be edited at any time. Changing between class 2 and 3 can be done while the state is on. Changing to the user class requires the state to be in the off position.

For Class 1 EUT, the user class must be used. Only class 2 and 3 test levels are pre-programmed. When using the provided, GUI Windows program, class 1 tests are set up by the GUI program automatically.

**GROUP**

This field selects the test GROUP. Selecting a group is required for editing the data fields associated with the group as well as running the individual group if run group is selected. The field has the following groups:

1. FCURVE This is the first part of harmonic combination test.
2. OSWING This is the second part of harmonic combination test.
3. SWEEP This is the sweep in frequency and resonance frequency detection.
4. HRAM This is the first part of the Individual harmonics and inter harmonics test.
5. IHARM This is the second part of the Individual harmonics and inter harmonics test.
6. MCURVE This is the Meister test.

See the appropriate sections for details on each group.

**DWELL**

This field will show the dwell time in seconds for each group during the test and will allow changes to the dwell time to be made.

The dwell time for the Meister curve group is the dwell time for each inter harmonics. This combined with the frequency step size results in a 5-minute test time per frequency decade.

The dwell time for the sweep group is the dwell time for each frequency decade.

### 9.3.3.2 IEC GROUPS

This section will describe the groups and parameters associated with IEC 61000-4-13. Refer to paragraph 9.3.3.1 for groups associated with the test.

#### FCURVE GROUP

If the FCURVE group is selected, the screen will appear as shown in Figure 9-22. The screen has the following parameters that are unique to the group:

```

      IEC 1000-4-13 TESTS      @A
      STATE =OFF
      RUN  =ALL      LEVEL =80.0%
      CLASS =3      PAUSE =10S
      GROUP =FCURVE
      DWELL =120S
      PREVIOUS SCREEN
  
```

Figure 9-22: IEC 61000-4-13 FCurve

1. LEVEL Set the Flat curve clip level. This field can be set when the IEC 1000-4-13 is in the OFF state and the Class is set for USER class.
2. PAUSE Time in seconds the test will pause prior to proceeding to the following test. This field can be set at any time when the test is not running.

#### OSWING GROUP

If the OSWING group is selected, the screen will appear as shown in Figure 9-23. The screen has the following parameters that are unique to the group:

```

      IEC 1000-4-13 TESTS      @A
      STATE =OFF
      RUN  =ALL      LEVEL =8.0%
      CLASS =3      HARM NO=3
      GROUP =OSWING      PHASE =180.0°
      DWELL =120S      PAUSE =10S
      PREVIOUS SCREEN
  
```

Figure 9-23: IEC 61000-4-13 OSwing

1. LEVEL The level of the harmonics relative to the fundamental in percent. There are two levels, one for harmonic #3 and the other for harmonic #5. The harmonic number must be selected prior to the harmonic level entry. To change levels, the test state must be off and USER class must be selected.
2. HARM NO There are only two harmonic numbers. This field is used to set the harmonics level that corresponds to the harmonics number.
3. PHASE Sets the phase angle of the harmonics relative to the fundamental. The phase can be set when the test state is off and USER class is selected.
4. PAUSE Sets the time in seconds. The test will pause prior to proceeding to the following test. This field may be changed at any time as long as the test is not running.

## SWEEP GROUP

If the SWEEP group is selected, the screen will appear as shown in Figure 9-24. The screen has the following parameters that are unique to the group:

```

      IEC 1000-4-13 TESTS      mA
      STATE =OFF
RUN  =ALL      LEVEL =4.5%
CLASS =3      FRANGE =1000-2000HZ
GROUP =SWEEP  STEP  =25HZ
DWELL =120S   IHFREQ =1000HZ
PREVIOUS SCREEN  RESONANT=
  
```

Figure 9-24: IEC 61000-4-13 Sweep

1. LEVEL Sets the percentage level of the inter harmonics relative to the fundamental. The level is fixed for the entire frequency range, which is defined by FRANGE. To change level, the test state must be off and user class must be selected.
2. FRANGE The range is selected by rotating the shuttle. The range selection is required to change the level for the selected range. Also, an individual range sweep is possible by selecting the desired range and selecting RUN RANGE from the RUN field.
3. STEP The step size defines the inter harmonics sweep points. Step size is fixed for the entire sweep range. The STEP size can be changed when the test state is off.
4. IHFREQ This field will show the current inter harmonic frequency when the test is running. An inter harmonic frequency can be selected using the shuttle. To run a frequency without sweeping through the entire range, a RUN POINT can be selected.
5. RESONANT This field is used to report the resonant points, if any, after running the sweep test. No editing is allowed in this field. When the test is completed, a display of harmonics current versus frequency plot is available. To view the graph, select the field and press the ENTER key.

## HARMONICS GROUP

If the Harmonics group is selected, the screen will appear as shown in Figure 9-25. The screen has the following parameters that are unique to the group:

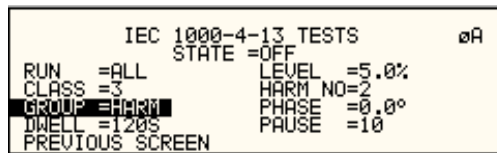

```
IEC 1000-4-13 TESTS      0A
STATE =OFF
RUN  =ALL                LEVEL =5.0%
CLASS =3                 HARM NO=2
GROUP =HARM              PHASE =0.0°
DWELL =120S              PAUSE =10
PREVIOUS SCREEN
```

Figure 9-25: IEC 61000-4-13 Harmonics

1. **LEVEL** Sets the percentage level of the harmonic relative to the fundamental. Each level is associated with a harmonic number. To change levels, the test state must be off and user class must be selected.
2. **HARM NO** Selecting a harmonic number using the shuttle knob will allow examination of the LEVEL and PHASE of each harmonic and changing the level and phase angle when USER class is selected.
3. **PHASE** Sets the phase angle of the harmonics relative to the fundamental. To change phase, the test state must be off and user class must be selected.
4. **PAUSE** Sets the pause time in seconds between harmonics tests. There is only one value for the entire test. The PAUSE value can be changed when the test is not running.



## INTERHARMONICS GROUP

If the Harmonics group is selected, the screen will appear as shown in Figure 9-26. The screen has the following parameters that are unique to the group:

```

      IEC 1000-4-13 TESTS      0A
      STATE =OFF
      RUN  =ALL      LEVEL =4.0%
      CLASS =3      FRANGE =1000-2000HZ
      GROUP =IHM    STEP  =25HZ
      DWELL =120S   IHFREQ =1000HZ
      PREVIOUS SCREEN PAUSE =10S
  
```

Figure 9-26: IEC 61000-4-13 Inter harmonics

1. LEVEL Sets the percentage level of the inter harmonics relative to the fundamental. The level is fixed for the entire frequency range defined by FRANGE. To change levels, the test state must be off and user class must be selected.
2. FRANGE The range is selected by rotating the shuttle. The range selection is required to change the level. An individual range step can be run by selecting the desired range, followed by RUN RANGE from the RUN field.
3. STEP The step size defines the inter harmonics sweep points. This step size is fixed for the entire range of the sweep. The STEP size can be changed when the test state is off.
4. IHFREQ This field shows the current inter harmonic frequency when the test is running. An inter harmonic frequency can be selected with the shuttle. To run an inter harmonic frequency without sweeping through the entire range, RUN POINT must be selected.
5. PAUSE Sets the time in seconds for which the test will pause between inter harmonic frequencies. There is only one value for the entire test. The PAUSE can be set when the test is not running.

## MEISTER CURVE GROUP

If the Meister curve group is selected, the screen will appear as shown in Figure 9-27. The screen has the following parameters that are unique to the group:

```

IEC 1000-4-13 TESTS          0A
STATE =OFF
RUN  =ALL                     LEVEL =4.0%
CLASS =3                      FRANGE =1000-2000HZ
GROUP =MEISTER
DWELL =120S                   IHFREQ =1000HZ
PREVIOUS SCREEN              PAUSE =10S
  
```

Figure 9-27: IEC 61000-4-13 Meister Curve

1. **LEVEL** Sets the percentage level of the inter harmonics relative to the fundamental. The level is fixed for the entire frequency range defined by FRANGE. To change levels, the test state must be off and user class must be selected.
2. **FRANGE** The range is selected by rotating the shuttle. The range selection is required to change the level. An individual range step can be run by selecting the desired range, followed by RUN RANGE from the RUN field.
3. **STEP** The step size defines the inter harmonics sweep points. This step size is fixed for the entire range of the sweep. The STEP size can be changed when the test state is off.
4. **PAUSE** Sets the time in seconds for which the test will pause between ranges. There is only one value for the entire test. The PAUSE can be set when the test is not running. For the Meister curve test, the pause time is normally set to 0 secs. If a value other than 0 is entered, the inter harmonics are set to 0% during the pause times.
5. **RESONANT** This field is used to report the resonant points, if any, after running the Meister curve test. No editing is allowed in this field. When the test is completed, a display of harmonics current versus frequency plot is available. To view the graph, select the field and press the ENTER key.

### 9.3.3.3 RUNNING THE TEST

The test sequence used is a function of the EUT class. The end user needs to determine the appropriate class of EUT. The test protocol is document in the IEC 61000-4-13 test standard. For reference, the test flow charts are shown here. It is assumed that the end user has a copy of the actual test standard however.

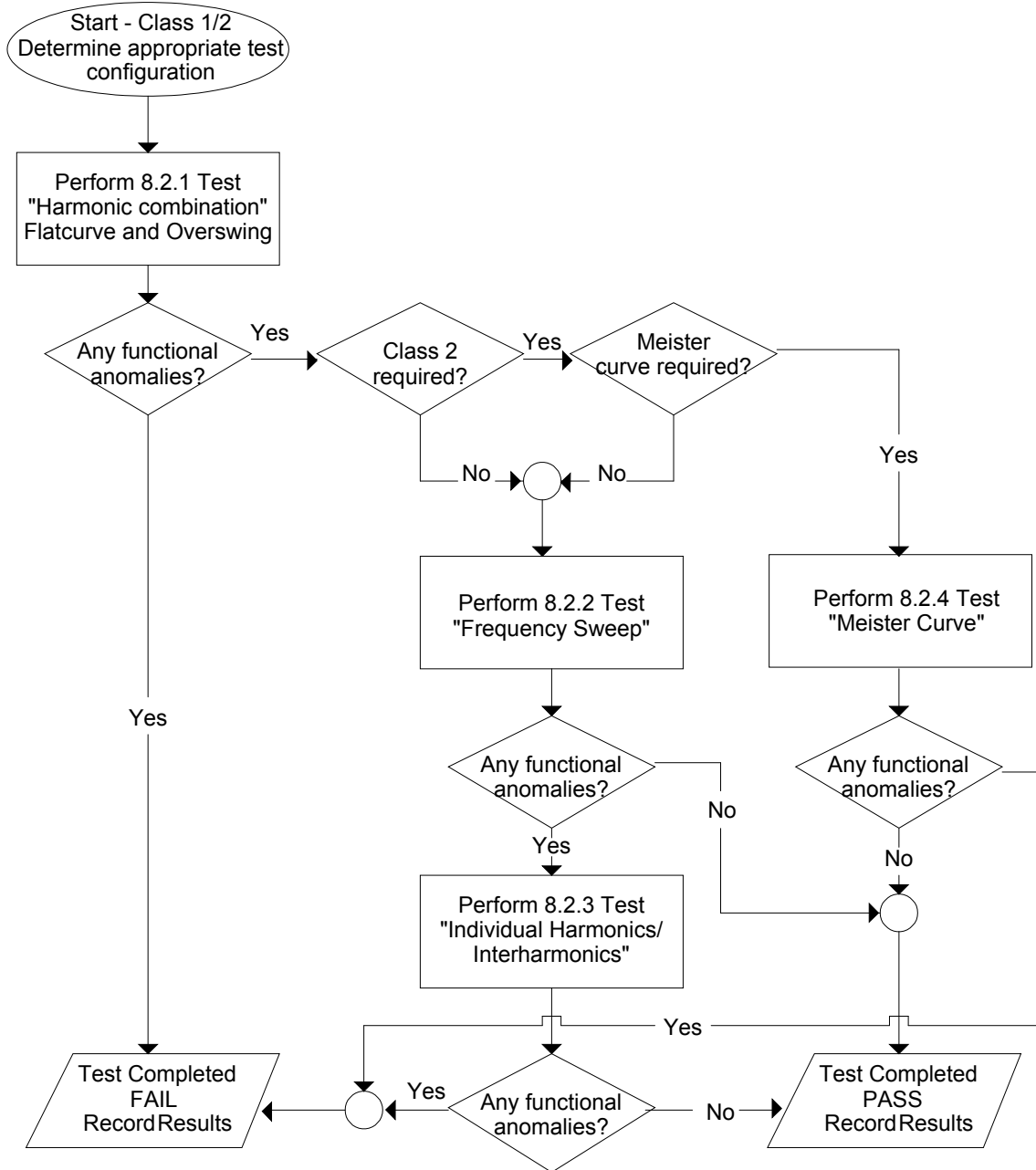

Figure 9-28: IEC 61000-4-13 Test Flowchart Class 1 and 2

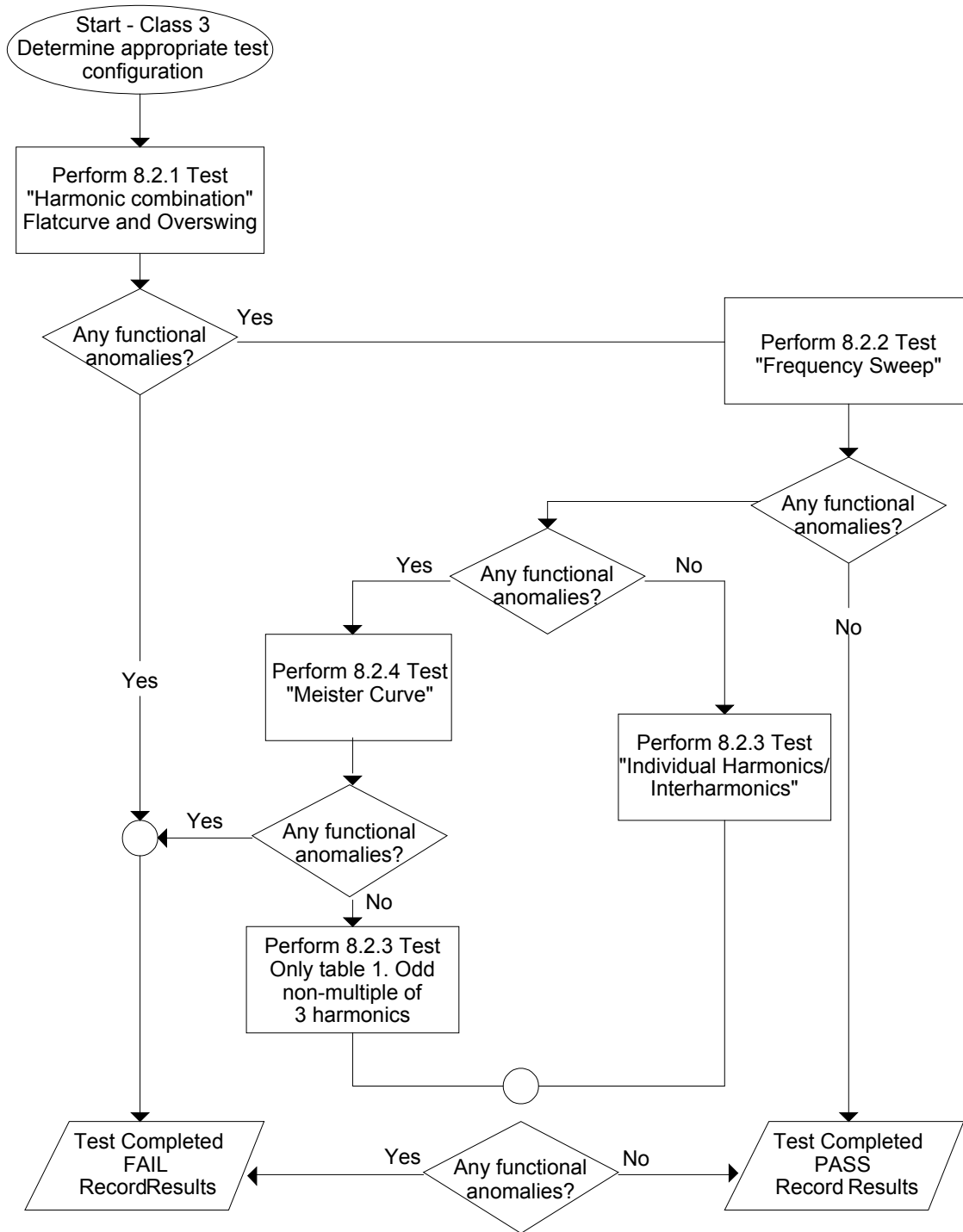

Figure 9-29: IEC 61000-4-13 Test Flowchart Class 3

To run the test, the IEC 61000-4-13 mode must be selected. Refer to paragraph 4 for access to the screen. The following conditions have to be met before running the test:

1. Prior to the test, set the nominal voltage, frequency, and phase angle. The frequency must be 50 or 60 Hz. Function must be set to sine wave.
2. Select EUT CLASS 2, 3 or USER. The default parameters for the USER class are identical to those for class 3. If USER class is selected, the level and phase parameters can be edited. For Class 1 EUT's, the USER class must be used as well. In this case, set the levels to those called out in the test document.
3. Set the STATE to ON. It will take a few seconds to initialize data required to perform the test.
4. If it is desired to run all tests, select ALL from the RUN parameter with the shuttle knob and press the ENTER key. The tests will run in the following sequence:

FCURVE, OSWING, SWEEP, HARM, IHARM,MCURVE

**Note:** The test for class 3 will take about 25 minutes, class 2 slightly less.

5. While the test is running, the ABORT and PAUSE selection is accessible from the RUN field by rotating the shuttle.
6. If it is desired to run a specific group, the group must be selected from the group screen. Also, the RUN GROUP must be selected prior to the start of test.
7. To run an individual range, applicable for sweep and individual harmonics only, the desired range and the RUN RANGE mode must be selected prior to the start of the test. In case the harmonics group is selected, RUN RANGE will run the harmonics from the second harmonics to the harmonics number specified by the HARM NO field. See Figure 9-25.
8. To run individual harmonics or individual inter harmonics, set the harmonic number or the inter harmonics frequency and select RUN POINT prior to running the test.

### 9.3.3.4 INTERHARMONICS

A single inter harmonic frequency may be generated using the INTERHARMONICS screen. This screen allows insertion of any inter harmonic from 1Hz to 2400Hz in 1Hz steps. The amplitude level of the harmonics range is from 0 to 20% of the programmed voltage. To select the inter harmonics screen, press the menu screen until the MENU 2 screen appears as shown in Figure 9-30. Select INTERHARMONICS using the up or down key.



Figure 9-30: MENU 2 SCREEN

#### INTERHARMONICS SCREEN

The inter harmonics screen will appear as shown in Figure 9-31. This screen has the following parameters:



Figure 9-31: INTERHARMONICS SCREEN

1. REFERENCE This field will enable the Inter harmonics generator if ON is selected and will disable the inter harmonics generation if OFF is selected.
2. REF. COUPL If turned on, the REF. VOLT will follow the programmed voltage value.
3. REF. VOLT This field must be programmed to a value if REF. COUPL is off. This value has a range from 0 to 230 volts. This value is set to a value equal to the phase A voltage if the REF. COUPL is turned on.
4. VOLTAGE This field programs the Inter harmonic level in percentage of the REF.VOLT. This value has a range from 0 to 20%

## 9.4 EOS Option

### 9.4.1 Introduction

This section contains information on the installation and operation of the EOS-1 and EOS-3 electronic output switches to be used with the California Instruments i/iX-series of power sources.

### 9.4.2 EOS Revisions

There are two versions of the EOS1 and EOS3. The first generation EOS1 is the original version and has top assembly number 5100-407-1. The second generation EOS1 adds an additional output tap at the 80% test level selectable through a front panel switch and has top assembly number 5100-410-1, Rev A. For the EOS3, the top assembly number remains the same at 5100-407-3. However, the revision of the second generation EOS-3 is Rev E. First generation EOS-3 units will have an older revision letter. The selection between a 70% tap and an 80% tap on the EOS-3 must be hard wired which requires removal of the top cover.

Top assembly number and revision information can be obtained from the model number/serial tag.

Model	Generation	Assembly	Revision
EOS1	1	5100-407-1	D or lower
	2	5100-410-1	A
EOS3	1	5100-407-3	D or lower
	2	5100-407-3	E

Table 9-21: EOS Versions

### 9.4.3 General Description

The EOS-1 and EOS-3 electronic output switches are used with the IEC1000-4-11 option (option –411) to perform IEC1000-4-11 voltage dips and interruptions tests. The –411 option must be installed in the iX/i power source for the EOS to function. It is configured if the EOS was ordered with the iX/i AC source. If the –411 option is not present, contact California Instruments at [service.ppd@ametek.com](mailto:service.ppd@ametek.com) for support.

The tests are fully compliant as long as the equipment under test draws less than 70% of the peak current drive capability of the controlling power source. The EOS-1 may be used with a 5001iX power source for single-phase tests. The EOS-3 may be used with a 15003iX power system for three phase tests. During IEC1000-4-11 testing the EOS directs power from the iX source to a multi-tap power transformer and a set of electronic switches. The switches are opened and closed as required to select the appropriate tap from the transformer to send to the EOS output. During standard operation, the transformer and switches are bypassed within the EOS unit.

All control of the EOS unit is performed automatically by the controlling California Instruments iX power source. The controlling power source automatically detects whether an EOS is operating in the system or not. If the EOS unit is not powered on and active, the controlling source will still perform non-compliant IEC1000-4-11 tests. No user controls are provided. Refer to Section 9.2 for instructions regarding performing IEC1000-4-11 tests with this equipment.

## 9.4.4 Specifications

### 9.4.4.1 Input

Line Voltage (user configurable)	115 VAC $\pm$ 10% 230 VAC $\pm$ 10%
Line Current	< 0.4 amps at 115 VAC input < 0.2 amps at 230 VAC input
Line Frequency	47 to 63 Hz
Fuse Rating	0.5 amp, slow acting at 115 VAC input 0.25 amp, slow acting at 230 VAC input

### 9.4.4.2 Output

	EOS-1	EOS-3
Phases	1	3
<b>IEC 1000-4-11 Test Mode Engaged:</b>		
Voltage		
Range	100-230 V <sub>RMS</sub>	
Regulation	<5%, 100% output < 7%, 80% output (EOS Gen 2 only) <7%, 70% output <10%, 40% output	
Over/Undershoot	<5% into a 100 ohm resistive load	
Rise/Fall Times	Between 1 $\mu$ s & 5 $\mu$ s into a 100 ohm resistive load measured from 10% to 90% of transition	
Programmable Output Levels	100%, 70%, 40%, and 0% of U <sub>NOM</sub>	
Frequency		
Range	50 Hz/60 Hz	
Accuracy	+/- 0.02%	
Phase		
Range	0.0° - 360°	
Accuracy	+/- 1.0°	
Maximum Current		
at 100% U <sub>NOM</sub>	18.5 A <sub>RMS</sub>	18.5 A <sub>RMS</sub> /phase
at 80% U <sub>NOM</sub> (EOS Gen 2 only)	26.4 A <sub>RMS</sub>	26.4 A <sub>RMS</sub> /phase
at 70% U <sub>NOM</sub>	23.1 A <sub>RMS</sub>	23.1 A <sub>RMS</sub> /phase
at 40% U <sub>NOM</sub>	46.2 A <sub>RMS</sub>	46.2 A <sub>RMS</sub> /phase
Maximum Peak Current	92.5 A	92.5 A/ phase



(limited by 5001iX / 15003iX)		
at 0% U <sub>NOM</sub>	N/A	N/A
<b>Bypass Mode Engaged:</b>		
Maximum Current	37 A <sub>RMS</sub>	37 A <sub>RMS</sub> /phase

#### 9.4.4.3 Controls/Indicators

Control / Indicator	Comments
ON/OFF toggle switch	
70 / 80 Tap Select toggle switch	(EOS1, second generation only).
Power On lamp	
Active lamp	
Fault lamp	

#### 9.4.4.4 Mechanical

Dimensions	7"H x 19"W x 24"D 178 mm H x 483 mm W x 610 mm D
Weight	
EOS-1	70 lbs, 32 kg
EOS-3	160 lbs, 73 kg
Connectors:	
Input mains	IEC 320
Source	Compression
Load	Compression
Option In/Out	9 pin D-subminiature
Chassis Slide	General Devices C300S-120-B308

#### 9.4.4.5 Environmental

Temperature	0 to 40 °C
Relative Humidity	80% max. to 31 °C derate linearly to 50% max. at 40°C
Altitude	2000 m max.
Installation Over voltage Category	II
Pollution Degree	2
Equipment Class	I
Usage	Indoors

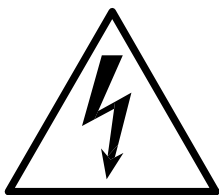

## **CAUTION**

Voltages up to 600 VAC are available in certain sections of this product. This equipment uses potentially lethal voltages.



## **DEATH**

On contact may result if personnel fail to observe safety precautions. Do not touch electronic circuits when power is applied.

## **9.4.5 Installation and Acceptance**

---

### **9.4.5.1 Unpacking**

---

Inspect the unit for any possible shipping damage immediately upon receipt. If damage is evident, notify the carrier. Do not return an instrument to the factory without prior approval. Do not destroy the packing container until the unit has been inspected for damage in shipment.

### **9.4.5.2 Power Requirements**

---

The EOS-1 and EOS-3 electronic switches use either 115 or 230 VAC to power the control circuits. The user may select the desired input voltage using the range selector within the input module.

To change the input voltage range, pry open the cover to the input module. Remove the fuse carrier. Install the correct fuses in the carrier. Reinstall the carrier into the input module so that the desired voltage range appears in the module cover window. Close the cover.

Note that attempting to operate the EOS from an input range that does not match the actual AC power voltage may cause permanent damage to the unit.

The line power source to the EOS must provide protective earth grounding.

### **9.4.5.3 Mechanical Installation**

---

The EOS-1 and EOS-3 have been designed for rack mounting in a standard 19 inch rack. The unit should be supported from the bottom with a shelf-track or supported from the sides with optional rack slides (-RMS option).

The cooling fan at the rear of the unit must be free of any obstructions that would interfere with the flow of air. A 2.5-inch clearance should be maintained between the rear panel of the EOS unit and the rear panel of the mounting cabinet. Also, the air intake holes on the sides of the power chassis must not be obstructed.

---

#### 9.4.5.4 Output Wiring

---

The EOS-1 or EOS-3 is wired in series with the output of specified California Instruments power systems. The EOS terminal block marked SOURCE should be wired to the output of the power source/system. The terminal block marked LOAD is wired to the user's load. Refer to

Figure 9-32 and Figure 9-33 in this section for examples of proper connections. Refer to Section 3.5 to determine the appropriate wire gauge needed for the output wiring.

Note in Figure 9-32 the sequence of instruments. This is the recommended sequence between the iX source and the equipment under test. For systems that do not include all the instruments shown, maintain the sequence of the remaining instruments.

Note also that for all applications the remote sense wiring must be connected **before** the EOS unit.



**Note: The output voltage of the iX/i-series power sources into the EOS box may be at hazardous potentials as high as 300 volts line to neutral (600 volts line to line). Wiring used between the power sources and the EOS and between the EOS and the user's load must be insulated to withstand this potential.**

---



**Note: The SOURCE and LOAD terminals of the EOS will be at the hazardous live potentials of the iX/i-series power sources driving it even if EOS box has not been switched on.**

---

Figure 9-32: Example Connection With 500iX and EOS-1

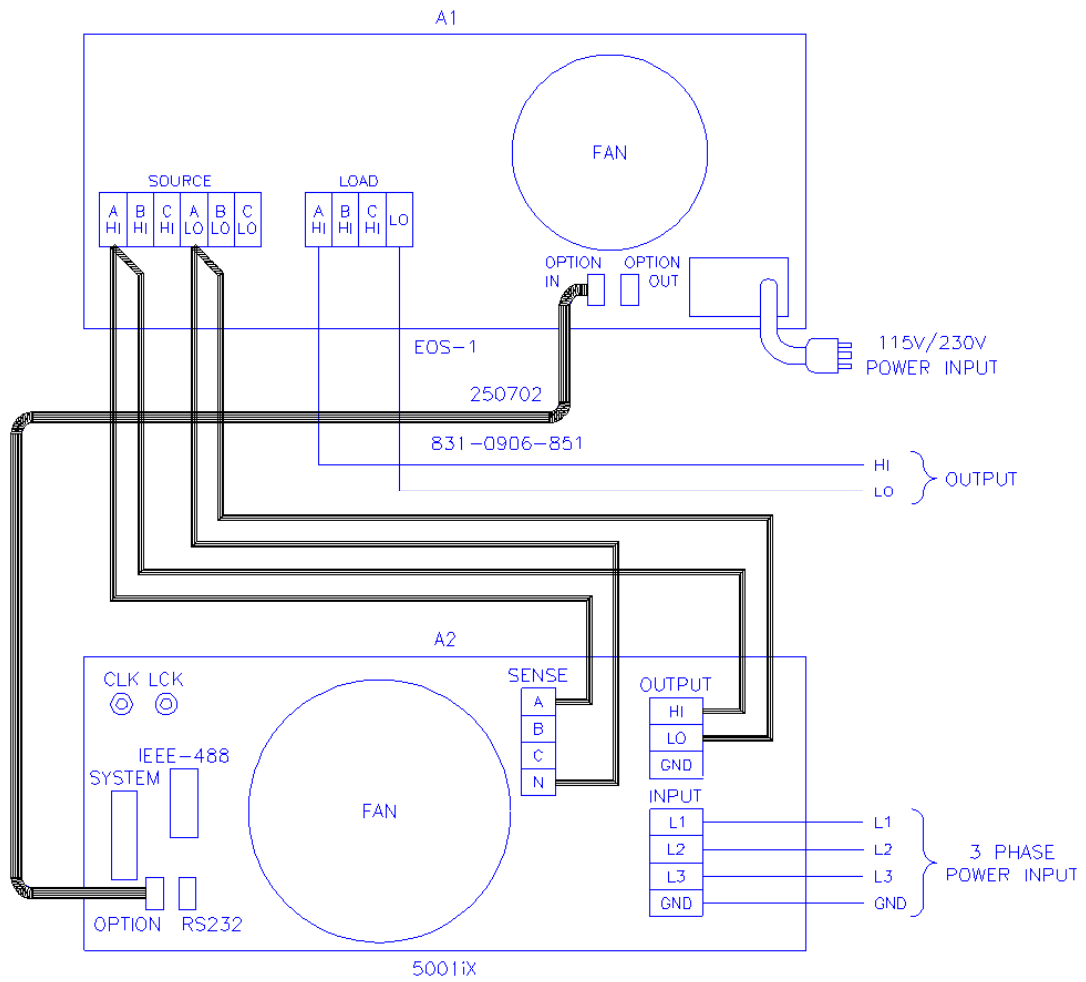

Figure 9-33: Example Connection With Compliance Test System and EOS-1

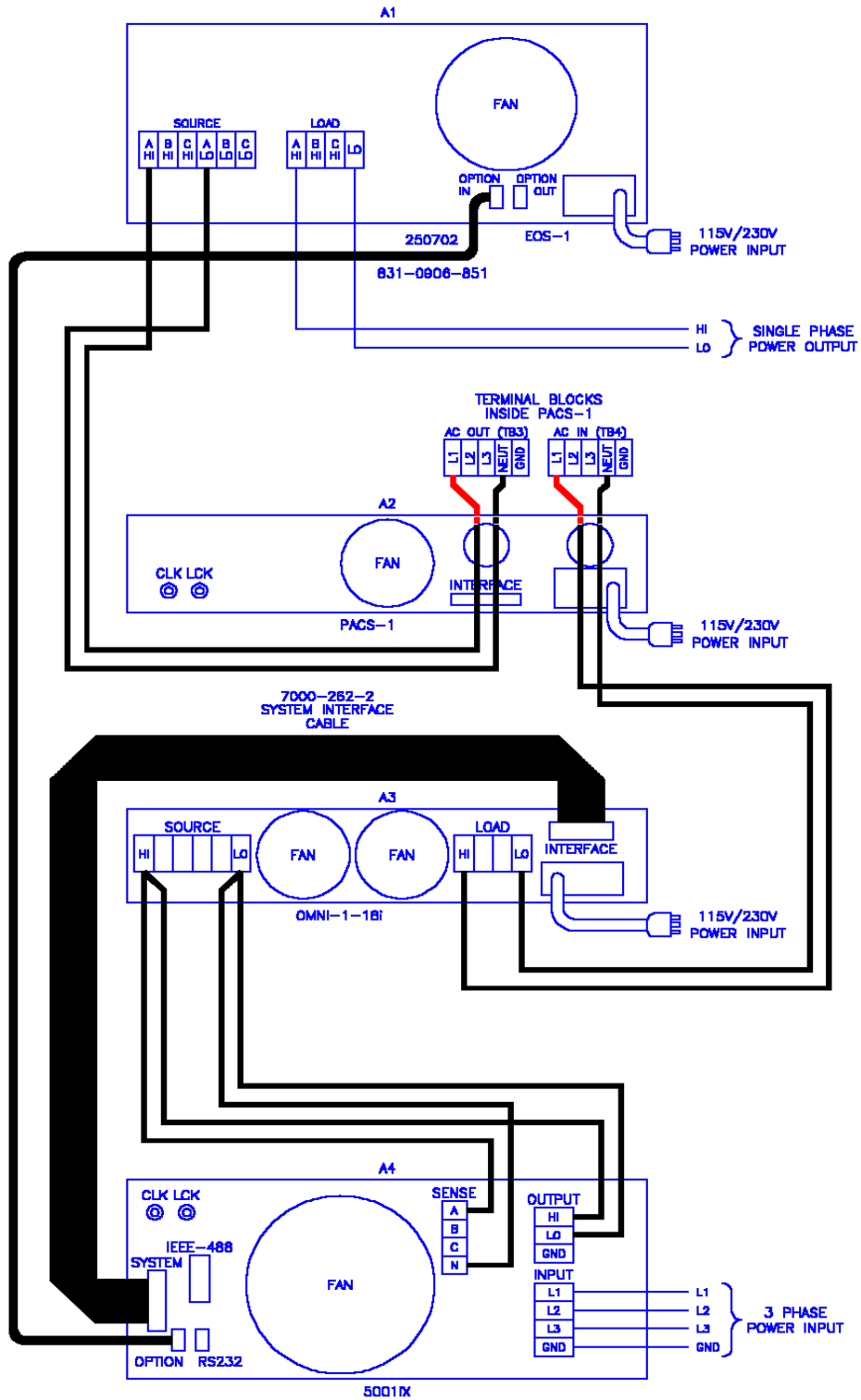
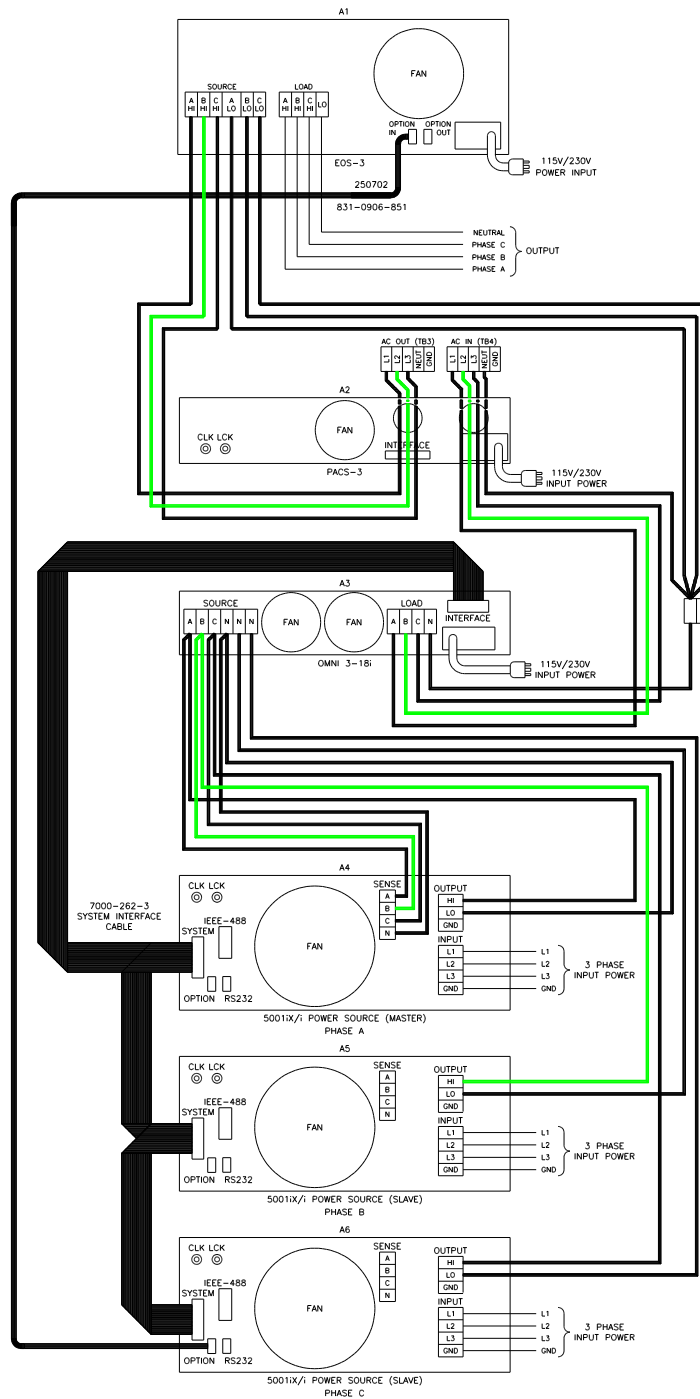
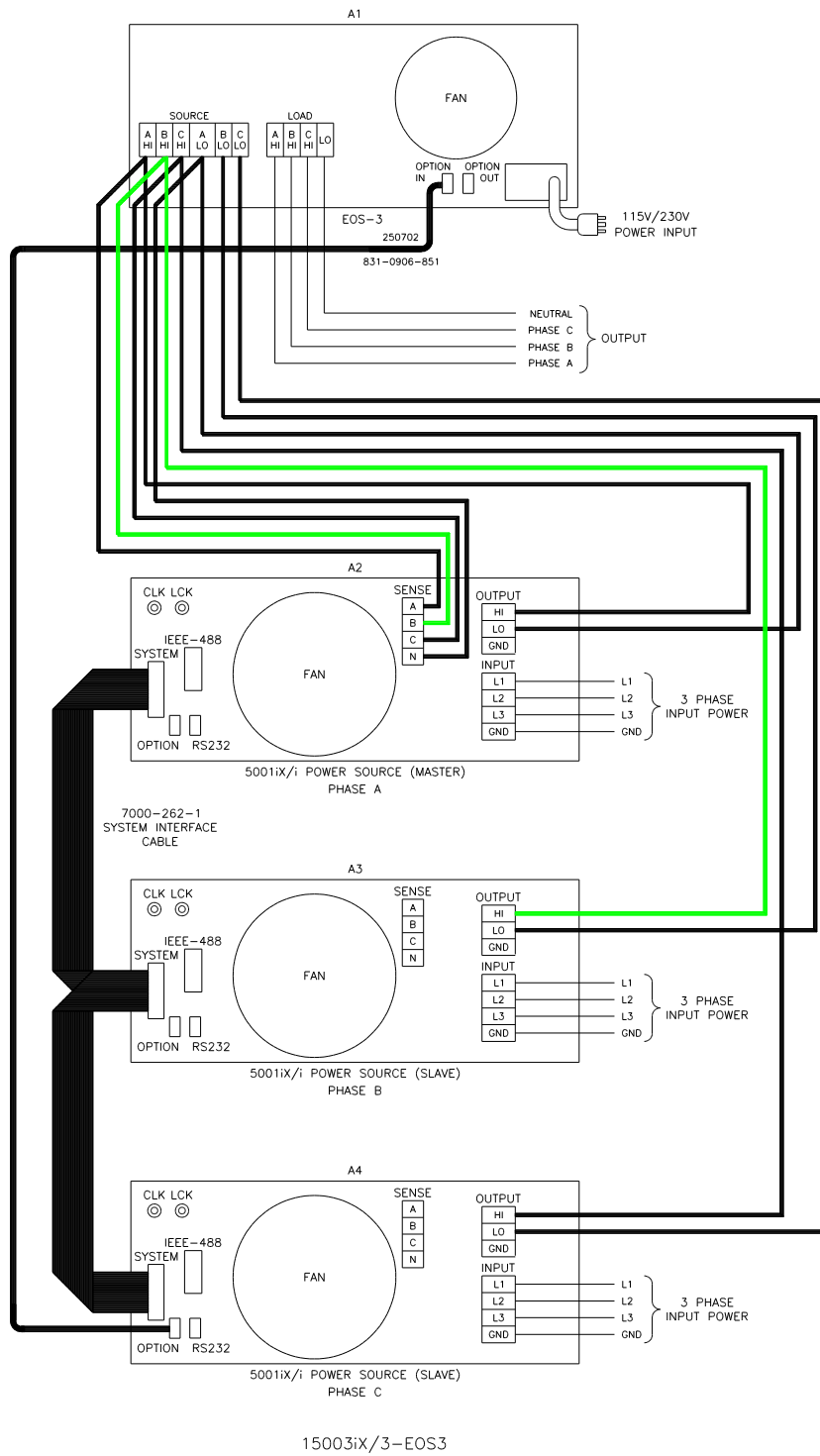

Figure 9-34: 15003iX-CTS-EOS3-LR3



15003iX/3-CTS-EOS3-LR3

Figure 9-35: 15003iX/3-EOS3





---

## 9.4.6 Operation

---

### 9.4.6.1 General

---

The EOS-1 is used with a California Instruments i/iX power source to perform testing compliant with the requirements of IEC1000-4-11. The EOS routes the voltage from the power source to an internal, tapped power transformer. Voltage from each of four taps is sent through an electronic switch to the EOS-1 output. During IEC1000-4-11 testing, the controlling California Instruments power source selects which voltage tap to connect to the EOS output. When IEC1000-4-11 testing is not active, the controlling power source puts the EOS-1 into bypass mode, shunting the EOS input terminals directly to the output terminals.

All control of the EOS-1 is performed automatically by the California Instruments power source. The control signals are sent from the power source to the EOS via the option interface cable. Refer to Section 9.2 for instructions regarding performing IEC1000-4-11 tests with this equipment.

The rated operating current for the EOS in active mode is 18.5 amps. If the controlling power source is set for an RMS current limit greater than 18.5 amps, it will not activate the EOS unit. An attempt to do so will indicate Error -222, "Data out of range". IEC 1000-4-11 tests may still be run, but in pre-compliance mode with the EOS unit bypassed.

Note that while the EOS is engaged, there is no Function Strobe output. Normally, the function strobe - outside the transient system - is associated with any output voltage change. When the EOS is in use however, the function strobe is generated only when the EOS is engaged. This is because the output is programmed down during relay activation. These strobes are meaningless and are not related to any output drops occurring through the EOS. During the EOS transients that use any of the available EOS drop levels, there are no function strobes. Voltage drops that do not use one of the available fixed drop levels are done by dropping the output of the power source itself and will result in function strobes on J22. It is possible to use the OPTION OUT on the back of the EOS - a DB9 connector, pin 6. The return can be either pin 2, 3 or 4. The strobe is a low going level that last for only 400 to 500 nsec. This strobe will coincide with drops performed by the EOS switch.

If the EOS is already in active mode, the controlling power source will not allow its RMS current limit to be programmed above 18.5 amps.

The EOS-3 is similar to EOS-1 with provision for three-phase operation.

---

### 9.4.6.2 Front Panel Controls/Indicators

---

#### Power Switch and Lamp

A power switch turns the EOS on or off. A lamp above the switch illuminates when power is on.

#### Active Lamp

This lamp is illuminated when the EOS is operating with the power transformer and electronic switches active for IEC1000-4-11 testing. During normal power source operation the lamp is off.

#### Fault Lamp

This lamp is illuminated when an overtemperature or an overcurrent condition has occurred in the EOS. If a fault occurs during IEC1000-4-11 testing, the FAULT lamp will be turned on and the EOS electronic switches will be turned off. The next time the controlling power source attempts to change the EOS state, the test will be aborted, the FAULT lamp will be turned off, the controlling power source will indicate an EOS error, and the EOS unit will be programmed to normal (bypassing EOS) mode.

The overtemperature condition will be released when the internal circuits have sufficiently cooled. An overcurrent condition may be reset by reactivating the EOS option from the iX controller 4-11 option screen.

#### Tap Select Switch (Second generation EOS1 only)

The EOS1 tap selection between the 70% and the 80% dip level taps is made using a toggle switch on the front panel of the EOS1. If this toggle switch is not present, the EOS1 is a first generation version. See Table 9-21 for revision details.

To use the 70% dip level, set the toggle switch in the 70% position.

To use the 80% dip level, set the toggle switch in the 80% position.

---

### 9.4.6.3 EOS1 70/80 Tap setting change

---

Second generation EOS1 units are equipped with both a 70% and an 80% output tap. The default configuration shipped from the factor is set to the 70% tap. This is the most commonly used dip level for product standards. However, Edition 2.0 of the IEC 61000-4-11 test standard does allow for a 80% dip level for which the alternate tap setting may be used. The EOS1 tap selection between the 70% and the 80% dip level taps is made using a toggle switch on the front panel of the EOS1. If this toggle switch is not present, the EOS1 is a first generation version. See Table 9-21 for revision details.

To use the 70% dip level, set the toggle switch in the 70% position.

To use the 80% dip level, set the toggle switch in the 80% position.

---

**Note: When using the GUI Windows GUI program to run IEC 61000-4-11 tests, select the EOS1 tap setting on the IEC 61000-4-11 test screen to match the toggle switch position. The GUI has no way to determining the switch setting on its own. If set correctly, the GUI program will use the EOS when the correct dip level is programmed in the voltage dips data grid.**

---

---

**9.4.6.4 EOS3 70/80 Tap setting change**

---

Second generation EOS3 units are equipped with both a 70% and an 80% output tap. The default EOS3 configuration shipped from the factor is set to the 70% tap. This is the most commonly used dip level for product standards. However, Edition 2.0 of the IEC 61000-4-11 test standard does allow for a 80% dip level for which the alternate tap setting may be used. If testing for 80% dips is required, the EOS3 must be reconfigured. This can only be done by removing the top cover and changing the connections on the three transformer taps inside the EOS3, one for each phase. As such, this configuration change should be avoided as much as possible. Should a configuration change be required, follow the procedure outlined below.

1. Remove all input power from the EOS3 first. Make sure the 15001iX is turned off. Then disconnect the output of the 15003iX power source from the EOS input.
2. With the EOS3 completely disconnected, remove the top cover by removing the Phillips screws of the top cover.
3. Each transformer – one per phase – has five output tap lugs connected to a wire harness. The wire harness routes the output of each tap the electronic switches on the control board. There is one control board for each phase mounted to a heat sink.
4. The output tap lugs are numbered 1, 2, 3, 5, 4 in that order on the transformer. The 70% output tap is available on lug number 3. The 80% output tap is available on lug number 5. To change taps, some hand tools (wrench, pliers) will be required.
  - To switch from 70% to 80% tap, disconnect the wire from lug 3 and reconnect it to lug 5 on each of the three transformers.
  - To switch from 80% to 70% tap, disconnect the wire from lug 5 and reconnect it to lug 3 on each of the three transformers.
5. Replace the top cover.

Although it is possible to wire each phase for a different tap level, this is not recommended. It may be advisable to mark the unit to reflect the configured tap after making a configuration change.

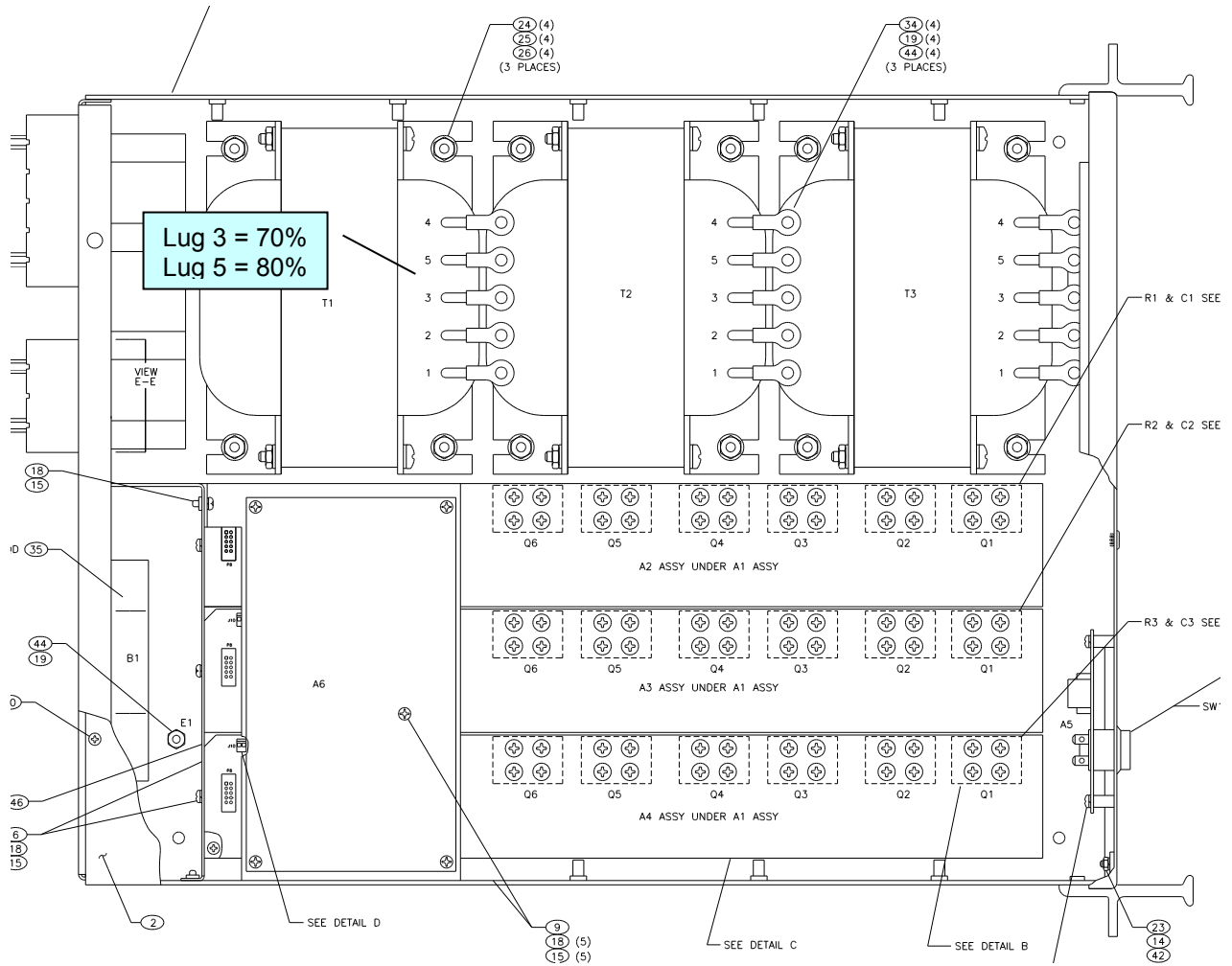

Figure 9-36: EOS3 Location of 70/80 Taps for each phase.

## 9.4.7 Service and Maintenance

---

### 9.4.7.1 Cleaning

---

The exterior of the instrument may be cleaned with a cloth dampened with a mild detergent and wrung out. Disconnect all sources of power (mains, i/iX-power sources, etc.) before cleaning. Do not spray water or other cleaning agents directly on the instrument.

### 9.4.7.2 Fuses

---

There are two fuses used in the EOS-1 or EOS-3. They are located in the mains connector. For continued protection against fire hazard, replace fuses with same type and rating.

<b>Mains Voltage</b>	<b>Fuse Rating</b>	<b>Fuse Type</b>	<b>CI Stock Number</b>
115 VAC, nominal	0.5 amp	3AG, slow acting	270064
230 VAC, nominal	0.25 amp	5x20mm, slow acting	

## 9.5 Mode iX Option

### 9.5.1 Introduction

This section contains information on the installation and operation of the Mode-iX phase mode controller to be used with the California Instruments iX-series of power sources.

#### GENERAL DESCRIPTION

The Mode-iX phase mode controller accepts three outputs from California Instruments iX-series power systems and directs them to one output for a single phase system or three outputs for a three phase system. This switching action is performed automatically via a control signal from the power system to the Mode-iX phase mode controller.

### 9.5.2 Specifications

#### 9.5.2.1 Input

Line Voltage (user configurable)	115 VAC $\pm$ 10% 230 VAC $\pm$ 10%
Line Current	< 0.25 amps at 115 VAC input < 0.125 amps at 230 VAC input
Line Frequency	47 to 63 Hz
Fuse Rating	0.25 amp, slow acting at 115 VAC input 0.125 amp, slow acting at 230 VAC input

#### 9.5.2.2 Phase Mode Terminals

Voltage	300 volts line to chassis 600 volts line to line
Current	37A rms, SOURCE A, B, C, N 37A rms, LOAD B, C 112A rms, LOAD A, N

#### 9.5.2.3 Controls/Indicators

ON/OFF toggle switch  
Phase mode push button switch  
Power lamp  
One Phase Mode lamp  
Three Phase Mode lamp

#### 9.5.2.4 Mechanical

Dimensions	3.5"H x 19"W x 22"D
------------	---------------------

	89 mm H x 480 mm W x 560 mm D
Weight	14.1 lbs, 6.39 kg
Connectors:	
Input mains	IEC 320
Source A, B, C, N	Phoenix Contact HDFK10
Load A, N	Phoenix Contact HDFK50
Load B, C	Phoenix Contact HDFK10
System Interface	3M 3367-1000 (mates with 3M 3366-1001)
Chassis Slide	General Devices C300S-118-U/B308 BKT

### 9.5.2.5 Environmental

Temperature	0 to 40 °C
Relative Humidity	80% max. to 31 °C derate linearly to 50% max. at 40°C
Altitude	2000 m max.
Installation Overvoltage Category	II
Pollution Degree	2
Equipment Class	I
Usage	indoor

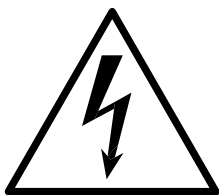

## CAUTION

Voltages up to 600 VAC are available in certain sections of this product. This equipment uses potentially lethal voltages.



## DEATH

On contact may result if personnel fail to observe safety precautions. Do not touch electronic circuits when power is applied.



---

### 9.5.3 Installation and Acceptance

---

#### 9.5.3.1 Unpacking

---

Inspect the unit for any possible shipping damage immediately upon receipt. If damage is evident, notify the carrier. Do not return an instrument to the factory without prior approval. Do not destroy the packing container until the unit has been inspected for damage in shipment.

#### 9.5.3.2 Power Requirements

---

The Mode-iX uses either 115 or 230 VAC to power the control circuits. The user may select the desired input voltage using the small range selector card within the IEC input module. The selector card may be removed from the input module by removing the line cord, sliding the plastic window to the left, and extracting the card.

Note that attempting to operate the Mode-iX from an input range that does not match the actual AC power voltage may cause permanent damage to the unit.

The selector card is marked 100/220 on one side and 120/240 on the opposite side. Mode-iX may be operated from a 115 volt line by selecting the 120 volt range. It may be operated from 230 volts by selecting the 240 volt range. The 100 volt and 220 volt ranges are not active.

The selected range is the one that is marked on the upper left side of the selector card as the card is slid into the IEC 320 module.

The power source to the Mode-iX must provide protective earth grounding.

#### 9.5.3.3 Mechanical Installation

---

The Mode-iX has been designed for rack mounting in a standard 19 inch rack. The unit should be supported from the bottom with a shelf-track or supported from the sides with optional rack slides.

The cooling fan at the rear of the unit must be free of any obstructions that would interfere with the flow of air. A 2.5 inch clearance should be maintained between the rear of the unit and the rear panel of the mounting cabinet. Also, the air intake holes on the sides of the power chassis must not be obstructed.

#### 9.5.3.4 Output Wiring

---

The Mode-iX is wired in series with the output of specified California Instruments power source systems. The Mode-iX terminal block marked SOURCE should be wired to the output of the power source/system. The terminal block marked LOAD is wired to the user's load (unit under test, UUT). Refer to Figure 9-33 in this section for an example of proper connections.

Refer to Section 3.5 to determine the appropriate wire gauge needed for the output wiring.



**Note:** The output voltage of the iX-series power sources into the Mode-iX box may be at hazardous potentials as high as 300 volts line to neutral (600 volts line to line). Wiring used between the power sources and Mode-iX and between the Mode-iX and the user's load must be insulated to withstand this potential.

---



**Note:** The SOURCE and LOAD terminals of Mode-iX will be at the hazardous live potentials of the iX-series power sources driving it even if Mode-iX box has not been switched on.

### 9.5.3.5 DC Mode Application– Blocking and Anti-Parallel Diodes

This section provides guidelines for incorporating protective diode networks at the output of the power supply to prevent damage while driving inductive loads or loads having stored energy that could be circulated back to the power supply operating in DC mode.

To prevent damage to the power supply from inductive voltage kickback, connect an anti-parallel diode (rated at greater than the supply's output voltage and current) across the output: Connect the cathode to the positive output and the anode to return.

Where positive load transients, such as back EMF from a motor might occur, or stored energy is present such as a battery, a second blocking diode in series with the output is recommended to protect the power supply.

Ensure that the chosen components are suitably rated for the particular inductance and energy to be dissipated. The Peak Reverse Voltage ratings should be a minimum of 2 times the Power Supply maximum output voltage. The Continuous Forward Current ratings should be a minimum of 1.5 times the power supply maximum output current. A heatsink may be required to dissipate the power caused by flow of current.

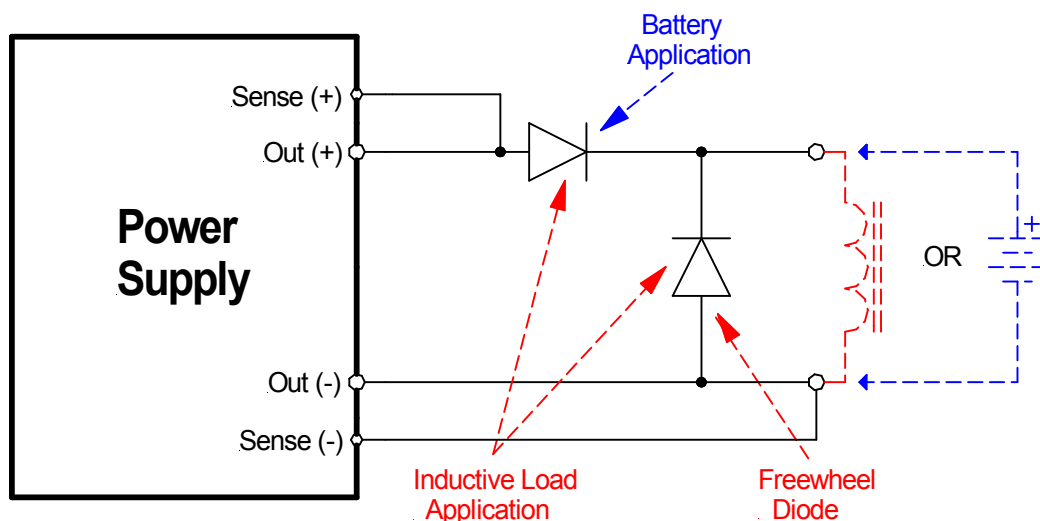
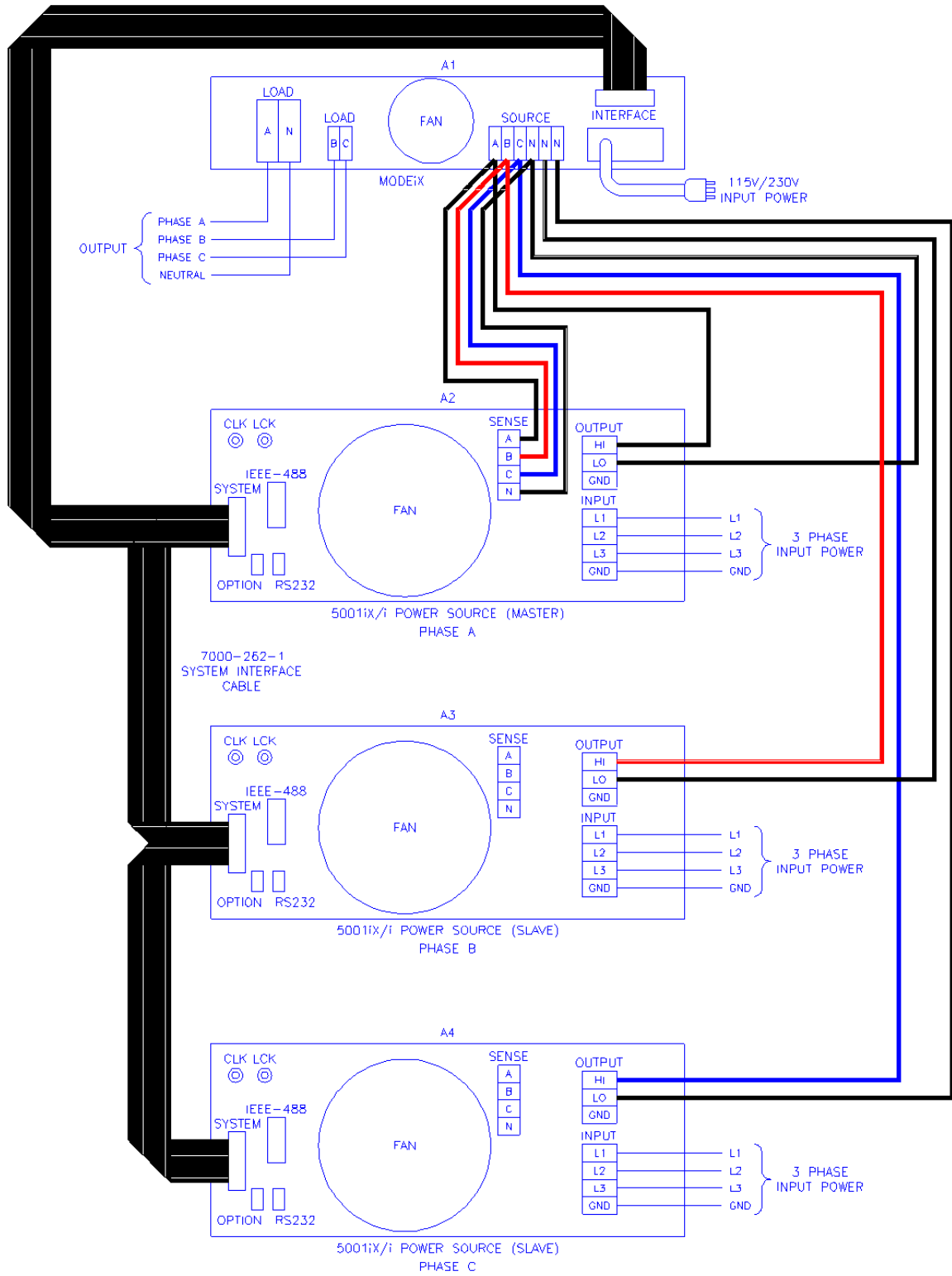

Figure 9-36A. Diode Connection

Figure 9-37: Example Connection With MODE iX



---

## 9.5.4 Operation

---

### 9.5.4.1 General

---

The Mode-iX phase mode controller switches the three outputs from three California Instruments iX-series power sources to one or three sets of outputs on the phase mode controller. This allows the three power sources to be operated in either three phase or single phase mode with the system output being taken from the phase mode controller.

This switching is performed automatically via a control signal on the system interface connector. The signal is generated by the master power source. The master power source also automatically configures the complete power system for proper output phase angles and power source current sharing.

### 9.5.4.2 Front Panel Controls/Indicators

---

#### Power Switch and Lamp

A power switch turns the phase mode controller on or off. A lamp above the switch illuminates when power is on.

#### Mode Switch

This momentary contact push button switch toggles the phase mode controller between three phase and one phase mode. The function of this switch is normally disabled and switching is remotely controlled via a signal on the system interface connector.

#### One Phase Lamp

This lamp is illuminated when the phase mode controller is operating in single phase mode. The power source outputs connected to the SOURCE A, B and C terminals are shorted together in the phase mode controller and directed to the LOAD A terminal.

#### Three Phase Lamp

This lamp is illuminated when the phase mode controller is operating in three phase mode. The power source outputs connected to the SOURCE A, B, C terminals are directed to the LOAD A, B, C terminals, respectively.

#### Programmed Control

The phase mode controller is normally remotely programmed by the master iX-series power source.

A system interface cable must be connected between the Mode-iX and the power sources to carry the control signal to the Mode-iX. When configured for programmed control, the Mode-iX may not be controlled by the front panel MODE switch. Refer to Section 4.2.11.2 for details on controlling the number of output phases with the Mode-iX option.

---

**9.5.5 Service and Maintenance**

---

**9.5.5.1 Cleaning**

---

The exterior of the instrument may be cleaned with a cloth dampened with a mild detergent and wrung out. Disconnect all sources of power (mains, iX-power sources, etc.) before cleaning. Do not spray water or other cleaning agents directly on the instrument.

**9.5.5.2 Fuses**

---

There is one fuse used in the Mode-iX phase controller. It is located in the mains connector. For continued protection against fire hazard, replace fuse with same type and rating.

<b>Mains Voltage</b>	<b>Fuse Rating</b>	<b>Fuse Type</b>	<b>CI Stock Number</b>
115 v rms, nominal	0.25 amp	3AG, slow acting	270117
230 v rms, nominal	0.125 amp	3AG, slow acting	270109

## 9.6 Omni Options

### 9.6.1 Introduction

This section contains information on the installation and operation of the OMNI (Output Matching Network Impedance) impedance network to be used with the California Instruments

i- or iX-series of power sources.

### 9.6.2 General Description

The OMNI impedance network adds inductive and resistive impedance to California Instruments i- or iX-series power sources. This additional impedance brings the combined system impedance up to the levels required of the power source for IEC 555-3 and IEC 1000-3-3 (flicker) testing.

### 9.6.3 Specifications

#### 9.6.3.1 Input

	Omni 1-18i and 3-18i	Omni 1-37i, 1-37iJ and 3-37i
Line Voltage (user configurable)	115 VAC $\pm$ 10% or 230 VAC $\pm$ 10%	115 VAC $\pm$ 10% or 230 VAC $\pm$ 10%
Line Current	< 0.25 amps at 115 VAC input < 0.125 amps at 230 VAC input	< 1.0 amps at 115 VAC input < 0.5 amps at 230 VAC input
Line Frequency	47 to 63 Hz	47 to 63 Hz
Fuse Rating	0.25 amp, slow acting at 115 VAC input 0.125 amp, slow acting at 230 VAC input	2 Amp, slow acting used for both input ranges

#### 9.6.3.2 Output

OMNI Type	1-18i	3-18i	1-37i and 1-37iJ	3-37i
Phases	1	3	1	3
Current max, rms.	18.5A per phase	18.5A per phase	37A per phase	37A per phase
Current in bypass	37A per phase	37A per phase	74A per phase	74A per phase

**NOTE: To prevent damage to the OMNI unit, the BYPASS mode must be selected when the power source is operated on low output voltage range or if currents in excess of OMNI ratings will be drawn.**

<b>OMNI Type</b>	<b>1-18i, 3-18i, 1-37i, 3-37i</b>	<b>1-37iJ</b>
<b>Impedance <math>\pm 5\%</math></b>	<b>(in combination with power source output impedance)</b>	
Phase	0.24 ohms + j 0.15 ohms at 50 Hz	0.24 ohms + j 0.062 ohms at 50 Hz
Neutral	0.16 ohms + j 0.10 ohms at 50 Hz	0.16 ohms + j 0.054 ohms at 50 Hz

### 9.6.3.3 Controls/Indicators

ON/OFF toggle switch  
 Flicker On/Off push button switch  
 Power Lamp  
 Bypass Lamp  
 Flicker Lamp

### 9.6.3.4 Mechanical

Dimensions	<u>Omni 1-18i and 3-18i:</u> 3.5"H x 19"W x 22"D 89mmH x 480mmW x 560mmD	<u>Omni 1-37i, 1-37iJ and 3-37i:</u> 5.25"H x 19"W x 22"D 133mmH x 480mmW x 560mmD
Weight		
OMNI-1-18i	31 lb. (14 kg)	
OMNI-3-18i	37 lb. (17 kg)	
OMNI-1-37iJ	55 lb. (25 kg)	
OMNI-3-37i	55 lb. (25 kg)	
Connectors		
Input AC	IEC 320	
Impedance Network Input and Output	Kulka 9-85 series 3M 3367-1000 (mates with 3M 3366-1001)	
System Interface		
Chassis Slide	General Devices C300S-118-U/B308 BK	

## 9.6.4 Installation and Acceptance

### 9.6.4.1 Unpacking

Inspect the unit for any possible shipping damage immediately upon receipt. If damage is evident, notify the carrier. Do not return an instrument to the factory without prior approval. Do not destroy the packing container until the unit has been inspected for damage in shipment.

### 9.6.4.2 Power Requirements

The OMNI 1-18i and 3-18i use either 115 or 230 VAC to power the control circuits. The user may select the desired input voltage using the small range selector card within the IEC input module. The selector card may be removed from the input module by removing the line cord, sliding the plastic window to the left, and extracting the card.

For the Omni 1-18i and 3-18i the selector card is marked 100/220 on one side and 120/240 on the opposite side. OMNI 1-18i and 3-18i may be operated from a 115 volt line by selecting the 120 volt range. It may be operated from 230 volts by selecting the 240 volt range. The 100 volt and 220 volt ranges are not active.

The selected range is the one that is marked on the upper left side of the selector card as the card is slid into the IEC 320 module.

The OMNI 1-37i, 1-37iJ and 3-37i are designed to operate on either 115V or 230V AC power. The input voltage is user-selectable by orienting the input selector module inside the rear panel power entry module. To change input voltage proceed as outlined below.

**Note that attempting to operate the OMNI from an input range that does not match the actual AC power voltage may cause permanent damage to the unit.**

### **9.6.5 Voltage Range Configuration for the OMNI 1-37i, 1-37iJ and OMNI 3-37i**

---

To change input range:

1. Remove power cord from input module.
2. Pry cover loose with a small screwdriver.
3. Pull out fuse holder, prying with a screwdriver will be necessary.
4. Orient the red fuse holder so that the desired voltage shows through the window. It is necessary that the fuse always sits on the top side of the fuse holder when it is re-inserted into the module. Likewise, the shorting clip must always be on the bottom of the fuse holder.

For example, if the input voltage is being changed from 115 to 230, the fuse holder must first be removed, and then the clip and the fuse must swap location. The fuse assembly can then be inserted back into the input module.

#### **9.6.5.1 Mechanical Installation**

---

The OMNI has been designed for rack mounting in a standard 19 inch rack. The unit should be supported from the bottom with a shelf-track or supported from the sides with optional rack slides.

The cooling fans at the rear of the unit must be free of any obstructions that would interfere with the flow of air. A 2.5 inch clearance should be maintained between the rear of the unit and the rear panel of the mounting cabinet. Also, the air intake holes on the sides of the power chassis must not be obstructed.

#### **9.6.5.2 Output Wiring**

---

The OMNI impedance network is wired in series with the output of specified California Instruments power sources or power source systems. The OMNI terminal block marked SOURCE should be wired to the output of the power source/system. The terminal block marked LOAD is wired to the user's load (unit under test, UUT). Refer to the figures in this section for examples of proper connections.



Refer to the power source manual to determine the appropriate wire gauge needed for the output wiring.

### **9.6.5.3 External Sense Wiring**

---

The external sense wires of the power source must be connected at the output of the power source and NOT at the output of the OMNI or at the load. If the external sense wires were connected at the load or the OMNI output, the power source error amplifier would lower the effective OMNI impedance making the system unsuitable for IEC 555-3 or IEC 1000-3-3 flicker testing.

Refer to the figures in this section for examples of proper external sense connections.

Figure 9-38: Example Connections With OMNI 1-18i

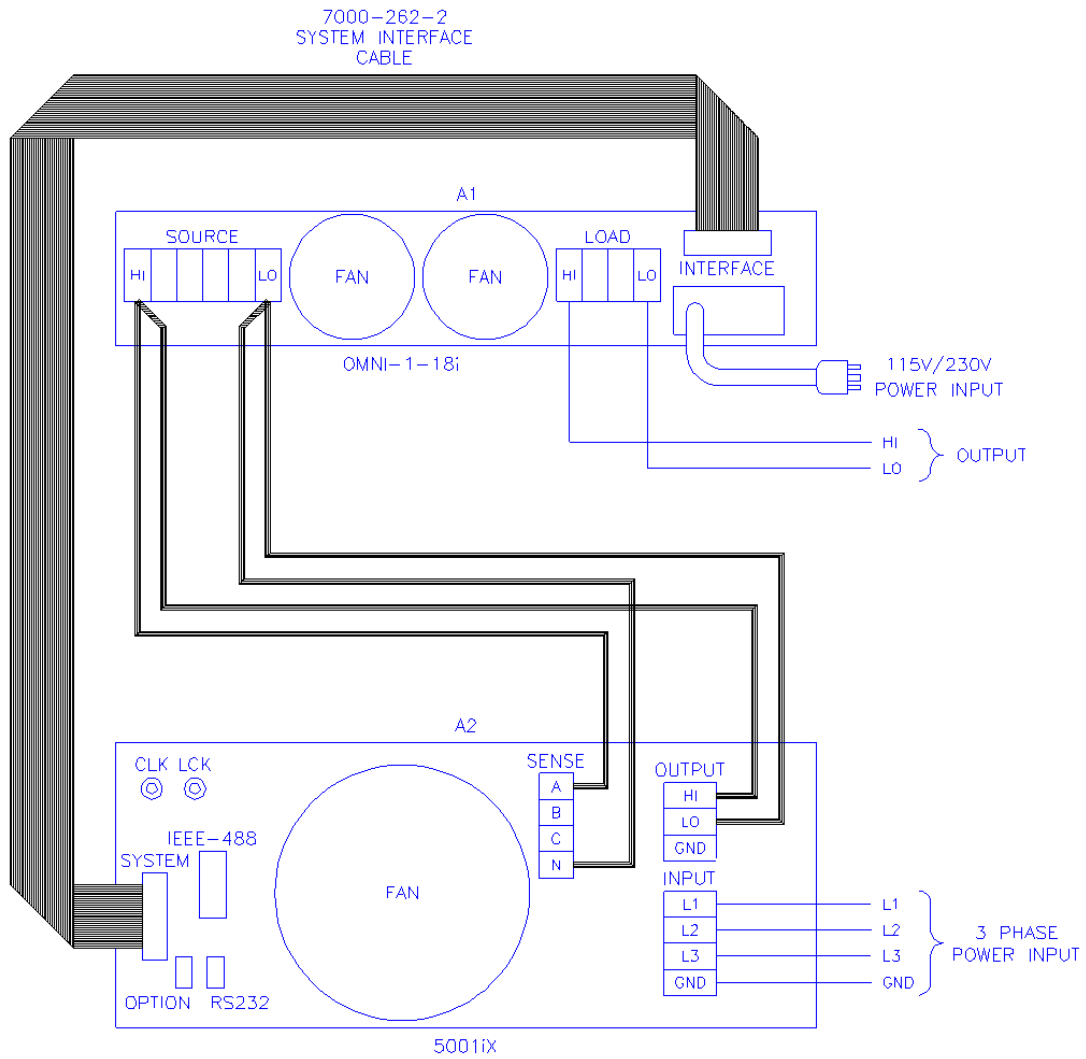

Figure 9-39: Example Connections With OMNI 3-18i

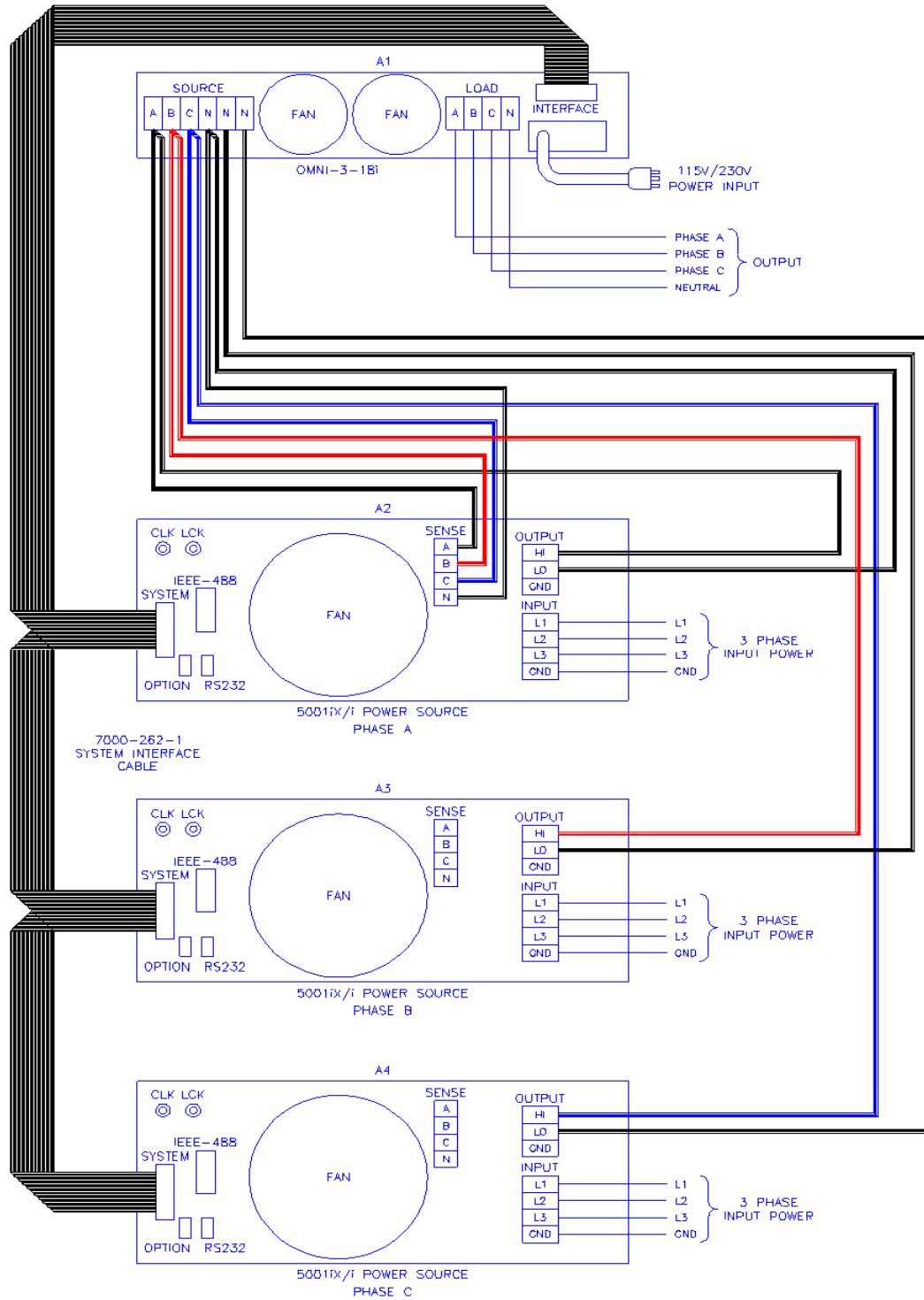

Figure 9-40: Schematic Showing OMNI 1-37i and 1-37iJ Connected to 5001iX System

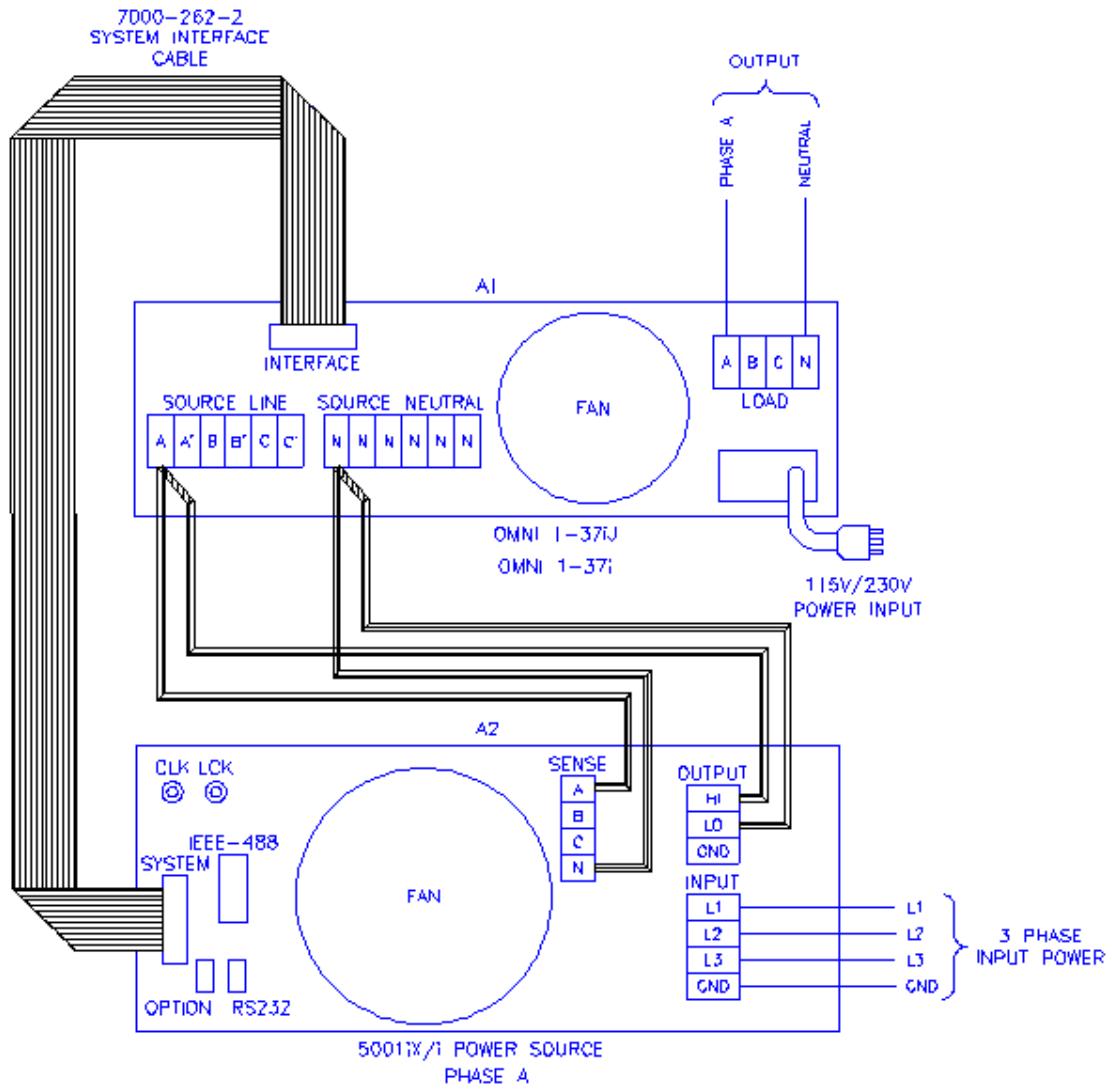
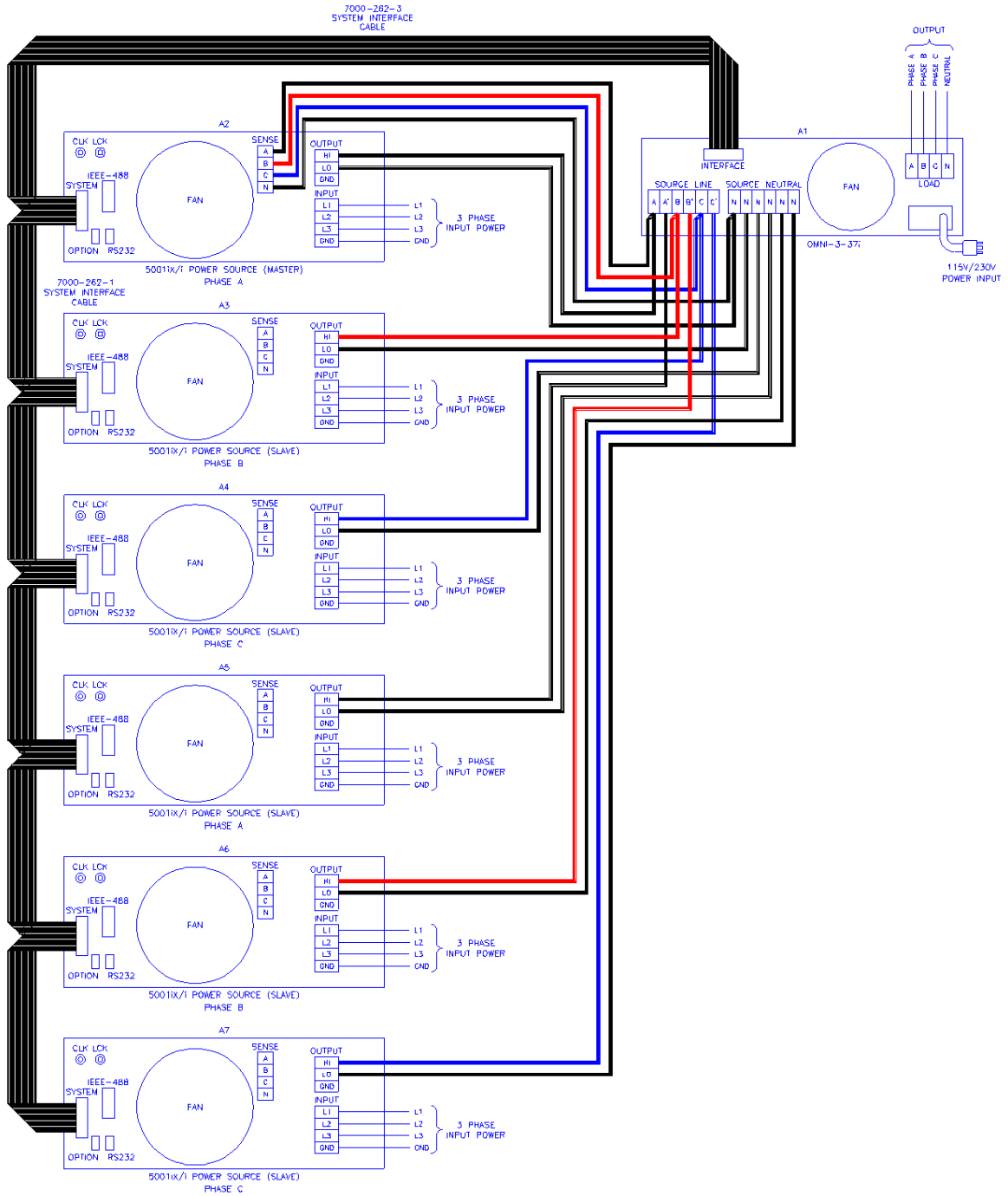

Figure 9-41: Schematic Showing OMNI 3-37i Connected to 30003iX System



## 9.6.6 Operation

---

### 9.6.6.1 General

---

The OMNI impedance network adds resistive and inductive impedance to the output of selected California Instruments power sources/systems to provide power source impedance levels specified for IEC 555-3 flicker testing. For normal (low impedance) power source operation, the impedance that OMNI adds may be shunted by bypass relays selected on the OMNI front panel.

### 9.6.6.2 Omni i Front Panel Controls/Indicators

---

#### Power Switch and Lamp

A power switch turns the OMNI control circuits on or off. A lamp above the switch illuminates when power is on.

#### Flicker On/Off Switch and Lamps

The momentary contact push button Flicker On/Off switch toggles the OMNI mode between bypass function (no added impedance) and flicker function (IEC 555-3 impedance). Lamps above the switch indicate the selected mode.

---

**NOTE: To prevent damage to the OMNI unit, the BYPASS mode must be selected when the power source is operated on low output voltage range or if currents in excess of OMNI ratings will be drawn.**

---

Bypass relays are provided to short out the OMNI impedance so that the power source may be used with its normal low output impedance or whenever the load current will be in excess of the OMNI maximum current rating. When the BYPASS mode is selected, the OMNI impedance is shorted out. When the FLICKER mode is selected, the OMNI impedance is added to the power source output impedance.

Select the BYPASS position when low power source output impedance is required or desirable. This is the case for most tests other than IEC 555-3 flicker tests. Also select the BYPASS position when the power source is operated on the low voltage output range. The low voltage output range can deliver currents well in excess of the OMNI maximum current rating.

### 9.6.6.3 Omni Control Through i/iX Front Panel

---

Select the APPLICATIONS screen from the MENU2 screen. The following screen will appear as shown in Figure 9-42

APPLICATIONS SETUP	
MIL-STD-704	RTCA/DO-160C
<b>OMNI OPTION</b>	IEC 1000-4-11
PREVIOUS SCREEN	

Figure 9-42: Applications Screen

Scroll to the OMNI OPTION entry using the up and down cursor key. Press the ENTER key. The following MENU will appear as shown in Figure 9-43

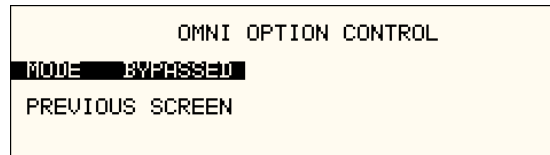

Figure 9-43: OMNI Control Screen

Scroll to the MODE entry using the up and down cursor key. USE the Shuttle Knob to engage the OMNI. The display will indicate that the OMNI mode as shown in Figure 9-44

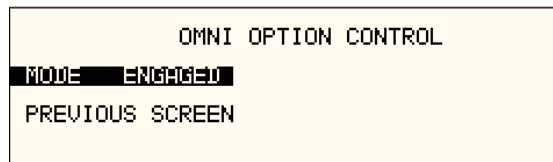

Figure 9-44: OMNI Control Screen

Note: The output of the AC source will drop for about 50 ms when the OMNI MODE changes state.

To Bypass the OMNI, turn the Shuttle Knob counterclockwise.

#### 9.6.6.4 Programmed Control

---

The FLICKER/BYPASS mode may be remotely programmed by the power source if the power source and OMNI are configured for this function. A system interface cable must be connected between the OMNI and the power source to carry the control signal to the OMNI. When configured for programmed control, the OMNI may not be controlled by the front panel FLICKER/BYPASS switch. Refer to the power source manual for details on programming instructions.

### 9.6.6.5 Control Configuration

---

Manual versus programmable control of the OMNI is configured using a two pole DIP switch on the DC Supply/Relay Board assembly inside the OMNI chassis. To reconfigure the control feature, perform the following steps:

**WARNING:** Disconnect all sources of power to the OMNI before performing any of these steps. Hazardous voltages may be present internally from the AC mains and from AC power source connected to the OMNI rear panel.

1. Disconnect all sources of power to the OMNI.
2. Remove the OMNI top cover.
3. Configure S1 DIP switch setting according to table:

MODE	S1 POSITION 1	S1 POSITION 2
Manual	OFF	ON
Programmable	ON	OFF

Note: Position 1 is toward the OMNI front panel, position 2 is toward the OMNI rear panel.

4. Replace the top cover.
5. Reconnect power to the OMNI



## 9.7 LNS Option and XLS Option

The Line Sync option and the External Line Sync option both provide the same function, namely synchronizing the iX output to the input line. The LNS option is internal to the iX power source and will sync the output to the iX input line only.

The XLS option however, is external to the power source, it can be added to the source as needed and it will sync to any line voltage whether it is connected to the iX source or not.

Note: This Feature is not available with the –FC option.

### 9.7.1 Specifications

The -LNS and -XLS options meet the following specifications. The specifications shown here are for these line sync options only. All other power source specifications for i Series and iX Series power systems are covered in their respective data sheets.

<b>Internal Line Sync (-LNS)</b>			
AC Line Voltage input		Taken from AC input	
		Internally in power source	
Frequency		45 – 66	Hz
Phase offset		0.0° - 360.0°	
Phase error		± 1.0°	
<b>External Line Sync (-XLS)</b>			
AC Line Voltage input			
	Low range	80 – 250	V RMS
	High range	250 – 500	V RMS
Frequency		45 – 66	Hz
Phase offset		0.0° - 360.0°	
Phase error		± 1.0°	
Input connectors		Banana Jacks	
		Screw Terminals	
Interface to Power Source		36 Pin System Interface	

**Note:** During external sync mode operation, some features such as clock and lock mode, external sync and frequency transients are disabled.

### 9.7.2 LNS Option (not available with –FC option)

---

The Line Sync Option (LNS) allows the output of the *i/iX* AC Source to be synchronized to the line input. This capability may be needed to support tests that require the use of additional equipment. The –LNS option needs to be ordered at the time of purchase and cannot be installed in the field.

The LNS Option – if installed – can be turned on from the front panel as follows:

Select the PROGRAM 2 screen and move the cursor to the CLK MODE field. The default value for the field is INT for internal clock mode. Use the knob to select the SYNC mode in order to enable the LNS. If the LNS is not installed a “LINE SYNC ERROR” will appear after a short period in the top left of the screen. This means the LNS option is either not present or not receiving a phase input signal from the line.

To turn the sync mode back off, set the CLK MODE field back to INT.

Over the bus, the LNS is enabled or disabled as follows:

```
FREQ:MODE SENS          /* Enables LNS */
FREQ:MODE FIX           /* Disables LNS */
```

If the LNS is not installed and the FREQ:MODE SENS command is issued, an error message is generated. If done as part of a test program, an error check should be done after a 800 msec delay to allow the *i/iX* to sense the presence of a sync signal coming from the LNS board. If no error occurs, the LNS is active. If an error occurs, the LNS may not be available or not functioning and the mode has reverted back to internal.

The LNS option is designed to keep the *iX* output frequency locked to the line frequency. There is a finite phase offset however, between the *iX* source output and the line input to the *iX* power source. This phase offset will vary somewhat with the input line voltage. If it is desired to have the *iX* output in-phase with the line input it will be necessary to monitor the *iX* output voltage as well as the line input to the *iX* source using a two channel oscilloscope to compare the zero-crossings of the voltage waveforms. An isolation amplifier must be used when connecting the input line to the o'scope input. To program an offset angle on the *iX* source, go to PROGRAM 2 screen and select PHASE. Typically 25-30 of phase angle will put the line input and the source output in-phase, but the exact angle to program can only be determined by monitoring the *iX* source output and the line input voltage and comparing the waveforms.

### 9.7.3 XLS Option (not available with –FC option)

---

The External Line Sync option (-XLS) is housed in a small metal enclosure that interfaces to the power source using a system interface cable. This module has a pass-through connector for the system interface so this interface remains available for other purposes.

The external line sync module provides two input voltage ranges, a low range from 80 V to 250 V RMS and a high range from 250 V to 500 V RMS. The AC line voltage can be connected using standard sheathed banana jacks or a screw terminal strip. The -XLS option provides full safety isolation from input to interface connector. The AC line to synchronize the source output to can be the same as the one feeding the source itself, or a different one altogether for greater flexibility.

### 9.7.4 Mechanical Dimensions

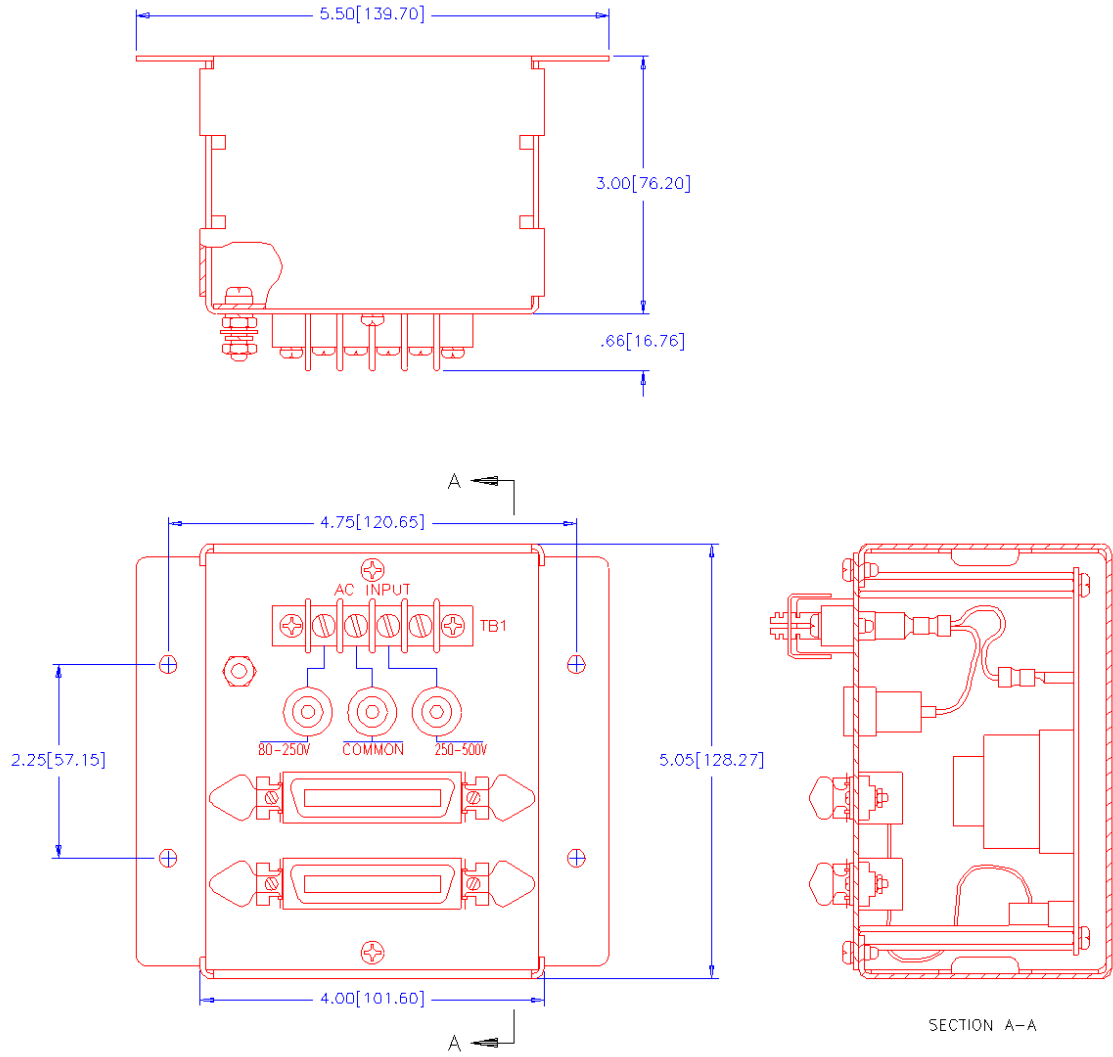

Figure 9-45: XLS Module Dimensions

### 9.7.5 Connection Diagram

The following diagrams illustrate both low range and high range connections between the XLS module, the i/iX Series master power source and the AC Line synchronizing voltage.

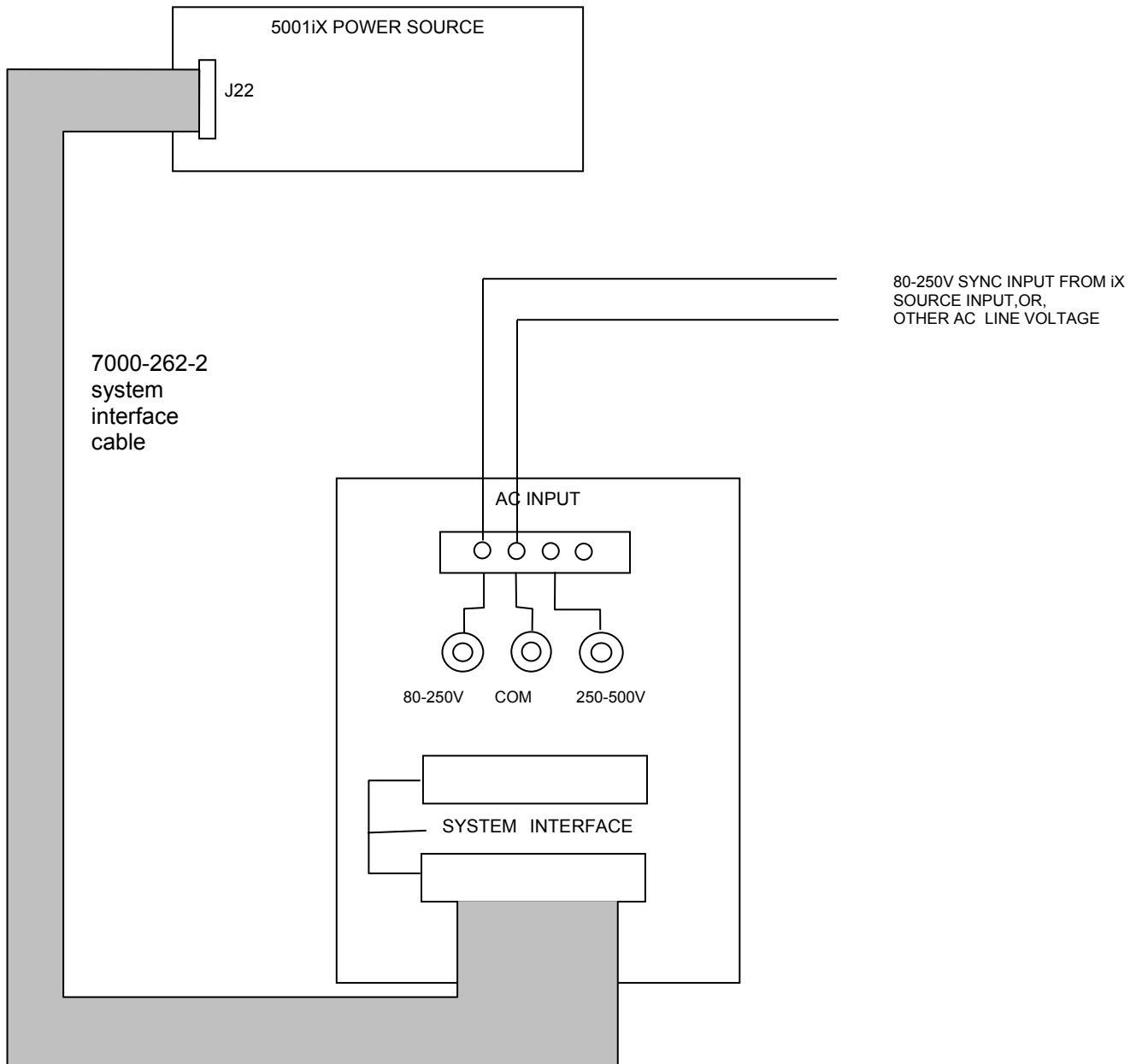

Figure 9-46: XLS Connection on Low Range

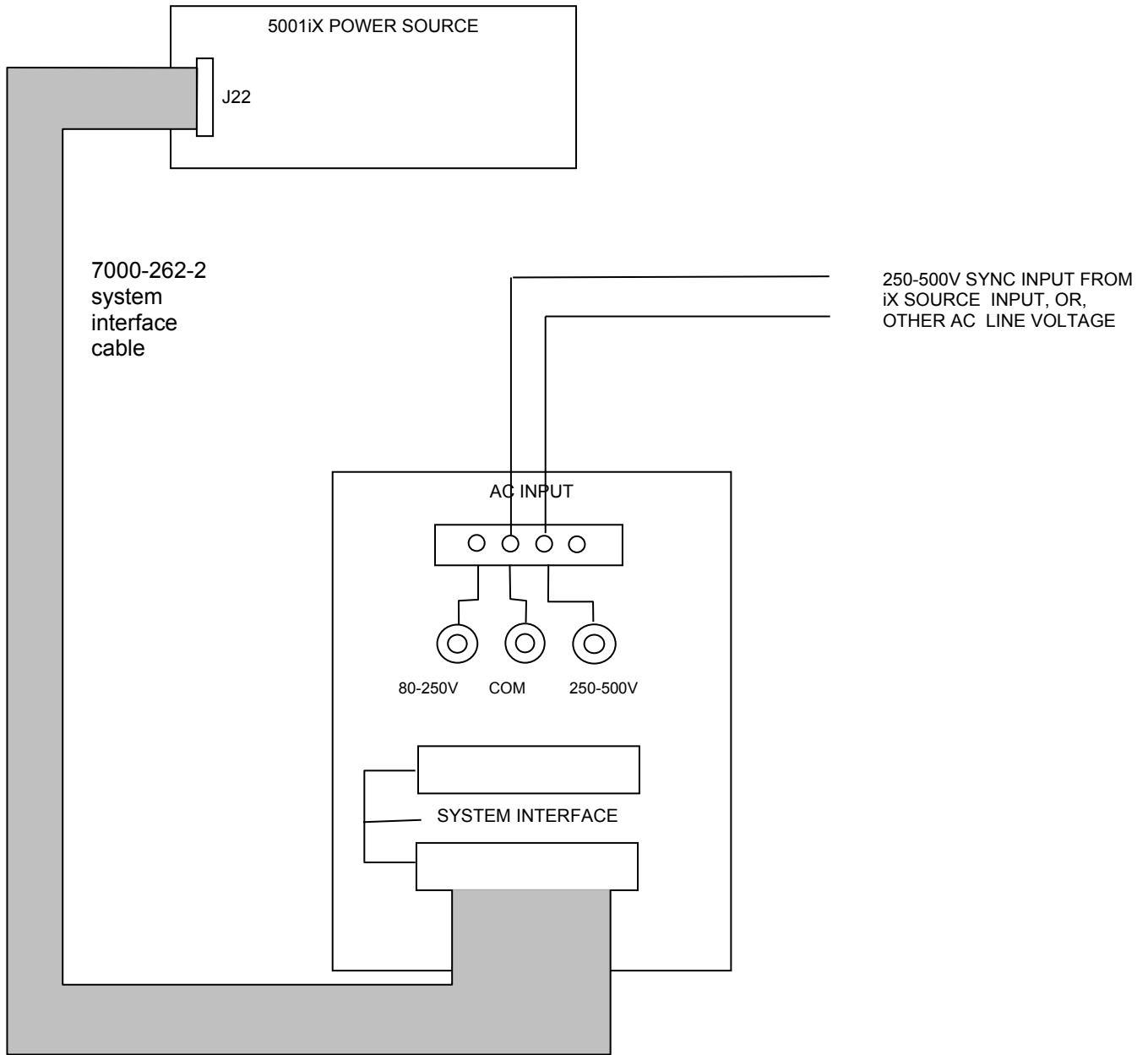

Figure 9-47: XLS Connection on High Range

### 9.7.6 Installation

---

The XLS module can be installed inside a system cabinet or other vertical structure in the vicinity of the iX power source. Refer to Figure 9-46 and Figure 9-47 for connection details. The input voltage can be applied to the AC input terminal strip as shown, or, banana jacks can be used to secure the line voltage to the XLS module. The system interface ribbon cable can be connected to either of the two connectors on the XLS module. The extra connector is provided for pass-through connectivity.

### 9.7.7 XLS Option Operation (not available with –FC option)

---

The External Line Sync option (XLS) allows the output of the i/iX AC Source to be synchronized to any line input, whether it is the line powering the iX source or any other line voltage not necessarily hooked up to the iX source. This capability may be needed to support tests that require the use of additional equipment.

The XLS Option – once installed and connected – can be turned on from the iX front panel as follows:

Select the PROGRAM 2 screen and move the cursor to the CLK MODE field. The default value for the field is INT for internal clock mode. Use the knob to select the SYNC mode in order to enable the XLS. If the XLS is not installed a “LINE SYNC ERROR” will appear after a short period in the top left of the screen. This means the XLS option is either not present or not receiving a phase input signal from the line.

To turn the sync mode back off, set the CLK MODE field back to INT.

Over the bus, the XLS is enabled or disabled as follows:

```
FREQ:MODE SENS          /* Enables XLS */
```

```
FREQ:MODE FIX           /* Disables XLS */
```

If the XLS is not installed and the FREQ:MODE SENS command is issued, an error message is generated. If done as part of a test program, an error check should be done after a 800 msec delay to allow the i/iX to sense the presence of a sync signal coming from the XLS module. If no error occurs, the XLS is active. If an error occurs, the XLS may not be available or not functioning and the mode has reverted back to internal.

The XLS option is designed to keep the iX output frequency locked to the line frequency. There is a finite phase offset however, between the iX source output and the line input to the External Sync Module. This phase offset will vary somewhat with the line voltage going to the XLS module. If it is desired to have the iX output in phase with the line input, it will be necessary to monitor the iX output voltage as well as the line input to the XLS module using a two channel oscilloscope to compare the zero-crossings of the voltage waveforms. An isolation amplifier must be used when connecting the sync input line to the o'scope input. To program an offset angle on the iX source, go to PROGRAM 2 screen and select PHASE. Typically 25-30 of phase angle will put the line input and the source output in-phase, but the exact angle to program can only be determined by monitoring the iX source and the line input voltage and comparing the waveforms.

## **9.8 Option –704: MilStd704 Tests**

---

The MIL704 option is made up of both firmware that resides in the power source and the GUI Windows application program. The firmware covers revision D and E of the Mil-Std704 standard. The GUI covers the remaining revisions A, B, C and F. This provides coverage of all available standard revisions.

The user interface for each implementation is different however. The revision D and E tests can be operated directly from the power source's front panel or through the supplied GUI program. The revision A-C, F tests can only be operated through the supplied GUI program. Thus, for rev A-C and F, a Windows PC and interface is required.

Section 9.8.1 covers operation of the firmware based revision D and E tests.

For information regarding the operation of the MIL-STD-704 revision A, B, C, and F tests with the GUI, please refer to the Avionics Software Manual (CI part no. 4994-971 included on CDROM). Note that future updates of the GUI may include overlapping coverage for revisions D and E in the software as the GUI program is designed to support all revisions. For now, revisions D and E have no associated data files in the GUI.

---

## 9.8.1 Option –704: MIL-STD-704 rev D & E Tests. (Firmware)

---

### 9.8.1.1 General

---

The MIL704 option is capable of performing most sections of MIL-STD-704 rev D and E in either of the AC or DC mode.

**Note: The Distortion Spectrum tests:**

**Table I and II, Figure 7**  
**Table III, Figure 12**  
**Table IV, Figure 18**

**are not supported by the –704 option. These tests require the use of additional external equipment.**

---

### 9.8.1.2 Initial Setup

---

Nominal parameters for the AC Power source are as follows:

Output Voltage	115V L-N
Output Frequency	400 Hz

Nominal parameters for the DC Power source are as follows:

Output Voltage	28V or 270V L-N
----------------	-----------------

A setting outside these nominal values will disable the test and will prevent access to its Menu screens.

### 9.8.1.3 Revision

---

The MIL704 option defaults to Revision E. The System is capable of performing Revision D test by changing the selection to Revision D. All Revision D tests can be performed except for the 270V DC TRANSIENT and ABNORMAL where Revision E level are used despite the revision selection.

**All levels and timing in this document refers to Revision E. For Revision D refer to MIL-STD-704D date 9/30/1980**

### 9.8.1.4 Tests Performed

---

#### 9.8.1.4.1 STEADY STATE

AC Mode:

1. Steady State Voltage and Frequency test
2. Waveform Distortion test
3. Voltage Modulation test
4. Voltage Unbalance test
5. Phase Unbalance test
6. Frequency Modulation test
7. Transient Voltage low and high test
8. Transient Frequency low and high test

DC Mode:



1. Steady State Voltage test
2. Ripple test

#### 9.8.1.4.2 EMERGENCY TEST

AC Mode:

1. Emergency Voltage minimum and maximum test
2. Emergency Frequency minimum and maximum test

DC Mode:

1. Emergency Voltage minimum and maximum test

#### 9.8.1.4.3 ABNORMAL TEST

AC Mode:

1. Abnormal Voltage under
2. Abnormal Voltage over
3. Abnormal Frequency under
4. Abnormal Frequency over

DC Mode:

1. Abnormal Voltage under
2. Abnormal Voltage over

#### 9.8.1.5 Front Panel Entry

To perform a test from the keyboard, from the MENU 2 screen, select the APPLICATIONS screen. The APPLICATIONS screen will appear as shown in Figure 9-48.

APPLICATIONS SETUP	
MIL-STD-704	RTCA/DO-160D
OMNI OPTION	IEC 1000-4-11
PREVIOUS SCREEN	IEC 1000-4-13

Figure 9-48: Application Menu

Scroll to the MIL-STD-704 entry using the up and down cursor keys. Press the ENTER key to select the MIL704 main menu. One of the screens will appear as shown in Figure 9-49. The voltage mode and setting will define which menu to select. Refer to Section 9.8.1.2

**Note:** The user has to turn on the Output relay before starting a test and set the steady state setup for the test.

MIL704 AC MENU		0A
REVISION EE	TRANSIENT	
STEADY STATE	ABNORMAL	
PREVIOUS SCREEN	EMERGENCY	

MIL704 DC MENU		0A
REVISION EE	TRANSIENT	
STEADY STATE	ABNORMAL	
PREVIOUS SCREEN	EMERGENCY TEST	

Figure 9-49: MIL704 Menu

### 9.8.1.6 Revision Selection

The default Revision is E. Revisions supported are D and E. The Revision can be changed from the front panel. Scroll to the REVISION entry using the up and down cursor keys (see Figure 9-49). Use the shuttle to change the selection.

### 9.8.1.7 AC MODE TESTS

#### 9.8.1.7.1 Steady State Test

Scroll to the STEADY STATE AC entry using the up and down cursor keys. Press the ENTER key to select the STEADY STATE screens. The screen will appear as shown in Figure 9-50.



Figure 9-50: Steady State Menu

The MIL704 Steady state 1 and Steady state 2 screens have the following tests:

- 1 VOLTAGE
- 2 FREQUENCY
- 3 VOLT UNBALANCE
- 4 PHASE DIFFERENCE
- 5 VOLT MODULATION
- 6 FREQ MODULATION
- 7 DISTORTION

The above tests can be selected by scrolling to the highlighted selection using the up and down cursor keys and the ENTER key to start the selected test.

#### VOLTAGE

This test will change the output voltage in the following sequence:

- 108V for 1 minute.
- 118V for 1 minute.
- 115V for 1 minute.

The ← key (backspace) will terminate the test at any time.

#### FREQUENCY

This test will change the output frequency in the following sequence:

- 393Hz for 1 minute.
- 407Hz for 1 minute.
- 400Hz for 1 minute.

The ← key (backspace) will terminate the test at any time.

#### VOLT UNBALANCE

This test will change the output voltage for the selected phase only in the following sequence:

- 112V for 1 minute.
- 118V for 1 minute.
- 115V for 1 minute.

The test will be repeated on three phase systems to include all three phases if the coupling is set to all.

The ← key (backspace) will terminate the test at any time.

### **PHASE DIFFERENCE**

This test applies to three phase systems only. The phase angle for the selected phase will change relative to phase A in the following sequence:

If phase B is selected:

- 236° for 1 minute.
- 244° for 1 minute.
- 240° for 1 minute.

If phase C is selected:

- 116° for 1 minute.
- 124° for 1 minute.
- 120° for 1 minute

### **VOLTAGE MODULATION**

This test will vary the output voltage by  $\pm 2.5V$  rms over a period of one second. The test will last for 2 minutes. The ← key (backspace) will terminate the test at any time.

### **FREQUENCY MODULATION**

This test will vary the output frequency by  $\pm 4Hz$  over a period of one minute. The test will last for 4 minutes. The ← key (backspace) will terminate the test at any time.

### **WAVEFORM DISTORTION**

This test will generate a 5% THD voltage distortion on the output voltage waveform. The distortion is caused by using a clipped sinewave. The test will last for 1 minute. The ← key (backspace) will terminate the test at any time.

### 9.8.1.7.2 TRANSIENT TEST

From the MIL704 main menu (Figure 9-49) scroll to the TRANSIENT AC entry using the up and down cursor keys. Press the ENTER key to select the TRANSIENT screens. The screen will appear as shown in Figure 9-51.

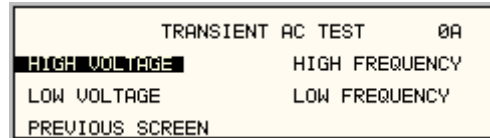

Figure 9-51: Transient Menu

The MIL704 Transient screen has the following tests:

- 1 HIGH VOLTAGE
- 2 LOW VOLTAGE
- 3 HIGH FREQUENCY
- 4 LOW FREQUENCY

The above tests can be selected by scrolling to the highlighted selection using the up and down key and the ENTER key to start the selected test.

#### HIGH VOLTAGE

This test will change the output voltage for the selected phase in the following sequence:

- 180V for 10 msec.
- Linearly reduced to 118V in 78msec.
- Stay at 118V for 87msec before returning to 115V.

Prior to the test, a range change may take place if the power source is set for the low voltage range.

The ← key (backspace) will terminate the test at any time.

**Note:** A range change will result in momentary loss of power to the EUT. If this is not acceptable, the power source must be left in high range at all times.

#### LOW VOLTAGE

This test will change the output voltage for the selected phase only in the following sequence:

- 80V for 10 msec.
- Linearly increase to 108V in 70msec.
- Stay at 108V for 95msec before returning to 115V.

The ← key (backspace) will terminate the test at any time.

#### HIGH FREQUENCY

This test will change the output frequency in the following sequence:

- 425Hz for 1 sec.
- 420Hz for 4 sec.
- 410Hz for 5 sec.
- 407Hz for 4 sec.

#### LOW FREQUENCY

This test will change the output frequency in the following sequence:

- 375Hz for 1 sec.
- 380Hz for 4 sec.
- 390Hz for 5 sec.
- 393Hz for 4 sec.

#### 9.8.1.7.3 EMERGENCY TEST

From the MIL704 main menu (Figure 9-49) scroll to the EMERGENCY AC entry using the up and down cursor keys. Press the ENTER key to select the EMERGENCY screens. The screen will appear as shown in Figure 9-52.

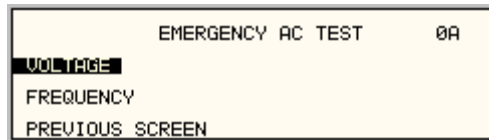

Figure 9-52: Emergency Menu

The EMERGENCY SCREEN has the following tests:

- 1 VOLTAGE
- 2 FREQUENCY

The above tests can be selected by scrolling to the highlighted selection using the up and down key and the ENTER key to start the selected test.

#### **VOLTAGE**

This test will change the output voltage in the following sequence:

- 108V for 1 minute.
- 118V for 1 minute.
- 115V for 1 minute.

The ← key (backspace) will terminate the test at any time.

#### **FREQUENCY**

This test will change the output frequency in the following sequence:

- 393Hz for 1 minute.
- 407Hz for 1 minute.
- 400Hz for 1 minute.

The ← key (backspace) will terminate the test at any time.

#### 9.8.1.7.4 ABNORMAL TEST

From the MIL704 main menu (Figure 9-49) scroll to the ABNORMAL AC entry using the up and down cursor keys. Press the ENTER key to select the ABNORMAL screens. The screen will appear as shown in Figure 9-53.

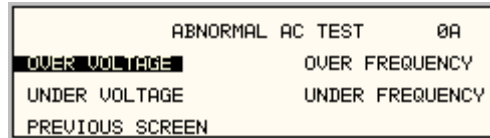

Figure 9-53: Abnormal Screen

The ABNORMAL SCREEN has the following tests:

- 1 OVER VOLTAGE
- 2 UNDER VOLTAGE
- 3 OVER FREQUENCY
- 4 UNDER FREQUENCY

The above test can be selected by scrolling to the highlighted selection using the up and down key and the ENTER key to start the selected test.

#### OVER VOLTAGE

This test will change the output voltage for the selected phase in the following sequence:

- 180V for 50msec.
- The voltage gradually decays with time to 125 volt by the following equation:  

$$V = 124.6 + 2.77/t. \text{ for } 0.05 \leq t \leq 6.925$$
- Stay at 125V for 93 seconds before returning to 115V.

Prior to the test, a range change may take place if the power source is set at the low voltage range.

The ← key (backspace) will terminate the test at any time.

**Note:** A range change will result in momentary loss of power to the EUT. If this is not acceptable, the power source must be left in high range at all times.

#### UNDER VOLTAGE

This test will change the output voltage for the selected phase in the following sequence:

- 0V for 7 seconds.
- 100V for 93 seconds.
- The ← key (backspace) will terminate the test at any time.

#### OVER FREQUENCY

This test will change the output frequency in the following sequence:

- 480Hz for 5 seconds.
- 420Hz for 9 seconds.

The ← key (backspace) will terminate the test at any time.

#### UNDER FREQUENCY

This test will change the output frequency in the following sequence:

- 0Hz for 7 seconds.
- 380Hz for 7 seconds.

The ← key (backspace) will terminate the test at any time.

### 9.8.1.8 DC TESTS

If the output voltage is set for 28V DC or 270V DC the MIL704 DC Main selection screen will appear as seen in Figure 9-54.

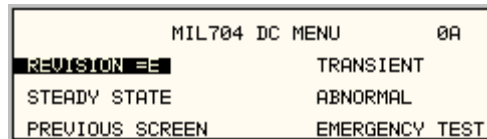

Figure 9-54: MIL704 DC Menu

#### 9.8.1.8.1 Steady State Test

Scroll to the STEADY STATE entry using the up and down cursor keys. Press the ENTER key to select the STEADY STATE screen. The screen will appear as shown Figure 9-55.

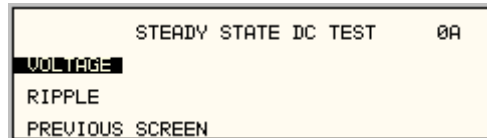

Figure 9-55: Steady State DC

The MIL704 STEADY STATE screen has the following tests:

- 1 VOLTAGE
- 2 RIPPLE

The above tests can be selected by scrolling to the highlighted selection using the up and down key and the ENTER key to start the selected test.

#### VOLTAGE

This test will change the output voltage for the selected phase in the following sequence:

1. 28V system:
  - 22V for 1 minute.
  - 29V for 1 minute.
  - 28V for 1 minute.
2. 270V system:
  - 250V for 1 minute.
  - 280V for 1 minute.
  - 270V for 1 minute.

The ← key (backspace) will terminate the test at any time.

#### DC RIPPLE

This test will impose a 400Hz frequency component to the output voltage. The test will last for 2 minutes. The level of the ripple is as follows:

1. 28V system:

- ±1.5V.
- 2. 270V system:
  - ±6.0V.

The ← key (backspace) will terminate the test at any time.

#### 9.8.1.8.2 Transient Test

From the MIL704 DC MENU scroll to the TRANSIENT DC entry using the up and down cursor keys. Press the ENTER key to select the TRANSIENT screen. The screen will appear as shown in Figure 9-56.

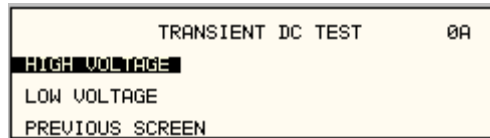

Figure 9-56: Transient Menu

The Transient Test has the following tests:

- 1 HIGH VOLTAGE
- 2 LOW VOLTAGE

#### HIGH VOLTAGE

This test will change the output voltage for the selected phase in the following sequence:

1. 28V System
  - 50V for 12.5 msec.
  - Linearly reduce to 29V in 70msec.
  - Stay at 29V for 92.5msec before returning to 28V.
2. 270V System
  - 330V for 20 msec.
  - Linearly reduce to 280V in 20msec.
  - Stay at 280V for 135msec before returning to 270V.

Prior to the test, a range change may take place if the power source is set for the low voltage range.

The ← key (backspace) will terminate the test at any time.

**Note:** A range change will result in momentary loss of power to the EUT. If this is not acceptable, the power source must be left in high range at all times.

#### LOW VOLTAGE

This test will change the output voltage for the selected phase in the following sequence:

1. 28V System
  - 18V for 15 msec.
  - Linearly increase to 22V in 85msec.
  - Stay at 22V for 75msec before returning to 28V.



## 2. 270V System

- 200V for 10 msec.
- Linearly increase to 250V in 30msec.
- Stay at 250V for 135msec before returning to 270V.

The ← key (backspace) will terminate the test at any time.

### 9.8.1.8.3 Abnormal Test

From the MIL704 DC MENU scroll to the ABNORMAL DC entry using the up and down cursor keys. Press the ENTER key to select the ABNORMAL screen. The screen will appear as shown in Figure 9-57.

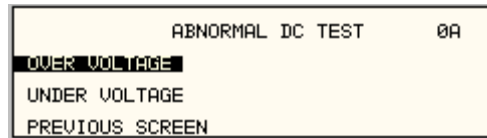

Figure 9-57: Abnormal Test Screen

The Abnormal Test has the following tests:

- 1 OVER VOLTAGE
- 2 UNDER VOLTAGE

The above tests can be selected by scrolling to the highlighted selection using the up and down cursor keys and the ENTER key to start the selected test.

#### OVER VOLTAGE

This test will change the output voltage for the selected phase in the following sequence:

1. 28V system:
  - 50V for 50msec.
  - The voltage gradually decays with time to 31.5 volts by the following equation:  
 $V = 31.38 + 0.93/t$  for  $0.05 \leq t \leq 7.758$
  - Stay at 31.5V for 92.242 seconds before returning to 28V.
2. 270V system:
  - 350V for 50msec.
  - The voltage gradually decays with time to 290 volts by the following equation:  
 $V = 289.6 + 3.02/t$  for  $0.05 \leq t \leq 7.55$
  - Stay at 290V for 92.45 seconds before returning to 270V.

Prior to the test, a range change may take place if the power source is set at the low voltage range. Note: See Section 9.8.1.7.2 under HIGH VOLTAGE.

The ← key (backspace) will terminate the test at any time.

**Note:** A range change will result in momentary loss of power to the EUT. If this is not acceptable, the power source must be left in high range at all times.

#### UNDER VOLTAGE

This test will change the output voltage for the selected phase in the following sequence:

1. 28V system:

- 0V for 7sec.
  - 20V for 93sec.
2. 270V system:
    - 0V for 7sec.
    - 240V for 93sec.

The ← key (backspace) will terminate the test at any time.

#### 9.8.1.8.4 Emergency Test

From the MIL704 DC MENU scroll to the EMERGENCY DC entry using the up and down cursor keys (Figure 9-58). Press the ENTER key to start the EMERGENCY TEST.

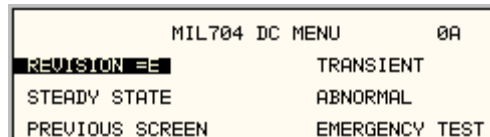

Figure 9-58: Emergency Test

#### VOLTAGE

This test will change the output voltage for the selected phase in the following sequence:

1. 28V system:
  - 18V for 1 minute.
  - 29V for 1 minute.
  - 28V for 1 minute.
2. 270V system:
  - 250V for 1 minute.
  - 280V for 1 minute.
  - 270V for 1 minute.

The ← key (backspace) will terminate the test at any time.

### **9.9 ABD Option: Airbus ABD0100.1.8 Test**

---

For information regarding the operation of the ABD0100.1.8 tests with the CIGuiSII, please refer to the Avionics Software Manual (CI part no. 4994-971 included on CDROM).

### **9.10 AMD Option: Airbus AMD24C Test**

---

For information regarding the operation of the Airbus AMD24C tests with the CIGuiSII, please refer to the Avionics Software Manual (CI part no. 4994-971 included on CDROM).

### **9.11 A350 Option: Airbus A350 (ABD0100.1.8.1) Test**

---

For information regarding the operation of the Airbus A350 tests with the CIGuiSII, please refer to the Avionics Software Manual (CI part no. 4994-971 included on CDROM).

### **9.12 787 Option: Boeing B787-0147 Test**

---

For information regarding the operation of the Boeing B787-0147 tests with the CIGuiSII, please refer to the Avionics Software Manual (CI part no. 4994-971 included on CDROM).

## 9.13 WHM Option

### 9.13.1 General

This section describes the WHM option for the i / iX Series Power Source.

### 9.13.2 Specification

All specifications are the same as the standard i / iX Power Source specifications in addition to the following specifications:

Watt-hour

0-6.000KW	0.01KWH + 0.1% <100Hz
	0.02KWH +0.1% 100-500Hz
>6.000KW	Times three of the above specification

### 9.13.3 Local Operation

- From the Menu screen 2, select the APPLICATIONS SETUP 2 screen. The screen will appear as shown in Figure 9-59. Use the up and down key to position the cursor to the WH METER field. Press the Enter Key.

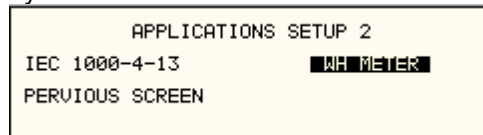

Figure 9-59: Application Screen

- The WATT-HOURS METER screen shown in Figure 9-60 has the following fields:

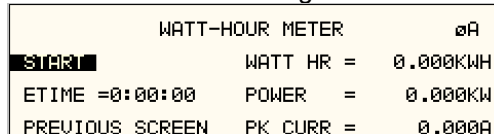

Figure 9-60 Watt-Hour Meter Screen

START: This field will activate the watt-hour measurements. Moving the shuttle clockwise when the field is highlighted will activate the watt hour function and the field will change to STOP as shown in Figure 9-61.

- ETIME: This field will accumulate the time in hours, minutes and seconds.
- WATT HR: This field will accumulate the watt-hour in KWH.
- POWER: This field will report the instantaneous power in KW.
- PK CURR: This field will report the peak current and will hold the maximum reading.

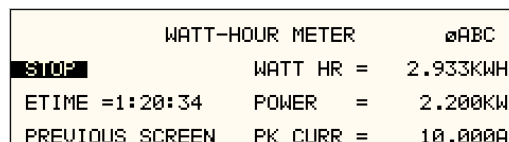

Figure 9-61: WH-Meter Screen With Function Active

**Note:** Changing from stop to start will stop the measurement and will maintain the last data record for the watt-hour meter. To restart the measurements, the field is toggled to the stop position from the start position and the previous data will be reset to zeros.

WATT HR, POWER and PK CURR will display the data for the phase selected with the phase key. If the phase is selected for all phases in a two or three phase system, the WATT HR and POWER fields will show the sum of all phases. PK CURR will remain at the last selected phase.

**Note:** Changing Mode of operation from single phase to three phases while the Watt-hour meter is in the active state will generate an error: "Input buffer full". This error will halt the measurements. To clear the error, the Watt-hour meter must be switched to the stopped state. It is advised that the Watt-hour meter should be set to the stop state before changing the mode of operation.

### 9.13.4 Remote PROGRAMMING

The following SCPI command will be used to control the WHM functions:

WHMeter:

[STATe]	Turn on or of the watt hour function
ETIMe?	Return the elapse time
WHOur?	Return the watt-hour in KWH

#### WHMeter[:STATe]

This command will start or stop the watt-hour function.

Command Syntax	WHMeter[:STATe]<bool>
Parameters	0   OFF   1   ON
Examples	WHM ON
Query Syntax	WHM[:STATe]?
Returned Parameters	0   1

#### WHMeter:ETIMe?

This command will return the total amount of time the watt-hour meter accumulated. The returned data has four fields separated by commas. These fields are hours, minutes, seconds and milliseconds.

Command Syntax	WHMeter:ETIMe?
Parameters	none
Query Syntax	WHM:ETIM?
Returned Parameters	h,mm,ss,ms

#### WHMeter:WHOur?

##### *Phase Selectable*

This command will return the total accumulated kilowatt-hour for the selected phase. If coupling is set to all, the value returned is the sum of all phases in the system irregardless of the selected phase.

Command Syntax	WHMeter:WHOur?
Parameters	none
Query Syntax	WHM:WHO?
Returned Parameters	<numeric value>

**Note:** If the watt-hour meter is active, the total power of all phases in the system will be returned when querying the power.

### 9.13.5 FC Option

This option when enabled will cause the frequency to sweep around the program frequency with a deviation of  $\pm 0.25\%$  of the program frequency.

## Error Messages

Any errors that occur during operation from either the front panel or the remote control interface will result in error messages. Error messages are displayed in the upper left hand corner of the LCD display. They are also stored in the error message queue from which they can be queried using the SYST:ERR? Query. The error queue has a finite depth. If more error messages are generated than can be held in the queue, a queue overflow message will be put in the last queue location. To empty the queue, use the error query until the No Error result is received.

Errors appearing on the LCD will generally remain visible until the user moves to another screen. If multiple error messages are generated in succession, only the last message will be visible as there is only space for one error message on the LCD display.

The same area of the display is also used to display status messages. While error messages always have a negative error number, status messages have a positive number.

The table below displays a list of possible error and status messages along with their possible cause and remedy.

Number	Message String	Cause	Remedy
0	"No error"	No errors in queue	
-100	"Command error"	Unable to complete requested operation	Unit may be in a mode inconsistent with request.
-102	"Syntax error"	Command syntax incorrect.	Misspelled or unsupported command
-103	"Invalid separator"	SCPI separator not recognized	See SCPI section of programming manual.
-104	"Data type error"	Data type invaled.	Check command for supported data types
-108	"Parameter not allowed"	One or more additional parameters were received.	Check programming manual for correct number of parameters
-109	"Missing parameter"	Too few parameters received for requested operation	Check programming manual for correct number of parameters
-110	"Command header error"	Command header incorrect	Check syntax of command.
-111	"header separator error"	Invalid command separator used.	Use semi-colon to separate command headers
-112	"Program mnemonic too long"	Syntax error	Check programming manual for correct command syntax
-113	"Undefined header"	Command not recognized error	Check programming manual for correct command syntax
-120	"Numeric data error"	Data received is not a number	Check programming manual for correct command syntax
-121	"Invalid character in number"	Number received contains non-numeric character(s)	Check programming manual for correct command syntax
-123	"Exponent too large"	Exponent in number exceeds limits	Check programming manual for correct parameter range
-128	"Numeric data not allowed"	Number received when number is not allowed.	Check programming manual for correct command syntax
-168	"Block data not"	Block data was sent.	Check programming manual for

Number	Message String	Cause	Remedy
	allowed"		correct command syntax
-200	"Execution error"	Command could not be executed	Command may be inconsistent with mode of operation such as programming frequency when in DC mode.
-201	"Invalid while in local"	Command issued but unit is not in remote state	Put instrument in remote state before issuing GPIB commands.
-203	"Command protected"	Command is locked out	Some commands are supported by the unit but are locked out for protection of settings and are not user accessible.
-210	"Trigger error"	Problem with trigger system.	Unit could not generate trigger for transient execution or measurement.
-211	"Trigger ignored"	Trigger request has been ignored.	Trigger setup incorrect or unit was not armed when trigger was received. Check transient system or measurement trigger system settings.
-213	"Init ignored"	Initialization request has been ignored	Unit was told to go to armed state but was unable to do so. Could be caused by incorrect transient system or measurement acquisition setup.
-220	"Parameter error"	Parameter not allowed.	Incorrect parameter or parameter value. Check programming manual for allowable parameters
-221	"Setting conflict"	Requested setting conflicts with other setting in effect.	Check other settings. E.g. trying to program a DC offset while in AC mode
-222	"Data out of range"	Parameter data outside of allowable range.	Check programming manual for allowable parameter values
-223	"Too much data"	More data received than expected	Check programming manual for number of parameters or data block size
-224	"Illegal parameter value"	Parameter value is not supported	Check programming manual for correct parameters
-226	"Lists not same length"	One or more transient lists programmed has different length.	All lists must be of same length or transient cannot be compiled and executed.
-241	"Hardware missing"	N/A	N/A
-254	"Media full"	No storage space left to save settings or data.	Delete other settings or data to make room.
-255	"Directory full"	Too many waveform directory entries	Delete one or more waveforms from waveform memory to make room.
-256	"File name not found"	Waveform requested not in directory	Check waveform directory for waveform names present.
-257	"File name error"	Incorrect filename	Too many or non ASCII characters used in waveform file definition.
-283	"Illegal variable name"	Variable name illegal.	Use ASCII characters only



Number	Message String	Cause	Remedy
-300	"Device specific error"	Hardware related error	Check hardware for proper operation.
-311	"Memory error"	Waveform memory checksum error.	May be the result of incomplete user-defined waveform download. Check interface and try downloading waveform again. Successful download may clear this error condition. Alternatively, use TRAC:DEL:ALL command to clear waveform memory.
-314	"Save/recall memory lost"	User setup register contents lost	Store setup in same register again.
-315	"Configuration memory lost"	Hardware configuration settings lost.	Contact AMETEK service department at <a href="mailto:service.ppd@ametek.com">service.ppd@ametek.com</a> to obtain instructions on restoring configuration data.
-330	"Self-test failed"	Internal error	Contact AMETEK service department at <a href="mailto:service.ppd@ametek.com">service.ppd@ametek.com</a>
-350	"Queue overflow"	Message queue full.	Too many messages. Read status using SYST:ERR query until 0, "No Error" is received indicating queue empty.
-400	"Query error"	Unable to complete query.	Check programming manual for correct query format and parameters
-410	"Query INTERRUPTED"	Query issued but response not read.	Check application program for correct flow. Response must be read after each query to avoid this error.
-420	"Query UNTERMINATED"	Query incomplete.	Check for terminator after query command.
-430	"Query DEADLOCKED"	Query cannot be completed	Check application program for multiple queries
-440	"Query UNTERMINATED"	Query incomplete.	Check for terminator after query command.
1	"Output volt fault"	Output voltage does not match programmed value.	Load exceeds current limit and unit is in Constant Voltage (CV) mode of operation. Reduce load or increase CL setting Output voltage is driven above programmed voltage by external influence (Load, voltage kickback, etc.)
2	"Current limit fault"	Current limit exceeded.	Load exceeds current limit and unit is in Constant Voltage (CV) mode of operation. Reduce load or increase CL setting
3	"Temperature fault"	Temperature of heat sink too high.	Reduce load. Ensure proper air flow and exhaust clearance. Check fan(s) for operation.
4	"External sync. error"	Could not sync to external sync signal.	External sync signal missing or disconnected or out of range.
5	"Initial memory lost"	Power on settings could not be recalled.	Save power on settings again to overwrite old content.

Number	Message String	Cause	Remedy
6	"Limit memory lost"	Hardware configuration settings lost.	Contact CI service department at <a href="mailto:service.ppd@ametek.com">service.ppd@ametek.com</a> to obtain instructions on restoring configuration data.
7	"System memory lost"	Memory corrupted.	Recycle power.
8	"Calibration memory lost"	Calibration data lost.	Contact AMETEK service department at <a href="mailto:service.ppd@ametek.com">service.ppd@ametek.com</a> to obtain instructions on restoring calibration data or recalibrate unit.
9	"Start angle must be first sequence"	Start phase angle in wrong place..	Start phase angles can only programmed at the start of a transient list. Once a transient is in progress, phase angle cannot be changed.
10	"Illegal for DC"	Operation not possible in DC mode.	Switch to AC or AC+DC mode.
11	"Duplicate sequence"	N/A	N/A
12	"Too many sequence"	N/A	N/A
13	"Missing list parameter"	One or more transient list parameters missing.	Check programmed lists.
14	"Voltage peak error "	Peak voltage exceeds internal bus voltage	This error may occur when selecting user defined wave shapes with higher crest factors. Reduce programmed RMS value.
15	"Slew time exceed dwell"	Time needed to slew to final value is less than dwell time.	Check dwell times in transient list settings. Increase dwell time or change slew rate for affected parameter.
16	"Illegal during transient"	Operation requested not available while transient is running.	Wait till transient execution is completed or abort transient execution first.
17	"Output relay must be closed"	Operation not possible with open relay	Close relay before attempting operation. E.g. transient execution requires output relay to be closed.
18	"Trans. duration less then 1msec"	Dwell time below minimum or 1 msec	Increase dwell time to at least 1 msec.
19	"Clock and sync must be internal"	Operation not possible with external clock	Switch to internal sync. (Default)
20	"Input buffer full"	Too much data received.	Break up data in smaller blocks.
21	"EOS Fault"	Hardware error reported by EOS option	Cycle power on EOS to reset error. If error persist, contact Contact AMETEK service department at <a href="mailto:service.ppd@ametek.com">service.ppd@ametek.com</a> for repair.
22	"Waveform harmonics limit"	Harmonic contents of user defined wave shape is too high and could damage amplifier output stage.	Reduce harmonic content or reduce fundamental frequency programmed.

Number	Message String	Cause	Remedy
23	"ALC or Impedance must be off"	Conflict between ALC and programmable impedance mode.	Turn off ALC to use programmable impedance. Turn off programmable impedance to use ALC.
24	"Output Relay must be closed"	Attempt to change voltage range while output relay is closed.	Open output relay first, then change range.
25	"Overvoltage Protection Trip"	Over voltage trip limit exceeded.	Check for inductive kickbacks or overshoot on eut.
26	"Peak Current Protection Trip"	Peak current exceeds trip limit.	Reduce load or increase trip level.
29	"DC component exceed limit"	Waveform selected has too much DC content to be supported on AC coupled voltage range.	Use AC waveform without DC offset only or select DC coupled voltage range. (Does not apply to iM/i/iX Series. Applies to MX Series with – HV models only).

*Table 9-22: Error Messages.*

## 10. Index

<b>+</b>		Current	
+/- key .....	61	peak repetitive .....	23
<b>1</b>		current limit .....	123, 125
15003iX-MODE .....	96	custom waveforms .....	101
<b>7</b>		creating .....	101
704 .....	231, 232	deleting .....	102
<b>9</b>		downloading .....	102
9003iX-MODE .....	96	<b>D</b>	
<b>A</b>		DC offset .....	69
A350 Option .....	243	DC output choke .....	129
ABD option .....	243	DC-DC converter .....	150
ABD0100.1.8 .....	95	Dimensions .....	26
AC inductors .....	129	Disassembly procedure .....	151
Acoustic .....	27	Distorted output .....	146
active group .....	101	DVM .....	125
ALC mode .....	90	<b>E</b>	
AMD Option .....	243	Efficiency .....	15
arrow keys .....	59	Emissions .....	27
assembly part numbers .....	14	EOS	
aux. PS .....	125	State .....	174
<b>B</b>		error messages .....	247
B787 Option .....	243	Ethernet .....	89
blinking		<b>F</b>	
parameter entry .....	59	fan .....	123
bridge rectifier .....	122	FFT	
<b>C</b>		analysis .....	107
calibration		data displays .....	108
impedance .....	140	Finish	
measurements .....	133, 134	paint .....	26
non-routine .....	142	Frequency Range .....	22
output .....	138	front panel .....	58
calibration factors .....	97, 98	lock .....	58
CE" mark .....	27	front panels	
circuit breaker .....	58, 122	blank .....	46
clip level .....	81	function strobe .....	40, 201
clock and lock .....	46	Function Strobe .....	25, 35
Clock and Lock		Function Strobe BNC	
-LKS configuration .....	94	accessory .....	40
clock mode .....	69	Functional Test .....	46
constant current .....	125	Fuse check .....	149
Construction		fuses	
internal .....	26	functions .....	149
Controllers		<b>G</b>	
programable .....	28	gate drive .....	126, 150
Cooling .....	26	GPIB .....	89
		<b>H</b>	
		handles .....	29

Hold-Up Time .....	15	<b>N</b>	Noise .....	22
<b>I</b>		<b>O</b>		
IEC 1000-4-11 .....	94	Offset Voltage		
IEC 61000-4-11		DC .....	22	
Edition 1.0 .....	171	oscillator .....	123, 150	
Edition 2.0 .....	171	oscillator assembly .....	123	
IEEE-488 .....	89	output		
IGBT's .....	126, 129	frequency .....	68	
checking .....	149	voltage .....	68	
iM Series .....	13	output calibration .....	98	
Immunity .....	27	output mode .....	69	
impedance calibration .....	140	OUTPUT ON/OFF key .....	60	
Inrush Current .....	15	OUTPut[:STATe] .....	246	
installation .....	32	over voltage .....	147	
Introduction .....	13	overcurrent .....	125, 147	
Isolation Voltage .....	15	Overcurrent .....	25	
<b>K</b>		overload .....	58	
keypad .....	60	Overtemperature .....	25	
function .....	60	Overvoltage .....	25	
knob .....	59	<b>P</b>		
<b>L</b>		parallel .....	129	
LAN .....	24, 89	Parallel .....	28	
Configuration .....	87	phase angle .....	69	
connector .....	39	PHASE key .....	60	
MAC Address .....	39	power factor .....	122	
Settings .....	87	Power Factor .....	15	
-LAN option .....	29	PROG key .....	60	
LCD display .....	63	Programmable Impedance .....	28	
LED .....	125, 129, 146	-MODE option .....	29	
DC-DC .....	150	pulse transient .....	116	
DC-DC output .....	126	PWM .....	126	
LED		<b>R</b>		
aux. PS .....	149	registers .....	81	
LED indicators .....	146	regulators		
Line Current .....	15	TO220 .....	129	
Line Frequency .....	15	relay .....	126, 129, 150	
Line VA .....	15	Relay		
list transient .....	117	output .....	28	
load sharing .....	126	remote control .....	58	
<b>M</b>		Remote Inhibit .....	25, 41	
MAC Address .....	39	repeat .....	81	
maintenance .....	145	replacement parts .....	152	
Material		RJ45		
chassis .....	26	connector .....	39	
MEAS key .....	60	RS232 .....	89	
measurement calibration .....	97	Cable .....	37	
MENU key .....	60	Connector .....	37	
MIL/STD-704 .....	94	RTCA DO160 .....	94	
MODE .....	96	<b>S</b>		
models		Safety .....	27	
voltage rating .....	31			
MS704 .....	95			

sense.....	146	transients	
wiring .....	32	list.....	117
Series I .....	14	pulse.....	116
Series II .....	14	slew rate.....	119
SET key.....	61	step .....	115
SET mode .....	59	switching waveforms .....	120
Shock .....	26	Transients	
Short Circuit		Input .....	25
current.....	25	Trigger Out BNC	
shuttle.....	59	accessory .....	40
SET mode.....	59	trigger output.....	25, 40
Shuttle		Trigger output .....	35
IMMEDIATE mode.....	59	troubleshooting .....	145
single phase .....	46, 125	<b>U</b>	
to three phase.....	46	UP key .....	61
slew rates .....	119	USB .....	24, 89
status.....	58	connector .....	38
step transient.....	115	<b>V</b>	
system		Vibration.....	26
single phase .....	13	volt mode .....	69
three phase.....	13	voltage drop	
system interconnect .....	122	cables.....	33
system interface .....	46, 125	voltage ranges .....	46
<b>T</b>		<b>W</b>	
temperature		WAVE key.....	60
over.....	58	waveform	
Temperature		data displays .....	110
operating,storage.....	26	Waveform	
terminal block		acquisition .....	109
connections .....	26	waveform group .....	91
three phase .....	46	Weight.....	26
output.....	46	WHM .....	94
Three phase .....	122	Wire Sizes.....	33
Three Phase.....	28	wiring	
top cover		input .....	32
removal.....	148		
transient			
execution .....	121		
transient execution .....	81		