

Faith费思®

Programmable DC Power Supply

User's Manual

(FTP9000 Series)

©Copyright Faithtech

Version V1.03

2021-06

Preface

Dear Sirs,

Thank you for purchasing Faithtech FT9000 Series programmable DC power supplies. This manual contains detailed information about FTP9000 Series' installation, operation, and specifications, etc..

Please read this manual carefully for using this product safely and correctly, especially safety precautions.

Please keep this manual properly for future use.

Notice

All rights are reserved by Faithtech. This manual is only for reference. Information may be revised without prior notice. Faithtech shall not be liable for possible errors or damages caused by using this manual.

Please visit our website <http://www.faithtech.cn> for latest information.

Product Warranty

Faithtech promises that specifications and features of FTP9000 Series power supplies have completely met all technical indexes claimed in this manual. We strictly check raw materials and manufacturing technology to ensure the stability and credulity of products.

Warranty Service

From the date of purchase warranty, within the one-year warranty period, Faithtech will provide free repair for all faults in the normal usage and maintenance of the product. The user need prepay one-way freight for sending the product to the service department. The return freight will be paid by Faithtech. If products are returned from other countries for maintenance service, then you should pay all freight, duties and other taxes.

Warranty Limitation

The warranty is only limited to the power supply host. Faithtech will not provide free repair if the product is damaged by misuse, negligence, unauthorized modifications, abnormal application environment or force majeure, instead Faithtech shall provide estimated maintenance cost before the repair.

This warranty is in lieu of all other warranties. Faithtech does not make any other warranties, expressed or implied, including guarantees of merchantability, reasonableness and applicability of certain specific applications, which might arise in the contract, civil negligence or others.

Faithtech assumes no responsibility for its product being used in a hazardous or dangerous manner either alone or in conjunction with other equipment. High voltage used in some instruments may be dangerous if misused. Special disclaimers apply to these instruments. Faithtech assumes no liability for any special, incidental or indirect damages.

Safety Abstract

Please observe important safety instructions strictly in the process of operating and repairing the power supply. Not observing safety precautions or warnings in this manual will probably weaken protective functions provided by the power supply. Faithtech will not assume any liability for damages if the user does not observe those safety precautions.

Important Safety Instructions

- **Ensure proper grounding.** Before turning on the power supply, please make sure that the power supply is reliably grounded to prevent electric shock.
- **Three-phase 380VAC input.** Make sure the input wire meets the specified standards, and a protective cover must be installed to prevent electric shock.
- **Output cable connection.** Make sure the output wire meets the specified standards, and a protective cover must be installed to prevent electric shock.
- **Do not open the instrument case.** Operators are not allowed to open the shell of the power supply. Non-professionals are not allowed to repair or adjust.
- **Do not use in a hazardous or dangerous manner** either alone or in conjunction with other equipment. Operating in inflammable or explosive environment is strictly forbidden.

Safety Symbols

Please see the following table for meanings of international symbols applied in the mainframe or the user's manual.



WARNING: To avoid injury, death of personnel, or damage to the instrument, the operator must refer to the explanation in the instruction manual.



High temperature: This symbol indicates the temperature is hazardous to human beings. Do not touch it to avoid any personal injury.



DANGER: High voltage.



Protective grounding terminal: This symbol indicates that the terminal must be connected to ground before operation of the equipment to protect against electrical shock in case of a fault.



The **WARNING** sign highlights an essential operating or maintenance procedure, practice, condition, statement, etc., which if not strictly observed, could result in injury to, or death of personnel or long term health hazards.



The **CAUTION** sign highlights an essential operating or maintenance procedure, practice, condition, statement, etc., which if not strictly observed, could result in damage to, or destruction of equipment.



The **Notice** sign highlights an essential operating or maintenance procedure, condition, or statement.

More safety symbols table

| Symbol | Meaning | Symbol | Meaning |
|--------|--------------------------------|--------|-----------------------|
| | Direct Current (DC) | | Neutral Line |
| | Alternating Current (AC) | | Live Line |
| | Alternating and Direct Current | | Protective Earth Line |
| | 3 Phase AC Current | | On / Off (Power) |
| | Earth | | Back up (Power) |
| | Signal Earth | | Press (Button switch) |
| | Mainframe or Chassis | | Pop (Button switch) |

Table Of Contents

| | |
|--|--------|
| 1. GENERAL DESCRIPTION | - 6 - |
| 1.1 Overview | - 6 - |
| 1.2 Main features | - 6 - |
| 1.3 Dimension diagram | - 7 - |
| 1.3.1 Model of 5kW, 10kW, 15kW | - 7 - |
| 1.3.2 Model of 20kW, 25kW, 30kW | - 8 - |
| 1.4 Model Naming | - 9 - |
| 1.5 Specification sheet | - 9 - |
| 2. Quick Guide | - 13 - |
| 2.1 Checking Goods | - 13 - |
| 2.2 Front Panel | - 14 - |
| 2.3 Keyboard | - 14 - |
| 2.4 Screen Display | - 16 - |
| 2.5 Rear Panel | - 17 - |
| 2.6 Installing | - 18 - |
| 2.6.1 Preparation For Use | - 18 - |
| 2.6.2 Requirements of Input Power | - 18 - |
| 2.6.3 Power ON Self Check | - 18 - |
| 2.7 Connection | - 19 - |
| 2.7.1 Input Connection | - 19 - |
| 2.7.2 Input Connection for Multiple Power Supplies | - 19 - |
| 2.7.3 Output Connection | - 20 - |
| 2.7.4 Remote Sensing Connection | - 20 - |
| 2.7.5 PRO-INT Analog Interface | - 21 - |
| 3. FUNCTION INTRODUCTION | - 22 - |
| 3.1 Local & remote operation mode | - 22 - |
| 3.2 Menu Layout | - 22 - |
| 3.2.1 Set Menu | - 22 - |
| 3.2.2 System Menu | - 24 - |
| 3.2.3 Edit Menu | - 24 - |
| 3.2.4 About Menu | - 24 - |
| 3.3 Static Output Function | - 25 - |
| 3.3.1 Power supply output modes | - 26 - |
| 3.3.2 Limit Voltage/Current/Power Set | - 26 - |
| 3.4 Voltage Slew Rate And Current Slew Rate | - 27 - |
| 3.5 CV/CC Priority Start function | - 27 - |
| 3.6 Output Control | - 28 - |
| 3.7 Analog interface (optional PRO-INT interface) | - 28 - |
| 3.7.1 Analog Programming | - 28 - |
| 3.7.2 External Control | - 30 - |
| 3.7.3 Voltage, Current Monitoring Output | - 31 - |

- 3.7.4 Output Mode & Status Monitoring..... - 31 -
- 3.8 Protection..... - 32 -**
- 3.9 Save And Recall..... - 33 -**
- 3.10 Power-down Save..... - 34 -**
- 3.11 Keyboard Lock And Unlock..... - 35 -**
- 3.12 Sequence (SEQ) Function..... - 35 -**
- 3.13 Internal Resistance Simulation (RESI)..... - 37 -**
- 3.14 Voltage ramp-up, ramp-down (RAMP)..... - 38 -**
- 3.15 Master-slave Parallel..... - 40 -**
 - 3.15.1 Master-slave parallel connection..... - 40 -
 - 3.15.2 Master-slave parallel setting..... - 41 -
 - 3.15.3 Master-slave parallel function operations..... - 42 -
- 4. COMMUNICATION INTRODUCTION..... - 44 -**
 - 4.1 Communication Setup..... - 44 -**
 - 4.2 Voltage, current acquisition speed..... - 45 -**
 - 4.3 Communication Interfaces..... - 45 -**
 - 4.3.1 USB (Serial)..... - 45 -
 - 4.3.2 LAN..... - 46 -
 - 4.3.3 CAN..... - 46 -
 - 4.3.4 RS485..... - 46 -
 - 4.4 Communication Protocol..... - 47 -**
 - 4.4.1 SCPI protocol..... - 47 -
 - 4.4.2 Modbus protocol..... - 47 -
 - 4.4.3 CANopen protocol..... - 47 -
- 5. TROUBLESHOOTING..... - 48 -**
- 6. APPENDIX..... - 49 -**

1. General Description

1.1 Overview

FTP9000 series high-power programmable DC power supply has the characteristics of high power density, high power factor, high efficiency, and wide range of output. Its wide range voltage / current output and automatic constant power function can greatly increase the application coverage. FTP9000 series DC power supply output power 5kW up to 180kW in a single unit, and expandable up to 1800kW when paralleling 10 identical models. Its voltage output up to 2250V, current up to 6120A.

For bench top applications, this series provides an intuitive user interface with full keypad and rotary knob. System integrators benefit from the standard USB (virtual SERIAL) and LAN interfaces supporting both SCPI commands and ModBus RTU protocol. Free application software, programming manual and a complete set of development DLLs are available to reduce programming time and increase productivity. The application software allows users to control the power supply, execute test sequences, or log measurements.

1.2 Main features

- Output voltages: 80 V up to 2250 V;
- Output current: 20 A up to 6120 A;
- Output power: 5 kW up to 180 kW, expandable up to 1800 kW;
- CV, CC, CP operation modes;
- Easy Master-Slave parallel;
- Precision V & I measurement;
- High speed programming;
- Programmable sequence;
- Voltage & current slew rate control;
- CV / CC priority;
- Voltage ramp function;
- Wide operating region for output;
- Internal resistance simulating;
- Remote sense compensation;
- Optional analog programming & monitoring interface;
- \pm OVP, \pm OCP, \pm OPP, OTP, \pm LVP;
- Voltage / current / power limit;
- Standard LAN, USB (serial), optional RS485, GPIB or CAN ports;
- SCPI and ModBus RTU protocol;

1.3 Dimension diagram

1.3.1 Model of 5kW, 10kW, 15kW

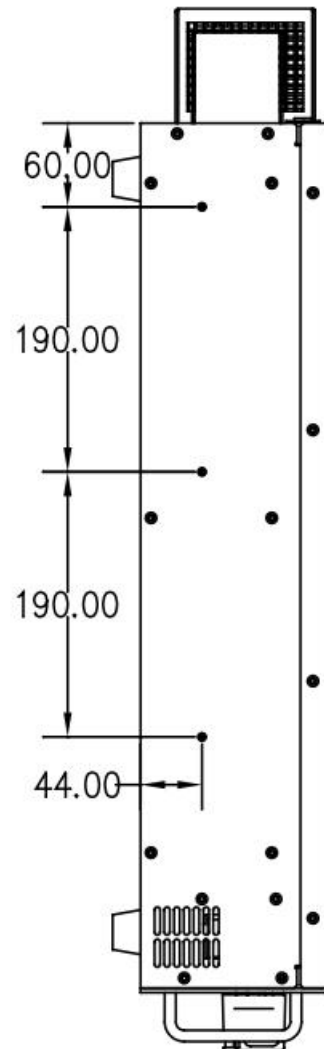
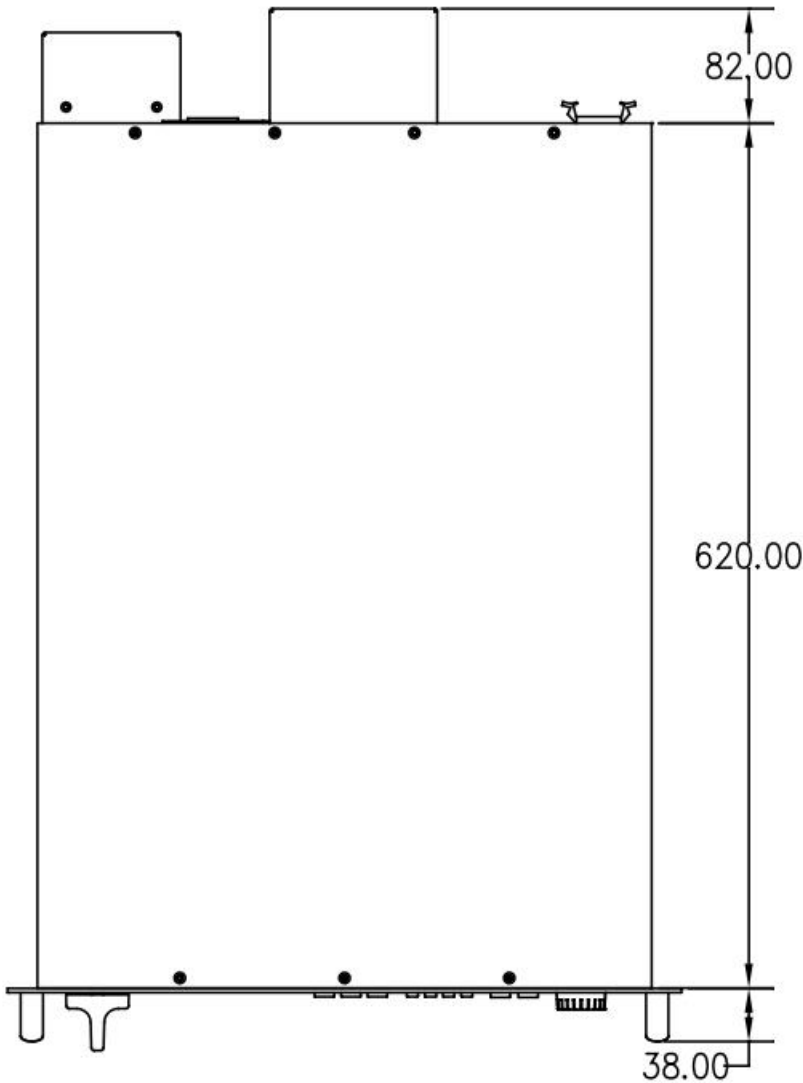
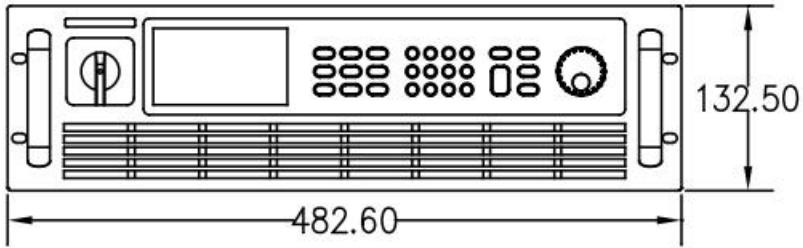

1.3.2 Model of 20kW, 25kW, 30kW

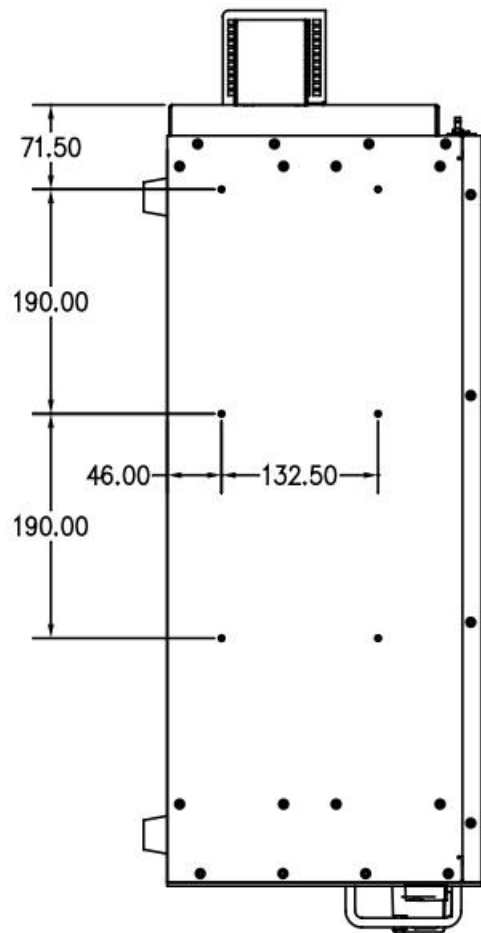
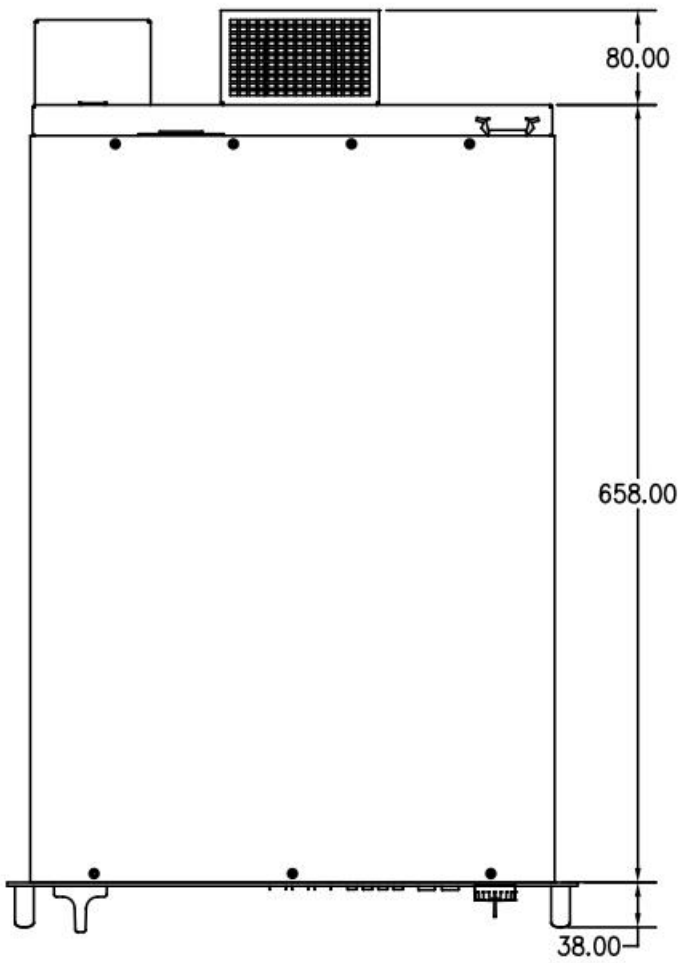
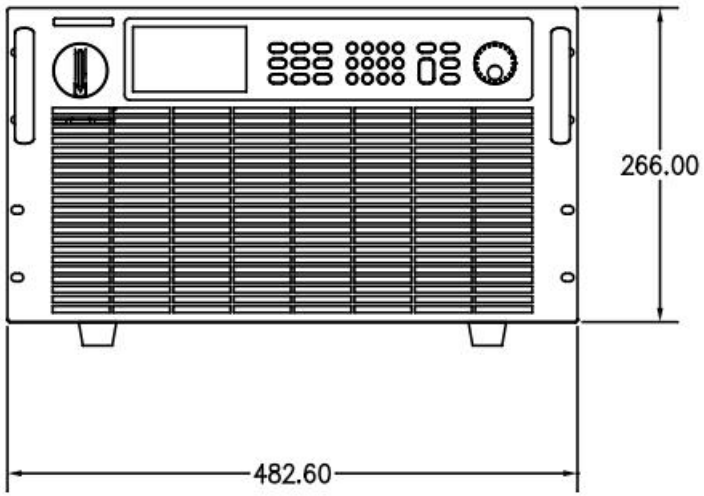

1.4 Model Naming

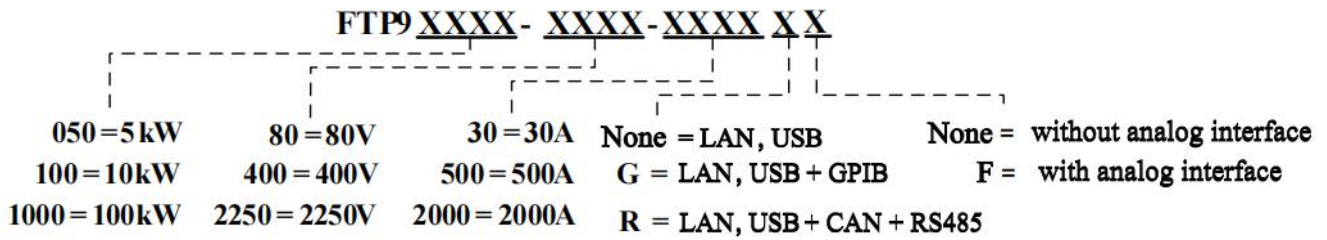

1.5 Specification sheet

| General specification | |
|------------------------|--|
| Voltage rise slew rate | |
| Maximum slew rate | 6000V/s |
| Voltage fall time | |
| No load | <2s |
| Full load | ≤30ms |
| Transient response | Typical 2ms |
| Parallel | Parallel up to 10 identical units through master-slave mode for max 1800W output |
| Protection | OVP, OCP, OPP, OTP, LVP etc.. |
| Interface | Standard LAN、USB(serial) (optional GPIB、CAN、RS485) |
| Protocol | SCPI、MODBUS、CAN-Open protocols |
| Input characteristics | |
| Input voltage | 340VAC~460VAC, 47Hz~63Hz |
| Power factor | 0.99 (Typical) |
| Efficiency | >93% (Typical) |
| Operation environment | |
| Working temp | 0°C~40°C |
| Storage temp | -20°C~70°C |
| Altitude | <2000m |
| Cooling | Air cooling |

Specification table 1

| Model | FTP9050-80-170 | FTP9050-200-70 | FTP9050-400-40 | FTP9050-500-30 | FTP9050-800-25 |
|---------|----------------|-----------------|----------------|----------------|----------------|
| Voltage | 0~80V | 0~200V | 0~400V | 0~500V | 0~800V |
| Current | 0~170A | 0~70A | 0~40A | 0~30A | 0~25A |
| Power | 0~5kW | | | | |
| Model | FTP9100-80-340 | FTP9100-200-140 | FTP9100-400-80 | FTP9100-500-60 | FTP9100-800-50 |
| Voltage | 0~80V | 0~200V | 0~400V | 0~500V | 0~800V |
| Current | 0~340A | 0~140A | 0~80A | 0~60A | 0~50A |
| Power | 0~10kW | | | | |

FTP9000 Series Programmable DC Power Supply Operation Manual

| | | | | | |
|------------------------------|--------------------------------|-------------------|------------------|------------------|------------------|
| Model | FTP9150-80-510 | FTP9150-200-210 | FTP9150-400-120 | FTP9150-500-90 | FTP9150-800-75 |
| Voltage | 0~80V | 0~200V | 0~400V | 0~500V | 0~800V |
| Current | 0~510A | 0~210A | 0~120A | 0~90A | 0~75A |
| Power | 0~15kW | | | | |
| Model | FTP9300-80-1020 | FTP9300-200-420 | FTP9300-400-240 | FTP9300-500-180 | FTP9300-800-150 |
| Voltage | 0~80V | 0~200V | 0~400V | 0~500V | 0~800V |
| Current | 0~1020A | 0~420A | 0~240A | 0~180A | 0~150A |
| Power | 0~30kW | | | | |
| Model | FTP9600-80-2040 | FTP9600-200-840 | FTP9600-400-480 | FTP9600-500-360 | FTP9600-800-300 |
| Voltage | 0~80V | 0~200V | 0~400V | 0~500V | 0~800V |
| Current | 0~2040 A | 0~840A | 0~480A | 0~360A | 0~300A |
| Power | 0~60kW | | | | |
| Model | FTP9900-80-3060 | FTP9900-200-1260 | FTP9900-400-720 | FTP9900-500-540 | FTP9900-800-450 |
| Voltage | 0~80V | 0~200V | 0~400V | 0~500V | 0~800V |
| Current | 0~3060 A | 0~1260A | 0~720A | 0~540A | 0~450A |
| Power | 0~90kW | | | | |
| Model | ~ | FTP91200-200-1680 | FTP91200-400-960 | FTP91200-500-720 | FTP91200-800-600 |
| Voltage | ~ | 0~200V | 0~400V | 0~500V | 0~800V |
| Current | ~ | 0~1680A | 0~960A | 0~720A | 0~600A |
| Power | 0~120kW | | | | |
| Voltage programming① | | | | | |
| Resolution | 16bits | | | | |
| Accuracy | 0.05%+0.1%F.S. | | | | |
| Current programming① | | | | | |
| Resolution | 16bits | | | | |
| Accuracy | 0.1%+0.2% F.S. | | | | |
| Power programming① | | | | | |
| Accuracy | 1%F.S. | | | | |
| External analog programming① | | | | | |
| Control voltage | 0~5V corresponds to 0~100%F.S. | | | | |
| Voltage accuracy | 0.5%F.S. | | | | |
| Current accuracy | 0.5%F.S. | | | | |
| Line regulation② | | | | | |
| Voltage | 0.02%F.S. | | | | |
| Current | 0.05%F.S. | | | | |
| Power | 0.05%F.S. | | | | |
| Load regulation③ | | | | | |
| Voltage | 0.05%F.S. | | | | |
| Current | 0.15%F.S. | | | | |
| Power | 0.75%F.S. | | | | |
| Voltage measurement① | | | | | |
| Resolution | 16bits | | | | |
| Accuracy | 0.05%+0.1%F.S. | | | | |
| Current measurement① | | | | | |
| Resolution | 16Bits | | | | |

| | | | | | | |
|--------------------|---|-------|-------|-------|-------|-------|
| Accuracy | 0.1%+0.2% F.S. | | | | | |
| Power measurement① | | | | | | |
| Accuracy | 1%F.S. | | | | | |
| Ripple noise④ | | | | | | |
| Ripple Vpp | 5kW | 160mV | 300mV | 550mV | 450mV | 800mV |
| | 10kW | 320mV | 300mV | 550mV | 450mV | 800mV |
| | 15kW | 320mV | 300mV | 550mV | 450mV | 800mV |
| Ripple Vrms | 5kW | 16mV | 40mV | 65mV | 70mV | 200mV |
| | 10kW | 25mV | 40mV | 65mV | 70mV | 200mV |
| | 15kW | 25mV | 40mV | 65mV | 70mV | 200mV |
| Size (W x H x D) | 5kW~15kW: 482.6mm x 132.5mm x 702.0mm, includes output protection cover | | | | | |
| | 20kW~30kW: 482.6mm x 266mm x 738.0mm, includes protection cover, excludes casters | | | | | |
| Weight | 5kW≈17kg, 10kW≈24kg, 15kW≈30kg, 30kW≈65kg | | | | | |

Specification table 2

| | | | | |
|---------|-------------------|-------------------|-------------------|-------------------|
| Model | FTP9100-1000-30 | - | FTP9100-1500-25 | - |
| Voltage | 0~1000V | - | 0~1500V | - |
| Current | 0~30A | - | 0~25A | - |
| Power | 0~10kW | | | |
| Model | FTP9150-1000-40 | FTP9150-1200-40 | FTP9150-1500-30 | FTP9150-2250-25 |
| Voltage | 0~1000V | 0~1200V | 0~1500V | 0~2250V |
| Current | 0~40A | 0~40A | 0~30A | 0~25A |
| Power | 0~15kW | | | |
| Model | FTP9200-1000-60 | - | FTP9200-1500-50 | |
| Voltage | 0~1000V | - | 0~1500V | |
| Current | 0~60A | - | 0~50A | |
| Power | 0~20kW | | | |
| Model | FTP9300-1000-80 | FTP9300-1200-80 | FTP9300-1500-60 | FTP9300-2250-50 |
| Voltage | 0~1000V | 0~1200V | 0~1500V | 0~2250V |
| Current | 0~80A | 0~80A | 0~60A | 0~50A |
| Power | 0~30kW | | | |
| Model | FTP9400-1000-120 | - | FTP9400-1500-100 | - |
| Voltage | 0~1000V | - | 0~1500V | - |
| Current | 0~120A | - | 0~100A | - |
| Power | 0~40kW | | | |
| Model | FTP9600-1000-180 | FTP9600-1200-160 | FTP9600-1500-120 | FTP9600-2250-100 |
| Voltage | 0~1000V | 0~1200V | 0~1500V | 0~2250V |
| Current | 0~180A | 0~160A | 0~120A | 0~100A |
| Power | 0~60kW | | | |
| Model | FTP9800-1000-240 | FTP9900-1200-240 | FTP9900-1500-180 | FTP9900-2250-150 |
| Voltage | 0~1000V | 0~1200V | 0~1500V | 0~2250V |
| Current | 0~240A | 0~240A | 0~180A | 0~150A |
| Power | 0~80kW | | 0~90kW | |
| Model | FTP91000-1000-300 | FTP91200-1200-320 | FTP91200-1500-240 | FTP91200-2250-200 |
| Voltage | 0~1000V | 0~1200V | 0~1500V | 0~2250V |

| Current | 0~300A | 0~320A | 0~240A | 0~200A | |
|------------------------------|---|--------|---------|--------|--------|
| Power | 0~100kW | | 0~120kW | | |
| Voltage programming① | | | | | |
| Resolution | 16bits | | | | |
| Accuracy | 0.05%+0.1%F.S. | | | | |
| Power programming① | | | | | |
| Resolution | 16bits | | | | |
| Accuracy | 0.1%+0.2% F.S. | | | | |
| Power programming① | | | | | |
| Accuracy | 1%F.S. | | | | |
| External analog programming① | | | | | |
| Control voltage | 0~10V corresponds to 0~100%F.S. | | | | |
| Voltage accuracy | 0.5%F.S. | | | | |
| Current accuracy | 0.5%F.S. | | | | |
| Line regulation② | | | | | |
| Voltage | 0.02%F.S. | | | | |
| Current | 0.05%F.S. | | | | |
| Power | 0.05%F.S. | | | | |
| Load regulation③ | | | | | |
| Voltage | 0.05%F.S. | | | | |
| Current | 0.15%F.S. | | | | |
| Power | 0.75%F.S. | | | | |
| Voltage measurement① | | | | | |
| Resolution | 16bits | | | | |
| Accuracy | 0.05%+0.05%F.S. | | | | |
| Current measurement① | | | | | |
| Resolution | 16Bits | | | | |
| Accuracy | 0.1%+0.2% F.S. | | | | |
| Power measurement① | | | | | |
| Accuracy | 1%F.S. | | | | |
| Ripple noise④ | | | | | |
| Ripple Vpp | 10kW | 1600mV | | - | - |
| | 15kW | 2000mV | 2000mV | 2400mV | 3600mV |
| Ripple Vrms | 10kW | 350mV | | - | - |
| | 15kW | 350mV | 350mV | 400mV | 400mV |
| Size (W x H x D) | 5kW~15kW: 482.6mm x 132.5mm x 702.0mm, includes output protection cover | | | | |
| | 20kW~30kW: 482.6mm x 266mm x 738.0mm, includes protection cover, excludes casters | | | | |
| Weight | 5kW≈17kg, 10kW≈24kg, 15kW≈30kg, 30kW≈65kg | | | | |

2. Quick Guide

2.1 Checking Goods

Upon reception of the power supply, please examine the equipment according to procedures stipulated as below.

(1) Check if there is damage during transportation.

Contact authorized dealer or Faithtech after-sale service immediately if the packing or protective cushion is severely damaged.

 **Notice** Do not return the instrument without obtaining prior approval from Faithtech.

(2) Check for the accessories.

Make sure you have received the following accessories along with the power supply:

Table 2-1 Accessories Explanation

| Accessory | QTY | Explanation |
|-------------------------|-------|---|
| Protective cover | 1 Set | Input and output protection |
| 2PIN 5.08mm terminal | 1 PCS | Voltage remote sense connection terminal |
| 2PIN 2.54mm terminal | 1 PCS | Master-Slave parallel connection terminal |
| USB communication cable | 1 PCS | For connecting PC and USB port |
| LAN communication cable | 1 PCS | For connection PC and LAN port |
| User Manual | 1 PCS | Installing and operation info |
| CD Disk | 1 PCS | Software and tech info |
| Warranty & QC PASS Card | 1 PCS | Warranty and after-sale info |

Contact authorized dealer or Faithtech after-sale service immediately if there is damage or miss.

(3) Check for the power supply unit.

Contact authorized dealer or Faithtech after-sale service immediately if the power supply case is damaged or working abnormally.

(4) Cleaning.

If you need to clean the casing of the machine, please wipe it gently with a dry cloth or a slightly damp cloth. Do not wipe the inside of the machine.

 **WARNING** Turn off the power supply before cleaning.

2.2 Front Panel

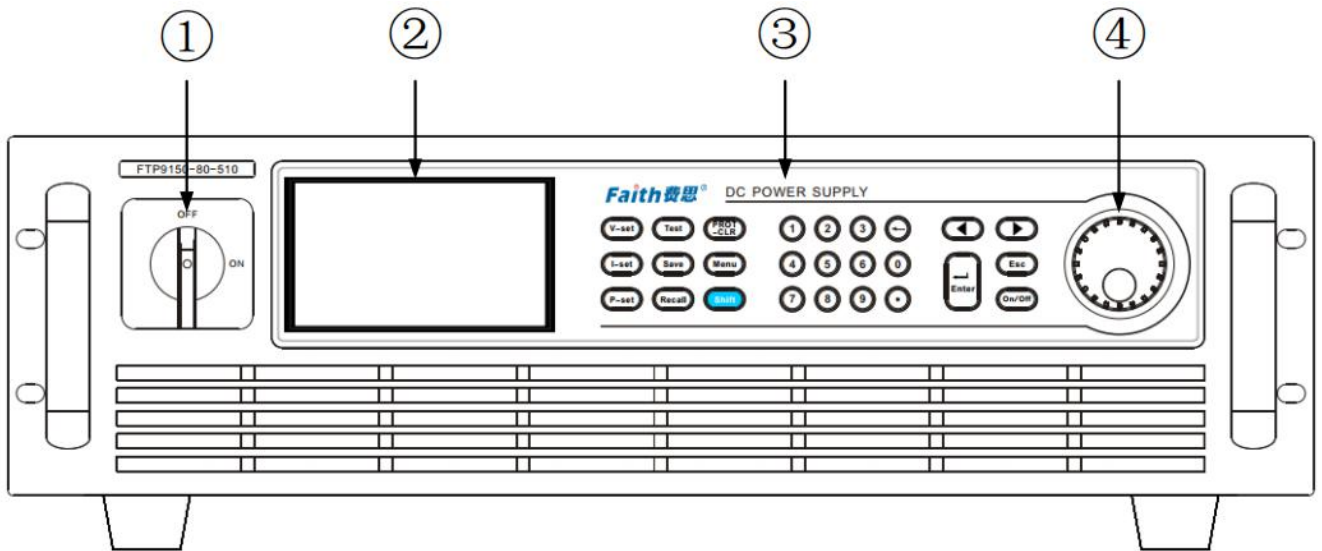

- ① Power switch
- ② TFT color screen
- ③ Keyboard
- ④ Rotary knob

2.3 Keyboard

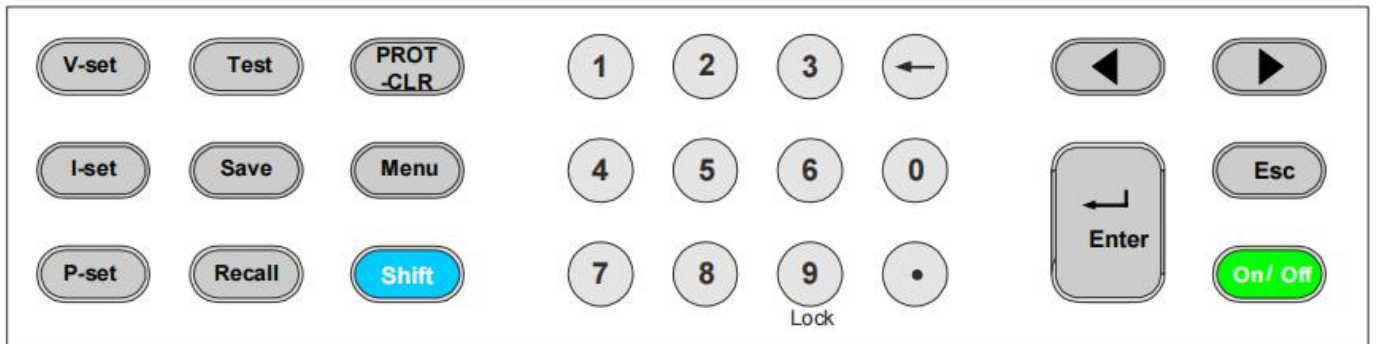



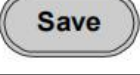
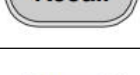
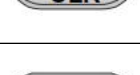





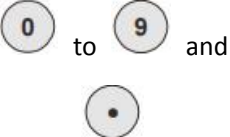







Figure 2-2 FTP9000 keyboard

Table 2-2 Key Function Descriptions

| Button | Key Name | Description |
|---|---------------------|--|
|  | Voltage Setting Key | Switch to output setting mode from other functions, and Voltage is now settable; |
|  | Current Setting Key | Switch to output setting mode from other functions, and Current is now settable; |

| | | |
|---|-----------------------------|---|
|  | Power Setting Key | Switch to output setting mode from other functions, and Power is now settable; |
|  | Advanced Test Key | For performing Sequence Test, Voltage RAMP, RESI internal resistance simulation, etc. |
|  | SAVE Key | Save the settings of the static output to internal memory. |
|  | Recall Key | Recall the saved settings from internal memory. |
|  | Protection Clear Key | Clear the occurred protection and warning messages. |
|  | Main Menu Key | Enter the main menu. |
|  | Compound Function Key | Work with other key together |
|  | Lock or unlock the keyboard | In locked state, only  and  are valid. |
|  | Numeric and Decimal Point | Enter digital data. |
|  | Clear Key | Each press clears one digit of your numeric input. |
|  | Cursor Movement Keys | Control the cursor to move between digits when setting parameters. In menu navigation, used for selecting the specified item. |
|  | ENTER Key | Enter set item, or confirm input and exit set item. |
|  | EXIT Key | Exit set item or current menu. |
|  | Output On/Off Key | Turn on/off power supply output. |

2.4 Screen Display

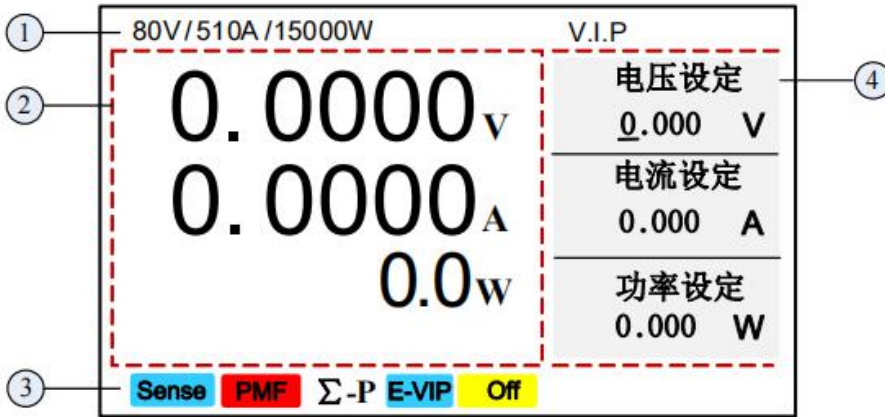

Figure 2-3 MAIN PAGE Display

- ① Specification info of the power supply;
- ② Readback voltage, current, etc. parameters display area;
- ③ Status prompt area;
- ④ Parameters setting area;

About specification info:

Displays the rated voltage, rated current, rated power of the power supply;

About V, I parameters display area:

Displays readback voltage, current, power, measurement result etc.. However, the actual displayed information varies, for example, in V.I.P static output mode, the area displays output voltage, current and power; in sequence test mode, the area displays output voltage, current, sequence current steps and sequence cycle times.

About Status prompt area:

Sense V-Sense: Blank (local sensing), Sense (remote sensing);

PMF Protection occurred: Blank (no protection occurred), PMF, OVP, OCP, OPP, OTP1, OTP2, LVP, OP, OC, OV, RVP, CMF etc.. protections occurred;

Σ-P Parallel operation;

E-VIP External programming: Blank (Analog programming is off), E-VIP;

Off Output mode indicator: CV, CC, CP, Off;

2.5 Rear Panel

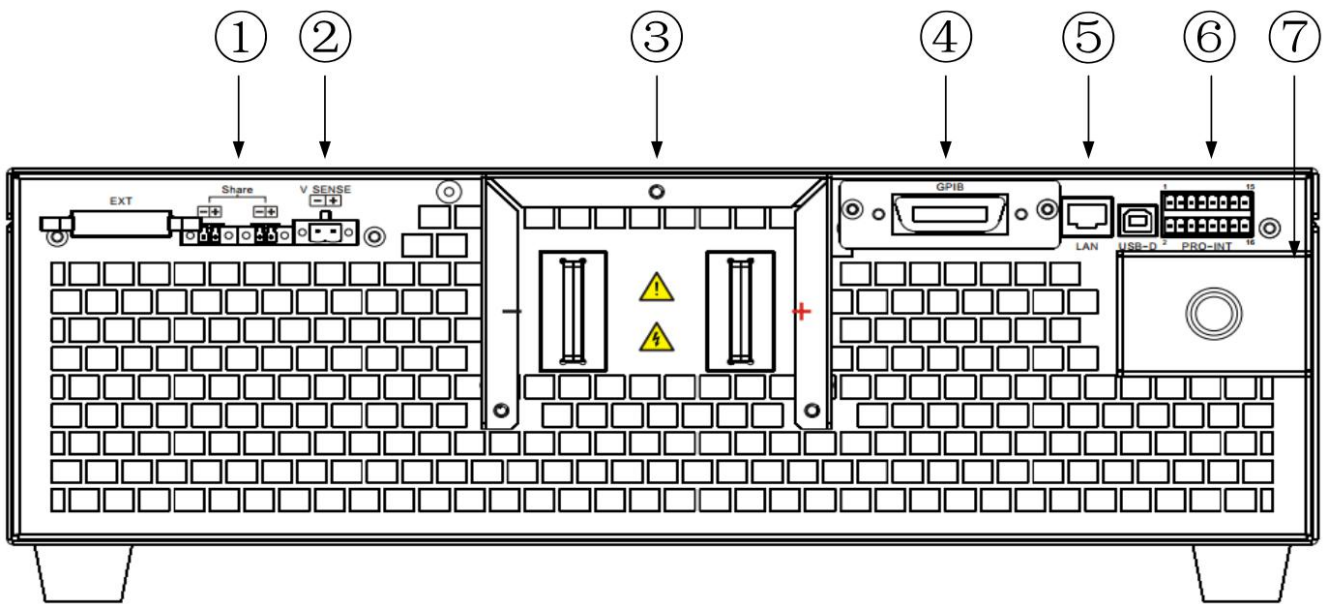

Figure 2-4 FTP9000 Rear Panel

| Item | Name | Description |
|------|-----------------------|--|
| 1 | Share | Master-Slave parallel ports |
| 2 | V SENSE | This connector compensates for any voltage drop generated by the cable resistance. Be sure to connect the remote sense connector "+" to the positive output terminal and the "-" connector to the negative output terminal. Do not reverse the connections. |
| 3 | "+", "-" Output | The output terminals of the DC Power Supply. |
| 4 | GPIB (or CAN + RS485) | The remote controller uses the GPIB connector to connect to a PC for remote operation. |
| 5 | LAN, USB | The remote controller uses the USB/LAN connector to connect to a PC for remote operation. |
| 6 | PRO-INT | This interface has the functions of analog programming input, voltage/current monitoring output, external control, power supply status and work mode indication. Refer to "2.7.5 PRO-INT Analog Interface" for details. |
| 7 | AC INPUT | L1、 L2、 L3、 PE three phase AC INPUT |

2.6 Installing

2.6.1 Preparation For Use

- (1) Insure the Power Supply is connected to the AC line input that meets the specification.
- (2) The instrument must be installed in an area with good air circulation to avoid the internal temperature getting too high.
- (3) For indoor use only, ambient temperature 0°C to 40°C.

2.6.2 Requirements of Input Power

Please pay attention to the following items for FTP9000 series power supply input connection:

- ① Three-phase input: 340VAC~460VAC, 47~63Hz;
- ② Ensure reliable grounding;
- ③ 5kW model power supply is connected to L1, L2 and grounding terminal, other types of power supply need to be connected to L1, L2, L3 and grounding terminal;
- ④ Please refer to "Table 6-1 Recommended Wire Diameters for Cables" for the selection of input wire diameters to avoid potential safety hazards due to thinner wire diameters.



1. To protect the operator, the wire connected to the GND terminal must be connected to the earth. Under no circumstances shall this DC Power Supply be operated without an adequate ground connection.
2. Installation of the power cord must be done by a professional and compliant with local electrical codes.

2.6.3 Power ON Self Check

When powered on, the power supply will conduct self check, the check process and results will be displayed on the screen, such as below:

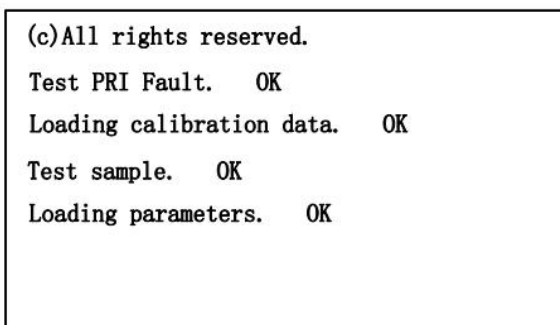

Figure 2-5 FTP9000 Power ON Self Check

The power supply will enter MAIN PAGE if all checking results are OK, otherwise it will wait for 5 seconds before entering the MAIN PAGE.



CAUTION For fault meaning please refer to "Table 5-2 Power On Fault Check".

2.7 Connection

2.7.1 Input Connection

The user connects the three-phase wire and the ground wire to the power supply input terminal as shown in Figure 2-6. For the size of the wire diameter, please refer to "Table 6-1 Recommended Wire Diameter for Cables".

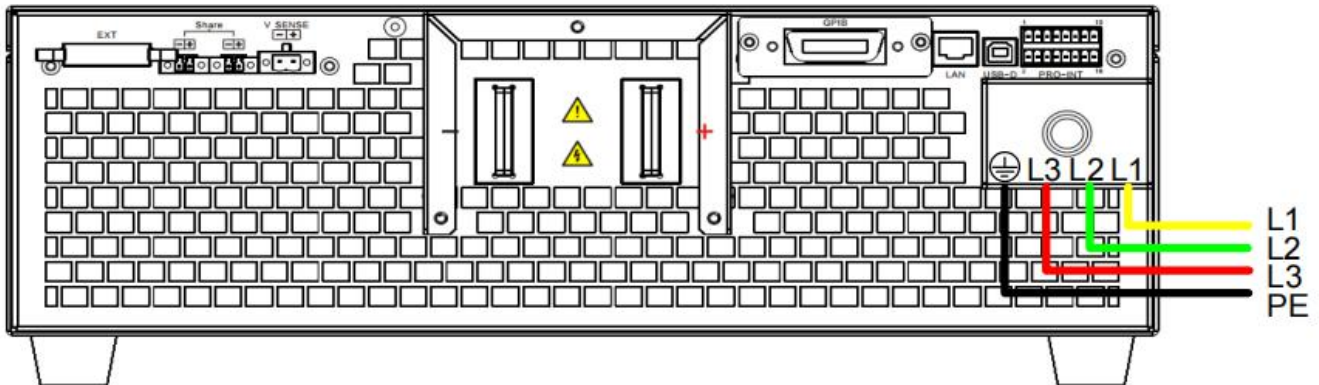

Figure 2-6 Power supply Input Connection



1. To protect the operator, the wire connected to the GND terminal must be connected to the earth. Under no circumstances shall this DC Power Supply be operated without an adequate ground connection.
2. Installation of the power cord must be done by a professional and compliant with local electrical codes.

2.7.2 Input Connection for Multiple Power Supplies

If multiple 5kW or 10kW models are connected to the grid, it is recommended to distribute the access points in a balanced manner as shown in the figure below. When the 15kW model is connected to the three-phase power grid, there is no need to consider the imbalance of the power grid.

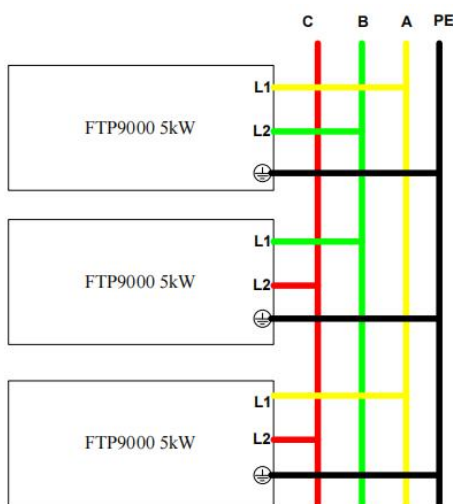

Figure 2-7 Input Connection of multiple 5kW Models

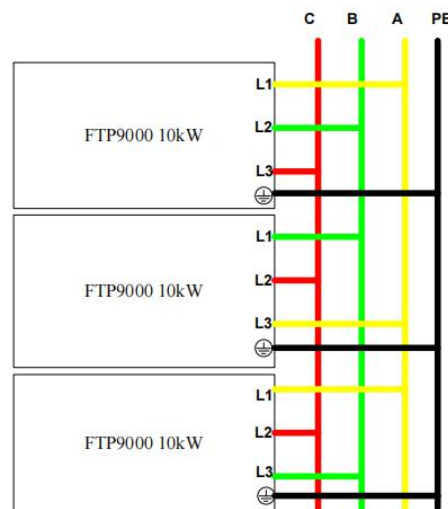

Figure 2-8 Input Connection of multiple 10kW Models

2.7.3 Output Connection

The device under test is connected to the "+" and "-" output terminals on the rear panel of the power supply. When connecting, pay attention to the wire diameter, length and polarity of the output cable. To prevent the wire diameter from being too small to affect the test accuracy and generate large heat to cause safety accidents, please refer to "Table 6-1 Recommended Wire Diameters for Cables" for wire diameter selection.

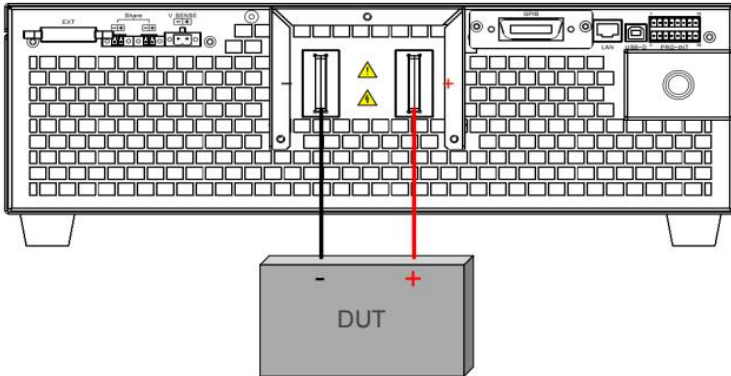
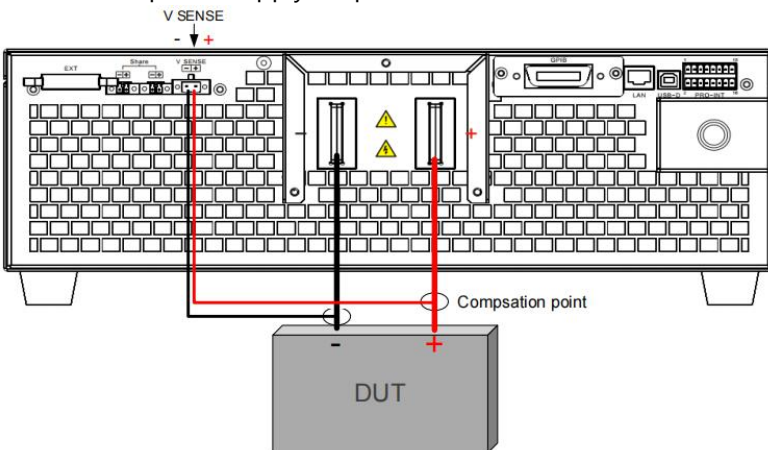

Figure 2-9 Power Supply Output Connection

CAUTION The diameter of the wire connected to the load must be adequate so as to carry the maximum applied current.

2.7.4 Remote Sensing Connection

FTP9000 series power supplies are able to compensate for the voltage drop caused by output connecting cables. Use two wires to connect the positive/negative connectors of the load to the corresponding positive/negative remote sensing connector on the rear panel, symbol "Sense" will be prompted in the status prompt area of the screen if the power supply output is turned on.



1. It is OK to choose red and black wires with a cross-sectional area of 0.5mm^2 to 1mm^2 for voltage compensation wire, try double strand the wire as much as possible.

CAUTION 2. The 80V type of FTP9000 series power supply has a compensation voltage drop of less than 1.5V, and other voltage models have a compensation voltage drop of less than 5V. For special requirements, please consult the dealer or the Faithtech Technology Department.

2.7.5 PRO-INT Analog Interface

FTP9000 series power supply provides optional PRO-INT analog Interface at its rear panel. This interface has the functions of analog programming input, voltage/current monitoring output, external control, power supply status and work mode indication.

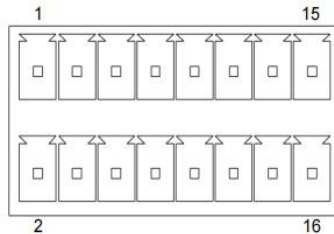

Figure 2-11 PRO-INT Analog Interface

Table 2-4 Analog Interface Function Description

| PIN No. | PIN Name | I/O | Description |
|---------|----------|--------|--|
| 1 | Ready | Output | Power supply status indicating, 5V TTL, H: fault, L: normal |
| 2 | MODE | Output | Power supply output mode indicating, 5V TTL, H: CC or CP, L: CV |
| 3 | INHIBIT | Input | External control port, 5V TTL, low level or falling edge effective, can be set to Trigger, Toggle, Hold three behaviors. Refer to "3.7.2 External Control" |
| 4 | DGND | - | Digital ground |
| 5 | DGND | - | Digital ground |
| 6 | AGND | - | Analog ground |
| 7 | VMON | Output | Output Voltage monitoring port, monitoring output range 0~5VDC corresponds to 0~100%F.S. rated voltage of the power supply output |
| 8 | IMON | Output | Output current monitoring port, monitoring output range 0~5VDC corresponds to 0~100%F.S. rated current of the power supply output |
| 9 | I-SET | Input | Analog programming current input port, input range 0~5VDC or optional 0~20mA corresponds to 0~100%F.S. rated current of the power supply output |
| 10 | AGND | - | Analog ground |
| 11 | V-SET | Input | Analog programming voltage input port, input range 0~5VDC or optional 0~20mA corresponds to 0~100%F.S. rated voltage of the power supply output |
| 12 | P-SET | Input | Analog programming power input port, input range 0~5VDC or optional 0~20mA corresponds to 0~100%F.S. rated power of the power supply output |
| 13, 14 | RS485-A | - | Communication port for master-slave parallel operation |
| 15, 16 | RS485-B | - | Communication port for master-slave parallel operation |

3. Function Introduction

This chapter describes the main functions and characteristics of the power supply. Reading this chapter, you will have a deeper understanding of FTP9000 series power supplies.

3.1 Local & remote operation mode

The power supply provides two operation modes: local operation and remote operation. In the local operation mode, the user mainly operates through the keyboard and knob on the front panel, and checks the power status through the LCD display; in the remote operation mode, the user mainly performs settings and operations via the communication interface and programming commands.

Local operation mode

When the power supply is turned on, it operates in local operation mode by default. In this mode, the user operates the power supply through the front panel keyboard. The LCD screen provides users with display functions such as parameter viewing, measurement display and status indication.

Some parameters can only be set in local mode, including:

- * System language
- * Serial port baud rate and parity method
- * Key sound
- * IP address and subnet mask
- * Communication protocol selection

Remote operation mode

To enter the remote operation mode, please use the proper communication cable to connect the PC with the power supply. The communication configuration parameters must be consistent with the control device settings. Upon receiving the programming command, the power supply automatically switches to the remote operation mode from local control mode.

In remote control mode, the power supply can only be controlled by programming commands. Press "Enter" to return to local operation mode.

3.2 Menu Layout

3.2.1 Set Menu



Press  to enter main menu, then select "Set" and press  to pop up sub menu as below:

Table 3-1 Set Menu Layout

| | | |
|----------|----------------------|--|
| App Set | Samp Rate | Data transmission speed, choices: 1000Hz/500Hz/200Hz/100Hz/10Hz, default value 10Hz |
| | Prio SLT | Choice for CV or CC priority. Default value: Volt (CV Priority) |
| | V _{slew-UP} | Voltage rise slew rate, range: 0.0006V/s~6000V/s, default value: 50% of max value |
| | V _{slew-DN} | Voltage fall slew rate, range: 0.0006V/s~6000V/s, default value: 50% of max value |
| | I _{slew-UP} | Current rise slew rate, range: 0.0006A/s~2000A/s, default value: max value |
| | I _{slew-DN} | Current fall slew rate, range: 0.0006A/s~2000A/s, default value: max value |
| Protect | OVP | Set overvoltage protection point, set 0 to turn off this protection. |
| | OCP | Set overcurrent protection point, set 0 to turn off this protection. |
| | OPP | Set overpower protection point, set 0 to turn off this protection. |
| | LVP | Set low voltage protection point, set 0 to turn off this protection. |
| | Over time | Set communication error time out, range: 0.0~60.0s, set 0 to turn off this protection; |
| | Detect RV | Turn on/off reverse voltage protection, default value: Closed |
| Limit | V_MAX | Upper limit of static output voltage set, default max output voltage |
| | V_MIN | Lower limit of static output voltage set, default 0 means no limit |
| | I_MAX | Upper limit of static output current set, default max output current |
| | I_MIN | Lower limit of static output current set, default 0 means no limit |
| | P_MAX | Upper limit of static output power set, default max output power |
| | P_MIN | Lower limit of static output power set, default 0 means no limit |
| Ext Prog | APG_V | Turn on/off external voltage programming, default: OFF. |
| | APG_I | Turn on/off external current programming, default: OFF. |
| | APG_P | Turn on/off external power programming, default: OFF. |
| | EXT-S | Set external input signal behavior, choices: Trigger/Toggle/Hold; default value: Trigger (Refer to 3.7.2 External Control) |
| Parallel | M_or_S | Set the power supply as master or slave, default value: master |
| | S.NUM | Set number of slaves in master, range: 1~9 |
| | MS_CTRL | Turn on/off parallel function, default value: OFF |

3.2.2 System Menu



Press  to enter main menu, then select "System" and press  to pop up sub menu as below:

Table 3-2 System Menu Layout

| | | |
|---------------|------------|---|
| Communication | IP | Default 192.168.1.123 |
| | S-Mask | Default 255.255.255.0 |
| | Baud | Serial port baud rate, 4800/9600/19200/38400/115200, default: 9600. |
| | Parity | no parity/odd parity/even parity, default: no parity. |
| | DEVI-ADDR | Device address in MODBUS protocol, range 0~254, default: 160 |
| | GPIB | set GPIB address, range: 0~30, default: 5. |
| | Protocol | SCPI/MODBUS, default: MODBUS |
| Factory | | Reset to factory setting. Reboot the machine to take effect. |
| Others | Language | Simplified Chinese/Traditional Chinese/English. Default: English. |
| | Sound | Keyboard sound ON/OFF. Default: ON |
| | Power Save | Power down save function ON/OFF. Default: ON |
| | Shortcut | Fast recall function ON/OFF. Default: OFF |

3.2.3 Edit Menu





Press  to enter main menu, then select "Edit" and press  to pop up sub menu as below:

Table 3-3 Edit Menu Layout



| | | |
|------|----------|---|
| Edit | Sequence | Select sequence file number, range 1~10 |
| | Back | Exit |

3.2.4 About Menu

Press  to enter main menu, then select "About" and press  to pop up sub menu such as HMI, MAIN, COMM program version information etc..

3.3 Static Output Function

FTP9000 series power supply provides auto ranging wide range output within its rated power. The output range is 0 ~ 102% rated output of voltage, current and power.

Press ,  or , the power supply enters static output function, the screen displays information as below:

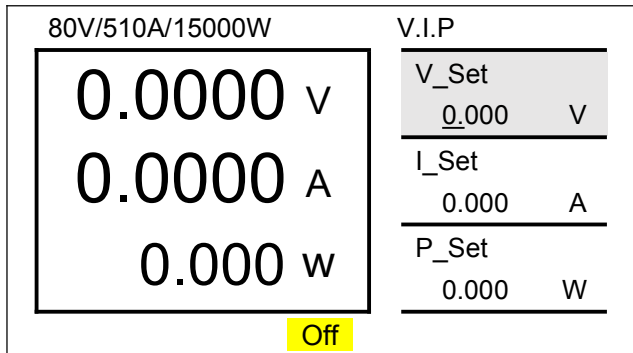











Figure 3-1 Static Output View

Setting output voltage:

1. Press , power supply enters static output mode, the cursor for voltage set blinks, also you can rotate

the knob to highlight the voltage setting and press  to edit voltage,

2. Use  至  与  to set the value and press  to confirm the voltage setting or rotate the  knob to set the value.

When using the "Rotary" knob  for setting, use  与  to move the cursor to the individual digit, and then rotate the rotary knob to increase or decrease the value.

When power supply is reset to factory setting, the default voltage set is 0V.

Setting output current or output power:

Press  or  and follow the similar steps.

When power supply is reset to factory setting, the default set current is maximum output current, default set power is maximum output power.

3.3.1 Power supply output modes

FTP9000 series power supply has three output modes: CV (constant voltage mode), CC (constant current mode), CP (constant power mode).

The power supply generally outputs voltage according to the set value, in such situation, "CV" is displayed in status prompt area. When the output current exceeds the set current value, the power supply will automatically switch to CC mode, the output current can be changed by setting the output current value, in this situation "CC" is displayed in status prompt area. When the output power exceeds the set power value, the power supply automatically switch to CP mode, in which the output power can be changed by setting the output power value, in this situation, "CP" is displayed in status prompt area.

3.3.2 Limit Voltage/Current/Power Set

FTP9000 series power supply allows for setting upper and lower limits on voltage, current and power. When the upper and lower limit is set to non-zero, the setting range of static output voltage, current, and power parameters is limited between the upper and lower limit. If the input exceeds the limit, it will be invalid. This function is useful for preventing misoperation from damaging the user's equipment.

The limit function will be canceled if upper and lower limit both are set to 0.

Operation:

1. Press  ;

2. Select "Set" >> "Limit", press  to enter the limit setting page shown as below:

| Set | System | Edit | About |
|-------|--------|------|-------|
| V_MAX | 0.000 | V | |
| V_MIN | 0.000 | V | |
| I_MAX | 0.000 | A | |
| I_MIN | 0.000 | A | |
| P_MAX | 0.000 | W | |
| P_MIN | 0.000 | W | |

Figure 3-2 Voltage, Current, Power Limit Set

3. Select the desired item and set the corresponding parameter.

3.4 Voltage Slew Rate And Current Slew Rate

FTP9000 series power supply supports adjustable voltage and current slew rate, which effectively avoids the inrush damage or surge damage to the units under test.

Operation:

1. Press  ;

2. Select "Set" >> "App Set", press  to enter the application setting page shown as below:

| | | | |
|----------------------|--------|------|-------|
| Set | System | Edit | About |
| Samp Rate | 10Hz | | |
| Prio SLT | Volt | | |
| V _{slew-UP} | 5000.0 | V/s | |
| V _{slew-DN} | 5000.0 | V/s | |
| I _{slew-UP} | 2000.0 | V/s | |
| I _{slew-DN} | 2000.0 | V/s | |

Figure 3-3 Voltage, Current Slew Rate Set

3. Select parameters to set corresponding value.

3.5 CV/CC Priority Start function

FTP9000 series power supply provides CC priority and CV priority start function, which forces the power supply to operate in CC or CV mode at the moment the output is turned on, effectively avoids the current or voltage overshoot resulted from capacitive or inductive load.

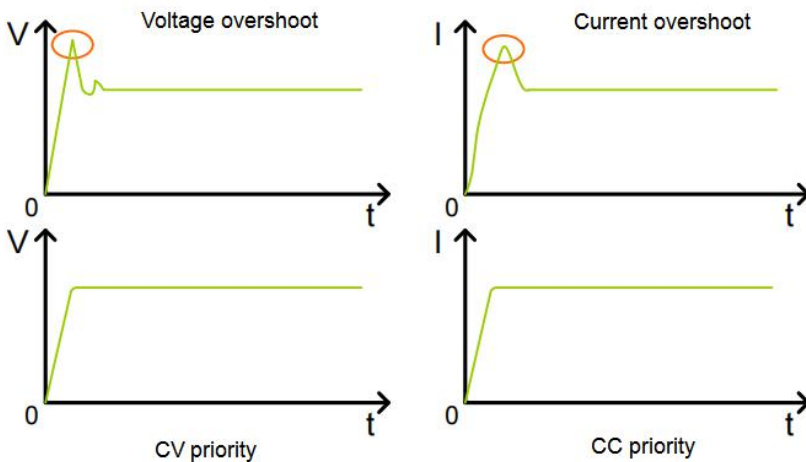



Figure 3-4 CV, CC Priority V / I Waveform

Operation:

1. Press  ;
2. Select "Set" >> "App Set", press "Enter" to enter the application setting page shown as below:

| | | | |
|----------------------|--------|------|-------|
| Set | System | Edit | About |
| Samp Rate | 10Hz | | |
| Prio SLT | Volt | | |
| V _{slew-UP} | 5000.0 | V/s | |
| V _{slew-DN} | 5000.0 | V/s | |
| I _{slew-UP} | 2000.0 | V/s | |
| I _{slew-DN} | 2000.0 | V/s | |



Figure 3-5 CV, CC Priority Set

3. Select "Prio SLT" item to set, "Volt" stands for voltage priority while "Curr" stands for current priority.

3.6 Output Control

The power supply's output is turned off when it is switched on. Users control its output via front panel key.



-  key is lighted, suggests the output is turned on, the screen displays voltage, current, power, operation mode in real time;
-  key is light off, suggests the output is turned off, "OFF" is displayed in the status prompt area.

3.7 Analog interface (optional PRO-INT interface)

3.7.1 Analog Programming

Users are able to control the power supply's output voltage, output current and output power through external 0 ~ 5V DC voltage, connections as follows:

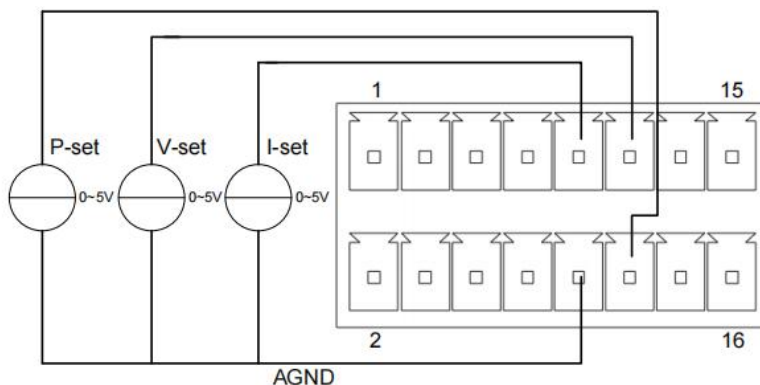

Figure 3-6 Analog Interface Programming Connection

Analog programming control speed is 1000 points per second, external 0 ~ 5V DC voltage corresponds to 0 ~ 100%F.S. output voltage, current, power.

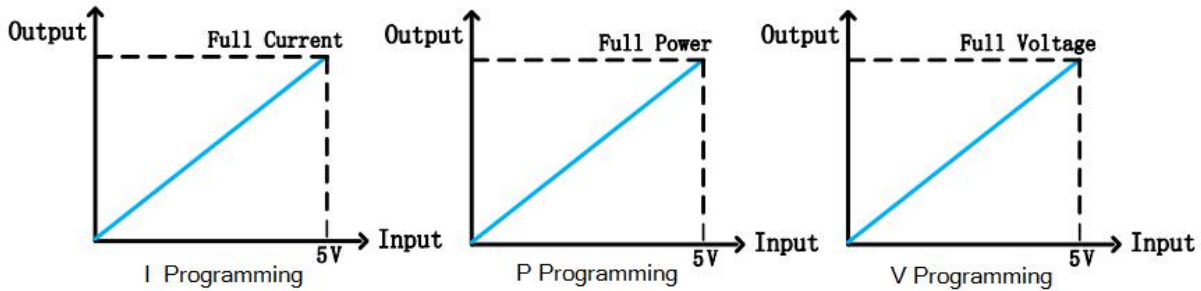

Figure 3-7 Input Programming Signal And Output Relation

Operation:

1. Press  to enter the main menu.

2. Select "Set" >> "EXT Prog" and press  to enter external programming page as shown below:

| | | | |
|-------|---------|------|-------|
| Set | System | Edit | About |
| APG_V | OFF | | |
| APG_I | OFF | | |
| APG_P | OFF | | |
| EXT-S | Trigger | | |

Figure 3-8 External Programming Set

3. Select APG_V, APG_I, APG_P for performing voltage programming, current programming or power programming turn on/off operations respectively, the status prompt area will prompt "E-VIP" symbol if any of these three programming selections is turned on.

4. Press  to turn on output.

 **Notice**

1. Altering of "External Programming Set" is allowed only when the output is turned off.
2. The external signal controls the output voltage/current/power on the condition that corresponds voltage/current/power programming is turned on, otherwise the power supply output can still be controlled by the front panel or remote communication.

3.7.2 External Control

FTP9000 series power supply analog interface provides an input "INHIBIT" for trigger signal, as shown below:

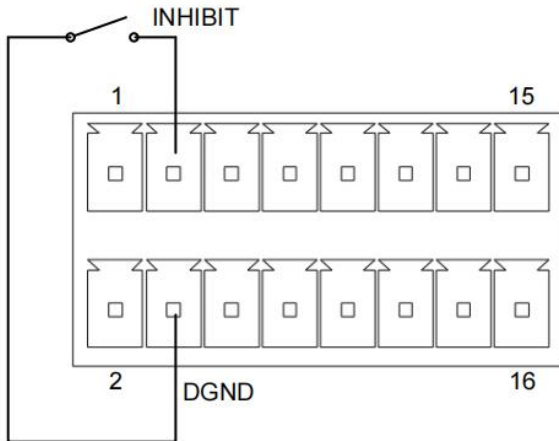



Figure 3-9 Trigger Signal Connection

This "INHIBIT" port receives 5V TTL level signal, low level is effective. You can use a physical switch such as "Figure 3-9 Trigger Signal Connection" or a 0~5VDC signal source for triggering. Closed or 0V is low level, open or 5V is high level. The port response time is about 20 milliseconds, and can be set to Trigger, Toggle, Hold three behaviors.

Trigger: Default setting. Used as trigger signal. The port detects a valid low-level pulse, that is, a trigger signal is received.



Toggle: Used as power supply output ON/OFF control signal. The output ON/OFF is switched once when the port detects a valid low-level pulse. Same effect as you press  once on the front panel.

Hold: Used as power supply output ON/OFF control signal. Output is turned ON when the port detects a valid low-level signal; turned off when the port detects a valid high-level signal.



Keyboard control, external control and System Bus control take effect at the same time and work together.

Operation:

1. Press  to enter the main menu.
2. Select "SET" >> "Ext Prog" and press  to enter external programming page as shown in Figure 3-8.
3. Select "EXT-S", you can configure among "Trigger", "Toggle", or "Hold". Default setting is "Trigger".

3.7.3 Voltage, Current Monitoring Output

FTP9000 series power supply provides analog monitoring output function for its output voltage and current, with a speed up to 1000 points per second. Power supply 0 ~ 100%F.S. output voltage/current corresponds to 0 ~ 5VDC monitoring output, this function is valid once the power supply is powered on.

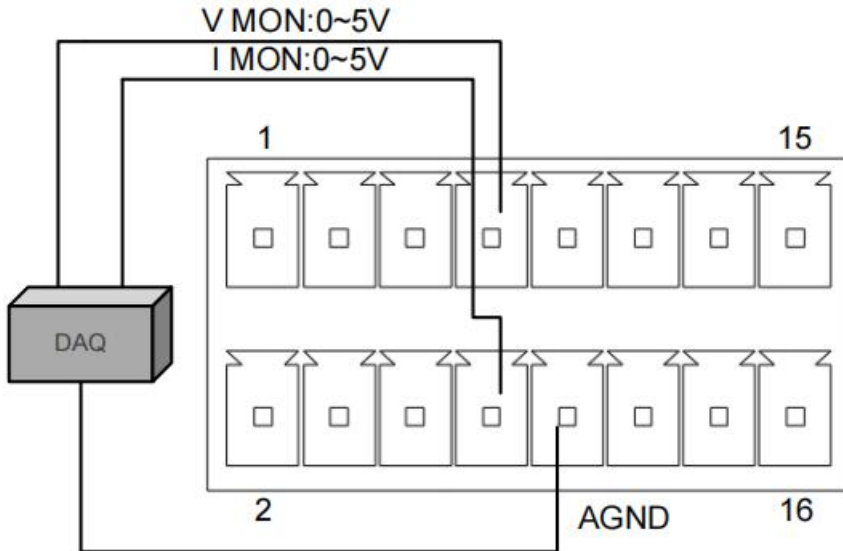

Figure 3-10 Voltage, Current Analog Monitoring Connection

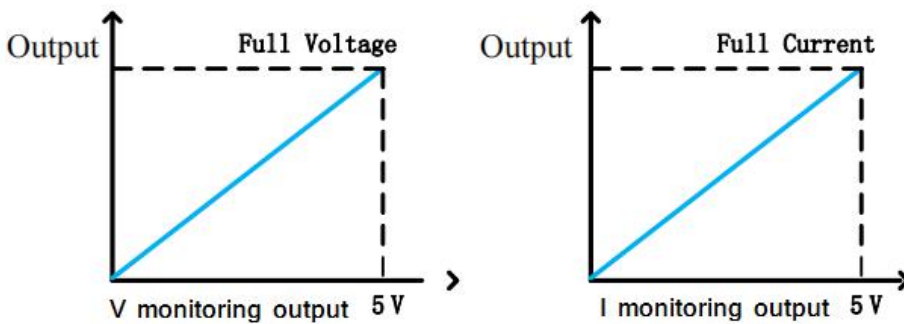

Figure 3-11 Output Voltage, Current And Monitoring Output

3.7.4 Output Mode & Status Monitoring

The FTP9000 series power supply has an output mode signal port and a fault indication signal port. The port outputs a 5V TTL level signal, and its functions are as follows:

Output mode signal port, low level indicates that the power supply is working in CV mode, and high level indicates that the power supply is working in CC or CP mode;

Fault indication signal port, low level indicates that the power supply is working normally, high level indicates that the power supply is abnormal, or protection has occurred but not cleared.

For specific please refer "Table 2-4 Analog Interface Function Explanation".

3.8 Protection

FTP9000 series power supply provides protections against overvoltage, overcurrent, overpower, low voltage, output reverse voltage, communication timed out, overtemperature.

When a protection occurs, the power supply will turn off output, sounds an alarm, and prompt corresponding protection information on display.

1. Press  to enter the main menu.

2. Select "Set" >> "Protect" and press  to enter protection setting page as shown below:

| Set | System | Edit | About |
|-----------|---------|------|-------|
| OVP | 0.000 V | | |
| OCP | 0.000 A | | |
| OPP | 0.000 W | | |
| LVP | 0.000 V | | |
| Over time | 0.0 s | | |
| Detect RV | OFF | | |

Figure 3-12 Protection Set

3. Select the corresponding item to set the desired value.

4. When a protection occurred, press  to clear the protection state and warning message.

Overvoltage protection (OV/OVP)

It has two kinds of overvoltage protection: hardware overvoltage (OV) and software overvoltage (OVP).

- Hardware overvoltage protection (OV): It is triggered once the output voltage exceeds 105% rated output voltage, and "OV" is prompt on display.
- Software overvoltage protection (OVP): It is programmable as shown in "Figure 3-12 Protection Set". Users are able to set the OVP threshold, set to 0 means to turn off OVP. OVP is triggered once the output voltage exceeds OVP set, and "OVP" is prompt on display.

Overcurrent protection (OC/OCP)

It has two kinds of overcurrent protection: hardware overcurrent (OC) and software overcurrent (OCP).

- Hardware overcurrent protection (OC): It is triggered once the output current exceeds 105% rated output current, and "OC" is prompt on display.
- Software overcurrent protection (OCP): It is programmable as shown in "Figure 3-12 Protection Set". Users are able to set the OCP threshold, set to 0 means to turn off OCP. OCP is triggered once the output current exceeds OCP set, and "OCP" is prompt on display.

Overpower protection (OP/OPP)

It has two kinds of overpower protection: hardware overpower (OP) and software overpower (OPP).

- Hardware overpower protection (OP): It is triggered once the output power exceeds 110% rated output power, and "OP" is prompt on display.
- Software overpower protection (OPP): It is programmable as shown in "Figure 3-12 Protection Set". Users are able to set the OPP threshold, set to 0 means to turn off OPP. OPP is triggered once the output power exceeds OPP set, and "OPP" is prompt on display.

Low voltage protection (LVP)

It is programmable as shown in "Figure 3-12 Protection Set". Users are able to set the low voltage protection threshold, set to 0 means to turn off this protection. Low voltage protection is triggered once the output voltage is below the set value, and "LVP" is prompt on display.

Reverse voltage warning (RVP)

It is triggered once the output polarities are reverse connected, and "RVP" is prompt on display.

Communication timed out protection (CMF)

When power supply is controlled remotely, you can turn on this protection. It is triggered if the host computer did not send communication command to the power supply for a certain period, the power supply output will be turned off and "CMF" is prompt on display. The triggering time can be set as in "Figure 3-12 Protection Set", range 0.0 ~ 60.0 seconds.

Overtemperature protection

It is triggered once the temperature of inner power components exceeds allowed temperature range, "OTP1" or "OTP2" is prompt on display.

3.9 Save And Recall

The power supply provides 20 groups of storage locations for users to save static output parameters, such as voltage setting, current setting, power setting, voltage slope, and current slope to a designated internal memory location, so that the user can easily and quickly recall and use. If the shortcut function is turned on, you only need to press a number key to recall the saved parameters. This function can significantly reduce user's operations and improve test efficiency.

Operation:

When users need to use the save and recall functions, they should first configure the parameters of the static output. The following examples illustrate:





1. Switch to the static output (by pressing the V-Set, I-Set or P-Set button), set the voltage to 12V, the current to 10A, the power to 1000W, the maximum voltage slope, and the maximum current slope;

2. Press  to enter save state;







3. Input number "1" and press  to validate the setting, so the setting parameters now stored to position "1";

4. Change the static output parameters, set the voltage to 24V, the current to 20A, the power to 2000W, the maximum voltage slope, and the maximum current slope;

5. Press  to enter save state;



6. Input number "2" and press  to validate the setting, the setting parameters now stored to position "2";
7. Press  to enter recall interface;
8. Input number "1" and press  to activated it, the power supply will switch to static output with the recalled parameters of position "1": voltage 12V, current 10A, power 1000W, maximum voltage and current slew rate;
9. Press  to enter recall interface;
10. Input number "2" and press  to activated it, the power supply will switch to static output with the recalled parameters of position "2": voltage 24V, current 20A, power 2000W, maximum voltage and current slew rate;

Shortcut Function

1. Press  ;
2. Select "Set" >> "System" and press  , then select "Others" and press  again;
3. Set "Shortcut" as ON, so as to activate it;
4. Press  to return to MAIN PAGE;
5. In MAIN PAGE, when it is not in parameter editing state, press number key to quick recall parameters in position 1~10.  ~  corresponds to storage location 1 ~ 9,  corresponds to position 10.

3.10 Power-down Save

FTP9000 series provides power-down save function. The power supply will resume last time working parameters at its power on moment when power-down save function is activated, otherwise the power supply will initialize using default parameters when it is turned on.

1. Press  ;
2. Select "Set" >> "System" and press  , then select "Others" and press  again;
3. Set "Power Save" item as ON, so as to activate it;

3.11 Keyboard Lock And Unlock

Press  +  to lock the keyboard.

When keyboard locked, only ON/OFF button and "Shift+9" operations are valid, the other key operations are invalid. At the same time, the parameter setting area in MAIN PAGE will shown in gray color to differentiate with normal unlocked state.

To unlock the keyboard, press  +  again.

3.12 Sequence (SEQ) Function



For sequence test function, the corresponding menu option is "Sequence". The sequence feature allows users to program a list of steps to the power supply's internal memory and execute them. A total of 100 steps can be allocated to each internal memory location, up to a maximum of 10 locations (sequences files). Voltage, current and delay can be set in each step. Sequence file supports "cycle" and "link" attributes. "cycle" controls the sequence file to run cyclically for a specified times, set to 0 means infinite loop. "Link" can add other sequence file into test, set to 0 means no linked sequence file.

When the sequence test is turned on, the highest voltage and current slew rate are used by default.

Table 3-4 Sequence Parameter Explanation









| Parameter | Explanation |
|-----------|---|
| Length | SEQ file running steps, range 1 ~ 100 |
| Cycle | Set SEQ file running cycles, range 0 ~ 60000, value 0 means infinite cycle. Default value is 1. |
| Link | Range 0 ~ 10, call specified SEQ file to run at this step, value 0 means no linked file |
| SEQ Step | Choose the specified step to edit. Range 0 ~ 100 |
| V_Set | Output voltage for current step, Range 0 ~ max. Output voltage |
| I_Set | Output current for current step, Range 0 ~ max. Output current |
| Step-Time | Delay for current step, range 0.001 ~ 86400s. The delay time is counting from the moment that the current step V/I reaches the setting value. |

Program Sequence (SEQ):

1. Press  ;
2. Select "Edit" >> "Sequence" press  to enter sequence file choosing page;
3. Rotate the rotary knob or input numbers to choose a file for editing, press  to enter SEQ editing page:

| Set | System | Edit | About |
|-----------|-----------|-------------|------------|
| SEQ Step | 1 | File Length | <u>100</u> |
| V_Set | 0.000 V | Cycle | 1 |
| I_Set | 0.000 A | Link | 0 |
| Step-Time | 86400.0 s | | |

Figure 3-13 Sequence File Edit

4. Set "Length", press  to validate it, the editing cursor will move to "Cycle" automatically;
5. Set "Cycle", press  to validate it, the editing cursor will move to "Link" automatically;
6. Set "Link", press  to validate it, the editing cursor will move to "SEQ Step" automatically;
7. Set "SEQ Step", press  to validate it, the editing cursor will move to "V_Set" automatically;
8. Set "V_Set", press  to validate it, the editing cursor will move to "I_Set" automatically;
9. Set "I_Set", press  to validate it, the editing cursor will move to "Step-Time" automatically;
10. Set "Step-Time", press  to validate it, the editing cursor will move to "SEQ step" automatically;
11. Repeat procedures of 7 ~ 11, till all sequence steps have been programmed.
12. Press  to save the programmed sequence file.
13. Press  to quit sequence editing.

 **Notice** When output is ON, sequence editing is not allowed.

Running sequence file

1. Press  to enter test function selecting page;

2. Rotate the rotary knob to select "Sequence", press  to activate sequence test, the screen will displays:

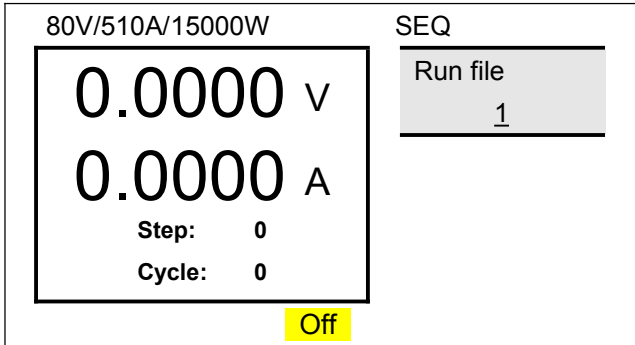



Figure 3-14 Sequence Test Display

3. Set "Run File", press  to validate it;

4. Press  to start sequence test.

About the display information: "Step:" shows the current sequence step, "Cycle:" shows how many cycles the sequence have run.

3.13 Internal Resistance Simulation (RESI)

Since a battery has internal resistance, its output voltage will decrease along with the increasing output current. FTP9000 series power supply provides internal resistance simulation feature to imitate the output characteristics of batteries. With this function, the power supply output voltage satisfy below formula:

$$V_o = V_s - I_o \times R_{Inner}$$

V_o : Actual output voltage;



V_s : Theoretical output voltage;

I_o : Output current;

R_{Inner} : simulated Inner resistance.

Operation:

1. Press  to enter test modes selection interface;

2. Use "Rotary"  knob to select "RESI", press , the screen displays as below:

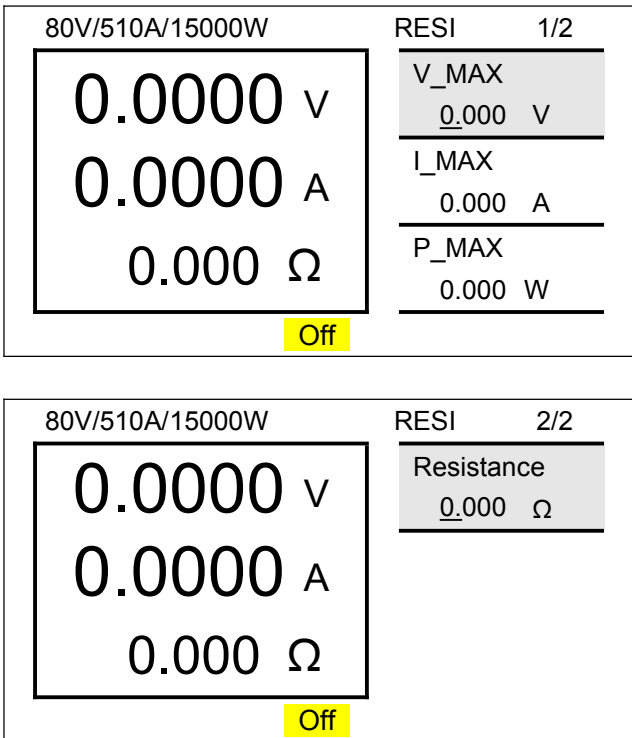

Figure 3-16 Output Test For Battery Simulating

3. Set the corresponding test parameters;
4. Press  to turn on battery simulating output.



Table 3-5 RESI Test Parameter Explanation

| Parameter | Notes |
|------------|--|
| V_MAX | RESI simulating output max voltage |
| I_MAX | RESI simulating output max current |
| P_MAX | RESI simulating output max power |
| Resistance | RESI simulating battery inner resistance |

3.14 Voltage ramp-up, ramp-down (RAMP)

FTP9000 series power supply allows for output voltage ramp-up and ramp-down according to the set slew rate.

Operation:

1. Press  to enter test modes selection interface;
2. Use "Rotary"  knob to select "RAMP", press , the screen displays as below:

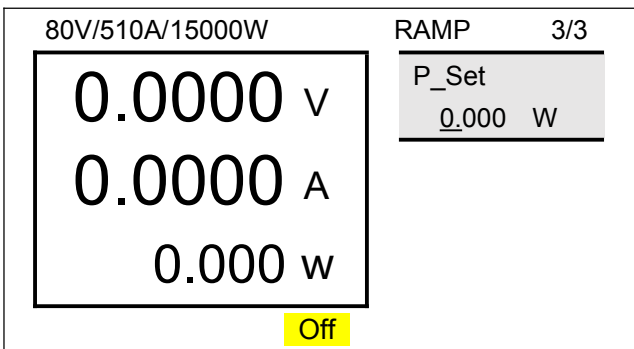
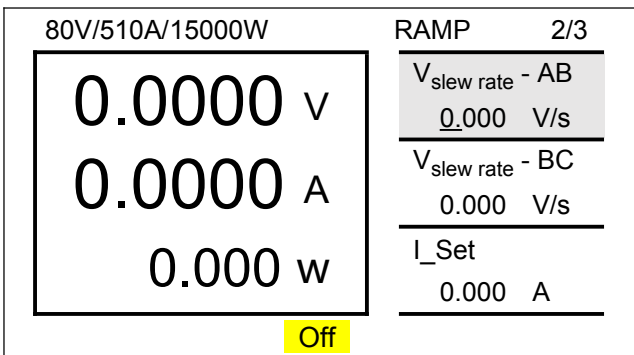
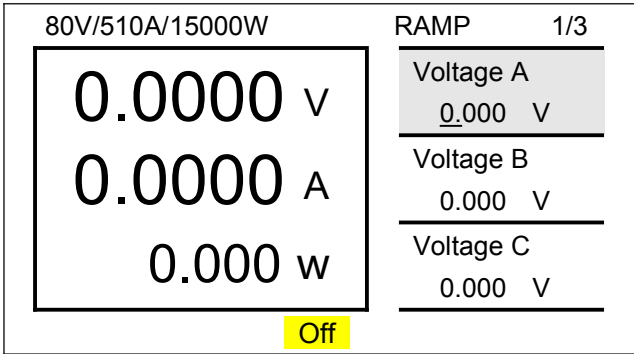

Figure 3-17 RAMP Function Parameter Set

3. Set the corresponding parameters, you can refer to "Table 3-6 RAMP Function Parameter Explanation" ;
4. Press  to turn on voltage ramp output.

Table 3-6 RAMP Function Parameter Explanation

| Parameter | Explanation |
|-----------|-------------|
|-----------|-------------|

| | |
|-----------------------------|---|
| Voltage A | Set voltage for A, range: 0 - Max output voltage |
| Voltage B | Set voltage for B, range: 0 - Max output voltage |
| Voltage C | Set voltage for C, range: 0 - Max output voltage |
| $V_{\text{slew rate - AB}}$ | Set voltage slew rate from A to B, range: 0.0006V/s to 6000V/s, default value 50% max slew rate |
| $V_{\text{slew rate - BC}}$ | Set voltage slew rate from B to C, range: 0.0006V/s to 6000V/s, default value 50% max slew rate |
| I_Set | Set output current, range: 0 - Max output current |
| P_Set | Set output power, range: 0 - Max output power |

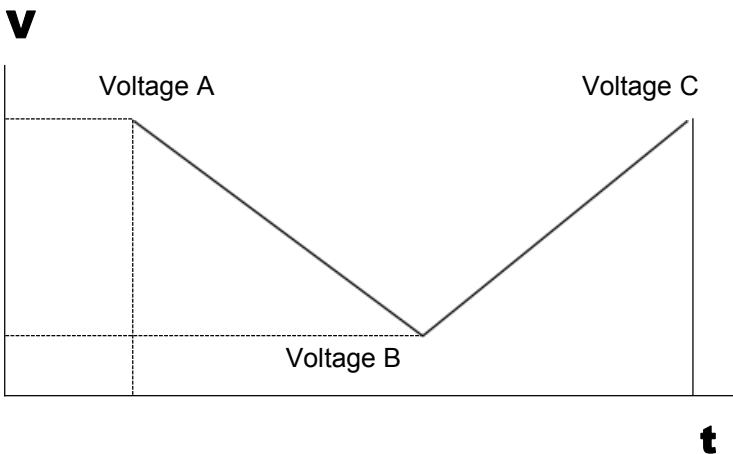

Figure 3-18 RAMP Function Parameter Set

3.15 Master-slave Parallel

3.15.1 Master-slave parallel connection

FTP9000 series power supplies provide a master-slave parallel mode, so that users can achieve greater output power by paralleling same models. The user uses proper wires to connect the "Share" interface in the rear panel, the "RS485" parallel communication interface in the "PRO-INT" port, and the output positive and negative poles according to "Figure 3-19 Master-Slave Parallel Connection", and then make corresponding configuration for the power supplies to realize the master-slave parallel function, operating the whole group is as simple as operating a stand-alone power supply.

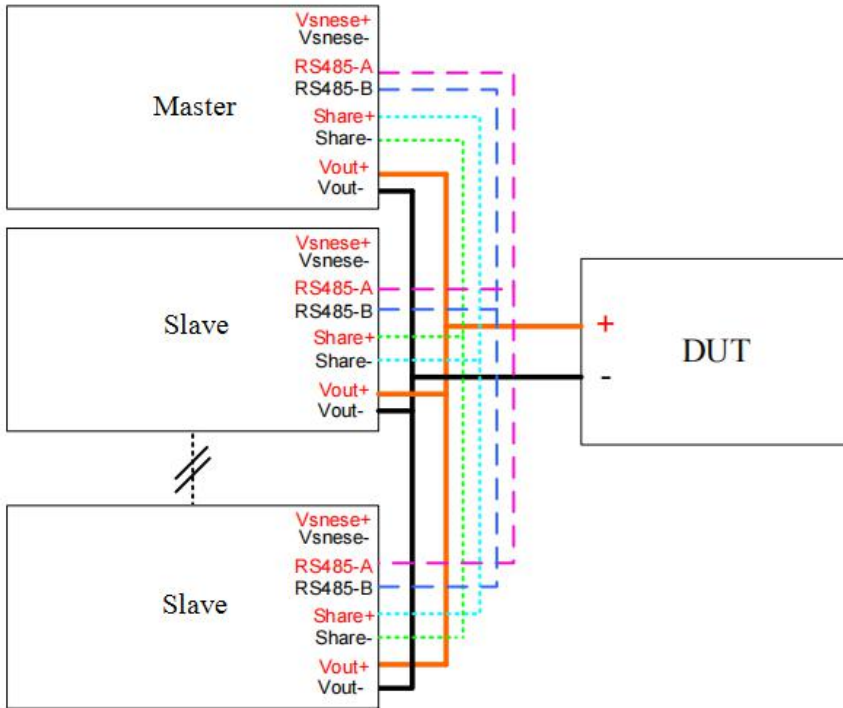

Figure 3-19 Master-Slave Parallel Connection

Master-slave parallel cable requirements

It is OK to use cross-sectional area 0.5 mm² ~ 1 mm² double strand wire for RS485 and "Share" ports.



1. Master-slave parallel support identical power supplies only;
2. Max 10 units;
3. Use the V SENSE terminal of the master unit if you want to compensate voltage line loss;
4. Does not support master-slave series operation

3.15.2 Master-slave parallel setting

Slave setting

1. Press  to enter main menu interface;

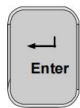

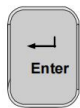

2. Select "Set" >> "Parallel", then press  to display master-slave parallel setting page;
3. "M_or_S" item set as "Slave1", "Slave2"... etc., one number corresponds to one slave power supply, number starts from 1 and must be consecutive, repeat numbers are forbidden because it leads to communication error.
4. Unwanted configuration items are hidden when a slave power supply returns to main display page.

Master setting

| Set | System | Edit | About |
|---------|--------|------|-------|
| M_or_S | Master | | |
| S.NUM | 1 | | |
| MS_CTRL | OFF | | |

Figure 3-20 Master-Slave Parallel Set

1. Press  to enter main menu interface;
2. Select "Set" >> "Parallel", then press  to display master-slave parallel set page;
3. "M_or_S" item set as "Master";
4. "S.NUM" item set as the actual number of slave power supplies;
5. "MS_CTRL" item as as "ON".

Press  to return to main page after completing the parallel parameter setting. The master power supply specifications will be updated.

3.15.3 Master-slave parallel function operations

Simply operate the master unit to control the whole group if you have configured the master-slave parallel correctly. The relative protections are still in effect once parallel function is turned on. The system will automatically turn off all power outputs if one unit in the group is protected. The corresponding slave unit displays the specific fault information, and the master unit displays the master fault information and the fault slave code, as shown in the figure below:

| | |
|------------------|------------------|
| 80V/1020A/30000W | V.I.P |
| 0.0000 V | V_SET 0.000 V |
| 0.0000 A | I_SET 0.000 A |
| 0.000 W | P_SET 0.000 W |
| SP01 Σ-P | Off |

Figure 3-21 Master display

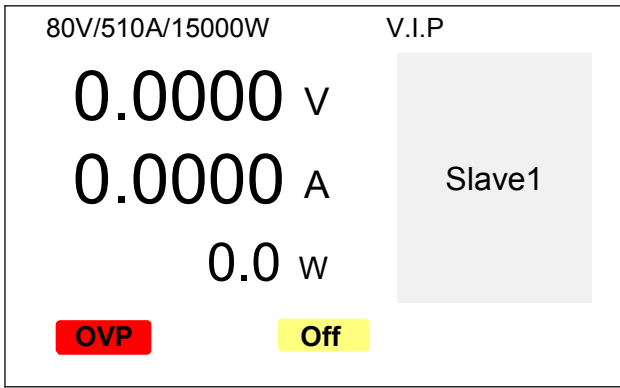

Figure 3-22 Slave display



When a protection occurred in the slave unit, please press  to clear fault in corresponding slave unit and in master unit. When protection occurred in master unit only, just press  on master unit to clear fault. Possible protections and fault in parallel operations are listed as follows:

Table 3-7 Master-slave parallel protection

| Protection Display | Explanation |
|---|---|
| Σ -P | Parallel communication normal, symbol is white background and not blinking |
|  | Parallel communication error, symbol is red background and blinking |
|  | Indicates the fault slave unit code, requires user to press  to clear the fault protection |

 CAUTION

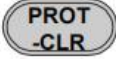
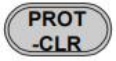
1. Set slave unit first, so as to avoid master unit communication error;
2. Multiple power supplies have been set as master unit leads to parallel operation failure;
3. If cable in "Share" port is not connected or fall off, then although the specifications are updated in accordance with number of slave units when the master unit turns on master-slave parallel control, the actual output will be inconsistent with the master unit configuration due to "Share" port fault.
4. The external programming of the master unit is effective to the whole group.
5. When a power supply is configured as slave unit, the previous set protection value in "Protection" are canceled. To resume you have to reset its values.
6. It is prohibited for paralleling different power supply models, because this will damage the power supplies.

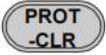
4. Communication Introduction

FTP9000 series power supply provides users with 5 types of communication interfaces: standard USB (serial), LAN (Ethernet), optional GPIB or CAN or RS485 interfaces. FTP9000 supports standard Modbus, SCPI protocol, default protocol is ModBus. Users are able to configure communication ports and protocols base on requirements.

4.1 Communication Setup

1. Press  to enter main menu page;

2. Select "System">>"Communication ", press  to pop up system parameter setting page as below:

| Set | System | Edit | About |
|-----------|---------------|----------|--------|
| IP | 192.168.1.123 | | |
| S_Mask | 255.255.255.0 | | |
| Baud | 9600 | | |
| Parity | None | Protocol | Modbus |
| DEVI-ADDR | 160 | | |
| GPIB | 5 | | |

Figure 4-1 Communication Parameter Setting Interface

3. For LAN communication: first please set "IP" as 192.168.1.123, subnet mask as 255.255.255.0, then set the IP address of the connecting PC to be in the same segment with the power supply IP. Different IP segments will result in communication failure. For example, computer network IP "192.168.1.100" is OK while "198.168.1.100" is not OK.

4. For USB communication: First please set "Baud", default value 9600, configurable among 4800, 9600, 19200, 38400, 115200. Then set "Parity" as "None".

5. For RS485 communication: First please set "Baud", default value 9600, configurable among 4800, 9600, 19200, 38400, 115200. Then set "Parity" as "None", "DEVI-ADDR" default value 160, range 0 ~ 254.

6. For CAN communication: set "DEVI-ADDR", default value 160, range 0 ~ 254 (Device address).

7. For GPIB communication: set "GPIB", default value 5, range 0 ~ 30 (GPIB address).

8. Set communication protocol, select ModBus or SCPI.

After modifying the communication configuration, you need to restart the power supply to take effect.





CAUTION

After modifying the communication configuration, you need to restart the power supply to take effect.

4.2 Voltage, current acquisition speed

After the above communication configuration is completed, if the user needs to increase the voltage, current acquisition speed, the configuration can be as follows:

1. Press  to enter main menu page;
2. Select "Set" >> "App Set", press  to show as below:

| | | | |
|----------------------|--------|------|-------|
| Set | System | Edit | About |
| Samp Rate | 10Hz | | |
| Prio SLT | Volt | | |
| V _{slew-UP} | 5000.0 | V/s | |
| V _{slew-DN} | 5000.0 | V/s | |
| I _{slew-UP} | 2000.0 | V/s | |
| I _{slew-DN} | 2000.0 | V/s | |

Figure 4-2 Application Setting

3. Select required speed in "Samp Rate", there are 5 choices select-able, Default is 10Hz.

4.3 Communication Interfaces

4.3.1 USB (Serial)

FTP9000 provides a USB virtual serial port, compatible with Windows XP/7/8/10. For specific driver software and installation, please refer to the "CD and Software User Manual".

The USB port uses a baud rate of 9600bps by default, parity type is None, and does not support flow control. Also, it adopts USB-B type terminal, users can use the accessory USB communication cable to easily connect to the USB port on the PC. Its pin signals are described in the following table:

Table 4-3 USB Interface Signals

| Pin NO. | Description |
|---------|-------------|
| 1 | 5V DC |
| 2 | Data- |
| 3 | Data+ |
| 4 | GND |

4.3.2 LAN

The FTP9000 series power supply has an Ethernet communication interface and adopts UDP communication mode. The default IP address is 192.168.1.123, the default subnet mask is 255.255.255.0, and the default port number is 7000.



CAUTION

Before starting communication, make sure that the address of the PC and the power supply are in the same network segment, and that there is no duplicate IP address with the power supply in this network segment, otherwise it will not be able to connect correctly.

4.3.3 CAN

The CAN interface uses a fixed communication speed of 500kbps, and the communication address can be set from 0 to 255.



图 4- 3 CAN 通讯连接



Notice

CAN interface uses CANopen protocol.

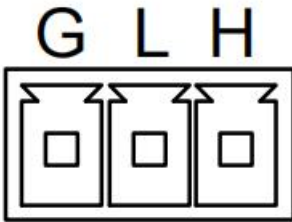
4.3.4 RS485

The RS485 communication interface configuration is the same as that of the USB serial port. The baud rate and parity method can be configured through "Figure 4-1 Communication Parameter Setting Interface". The connection method is as follows:



图 4- 4 RS485 通讯连接

4.4 Communication Protocol

FTP9000 series power supplies support SCPI, Modbus and CANopen communication protocols. For LAN, USB serial port, RS485 interface, users can choose SCPI or Modbus; for GPIB interface, only SCPI protocol is supported, and CAN interface only supports CANopen protocol.

4.4.1 SCPI protocol

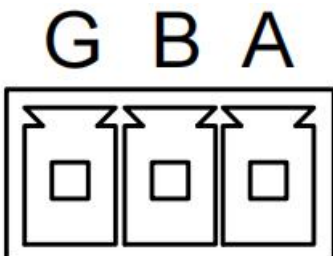
For specific content of SCPI protocol, please refer to "FTP9000 Programming Manual SCPI Edition".

4.4.2 Modbus protocol

For specific content of Modbus protocol, please refer to "FTP9000 Programming Manual Modbus Edition"

 **Notice** Regarding to ModBus protocol, FTP9000 series support RTU communication mode only.

4.4.3 CANopen protocol

For specific content of CANopen protocol, please refer to "FTP9000 Programming Manual CANopen Edition"

 **Notice** CANopen protocol is an optional protocol.

5. Troubleshooting

Follow the actions described in this chapter to inspect the instrument and troubleshoot the problem if the FTP9000 series DC Power Supply does not operate normally. Contact Faithtech authorized agent or Faithtech after-sales if the information provided in this manual does not resolve the problem.

Table 5-1 Fault Check





| Problem | Possible Cause | Solution |
|--|--|--|
| Measurement accuracy is not within SPEC. | Measurement swings due to aged components. | Do calibration. |
| Output accuracy is not within SPEC. | Output swings due to aged components. | Do calibration |
| PMF Fault | <ol style="list-style-type: none"> 1. The grid power supply is below the instrument requirement; 2. PMF triggered by power failure | <ol style="list-style-type: none"> 1. Check whether the grid power supply is normal 2. Neglectable if PMF triggered by power failure 3. Press  to clear protection state. |
| Overtemperature Protection (OTP1、OTP2) | <ol style="list-style-type: none"> 1. The ambient temperature is too high. 2. Bad ventilation. 3. Fan damaged. | <ol style="list-style-type: none"> 1. Operate the instrument within an ambient temperature of 0 - 40°C. 2. Ensure the instrument is well ventilated. 3. Contact Faithtech authorized agent or Faithtech after-sales. 4. Press  to clear protection state. |
| Overpower Protection (OPP, OP) | The output power exceeds the spec. or OPP settings. | <ol style="list-style-type: none"> 1. Decrease load or increase OPP setting. 2. Press  to clear protection state. |
| Overcurrent Protection (OCP, OC) | The output current exceeds the spec. or OCP settings. | <ol style="list-style-type: none"> 1. Decrease load or increase OCP setting. 2. Press  to clear protection state. |
| Overvoltage Protection (OVP, OV) | The output voltage exceeds the spec. or OVP settings. | <ol style="list-style-type: none"> 1. Decrease output voltage or increase OVP setting. 2. Press  to clear protection state. |

Table 5-2 Power on Self-test Fault Check

| Problem | Possible Cause | Solution |
|----------------------------------|--|--------------------------------------|
| The PRI Fault... Error! | Internal communication error Power module error | Contact Faithtech after-sale service |
| Test sample. Error! | Sampling data error | |
| Loading calibration data. Error! | Loading calibration data failure | |
| Loading parameters. Error! | Loading system para failure | |

6. Appendix

Table 6-1 Recommended Wire Diameters for Cables

| Type | Cross-sectional area | Different temperature conditions | | | |
|------|----------------------|----------------------------------|-----------------------|---------------------|-------------------------------|
| AWG | mm ² | 60°C | 75°C | 85°C | 90°C |
| | | Wire type: RUW, T, UF | Wire type: RHW, RH | Wire type: V, MI | Wire type: TA, TBS, SA, AV |
| | | Rated Current (A) | | | |
| 14 | 2.08 | 20 | 20 | 20 | 20 |
| 12 | 3.31 | 25 | 25 | 30 | 30 |
| 10 | 5.26 | 30 | 35 | 40 | 40 |
| 8 | 8.36 | 40 | 50 | 55 | 55 |
| 6 | 13.3 | 55 | 65 | 70 | 75 |
| 4 | 21.1 | 70 | 85 | 95 | 95 |
| 3 | 26.7 | 85 | 100 | 110 | 110 |
| 2 | 33.6 | 95 | 115 | 125 | 130 |
| 1 | 42.4 | 110 | 130 | 145 | 150 |
| 0 | 53.5 | 125 | 150 | 165 | 170 |
| 00 | 67.4 | 145 | 175 | 190 | 195 |
| 000 | 85 | 165 | 200 | 215 | 225 |
| 0000 | 107 | 195 | 230 | 250 | 260 |

Shenzhen Faithtech CO., LTD.

ADD: 3C, Building 1, Saitu Digital Industrial Park, No.137 Bulan Road, Longgang District, Shenzhen, China

Tel: (0086) 400-616-0086

Web: www.faithtech.cn