

Programmable AC/DC Power Source

ASR-3000 Series

PROGRAMMING MANUAL

Rev. A



ISO-9001 CERTIFIED MANUFACTURER

GW INSTEK

This manual contains proprietary information, which is protected by copyright. All rights are reserved. No part of this manual may be photocopied, reproduced or translated to another language without prior written consent of Good Will company.

The information in this manual was correct at the time of printing. However, Good Will continues to improve products and reserves the rights to change specification, equipment, and maintenance procedures at any time without notice.

Good Will Instrument Co., Ltd.
No. 7-1, Jhongsing Rd., Tucheng Dist., New Taipei City 236, Taiwan.

Table of Contents

SAFETY INSTRUCTIONS	4
GETTING STARTED.....	8
ASR-3000 Series Overview	9
Appearance.....	12
REMOTE CONTROL.....	20
Interface Configuration	21
Command Syntax	41
Command List	45
Status Register Overview	127
Error List	143
APPENDIX.....	152
Factory Default Settings.....	152
INDEX.....	157

S SAFETY INSTRUCTIONS

This chapter contains important safety instructions that you must follow during operation and storage. Read the following before any operation to ensure your safety and to keep the instrument in the best possible condition.

Safety Symbols

These safety symbols may appear in this manual or on the instrument.



Warning: Identifies conditions or practices that could result in injury or loss of life.



Caution: Identifies conditions or practices that could result in damage to the ASR-3000 or to other properties.



DANGER High Voltage



Attention Refer to the Manual



Protective Conductor Terminal



Earth (ground) Terminal



Do not dispose electronic equipment as unsorted municipal waste. Please use a separate collection facility or contact the supplier from which this instrument was purchased.

Safety Guidelines

General Guideline



CAUTION

- Do not place any heavy object on the ASR-3000.
- Avoid severe impact or rough handling that leads to damaging the ASR-3000.
- Do not discharge static electricity to the ASR-3000.
- Use only mating connectors, not bare wires, for the terminals.
- Do not block the cooling fan opening.
- Do not disassemble the ASR-3000 unless you are qualified.
- If the equipment is used in a manner not specified by the manufacturer, the protection provided by the equipment may be impaired.

Power Supply



WARNING

- AC Input voltage range:
200 ~ 240 Vac
 - Frequency: 47 ~ 63 Hz
 - To avoid electrical shock connect the protective grounding conductor of the AC power cord to an earth ground.
 - The power switch that is included in the instrument is not considered a disconnecting device.
 - The permanently connected power input is used as the disconnecting device and shall remain readily operable.
 - a. A switch or circuit-breaker must be included in the installation
 - b. It must be suitably located and easily reached
 - c. It must be marked as the disconnecting device for the equipment.
 - d. It shall be located near the equipment
 - Do not position the equipment so that it is difficult to operate the disconnecting device.
 - Ask for professional technician for installation.
 - It requires 200Vac input condition and the maximum input current [15A (ASR-3200), 22.5A (ASR-3300), 30A (ASR-3400)], which conforms to cord diameter by local regulations.
 - Breaker, of which the specification is required to larger than 20A (ASR-3200), 30A (ASR-3300), 40A (ASR-3400) individually, should be in the near proximity of unit.
-

-
- Cleaning the ASR-3000
- Disconnect the circuit-breaker or permanently connected power input before cleaning.
 - Use a soft cloth dampened in a solution of mild detergent and water. Do not spray any liquid.
 - Do not use chemicals containing harsh material such as benzene, toluene, xylene, and acetone.
-

- Operation Environment
- Location: Indoor, no direct sunlight, dust free, almost non-conductive pollution (Note below)
 - Relative Humidity: 20%~ 80%, no condensation
 - Altitude: < 2000m
 - Temperature: 0°C to 40°C
- (Pollution Degree) EN 61010-1:2010 specifies the pollution degrees and their requirements as follows. The ASR-3000 falls under degree 2. Pollution refers to “addition of foreign matter, solid, liquid, or gaseous (ionized gases), that may produce a reduction of dielectric strength or surface resistivity”.
- Pollution degree 1: No pollution or only dry, non-conductive pollution occurs. The pollution has no influence.
 - Pollution degree 2: Normally only non-conductive pollution occurs. Occasionally, however, a temporary conductivity caused by condensation must be expected.
 - Pollution degree 3: Conductive pollution occurs, or dry, non-conductive pollution occurs which becomes conductive due to condensation which is expected. In such conditions, equipment is normally protected against exposure to direct sunlight, precipitation, and full wind pressure, but neither temperature nor humidity is controlled.
-

- Storage environment
- Location: Indoor
 - Temperature: -10°C to 70°C
 - Relative Humidity: ≤90%, no condensation
-

Disposal



Do not dispose this instrument as unsorted municipal waste. Please use a separate collection facility or contact the supplier from which this instrument was purchased. Please make sure discarded electrical waste is properly recycled to reduce environmental impact.

GETTING STARTED

This chapter describes the ASR-3000 power supply in a nutshell, including its main features and front / rear panel introduction.

ASR-3000 series



ASR-3000 Series Overview	9
Series lineup	9
Main Features	9
Accessories	10
Appearance	12
Front Panel	12
Rear Panel	17

ASR-3000 Series Overview

Series lineup

The ASR-3000 series consists of 3 models, the ASR-3200, ASR-3300 and ASR-3400, differing only in capacity. Note that throughout the user manual, the term “ASR-3000” refers to any of the models, unless stated otherwise.

Model Name	Power Rating	Max. Output Current	Max. Output Voltage
ASR-3200	2000 VA	20 / 10 A	400 Vrms / 570 Vdc
ASR-3300	3000 VA	30 / 15 A	400 Vrms / 570 Vdc
ASR-3400	4000 VA	40 / 20 A	400 Vrms / 570 Vdc

Main Features

- Performance
- Maximum AC output voltage is 400 Vrms
 - Maximum DC output voltage is 570 Vdc
 - Maximum output frequency is 999.9 Hz in AC mode
 - Supported AC+DC waveform application
 - DC full capacity output ability
 - Output voltage total harmonic distortion is less than 0.5% at all frequency
 - Crest factor reached 6 times high
-

- Features
- Include sine, square, triangle, arbitrary and DC output waveforms
 - Variable voltage, frequency and current limiter
 - Harmonic voltage and current analysis ability
 - Excellent and feature-rich measurement capacity
 - Sequence and simulate function
 - External input amplification
 - AC line synchronized output
 - Preset memory function
 - USB memory support
 - Remote sense
 - OCP, OPP and OTP protection function

- Interface
- Built-in LAN, USB host, USB device, RS232 and GPIB interface
 - External control I/O
 - External signal input

Accessories

Before using the ASR-3000 power source unit, check the package contents to make sure all the standard accessories are included.

Standard Accessories	Part number	Description
	CD ROM	User manual, programming manual
	82GW1SAFE0M*1	Safety guide
	62SR-3K0SC101	Input terminal cover
	62SR-3K0SC201	Output terminal cover include remote sensing
	GRA-442-E	Rack mount adapter (EIA)

	GTL-246	USB CABLE (USB 2.0 Type A-Type B Cable, Approx. 1.2M)
Factory Installed Options	Part number	Description
	Optional 1	European Output Socket
Optional Accessories	Part number	Description
	GPW-005	Power Cord SJT 12AWG/3C, 3m Max Length, 105°C, RNB5-8*3P, RNB3-4*3P UL/CSA Type
	GPW-006	Power Cord H05W-F 1.5mm ² /3C, 3m Max Length, 105°C, RNB1-5*3P, RNBL2-4*3P VDE Type
	GPW-007	Power Cord VCT 3.5mm ² /3C, 3m Max Length, 105°C, RNB5-8*3P, RNB3-4*3P PSE Type
	GRA-442-J	Rack mount adapter (JIS)
	GTL-137	Output power wire (Load wire_10AWG: 50A, 600V) (Sense wire_16AWG: 20A, 600V)
	GTL-232	RS232C cable, approx. 2M
	GTL-248	GPIB Cable, approx. 2M
	ASR-002	External Three Phase Control Unit
	APS-008	Air inlet filter

Appearance

Front Panel

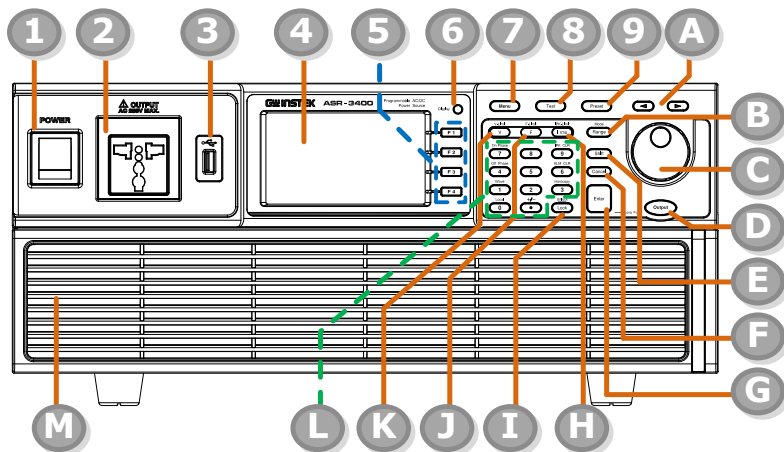

Item Index	Description
1	Power switch button
2	Output Socket
3	USB interface connector (A Type)
4	LCD screen
5	Function keys (blue zone)
6	Display mode select key
7	Menu key
8	Test key
9	Preset key
A	Arrow keys
B	Range key/Output mode key
C	Scroll wheel

D	Output key
E	Shift key
F	Cancel key
G	Enter key
H	Irms/IPK-Limit button
I	Lock/Unlock button
J	F/F-Limit button
K	V/V-Limit button
L	Numerical Keypad with additional “Shift + key” shortcut functions (green zone)
M	Air inlet

Item	Description
------	-------------

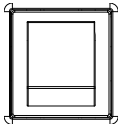

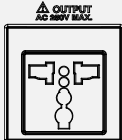

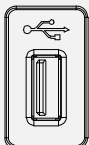



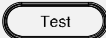

Power Switch		Turn on the mains power
--------------	---	-------------------------

Output Socket		Output voltage socket, which has 2 versions in accordance with different regions: Universal and European types, in front panel.
---------------	--	---

USB A Port		The USB port is used for data transfers and upgrading software. Also, it is available for screenshot hardcopy in association with the Hardcopy key.
------------	---	---









 **Note** It supports FAT32 format with maximum 32G storage only.



LCD Screen	Displays the setting and measured values or menu system
------------	---

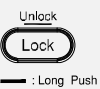

Function Keys		Assigned to the functions displayed on the right side of the screen.
Display Mode Select Key	Display 	Selects between standard, simple and harmonic analysis mode.
Menu Key		Enters the Main menu or goes back to one of the display modes.
Test Key		Puts the instrument into the Sequence and Simulation control mode.
Preset Key		Puts the instrument into Preset mode.
Arrow Keys		The arrow keys are used to select the digit power of a value that is being edited.
Range Key	Mode 	Switches between the 100V, 200V and AUTO ranges
Output Mode	 + 	Selects between the AC+DC-INT, AC-INT, DC-INT, AC+DC-EXT, AC-EXT, AC+DC-ADD, AC-ADD, AC+DC-Sync and AC-Sync modes.
Scroll Wheel		Used to navigate menu items or for increment/decrement values one step at a time.
Output Key		Turns the output on or off.



Shift Key  Turns on the shift state, which enables shortcut operations with an icon **Shift** indicated on the top status bar. The shift state, which allows continuous shortcut operations, is kept until another press on shift key again.

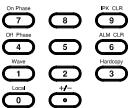

 **Note** When performing shortcut operations, press shift key followed by another shortcut function key. Do Not press both shift key and shortcut function key simultaneously.



Cancel Key		Used to cancel function setting menus or dialogs.
Enter Key		Confirms selections and settings.
I rms		Used for setting the maximum output current.
IPK-Limit		Used to set the peak output current limit value.
Lock/Unlock Key		Used to lock or unlock the front panel keys except output key. Simply press to lock, whilst long press to unlock.
F		Used for setting the output frequency (DC mode N/A).
F-Limit		Used for setting the output frequency limit value (DC mode N/A).
V		Used for setting the output voltage.



V-Limit  +  Used for setting the output voltage limit value.



Keypad  Used to input power of a value directly. The  key is used to input decimal / plus or minus.

On Phase  +  Sets the on phase for the output voltage.



Off Phase  +  Sets the off phase for the output voltage.

Output Waveform  +  Selects between the Sine, Square, Triangle and ARB 1~16 waveforms (not available for DC-INT, AC+DC-EXT and AC-EXT).

Local Mode  +  Switches operation back to local mode from remote mode.

IPK CLR  +  Used to clear peak output current value.

ALM CLR  +  Clears alarms.



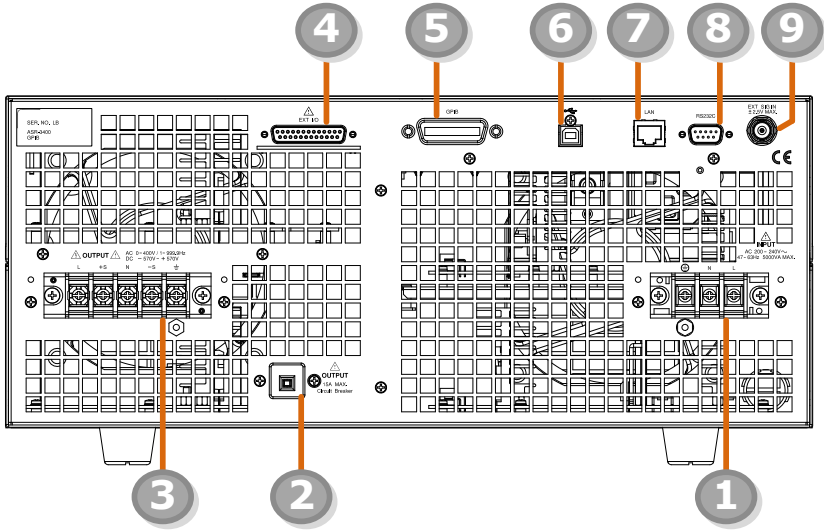

Hardcopy Key  +  Used to take a screenshot. Make sure a USB flash disk is well inserted before the action.

Air Inlet Air inlet for cooling the inside of the ASR-3000 series.

Rear Panel

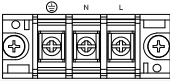

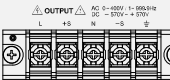
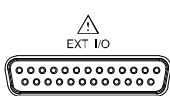
Item Index	Description
1	Line input terminal
2	Front panel output socket circuit breaker
3	Output terminal with remote sensing input terminal
4	External I/O connector
5	GPIB connector
6	USB interface connector (B Type)
7	Ethernet (LAN) connector
8	RS232 connector
9	External signal input/ External synchronized signal input

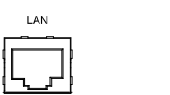
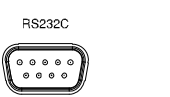
Item	Description	
AC Power Input terminal		AC inlet (M4 screw type, 8 ~ 22 AWG)
Circuit Breaker		When front panel output socket output current reaches 15A, the circuit breaker will be activated automatically to cut off output. Press the button to reset the function.
Output Terminal with Remote Sensing Input terminal		L, N, ⚡ : Output voltage terminal (M4 screw type, 8 ~ 22 AWG) +S, -S: Remote sensing input terminal is for compensation of load wire voltage drop.
External Control I/O Connector		Used to control ASR-3000 externally by using the logic signal and monitor Sequence function status.
GPIB Connector		The GPIB connector for controlling the ASR-3000 remotely.
USB		USB port for controlling the ASR-3000 remotely.
Ethernet Port		The Ethernet port is used for remote control.
RS232C Connector		The RS232C connector for controlling the ASR-3000 remotely.

External Signal
Input Connector



Synchronizing the output frequency with this external input signal for SYNC or outputting the amplified external signal with this external input signal for EXT and ADD.

REMOTE CONTROL

This chapter describes basic configuration of IEEE488.2 based remote control.



Interface Configuration	21
Configure Ethernet Connection	21
USB Remote Interface	22
USB Remote Control Function Check	23
RS-232 Remote Interface	24
RS232 Remote Control Function Check	26
Using Realterm to Establish a Remote Connection	28
GPIB Remote Interface	31
GPIB Function Check	32
Web Server Remote Control Function Check	35
Socket Server Function Check	36
Command Syntax	41
Command List	45

Interface Configuration

Configure Ethernet Connection

The Ethernet interface can be configured for a number of different applications. Ethernet can be configured for basic remote control or monitoring using a web server or it can be configured as a socket server.

The ASR-3000 supports both DHCP connections so the instrument can be automatically connected to an existing network or alternatively, network settings can be manually configured.

Ethernet Parameters	MAC Address (display only)	DHCP
	IP Address	Subnet mask
	Gateway	DNS address
	DNS Server	Socket port fixed at 2268
Ethernet Configuration	1. Connect a LAN cable from the PC to the Ethernet port on the rear panel.	
	2. Press the <i>Menu</i> key. The Menu setting will appear on the display.	
	3. Use the scroll wheel to go to item 3, <i>LAN</i> and press <i>Enter</i> .	
	4. If the LAN cable is installed correctly a connection is active, the <i>Connection Status</i> will show <i>Online</i> .	
	5. To automatically have the network assign an IP address, set DHCP to ON. Otherwise set DHCP to OFF to manually set the Ethernet settings.	
	DHCP	ON, OFF

- If DHCP was set to OFF, configure the remaining LAN parameters.

IP Address

Subnet Mask

Gateway

DNS Server

Socket Port



Note

Socket Port is fixed to 2268.

LAN configuration - 1

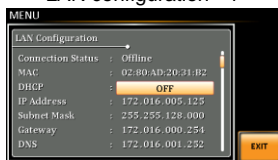

LAN configuration - 2



Exit

- Press *Exit*[F4] to exit from the LAN settings.



USB Remote Interface

USB Configuration	PC side connector	Type A, host
	ASR-3000 side connector	Rear panel Type B, slave
	Speed	1.1/2.0 (full speed)
	USB Class	CDC (communications device class)

Steps

- Connect the Type A-Type B USB cable from the PC to the rear panel USB B port.



2. Press the *Menu* key. The *Menu* setting will appear on the display. 
3. Use the scroll wheel to go to item 4, *USB Device*.
4. If the connection is successful *Connection Status* will change from *Offline* to *Online*.

Exit

5. Press *Exit*[F4] to exit from the rear panel USB settings.



USB Remote Control Function Check

Functionality
Check

Invoke a terminal application such as Realterm.

ASR-3000 will appear as a COM port on the PC.

To check the COM settings in Windows, see the Device Manager. For example, in Win7 go to the Control panel → System → Hardware tab.



If you are not familiar with using a terminal application to send/receive remote commands via a USB connection, please see page 28 for more information.

Run this query command via the terminal after the instrument has been configured for USB remote control (page 22).

*IDN?

This should return the Manufacturer, Model number, Serial number, and Software version in the following format.

GW-INSTEK,ASR-XXXX,GXXXXXXXXX,XX.XX

Manufacturer: GW-INSTEK

Model number : ASR-XXXX

Serial number : GXXXXXXXXX

Software version : XX.XX



Note

For further details, please see the programming manual, available on the GW Instek web site @ www.gwinstek.com.

RS-232 Remote Interface

RS-232 Configuration	Connector Parameters	BD-9, male Baud rate, data bits, parity, stop bits.
----------------------	----------------------	--

Pin Assignment		2: RxD (Receive data) 3: TxD (Transmit data) 5: GND 4, 6 ~ 9: No connection
----------------	--	--

Pin Connection Use a Null Modem connection (RS-232C cable) as shown in the diagram below.

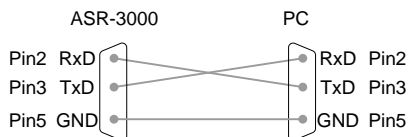

- Steps
1. Connect the RS-232C cable from the PC to the rear panel RS-232 port.

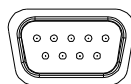

2. Press the *Menu* key. The Menu setting will appear on the display.



3. Use the scroll wheel to go to item 5, *RS232C* and press *Enter*.

4. Set the RS232C relative settings.

Baud rate	1200, 2400, 4800, 9600(default), 19200, 38400, 57600, 115200,
Data bits	7 bits, 8 bits(default)
Parity	None(default), Odd, Even
Stop bits	1 bit(default), 2 bits

RS232C Configuration



Exit

5. Press *Exit[F4]* to exit from the RS232C settings.



The standard accessory does Not include RS232 data cable. Please purchase the additional GTL-232 which will meet your need for RS232 connection.

RS232 Remote Control Function Check

Functionality Check

Invoke a terminal application such as Realterm.

For RS-232, set the COM port, baud rate, stop bit, data bit and parity accordingly.

To check the COM settings in Windows, see the Device Manager. For example, in Win7 go to the Control panel → System → Hardware tab.



Note

If you are not familiar with using a terminal application to send/receive remote commands from the serial port, please see page 28 for more information.

Run this query command via the terminal after the instrument has been configured for RS-232 remote control (page 24).

*IDN?

This should return the Manufacturer, Model number, Serial number, and Software version in the following format.

GW-INSTEK,ASR-XXXX,GXXXXXXXXX,XX.XX

Manufacturer: GW-INSTEK

Model number : ASR-XXXX

Serial number : GXXXXXXXXX

Software version : XX.XX



Note

For further details, please see the programming manual, available on the GW Instek web site @ www.gwinstek.com.

Using Realterm to Establish a Remote Connection

Background Realterm is a terminal program that can be used to communicate with a device attached to the serial port of a PC or via an emulated serial port via USB.

The following instructions apply to version 2.0.0.70. Even though Realterm is used as an example to establish a remote connection, any terminal program can be used that has similar functionality.



Note

Realterm can be downloaded on Sourceforge.net free of charge.

For more information please see
<http://realterm.sourceforge.net/>

- Operation**
1. Download Realterm and install according to the instructions on the Realterm website.
 2. Connect the ASR-3000 via USB (page 21) or via RS-232 (page 23).
 3. If using RS-232, make note of the configured baud rate, stop bits and parity.
 4. Go to the Windows device manager and find the COM port number for the connection. For example, go to the Start menu > Control Panel > Device Manager.

Double click the *Ports* icon to reveal the connected serial port devices and the COM port for the each connected device.

If using USB, the baud rate, stop bit and parity settings can be viewed by right-clicking the connected device and selecting the *Properties* option.

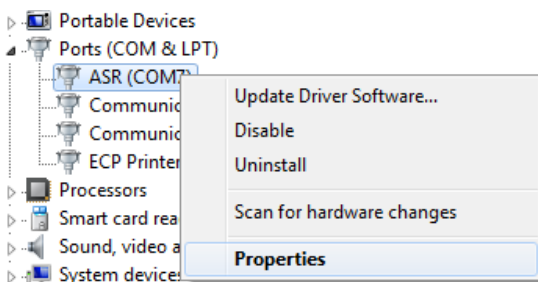

5. Start Realterm on the PC as an administrator.
Click:
Start menu>All Programs>RealTerm>realterm

Tip: to run as an administrator, you can right click the Realterm icon in the Windows Start menu and select the *Run as Administrator* option.

6. After Realterm has started, click on the *Port* tab.

Enter the *Baud*, *Parity*, *Data bits*, *Stop bits* and *Port number* configuration for the connection.

The *Hardware Flow Control*, *Software Flow Control* options can be left at the default settings.

Press *Open* to connect to the ASR-3000.

- The terminal display will return the following:

GW-INSTEK,ASR-XXXX,GXXXXXXXXX,XX.XX
 (manufacturer, model, serial number, software version)

- If Realterm fails to connect to the ASR-3000, please check all the cables and settings and try again.

GPIB Remote Interface

GPIB Configuration

- Connect a GPIB cable from the PC to the GPIB port on the rear panel.



- Press the *Menu* key. The Menu setting will appear on the display.



- Use the scroll wheel to go to item 6, *GPIB* and press *Enter*.
- Set the GPIB address.

GPIB Address 0 ~ 30 (10 by default)

GPIB Configuration

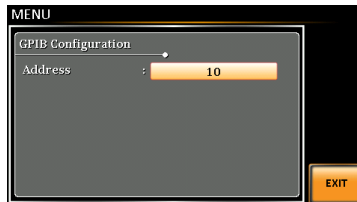

Note

Only one GPIB address can be used at a time.

Exit

5. Press *Exit*[F4] to exit from the GPIB settings.



GPIB Constraints

- Maximum 15 devices altogether, 20m cable length, 2m between each device
- Unique address assigned to each device
- At least 2/3 of the devices turned On
- No loop or parallel connection



Note

The standard accessory does Not include GPIB data cable. Please purchase the additional GTL-248 which will meet your need for GPIB connection.

GPIB Function Check

Functionality Check

Please use the National Instruments Measurement & Automation Controller software to confirm GPIB/LAN functionality.

See the National Instrument website, <http://www.ni.com> for details.



Note

- For further details, please see the programming manual, available on the GW Instek web site @ www.gwinstek.com
- Operating System: Windows XP, 7, 8, 10

Operation

1. Start the NI Measurement and Automation Explorer (MAX) program. Using Windows, press:



Start>All Programs>NI MAX



2. From the Configuration panel access;
My System>Devices and Interfaces>GPIB0
3. Press the *Scan for Instruments* button.
4. In the *Connected Instruments* panel the ASR-3000 should be detected as *Instrument 0* with the address the same as that configured on the ASR-3000.
5. Double click the *Instrument 0* icon.

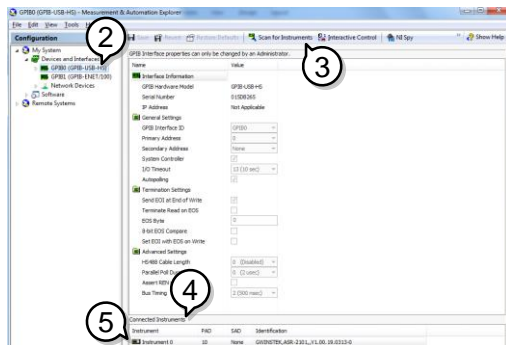

6. Click on *Communicate with Instrument*.
7. Under the Communicator tab, ensure **IDN?* is written in the *Send String* text box.
8. Click on the *Query* button to send the **IDN?* query to the instrument.
9. The instrument identification string will be returned to the buffer area:
 GW-INSTEK,ASR-XXXX,GXXXXXXXXX,XX.XX
 (manufacturer, model, serial number, software version)

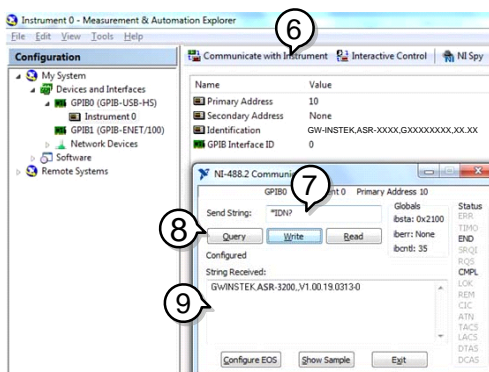

10. The function check is complete.

Web Server Remote Control Function Check

Functionality
Check

Enter the IP address of the power supply (for example: http:// XXX.XXX.XXX.XXX) in a web browser after the instrument has been configured for LAN (page 21).

The web interface allows you to:

- View the system and information and the network configuration.
- View the analog control pinout.
- View the dimensions of the unit.
- View the operating area

Example:



[Visit Our Site](#)

[Support](#) | [Contact Us](#)

<p>Welcome Page</p> <p>Network Configuration</p> <p>Analog Control</p> <p>Figure of Dimensions</p> <p>Operating Area</p>	<p>Network Configuration</p> <p>IP Address : 192.168.0.145</p> <p>Subnet Mask : 255.255.255.0</p> <p>Gateway : 192.168.0.1</p> <p>DNS : 172.16.1.252</p> <p>DHCP State : <input type="radio"/> ON <input checked="" type="radio"/> OFF</p> <p>Password : <input type="password"/></p> <p><input type="button" value="Submit"/></p>
---	---

Socket Server Function Check

Background To test the socket server functionality, National Instruments Measurement and Automation Explorer can be used. This program is available on the NI website, www.ni.com, via a search for the VISA Run-time Engine page, or “downloads” at the following URL, <http://www.ni.com/visa/>

Requirements Operating System: Windows XP, 7, 8, 10

Functionality Check

1. Start the NI Measurement and Automation Explorer (MAX) program. Using Windows, press:

Start>All Programs>NI MAX

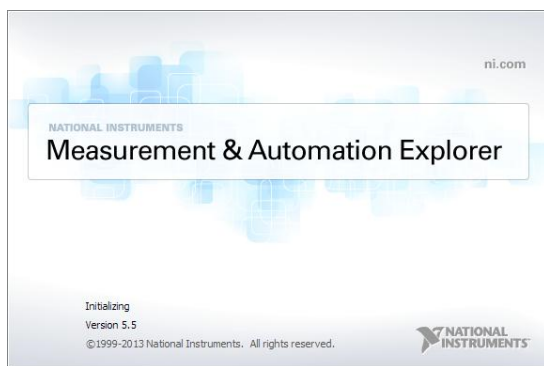

2. From the Configuration panel access;

My System>Devices and Interfaces>Network Devices

3. Press *Add New Network Device>Visa TCP/IP Resource...*

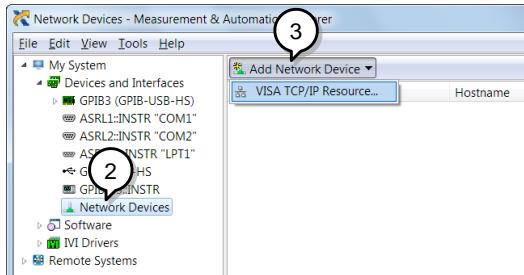

4. Select *Manual Entry of Raw Socket* from the popup window.

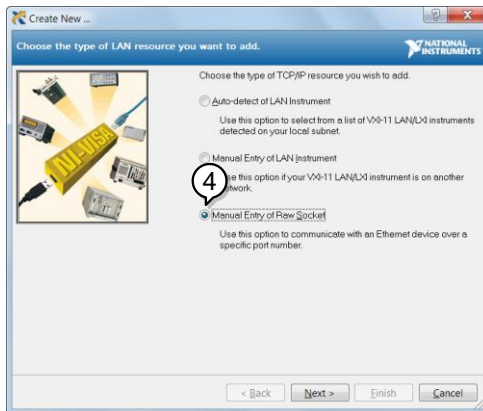

5. Enter the IP address and the port number of the ASR-3000. The port number is fixed at 2268.
6. Double click the Validate button and press *Next*.

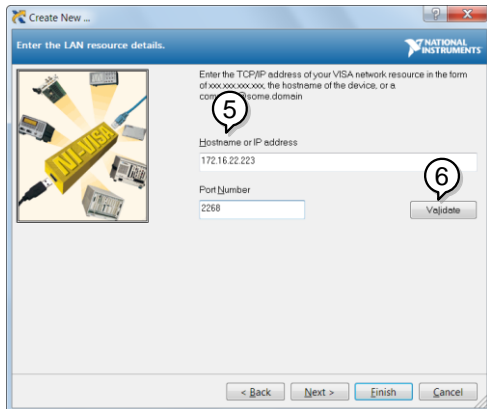

7. Next configure the Alias (name) of the ASR-3000 connection. In this example the Alias is: ASR
8. Click finish.

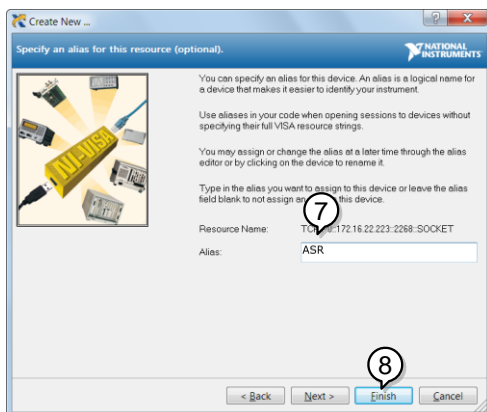

9. The IP address of the power supply will now appear under Network Devices in the configuration panel. Select this icon now.
10. Press *Open VISA Test Panel*.

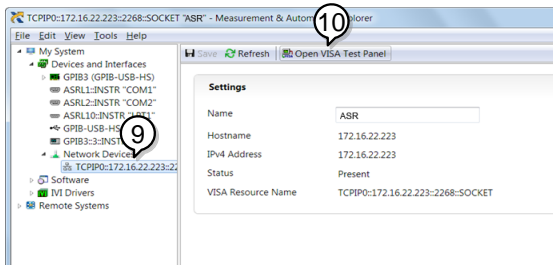

11. Click the *Configuration* Icon. Under the *IO Settings* tab check *Enable Termination Character*. The termination character should be set as *Line Feed - \n*.

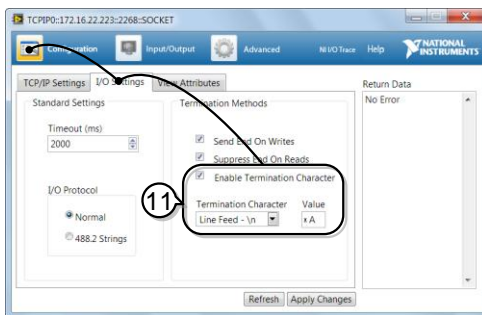

12. Click the *Input/Output* icon. Under the *Basic I/O* tab, make sure **IDN? \n* is entered in the *Select or Enter Command* drop box.
13. Click *Query*.

The ASR-3000 will return the machine identification string into the buffer area:

GW-INSTEK,ASR-XXXX,GXXXXXXXXX,XX.XX

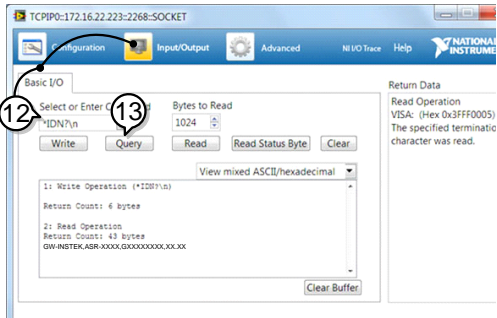

For further details, please see the programming manual, available on the GW Instek web site @ www.gwinstek.com.

Command Syntax

Compatible Standard	IEEE488.2	Partial compatibility
	SCPI, 1999	Partial compatibility

Command Structure

SCPI commands follow a tree-like structure, organized into nodes. Each level of the command tree is a node. Each keyword in a SCPI command represents each node in the command tree. Each keyword (node) of a SCPI command is separated by a colon (:).

For example, the diagram below shows an SCPI sub-structure and a command example.

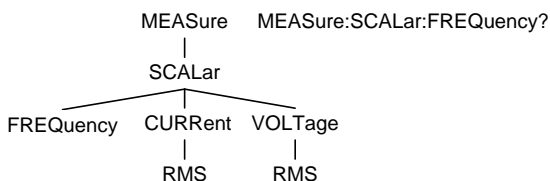

Command types

There are a number of different instrument commands and queries. A command sends instructions or data to the unit and a query receives data or status information from the unit.

Command types

Simple A single command with/without a parameter

Example *IDN?

Query	A query is a simple or compound command followed by a question mark (?). A parameter (data) is returned.
-------	--

Example	meas:curr?
---------	------------

Compound	Two or more commands on the same command line. Compound commands are separated with either a semi-colon (;) or a semi-colon and a colon (;:).
----------	---

A semi-colon is used to join two related commands, with the caveat that the last command must begin at the last node of the first command.

Example	meas:volt?;curr?
---------	------------------

A semi-colon and colon are used to combine two commands from different nodes.

Example	meas:volt?::sour:volt?
---------	------------------------



Note
(Further
explanation)

A semi-colon(;) is used to connect two commands. A colon(:) at the start of a command indicates that the command starts from the root node. The first command can ignore that first colon. Any commands after the first command (for compound commands) that do not begin with a colon, must begin at the last node of the first command.

Command Forms Commands and queries have two different forms, long and short. The command syntax is written with the short form of the command in capitals and the remainder (long form) in lower case.

The commands can be written in capitals or lower-case, just so long as the short or long forms are complete. An incomplete command will not be recognized.

Below are examples of correctly written commands.

Long form	:SYSTem:ERRor? :SYSTEM:ERROR? :system:error?
Short form	SYST:ERR? syst:err?

Square Brackets Commands that contain square brackets indicate that the contents are optional. The function of the command is the same with or without the square bracketed items, as shown below.

For example the query “:OUTPut[:STATe]?” has two valid forms, “:OUTPut:STATe?” and “:OUTPut?”.

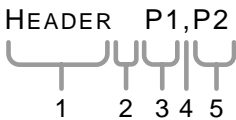
Command Format		<ol style="list-style-type: none"> 1. Command header 2. Space 3. Parameter 1 4. Comma (no space before/after comma) 5. Parameter 2
-----------------------	---	---

Parameters	Type	Description	Example
	<Boolean>	Boolean logic	0, 1
	<NR1>	integers	0, 1, 2, 3
	<NR2>	decimal numbers	0.1, 3.14, 8.5
	<NR3>	floating point	4.5e-1, 8.25e+1
	<NRf>	any of NR1, 2, 3	1, 1.5, 4.5e-1
	<block data>	Definitive length arbitrary block data. A single decimal digit followed by data. The decimal digit specifies how many 8-bit data bytes follow.	

Message Terminator	LF	Line feed code	
--------------------	----	----------------	--

Command List

Common	*CLS.....	51
Commands	*ESE.....	51
	*ESR.....	52
	*IDN.....	52
	*OPC.....	52
	*RCL.....	53
	*RST.....	53
	*SAV.....	53
	*SRE.....	54
	*STB.....	54
	*WAI.....	54
Data/Trace	:DATA TRACe:SEQuence:CLEar.....	55
Commands	:DATA TRACe:SEQuence:RECall.....	55
	:DATA TRACe:SEQuence:STORe.....	56
	:DATA TRACe:SIMulation:CLEar.....	56
	:DATA TRACe:SIMulation:RECall.....	56
	:DATA TRACe:SIMulation:STORe.....	57
	:DATA TRACe:WAVe:CLEar.....	57
	:DATA TRACe:WAVe[:DATA].....	58
Measure	:MEASure[:SCALar]:CURRent:CFACtor.....	60
Commands	:MEASure[:SCALar]:CURRent:HIGH.....	60
	:MEASure[:SCALar]:CURRent:LOW.....	60
	:MEASure[:SCALar]:CURRent:PEAK:CLEar.....	60
	:MEASure[:SCALar]:CURRent:PEAK:HOLD.....	60
	:MEASure[:SCALar]:CURRent[:RMS].....	61
	:MEASure[:SCALar]:CURRent:AVERAge.....	61
	:MEASure[:SCALar]:CURRent:HARMonic[
	:RMS].....	61
	:MEASure[:SCALar]:CURRent:HARMonic	
	:RATio.....	61
	:MEASure[:SCALar]:FREQuency.....	62
	:MEASure[:SCALar]:POWer[:AC]:APParent.....	62

	:MEASure[:SCALar]:POWER[:AC]:PFACtor.....	62
	:MEASure[:SCALar]:POWER[:AC]:REACTive.....	62
	:MEASure[:SCALar]:POWER[:AC][:REAL]	62
	:MEASure[:SCALar]:VOLTage[:RMS].....	63
	:MEASure[:SCALar]:VOLTage:AVERage.....	63
	:MEASure[:SCALar]:VOLTage:HIGH	63
	:MEASure[:SCALar]:VOLTage:LOW	63
	:MEASure[:SCALar]:VOLTage:HARMonic[
	:RMS].....	64
	:MEASure[:SCALar]:VOLTage:HARMonic	
	:RATio	64
	:MEASure:CONFigure:SENSing	64
Memory	:MEMory:RCL.....	65
Commands	:MEMory:SAV.....	65
Output	:OUTPut[:STATe]	66
Commands	:OUTPut:PON	66
	:OUTPut:PROtection:CLEar	67
	:OUTPut:RELay	67
Status	:STATus:OPERation:CONDition.....	68
Commands	:STATus:OPERation:ENABLE.....	68
	:STATus:OPERation[:EVENT]	69
	:STATus:OPERation:NTRansition	69
	:STATus:OPERation:PTRansition	69
	:STATus:QUESTionable[:EVENT].....	70
	:STATus:QUESTionable:CONDition	70
	:STATus:QUESTionable:ENABLE	70
	:STATus:QUESTionable:NTRansition	70
	:STATus:QUESTionable:PTRansition	71
	:STATus:PRESet.....	71
	:STATus:WARNIing:CONDition	72
	:STATus:WARNIing:ENABLE	72
	:STATus:WARNIing[:EVENT]	72
	:STATus:WARNIing:NTRansition	73
	:STATus:WARNIing:PTRansition	73

	:STATus:LOCK:CONDition.....	73
	:STATus:LOCK:ENABle	73
	:STATus:LOCK[:EVENT]	74
	:STATus:LOCK:NTRansition.....	74
	:STATus:LOCK:PTRansition.....	74
System	:SYSTem:ARBITrary:EDIT:BUILtin.....	76
Commands	:SYSTem:ARBITrary:EDIT:SURGe	76
	:SYSTem:ARBITrary:EDIT:STAir	77
	:SYSTem:ARBITrary:EDIT:CFACTOR2.....	77
	:SYSTem:ARBITrary:EDIT:CFACTOR1.....	78
	:SYSTem:ARBITrary:EDIT:CLIP	78
	:SYSTem:ARBITrary:EDIT:STORe.....	79
	:SYSTem:ARBITrary:EDIT:TRAngle.....	80
	:SYSTem:BEEPer:STATe.....	80
	:SYSTem:COMMunicate:GPIB[:SELF]	
	:ADDReSS	81
	:SYSTem:COMMunicate:LAN:DHCP	81
	:SYSTem:COMMunicate:LAN:DNS	81
	:SYSTem:COMMunicate:LAN:GATeway	82
	:SYSTem:COMMunicate:LAN:IPADdress.....	82
	:SYSTem:COMMunicate:LAN:MAC	82
	:SYSTem:COMMunicate:LAN:SMASk.....	83
	:SYSTem:COMMunicate:RLSState.....	83
	:SYSTem:COMMunicate:SERial[:RECeive]	
	:TRANsmIT:BAUD.....	84
	:SYSTem:COMMunicate:SERial[:RECeive]	
	:TRANsmIT:BITS	84
	:SYSTem:COMMunicate:SERial[:RECeive]	
	:TRANsmIT:PARity	85
	:SYSTem:COMMunicate:SERial[:RECeive]	
	:TRANsmIT:SBITS.....	86
	:SYSTem:COMMunicate:TCPIp:CONTRol	86
	:SYSTem:COMMunicate:USB:FRONT:STATe.....	86
	:SYSTem:COMMunicate:USB:REAR:STATe	87
	:SYSTem:CONFigure[:MODE]	87
	:SYSTem:CONFigure:EXTio[:STATe].....	87
	:SYSTem:ERRor	88
	:SYSTem:ERRor:ENABle	88

	:SYSTem:HOLD:STATe	88
	:SYSTem:IPKHold:TIME	88
	:SYSTem:KLOCK	89
	:SYSTem:REBoot.....	89
	:SYSTem:SLEW:MODE.....	89
	:SYSTem:VUNit	90
Source	[:SOURce]:CURRent:LIMit:PEAK:HIGH.....	91
Commands	[:SOURce]:CURRent:LIMit:PEAK:LOW	92
	[:SOURce]:CURRent:LIMit:RMS[:AMPLitude]..	92
	[:SOURce]:CURRent:LIMit:PEAK:MODE	93
	[:SOURce]:CURRent:LIMit:RMS:MODE.....	93
	[:SOURce]:FREQuency:LIMit:HIGH	94
	[:SOURce]:FREQuency:LIMit:LOW	94
	[:SOURce]:FREQuency[:IMMEDIATE]	95
	[:SOURce]:FUNction[:SHAPE][:IMMEDIATE]	95
	[:SOURce]:FUNction:THD:FORMat	96
	[:SOURce]:MODE.....	96
	[:SOURce]:PHASe:STARt:STATe	97
	[:SOURce]:PHASe:STOP:STATe.....	98
	[:SOURce]:PHASe:STARt[:IMMEDIATE]	98
	[:SOURce]:PHASe:STOP[:IMMEDIATE]	99
	[:SOURce]:READ	99
	[:SOURce]:VOLTage:RANGe	100
	[:SOURce]:VOLTage:LIMit:RMS.....	100
	[:SOURce]:VOLTage:LIMit:PEAK.....	101
	[:SOURce]:VOLTage:LIMit:HIGH	101
	[:SOURce]:VOLTage:LIMit:LOW	102
	[:SOURce]:VOLTage[:LEVel][:IMMEDIATE]	
	[:AMPLitude]	102
	[:SOURce]:VOLTage[:LEVel][:IMMEDIATE]	
	:OFFSet.....	103
Sequence	[:SOURce]:SEQUence:CPARAmeter	104
Commands	[:SOURce]:SEQUence:CSTep.....	105
	[:SOURce]:SEQUence:SPARAmeter	105
	[:SOURce]:SEQUence:STEP	106
	[:SOURce]:SEQUence:CONDition	107

	:TRIGger:SEquence:SElected:EXECute	107
Simulate	[.:SOURce]:SIMulation:CONDition	109
Commands	[.:SOURce]:SIMulation:ABNormal:CODE	109
	[.:SOURce]:SIMulation:ABNormal:FREQuency	110
	[.:SOURce]:SIMulation:ABNormal:PHASe	
	:STARt:ENABle	110
	[.:SOURce]:SIMulation:ABNormal:PHASe	
	:STARt[:IMMediate]	111
	[.:SOURce]:SIMulation:ABNormal:PHASe	
	:STOP:ENABle	111
	[.:SOURce]:SIMulation:ABNormal:PHASe	
	:STOP[:IMMediate]	112
	[.:SOURce]:SIMulation:ABNormal:TIME.....	112
	[.:SOURce]:SIMulation:ABNormal:VOLTage....	113
	[.:SOURce]:SIMulation:CSTep	113
	[.:SOURce]:SIMulation:INITial:CODE.....	114
	[.:SOURce]:SIMulation:INITial:FREQuency	114
	[.:SOURce]:SIMulation:INITial:PHASe:STARt	
	:ENABle	115
	[.:SOURce]:SIMulation:INITial:PHASe:STARt[
	:IMMediate].....	115
	[.:SOURce]:SIMulation:INITial:PHASe:STOP	
	:ENABle	116
	[.:SOURce]:SIMulation:INITial:PHASe:STOP[
	:IMMediate].....	116
	[.:SOURce]:SIMulation:INITial:VOLTage	117
	[.:SOURce]:SIMulation:NORMal<1 2>:CODE	117
	[.:SOURce]:SIMulation:NORMal 1:FREQuency	118
	[.:SOURce]:SIMulation:NORMal<1 2>	
	:PHASe:STARt:ENABle	118
	[.:SOURce]:SIMulation:NORMal<1 2>	
	:PHASe:STARt[:IMMediate]	119
	[.:SOURce]:SIMulation:NORMal<1 2>	
	:PHASe:STOP:ENABle.....	119
	[.:SOURce]:SIMulation:NORMal<1 2>	
	:PHASe:STOP[:IMMediate].....	120
	[.:SOURce]:SIMulation:NORMal<1 2>:TIME...	120
	[.:SOURce]:SIMulation:NORMal 1:VOLTage....	121
	[.:SOURce]:SIMulation:REPeat:COUNt	121

	[:SOURce]:SIMulation:REPeat:ENABle.....	122
	[:SOURce]:SIMulation:TRANsition<1 2>:TIME122	
	[:SOURce]:SIMulation:TRANsition<1 2>	
	:CODE	123
	:TRIGger:SIMulation:SELeCted:EXECute.....	123
Input Commands	:INPut:GAIN	124
	:INPut:SYNC:SOURce	124
Display	:DISPlay[:WINDow]:DESIgn:MODE.....	125
Commands	:DISPlay[:WINDow]:MEASure	
	:SOURce<1 2 3>	125

Common Commands

*CLS.....	51
*ESE.....	51
*ESR.....	52
*IDN.....	52
*OPC.....	52
*RCL.....	53
*RST.....	53
*SAV.....	53
*SRE.....	54
*STB.....	54
*WAI.....	54

*CLS



Description The *CLS command clears all the event registers, including the status byte, event status and error queue.

Syntax *CLS

*ESE

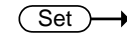

Description Sets or queries the Standard Event Status Enable register.

Syntax *ESE <NR1>

Query Syntax *ESE?

Parameter <NR1> 0~255

Return parameter <NR1> Returns the bit sum of the Standard Event Status Enable register.

***ESR** → Query

Description Queries the Standard Event Status (Event) register. The Event Status register is cleared after it is read.

Query Syntax *ESR?

Return parameter <NR1> Returns the bit sum of the Standard Event Status (Event) register and clears the register.

***IDN** → Query

Description Queries the manufacturer, model name, serial number, and firmware version of the ASR.

Query Syntax *IDN?

Return parameter <string> Returns the instrument identification as a string in the following format:
 GW-INSTEK,ASR-XXXX,GXXXXXXXXX,XX.XX
 Manufacturer: GW-INSTEK
 Model number : ASR-XXXX
 Serial number : GXXXXXXXXX
 Firmware version : XX.XX

***OPC** → Query

Description The *OPC? Query returns 1 when all the outstanding commands have completed.

Query Syntax *OPC?

Return parameter 1 Returns 1 when all the outstanding commands have completed.

***RCL**

Set →

Description	Recalls the contents stored in memory slot M0 ~ M9. These memory slots are mapped to the preset settings.	
Syntax	*RCL {<NR1> MINimum MAXimum}	
Parameter	<NR1>	0 ~ 9 (as memory M0 ~ M9)
	MIN	Recalls the M0 memory contents.
	MAX	Recalls the M9 memory contents.

***RST**

Set →

Description	Performs a device reset. Configures the unit to a known configuration (default settings). This known configuration is independent of the usage history.	
Syntax	*RST	

***SAV**

Set →

Description	Saves the settings into memory slot M0 ~ M9. These memory slots are mapped to the preset settings.	
Syntax	*SAV {<NR1> MINimum MAXimum}	
Return parameter	<NR1>	0 ~ 9 (as memory M0 ~ M9)
	MIN	Saves to the M0 memory slot.
	MAX	Saves to the M9 memory slot.

***SRE**

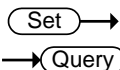

Description Sets or queries the Service Request Enable register. The Service Request Enable register determines which registers of the Status Byte register are able to generate service requests.

Syntax *SRE <NR1>

Query Syntax *SRE?

Parameter <NR1> 0~255

Return parameter <NR1> Returns the bit sum of the Service Request Enable register.

***STB**



Description Queries the bit sum of the Status Byte register with MSS (Master summary Status) replacing the RQS bit (bit 6).

Query Syntax *STB?

Return parameter <NR1> Returns the bit sum of the Status Byte register with the MSS bit (bit 6).

***WAI**



Description Prevents any other commands or queries from being executed until all outstanding commands have completed.

Syntax *WAI

Trace/Data Commands



Note

The TRACE and DATA node for the following commands are functionally equivalent.

:DATA TRACe:SEQUence:CLEar.....	55
:DATA TRACe:SEQUence:RECall.....	55
:DATA TRACe:SEQUence:STORE.....	56
:DATA TRACe:SIMulation:CLEar.....	56
:DATA TRACe:SIMulation:RECall.....	56
:DATA TRACe:SIMulation:STORE.....	57
:DATA TRACe:WAVE:CLEar.....	57
:DATA TRACe:WAVE[:DATA].....	58

:DATA|TRACe:SEQUence:CLEar



Description Clears the sequence data for the selected save memory (Seq0 ~ Seq9).

Syntax :DATA|TRACe:SEQUence:CLEar
{<NR1>|MINimum|MAXimum}

Parameter	<NR1>	0~9
	MIN	0
	MAX	9

Example :DATA:SEQ:CLE 1
Clears the sequence data from Seq1.

:DATA|TRACe:SEQUence:RECall



Description Loads the sequence data. This command is the equivalent to recalling a sequence memory in the Sequence mode.

Syntax :DATA|TRACe:SEQUence:RECall
{<NR1>|MINimum|MAXimum}

Parameter	<NR1>	0~9 (Seq0 ~ Seq9).
	MIN	0

MAX 9

Example :DATA:SEQ:REC 1
Loads the data from Seq1.

:DATA|TRACe:SEQuence:STORe (Set) →

Description Saves the sequence data. This command is the equivalent to saving a sequence memory in Sequence mode.

Syntax :DATA|TRACe:SEQuence:STORe
{<NR1>|MINimum|MAXimum}

Parameter <NR1> 0~9 (Seq0 ~ Seq9).
MIN 0
MAX 9

Example :DATA:SEQ:STOR 1
Saves the data from Seq1.

:DATA|TRACe:SIMulation:CLEar (Set) →

Description Clears the simulation data for the selected save memory (SIM0 ~ SIM9).

Syntax :DATA|TRACe:SIMulation:CLEar
{<NR1>|MINimum|MAXimum}

Parameter <NR1> 0~9 (SIM0 ~ SIM9).
MIN 0
MAX 9

Example :DATA:SIM:CLE 1
Clears the simulation data from SIM1.

:DATA|TRACe:SIMulation:RECall (Set) →

Description Loads the simulation data. This command is the equivalent to recalling a simulation memory in the Simulation mode (SIM0~SIM9).

Syntax	:DATA TRACe:SIMulation:RECall {<NR1> MINimum MAXimum}
Parameter	<NR1> 0~9 (SIM0 ~ SIM9). MIN 0 MAX 9
Example	:DATA:SIM:REC 1 Loads the data from SIM1.

:DATA|TRACe:SIMulation:STORE Set →

Description	Saves the simulation data. This command is the equivalent saving a simulation memory in Simulation mode (SIM0 ~ SIM9).
Syntax	:DATA TRACe:SIMulation:STORE {<NR1> MINimum MAXimum}
Parameter	<NR1> 0~9 (SIM0 ~ SIM9). MIN 0 MAX 9
Example	:DATA:SIM:STOR 1 Saves the data from SIM1.

:DATA|TRACe:WAVE:CLEAr Set →

Description	Clears the ARB 1-16 data for the selected wave group.
Syntax	:DATA TRACe:WAVE:CLEAr {<NR1> MINimum MAXimum}
Parameter	<NR1> 1~16 (ARB1 ~ ARB16). MIN 1 (ARB1) MAX 16 (ARB16)
Example	:DATA:WAV:CLE 13 Clears the wave data from ARB13.

:DATA|TRACe:WAVe[:DATA]

Set →

Description	Sets the arbitrary wave.	
Syntax	:DATA TRACe:WAVe[:DATA] {<NR1> <Binary Data>}	
Parameter	<NR1>	1 - 16 (ARB 1 - 16)
	Binary Data	includes the #48192<DAB>...<DAB>
	#	Indicates the block data is sent.
	4	Indicates the number of subsequent numbers.
	8192	Indicates the number of subsequent byte data.
	<DAB>..	Indicates 16-bit with 4096 words waveform data. Plus, the data format of wave is the big endian in the form of two's complement.
	.<DAB>	
Example	TRAC:WAV 1, #48192<DAB>...<DAB>	

Measure Commands

:MEASure[:SCALar]:CURRent:CFACtor	60
:MEASure[:SCALar]:CURRent:HIGH	60
:MEASure[:SCALar]:CURRent:LOW	60
:MEASure[:SCALar]:CURRent:PEAK:CLEar	60
:MEASure[:SCALar]:CURRent:PEAK:HOLD	60
:MEASure[:SCALar]:CURRent[:RMS]	61
:MEASure[:SCALar]:CURRent:AVERAge	61
:MEASure[:SCALar]:CURRent:HARMonic[:RMS]	61
:MEASure[:SCALar]:CURRent:HARMonic :RATio	61
:MEASure[:SCALar]:FREQuency	62
:MEASure[:SCALar]:POWer[:AC]:APParent	62
:MEASure[:SCALar]:POWer[:AC]:PFACtor	62
:MEASure[:SCALar]:POWer[:AC]:REACTive	62
:MEASure[:SCALar]:POWer[:AC][:REAL]	62
:MEASure[:SCALar]:VOLTage[:RMS]	63
:MEASure[:SCALar]:VOLTage:AVERAge	63
:MEASure[:SCALar]:VOLTage:HIGH	63
:MEASure[:SCALar]:VOLTage:LOW	63
:MEASure[:SCALar]:VOLTage:HARMonic[:RMS]	64
:MEASure[:SCALar]:VOLTage:HARMonic :RATio	64
:MEASure:CONFiGure:SENSing	64

:MEASure[:SCALar]:CURRent:CFACtor → Query

Description Returns the output current crest factor (CF).

Query syntax :MEASure[:SCALar]:CURRent:CFACtor?

Return parameter <NR2> Returns the crest factor.

:MEASure[:SCALar]:CURRent:HIGH → Query

Description Returns the output current maximum peak value (Imax).

Note: Current maximum peak value is defined as the highest peak value in the complete period.

Query syntax :MEASure[:SCALar]:CURRent:HIGH?

Return parameter <NR2> Returns the Imax value in amps.

:MEASure[:SCALar]:CURRent:LOW → Query

Description Returns the output current minimum value (Imin).

Note: Current minimum value is defined as the lowest value in the complete period.

Query syntax :MEASure[:SCALar]:CURRent:LOW?

Return parameter <NR2> Returns the Imin value in amps.

:MEASure[:SCALar]:CURRent:PEAK:CLEar Set →

Description Clears the current peak-hold value.

Syntax :MEASure[:SCALar]:CURRent:PEAK:CLEar

:MEASure[:SCALar]:CURRent:PEAK:HOLD → Query

Description Returns the current peak hold value in amps (IPK Hold).

Query syntax :MEASure[:SCALar]:CURRent:PEAK:HOLD?

Return <NR2> Returns the peak hold value in amps.

:MEASure[:SCALar]:CURRent[:RMS] → Query

Description Returns the output current (Irms).

Query syntax :MEASure[:SCALar]:CURRent[:RMS]?

Return <NR2> Returns the current value in Irms.

:MEASure[:SCALar]:CURRent:AVERage → Query

Description Returns the current average value (Iavg).

Query syntax :MEASure[:SCALar]:CURRent:AVERage?

Return <NR2> Returns the current average value in amps.

:MEASure[:SCALar]:CURRent:HARMonic[:RMS] → Query

Description Returns 41 values covering Total and order 1 to 40 current (Irms) in harmonic. (Only AC-INT and 50 /60 Hz Active)

Query syntax :MEASure[:SCALar]:CURRent:HARMonic[:RMS]?

Return <NR2>,<NR2 >,<NR2>,<NR2>..., etc. Returns the entire 41 values containing Total and order 1 to 40 current (Irms) in harmonic.

:MEASure[:SCALar]:CURRent:HARMonic:RATio → Query

Description Returns 41 values covering Total and order 1 to 40 current (Ratio) in harmonic. (Only AC-INT and 50 /60 Hz Active)

Query syntax :MEASure[:SCALar]:CURRent:HARMonic:RATio?

Return <NR2>,<NR2 >,<NR2>,<NR2>..., etc. Returns the entire 41 values containing Total and order 1 to 40 current (Ratio) in harmonic.

:MEASure[:SCALar]:FREQUency → Query

Description Returns the SYNC signal source frequency in Hz.
(Only AC+DC-sync or AC-sync Active)

Query syntax :MEASure[:SCALar]:FREQUency?

Return <NR2> Returns the SYNC frequency in Hz.

:MEASure[:SCALar]:POWER[:AC]:APParent → Query

Description Returns the apparent power (S).

Query syntax :MEASure[:SCALar]:POWER[:AC]:APParent?

Return <NR2> Returns the apparent power in VA.

:MEASure[:SCALar]:POWER[:AC]:PFACTOR → Query

Description Returns the power factor (PF).

Query syntax :MEASure[:SCALar]:POWER[:AC]:PFACTOR?

Return <NR2> Returns the power factor.

:MEASure[:SCALar]:POWER[:AC]:REACTIVE → Query

Description Returns the reactive power (Q).

Query syntax :MEASure[:SCALar]:POWER[:AC]:REACTIVE?

Return <NR2> Returns the reactive power in VAR.

:MEASure[:SCALar]:POWER[:AC][:REAL] → Query

Description Returns the active power in Watts (P).

Query syntax :MEASure[:SCALar]:POWER[:AC][:REAL]?

Return <NR2> Returns the power in Watts.

:MEASure[:SCALar]:VOLTage[:RMS] → Query

Description	Returns the voltage (Vrms).
Query syntax	:MEASure[:SCALar]:VOLTage[:RMS]?
Return	<NR2> Returns the voltage value in Vrms.

:MEASure[:SCALar]:VOLTage:AVERage → Query

Description	Returns the voltage average value (Vavg).
Query syntax	:MEASure[:SCALar]:VOLTage:AVERage?
Return	<NR2> Returns the voltage average value in volts.

:MEASure[:SCALar]:VOLTage:HIGh → Query

Description	Returns the output voltage maximum peak value (Vmax).
Note:	Voltage maximum peak value is defined as the highest peak value in the complete period.
Query syntax	:MEASure[:SCALar]:VOLTage:HIGh?
Return parameter	<NR2> Returns the Vmax value in volts.

:MEASure[:SCALar]:VOLTage:LOW → Query

Description	Returns the output current minimum value (Vmin).
Note:	Voltage minimum value is defined as the lowest value in the complete period.
Query syntax	:MEASure[:SCALar]:VOLTage:LOW?
Return parameter	<NR2> Returns the Vmin value in volts.

:MEASure[:SCALar]: VOLTage:HARMonic[:RMS] → Query

Description Returns 41 values covering Total and order 1 to 40 voltage (Vrms) in harmonic. (Only AC-INT and 50 /60 Hz Active)

Query syntax :MEASure[:SCALar]: VOLTage:HARMonic[:RMS]?

Return <NR2>,<NR2 >,<NR2>, <NR2>..., etc. Returns the entire 41 values containing Total and order 1 to 40 voltage (Vrms) in harmonic.

:MEASure[:SCALar]: VOLTage:HARMonic:RATio → Query

Description Returns 41 values covering Total and order 1 to 40 voltage (Ratio) in harmonic. (Only AC-INT and 50 /60 Hz Active)

Query syntax :MEASure[:SCALar]: VOLTage:HARMonic:RATio?

Return <NR2>,<NR2 >,<NR2>, <NR2>..., etc. Returns the entire 41 values containing Total and order 1 to 40 voltage (Ratio) in harmonic.

Set →

:MEASure:CONFigure:SENSing → Query

Description Sets or queries the remote sense configuration. (Only AC-INT, DC-INT, AC-SYNC Mode and 100V, 200V Range and SIN Wave Shape and Time Slew Rate Mode Active)

Syntax :MEASure:CONFigure:SENSing {<bool>|OFF|ON}

Query Syntax :MEASure:CONFigure:SENSing?

Parameter OFF | 0 Turns the remote sense off.
ON | 1 Turns the remote sense on.

Return parameter <bool> Returns the status of remote sense.

Example :MEAS:CONF:SENS 0
Sets the remote sense off.

Memory Commands

:MEMory:RCL.....	65
:MEMory:SAV.....	65

:MEMory:RCL

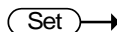

Description Recalls the settings from memory slot M0~M9. These memory slots are mapped to the preset settings. Equivalent to the *RCL command.

Syntax :MEMory:RCL {<NR1>|MINimum|MAXimum}

Parameter	<NR1>	0~9
	MINimum	0
	MAXimum	9

Example :MEMory:RCL
Recall the settings from M1.

:MEMory:SAV



Description Saves the settings into memory slot M0 ~ M9. These memory slots are mapped to the preset settings. Equivalent to the *SAV command.

Syntax :MEMory:SAV {<NR1>|MINimum|MAXimum}

Parameter	<NR1>	0~9
	MINimum	0
	MAXimum	9

Example :MEMory:SAV 1
Save the settings to M1.

Output Commands

:OUTPut[:STATe]	66
:OUTPut:PON	66
:OUTPut:PROtection:CLEar	67
:OUTPut:RELAy	67

:OUTPut[:STATe]

Set →

→ Query

Description	Sets or queries the output state of power source.	
Syntax	:OUTPut[:STATe] {<bool> OFF ON}	
Query Syntax	:OUTPut[:STATe]?	
Parameter	OFF 0	Turns the output off.
	ON 1	Turns the output on.
Return parameter	<bool>	Returns output status of the instrument.
Example	:OUTP 0 Sets power output off.	

Set →

→ Query

:OUTPut:PON

Description	Sets the output state at power-on.	
Syntax	:OUTPut:PON {<NR1> OFF ON SEQ SIM}	
Return Syntax	:OUTPut:PON?	
Parameter	<NR1>	0 ~ 3
	OFF 0	Disabled
	ON 1	Enabled
	SEQ 2	Sequence function
	SIM 3	Simulate function
Return parameter	<NR1>	Returns the selected output state at power-on from 0 to 3.
Example	:OUTPut:PON 2 Sets sequence function on at power-on.	

:OUTPut:PROTection:CLEar (Set) →

Description The Command will clear alarms like Over Current, Over Peak Current, Output Over-Power, Output Short, Output Overvoltage, Sensing Voltage Error.

Syntax :OUTPut:PROTection:CLEar

(Set) →

:OUTPut:RELAy → (Query)

Description Sets or queries the output relay of power source.

Syntax :OUTPut:RELAy {<bool>|OFF|ON}

Query Syntax :OUTPut:RELAy?

Parameter	OFF 0	Turns the output relay Disable.
	ON 1	Turns the output relay Enable.

Return parameter <bool> Returns output relay of the instrument.

Example :OUTP:REL 1
Sets output relay Enable.

Status Commands

:STATus:OPERation:CONDition	68
:STATus:OPERation:ENABle.....	68
:STATus:OPERation[:EVENT]	69
:STATus:OPERation:NTRansition	69
:STATus:OPERation:PTRansition	69
:STATus:QUESTionable[:EVENT].....	70
:STATus:QUESTionable:CONDition	70
:STATus:QUESTionable:ENABle	70
:STATus:QUESTionable:NTRansition	70
:STATus:QUESTionable:PTRansition.....	71
:STATus:PRESet.....	71
:STATus:WARNIng:CONDition	72
:STATus:WARNIng:ENABle	72
:STATus:WARNIng[:EVENT].....	72
:STATus:WARNIng:NTRansition	73
:STATus:WARNIng:PTRansition	73
:STATus:LOCK:CONDition.....	73
:STATus:LOCK:ENABle	73
:STATus:LOCK[:EVENT]	74
:STATus:LOCK:NTRansition.....	74
:STATus:LOCK:PTRansition.....	74

:STATus:OPERation:CONDition → Query

Description Queries the Operation Status register. This query will not clear the register.

Syntax :STATus:OPERation:CONDition?

Return <NR1> Returns the bit sum of the Operation Condition register. (0~32767)

Set →

:STATus:OPERation:ENABle → Query

Description Sets or queries the bit sum of the Operation Status Enable register.

Syntax :STATus:OPERation:ENABLE <NR1>

Query Syntax :STATus:OPERation:ENABLE?

Parameter <NR1> 0~32767

Return parameter <NR1> 0~32767

:STATus:OPERation[:EVENT] → Query

Description Queries the Operation Status Event register and clears the contents of the register.

Syntax :STATus:OPERation[:EVENT]?

Return <NR1> Returns the bit sum of the Operation Status Event register.

Set →

:STATus:OPERation:NTRansition → Query

Description Sets or queries the bit sum of the negative transition filter of the Operation Status register.

Syntax :STATus:OPERation:NTRansition <NR1>

Query Syntax :STATus:OPERation:NTRansition?

Parameter <NR1> 0~32767

Return parameter <NR1> 0~32767

Set →

:STATus:OPERation:PTRansition → Query

Description Sets or queries the bit sum of the positive transition filter of the Operation Status register.

Syntax :STATus:OPERation:PTRansition <NR1>

:STATus:OPERation:PTRansition?

Parameter <NR1> 0~32767

Return parameter <NR1> 0~32767

:STATus:QUESTionable[:EVENT] → Query

Description Queries the bit sum of the Questionable Status Event register. This query will also clear the contents of the register.

Query Syntax :STATus:QUESTionable[:EVENT]?

Return parameter <NR1> 0~32767

:STATus:QUESTionable:CONDition → Query

Description Queries the status (bit sum) of the Questionable Status register. This query will not clear the register.

Query Syntax :STATus:QUESTionable:CONDition?

Return parameter <NR1> 0~32767

:STATus:QUESTionable:ENABLE → Query

Description Sets or queries the bit sum of the Questionable Status Enable register.

Syntax :STATus:QUESTionable:ENABLE <NR1>

Query Syntax :STATus:QUESTionable:ENABLE?

Parameter <NR1> 0~32767

Return parameter <NR1> 0~32767

:STATus:QUESTionable:NTRansition → Query

Description Sets or queries the bit sum of the negative transition filter of the Questionable Status register.

Syntax :STATus:QUESTionable:NTRansition <NR1>

Query Syntax :STATus:QUESTionable:NTRansition?

Parameter <NR1> 0~32767

Return parameter <NR1> 0~32767

:STATus:QUEStionable:PTRansition (Set) →
→ (Query)

Description	Sets or queries the bit sum of the positive transition filter of the Questionable Status register.
Syntax	:STATus:QUEStionable:PTRansition <NR1>
Return Syntax	:STATus:QUEStionable:PTRansition?
Parameter	<NR1> 0~32767
Return parameter	<NR1> 0~32767

:STATus:PRESet (Set) →

Description This command resets the ENABLE register, the PTRansition filter and NTRansition filter on the Operation Status, Questionable Status, Warning Status and System Lock Status Registers. The registers/filters will be reset to a default value.

Default Register/Filter Values	Setting
QUEStionable Status Enable	0x0000
QUEStionable Status Positive Transition	0x7FFF
QUEStionable Status Negative Transition	0x0000
Operation Status Enable	0x0000
Operation Status Positive Transition	0x7FFF
Operation Status Negative Transition	0x0000
WARning Status Enable	0x0000
WARning Status Positive Transition	0x7FFF
WARning Status Negative Transition	0x0000
System Lock Status Enable	0x0000
System Lock Status Positive Transition	0x7FFF
System Lock Status Negative Transition	0x0000

Summary: The Questionable Status Enable registers, the Operation Status Enable registers, Warning Status registers and System Lock Status registers are both reset to 0.

The Questionable Status, Operation Status, Warning Status and System Lock Status Positive Transition filters are all set high (0x7FFF) and the Negative Transition filters are all set low (0x0000). I.e., only positive transitions will be recognized for the Questionable Status, Operation Status, Warning Status and System Lock Status registers.

Syntax :STATus:PRESet

:STATus:WARnIng:CONDition → Query

Description Queries the Warning Status register. This query will not clear the register.

Syntax :STATus:WARnIng:CONDition?

Return <NR1> Returns the bit sum of the Warning Condition register. (0~32767)

:STATus:WARnIng:ENABle Set →
→ Query

Description Sets or queries the bit sum of the Warning Status Enable register.

Syntax :STATus:WARnIng:ENABle <NR1>

Query Syntax :STATus:WARnIng:ENABle?

Parameter <NR1> 0~32767

Return parameter <NR1> 0~32767

:STATus:WARnIng[:EVENT] → Query

Description Queries the Warning Status Event register and clears the contents of the register.

Syntax :STATus:WARnIng[:EVENT]?

Return <NR1> Returns the bit sum of the Warning Status Event register.

:STATus:WARNing:NTRansition  

Description Sets or queries the bit sum of the negative transition filter of the Warning Status register.

Syntax :STATus:WARNing:NTRansition <NR1>

Query Syntax :STATus:WARNing:NTRansition?

Parameter <NR1> 0~32767

Return parameter <NR1> 0~32767

:STATus:WARNing:PTRansition  

Description Sets or queries the bit sum of the positive transition filter of the Warning Status register.

Syntax :STATus:WARNing:PTRansition <NR1>

:STATus:WARNing:PTRansition?

Parameter <NR1> 0~32767

Return parameter <NR1> 0~32767

:STATus:LOCK:CONDition 

Description Queries the System Lock Status register. This query will not clear the register.

Syntax :STATus:LOCK:CONDition?

Return <NR1> Returns the bit sum of the System Lock Status register. (0~32767)

:STATus:LOCK:ENABLE  

Description Sets or queries the bit sum of the System Lock Status Enable register.

Syntax :STATus:LOCK:ENABLE <NR1>

Query Syntax :STATus:LOCK:ENABLE?

Parameter	<NR1>	0~32767
Return parameter	<NR1>	0~32767

:STATus:LOCK[:EVENT] → Query

Description Queries the System Lock Status Event register and clears the contents of the register.

Syntax :STATus:LOCK [:EVENT]?

Return <NR1> Returns the bit sum of the System Lock Status Event register.

Set →

:STATus:LOCK:NTRansition → Query

Description Sets or queries the bit sum of the negative transition filter of the System Lock Status register.

Syntax :STATus:LOCK:NTRansition <NR1>

Query Syntax :STATus:LOCK:NTRansition?

Parameter <NR1> 0~32767

Return parameter <NR1> 0~32767

Set →

:STATus:LOCK:PTRansition → Query

Description Sets or queries the bit sum of the positive transition filter of the System Lock Status register.

Syntax :STATus:LOCK:PTRansition <NR1>
:STATus:LOCK:PTRansition?

Parameter <NR1> 0~32767

Return parameter <NR1> 0~32767

System Function Commands

:SYSTem:ARBITrary:EDIT:BUIlTin.....	76
:SYSTem:ARBITrary:EDIT:SURGe.....	76
:SYSTem:ARBITrary:EDIT:STAir.....	77
:SYSTem:ARBITrary:EDIT:CFACTor2.....	77
:SYSTem:ARBITrary:EDIT:CFACTor1.....	78
:SYSTem:ARBITrary:EDIT:CLIP.....	78
:SYSTem:ARBITrary:EDIT:STORe.....	79
:SYSTem:ARBITrary:EDIT:TRlAngle.....	80
:SYSTem:BEEPer:STATe.....	80
:SYSTem:COMMunicate:GPIB[:SELf]	
:ADDReSS.....	81
:SYSTem:COMMunicate:LAN:DHCP.....	81
:SYSTem:COMMunicate:LAN:DNS.....	81
:SYSTem:COMMunicate:LAN:GATeway.....	82
:SYSTem:COMMunicate:LAN:IPADdress.....	82
:SYSTem:COMMunicate:LAN:MAC.....	82
:SYSTem:COMMunicate:LAN:SMASk.....	83
:SYSTem:COMMunicate:RLSTate.....	83
:SYSTem:COMMunicate:SERial[:RECeive]	
:TRANsmit:BAUD.....	84
:SYSTem:COMMunicate:SERial[:RECeive]	
:TRANsmit:BITS.....	84
:SYSTem:COMMunicate:SERial[:RECeive]	
:TRANsmit:PARity.....	85
:SYSTem:COMMunicate:SERial[:RECeive]	
:TRANsmit:SBITs.....	86
:SYSTem:COMMunicate:TCPip:CONTRol.....	86
:SYSTem:COMMunicate:USB:FRONT:STATe.....	86
:SYSTem:COMMunicate:USB:REAR:STATe.....	87
:SYSTem:CONFigure[:MODE].....	87
:SYSTem:CONFigure:EXTio[:STATe].....	87
:SYSTem:ERRor.....	88
:SYSTem:ERRor:ENABle.....	88
:SYSTem:HOLD:STATe.....	88
:SYSTem:IPKHold:TIME.....	88
:SYSTem:KLOCK.....	89

:SYSTem:REBoot..... 89
 :SYSTem:SLEW:MODE..... 89
 :SYSTem:VUNit..... 90

:SYSTem:ARBitrary:EDIT:BUILtin

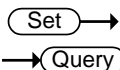

Description	Sets or queries the built in function of arbitrary edit	
Syntax	:SYSTem:ARBitrary:EDIT:BUILtin TRlangle STAir CLIP CFACtor1 CFACtor2 SURGe DST<01 22>	
Query Syntax	:SYSTem:ARBitrary:EDIT:BUILtin?	
Parameter/Return	TRlangle	Built In Triangle Wave Function
	STAir	Built In Stair Wave Function
	CLIP	Built In Clip Wave Function
	CFACtor1	Built In CF-1 Wave Function
	CFACtor2	Built In CF-2 Wave Function
	SURGe	Built In Surge Wave Function
	DST<01 22>	Built In DST01 ~ DST22 Wave Function

Example :SYST:ARB:EDIT:BUIL?
 TRI
 Returns the built in function of arbitrary edit

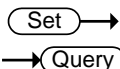

:SYSTem:ARBitrary:EDIT:SURGe

Description	Sets or queries the type and ACV and site parameter for built in Surge wave function	
Syntax	:SYSTem:ARBitrary:EDIT:SURGe <NR1> SQU SIN, <NR1> MINimum MAXimum, <NR1> MINimum MAXimum	
Query Syntax	:SYSTem:ARBitrary:EDIT:SURGe?	
Parameter<Type>	SQU 0	Square waveform type
	SIN 1	Sine waveform type
Parameter<ACV>	<NR1>	ACV Ratio : 0 ~100(0 ~ 100%)
	MINimum	Minimum ACV Ratio : 0 (0%)
	MAXimum	Maximum ACV Ratio : 100 (100%)
Parameter<Site>	<NR1>	Site Ratio : 0 ~100(0 ~ 100%)
	MINimum	Minimum Site Ratio : 0 (0%)

Return parameter	MAXimum <Type>,<ACV >,<Site>	Maximum Site Ratio : 100 (100%) Returns the type and ACV and site parameter for built in Surge wave function
------------------	------------------------------------	---

Example :SYST:ARB:EDIT:SURG?
SIN,+50,+25
Returns the type and ACV and site parameter for built in Surge wave function

:SYSTem:ARBitrary:EDIT:STAir  

Description Sets or queries the stair parameter for built in stair wave function

Syntax :SYSTem:ARBitrary:EDIT:STAir <NR1> | MINimum | MAXimu

Query Syntax :SYSTem:ARBitrary:EDIT:STAir? [MINimum | MAXimum]?

Parameter	<NR1>	stair : 1 ~ 100
	MINimum	Minimum stair : 1
	MAXimum	Maximum stair : 100

Return parameter	<NR1>	Returns the stair parameter for built in stair wave function
------------------	-------	--

Example :SYST:ARB:EDIT:STA?
+5
Returns the stair parameter for built in stair wave function

:SYSTem:ARBitrary:EDIT:CFACTor2  

Description Sets or queries the crest factor parameter for built in CF-2 wave function

Syntax :SYSTem:ARBitrary:EDIT:CFACTor2 <NR2> | MINimum | MAXimum

Query Syntax :SYSTem:ARBitrary:EDIT:CFACTor2? [MINimum | MAXimum]?

Parameter	<NR2>	crest factor : 1.5 ~ 2.0
	MINimum	Minimum crest factor : 1.5

Return parameter	MAXimum <NR2>	Maximum crest factor : 2.0 Returns the crest factor parameter for built in CF-2 wave function
------------------	------------------	--

Example :SYST:ARB:EDIT:CFAC2?
+1.5000
Returns the crest factor parameter for built in CF-2 wave function

Set →

→ Query

:SYSTem:ARBitrary:EDIT:CFACtor1

Description Sets or queries the crest factor parameter for built in CF-1 wave function

Syntax :SYSTem:ARBitrary:EDIT:CFACtor1 <NR2> | MINimum | MAXimum
Query Syntax :SYSTem:ARBitrary:EDIT:CFACtor1? [MINimum | MAXimum]?

Parameter	<NR2>	crest factor : 1.1 ~ 10.0
	MINimum	Minimum crest factor : 1.1
	MAXimum	Maximum crest factor : 10.0
Return parameter	<NR2>	Returns the crest factor parameter for built in CF-1 wave function

Example :SYST:ARB:EDIT:CFAC1?
+2.0000
Returns the crest factor parameter for built in CF-1 wave function

Set →

→ Query

:SYSTem:ARBitrary:EDIT:CLIP

Description Sets or queries the ratio parameter for built in clip wave function

Syntax :SYSTem:ARBitrary:EDIT:CLIP <NR2> | MINimum | MAXimum
Query Syntax :SYSTem:ARBitrary:EDIT:CLIP? [MINimum | MAXimum]?

Parameter	<NR2>	clip ratio : 0.00 ~ 1.00
	MINimum	Minimum clip ratio : 0.00
	MAXimum	Maximum clip ratio : 1.00

Return parameter	<code><NR2></code>	Returns the ratio parameter for built in clip wave function
------------------	--------------------------	---

Example :SYST:ARB:EDIT:CLIP?
 +0.5000
 Returns the ratio parameter for built in clip wave function

:SYSTem:ARBitrary:EDIT:STORe Set →

Description	Saves the waveform data of built in into ARB1 ~ ARB16
-------------	---

Syntax	:SYSTem:ARBitrary:EDIT:STORe <NR1> ARB1 ARB2 ARB3 ARB4 ARB5 ARB6 ARB7 ARB8 ARB9 ARB10 ARB11 ARB12 ARB13 ARB14 ARB15 ARB16
--------	---

Parameter	ARB1 0	Saves the waveform data of built in into ARB1
	ARB2 1	Saves the waveform data of built in into ARB2
	ARB3 2	Saves the waveform data of built in into ARB3
	ARB4 3	Saves the waveform data of built in into ARB4
	ARB5 4	Saves the waveform data of built in into ARB5
	ARB6 5	Saves the waveform data of built in into ARB6
	ARB7 6	Saves the waveform data of built in into ARB7
	ARB8 7	Saves the waveform data of built in into ARB8
	ARB9 8	Saves the waveform data of built in into ARB9
	ARB10 9	Saves the waveform data of built in into ARB10
	ARB11 10	Saves the waveform data of built in into ARB11
	ARB12 11	Saves the waveform data of built in into ARB12
	ARB13 12	Saves the waveform data of built in into ARB13
	ARB14 13	Saves the waveform data of built in into ARB14
	ARB15 14	Saves the waveform data of built in into ARB15
	ARB16 15	Saves the waveform data of built in into ARB16

Example :SYST:ARB:EDIT:STOR ARB1
 Saves the waveform data of built in into ARB1

Set →
 → Query

:SYSTem:ARBitrary:EDIT:TRlangle

Description	Sets or queries the symmetry parameter for built in triangle wave function	
Syntax	:SYSTem:ARBitrary:EDIT:TRlangle <NR1> MINimum	
Query Syntax	MAXimum :SYSTem:ARBitrary:EDIT:TRlangle? [MINimum MAXimum]?	
Parameter	<NR1>	Symmetry : 0 ~ 100(0 ~ 100%)
	MINimum	Minimum Symmetry : 0 (0%)
	MAXimum	Maximum Symmetry : 100 (100%)
Return parameter	<NR1>	Returns the symmetry parameter for built in triangle wave function
Example	:SYST:ARB:EDIT:TRI? +50 Returns the symmetry parameter for built in triangle wave function	

Set →
 → Query

:SYSTem:BEEPer:STATe

Description	Sets or queries the buzzer state on/off.	
Syntax	:SYSTem:BEEPer:STATe {<bool> OFF ON}	
Query Syntax	:SYSTem:BEEPer:STATe?	
Parameter	OFF 0	Turns the buzzer off.
	ON 1	Turns the buzzer on.
Return parameter	<bool>	Returns the buzzer status.

:SYSTem:COMMunicate:GPIB[:SELF] 
:ADDRess 

Description	Sets or queries the GPIB address.
Note:	The setting will only be valid after the power has been cycled.
Syntax	:SYSTem:COMMunicate:GPIB[:SELF]:ADDRess <NR1>
Query Syntax	:SYSTem:COMMunicate:GPIB[:SELF]:ADDRess?
Parameter/Return	<NR1> 0~30
Example	SYST:COMM:GPIB:ADDR 15 Sets the GPIB address to 15.

:SYSTem:COMMunicate:LAN:DHCP 

Description	Turns DHCP on/off. Queries the DHCP status.
Note:	The setting will only be valid after the power has been cycled.
Syntax	:SYSTem:COMMunicate:LAN:DHCP {<bool> OFF ON}
Query Syntax	:SYSTem:COMMunicate:LAN:DHCP?
Parameter	OFF 0 DHCP off ON 1 DHCP on
Return parameter	<bool> Returns the DHCP status.

:SYSTem:COMMunicate:LAN:DNS 

Description	Sets or queries the DNS address.
Note:	The setting will only be valid after the power has been cycled.
Syntax	:SYSTem:COMMunicate:LAN:DNS <string>
Query Syntax	:SYSTem:COMMunicate:LAN:DNS?

Parameter/Return <string> DNS in string format (“mask”)
Applicable ASCII characters: 20H to 7EH

Example SYST:COMM:LAN:DNS “172.16.1.252”
Sets the DNS to 172.16.1.252.

Set →

:SYSTem:COMMunicate:LAN:GATeway → Query

Description Sets or queries the Gateway address.

Note: The setting will only be valid after the power has been cycled.

Syntax :SYSTem:COMMunicate:LAN:GATeway <string>

Query Syntax :SYSTem:COMMunicate:LAN:GATeway?

Parameter/Return <string> Gateway address in string format (“address”)
Applicable ASCII characters: 20H to 7EH

Example SYST:COMM:LAN:GAT “172.16.0.254”
Sets the LAN gateway to 172.16.0.254.

Set →

:SYSTem:COMMunicate:LAN:IPADdress → Query

Description Sets or queries LAN IP address.

Note: The setting will only be valid after the power has been cycled.

Syntax :SYSTem:COMMunicate:LAN:IPADdress <string>

Query Syntax :SYSTem:COMMunicate:LAN:IPADdress?

Parameter/Return <string> LAN IP address in string format (“address”)
Applicable ASCII characters: 20H to 7EH

Example SYST:COMM:LAN:IPAD “172.16.5.111”
Sets the IP address to 172.16.5.111.



:SYSTem:COMMunicate:LAN:MAC → Query

Description Returns the unit MAC address as a string. The MAC address cannot be changed.

Query Syntax :SYSTem:COMMunicate:LAN:MAC?

Return parameter <string> Returns the MAC address in the following format “FF-FF-FF-FF-FF-FF”

Parameter/Return parameter	LOCAL	All keys are valid. This instrument is controlled by the front panel controls.
	REMOte	All keys are invalid, except for the [local] key and the ability to turn the output off.
	RWLock	All keys are invalid. The instrument can only be controlled remotely.
	LREMOte	All keys are valid. This instrument is controlled by the front panel controls and remotely.
Example	:SYST:COMM:RLST LOCAL Sets the operating mode to local.	

:SYSTem:COMMunicate:SERial[:RECeive] 
:TRANsmit:BAUD 

Description	Sets or queries the UART baud rate.	
Note:	The setting will only be valid after the power has been cycled.	
Syntax	:SYSTem:COMMunicate:SERial[:RECeive]:TRANsmit :BAUD <NR1>	
Query Syntax	:SYSTem:COMMunicate:SERial[:RECeive]:TRANsmit :BAUD?	
Parameter/Return	<NR1>	1200, 2400, 4800, 9600, 19200, 38400, 57600, 115200
Example	SYST:COMM:SER:TRAN:BAUD? 9600 Returns the baud rate settings.	

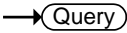
:SYSTem:COMMunicate:SERial[:RECeive] 
:TRANsmit:BITS 

Description	Sets or queries the UART number of data bits.	
Note:	The setting will only be valid after the power has been cycled.	

Syntax :SYSTem:COMMunicate:SERial[:RECeive]:TRANsmit
:BITS <NR1>

Query Syntax :SYSTem:COMMunicate:SERial[:RECeive]:TRANsmit
:BITS?

Parameter	0	7 bits
	1	8 bits

Return parameter	+0	7 bits
	+1	8 bits

Example SYST:COMM:SER:TRAN:BITS?
+1
Indicates that 8 data bits are used for the UART connection.

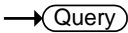
:SYSTem:COMMunicate:SERial[:RECeive] 
:TRANsmit:PARity 

Description Sets or queries the parity of the UART connection.

Note: The setting will only be valid after the power has been cycled.

Syntax :SYSTem:COMMunicate:SERial[:RECeive]:TRANsmit

Query Syntax :PARity {NONE|ODD|EVEN}
:SYSTem:COMMunicate:SERial[:RECeive]:TRANsmit
:PARity?

Parameter	NONE	No parity
	ODD	Odd parity
	EVEN	Even parity

Return parameter	+0	No parity
	+1	Odd parity
	+2	Even parity

Example SYST:COMM:SER:TRAN:PARity?
+0
Indicates that no parity is used for the UART connection.

:SYSTem:COMMunicate:SERial[:RECEive] **Set** →
:TRANsmit:SBITs → **Query**

Description Sets or queries the number of stop bits used for the UART connection.

Note: The setting will only be valid after the power has been cycled.

Syntax :SYSTem:COMMunicate:SERial[:RECEive]:TRANsmit :SBITs <NR1>

Query Syntax :SYSTem:COMMunicate:SERial[:RECEive]:TRANsmit :SBITs?

Parameter	0	1 stop bit
	1	2 stop bits

Return parameter	+0	1 stop bit
	+1	2 stop bits

Example SYST:COMM:SER:TRAN:SBITs?
 +1
 Indicates that one stop bit is used for the UART connection.

:SYSTem:COMMunicate:TCPip:CONTRol → **Query**

Description Queries the socket port number.

Query Syntax :SYSTem:COMMunicate:TCPip:CONTRol?

Return parameter <NR1> 0000 ~ 9999

Example SYST:COMM:TCP:CONT?
 2268
 Returns the socket port number.

:SYSTem:COMMunicate:USB:FRONT:STATe → **Query**

Description Queries the front panel USB-A port state.

Query Syntax :SYSTem:COMMunicate:USB:FRONT:STATe?

Return parameter	+0	<NR1>Absent
	+1	<NR1>Mass Storage

:SYSTem:COMMunicate:USB:REAR:STATe → **Query**

Description	Queries the rear panel USB-B port state.	
Query Syntax	:SYSTem:COMMunicate:USB:REAR:STATe?	
Return parameter	+0	<NR1>Absent
	+1	<NR1>Connected to the PC

Set →

:SYSTem:CONFigure[:MODE] → **Query**

Description	Sets or queries the test mode for the power supply.	
Syntax	:SYSTem:CONFigure[:MODE] {<NR1> CONTinuous SEQuence SIMulation} (SEQ is available for AC+DC-INT, AC-INT, DC-INT Modes, whilst SIM is available for AC+DC-INT Mode.)	
Query Syntax	:SYSTem:CONFigure[:MODE]?	
Parameter	CONTinuous 0	Continuous mode (normal operating mode)
	SEQuence 1	Sequence mode
	SIMulation 2	Simulation mode

Return parameter	<NR1>	
	CONT	Continuous mode (normal operating mode)
	SEQ	Sequence mode
	SIM	Simulation mode

Set →

:SYSTem:CONFigure:EXTio[:STATe] → **Query**

Description	Sets or queries the external control state on/off.	
Syntax	:SYSTem:CONFigure:EXTio[:STATe] {<bool> OFF ON}	
Query Syntax	:SYSTem:CONFigure:EXTio[:STATe]?	
Parameter	OFF 0	Turns the external control off.
	ON 1	Turns the external control on.
Return parameter	<bool>	Returns the external control status.

:SYSTem:ERRor → Query

Description Queries the error queue. The last error message is returned. A maximum of 32 errors are stored in the error queue.

Query Syntax :SYSTem:ERRor?

Return parameter <string> Returns an error code followed by an error message as a single string.

Example SYSTem:ERRor?
-100, "Command error"

:SYSTem:ERRor:ENABle Set →

Description Clears the Error Queue and enables all error messages to be placed in the System Error Queue.

Syntax :SYSTem:ERRor:ENABle

:SYSTem:HOLD:STATe Set →
→ Query

Description Sets or queries the freeze hold state on/off.

Syntax :SYSTem:HOLD:STATe {<bool>|OFF|ON}

Query Syntax :SYSTem:HOLD:STATe?

Parameter OFF | 0 Turns the freeze hold off.
ON | 1 Turns the freeze hold on.

Return parameter <bool> Returns the freeze hold status.

:SYSTem:IPKhold:TIME Set →
→ Query

Description Sets or queries the Ipeak hold time for peak current measurement when output on.

Syntax :SYSTem:IPKhold:TIME {<NR1>}

Query Syntax :SYSTem:IPKhold:TIME?

Parameter <NR1> 1~60,000

Example :SYST:IPKH:TIME 10
 Sets the Ipeak hold time 10ms to measure when output on.

Set →

:SYSTem:KLOCK

→ Query

Description Enables or disables the front panel key lock.

Syntax :SYSTem:KLOCK {<bool>|OFF|ON}

Query Syntax :SYSTem:KLOCK?

Parameter OFF | 0 Panel keys unlocked
 ON | 1 Panel keys locked

Return parameter <bool> Returns the key lock status.

:SYSTem:REBoot

Set →

Description Reboots the ASR system.

Syntax :SYSTem:REBoot

Set →

:SYSTem:SLEW:MODE

→ Query

Description Sets or queries slew mode setting.

Syntax :SYSTem:SLEW:MODE {<bool>|TIME|SLOPe}

Query Syntax :SYSTem:SLEW:MODE?

Parameter TIME | 0 Sets the Time mode.
 SLOPe | 1 Sets the Slope mode.

Return parameter <bool> Returns the slew mode setting.

Example :SYST:SLEW:MODE TIME
 Sets the Time mode for slew mode.

Set →

→ Query

:SYSTem:VUNit

Description	Sets or Queries the Unit of Voltage Setting in Specific Wave Shape(TRI or ARB)	
Syntax	:SYSTem:VUNit <bool> RMS P-P	
Query Syntax	:SYSTem:VUNit?	
Parameter	RMS 0	Sets V Unit (TRI, ARB) as rms
	P-P 1	Sets V Unit (TRI, ARB) as p-p
Return parameter	<bool>	Returns the V Unit(TRI, ARB) setting.
Example	:SYSTem:VUNit? +1 Returns the V Unit(TRI, ARB) setting.	

Source Commands

[[:SOURce]:CURRent:LIMit:PEAK:HIGH	91
[[:SOURce]:CURRent:LIMit:PEAK:LOW	92
[[:SOURce]:CURRent:LIMit:RMS[:AMPLitude]..	92
[[:SOURce]:CURRent:LIMit:PEAK:MODE.....	93
[[:SOURce]:CURRent:LIMit:RMS:MODE.....	93
[[:SOURce]:FREQuency:LIMit:HIGH	94
[[:SOURce]:FREQuency:LIMit:LOW	94
[[:SOURce]:FREQuency[:IMMEdiate]	95
[[:SOURce]:FUNctIon[:SHAPE][:IMMEdiate]	95
[[:SOURce]:FUNctIon:THD:FORMat	96
[[:SOURce]:MODE	96
[[:SOURce]:PHASe:START:STATe	97
[[:SOURce]:PHASe:STOP:STATe.....	98
[[:SOURce]:PHASe:START[:IMMEdiate]	98
[[:SOURce]:PHASe:STOP[:IMMEdiate]	99
[[:SOURce]:READ	99
[[:SOURce]:VOLTage:RANGe	100
[[:SOURce]:VOLTage:LIMit:RMS.....	100
[[:SOURce]:VOLTage:LIMit:PEAK.....	101
[[:SOURce]:VOLTage:LIMit:HIGH.....	101
[[:SOURce]:VOLTage:LIMit:LOW	102
[[:SOURce]:VOLTage[:LEVel][:IMMEdiate]	
[[:AMPLitude]	102
[[:SOURce]:VOLTage[:LEVel][:IMMEdiate]	
:OFFSet.....	103

[[:SOURce]:CURRent:LIMit:PEAK:HIGH



Description	Sets or queries the Ipk-High Limit parameter for the continuous operation mode.
Syntax	[[:SOURce]:CURRent:LIMit:PEAK:HIGH {<NR2> MINimum MAXimum}]
Query Syntax	[[:SOURce]:CURRent:LIMit:PEAK:HIGH? [MINimum MAXimum]]

Parameter	<NR2>	Ipk-High Limit in Arms.
	MINimum	Minimum settable peak current high limit
	MAXimum	Maximum settable peak current high limit

Return parameter	<NR2>	Returns the Ipk-High Limit value
------------------	-------	----------------------------------

Example CURR:LIM:PEAK:HIGH?
 +42.0000
 Returns the peak current high limit as +42.0 A.

Set →

[[:SOURce]:CURRent:LIMit:PEAK:LOW → Query

Description Sets or queries the Ipk-Low Limit parameter for the continuous operation mode.

Syntax [[:SOURce]:CURRent:LIMit:PEAK:LOW
 {<NR2>|MINimum|MAXimum}

Query Syntax [[:SOURce]:CURRent:LIMit:PEAK:LOW?
 [MINimum|MAXimum]

Parameter	<NR2>	Ipk-Low Limit in Arms.
	MINimum	Minimum settable peak current low limit
	MAXimum	Maximum settable peak current low limit

Return parameter	<NR2>	Returns the Ipk-Low Limit value
------------------	-------	---------------------------------

Example :CURR:LIM:PEAK:LOW?
 -42.0000
 Returns the peak current low limit as -42.0 A.

Set →

[[:SOURce]:CURRent:LIMit:RMS → Query
[[:AMPLitude]

Description Sets or queries the Irms parameter for the continuous operation mode.

Syntax [[:SOURce]:CURRent:LIMit:RMS[:AMPLitude]
 {<NR2>|MINimum|MAXimum}

Query Syntax [[:SOURce]:CURRent:LIMit:RMS[:AMPLitude]?
 [MINimum|MAXimum]

Parameter	<NR2>	Irms in A.
	MINimum	Minimum settable current

	MAXimum	Maximum settable current
Return parameter	<NR2>	Returns the Irms.
Example	:CURR:LIM:RMS? +10.5000 Returns the Irms setting.	

Set →
 → Query

Description	Sets or queries Ipk limit enabled or disabled.	
Syntax	[:SOURce]:CURRent:LIMit:PEAK:MODE {<bool> OFF ON}	
Query Syntax	[:SOURce]:CURRent:LIMit:PEAK:MODE?	
Parameter/ Return parameter	<bool> OFF 0 ON 1	OFF (0) ON (1) Ipk limit off Ipk limit on
Example	:CURR:LIM:PEAK:MODE ON Sets Ipk limit enabled.	

Set →
 → Query

Description	Sets or queries IRMS limit status.	
Syntax	[:SOURce]:CURRent:LIMit:RMS:MODE {<bool> OFF ON}	
Query Syntax	[:SOURce]:CURRent:LIMit:RMS:MODE?	
Parameter/ Return parameter	<bool> OFF 0 ON 1	OFF (0) ON (1) IRMS limit off IRMS limit on
Example	:CURR:LIM:RMS:MODE ON Sets IRMS limit enabled.	

Set →
 → Query

[[:SOURce]:FREQuency:LIMit:HIGH

Description	Sets or queries the frequency upper limit range. (Only AC+DC-INT or AC-INT or AC+DC-ADD or AC-ADD Active)	
Syntax	[:SOURce]:FREQuency:LIMit:HIGH {<NR2> MINimum MAXimum}	
Query Syntax	[:SOURce]:FREQuency:LIMit:HIGH? [INimum MAXimum]	
Parameter	<NR2>	Frequency in Hz.
	MINimum	Minimum settable frequency
	MAXimum	Maximum settable frequency
Return parameter	<NR2>	Returns the frequency limit
Example	FREQ:LIM:HIGH? +999.9000 Returns the frequency upper limit.	

Set →
 → Query

[[:SOURce]:FREQuency:LIMit:LOW

Description	Sets or queries the frequency lower limit range. (Only AC+DC-INT or AC-INT or AC+DC-ADD or AC-ADD Active)	
Syntax	[:SOURce]:FREQuency:LIMit:LOW {<NR2> MINimum MAXimum}	
Query Syntax	[:SOURce]:FREQuency:LIMit:LOW? [INimum MAXimum]	
Parameter	<NR2>	Frequency in Hz.
	MINimum	Minimum settable frequency
	MAXimum	Maximum settable frequency
Return parameter	<NR2>	Returns the frequency limit
Example	FREQ:LIM:LOW? +1.0000 Returns the frequency lower limit.	

Set →
 → Query

[[:SOURce]:FREQUency[:IMMediate]

Description	Sets or queries the frequency for the immediate trigger. (Only AC+DC-INT or AC-INT or AC+DC-ADD or AC-ADD Active)	
Syntax	[:SOURce]:FREQUency[:IMMediate] {<NR2>(HZ) MINimum MAXimum}	
Query Syntax	[:SOURce]:FREQUency[:IMMediate]? [MINimum MAXimum]	
Parameter/Return parameter	<NR2>	Frequency setting in Hz.
	MINimum	Minimum frequency
	MAXimum	Maximum frequency
Example	:FREQ 60 Sets the frequency of 60Hz.	

Set →
 → Query

[[:SOURce]:FUNCTion[:SHAPE][:IMMediate]

Description	Sets or queries the waveforms of power supply. (Not available for DC-INT, AC+DC-EXT and AC-EXT)	
Syntax	[:SOURce]:FUNCTion[:SHAPE][:IMMediate] {<NR1> ARB1 ARB2 ARB3 ARB4 ARB5 ARB6 ARB7 ARB8 ARB9 ARB10 ARB11 ARB12 ARB13 ARB14 ARB15 ARB16 SIN SQU TRI}	
Query Syntax	[:SOURce]:FUNCTion[:SHAPE][:IMMediate]?	
Parameter / Return parameter	<NR1>	From 0 - 18, which represent different waveforms, respectively.
	ARB1 0	Arbitrary wave 1
	ARB2 1	Arbitrary wave 2
	ARB3 2	Arbitrary wave 3
	ARB4 3	Arbitrary wave 4
	ARB5 4	Arbitrary wave 5
	ARB6 5	Arbitrary wave 6
	ARB7 6	Arbitrary wave 7
	ARB8 7	Arbitrary wave 8

ARB9	8	Arbitrary wave 9
ARB10	9	Arbitrary wave 10
ARB11	10	Arbitrary wave 11
ARB12	11	Arbitrary wave 12
ARB13	12	Arbitrary wave 13
ARB14	13	Arbitrary wave 14
ARB15	14	Arbitrary wave 15
ARB16	15	Arbitrary wave 16
SIN	16	Sin wave
SQU	17	Square wave
TRI	18	Triangle wave

Example :SOUR:FUNC:SHAP:IMM?
TRI
Returns the waveform as Triangle wave.

[[:SOURce]:FUNCTION:THD:FORMat

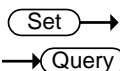

Description Sets or queries the THD format.

Syntax [[:SOURce]:FUNCTION:THD:FORMat
{<bool>|IEC|CSA}

Query Syntax [[:SOURce]:FUNCTION:THD:FORMat?

Parameter / Return parameter	<bool>	IEC (0) CSA (1)
	IEC 0	IEC THD format
	CSA 1	CSA THD format

Example :SOUR:FUNC:THD:FORM?
IEC
Returns the THD format as IEC.

[[:SOURce]:MODE

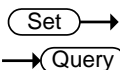

Description Sets or queries the output mode of power supply.

Syntax [[:SOURce]:MODE
{<NR1>|ACDC-INT|AC-INT|DC-INT|ACDC-EXT|AC-EXT|ACDC-ADD|AC-ADD|ACDC-SYNC|AC-SYNC}

Query Syntax	[:SOURce]:MODE?	
Parameter / Return parameter	<NR1>	From 0 – 8, which represent different output modes, respectively.
	ACDC-INT 0	AC+DC-INT
	AC-INT 1	AC-INT
	DC-INT 2	DC-INT
	ACDC-EXT 3	AC+DC-EXT
	AC-EXT 4	AC-EXT
	ACDC-ADD 5	AC+DC-ADD
	AC-ADD 6	AC-ADD
	ACDC-SYNC 7	AC+DC-SYNC
	AC-SYNC 8	AC-SYNC

Example MODE?
 ACDC-INT
 Returns the output mode as AC+DC-INT.

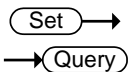

[:SOURce]:PHASe:STARt:STATe

Description	Sets or queries state of start phase. (Not available for DC-INT, AC+DC-EXT and AC-EXT)	
Syntax	[:SOURce]:PHASe:STARt:STATe {<bool> FREE FIXED}	
Query Syntax	[:SOURce]:PHASe:STARt:STATe?	
Parameter/ Return parameter	<bool>	FREE (0) FIXED (1)
	FREE 0	Start phase Free
	FIXED 1	Start phase Fixed

Example :PHAS:STAR:STAT?
 FREE
 Returns the state of start phase as Free.

[:SOURce]:PHASe:STOP:STATe



Description	Sets or queries state of stop phase. (Not available for DC-INT, AC+DC-EXT and AC-EXT)	
Syntax	[:SOURce]:PHASe:STOP:STATe {<bool> FREE FIXED}	
Query Syntax	[:SOURce]:PHASe:STOP:STATe?	
Parameter/ Return parameter	<bool> FREE 0 FIXED 1	FREE (0) FIXED (1) Start phase Free Start phase Fixed
Example	:PHAS:STOP:STAT? FIXED Returns the state of stop phase as Fixed.	

[:SOURce]:PHASe:STARt[:IMMEDIATE]

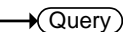
Description	Sets or queries the start phase. (Not available for DC-INT, AC+DC-EXT and AC-EXT)	
Syntax	[:SOURce]:PHASe:STARt[:IMMEDIATE] {<NR2> MINimum MAXimum}	
Query Syntax	[:SOURce]:PHASe:STARt[:IMMEDIATE]? [MINimum MAXimum]	
Parameter/Return parameter	<NR2> MINimum MAXimum	Start phase value 0° 359.9 °
Example	:PHAS:STAR 0 Sets the starting phase to 0.	

[[:SOURce]:PHASe:STOP[:IMMediate]]



Description	Sets or queries the off phase of the waveform. (Not available for DC-INT, AC+DC-EXT and AC-EXT)	
Note:	Sets the off phase of the waveform after the output has been turned off.	
Syntax	[:SOURce]:PHASe:STOP[:IMMediate] {<NR2> MINimum MAXimum}	
Query Syntax	[:SOURce]:PHASe:STOP[:IMMediate]? [MINimum MAXimum]	
Parameter/Return parameter	<NR2> MINimum MAXimum	Stop phase value 0 ° 359.9 °
Example	:PHAS:STOP 60 Sets the stop phase to 60.	

[[:SOURce]:READ] 

Description	Returns the measurement readouts.	
Query Syntax	[:SOURce]:READ?	
Return parameter	<Vrms>,<Vavg>,<Vmax>,<Vmin>,<I rms>,<lavg>,<Im ax>,<Imin>,<IpkH >,<P>,<S>,<Q>,< PF>,<CF>,<THDv >,<THDi>,<Freq>	<THDv>,<THDi> returns values in AC-INT mode only, whereas returns Invalid in other modes. <S>,<Q>,<PF>,<CF> returns Invalid in DC-INT mode. <Freq> returns values in AC+DC-Sync and AC-Sync modes only, whereas returns Invalid in other modes.
Example	:READ? >+0.3204,+0.0306,+0.1879,-0.5809,+0.0121, -0.0007, +0.0030, -0.0060, -0.0201, +0.0013, +0.0039, +0.0037, +0.3400, +1.1500, Invalid, Invalid, Invalid	

[:SOURce]:VOLTage:RANGe



Description	Sets or queries the voltage range.	
Syntax	[:SOURce]:VOLTage:RANGe {<NR1> 100 200 AUTO}	
Query Syntax	[:SOURce]:VOLTage:RANGe?	
Parameter / Return parameter	<NR1>	From 0 - 2, which represent different voltage ranges, respectively.
	100 0	100V
	200 1	200V
	AUTO 2	AUTO (Only AC+DC-INT or AC-INT or DC-INT or AC+DC-sync or AC-sync Active)
Example	:SOUR:VOLT:RANG? 200 Returns the voltage range as 200V.	

[:SOURce]:VOLTage:LIMit:RMS



Description	Sets or queries the voltage limit for the continuous operation mode. (Only AC-INT or AC-ADD or AC-Sync Active)	
Syntax	[:SOURce]:VOLTage:LIMit:RMS {<NR2> MINimum MAXimum}	
Query Syntax	[:SOURce]:VOLTage:LIMit:RMS? [MINimum MAXimum]	
Parameter	<NR2>	Vrms.
	MINimum	Minimum voltage limit
	MAXimum	Maximum voltage limit
Return parameter	<NR2>	Returns the voltage limit.
Example	VOLT:LIM:RMS? +350.0000 Returns the Vrms limit.	

[[:SOURce]:VOLTage:LIMit:PEAK



Description	Sets or Queries the Value of Vpp in Specific Mode(AC-INT or AC-ADD or AC-Sync) and Specific Wave Shape(TRI or ARB) and Specific V Unit(p-p)
Syntax	[[:SOURce]:VOLTage:LIMit:PEAK <NR2> MINimum MAXimum
Query Syntax	[[:SOURce]:VOLTage:LIMit:PEAK? [MINimum MAXimum]
Parameter	<NR2> Vpp MINimum Minimum Vpp limit MAXimum Maximum Vpp limit
Return parameter	<NR2> Returns the Vpp limit.
Example	VOLT:LIM:PEAK? +500.0000 Returns the Vpp limit.

[[:SOURce]:VOLTage:LIMit:HIGH



Description	Sets or queries the voltage high limit. (Only AC+DC-INT or DC-INT or AC+DC-ADD or AC+DC-Sync Active)
Syntax	[[:SOURce]:VOLTage:LIMit:HIGH {<NR2> MINimum MAXimum}
Query Syntax	[[:SOURce]:VOLTage:LIMit:HIGH? [MINimum MAXimum]
Parameter	<NR2> Voltage high limit MINimum Minimum voltage high limit MAXimum Maximum voltage high limit
Return parameter	<NR2> Returns the voltage high limit.
Example	VOLT:LIM:HIGH? +500.0000 Returns the voltage high limit.

`[:SOURce]:VOLTage:LIMit:LOW` (Set) →
→ (Query)

Description	Sets or queries the voltage low limit. (Only AC+DC-INT or DC-INT or AC+DC-ADD or AC+DC-Sync Active)	
Syntax	[:SOURce]:VOLTage:LIMit:LOW {<NR2> MINimum MAXimum}	
Query Syntax	[:SOURce]:VOLTage:LIMit:LOW? [MINimum MAXimum]	
Parameter	<NR2>	Voltage low limit
	MINimum	Minimum voltage low limit
	MAXimum	Maximum voltage low limit
Return parameter	<NR2>	Returns the voltage low limit.
Example	VOLT:LIM:LOW? -500.0000 Returns the voltage low limit.	

`[:SOURce]:VOLTage[:LEVel][:IMMEDIATE] [:AMPLitude]` (Set) →
→ (Query)

Description	Sets or queries the RMS voltage for the continuous operation mode. (Not available for DC-INT, AC+DC-EXT and AC-EXT)	
Syntax	[:SOURce]:VOLTage[:LEVel][:IMMEDIATE] [:AMPLitude] {<NR2>(V) MINimum MAXimum}	
Query Syntax	[:SOURce]:VOLTage[:LEVel][:IMMEDIATE] [:AMPLitude]? [MINimum MAXimum]	
Parameter/Return parameter	<NR2>	Vrms.
	MINimum	Minimum voltage
	MAXimum	Maximum voltage
Example	:VOLT 150.0 Sets the voltage to 150.0 ACV.	

[[:SOURce]:VOLTage[:LEVel]][:IMMediate]:OF Set →
 FSet → Query

Description	Sets or queries the voltage offset value. (Only AC+DC-INT or DC-INT or AC+DC-ADD or AC+DC-Sync Active)	
Syntax	[:SOURce]:VOLTage[:LEVel]][:IMMediate]:OFFSet {<NR2>(V) MINimum MAXimum}	
Query Syntax	[:SOURce]:VOLTage[:LEVel]][:IMMediate]:OFFSet? [MINimum MAXimum]	
Parameter/Return parameter	<NR2>	Voltage offset value
	MINimum	Minimum voltage offset value
	MAXimum	Maximum voltage offset value
Example	:VOLT:OFFS? +150.0000 Returns the voltage offset value as 150.0.	

Sequence Commands

[:SOURce]:SEQuence:CPARAmeter	104
[:SOURce]:SEQuence:CSTep	105
[:SOURce]:SEQuence:SPARAmeter	105
[:SOURce]:SEQuence:STEP	106
[:SOURce]:SEQuence:CONDition	107
:TRIGger:SEQuence:SELEcted:EXECute	107

[:SOURce]:SEQuence:CPARAmeter



Description	Sets the common parameters for the Sequence mode. Please see the user manual for a full description of each parameter. (Only Sequence Mode Active)	
Syntax	[:SOURce]:SEQuence:CPARAmeter {<NR2>,<NR2>,<bool> OFF ON,<NR2>,<bool> OFF ON,<NR1> CONTInue END HOLD,<NR1>,<bool> OFF ON,<NR1>,<bool> OFF ON,<NR1>,<bool> OFF ON,<NR1>,<bool> OFF ON,<NR1>,<bool> OFF ON}	
Query Syntax	[:SOURce]:SEQuence:CPARAmeter?	
Parameter	<NR2>	Step Time
	<NR2>	On phase
	<bool> OFF ON FR	On Phase settings:
	EE FIXED	on (fixed) (1) / off (free) (0)
	<NR2>	Off phase
	<bool> OFF ON FR	Off Phase settings:
	EE FIXED	on (fixed) (1) / off (free) (0)
	<NR1> CONTInue	Term settings:
	END HOLD	Continue(0)/End(1)/Hold(2)
	<NR1>	Jump step number (0 ~ 999)
	<bool> OFF ON	Jump on(1)/off(0)
	<NR1>	Jump Cnt (0~ 9999)
	<NR1>	Sync Code: LL(0) / LH(1) / HL(2) / HH(3)
	<NR1>	Branch1 (0 ~ 999)
	<bool> OFF ON	Branch1 on(1)/off(0)

	<NR1>	Branch2 (0 ~ 999)
	<bool> OFF ON	Branch2 on(1)/off(0)
	<bool>	Reserved (Fixed to 0)
Return parameter	<NR2>,<NR2>,<bool>,<NR2>,<bool>,<NR1>,<NR1>,<bool>,<NR1>,<NR1>,<bool>,<NR1>,<bool>,<bool>	
	Returns the common parameters in the following order: Step time, on phase, on phase on/off, off phase, off phase on/off, term settings, jump step number, jump on/off, jump count, code on/off, branch1, branch1 on/off, branch2, branch2 on/off, reserved on/off.	
Example1	:SEQ:CPAR 1,1,0,10,1,HOLD,10,1,0,1,0,0,0,0	
Example2	:SEQ:CPAR? +1.0000,+1.0,+0,+10.0,+1,HOLD,+10,+1,+0,+1,+0,+0,+0,+0,+0	

[[:SOURce]:SEQuence:CSTep] → Query

Description Returns the currently running step number. (Only Sequence Mode Active)

Query Syntax [[:SOURce]:SEQuence:CSTep?

Return parameter <NR1> Current step number

Example :SEQ:CSTep?
+1

[[:SOURce]:SEQuence:SPARAmeter] → Query

Description Sets or queries the parameters for a specified step. (Only Sequence Mode Active)

Syntax [[:SOURce]:SEQuence:SPARAmeter
{<NR2>,<NR1>|CONST|KEEP|SWEep,<NR2>,<NR1>|CONSt|KEEP|SWEep,<NR2>,<NR1>|CONSt|KEEP|SWEep,SIN,<NR1>}

Query Syntax [[:SOURce]:SEQuence:SPARAmeter?

Parameter <NR2> ACV setting
<NR1>|CONSt|KEEP|SWEep ACV mode: Constant(0) | Keep(1) | Sweep(2)

<code><NR2></code>	DCV. Not applicable. This parameter will be ignored.
<code><NR1> CONST KEEP SWEep</code>	DCV mode: Constant(0) Keep(1) Sweep(2)
<code><NR2></code>	Frequency
<code><NR1> CONST KEEP SWEep</code>	Frequency mode: Constant(0) Keep(1) Sweep(2)
Waveform	ARB1 ARB2 ARB3 ARB4 ARB5 ARB6 ARB7 ARB8 ARB9 ARB10 ARB11 ARB12 ARB13 ARB14 ARB15 ARB16 SIN SQU TRI
<code><NR1></code>	Phase angle. Fixed to 0.

Return parameter `<NR2>,<NR1> | CONST | KEEP | SWEep,<NR2>,<NR1> | CONST | KEEP | SWEep,<NR2>,<NR1> | CONST | KEEP | SWEep,ARB1 | ARB2 | ARB3 | ARB4 | ARB5 | ARB6 | ARB7 | ARB8 | ARB9 | ARB10 | ARB11 | ARB12 | ARB13 | ARB14 | ARB15 | ARB16 | SIN | SQU | TRI,<NR1>`
 Returns the step parameters in the following order: ACV, ACV mode, DCV, DCV mode, frequency, frequency mode, wave, phase.

Example :SEQ:SPAR?
 +0.0,CONST,+0.0,CONST,+50.00,CONST,SIN,0

Set →
 → Query

[[:SOURce]:SEQ:STEP

Description	Sets or queries the current step number. (Only Sequence Mode Active)						
Syntax	<code>[[:SOURce]:SEQ:STEP {<NR1> MINimum MAXimum}</code>						
Query Syntax	<code>[[:SOURce]:SEQ:STEP? [MINimum MAXimum]</code>						
Parameter/Return parameter	<table border="0"> <tr> <td style="padding-right: 10px;"><code><NR1></code></td> <td>Step number</td> </tr> <tr> <td><code>MINimum</code></td> <td>Minimum step number</td> </tr> <tr> <td><code>MAXimum</code></td> <td>Maximum step number</td> </tr> </table>	<code><NR1></code>	Step number	<code>MINimum</code>	Minimum step number	<code>MAXimum</code>	Maximum step number
<code><NR1></code>	Step number						
<code>MINimum</code>	Minimum step number						
<code>MAXimum</code>	Maximum step number						

Example :SEQ:STEP 1
 Sets the step number to 1.

[:SOURce]:SEQuence:CONDition → Query

Description	Returns the sequence status.(Only Sequence Mode Active)
-------------	---

Query Syntax	[:SOURce]:SEQuence:CONDition?
--------------	-------------------------------

Return parameter	<NR1>	Current sequence status	0 (Idle mode)
			1 (Run mode)
			2 (Hold mode)

Example	:SEQ:COND? 1
---------	-----------------

:TRIGger:SEQuence:SElected:EXECute Set →

Description	Sets to execute actions for sequence mode. (Only Sequence Mode Active)
-------------	--

Syntax	:TRIGger:SEQuence:SElected:EXECute {STOP START HOLD BRAN1 BRAN2}
--------	---

Parameter	STOP	Stops sequence execution
	START	Starts sequence execution
	HOLD	Holds sequence execution
	BRAN1	Jumps to Branch 1 execution
	BRAN2	Jumps to Branch 2 execution

Example	TRIG:SEQ:SEL:EXEC STAR Starts sequence execution.
---------	--

Simulate Commands

[:SOURce]:SIMulation:CONDition	109
[:SOURce]:SIMulation:ABNormal:CODE	109
[:SOURce]:SIMulation:ABNormal:FREQUENCY 110	
[:SOURce]:SIMulation:ABNormal:PHASe	
:STARt:ENABle.....	110
[:SOURce]:SIMulation:ABNormal:PHASe	
:STARt[:IMMediate].....	111
[:SOURce]:SIMulation:ABNormal:PHASe	
:STOP:ENABle	111
[:SOURce]:SIMulation:ABNormal:PHASe	
:STOP[:IMMediate]	112
[:SOURce]:SIMulation:ABNormal:TIME	112
[:SOURce]:SIMulation:ABNormal:VOLTage ..	113
[:SOURce]:SIMulation:CSTep	113
[:SOURce]:SIMulation:INITial:CODE	114
[:SOURce]:SIMulation:INITial:FREQUENCY	114
[:SOURce]:SIMulation:INITial:PHASe:STARt	
:ENABle	115
[:SOURce]:SIMulation:INITial:PHASe:STARt[
:IMMediate].....	115
[:SOURce]:SIMulation:INITial:PHASe:STOP	
:ENABle	116
[:SOURce]:SIMulation:INITial:PHASe:STOP[
:IMMediate].....	116
[:SOURce]:SIMulation:INITial:VOLTage	117
[:SOURce]:SIMulation:NORMal<1 2>:CODE .	117
[:SOURce]:SIMulation:NORMal 1:FREQUENCY 118	
[:SOURce]:SIMulation:NORMal<1 2>	
:PHASe:STARt:ENABle	118
[:SOURce]:SIMulation:NORMal<1 2>	
:PHASe:STARt[:IMMediate]	119
[:SOURce]:SIMulation:NORMal<1 2>	
:PHASe:STOP:ENABle	119
[:SOURce]:SIMulation:NORMal<1 2>	
:PHASe:STOP[:IMMediate].....	120
[:SOURce]:SIMulation:NORMal<1 2>:TIME ..	120

[[:SOURce]:SIMulation:NORMAL 1:VOLTage.... 121
 [[:SOURce]:SIMulation:REPeat:COUNt 121
 [[:SOURce]:SIMulation:REPeat:ENABle..... 122
 [[:SOURce]:SIMulation:TRANSition<1 | 2>
 :TIME..... 122
 [[:SOURce]:SIMulation:TRANSition<1 | 2>
 :CODE 123
 :TRIGger:SIMulation:SElected:EXECute..... 123

[[:SOURce]:SIMulation:CONDition → Query

Description	Returns the simulation status. (Only Simulation Mode Active)		
Query Syntax	[:SOURce]:SIMulation:CONDition?		
Return parameter	<NR1>	Current simulation status	0 (Idle mode) 1 (Run mode) 2 (Hold mode)
Example	:SIM:COND? 1		

[[:SOURce]:SIMulation:ABNormal:CODE Set →
→ Query



Description	Sets the external trigger output for the abnormal step parameter. This option is only applicable when in the Simulation mode. (Only Simulation Mode Active)		
Syntax	[:SOURce]:SIMulation:ABNormal:CODE {<NR1> MINimum MAXimum}		
Query Syntax	[:SOURce]:SIMulation:ABNormal:CODE? [MINimum MAXimum]		
Parameter/Return parameter	<NR1> MINimum MAXimum	External trigger output, 0=LL, 1=LH, 2=HL, 3=HH. 0 (LL) 3 (HH)	
Example	SIM:ABN:CODE 1		

`[:SOURce]:SIMulation:ABNormal` (Set) →
`:FREQuency` → (Query)

Description	Sets or queries the frequency of the abnormal step of the simulation mode. (Only Simulation Mode Active)	
Syntax	[:SOURce]:SIMulation:ABNormal:FREQuency {<NR2> MINimum MAXimum}	
Query Syntax	[:SOURce]:SIMulation:ABNormal:FREQuency? [MINimum MAXimum]	
Parameter/Return parameter	<NR2> MINimum MAXimum	Frequency of abnormal step Minimum frequency Maximum frequency
Example	:SIM:ABN:FREQ 55 Sets the frequency to 55Hz.	

`[:SOURce]:SIMulation:ABNormal:PHASe` (Set) →
`:STARt:ENABle` → (Query)

Description	Enables/Disables (Fixed/Free) the ON Phs parameter of the abnormal step for the Simulation mode. (Only Simulation Mode Active)	
Syntax	[:SOURce]:SIMulation:ABNormal:PHASe:STARt:ENABle {<bool> OFF ON FREE FIXED}	
Query Syntax	[:SOURce]:SIMulation:ABNormal:PHASe:STARt:ENABle?	
Parameter/Return parameter	OFF 0 FREE ON 1 FIXED	Disabled Enabled
Example	:SIM:ABN:PHAS:STAR:ENAB 1 Enable the ON Phs.	

`[:SOURce]:SIMulation:ABNormal:PHASe` 
`:STOP[:IMMEDIATE]` 

Description	Sets or queries the OFF Phs parameter of the abnormal step for the Simulation mode. (Only Simulation Mode Active)						
Note:	Sets the off phase of the waveform after the output has been turned off.						
Syntax	<code>[:SOURce]:SIMulation:ABNormal:PHASe:STOP[:IMMEDIATE] {<NR2> MINimum MAXimum}</code>						
Query Syntax	<code>[:SOURce]:SIMulation:ABNormal:PHASe:STOP[:IMMEDIATE]? [MINimum MAXimum]</code>						
Parameter/Return parameter	<table border="1"> <tr> <td><NR2></td> <td>OFF Phs (Stop phase)</td> </tr> <tr> <td>MINimum</td> <td>0</td> </tr> <tr> <td>MAXimum</td> <td>359.9</td> </tr> </table>	<NR2>	OFF Phs (Stop phase)	MINimum	0	MAXimum	359.9
<NR2>	OFF Phs (Stop phase)						
MINimum	0						
MAXimum	359.9						
Example	<code>:SIM:ABN:PHAS:STOP 0</code> Sets OFF Phs to 0.						

`[:SOURce]:SIMulation:ABNormal:TIME` 

Description	Sets or queries the Time parameter of the abnormal step for the Simulation mode. (Only Simulation Mode Active)						
Syntax	<code>[:SOURce]:SIMulation:ABNormal:TIME {<NR2> MINimum MAXimum}</code>						
Query Syntax	<code>[:SOURce]:SIMulation:ABNormal:TIME? [MINimum MAXimum]</code>						
Parameter/Return parameter	<table border="1"> <tr> <td><NR2></td> <td>Time of the abnormal step in seconds</td> </tr> <tr> <td>MINimum</td> <td>0.0001</td> </tr> <tr> <td>MAXimum</td> <td>999.9999s</td> </tr> </table>	<NR2>	Time of the abnormal step in seconds	MINimum	0.0001	MAXimum	999.9999s
<NR2>	Time of the abnormal step in seconds						
MINimum	0.0001						
MAXimum	999.9999s						
Example	<code>:SIM:ABN:TIME 1</code> Sets the abnormal step time to 1 second.						

[[:SOURce]:SIMulation:ABNormal:VOLTage (Set) →
→ (Query)

Description	Sets or queries the Vset parameter of the abnormal step for the Simulation mode. (Only Simulation Mode Active)	
Syntax	[:SOURce]:SIMulation:ABNormal:VOLTage {<NR2> MINimum MAXimum}	
Query Syntax	[:SOURce]:SIMulation:ABNormal:VOLTage? [MINimum MAXimum]	
Parameter/Return parameter	<NR2> MINimum MAXimum	Voltage of the abnormal step. Minimum settable voltage Maximum settable voltage
Example	:SIM:ABN:VOLT MAX Sets the abnormal step voltage to the maximum.	

[[:SOURce]:SIMulation:CSTep → (Query)

Description	Returns the currently running step. (Only Simulation Mode Active)	
Query Syntax	[:SOURce]:SIMulation:CSTep?	
Return parameter	<NR1>	Current step +0 = Initial step +1 = Normal1 step +2 = Transition1 step +3 = Abnormal step +4 = Transition2 step +5 = Normal2 step
Example	:SIM:CSTep? +1	

[:SOURce]:SIMulation:INITial:CODE





Description	Sets the external trigger output for the initial step parameter. This option is only applicable when in the Simulation mode. (Only Simulation Mode Active)	
Syntax	[:SOURce]:SIMulation:INITial:CODE {<NR1> MINimum MAXimum}	
Query Syntax	[:SOURce]:SIMulation:INITial:CODE? [MINimum MAXimum]	
Parameter/Return parameter	<NR1>	0=LL, 1=LH, 2=HL, 3=HH MINimum 0 (LL) MAXimum 3 (HH)
Example	SIM:INIT:CODE 1	

[:SOURce]:SIMulation:INITial:FREQuency



Description	Sets or queries the frequency of the initial step of the simulation mode. (Only Simulation Mode Active)	
Syntax	[:SOURce]:SIMulation:INITial:FREQuency {<NR2> MINimum MAXimum}	
Query Syntax	[:SOURce]:SIMulation:INITial:FREQuency? [MINimum MAXimum]	
Parameter/Return parameter	<NR2>	Frequency of initial step MINimum Minimum frequency MAXimum Maximum frequency
Example	:SIM:INIT:FREQ 60 Sets the frequency of the initial step to 60Hz.	

`[:SOURce]:SIMulation:INITial:PHASe:START`  
`:ENABle`



Description Enables/Disables (Fixed/Free) the ON Phs parameter of the initial step for the Simulation mode. (Only Simulation Mode Active)

Syntax `[:SOURce]:SIMulation:INITial:PHASe:START:ENABle {<bool>|OFF|ON|FREE|FIXED}`

Query Syntax `[:SOURce]:SIMulation:INITial:PHASe:START:ENABle?`

Parameter/Return parameter	OFF 0	Disabled
	FREE	
	ON 1	Enabled
	FIXED	

Example `:SIM:INIT:PHAS:STAR:ENAB 1`
 Enable the ON Phs.

`[:SOURce]:SIMulation:INITial:PHASe:START`  
`[:IMMEDIATE]`

Description Sets or queries the ON Phs parameter of the initial step for the Simulation mode. (Only Simulation Mode Active)

Syntax `[:SOURce]:SIMulation:INITial:PHASe:START [:IMMEDIATE] {<NR2>|MINimum|MAXimum}`

Query Syntax `[:SOURce]:SIMulation:INITial:PHASe:START [:IMMEDIATE]? [MINimum|MAXimum]`

Parameter/Return parameter	<NR2>	ON Phs (start phase)
	MINimum	0
	MAXimum	359.9

Example `:SIM:INIT:PHAS:STAR 0`
 Sets ON Phs to 0.

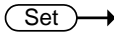
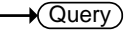
`[:SOURce]:SIMulation:INITial:PHASe:STOP` 
`:ENABLE` 

Description Enables/Disables (Fixed/Free) the OFF Phs parameter of the initial step for the Simulation mode. (Only Simulation Mode Active)

Syntax `[:SOURce]:SIMulation:INITial:PHASe:STOP:ENABLE`
`{<bool>|OFF|ON|FREE|FIXED }`

Query Syntax `[:SOURce]:SIMulation:INITial:PHASe:STOP:ENABLE?`

Parameter/Return parameter	<code>OFF 0 </code>	Disabled
	<code>FREE</code>	
	<code>ON 1 </code>	Enabled
	<code>FIXED</code>	

Example `:SIM:INIT:PHAS:STOP:ENAB 1`
 Enable the OFF Phs.

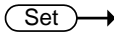
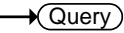
`[:SOURce]:SIMulation:INITial:PHASe:STOP` 
`[:IMMediate]` 

Description Sets or queries the OFF Phs parameter of the initial step for the Simulation mode. (Only Simulation Mode Active)

Note: Sets the off phase of the waveform after the output has been turned off.

Syntax `[:SOURce]:SIMulation:INITial:PHASe:STOP`
`[:IMMediate] {<NR2>|MINimum|MAXimum}`

Query Syntax `[:SOURce]:SIMulation:INITial:PHASe:STOP`
`[:IMMediate]? [MINimum|MAXimum]`

Parameter/Return parameter	<code><NR2></code>	OFF Phs (Stop phase)
	<code>MINimum</code>	0
	<code>MAXimum</code>	359.9

Example `:SIM:INIT:PHAS:STOP 0`
 Sets OFF Phs to 0.

`[:SOURce]:SIMulation:INITial:VOLTage`



Description	Sets or queries the Vset parameter of the initial step for the Simulation mode. (Only Simulation Mode Active)	
Syntax	[:SOURce]:SIMulation:INITial:VOLTage {<NR2> MINimum MAXimum}	
Query Syntax	[:SOURce]:SIMulation:INITial:VOLTage? [MINimum MAXimum]	
Parameter/Return parameter	<NR2> MINimum MAXimum	Voltage of the initial step. Minimum settable voltage Maximum settable voltage
Example	:SIM:INIT:VOLT MAX Sets the initial step voltage to the maximum.	

`[:SOURce]:SIMulation:NORMal<1|2>:CODE`

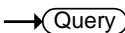



Description	Sets the external trigger output for the normal 1 or normal 2 step parameter. This option is only applicable when in the Simulation mode. (Only Simulation Mode Active)	
Syntax	[:SOURce]:SIMulation:NORMal<1 2>:CODE {<NR1> MINimum MAXimum}	
Query Syntax	[:SOURce]:SIMulation:NORMal<1 2>:CODE? [MINimum MAXimum]	
Parameter/Return parameter	<NR1> MINimum MAXimum	0=LL, 1=LH, 2=HL, 3=HH 0 (LL) 3 (HH)
Example	SIM:NORM1:CODE 1	

`[:SOURce]:SIMulation:NORMal 1` (Set) →
`:FREQuency` → (Query)

Description	Sets or queries the frequency of the normal1 step of the simulation mode. (Only Simulation Mode Active)	
Syntax	[:SOURce]:SIMulation:NORMal 1:FREQuency {<NR2> MINimum MAXimum}	
Query Syntax	[:SOURce]:SIMulation:NORMal 1:FREQuency? [MINimum MAXimum]	
Parameter/Return parameter	1 <NR2> MINimum MAXimum	Normal 1 Frequency of abnormal step Minimum frequency Maximum frequency
Example	:SIM:NORM1:FREQ 60 Sets the frequency to 60Hz.	

`[:SOURce]:SIMulation:NORMal<1|2>` (Set) →
`:PHASe:STARt:ENABle` → (Query)

Description	Enables/Disables (Fixed/Free) the ON Phs parameter of the normal1 or normal2 step for the Simulation mode. (Only Simulation Mode Active)	
Syntax	[:SOURce]:SIMulation:NORMal<1 2>:PHASe:STARt:ENABle { <bool> OFF ON FREE FIXED}	
Query Syntax	[:SOURce]:SIMulation:NORMal<1 2>:PHASe:STARt:ENABle?	
Parameter/Return parameter	<1 2> OFF 0 FREE ON 1 FIXED	Normal 1 or Normal 2 Disabled Enabled
Example	:SIM:NORM1:PHAS:STAR:ENAB 1 Enable the ON Phs.	

`[[:SOURce]:SIMulation:NORMal<1|2>:PHASe:START[:IMMEDIATE]`



Description Sets or queries the ON Phs parameter of the normal1 or normal2 step for the Simulation mode. (Only Simulation Mode Active)

Syntax `[[:SOURce]:SIMulation:NORMal<1|2>:PHASe:START[:IMMEDIATE] {<NR2>|MINimum|MAXimum}`

Query Syntax `[[:SOURce]:SIMulation:NORMal<1|2>:PHASe:START[:IMMEDIATE]? [MINimum|MAXimum]`

Parameter/Return parameter	<code><1 2></code>	Normal 1 or Normal 2
	<code><NR2></code>	ON Phs (start phase)
	<code>MINimum</code>	0
	<code>MAXimum</code>	359.9

Example `:SIM:NORM1:PHAS:STAR 0`
Sets ON Phs to 0.

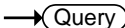
`[[:SOURce]:SIMulation:NORMal<1|2>:PHASe:STOP:ENABLE`



Description Enables/Disables (Fixed/Free) the OFF Phs parameter of the normal1 or normal2 step for the Simulation mode. (Only Simulation Mode Active)

Syntax `[[:SOURce]:SIMulation:NORMal<1|2>:PHASe:STOP:ENABLE {<bool>|OFF|ON|FREE|FIXED}`

Query Syntax `[[:SOURce]:SIMulation:NORMal<1|2>:PHASe:STOP:ENABLE?`

Parameter/Return parameter	<code><1 2></code>	Normal 1 or Normal 2
	<code>OFF 0 FREE</code>	Disabled
	<code>ON 1 FIXED</code>	Enabled

Example `:SIM:NORM1:PHAS:STOP:ENAB 1`
Enable the OFF Phs.

[:SOURce]:SIMulation:NORMal<1|2> 
 :PHASe:STOP[:IMMEDIATE] 

Description Sets or queries the OFF Phs parameter of the normal1 or normal2 step for the Simulation mode. (Only Simulation Mode Active)

Note: Sets the off phase of the waveform after the output has been turned off.

Syntax [:SOURce]:SIMulation:NORMal<1|2>:PHASe:STOP[:IMMEDIATE] {<NR2>|MINimum|MAXimum}

Query Syntax [:SOURce]:SIMulation:NORMal<1|2>:PHASe:STOP[:IMMEDIATE]? [MINimum|MAXimum]

Parameter/Return parameter	<1 2>	Normal 1 or Normal 2
	<NR2>	OFF Phs (Stop phase)
	MINimum	0
	MAXimum	359.9

Example :SIM:NORM1:PHAS:STOP 0
 Sets OFF Phs to 0.

[:SOURce]:SIMulation:NORMal<1|2>:TIME 

Description Sets or queries the Time parameter of the normal1 or normal2 step for the Simulation mode. (Only Simulation Mode Active)

Syntax [:SOURce]:SIMulation:NORMal<1|2>:TIME {<NR2>|MINimum|MAXimum}

Query Syntax [:SOURce]:SIMulation:NORMal<1|2>:TIME? [MINimum|MAXimum]

Parameter/Return parameter	<1 2>	Normal 1 or Normal 2
	<NR2>	Time of the step in seconds
	MINimum	0.0001
	MAXimum	999.9999s

Example :SIM:NORM1:TIME 1
 Sets the step time to 1 second.

Set →
 → Query

[[:SOURce]:SIMulation:NORMal 1:VOLTage

Description Sets or queries the Vset parameter of the normal1 step for the Simulation mode. (Only Simulation Mode Active)

Syntax [[:SOURce]:SIMulation:NORMal 1:VOLTage {<NR2>|MINimum|MAXimum}

Query Syntax [[:SOURce]:SIMulation:NORMal 1:VOLTage? [MINimum|MAXimum]

Parameter/Return parameter	1	Normal 1
	<NR2>	Voltage of the abnormal step.
	MINimum	Minimum settable voltage
	MAXimum	Maximum settable voltage

Example :SIM:NORM1:VOLT MAX
 Sets the normal1step voltage to the maximum.

Set →
 → Query

[[:SOURce]:SIMulation:REPeat:COUNT

Description Sets or queries the repeat count for the Simulation mode. (Only Simulation Mode Active)

Syntax [[:SOURce]:SIMulation:REPeat:COUNT {<NR1>|MINimum|MAXimum}

Query Syntax [[:SOURce]:SIMulation:REPeat:COUNT? [MINimum|MAXimum]

Parameter/Return parameter	<NR1>	0 ~ 9999 (0 = infinite loop)
	MINimum	0
	MAXimum	9999

Example :SIM:REP:COUN 1
 Sets the repeat count to 1.

[[:SOURce]:SIMulation:REPeat:ENABle (Set) →
→ (Query)

Description	Turns the repeat function on or off for the Simulation mode. (Only Simulation Mode Active)	
Syntax	[:SOURce]:SIMulation:REPeat:ENABle {<bool> OFF ON}	
Query Syntax	[:SOURce]:SIMulation:REPeat:ENABle?	
Parameter/Return parameter	OFF 0	Disabled
	ON 1	Enabled
Example	:SIM:REP:ENAB 1 Enables the repeat function.	

[[:SOURce]:SIMulation:TRANSition<1|2>:TIME (Set) →
→ (Query)

Description	Sets or queries the Time parameter of the transition step for the Simulation mode. (Only Simulation Mode Active)	
Syntax	[:SOURce]:SIMulation:TRANSition<1 2>:TIME {<NR2> MINimum MAXimum}	
Query Syntax	[:SOURce]:SIMulation:TRANSition<1 2>:TIME? [MINimum MAXimum]	
Parameter/Return parameter	<NR2>	Time of the step in seconds
	MINimum	0
	MAXimum	999.9999s
Example	:SIM:TRAN1:TIME 1 Sets the step time to 1 second.	

`[:SOURce]:SIMulation:TRANSition<1|2>:CODE` Set →
`DE` → Query

Description Sets the external trigger output for the transition step parameter. This option is only applicable when in the Simulation mode. (Only Simulation Mode Active)

Syntax `[:SOURce]:SIMulation:TRANSition<1|2>:CODE {<NR1>|MINimum|MAXimum}`

Query Syntax `[:SOURce]:SIMulation:TRANSition<1|2>:CODE? [MINimum|MAXimum]`

Parameter/Return parameter	<code><NR1></code>	0=LL, 1=LH, 2=HL, 3=HH
	MINimum	0 (LL)
	MAXimum	3 (HH)

Example `SIM:TRAN1:CODE 1`

`:TRIGger:SIMulation:SELEcted:EXECute` Set →

Description Sets to execute actions for simulate mode. (Only Simulation Mode Active)

Syntax `:TRIGger:SIMulation:SELEcted:EXECute {STOP|START|HOLD}`

Parameter	STOP	Stops simulate execution
	START	Starts simulate execution
	HOLD	Holds simulate execution

Example `TRIG:SIM:SEL:EXEC STAR`
Starts simulate execution.

Input Subsystem Command

:INPut:GAIN.....	124
:INPut:SYNC:SOURce	124

:INPut:GAIN

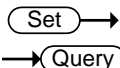

Description Sets or queries the input gain value. (Only AC+DC-EXT or AC-EXT or AC+DC-ADD or AC-ADD Active)

Syntax :INPut:GAIN {<NR2>(V)|MINimum|MAXimum}

Query Syntax :INPut:GAIN? [MINimum|MAXimum]

Parameter/Return parameter	<NR2>	Input gain value
	MINimum	Minimum input gain value
	MAXimum	Maximum input gain value

Example :INP:GAIN?
+150.0000
Returns the input gain value as 150.0.

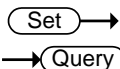

:INPut:SYNC:SOURce

Description Sets or queries state of sync source. (Only AC+DC-sync or AC-sync Active)

Syntax :INPut:SYNC:SOURce {<NR1>|LINE|EXT}

Query Syntax :INPut:SYNC:SOURce?

Parameter/Return parameter	<NR1>	LINE (0) EXT (1)
	LINE 0	LINE sync source
	EXT 1	EXT sync source

Example :INP:SYNC:SOUR?
EXT
Returns the state of sync source as EXT.

Display Command

:DISPlay[:WINDow]:DESIgn:MODE	125
:DISPlay[:WINDow]:MEASure	
:SOURce<1 2 3>	125

:DISPlay[:WINDow]:DESIgn:MODE (Set) →

Description	Sets two display mode.	
Syntax	:DISPlay[:WINDow]:DESIgn:MODE{NORMal SIMple}	
Parameter	MORMal	Configure setup and Measurement.
	SIMple	All measurement times.
Example	:DISP:DES:MODE NORM Sets standard normal display.	

:DISPlay[:WINDow]:MEASure:SOURce<1|2|3> (Set) →

Description	Sets standard normal display to measurement items 1 – 3.	
Syntax	:DISPlay[:WINDow]:MEASure:SOURce<1 3> {VRMS VAVG VMAX VMIN IRMS IAVG IMAX IMIN IPKH RPOWer SPOWer QPOWer FREQUency PFACTOR CFACtor THDV THDI}	
Parameter	Item 1	VRMS , VAVG , VMAX , VMIN , RPOWer , SPOWer*1, QPOWer*1, THDV*2
	Item 2	IRMS , IAVG , IMAX , IMIN , IPKH , PFACTOR*1, CFACtor*1, THDI*2
	Item 3	RPOWer , SPOWer*1, QPOWer*1, IPKH , PFACTOR*1, CFACtor*1, FREQUency*3
	Note	*1: Not available for DC-INT *2: Available for AC-INT only *3: Available for AC+DC-Sync & AC-Sync only

Example :DISP:MEAS:SOUR1 VRMS
 Sets measurement source 1 VRMS display.

Status Register Overview

To program the ASR power supply effectively, the Status registers need to be understood. This chapter explains in detail how the Status registers are used and how to configure them.

Introduction to the Status Registers.....	127
The Status Registers	128
Questionable Status Register Group.....	129
Operation Status Register Group	132
Warning Status Register Group	134
System Lock Status Register Group.....	137
Standard Event Status Register Group.....	139
Status Byte Register & Service Request Enable Register	141

Introduction to the Status Registers

Overview

The status registers are used to determine the status of the power supply. The status registers maintain the status of the protection conditions, operation conditions and instrument errors.

The ASR Series have a number of register groups:

- Questionable Status Register Group
- Standard Event Status Register Group
- Operation Status Register Group
- Warning Status Register Group
- System Lock Status Register Group
- Status Byte Register
- Service Request Enable Register
- Service Request Generation
- Error Queue
- Output Buffer

The diagram below shows the structure of the Status registers.

The Status Registers

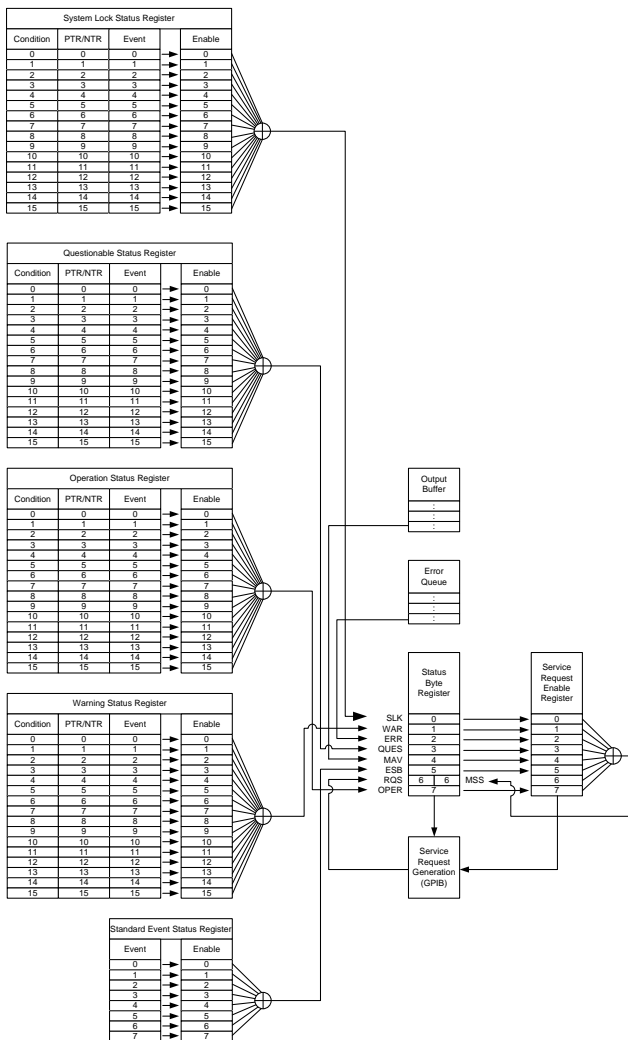

Questionable Status Register Group

Overview

The Questionable Status Register Group indicates if any protection modes or limits have been tripped.

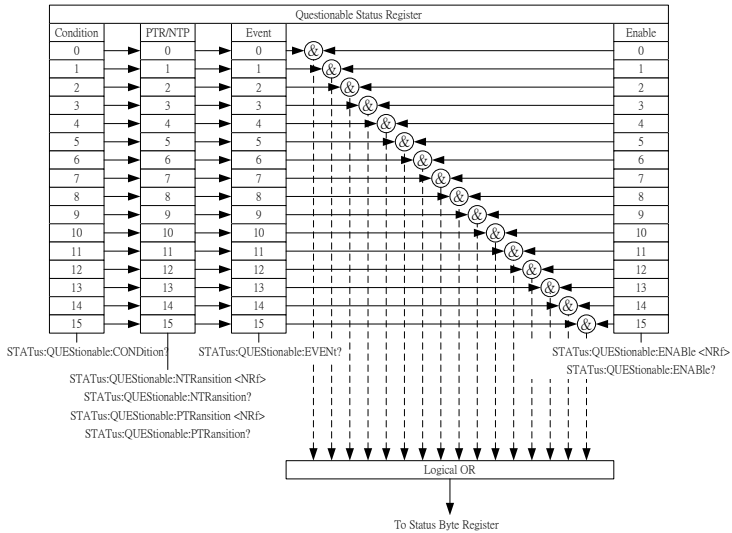

Bit Summary

Event	Bit #	Bit Weight
Output Overvoltage	0	1
Over internal maximum voltage (110% of rating voltage).		
Over Irms Current	1	2
Output current RMS value is excessive		
DCAC Power Unit Error	3	8
Internal DCAC power unit function error.		

DCDC Power Unit Error Internal DCDC power unit function error.	4	16
Output Short Call attention to output terminal short status	5	32
Over Ipeak+ Current or Over Ipeak- Current Positive/Negative output current peak value is excessive.	6	64
Fan Failure Fan failure. Contact service center.	7	128
Calibration Data Error The calibration data is abnormal or out of allowance range.	8	256
Output Over-Power Over internal power stage maximum power (110% of rating power)	9	512
IPK Limit The peak current limiter is activated.	10	1024
Remote Sensing Voltage Out of Range The Sensing voltage limiter is activated.	11	2048
IRMS Limit The RMS current limiter is activated.	12	4096
Always 0	15	32768

Condition Register	The Questionable Status Condition Register indicates the status of the power supply. If a bit is set in the Condition register, it indicates that the event is true. Reading the condition register does not change the state of the condition register.
PTR/NTR Filters	The PTR/NTR (Positive/Negative transition) register determines the type of transition conditions that will set the corresponding bit in the Event Registers. Use the Positive transition filter to view events that change from false to positive, and use the negative transition filter to view events that change from positive to negative.
	Positive Transition 0→1
	Negative Transition 1→0
Event Register	The PTR/NTR Register will dictate the type of transition conditions will set the corresponding bits in the Event Register. If the Event Register is read, it will be cleared to 0.
Enable Register	The Enable register determines which Events in the Event Register will be used to set the QUES bit in the Status Byte Register.

Operation Status Register Group

Overview

The Operation Status Register Group indicates the operating status of the power supply.

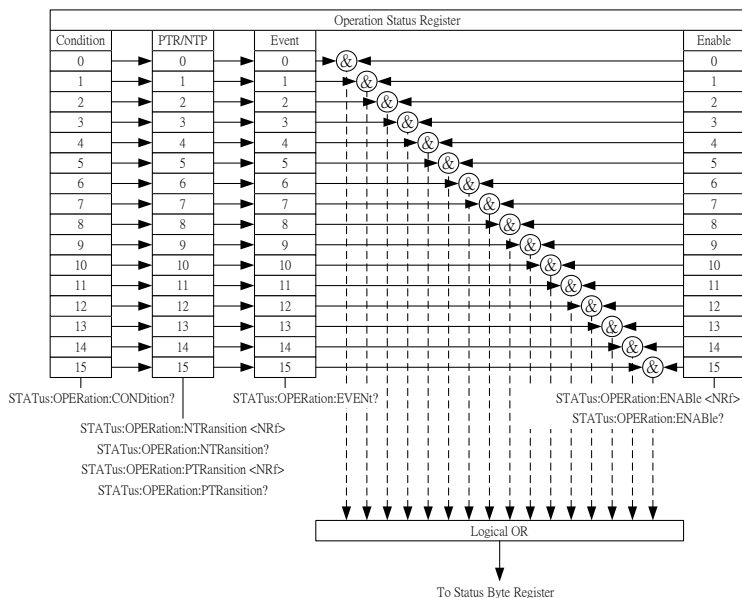

Bit Summary

Event	Bit #	Bit Weight
Busy Status	1	2
LOCK status (SYNC) status	8	256
Hold Status (Sequence)	12	4096
Run Status (Sequence)	14	16384
Always 0	15	32768

Condition Register	The Operation Status Condition Register indicates the operating status of the power supply. If a bit is set in the Condition register, it indicates that the event is true. Reading the condition register does not change the state of the condition register.
PTR/NTR Filters	The PTR/NTR (Positive/Negative transition) register determines the type of transition conditions that will set the corresponding bit in the Event Registers. Use the Positive transition filter to view events that change from false to positive, and use the negative transition filter to view events that change from positive to negative.
	Positive Transition 0→1
	Negative Transition 1→0
Event Register	The PTR/NTR Register will dictate the type of transition conditions will set the corresponding bits in the Event Register. If the Event Register is read, it will be cleared to 0.
Enable Register	The Enable register determines which registered Events in the Event Register will be used to set the OPER bit in the Status Byte Register.

Warning Status Register Group

Overview

The Warning Status Register Group is a secondary protection status register for the supply output.

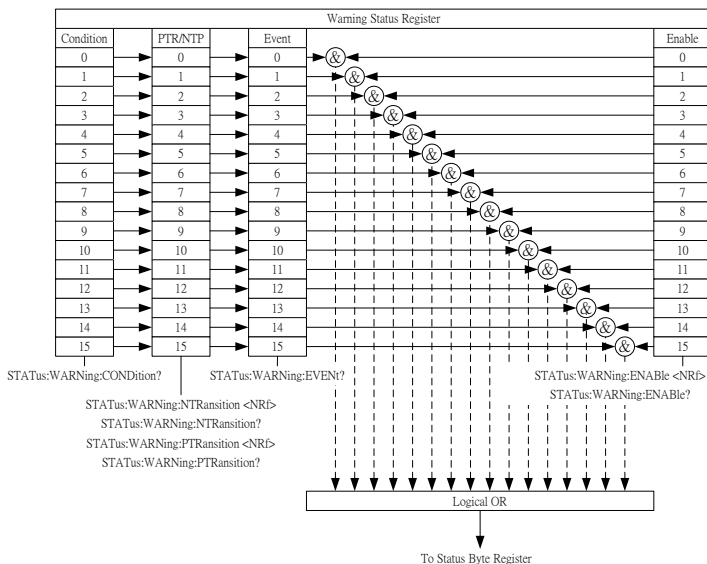

Bit Summary

Event	Bit #	Bit Weight
Output Overvoltage	0	1
Over internal maximum voltage (110% of rating voltage).		
Over Irms Current	1	2
Output current RMS value is excessive		

Over Ipeak+ Current or Over Ipeak- Current Positive/Negative output current peak value is excessive.	3	8
DCAC Power Unit Error Internal DCAC power unit function error.	5	32
DCDC Power Unit Error Internal DCDC power unit function error.	6	64
External Sync Frequency Error The external synchronization signal input frequency is out of the allowance range. (40Hz ~ 999.9Hz)	7	128
Sensing Voltage Error Remote sense connection wire is abnormal or over maximum compensation voltage.	9	512
Over Irms Current Output current RMS value is excessive	10	1024
Over Ipeak+ Current or Over Ipeak- Current Positive/Negative output current peak value is excessive.	11	2048
Output Over-Power Over internal power stage maximum power (110% of rating power)	12	4096
IRMS Limit The RMS current limiter is activated.	13	8192

IPK Limit	14	16384
The peak current limiter is activated.		
Always 0	15	32768

Condition Register The System Lock Status Condition Register indicates the system lock status of the power supply. If a bit is set in the Condition register, it indicates that the event is true. Reading the condition register does not change the state of the condition register.

PTR/NTR Filters The PTR/NTR (Positive/Negative transition) register determines the type of transition conditions that will set the corresponding bit in the Event Registers. Use the Positive transition filter to view events that change from false to positive, and use the negative transition filter to view events that change from positive to negative.

Positive Transition	0→1
Negative Transition	1→0

Event Register The PTR/NTR Register will dictate the type of transition conditions will set the corresponding bits in the Event Register. If the Event Register is read, it will be cleared to 0.

Enable Register The Enable register determines which registered Events in the Event Register will be used to set the SLK bit in the Status Byte Register.

System Lock Status Register Group

Overview

The System Lock Status Register Group indicates if system lock protection modes have been tripped.

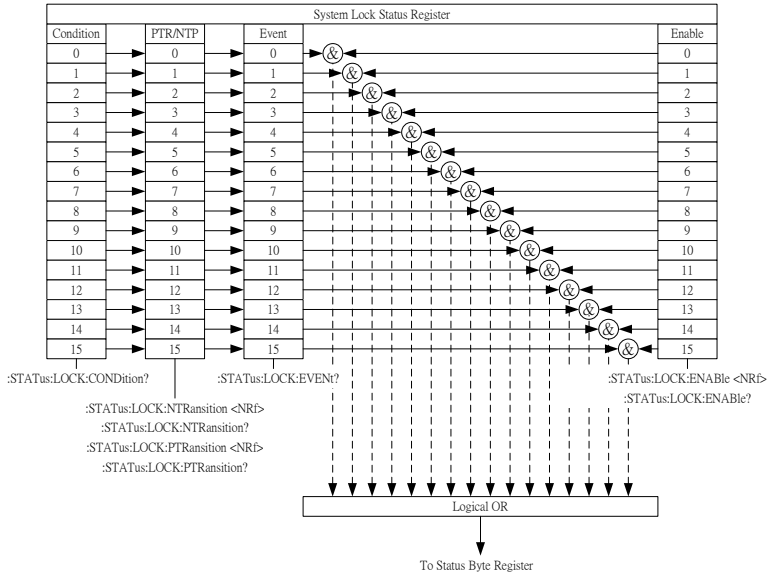

Bit Summary

Event	Bit #	Bit Weight
Power Input Anomaly	0	1
The power input voltage is insufficient or turning off main power switch. Check input power before rebooting the unit.		
Fan Failure	7	128
Fan failure. Contact service center.		
Startup Anomaly	8	256
Abnormal startup procedure.		

PFC Power Unit Error	9	512
----------------------	---	-----

Internal PFC power unit function error.

Condition Register	The System Lock Status Condition Register indicates the system lock status of the power supply. If a bit is set in the Condition register, it indicates that the event is true. Reading the condition register does not change the state of the condition register.
--------------------	---

PTR/NTR Filters	The PTR/NTR (Positive/Negative transition) register determines the type of transition conditions that will set the corresponding bit in the Event Registers. Use the Positive transition filter to view events that change from false to positive, and use the negative transition filter to view events that change from positive to negative.
-----------------	---

Positive Transition	0→1
---------------------	-----

Negative Transition	1→0
---------------------	-----

Event Register	The PTR/NTR Register will dictate the type of transition conditions will set the corresponding bits in the Event Register. If the Event Register is read, it will be cleared to 0.
----------------	--

Enable Register	The Enable register determines which registered Events in the Event Register will be used to set the SLK bit in the Status Byte Register.
-----------------	---

Standard Event Status Register Group

Overview

The Standard Event Status Register Group indicates if any errors have occurred. The bits of the Event register are set by the error event queue.

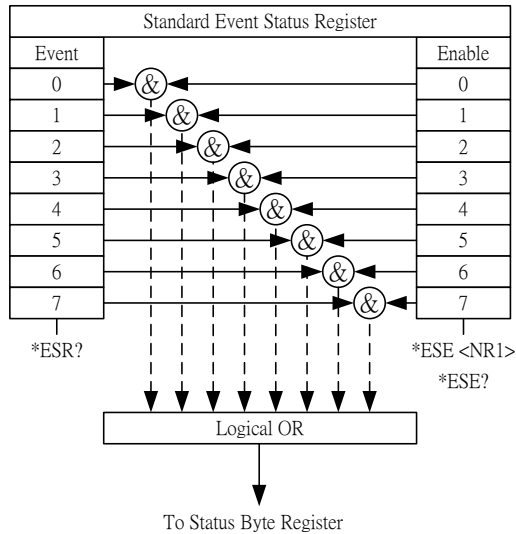

Bit Summary

Event	Bit #	Bit Weight
OPC (Operation complete)	0	1
The OCP bit is set when all selected pending operations are complete. This bit is set in response to the *OPC command.		
RQC (Request control)	1	2

	<p>QUE (Query Error)</p> <p>The Query Error bit is set in response to an error reading the Output Queue. This can be caused by trying to read the Output Queue when there is no data present.</p>	2	4
	<p>DDE (Device Dependent Error)</p> <p>Device specific error.</p>	3	8
	<p>EXE (Execution Error)</p> <p>The EXE bit indicates an execution error due to one of the following: illegal command parameter, parameter out of range, invalid parameter, the command didn't execute due to an overriding operation condition.</p>	4	16
	<p>CME (Command Error)</p> <p>The CME bit is set when a syntax error has occurred. The CME bit can also be set when a <GET> command is received within a program message.</p>	5	32
	<p>URQ (User Request)</p>	6	64
	<p>PON (Power On)</p> <p>Indicates the power is turned on.</p>	7	128
Event Register	<p>Any bits set in the event register indicate that an error has occurred. Reading the Event register will reset the register to 0.</p>		
Enable Register	<p>The Enable register determines which Events in the Event Register will be used to set the ESB bit in the Status Byte Register.</p>		

Status Byte Register & Service Request Enable Register

Overview

The Status Byte register consolidates the status events of all the status registers. The Status Byte register can be read with the *STB? query and can be cleared with the *CLS command.

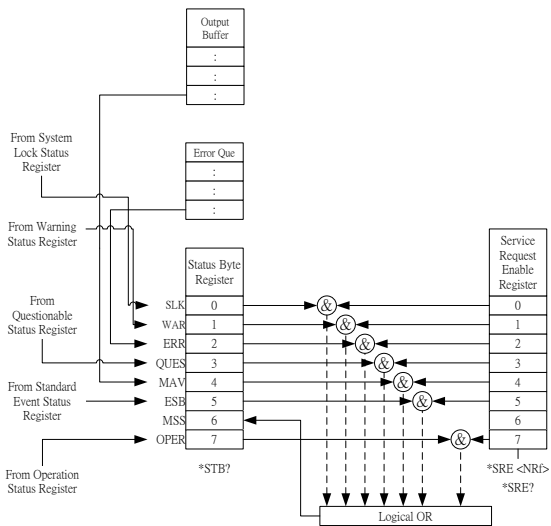

Bit Summary

Event	Bit #	Bit Weight
SLK(System Lock Status Register Summary)	0	1
WAR (Warning Status Register)	1	2
ERR (Error Queue not empty)	2	4
QUES (Questionable Status Register)	3	8
MAV (Message Available)	4	16
ESB(Standard Event Status Register Summary)	5	32

	RQS / MSS(Reuest Service / Master Summary Status)	6	64
	OPER (Operation Status Register)	7	128

Status Byte Register	Any bits set in the Status byte register acts as a summary register for all the three other status registers and indicates if there is a service request, an error in the Error Queue or data in the Output Queue. Reading the Status Byte register will reset the register to 0.
Service Request Enable Register	The Service Request Enable Register controls which bits in the Status Byte Register are able to generate service requests.

Error List

Command Errors	143
Execution Errors	147
Device Specific Errors	149
Query Errors	150

Command Errors

Overview

An <error/event number> in the range [-199 , -100] indicates that an IEEE 488.2 syntax error has been detected by the instrument's parser. The occurrence of any error in this class shall cause the command error bit (bit 5) in the event status register (IEEE 488.2, section 11.5.1) to be set. One of the following events has occurred:

- An IEEE 488.2 syntax error has been detected by the parser. That is, a controller-to-device message was received which is in violation of the IEEE 488.2 standard. Possible violations include a data element which violates the device listening formats or whose type is unacceptable to the device.
- An unrecognized header was received. Unrecognized headers include incorrect device-specific headers and incorrect or unimplemented IEEE 488.2 common commands.

Events that generate command errors shall not generate execution errors, device-specific errors, or query errors; see the other error definitions in this chapter.

Error Code	Description
-100 Command Error	This is the generic syntax error for devices that cannot detect more specific errors. This code indicates only that a Command Error as defined in IEEE 488.2,11.5.1.1.4 has occurred.
-102 Syntax error	An unrecognized command or data type was encountered; for example, a string was received when the device does not accept strings.
-103 Invalid separator	The parser was expecting a separator and encountered an illegal character; for example, the semicolon was omitted after a program message unit, MEAS:VOLT:DC?:MEASCURR:DC?
-104 Data type error	The parser recognized a data element different than one allowed; for example, numeric or string data was expected but block data was encountered.
-108 Parameter not allowed	More parameters were received than expected for the header; for example, the :SYSTem:KLOCK command only accepts one parameter, so receiving SYSTem:KLOCK 1,0 is not allowed.
-109 Missing parameter	Fewer parameters were received than required for the header; for example, the :SYSTem:KLOCK command requires one parameter, so receiving :SYSTem:KLOCK is not allowed.
-111 Header separator error	A character which is not a legal header separator was encountered while parsing the header; for example, no white space followed the header, thus *SRE2 is an error.

-112 Program mnemonic too long	The header contains more than twelve characters (see IEEE 488.2, 7.6.1.4.1).
-113 Undefined header	The header is syntactically correct, but it is undefined for this specific device; for example, *XYZ is not defined for any device.
-114 Header suffix out of range	The value of a numeric suffix attached to a program mnemonic, see Syntax and Style section 6.2.5.2, makes the header invalid.
-115 Unexpected number of parameters	The number of parameters received does not correspond to the number of parameters expected. This is typically due to an inconsistency with the number of instruments in the selected group.
-120 Numeric data error	This error, as well as errors -121 through -129, are generated when parsing a data element which appears to be numeric, including the nondecimal numeric types. This particular error message should be used if the device cannot detect a more specific error.
-121 Invalid character in number	An invalid character for the data type being parsed was encountered; for example, an alpha in a decimal numeric or a "9" in octal data.
-128 Numeric data not allowed	A legal numeric data element was received, but the device does not accept one in this position for the header.
-131 Invalid suffix	The suffix does not follow the syntax described in IEEE 488.2, 7.7.3.2, or the suffix is inappropriate for this device.

-141 Invalid character data	Either the character data element contains an invalid character or the particular element received is not valid for the header.
-148 Character data not allowed	A legal character data element was encountered where prohibited by the device.
-151 Invalid string data	A string data element was expected, but was invalid for some reason (see IEEE 488.2, 7.7.5.2); for example, an END message was received before the terminal quote character.
-158 String data not allowed	A string data element was encountered but was not allowed by the device at this point in parsing.
-160 Block data error	This error, as well as errors -161 through -169, are generated when parsing a block data element. This particular error message should be used if the device cannot detect a more specific error.
-161 Invalid block data	A block data element was expected, but was invalid for some reason (see IEEE 488.2, 7.7.6.2); for example, an END message was received before the length was satisfied.
-168 Block data not allowed	A legal block data element was encountered but was not allowed by the device at this point in parsing.
-178 Expression data not allowed	A legal expression data was encountered but was not allowed by the device at this point in parsing.

Execution Errors

Overview An <error/event number> in the range [-299 , -200] indicates that an error has been detected by the instrument's execution control block. The occurrence of any error in this class shall cause the execution error bit (bit 4) in the event status register (IEEE 488.2, section 11.5.1) to be set. One of the following events has occurred:

- A <PROGRAM DATA> element following a header was evaluated by the device as outside of its legal input range or is otherwise inconsistent with the device's capabilities.
- A valid program message could not be properly executed due to some device condition.

Execution errors shall be reported by the device after rounding and expression evaluation operations have taken place. Rounding a numeric data element, for example, shall not be reported as an execution error. Events that generate execution errors shall not generate Command Errors, device-specific errors, or Query Errors; see the other error definitions in this section.

Error Code	Description
-200 Execution error	This is the generic syntax error for devices that cannot detect more specific errors. This code indicates only that an Execution Error as defined in IEEE 488.2, 11.5.1.1.5 has occurred.

-201 Invalid while in local	Indicates that a command is not executable while the device is in local due to a hard local control (see IEEE 488.2, 5.6.1.5); for example, a device with a rotary switch receives a message which would change the switches state, but the device is in local so the message cannot be executed.
-203 Command protected	Indicates that a legal password-protected program command or query could not be executed because the command was disabled.
-211 Trigger ignored	Indicates that a GET, *TRG, or triggering signal was received and recognized by the device but was ignored because of device timing considerations; for example, the device was not ready to respond. Note: a DT0 device always ignores GET and treats *TRG as a Command Error.
-213 Init ignored	Indicates that a request for a measurement initiation was ignored as another measurement was already in progress.
-220 Parameter error	Indicates that a program data element related error occurred. This error message should be used when the device cannot detect the more specific errors described for errors -221 through -229.
-221 Settings conflict	Indicates that a legal program data element was parsed but could not be executed due to the current device state (see IEEE 488.2, 6.4.5.3 and 11.5.1.1.5.).

-222 Data out of range	Indicates that a legal program data element was parsed but could not be executed because the interpreted value was outside the legal range as defined by the device (see IEEE 488.2, 11.5.1.1.5.).
-224 Illegal parameter value	Used where exact value, from a list of possibles, was expected.

Device Specific Errors

Overview An <error/event number> in the range [-399 , -300] or [1 , 32767] indicates that the instrument has detected an error which is not a command error, a query error, or an execution error; some device operations did not properly complete, possibly due to an abnormal hardware or firmware condition. These codes are also used for self-test response errors. The occurrence of any error in this class should cause the device-specific error bit (bit 3) in the event status register (IEEE 488.2, section 11.5.1) to be set. The meaning of positive error codes is device-dependent and may be enumerated or bit mapped; the <error message>string for positive error codes is not defined by SCPI and available to the device designer.

Note that the string is not optional; if the designer does not wish to implement a string for a particular error, the null string should be sent (for example, 42,""). The occurrence of any error in this class should cause the device-specific error bit (bit 3) in the event status register (IEEE 488.2, section 11.5.1) to be set. Events that generate device-specific errors shall not generate command errors, execution errors,

or query errors; see the other error definitions in this section.

Error Code	Description
-310 System error	Indicates that some error, termed “system error” by the device, has occurred. This code is device-dependent.
-320 Storage fault	Indicates that the firmware detected a fault when using data storage. This error is not an indication of physical damage or failure of any mass storage element.

Query Errors

Overview

An <error/event number> in the range [-499 , -400] indicates that the output queue control of the instrument has detected a problem with the message exchange protocol described in IEEE 488.2, chapter 6. The occurrence of any error in this class shall cause the query error bit (bit 2) in the event status register (IEEE 488.2, section 11.5.1) to be set. These errors correspond to message exchange protocol errors described in IEEE 488.2, section 6.5. One of the following is true:

- An attempt is being made to read data from the output queue when no output is either present or pending;
- Data in the output queue has been lost.

Events that generate query errors shall not generate command errors, execution errors, or device-specific errors; see the other error definitions in this section.

Error Code	Description
-400 Query error	This is the generic query error for devices that cannot detect more specific errors. This code indicates only that a Query Error as defined in IEEE 488.2, 11.5.1.1.7 and 6.3 has occurred.

APPENDIX

Factory Default Settings

The following default settings are the factory configuration settings for the ASR-3000 series. For details on how to return to the factory default settings, please see the user manual.

AC+DC-INT Mode	ASR-3200	ASR-3300	ASR-3400
Range		100V	
Wave Shape		SIN	
ACV		0.0 Vrms	
DCV		+0.0 Vdc	
FREQ		50.00 Hz	
IRMS	21.00 A	31.50 A	42.00 A
V Limit		+/- 285.0 Vdc	
F Limit Lo		1.00 Hz	
F Limit Hi		999.9 Hz	
IPK Limit	+/- 126.0 A	+/- 189.0 A	+/- 252.0 A
ON Phs		0.0°	
OFF Phs		0.0°	

AC-INT Mode	ASR-3200	ASR-3300	ASR-3400
Range		100V	
Wave Shape		SIN	
ACV		0.0 Vrms	
FREQ		50.00 Hz	
IRMS	21.00 A	31.50 A	42.00 A
V Limit		200.0 Vrms	
F Limit Lo		40.00 Hz	
F Limit Hi		999.9 Hz	
IPK Limit	+/- 126.0 A	+/- 189.0 A	+/- 252.0 A
ON Phs		0.0°	
OFF Phs		0.0°	

DC-INT Mode	ASR-3200	ASR-3300	ASR-3400
Range		100V	
DCV		0.0 Vdc	
I	21.00 A	31.50 A	42.00 A
V Limit		+/- 285.0 Vdc	
IPK Limit	+/- 126.0 A	+/- 189.0 A	+/- 252.0 A

AC+DC-EXT Mode	ASR-3200	ASR-3300	ASR-3400
Range		100V	
GAIN		100.0	
IRMS	21.00 A	31.50 A	42.00 A
IPK Limit	+/- 126.0 A	+/- 189.0 A	+/- 252.0 A

AC-EXT Mode	ASR-3200	ASR-3300	ASR-3400
Range		100V	
GAIN		100.0	
IRMS	21.00 A	31.50 A	42.00 A
IPK Limit	+/- 126.0 A	+/- 189.0 A	+/- 252.0 A

AC+DC-ADD Mode	ASR-3200	ASR-3300	ASR-3400
Range		100V	
Wave Shape		SIN	
ACV		0.0 Vrms	
DCV		+0.0 Vdc	
GAIN		100.0	
FREQ		50.00 Hz	
IRMS	21.00 A	31.50 A	42.00 A
V Limit		+/- 285.0 Vdc	
F Limit Lo		1.00 Hz	
F Limit Hi		999.9 Hz	
IPK Limit	+/- 126.0 A	+/- 189.0 A	+/- 252.0 A
ON Phs		0.0°	
OFF Phs		0.0°	

AC-ADD Mode	ASR-3200	ASR-3300	ASR-3400
Range		100V	
Wave Shape		SIN	
ACV		0.0 Vrms	
GAIN		100.0	
FREQ		50.00 Hz	

IRMS	21.00 A	31.50 A	42.00 A
V Limit		200.0 Vrms	
F Limit Lo		40.00 Hz	
F Limit Hi		999.9 Hz	
IPK Limit	+/- 126.0 A	+/- 189.0 A	+/- 252.0 A
ON Phs		0.0°	
OFF Phs		0.0°	

AC+DC-SYNC Mode	ASR-3200	ASR-3300	ASR-3400
Range		100V	
Wave Shape		SIN	
ACV		0.0 Vrms	
DCV		+0.0 Vdc	
SIG		LINE	
IRMS	21.00 A	31.50 A	42.00 A
V Limit		+/- 285.0 Vdc	
F Limit		999.9 Hz	
IPK Limit	+/- 126.0 A	+/- 189.0 A	+/- 252.0 A
ON Phs		0.0°	
OFF Phs		0.0°	

AC-SYNC Mode	ASR-3200	ASR-3300	ASR-3400
Range		100V	
Wave Shape		SIN	
ACV		0.0 Vrms	
SIG		LINE	
IRMS	21.00 A	31.50 A	42.00 A
V Limit		200.0 Vrms	
F Limit		999.9 Hz	
IPK Limit	+/- 126.0 A	+/- 189.0 A	+/- 252.0 A
ON Phs		0.0°	
OFF Phs		0.0°	

Menu	ASR-3000
T _{ipeak, hold} (msec)	1 ms
IPK CLR	EXEC
Power ON	OFF
Buzzer	ON
Remote Sense	OFF
Slew Rate Mode	Slope
Output Relay	Enable
THD Format	IEC
External Control	OFF
V Unit (TRI, ARB)	rms
LAN	ASR-3000
DHCP	ON
USB Device	ASR-3000
Speed	Full
Sequence Mode	ASR-3000
Step	0
Time	0.1000 s
ACV	0.0, CT
DCV	0.0, CT
Fset	50.0, CT
Wave	SIN
Jump To	OFF
Jump Cnt	1
Branch 1	OFF
Branch 2	OFF
Term	CONTI
Sync Code	LL
ON Phs	Free
OFF Phs	Free

Simulation Mode	
Step	Initial
Repeat	OFF
Time	0.1000 s
ACV	0.0
Fset	50.00
ON Phs	Free
OFF Phs	Free
Wave	SIN
Code	LL
RS232C	
Baudrate	9600
Databits	8bits
Parity	None
Stopbits	1bit
GPIB	
Address	Optional 1 10

INDEX

Accessories	10	Command list	45
Caution symbol	4	Command syntax	41
Cleaning the instrument	7	Error list	143
Default settings	152	Ethernet	21
Disposal instructions	7	GPIB	31
EN61010		LAN	21
pollution degree	7	RS232	24
Environment		Status registers	127
safety instruction	7	USB	22
Ethernet		Remote control function check	
interface	21	GPIB	32
Front panel diagram	12	Realterm	28
Ground		RS-232	23, 26
symbol	4	USB	23, 26
List of features	9	Service operation	
Model differences	9	about disassembly	5
Power on/off		Socket server function check	36
safety instruction	6	Warning symbol	4
Remote control	20	Web server function check	35