



KANOMAX

4CH ANEMOMASTER

SYSTEM 6 2 4 4
(MODEL 1570)

Operation Manual

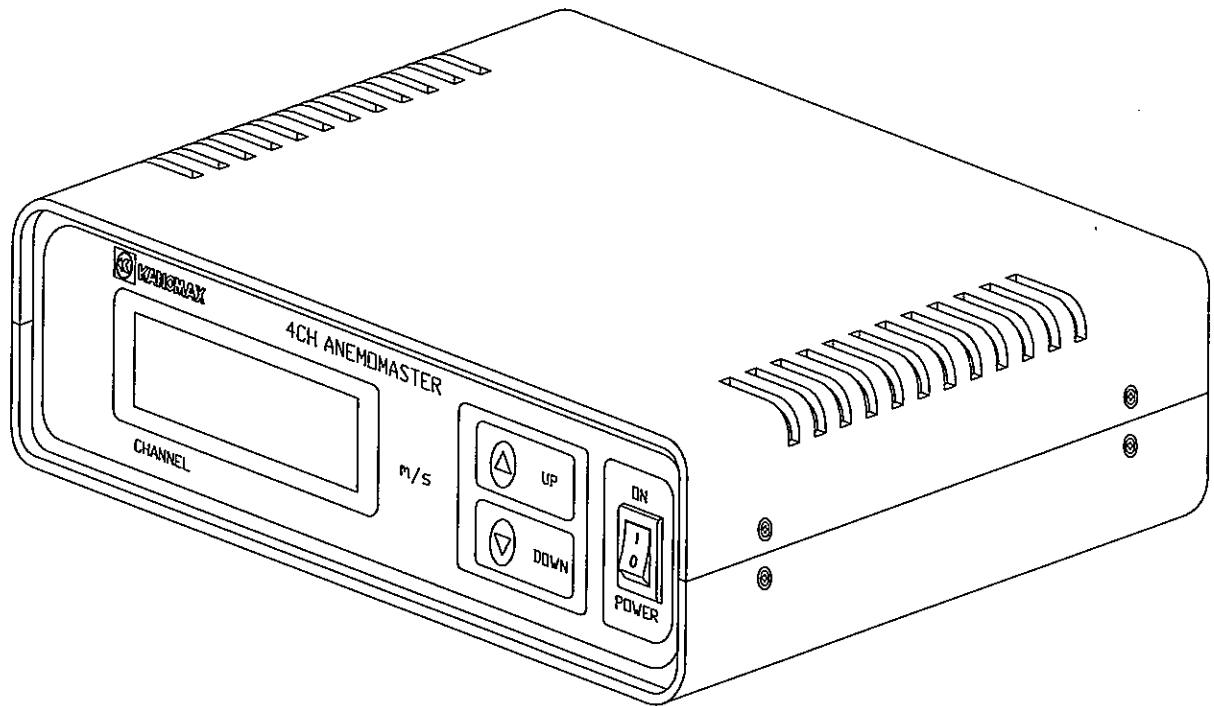

Read carefully and understand the warnings described in the main text
of the manual before using this instrument.

Please keep this manual in a safe place
so you can refer to it at any time.

Kanomax Japan, Inc.

2-1 Shimizu, Suita-Shi, Osaka-Fu 565-0805, Japan

TEL: +81-6-6877-8261

FAX: +81-6-6877-6849



01001

03.06

No. 624401

Thank you for purchasing this Kanomax product.

Please use this instrument properly by following the warning instructions and reading the instruction manual.

Safety Precautions

PLEASE READ CAREFULLY BEFORE PROCEEDING

These precautions explain how to use the device correctly and safely, thereby preventing injury to yourself or to others. This section has been sub-divided into a **WARNING** section and a **CAUTION** section, according to the likelihood and nature of any potential injuries or damage inflicted. They relate to your personal safety, and also help you minimize the risk of damaging the device. Please read these sections carefully before proceeding.



WARNING

Always follow the basic precautions listed below to avoid the possibility of serious injury or even death from electrical shock, short-circuiting, damages, fire or other hazards. These precautions include, but are not limited to, the following:

- Do not install the probe in an area where flammable gas is present. Otherwise, there is an increased risk of fire or even explosion.

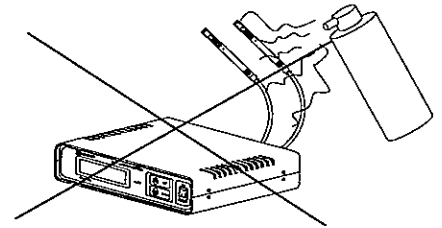

- Do not open the device or attempt to disassemble or modify it. Otherwise, there is an increased risk of electrical shock or fire. The device contains no user-serviceable parts. If it appears to be malfunctioning, have it inspected by qualified service personnel.

- Do not insert fingers or foreign objects into the device. Otherwise, there is an increased risk of personal injury (such as burning yourself), electrical shock, and damage to the device or fire. Please take particular care if small children are present.

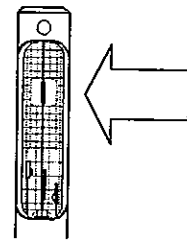

- Do not expose the device to rain, use it near water or in damp or wet conditions or place containers on it that contain liquids which might spill into any openings. Otherwise, there is an increased risk of electrical shock, fire or personal injury.

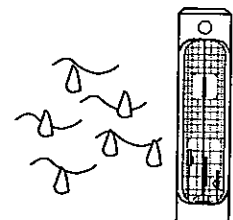

- Follow the Operation Manual carefully. Otherwise, there is an increased risk of personal injury, electrical shock, fire or damage to the unit. Follow the correct procedure when setting up the device.
- If unusual smells, sounds or smoke emanate from the device or if liquids enter the device, switch the device off immediately and take out the batteries and/or unplug it from the power outlet. Otherwise, there is an increased risk of electrical shock, fire or damage to the device. Return the device immediately to nearest Kanomax Office or to the Service Center in Osaka, Japan.



CAUTION

Always follow the basic precautions listed below to avoid the possibility of physical injury to yourself or others, or damage to the instrument or other property. These precautions include, but are not limited to, the following:

- Always unplug the anemometer from the electrical outlet if it will not be used for a prolonged period time or if there is a risk of lightning.
Otherwise, there is an increased risk of electrical shock, short-circuiting or fire.
- Always take out the batteries before storing.
Otherwise, there is an increased risk of leakage.
- Do not leave exhausted batteries in the unit.
Otherwise, there is an increased risk of leakage.
- Do not expose the device to excessive heat or vibrations or extreme cold or heat (such as in direct sun light or near heater).
Otherwise, the main body may become disfigured or the internal components may be damaged and no longer function properly.
- When cleaning the device, never use benzene, paint thinners, detergents or chemical-impregnated wiping cloths. Also, do not place vinyl, plastic or rubber objects on the device.
Otherwise, the device may be damaged or its main body may become discolored or disfigured. Use a soft, dry cloth to wipe the device.
- Do not impact the device by resting your weight on or placing heavy objects on the device; do not use excessive force on the buttons, switches or connectors.
Otherwise, there is an increased risk of damage to the device or personal injury.
- Have the device serviced regularly.
Otherwise, there is an increased risk of not maintaining the accuracy. For information about servicing charges, contact your nearest Kanomax Office or Kanomax Service Center in Osaka, Japan. The device should be serviced about once a year.

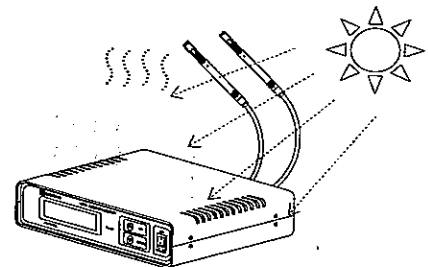

The sensor is very sensitive to electrostatic. Please handle with care.

Table of Contents

1. Name of Parts and Function	1
2. Getting Ready to Measure	2
2.1 System Configuration	2
2.2 Attaching/Removing Special ROM	3
2.3 Probe Connection and Output Setup	4
2.3.1 Assigning Probe Number	4
2.3.2 Connecting Cable	4
2.3.3 Connecting Probe	5
2.3.4 Output Setup	5
2.4 Connecting Analog Output Terminal	6
3. Measuring	7
3.1 Turning on the Power	7
3.1.1 Operating Main Body Power Source	7
3.1.2 Probe Setup	7
4. RS232C Data Transmission	8
4.1 Summary of Data Transfer	8
4.2 Output Connector	9
4.3 Explanation of Measurement Mode	9
4.4 Output Format (1) Burst Mode	10
4.5 Output Format (2) Channel Mode	10
4.6 Data Collection Timing Chart	10
4.7 Explanation of Commands	12
4.8 Return Code	14
5. Cleaning the Probe	15
6. Main Specifications	16
6.1 Main Body Specifications	16
6.2 Probe Specifications	17
7. Principle of Measurement	18
7.1 Principle of Thermal Anemometers	18
8. About Compensation	19
8.1 Influence of Measuring Temperature	19
8.2 Influence of Pressure at Measurement Point	19
8.3 Measuring Gas Components	19
9. Trouble-shooting	20
10. Warranty and After Service	21

1. Name of Parts and Function

Unit : mm

*Outer Panel Area

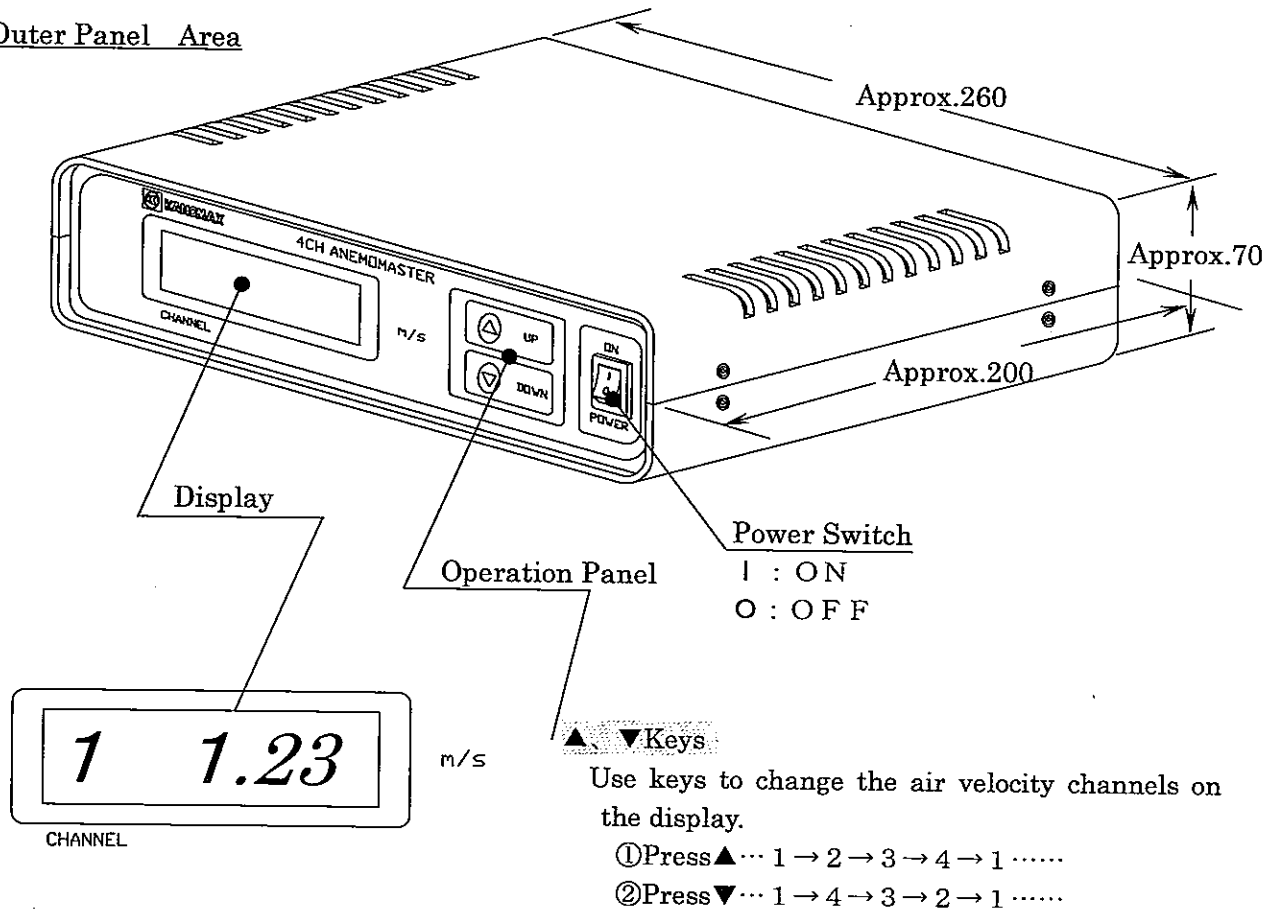

*Inner Panel Area

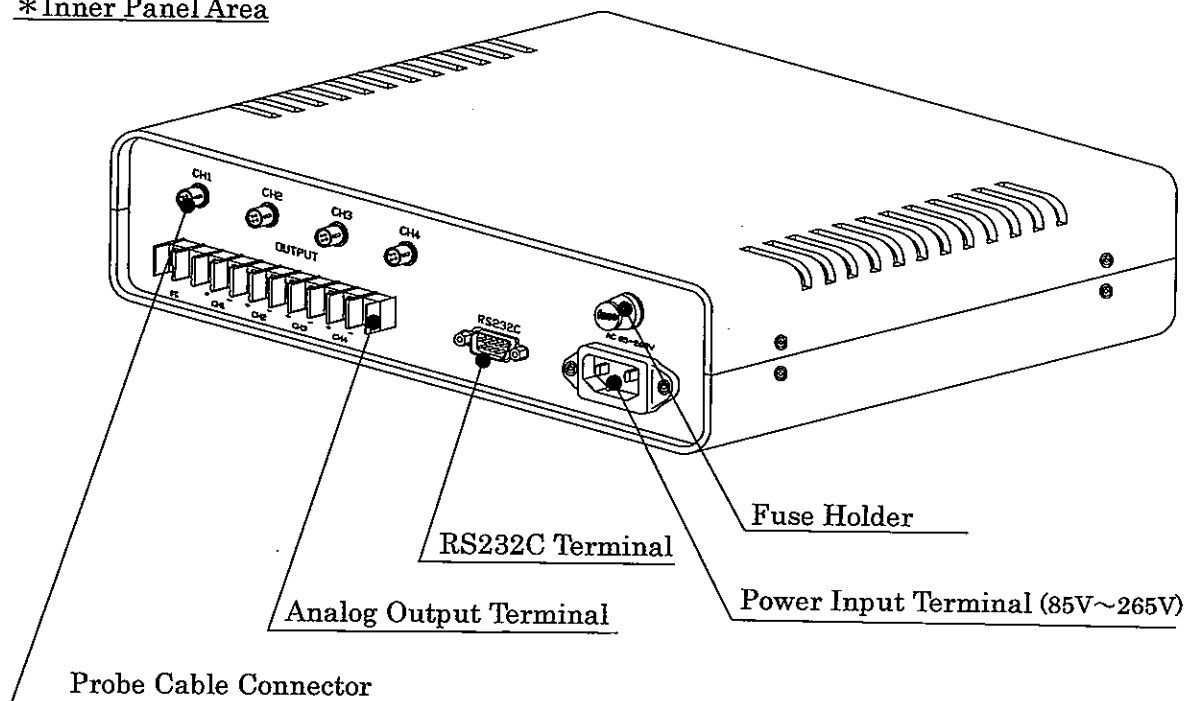

2. Getting Ready to Measure

2. 1 System Configuration

① Main Body

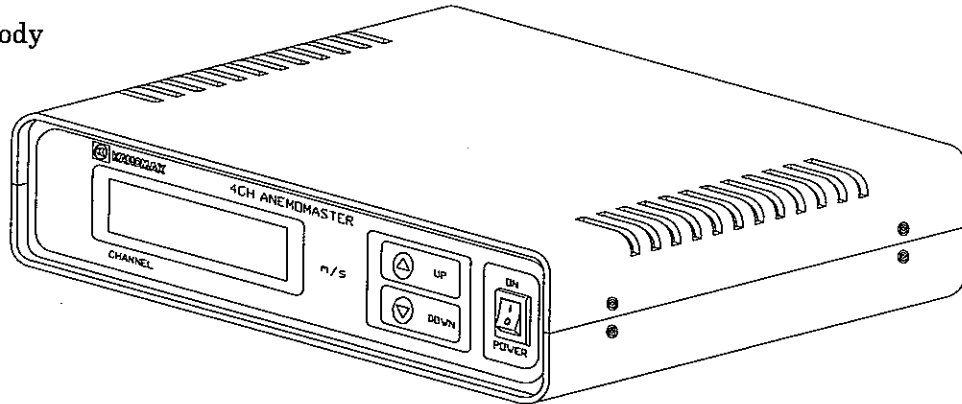

② Probe Cable (Sold Separately)

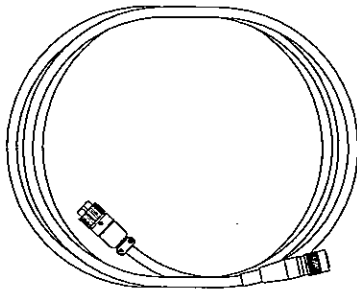

Types of Probe Cable

MODEL 1504-04...10m Cable (32feet)

MODEL 1504-05...20m Cable (65feet)

MODEL 1504-06...30m Cable (98feet)

Confirm the correct length depending on the use and application.

② Probe (Sold Separately)

Probes

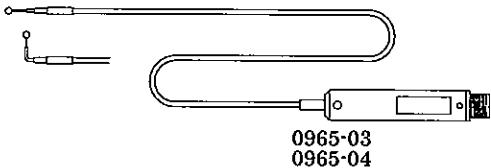
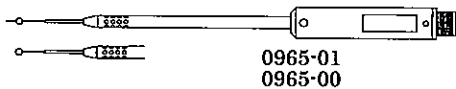
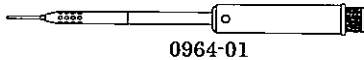
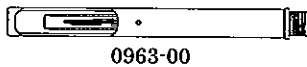
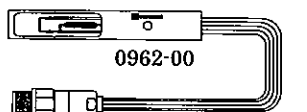

Special ROM

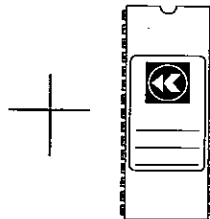

Probe Number Sticker (3 sheets)

* The probe and ROM are a unique pair. The probe characteristics are different for each probe and the characteristics are programmed in the ROM. When attaching the ROM to the Main Body, you must always confirm that the probe number indicated on the ROM is the same with probe number.

2. 2 Attaching / Removing Special ROM

1. Remove the top panel of the Main Body upwards, by removing the 4 screws ①.

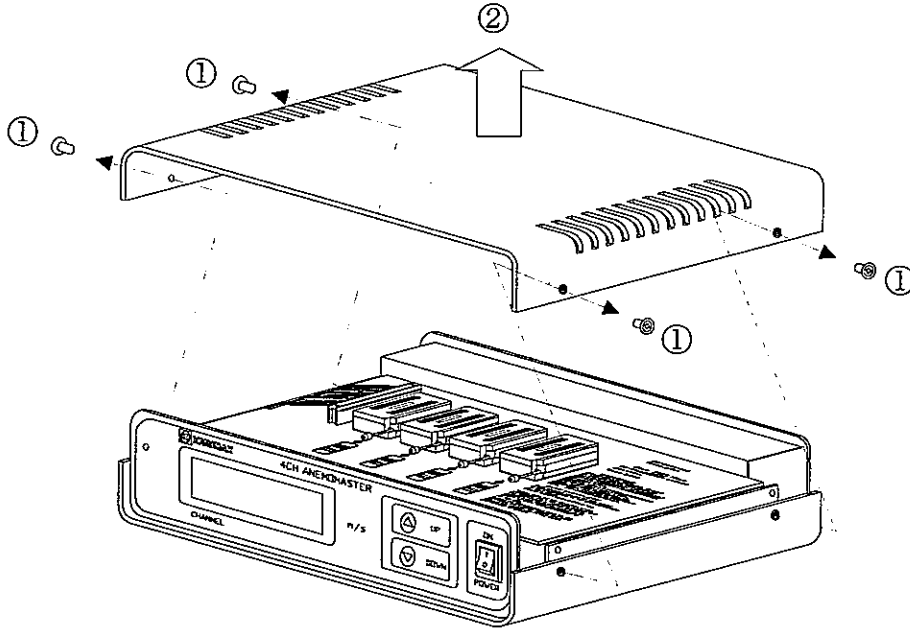

2. Attach the Special ROM into the ROM Socket.

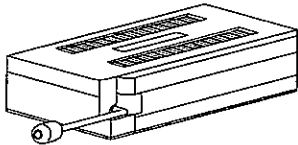

- ①The internal ROM socket has a lever that is pulled down as shown in the left figure.

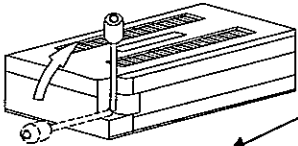

- ②Pull up the lever as shown.

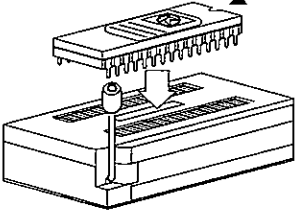

Confirm probe number and the direction (orientation) of the ROM when installing. Otherwise, it will lead to damage.

- ③When attaching the ROM, be careful to set in the correct orientation. Also, make sure that you do not bend the legs of the ROM when inserting into each socket.

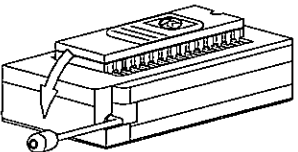

- ④After inserting the ROM, pull the lever down to fix the ROM in place. If you need to remove the ROM, pull the lever up.

3. After mounting the ROM, attach the probe number sticker onto the inner side of the main body panel. (Refer to section "Assigning Probe Number" of this manual.)

2. 3 Probe Connection and Output Setup

2.3.1 Assigning Probe Number

There are 3 sheets of probe number stickers for each probe. Adhere the stickers as shown in the areas below.

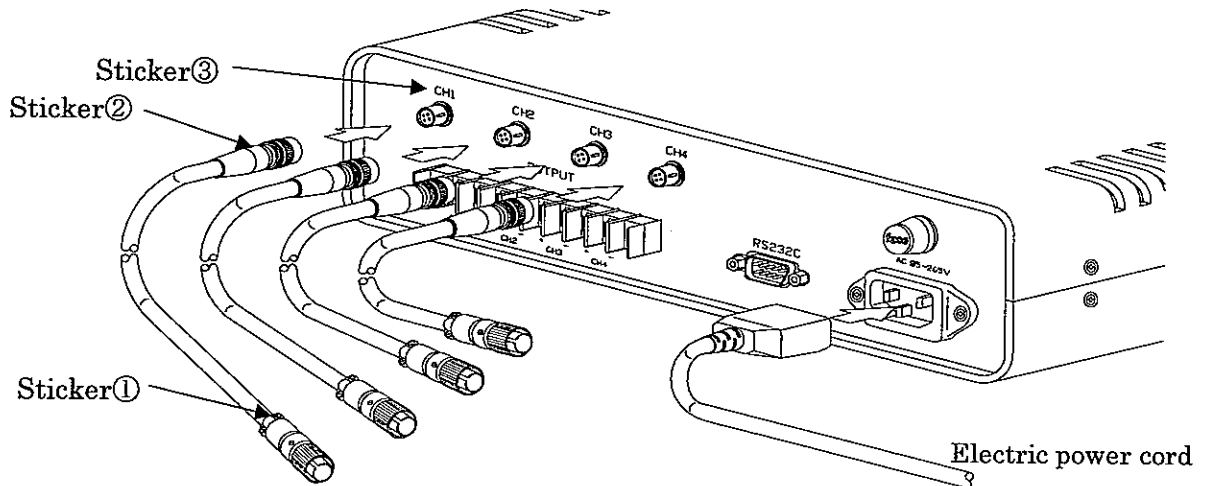

*The adhesiveness of the sticker decreases once you apply it and then peel it off. Please confirm correct area before applying.

* Confirm that the sticker and the probe number on the Special ROM matches.

2.3.2 Connecting Cable

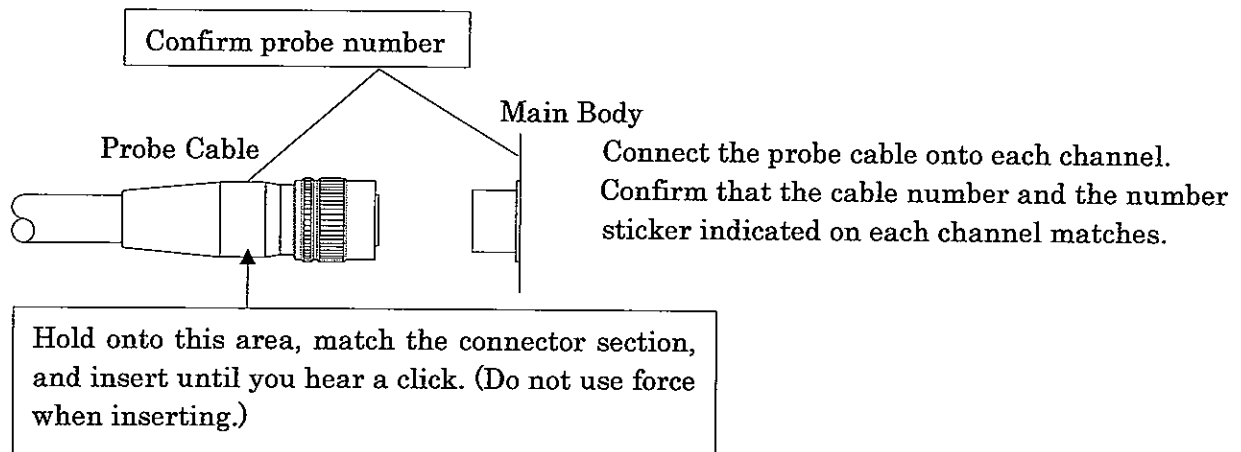

Connect the probe cable onto each channel.
Confirm that the cable number and the number sticker indicated on each channel matches.

2.3.3 Connecting Probe

Match the areas where the probe specifically connects to the main body(①). Twist the probe into the socket(②) and affix the probe.

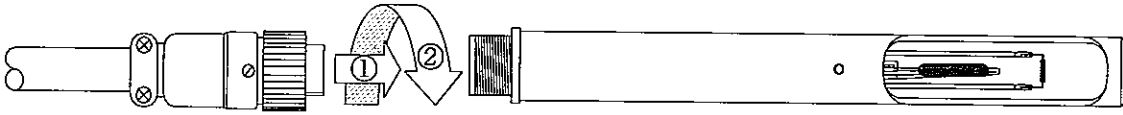

(0963-00)

When connecting the probe, always turn the power off on the main body. Otherwise, the probe might burn and the characteristics might change, or the sensor might get severed.

If the probe is not firmly twisted into the socket, the probe may get damaged due to bad connection.

2.3.4 Output Setup

Output volt: 0-5V

The output volt setup is different depending on the specifications of each probe.

The output volt is designed so that there will be constant output regardless of whether you are in the middle of doing digital transmission with the external environment.

* 50m/sec (9840fpm) specification probe: the probe switch needs to be set at 50m/s

Output range 0-50m/s (conversion formula: Air Velocity m/s = 10 × Volt)

* 25m/sec (4920fpm) specification probe : the probe switch needs to be set at 25m/s

Output range 0-25m/s (conversion formula: Air Velocity m/s = 5 × Volt)

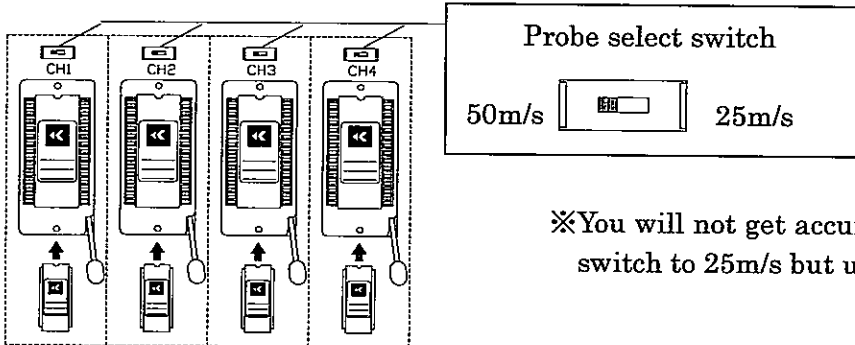

※You will not get accurate results if you switch the probe switch to 25m/s but use a probe for 50m/s specifications.

Probe with 50m/s(9840fpm) Specification	Probe with 25m/s(4920fpm) Specification
<p>0962-00</p> <p>0963-00</p> <p>0964-01</p> <p>0964-02</p>	<p>0965-00</p> <p>0965-01</p> <p>0965-03</p> <p>0965-04</p>

2. 4 Connecting Analog Output Terminal

You can get analog outputs, each corresponding to the probe connection channel number. Connect each of them to the Output Terminal Stand on the inner side of the main body panel.

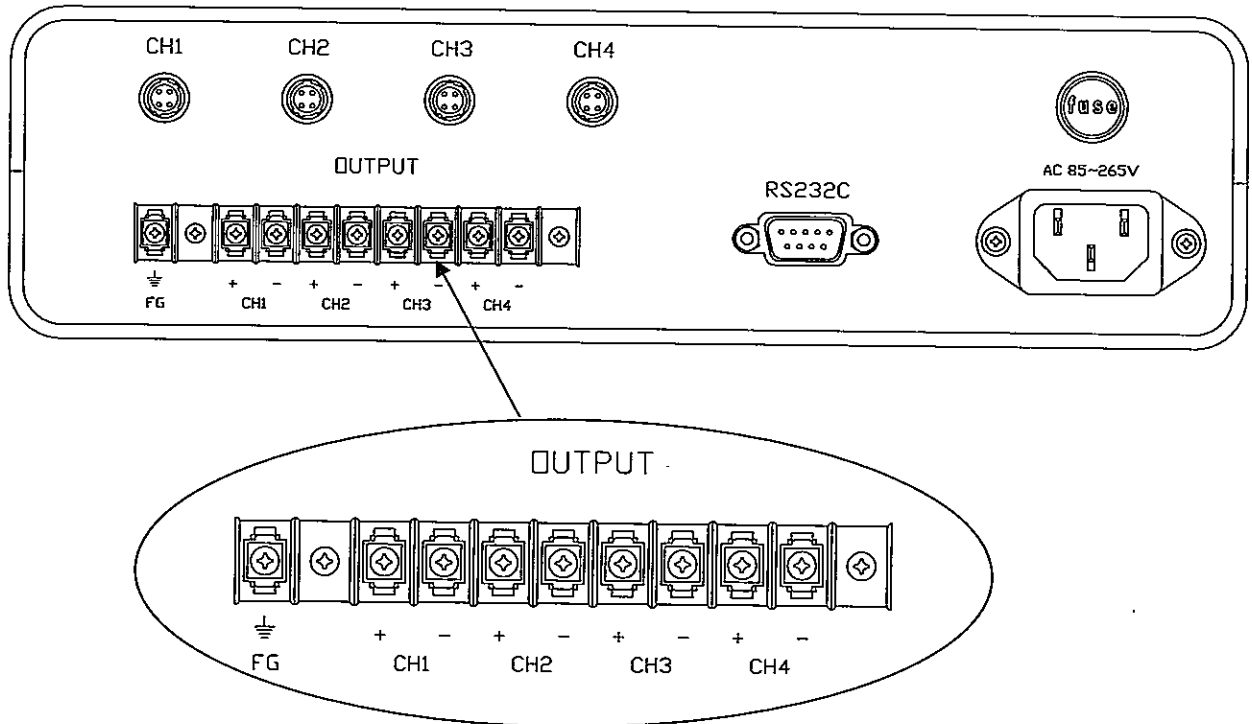

* On the + terminal, connect the positive (+) side of the equipment you want to connect. On the - terminal, connect the negative (-) side of the equipment you want to connect.

3. Measuring

3. 1 Turning on the Power

3.1.1 Operating Main Body Power Source

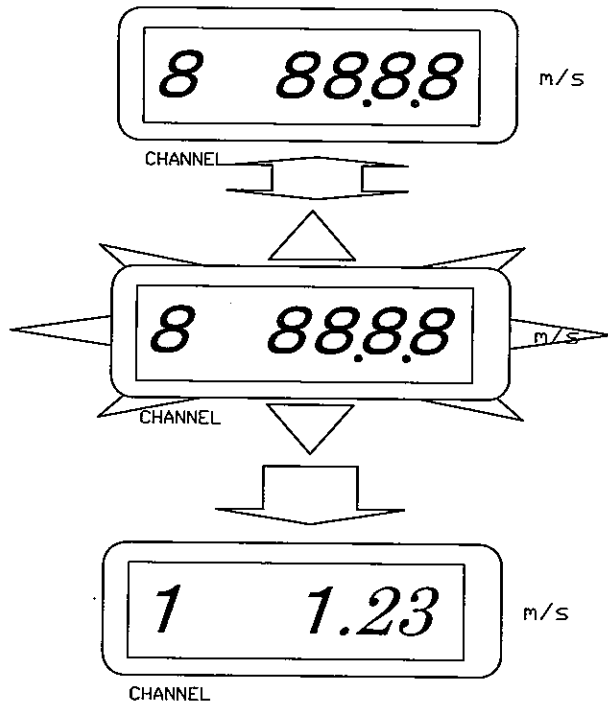
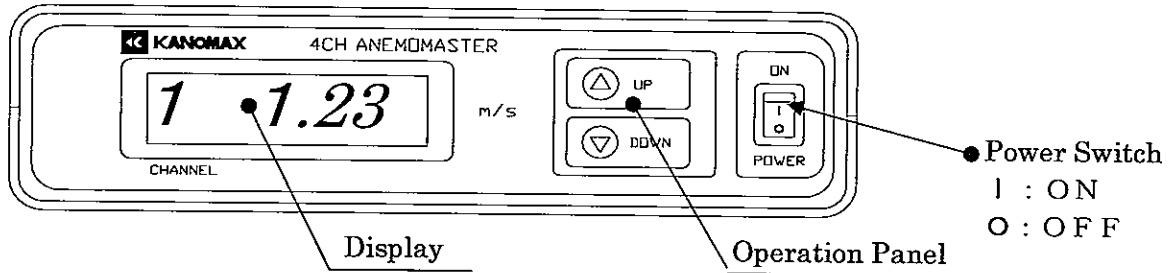

1. Turn the switch on when you have finished the preparation for measurements.
2. When you turn on the switch, the version of the firmware will be displayed for a few seconds.
3. After the version display, a display as on the left will flicker for a few seconds.
4. After flickering, you will get the normal measurement screen.
5. By pressing UP or DOWN on the operation panel during measurement, you can switch display channels.

3.1.2 Probe Setup

- * You must direct the wind direction mark on the probe facing the wind. (Sphere shaped sensors / needle shaped sensors have no orientation and measure 360 degrees horizontally, but calibration is done with the wind direction mark as the reference point.)
- * By combining the air velocity sensor and the temperature compensation sensor, the probe adjusts for the change in air velocity changes caused by air temperature change. In order to get this effect, both the air velocity sensor and the temperature compensation sensor needs to be placed in the same wind, to make the temperature condition the same.
- * When you are using the probe to measure air velocity where the air temperature rapidly changes, measure the air velocity for over 20 seconds and read the measurements when the readings stabilize.

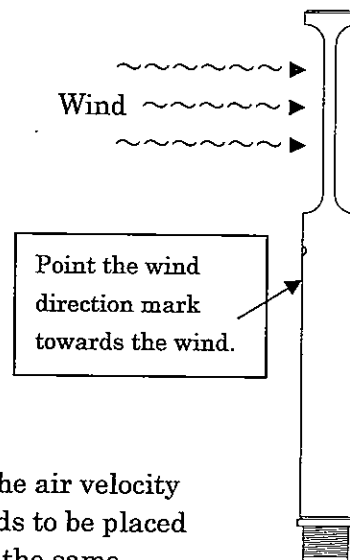

4. RS-232C Data Transmission

4. 1 Summary of Data Transfer

- * Display shows [— — — —] and you cannot operate keys during Remote
- * You need a transmission software to do data transfer.
- * The baud rate for the 4CH Anemometer is fixed at 9600bps.
 Confirm the baud rate setup of the computer.
 If the baud rate for the computer is not the same, you cannot communicate.
 During transmission, you will get an error code in response.
 Also confirm the data length, parity, stop bit in the same manner.

◆ Setup of Output Format

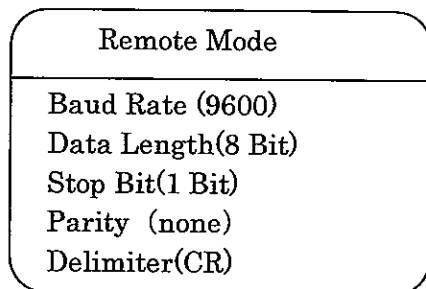

☆ Remote Mode
 Transmitting Data

◆ Chosing the Measurement Mode

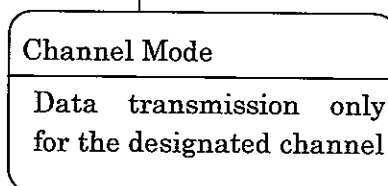
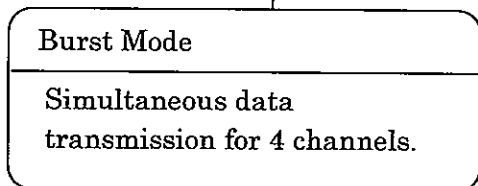

◆ Data Selection

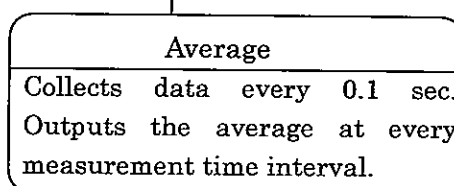
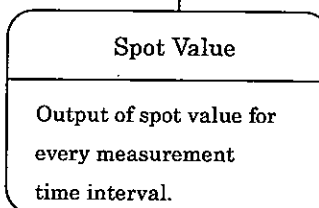
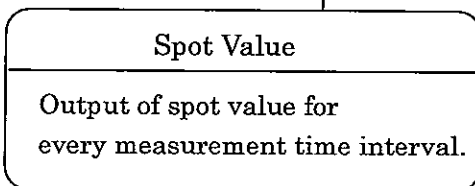

◆ Setup of Measurement Conditions

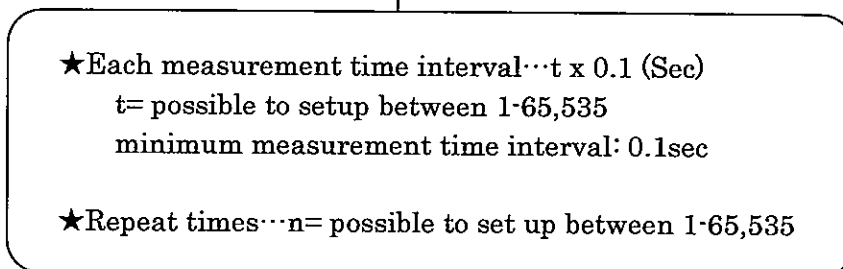

◆ Measurement Start

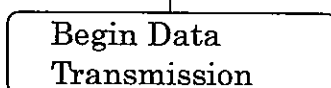

4. 2 Output Connector

< Connecting the Computer and the Main Body (4CH Anemomaster) >

① Connect the Main Body(RS-232C Terminal) and the computer with the standard cross cable. (Refer below.)

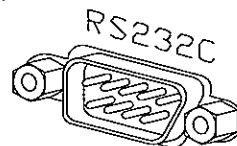

② Signal Terminal Chart

Below is the RS232C Connector wiring chart for the 4CH Anemomaster.

Computer (D-Sub9 pin)		Standard Cross Cable (General Market Product)			4CH Anemomaster Main Body (D-Sub9 pin)				
Signal Name	Pin#	Pin#	Wiring connection	Pin#	Pin#	Internal Connection	Signal Name	Meaning of Signal	Direction of Signal
NC	1	1		1	1		NC		
RXD	2	2		2	2	RXD	RXD	Data Sent	Output
TXD	3	3		3	3	TXD	TXD	Data Received	Input
DTR	4	4		4	4		NC		
GND	5	5		5	5	GND	GND	Ground Signal	
DSR	6	6		6	6		NC		
RTS	7	7		7	7	RTS	RTS	Request for Data Send	Output
CTS	8	8		8	8	CTS	CTS	Permission For Data Receive	Input
NC	9	9		9	9		NC		

4. 3 Explanation of Measurement Mode

Burst Mode

- ◇ Outputs the spot data for the 4 CH at each designated time interval.
- ◇ Simultaneously outputs data of all 4 channels.

★ Each measurement time interval... $t \times 0.1$ (Sec)

t = possible to setup between 1-65,500

★ minimum setup measurement time interval: transmits every 0.1sec

Channel Mode

- ◇ Designate the range of channels you want to output.
For example, it is possible to designate CH1-CH12 and command output.

- ◇ The Measurement Time Interval, similar to the burst mode, is constant regardless of the number of channels(CH) you designate.

(= $t \times 0.1$ sec. t : 1- 65,500)

For the data transmission, there is a spot value mode and the average mode.

Average Mode

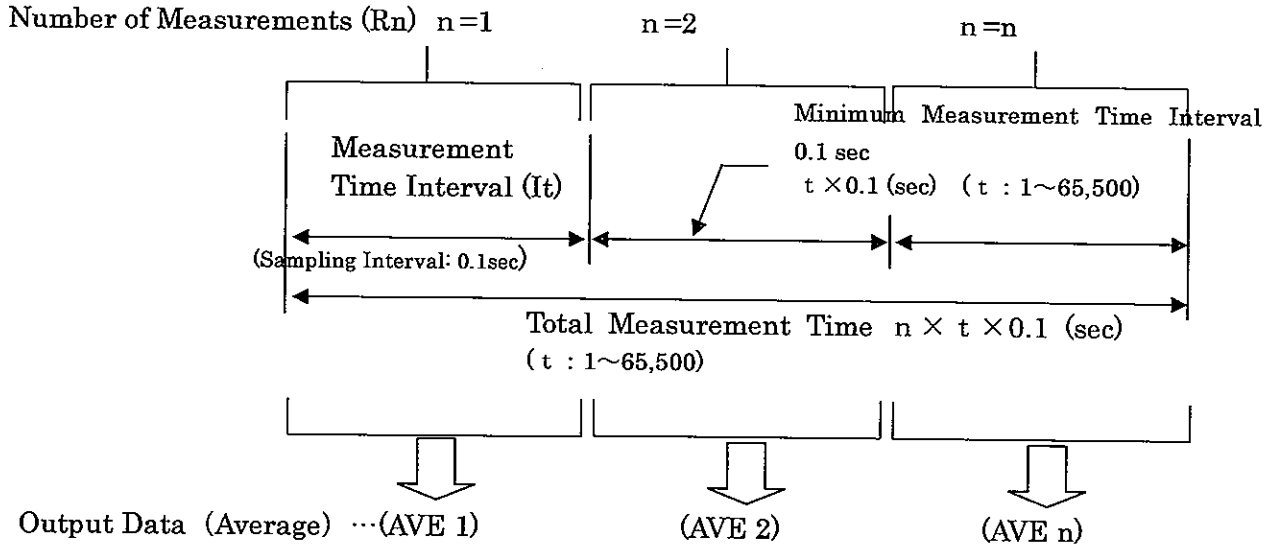

★Data will be collected every 0.1 second at the designated CH, and will output the average at every measurement time interval.

Example ... When the measurement time interval is 10 seconds, data will be collected 100 times (every 0.1second) and the average of the 100 data will be output every 10 seconds.

★The minimum measurement time interval is 0.1 seconds, but when you set it up at 0.1 second, the data collection time is only once, and is the same as the spot value.

4. 7 Explanation of Commands

Remote Mode

Function	Command	Explanation
Execute Remote (OPEN)	@(CR)	<p>Will switch to the transmission state (remote mode).</p> <p>* [— — — —] will be displayed and the keys cannot be operated during remote mode.</p> <p>The following 2 commands will be returned to you after transmission.</p> <p style="text-align: center;"> <u>@1(CR)</u> <u>@1(CR)</u> ↙ OK </p> <p>When you get no response, resend. If you still get no response, there is a possibility of transmission error.</p>
Deactivate close (CLOSE)	L(CR)	<p>Will return to the original measurement display (local mode).</p> <p>The receipt of the transmission command will be completed and you will be able to operate the keys.</p> <p>When you end remote, the setup up value will be renewed.</p> <p>You must do measurement setup for the next remote operation.</p>

Start Measurement

Function	Command	Explanation			
Start Measurement	S(CR)	<p>Measurement will start, and there will be an output of the measurement value.</p> <p>You need to set up the output mode, number of measurements, measurement time, interval. If you do not set them up, the measurement will start using the following default values.</p> <p>Default setup...</p> <table border="1" style="margin-left: auto; margin-right: auto;"> <tr> <td>Output mode: Burst mode</td> </tr> <tr> <td>Number of measurement: 1</td> </tr> <tr> <td>Measurement Interval: 0.1sec.</td> </tr> </table>	Output mode: Burst mode	Number of measurement: 1	Measurement Interval: 0.1sec.
Output mode: Burst mode					
Number of measurement: 1					
Measurement Interval: 0.1sec.					
Stop Measurement	Q(CR)	<p>Measurement will stop.</p> <p>However, the setup is saved.</p> <p>When you restart measurement, it will be considered as the first measurement.</p>			

Selecting the Measurement Mode

Function		Command	Explanation
Burst Mode	Select Burst Mode	B(CR)	The data of 4CH will be output simultaneously.
	End Selection	H×(CR)	You can select the end channel when you are in the burst mode. [Example] <u>H2</u> It will stop at the 2 nd channel (2CH). (1~4CH)

Function		Command	Explanation
Channel	Select Channel Mode	C(CR)	Data will be output only for the selected channel.(1~4CH)
	Select Range	U1×-×(CR)	Select range of the channels to output. [Example] <u>U11-3</u> Outputs CH1~CH3.
	Clear	X(CR)	The channel selection will be initialized. (U11-1) When selecting range, you must send this command first and then specify range. [Example] X(CR) U11-3(CR)

Data Selection

Function	Command	Explanation
Average Value Mode	M(CR)	Only valid for channel mode. ◆ Collects data every 0.1 seconds, and averages the data at every interval and outputs the results.
Spot Value Mode	N(CR)	Valid for both burst mode and channel mode. ◆ Output will be done at the measurement time interval that was set up. The data is spot value.

Measurement Conditions Setup

Function	Command	Explanation
Number of Measurement	Rn(CR)	<p>Sets up the number of times to repeat measurements. (1~4CH) × n times</p> <p>Possible Setup Range : 1-65,500 times [Example] R12 means repeating measurements 12 times.</p>
Setup of Measurement Time Intervals	It(CR)	<p>Sets up how often(seconds) you want to measure. The minimum interval possible to setup is 0.1 seconds.</p> <p>Minimum interval possible to set up ... t × 0.1(sec) (t = Possible to set up in the range of 1-65,500)</p> <p>[Example] I10 means there will be an output every second. ↙ 10 × 0.1sec</p> <p>The total measurement time is (n × t × 0.1) seconds</p>

* When you are doing setup using more than 2 commands, you can use “ ; ” (semicolon).

Example) C ; I 5 0 ; R 2 0 0 ; S (CR)

The number of characters that this 4CH Anemomaster can receive continuously is 20. Remote command “@” needs to be used independently.

It is not possible to make it receive further commands after the Measurement Start command “S”, and the Remote stop command “L”

When there is an error in the receiving command, it will give you an error code.

4. 8 Return Code

	Return Code	Explanation
①	@ 1 (CR)	You get this code only when you executed the remote command(@) and signifies the transmission was done correctly.
②	E (CR)	You get this when the command you received has an error. Command will not be executed.
③	A (CR)	Signifies that all commands were received correctly. This does not apply for the remote command (@).
④	/ (CR)	When you finish sending all the measurement data (per the designated number of measurements), this return code will appear after transmitting the final measurement data.
⑤	F / (CR)	You will get this code when the data receipt buffer (equivalent to 1000 data) in the main body is full.

5. Cleaning the Probe

Dust or particles attached on the velocity sensor would alter the amount of heat diffusion, which leads to less precise reading. Also, deformation or clogging up of the protective mesh around the sensor of 4CH ANEMOMASTER would also affect the accuracy of the instrument.

Users are encouraged to clean up Probe regularly for maintaining accurate measurement.

Procedure

Clean the sensor by soaking it to water in ultrasonic cleaner for 10 to 20 seconds. Do not soak it for too long, since there is an increased risk of damaging the coating. Please use water only for cleaning. You can also put cleaning agent in a container, and gently sway-wash the probe.

! CAUTION !

- !)When cleaning, make sure that the power is OFF.
- !)Make sure that the sensor is completely dry before turning it ON.
- !)DO NOT let the humidity sensor contact water. When wet, let it air dry by placing it in environment with less than 40%RH for more than 24 hours.
- !)NEVER USE alcohol or any other organic fluid.
Alcohol causes a permanent damage to the humidity sensor.
Once the sensor is damaged, the sensor needs to be replaced even if it seems functioning..

6. Main Specifications

MAIN BODY

Product Name	4CH Anemomaster
Model Name	1570 (SYSTEM 6244)
Operational Condition	Clean airflow
Display Resolution	Air Velocity 0~9.99m/s (1966fpm)0.01 m/s (2fpm) over 10m/s (1968fpm)0.1 m/s (20fpm)
Display	LDC Display
Function	<ul style="list-style-type: none"> ◆ Display : UP, DOWN switch allows channel display changes. ◆ Measurement Mode <ul style="list-style-type: none"> : Burst mode: Transmits all channel data : Channel mode: Transmits data of the designated channel only ◆ Data Selection <ul style="list-style-type: none"> : Spot value mode: Outputs at every designated interval : Average value mode: outputs the average of every designated interval * During remote control ,it displays as "-----",not display data. * Repeat times: 1-65,500 times * Measurement time interval: 0.1 sec × t (t: 1-65,500)
Interface	Data Transfer : RS-232C, Baud Rate : 9600bps
Main Body Ambient Temperature	5~40°C (41 to 104° F)
Outer Dimensions	D200mm (8") × W230mm (9") × H70 mm (2.7")
Weight	Approx. 2.6 kg (910 oz)
Power Supply	AC85V~265V
Accessories	Operation manual (1), RS232C cable (1), Power cable (1), Fuse (2)

PROBE

Measurement range and measurement accuracy	MODEL 0962-00 0963-00	<ul style="list-style-type: none"> • 0.1~4.99m/s :±0.1 m/s (19.7~982fpm: ±20fpm) • 5.00~9.99m/s :±0.2 m/s (984~1966fpm: ±39fpm) • 10.0~24.9m/s :±0.5 m/s (1968~4900fpm: ±98fpm) • 25.0~50.0m/s :±1.0 m/s (4920~9840fpm: ±197fpm) 	Sensor with directivity
	MODEL 0964-01 0964-02	<ul style="list-style-type: none"> • 0.1~4.99m/s :±0.15 m/s (19.7~982fpm: ±30fpm) • 5.00~9.99m/s :±0.3 m/s (984~1966fpm: ±59fpm) • 10.0~24.9m/s :±0.75 m/s (1968~4900fpm: ±148fpm) • 25.0~50.0m/s :±1.5 m/s (4920~9840fpm: ±295fpm) 	Sensor with no directivity(Needle shaped) Horizontal Characteristics : ±5%FS
	MODEL 0965-00 0965-01 0965-03 0965-04	<ul style="list-style-type: none"> • 0.1~4.99m/s :±0.15 m/s (19.7~982fpm: ±30fpm) • 5.00~9.99m/s :±0.3 m/s (984~1966fpm: ±59fpm) • 10.0~25.0m/s :±0.6 m/s (1968~4900fpm: ±118fpm) 	Non-directivity sensor (sphere shaped) Horizontal characteristics: +/-3%FS (360 degrees) Vertical characteristics: +/-3%FS (elevation angle: 0 +/-40degrees) ··MODEL 0965-00 Vertical characteristics: +/-3%FS (elevation angle: 0 +/-20 degrees) ··MODEL 0965-03,04,07,08
Responsiveness	90% responsiveness at air velocity 1m/sec(197fpm) 0962-00 / 0963-00 approx 1 sec 0964-01 / 0964-02 approx 3 sec 0965-00 / 01 / 03 / 04 / 07 / 08 approx 7 sec		
Temperature Compensation Accuracy	5~40°C (41 to 104° F) ...±5%FS 40~80°C (104 to 176° F) ...±7%FS		

7. Principle of Measurement

Principle of Thermal Anemometers

The principle of the thermal Probe is based on a heated element from which heat is extracted by the colder impact flow. The temperature is kept constant via a regulating switch. The controlling current is directly proportional to the velocity. When thermal velocity Probes are used in turbulent flows, the measured

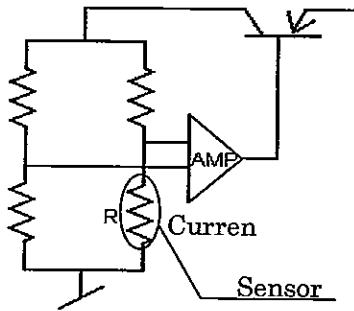
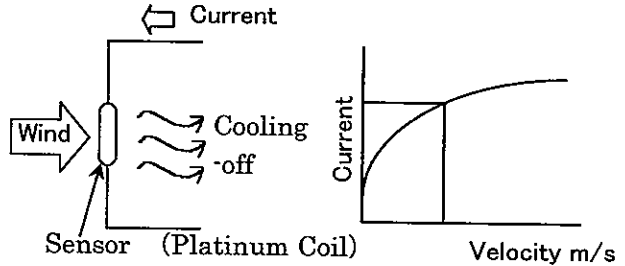

result is

influenced by the flows impacting the heated body from all directions.

In turbulent flows, a thermal velocity sensor indicates higher measured values than a vane Probe. This can be observed during measurements in ducts. Depending on the design of the duct, turbulent flows can occur even at low velocities. The amount of heat that is extracted by the colder impact flow from the sensor can be expressed by:

$$H = (a + b\sqrt{U})(T - Ta) \quad \dots \text{King's formula}$$

Where H: Heat diffusion quantity T: Temperature of the sensor Ta: Air temperature U: Air velocity a, b: Constant

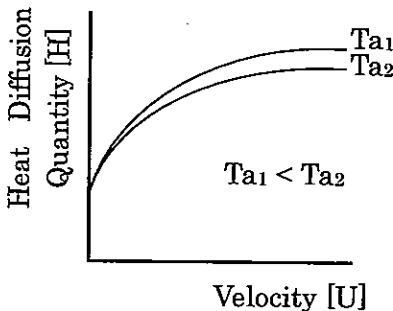

Also, heat diffusion quantity can be expressed by the formula:

$$H = RI^2$$

Where R is resistance and I is current (R is kept constant regardless of air velocity since the temperature is constant).

Therefore, $RI^2 \propto a + b\sqrt{U}$

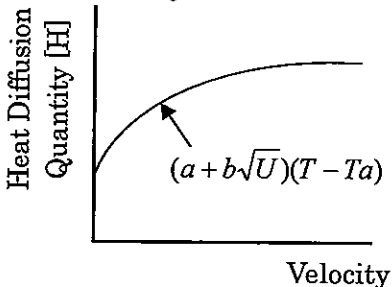

The Temperature Compensation

The air velocity sensor is heated to an elevated temperature relative to the surrounding air by means of control electronics. The temperature compensation sensor senses the ambient, or surrounding air temperature and forces the velocity sensor to stay at a constant overheat above the ambient. The circuit forces the voltage to be equal by means of an operational amplifier. Air flowing past the sensor tends to cool the sensor, thus driving down its resistance. The amplifier responds by immediately delivering more power to the circuit to maintain voltage equilibrium. Delivered power is converted into electrical signal to display.

8. About Compensation

This instrument has been calibrated at normal temperature and pressure. Therefore, if you are going to measure velocity at a different temperature and pressure, the indicating value will be affected.

8. 1 Influence of Measuring Temperature

This instrument has been calibrated at normal temperature. Because of theoretical fundamentals of hot-wire anemometer, it can easily be effected by the ambient temperature. To prevent such influence, temperature compensation is needed. The temperature compensation sensor senses the ambient, or surrounding air temperature and forces the velocity sensor to stay at a constant overheat above the ambient. By adopting temperature compensation sensors, you can measure air velocity accurately within the range of 5~60°C (41~140°F)

8. 2 Influence of Pressure at Measuring Point

This instrument has been calibrated at 1013hPa. Change in pressure does affect the amount of heat diffusion. Therefore, the pressure compensation, using the following equation, is needed.

$$U_m = \frac{1013}{P_m} \times U_c$$

Where: U_m : Actual Velocity[m/s] U_c : Indicating Value P_m : Pressure at the Measuring Point [h P a]

8. 3 Measuring Gas Components

This instrument has been calibrated using air. The 4CH ANEMOMASTER indicates air velocity based on the heat capacity, i.e. the heat diffusion quantity to deprive a device of in fluid. If the fluid, which is dealt with for the measurement, is different from the fluid when the instrument is calibrated, the diffusion quantity changes and the indicating air velocity, too, will be affected. In order to compensate, you first need to find the heat diffusion quantity of air to the indicating value in mixture measurement. By substituting this heat diffusion quantity to the value in the heat diffusion-velocity relation formula, you can find the actual velocity value of the mixture.

9. Trouble—shooting

9. 1 Initial Operation

Problem	Possible Cause(s) / Solution(s)	Refer To (Page No.)
The power will not turn on.	Check the fuse holder on the back panel of the main body. The fuse might be severed.	1
	External plug might be plugged out.	1

9. 2 During Measurement

Problem	Possible Cause(s) / Solution(s)	Refer To (Page No.)
“- - - -” is displayed as measurement value.	You are in the remote mode. Deactivate the remote mode or turn the switch off and turn it on again.	8
“0000” is displayed as the measurement value.	Confirm if probe/ Probe cable is properly connected.	4, 5
	Probe/Probe cable is severed or the sensor is broken. Contact the store you purchased from and ask for repairs, exchanges.	—
	The special ROM may not be properly installed in the main body.	3
The air velocity measurement is no correct	The wind direction mark may not be correctly facing the wind. Make sure the mark points in the wind direction.	7
The measurement readings vary significantly.	The special ROM and the probe may not be matching.	2

9. 3 Confirming Digital Output

Problem	Possible Cause(s) / Solution(s)	Refer To (Page No.)
Cannot output the data to the connected equipment.	Cable may not be connected.	9
	Baud rate setup may be incorrect.	8
	Transmission command may be incorrect.	8

9. 4 Confirming Analog Output

Problem	Possible Cause(s) / Solution(s)	Refer To (Page No.)
No output	The plus/minus (+/-) of the output terminal may be wrong.	
Output value is different.	Analog output setup may be incorrect.	5
	The output range setup may be incorrect.	5
	Load Impedance is setup lower than the required level. (Load Impedance : Above 1kΩ)	—

10. Warranty and After Service

Kanomax Limited Warranty

The limited warranty set below is given by KANOMAX JAPAN, Inc. (hereafter referred to as "KJI") with respect to the KANOMAX brand anemometer, its attachment parts including Probe and other accessories (hereafter referred to as "PRODUCT") that you have purchased. PRODUCT you have purchased shall be the only one that the limited warranty stated herein applies to.

Your PRODUCT, when delivered to you in new condition in its original container, is warranted against defects in materials or workmanship as follows: for a period of one (1) year from the date of original purchase, defective parts or a defective PRODUCT returned to KJI, as applicable, and proven to be defective upon inspection, will be exchanged for a new or comparable rebuilt parts, or a refurbished PRODUCT as determined by KJI. Warranty for such replacements shall not extend the original warranty period of the defective PRODUCT.

This limited warranty covers all defects encountered in normal use of the PRODUCT, and does not apply to the following cases:

- (1) Use of parts or supplies other than the PRODUCT sold by KJI, which cause damage to the PRODUCT or cause abnormally frequent service calls or service problems.
- (2) If any PRODUCT has its serial number or date altered or removed.
- (3) Loss of damage to the PRODUCT due to abuse, mishandling, improper packaging by the owner, alteration, accident, electrical current fluctuations, failure to follow operating, maintenance or environmental instructions prescribed in the PRODUCT's instruction manual provided by KJI, or service performed by other than KJI.

NO IMPLIED WARRANTY, INCLUDING ANY IMPLIED WARRANTY OF MERCHANTABILITY OR FITNESS FOR A PARTICULAR PURPOSE, APPLIES TO THE PRODUCT AFTER THE APPLICABLE PERIOD OF THE EXPRESS LIMITED WARRANTY STATED ABOVE, AND NO OTHER EXPRESS WARRANTY OR GUARANTY, EXCEPT AS MENTIONED ABOVE, GIVEN BY ANY PERSON OR ENTITY WITH RESPECT TO THE PRODUCT SHALL BIND KJI. KJI SHALL NOT BE LIABLE FOR LOSS OF STORAGE CHARGES, LOSS OR CORRUPTION OF DATA, OR ANY OTHER SPECIAL, INCIDENTAL OR CONSEQUENTIAL DAMAGES CAUSED BY THE USE OR MISUSE OF, OR INABILITY TO USE, THE PRODUCT, REGARDLESS OF THE LEGAL THEORY ON WHICH THE CLAIM IS BASED, AND EVEN IF KJI HAS BEEN ADVISED OF THE POSSIBILITY OF SUCH DAMAGES. IN NO EVENT SHALL RECOVERY OF ANY KIND AGAINST KJI BE GREATER IN AMOUNT THAN THE PURCHASE PRICE OF THE PRODUCT SOLD BY KJI AND CAUSING THE ALLEGED DAMAGE. WITHOUT LIMITING THE FOREGOING, THE OWNER ASSUMES ALL RISK AND LIABILITY FOR LOSS, DAMAGE OF, OR INJURY TO THE OWNER AND THE OWNER'S PROPERTY AND TO OTHERS AND THEIR PROPERTY ARISING OUT OF USE OR MISUSE OF, OR INABILITY TO USE, THE PRODUCT NOT CAUSED DIRECTLY BY THE NEGLIGENCE OF KJI. THIS LIMITED WARRANTY SHALL NOT EXTEND TO ANYONE OTHER THAN THE ORIGINAL PURCHASER OF THE PRODUCT, OR THE PERSON FOR WHOM IT WAS PURCHASED AS A GIFT, AND STATES THE PURCHASER'S EXCLUSIVE REMEDY.

After Service

Whenever the PRODUCT is malfunctioning, please check with "Troubleshooting" to find possible cause first.

Repair parts are retained for a minimum period of five (5) years after production cessation of the PRODUCT. This storage period of repair parts is considered as the period during which KJI can provide repair service.

For more information, please contact your local distributor, or call us at KJI's service desk from 9:00 a.m. to 5:00 p.m. JST on weekdays excluding holidays. When you make a call, please have the following information of your PRODUCT at hand:

- (1) PRODUCT name;
- (2) Model number;
- (3) Serial number;
- (4) Probe number;
- (5) Description of Symptom, and;
- (6) Date of purchase

* Product Name	4CH ANEMOMASTER
* Model Number	MODEL 1570
* Serial Number	-----
* Probe Number	-----
* Description of Symptom	-----
* Date of Purchase	-----

Kanomax

JAPAN

2-1 Shimizu, Suita, Osaka, 565-0805 Japan
TEL +81-6-877-0183 FAX +81-6-879-2080

USA

250 West 57th Street, Suite 816, New York, NY 10107
TEL +1-212-489-3755 FAX +1-212-489-4104

CHINA

4-3 Jia 5, Wencui Road, Heping District Shenyang, 110003 China
TEL +86-24-23846440 FAX +86-24.-23898417