



KANOMAX
The Ultimate Measurements

OPERATION MANUAL

Version 1

Duct Air Leakage Tester Model DALT 6900



Be sure to read this manual thoroughly before using the instrument.

Please keep this manual as a service reference.

Component List

Standard:

ITEM	Model	QTY
Duct Air Leakage Tester (main unit)	6900	1
Flow Grid		1
Low flow nozzle		1
∅6 Silicone tube (white)		1
Duct connection hose		1
Power cord		1
Container		1
∅ 6 Silicon tube (blue)		1
∅ 6 Silicon tube (red)		1
∅ 100 adjustable over lock straps		2
Calibration certificate		1

Optional Extras:

ITEM	Model	QTY
Smoke pellet kits		
Dust proof cover		

Symbols for warning mentioned in this manual are defined below:

Symbols classifications



Danger: To Prevent Serious Injury or Death

Warnings in this classification indicate a danger that may result in serious injury or death if not observed.



Caution: To Prevent Damage to the Product

Warnings in this classification indicate a risk of damage to the product that may void the product warranty if not observed.

Description of Symbols









△ This symbol indicates a condition that requires caution (including danger). The subject of each caution is illustrated inside the triangle.







⊘ This symbol indicates a prohibition. Do not take the prohibited action shown inside or near this symbol.



● This symbol indicates a mandatory action. A specific action is given near the symbol.

 WARNING	
 Heat forbidden	<p>○ Never bring the fabric hood near flammable gas or heat source.</p> <p>… Otherwise, the heat may cause a fire or explosion.</p>
 Disassembly prohibition	<p>○ Do not disassembly or refit the instrument.</p> <p>… Otherwise, it may cause the electric shock or a fire.</p>
 Using properly	<p>○ Use properly under the instruction manual.</p> <p>… Otherwise, it may cause sensor damaged or an electric shock even a fire.</p>
 Using properly	<p>○ If abnormal smells, noises or smoke occur, or if liquid enters the instrument, pull out the AC adapter and remove the batteries immediately. Then send it to the maintenance Dept. of KANOMAX for after service.</p> <p>… Or, there is possible of an electric shock or a fire or instrument malfunction.</p>
 Forbidden	<p>○ Do not expose the fabric hood, base and the instrument to water or rain.</p> <p>… Otherwise, may cause an electric shock, a fire and person injure.</p>

 CAUTION	
 Using properly	<ul style="list-style-type: none"> ○ Always unplug when the instrument not in use. … Failure to do so may cause an electric shock, a fire or circuit damage.
 Forbidden	<ul style="list-style-type: none"> ○ Do not use or leave the instrument in a high temperature, high humidity or dusty environment. Do not leave the instrument under direct sunlight. … Otherwise, the instrument may not function properly out of the specified operating conditions or the inside components damaged.
 Forbidden	<ul style="list-style-type: none"> ○ Never dropping the unit or place heavy objects on it … It may cause damage or malfunction to the instrument

CONTENTS

1. Introduction	6
1.1. Product features	6
1.2. Main Specifications	7
2. Outlook & Structure	8
2.1. Construction	8
2.2. Controller structure	8
3. Installation and Assembling	9
3.1. Testing duct connection	9
3.2. High- flow testing	10
3.3. Low- flow testing	11
4. Operating Instructions	12
4.1. Power On	12
4.2. “Accreditation” menu	12
4.3 “Measure” menu	15
4.4 “Setting” menu	16
4.5 “My Data” menu	17
4.6 “USB” menu	18
4.7 “About” menu	18
5. Error and Troubleshooting	19
6. Warranty and Service	20
6.1. Product Warranty	20
6.2. After service	20
Appendix1 Leakage Testing Standards	22
Appendix2 Fan Performance Graph	25
Appendix3 Installation Instruction	26

1. Introduction

Duct Air Leakage Tester is mainly used for HVAC duct air leakage testing. Testing can be in sections and the overall pipeline after whole system installation to make the HVAC system effective and avoiding energy waste. Model 6900 can judge the whether the duct seal is qualified based on and compliant with the corresponding accreditation standard. Touch screen with LCD color display and friendly Man-machine interface will make operation convenient and easier.

1.1. Product features

- ◆ Duct air leakage testing under positive or negative flow.
- ◆ Compliant with the following standards:EN1507:2006, EN12237:2002, Eurovent 2/2, DW/143, SMACNA Standard, GB50243 - 2002.
- ◆ Wide air flow testing range, two measuring tools ensure the test accuracy.
- ◆ Accreditation result will determine whether the duct sealing qualified.
- ◆ Real time display the leakage, testing pressure, temperature and atmosphere.
- ◆ 1000 groups data storage, review and delete.
- ◆ 4.7 inches LCD touch screen for easy operation.
- ◆ Simple construction and convenient installation.

1.2. Main Specifications

Model		DALE 6900
Air Flow	Ranges	Flow Grid: 21 to 377 CFM (36 to 640 m3/h) Nozzle: 2 to 21 CFM (4 to 36 m3/h)
	Accuracy	2.5 % of Reading \pm 0.06 CFM(0.1 m3/h)
	Resolution	0.01 CFM (0.01 m3/h)
Pressure	Ranges	\pm 10 in.wg (\pm 2500 Pa)
	Accuracy	1% of Reading \pm 0.004 in.wg(1 Pa)
	Resolution	0.001 in.wg (0.1 Pa)
Temperature	Ranges	32 to 140 °F (0 to 60 °C)
	Accuracy	\pm 1 °F (0.5 °C)
	Resolution	0.1 °F (0.1 °C)
Absolute Pressure	Ranges	20.6 to 38.3 in.Hg (70 to 130kPa)
	Accuracy	2% of Reading
	Resolution	0.1 in.Hg (0.1 kPa)
Power Source	DALE 6900-0E	110-120V, 1 Phase, 50/60Hz,16A
	DALE 6900-1E	220-240V, 1 Phase, 50/60Hz,10A
Weight		Approx.75kg
Dimensions		W21 x D20 x H47 inches (54 x 50 x 120 mm)
Data logging		Up to 1000 measurements

2. Outlook & Structure

2.1. Construction

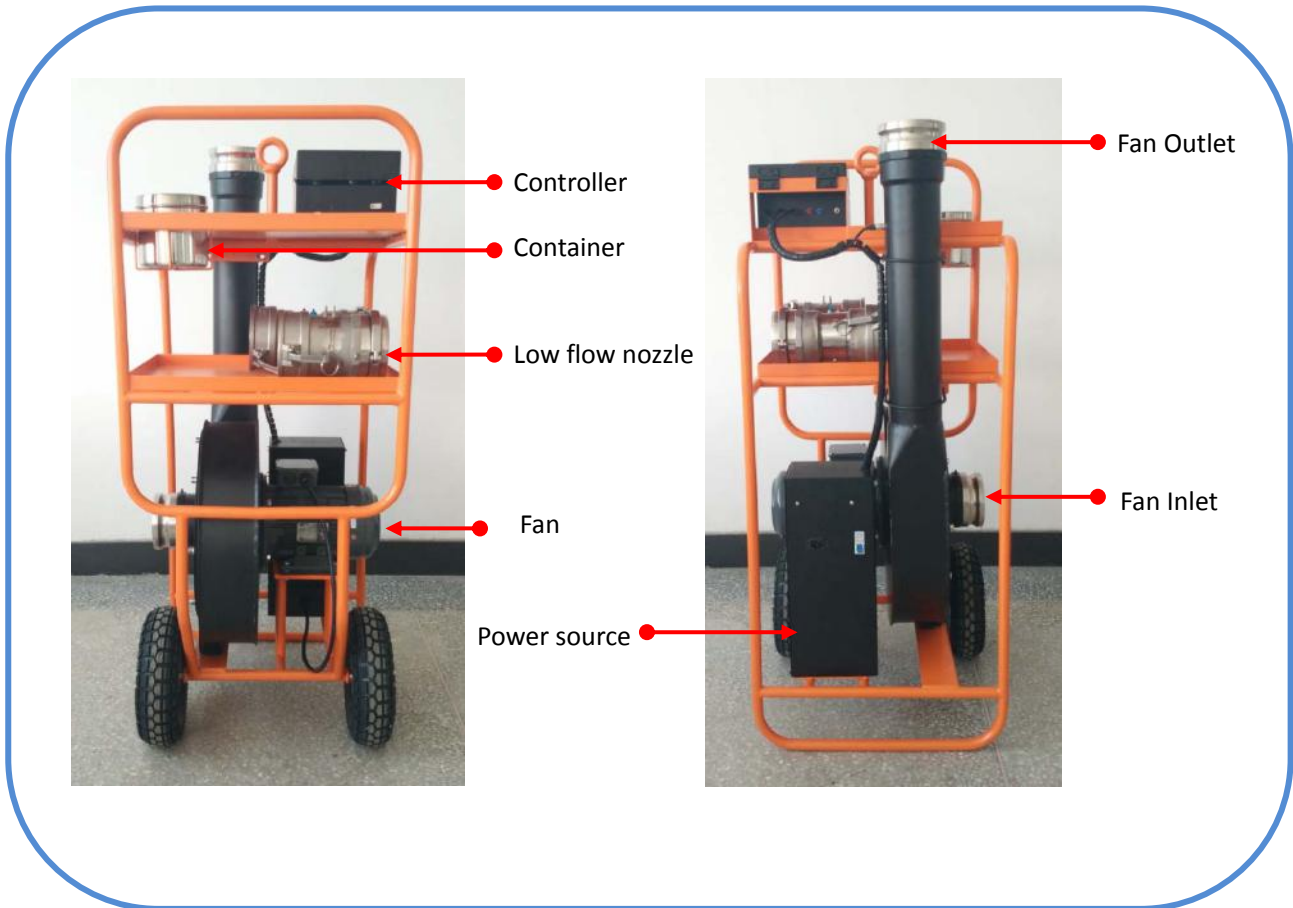

2.2. Controller structure

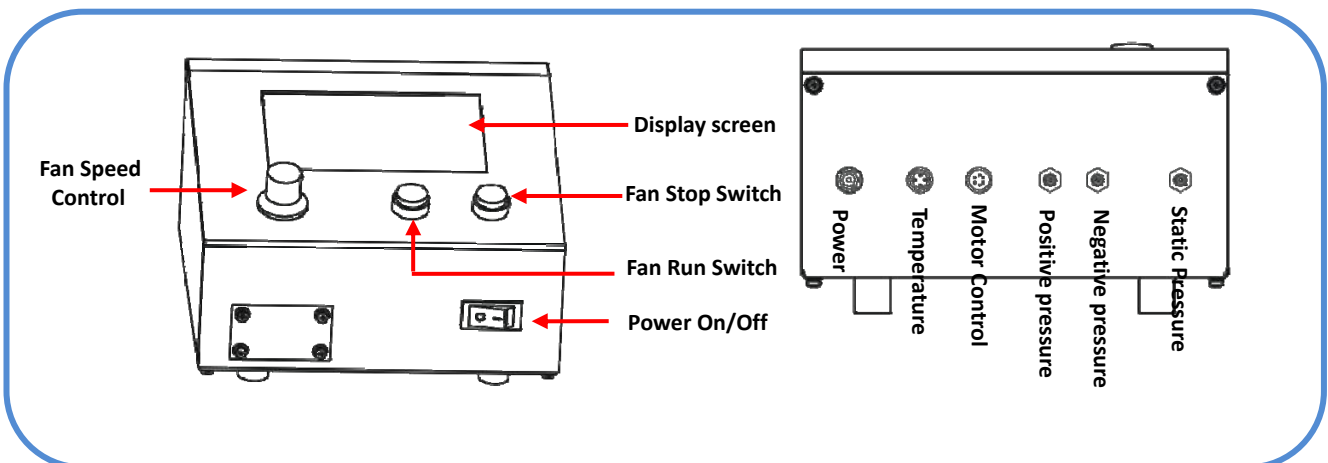

3. Installation and Assembling

According to the testing air flow range, nozzles or Matrix will be optional as the testing tool. And it's applicable to both air blower system and exhaust system of the air conditioning ducts. Generally speaking, take nozzle as the tool for low flow test and take matrix as the tool for the High flow test.

3.1. Testing duct connection

Preparation before testing:

- (1) Refer to [Appendix 1. Leakage testing standard](#) for a confirmation of required testing, such as:
 - Leakage standard to be followed;
 - Air tightness / leakage class to be achieved;
 - Testing pressure.
- (2) Temporarily seal all the openings of the ductwork except one, which will be connected to the duct leakage tester. Calculate the area of testing duct surface to ensure it's available and within the input range.

Connect the testing duct to the Tester :

- (1) Position the DALT 6900 unit as close to the remaining opening in the ductwork as possible to minimize the flexible tubing needed. Minimize bends in the flexible tubing to reduce the pressure loss, giving the best performance.
- (2) Fit one end of the flexi-tube with adapter spigot to the 6900. Make an air-tight seal using one of the over lock straps and lever-locking cam provided. Connect the other end with flange to the testing duct required. User need to install and connection with proper way according to the practical situation.
- (3) If the static pressure tapping on the testing duct, connect the static tube as the tapping or drill a $\Phi 6\text{mm}$ hole in the duct and insert the static tube into the duct. Seal around the hole. Connect the other end of the static tube to the Controller cabinet.

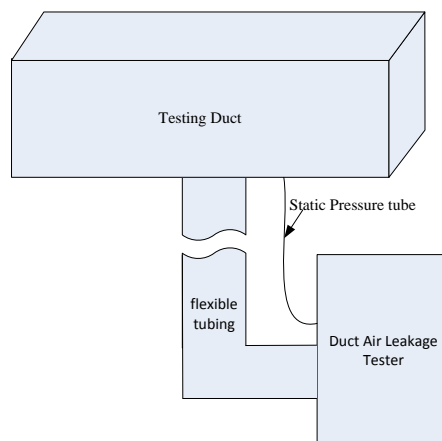

3.2.High- flow testing

High- flow testing takes Matrix grid as the tool for Duct leakage flow measuring. Connect the matrix grid tool to the fan outlet, tight locking the cam Lock to ensure proper fit. Connect the flow grid pressure tap to the Differential pressure flow port of the controller cabinet. And same color hose-tap connection please.

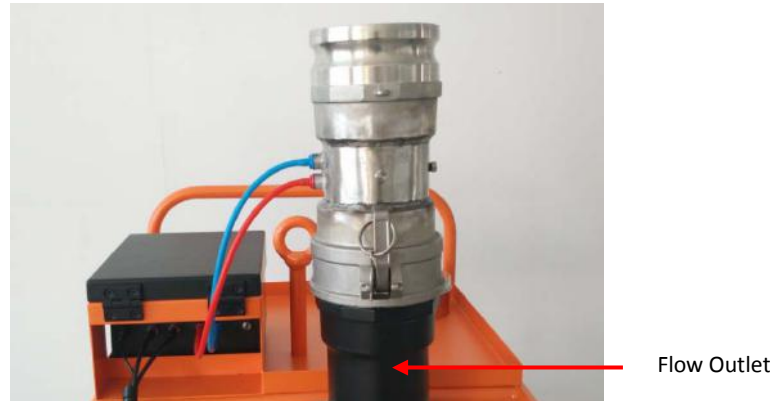

Noted: Hard push cam lock arms at the same time when locking the cam lock.

1. **Duct testing under Positive pressure:** Connect the flexible tubing to the outlet side of the flow grid pressure tap then tight lock.
2. **Duct testing under Negative pressure:** Connect the flexible tubing to the flow inlet side of the Fan then tight lock.



High flow Duct testing under positive pressure



Cam lock adaptor in locked status.



High flow Duct testing under Negative pressure

3.3.Low- flow testing

Low- flow testing takes nozzles as the tool for Duct leakage flow measuring. Install the low-flow nozzles to the blower outlet, tight locking the cam lock adaptor. Connect the pressure tap of the nozzle to the Differential pressure flow port of the controller cabinet. And same color hose-tap connection please.

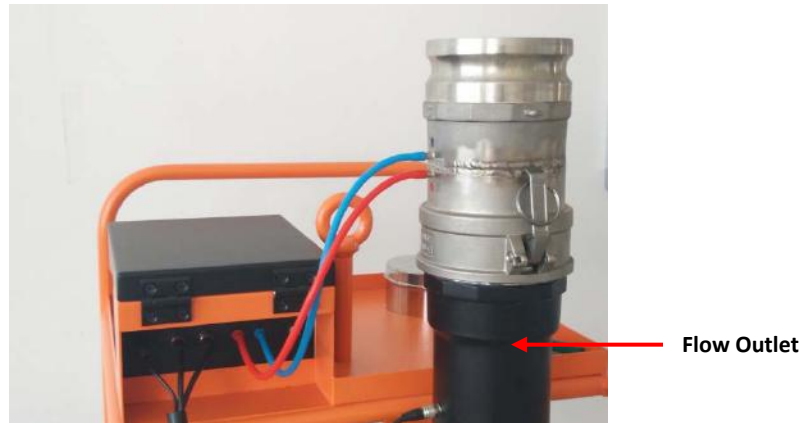

1. **Duct testing under Positive pressure:** Connect the flexible tubing to the flow outlet side of the nozzle then tight lock.
2. **Duct testing under Negative pressure:** Connect the flexible tubing to the flow inlet side of the Fan then tight lock.

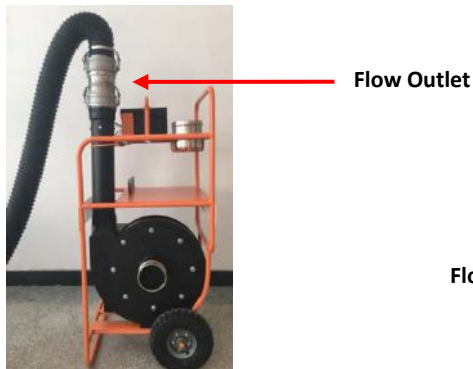

Low-flow Duct testing under positive pressure

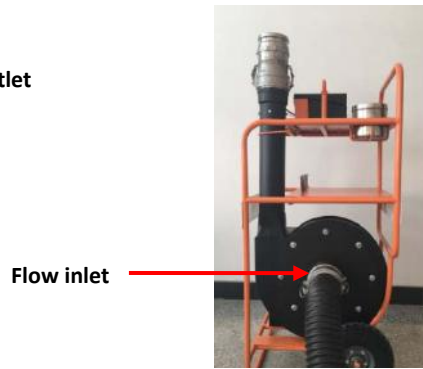

Low-flow Duct testing under Negative pressure

4. Operating Instructions

4.1. Power On

1. **Power source:** AC power supply with a Transient protector is for DALT 6900. Before turning on for start measuring, check and ensure the correct and securely connection behind the controller cabinet.



2. **Turn On for start measuring:** Power the controller on by plugging in the power cord. Press Power On of the Controller for start measuring.

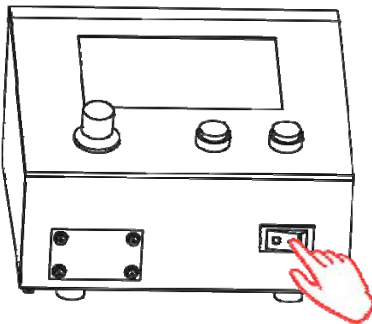

3. Application menus

Accreditation	Application items in “Accreditation”: set the Accreditation Standard for Duct leakage testing, Testing as steps according to the set standard and save testing data as request.
Measure	Application items in “Measure”: airflow, pressure, temperature and atmosphere.
Setting	Application items in “Setting”: date, time, testing mode, unit and other parameters’ setting.
My Data	Application options in “My Data”: browsing data or deleting data.
USB	Application of “USB”: Output the data record to U disk.
About	Application of “About”: introduce the fundamental performance parameters.

4.2. “Accreditation” menu

In Accreditation Menu, application items include select Flow device, Leakage testing standard, Air tightness class and input Duct Surface Area and testing time for a requested static pressure in duct. Duct accreditation should be under the request static pressure. And the accreditation result can be stored after testing or re-start

the testing.

Click "Accreditation" to access the Application menu.

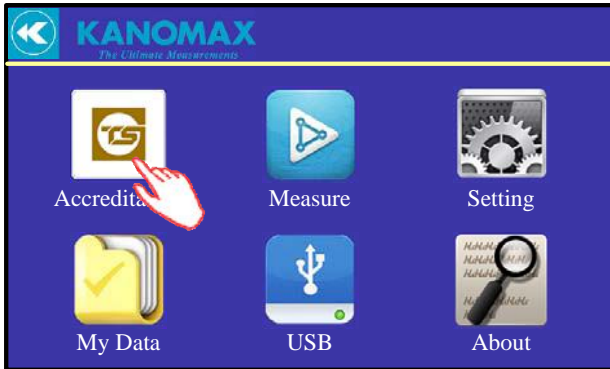

Select the Flow Device.

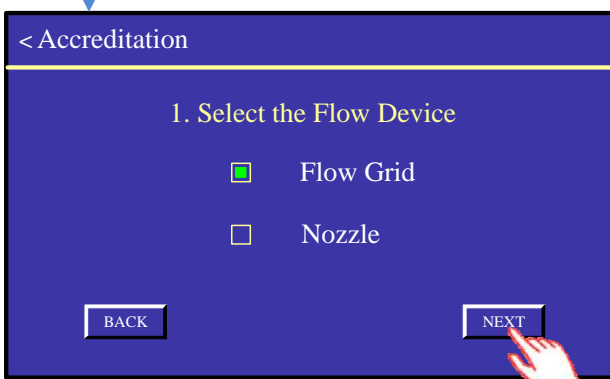

Click NEXT for Testing standard selection

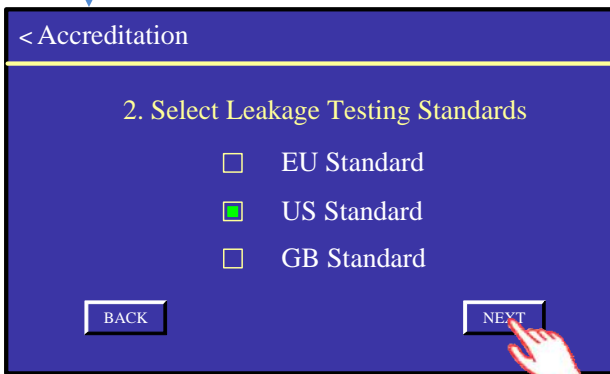

Click NEXT for Air Tightness class selection

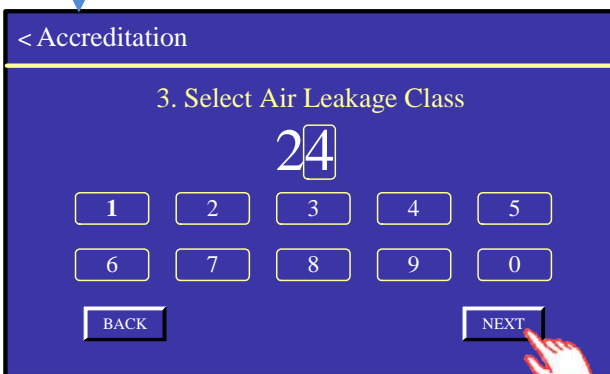

Click NEXT

inputting Duct Surface Area.

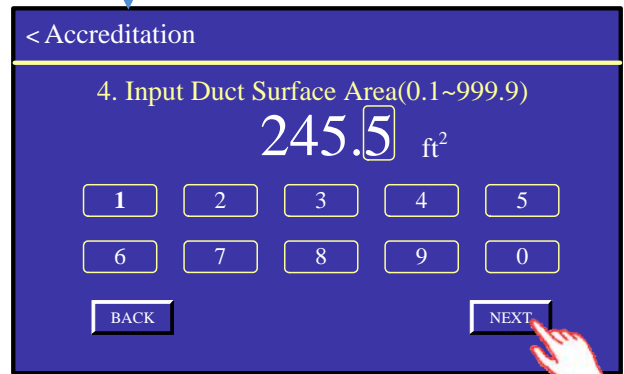

Click NEXT to Test time setting

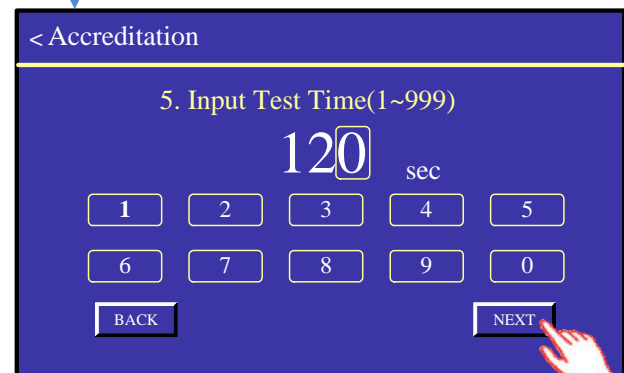

Click NEXT for adjusting static pressure in duct.

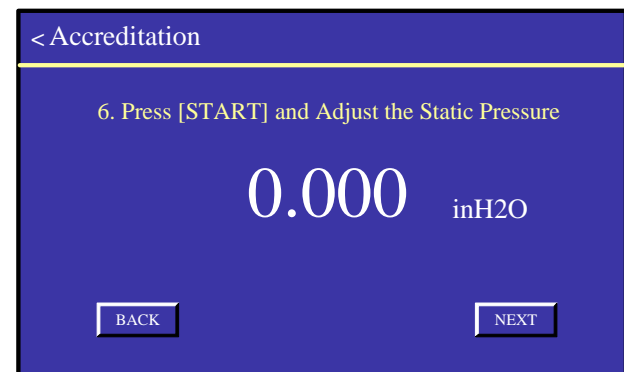

Press "START" for motor start running
Switch "Fan speed control" for adjusting the static pressure in Duct

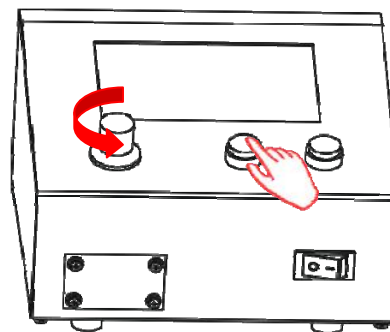

Real-time displaying the static pressure in duct.

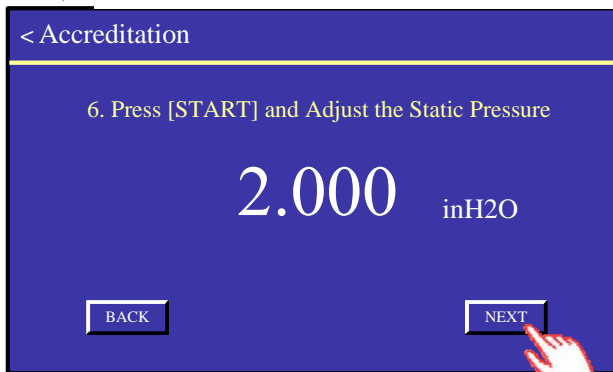

When pressure statically, click **NEXT** for starting test.

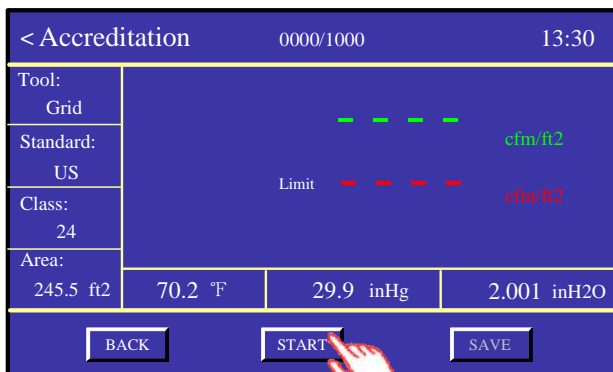

Click **START** for testing begin



Through after the setting time, output display the testing result.

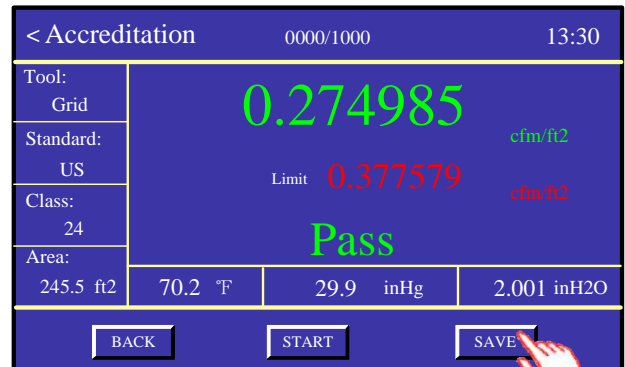

Click **SAVE** for data saving.

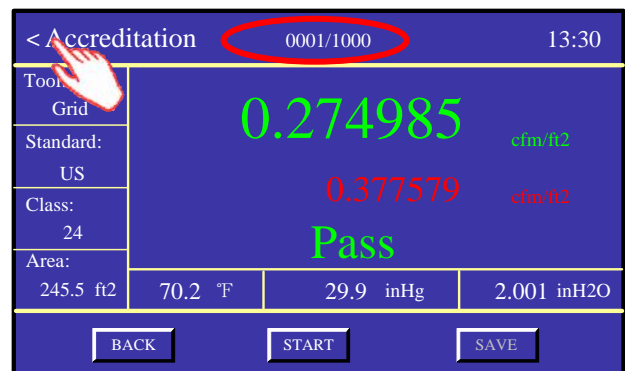

NOTE: After the Measurement, please press "STOP" button of "Blower Control" to stop the Blower.

4.3 “Measure” menu

Measure items include: airflow, static pressure, temperature and atmosphere.

Click “Measure” to access the Application menu.



Select the Flow Device

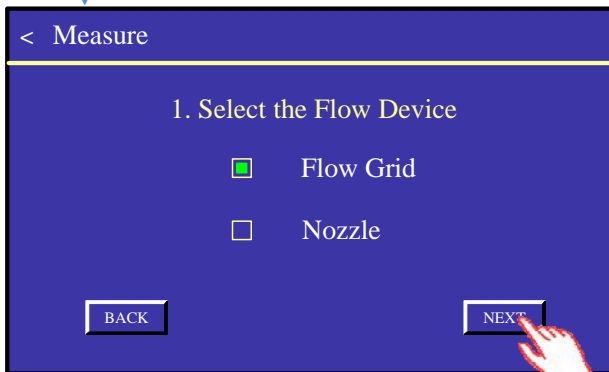

Press **NEXT** to enter the selected

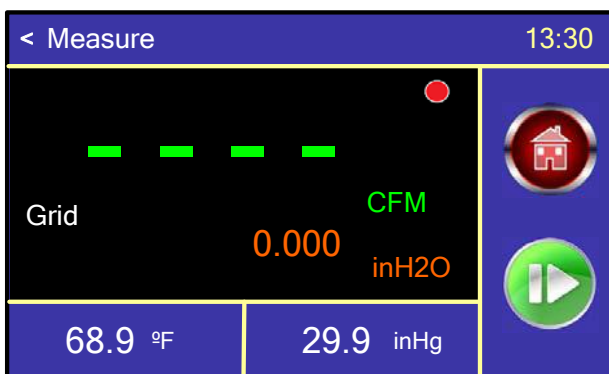

Press “START” for motor start running
Switch “Fan speed control” for adjusting the static pressure in Duct

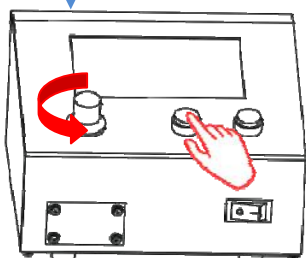

When pressure is adjusted to the request, click for start Airflow testing.

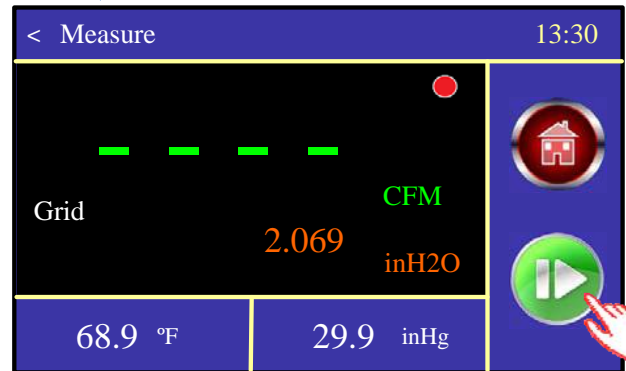

Air flow will be real-time display during testing.

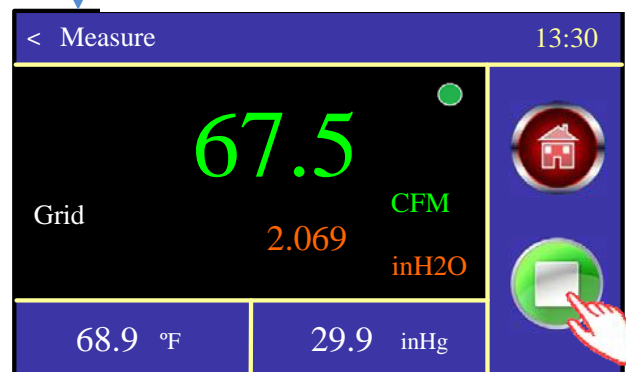

Press for end the airflow testing.

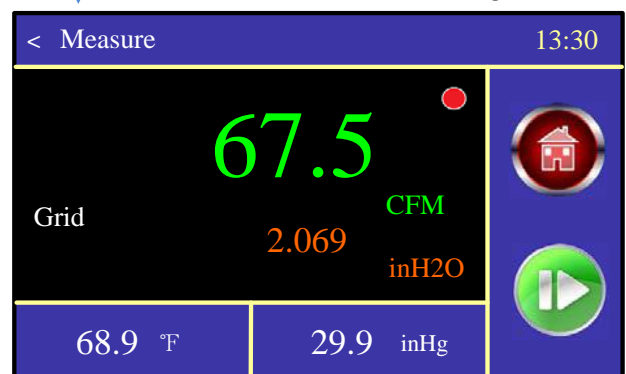

Press “STOP” for Fan stop running.

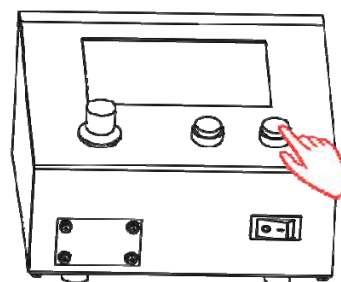

4.4 "Setting" menu

In "Setting" menu, application items include: Date, Time, STD/ACT, Temperature, Atmosphere, Air flow and Static pressure as shown below.

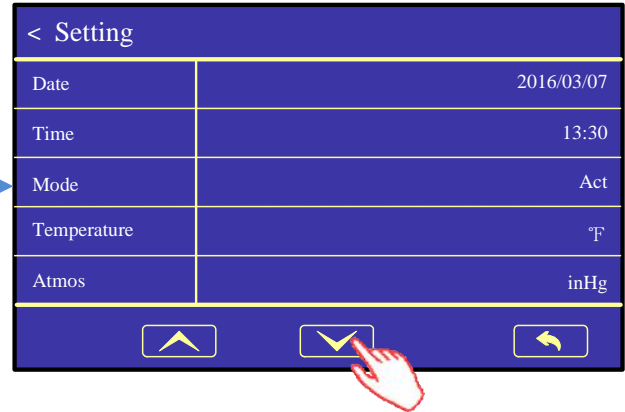

1. Date setting

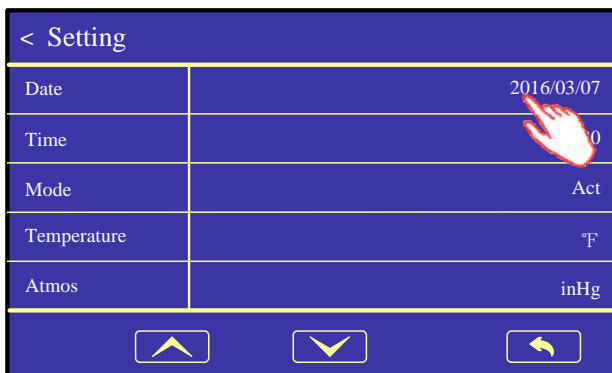

Click Date for editing setting

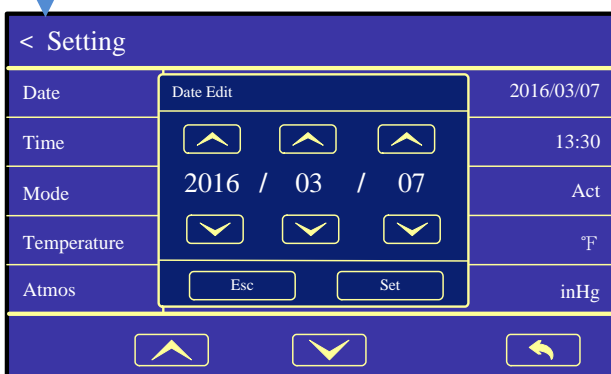

Press  or  for modifying data.

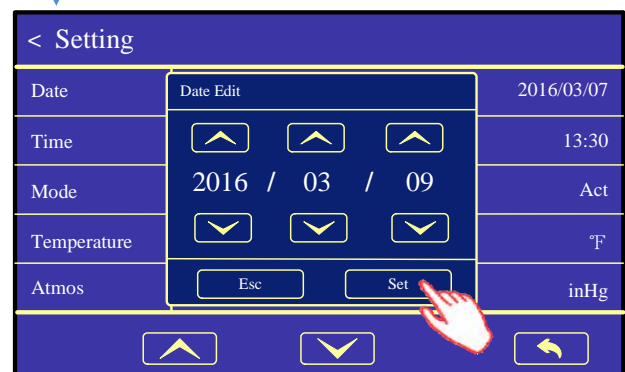

Click  for data saving.

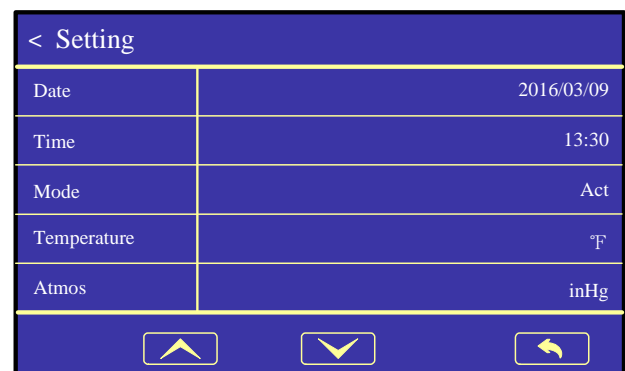

4.5 “My Data” menu

1. Press  or  for page turning browsing.

< My Data		0001/0010	
Tool: Flow	2016/03/07	13:32:54	
Standard: US	Pass		
Class: 24	0.274985	cfm/ft2	
Limit: 0.377579 cfm/ft2	67.51	cfm	
Area: 245.5 ft2	2.008	inH2O	
Time: 120 sec	70.2 °F	29.9	inHg

↓

< My Data		0002/0010	
Tool: Flow	2016/03/07	13:45:35	
Standard: US	Fail		
Class: 24	0.453698	cfm/ft2	
Limit: 0.377579 cfm/ft2	111.38	cfm	
Area: 245.5 ft2	2.001	inH2O	
Time: 120 sec	70.2 °F	29.9	inHg

2. Click the serial No. on upper right corner for data reviewing

< My Data		0001/0010	
Tool: Flow	2016/03/07	13:32:54	
Standard: US	Pass		
Class: 24	0.274985	cfm/ft2	
Limit: 0.377579 cfm/ft2	67.51	cfm	
Area: 245.5 ft2	2.001	inH2O	
Time: 120 sec	70.2 °F	29.9	inHg

→

< My Data		0001/0010	
Tool: Flow	2016/03/07	13:32:54	
Standard: US	Pass		
Class: 24	0.274985	cfm/ft2	
Limit: 0.377579 cfm/ft2	67.51	cfm	
Area: 245.5 ft2	2.001	inH2O	
Time: 120 sec	70.2 °F	29.9	inHg

Select
+ 0001 -
 Esc Set

3. Through Delete range settings for deleting selected data.

< My Data		0001/0010	
Tool: Flow	2016/03/07	13:32:54	
Standard: US	Pass		
Class: 24	0.274985	cfm/ft2	
Limit: 0.377579 cfm/ft2	67.51	cfm	
Area: 245.5 ft2	2.001	inH2O	
Time: 120 sec	70.2 °F	29.9	inHg

Del →

< My Data		0001/0010	
Tool: Flow	2016/03/07	13:32:54	
Standard: US	Pass		
Class: 24	0.274985	cfm/ft2	
Limit: 0.377579 cfm/ft2	67.51	cfm	
Area: 245.5 ft2	2.001	inH2O	
Time: 120 sec	70.2 °F	29.9	inHg

Delete
↑ 000 ~ 000 ↓
 1 1
 Esc Set

4. Exit.

Click  for Exiting the data browsing interface.

4.6“USB”menu

The data record can be output by USB disk.

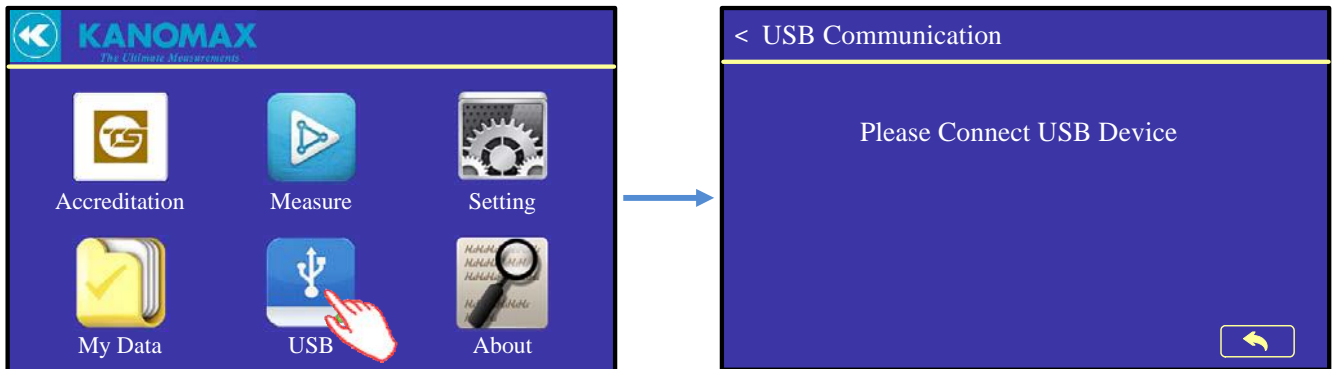

When insert USB disk to USB connector, it will be found by the system and all the saved data will be output.

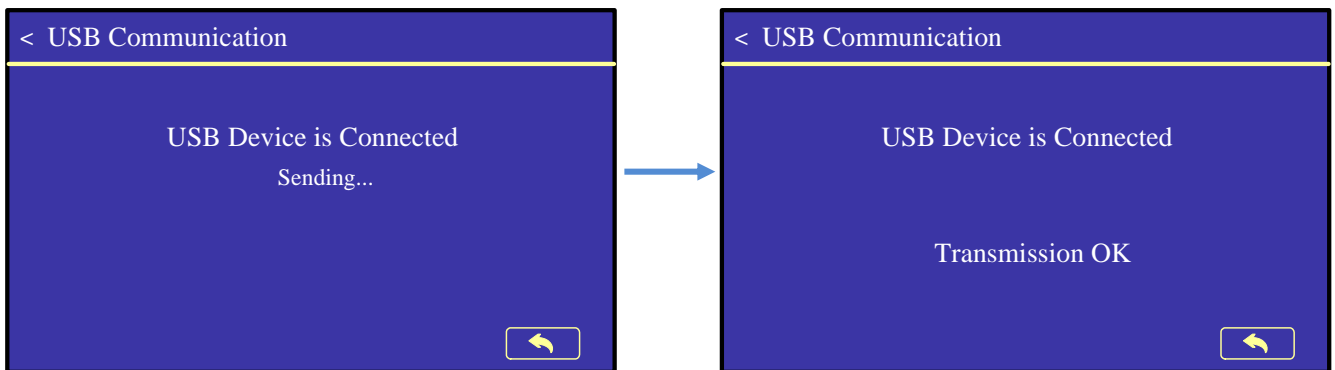

NOTE: if too many file in USB disk, the time of output will be long. Please clean up the USB disk before data output.

4.7“About” menu

Click “About” for entering the introduction menu, describing the main parameters of the instrument.

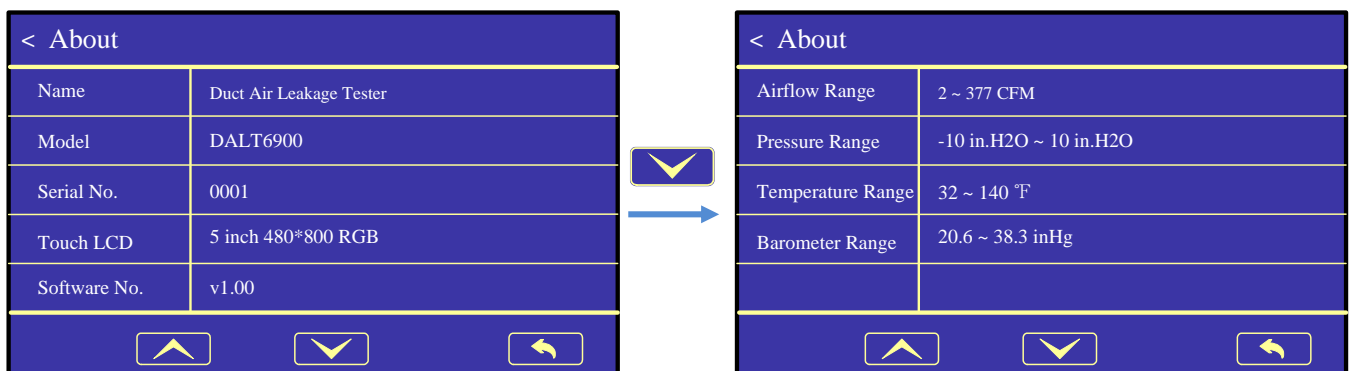

5. Error and Troubleshooting

No.	Symptom	Possible causes	Corrective action
1	Controller start failure	Power connect failure	Check the power source and connecting wire
		Internal circuit problem	Connect with manufacturer
2	Fan motor will not run	Power phase shortage	Check the power supply
		Motor controller line is not connected or poor connect.	Check the Motor Control line on the back of Controller
		Motor controller failure	Restart Controller. Or connect with manufacturer
3	Touch screen failure	External disturbances	Check around, away from the possible external disturbances, re-start the Controller.
		Capacitive touch screen only recognizes a fingertouch	Finger touch directly
		Touch screen failure	Connect with manufacturer
4	Temperature display wrong	Temperature line is not connected or poor connect.	Check and well connect the temperature line.
5	Air flow range displayed wrong	Testing tool set wrong matching with the fixed one.	Re-set the testing tool or re-install the matching testing tool.
6	USB data exporting failure	USB disk failure.	The available USB disk should be: support USB2.0 protocol and FAT file format.
		After plug-in USB disk, data exporting available only once.	USB disk unplug then back plug in for data exporting again.

6 Warranty and Service

6.1. Product Warranty

The limited warranty set forth below is given by KANOMAX GROUP COMPANIES with respect to the KANOMAX brand Duct Air Leakage Tester and other accessories (hereafter referred to as “PRODUCT”) purchased directly from KANOMAX GROUP COMPANIES or from an authorized distributor.

Your PRODUCT, when delivered to you in new condition in its original container, is warranted against defects in materials or workmanship as follows: for a period of two (2) year from the date of original purchase, defective parts or a defective PRODUCT returned to KANOMAX GROUP COMPANIES, as applicable, and proven to be defective upon inspection, will be exchanged for a new or comparable rebuilt parts, or a refurbished PRODUCT as determined by KANOMAX GROUP COMPANIES. Warranty for such replacements shall not extend the original warranty period of the defective PRODUCT.

This limited warranty covers all defects encountered in normal use of the PRODUCT, and does not apply in the following cases:

- (1) Use of parts or supplies other than the PRODUCT sold by KANOMAX GROUP COMPANIES, which cause damage to the PRODUCT or cause abnormally frequent service calls or service problems.
- (2) If any PRODUCT has its serial number or date altered or removed.
- (3) Loss of damage to the PRODUCT due to abuse, mishandling, alternation, improper packaging by the owner, accident, natural disaster, electrical current fluctuations, failure to follow operation, maintenance or environmental instructions prescribed in the PRODUCT's operation manual provided by KANOMAX GROUP COMPANIES, or service performed by other than KANOMAX GROUP COMPANIES.

NO IMPLIED WARRANTY, INCLUDING ANY IMPLIED WARRANTY OF MERCHANTABILITY OR FITNESS FOR A PARTICULAR PURPOSE, APPLIES TO THE PRODUCT AFTER THE APPLICABLE PERIOD OF THE EXPRESS LIMITED WARRANTY STATED ABOVE, AND NO OTHER EXPRESS WARRANTY OR GUARANTY, EXCEPT AS MENTIONED ABOVE, GIVEN BY ANY PERSON OR ENTITY WITH RESPECT TO THE PRODUCT SHALL BIND KANOMAX GROUP COMPANIES. KANOMAX GROUP COMPANIES SHALL NOT BE LIABLE FOR LOSS OF STORAGE CHARGES, LOSS OR CORRUPTION OF DATA, OR ANY OTHER SPECIAL, INCIDENTAL OR CONSEQUENTIAL DAMAGES CAUSED BY THE USE OR MISUSE OF, OR INABILITY TO USE, THE PRODUCT, REGARDLESS OF THE LEGAL THEORY ON WHICH THE CLAIM IS BASED, AND EVEN IF KANOMAX GROUP COMPANIES HAS BEEN ADVISED OF THE POSSIBILITY OF SUCH DAMAGES. IN NO EVENT SHALL RECOVERY OF ANY KIND AGAINST KANOMAX GROUP COMPANIES BE GREATER IN AMOUNT THAN THE PURCHASE PRICE OF THE PRODUCT SOLD BY KANOMAX GROUP COMPANIES AND CAUSING THE ALLEGED DAMAGE. WITHOUT LIMITING THE FOREGOING, THE OWNER ASSUMES ALL RISK AND LIABILITY FOR LOSS, DAMAGE OF, OR INJURY TO THE OWNER AND THE OWNER'S PROPERTY AND TO OTHERS AND THEIR PROPERTY ARISING OUT OF USE OR MISUSE OF, OR INABILITY TO USE, THE PRODUCT NOT CAUSED DIRECTLY BY THE NEGLIGENCE OF KANOMAX GROUP COMPANIES. THIS LIMITED WARRANTY SHALL NOT EXTEND TO ANYONE OTHER THAN THE ORIGINAL PURCHASER OF THE PRODUCT, OR THE PERSON FOR WHOM IT WAS PURCHASED AS A GIFT, AND STATES THE PURCHASER'S EXCLUSIVE REMEDY.

6.2. After service

- ◆ When you have a problem with your instrument, please check out the “Common Trouble Shooting” section first.
- ◆ If that does not help, please contact your local distributor, or contacts on the last page.

- ◆ During the warranty period, we will repair at no charge a product that proves to be defective due to material or workmanship under normal use.
All return shipping charges are the responsibility of the customer.
- ◆ Repair after warranty expiration:
Upon request, we will repair the instrument at the customer's expense, if the instrument's performance is found to be recoverable by providing the repair.
- ◆ Replacement parts are available for a minimum period of five (5) years after termination of production. This storage period of replacement parts is considered as the period during which we can provide repair service. For further information, please contact your local distributor, or contacts on the last page.

When making an inquiry, please provide the following information:

- * PRODUCT NAME -----
- * Model No. -----
- * Serial No. -----
- * Description of the problem: -----
- * Data of Purchase: Day, Month, and Year

Appendix1 Leakage Testing Standards

No.	Standard	County	Description
1	BS EN 12237:2003	EU	Ventilation for buildings—Ductwork—Strength and leakage of circular sheet metal ducts.
2	BS EN 1507:2006	EU	Ventilation for buildings—Sheet metal air ducts with rectangular section—Requirements for strength and leakage.
3	DW/143	EU	HVAC—A practical guide to Ductwork leakage testing.
4	Eurovent 2/2	EU	Air leakage rate in sheet metal air distribution systems.
5	SMACNA HVAC Air Duct Leakage Test manual, First edition, 1985	US	Duct construction leakage classification, expected leakage rates for sealed and unsealed ductwork, duct leakage test procedures, recommendations on use of leakage testing, types of test apparatus and test setup and sample leakage analysis.
6	GB50243	GB	Quality acceptance regulation of Ventilation and Air conditioning work

1. EU Standards EN12237

Air Tightness Class	Air Leakage Limit (fmax) m ³ /s/m ²	Static Pressure Limit (ps) Pa	
		Negative	Positive
A	$\frac{0.027 \times P_t^{0.65}}{1000}$	500	500
B	$\frac{0.009 \times P_t^{0.65}}{1000}$	750	1000
C	$\frac{0.003 \times P_t^{0.65}}{1000}$	750	2000
D	$\frac{0.001 \times P_t^{0.65}}{1000}$	750	2000

* Class D ductwork is only for special apparatus

2. EU Standards EN1507

Air Tightness Class	Air Leakage Limit (fmax) m ³ /s/m ²	Static Pressure Limit (ps) Pa			
		Negative	Positive at pressure class		
			1	2	3
A	$\frac{0.027 \times P_t^{0.65}}{1000}$	200	400		
B	$\frac{0.009 \times P_t^{0.65}}{1000}$	500	400	1000	2000

C	$\frac{0.003 \times P_t^{0.65}}{1000}$	750	400	1000	2000
D*	$\frac{0.001 \times P_t^{0.65}}{1000}$	750	400	1000	2000

* Class D ductwork is only for special apparatus

3. EU Standards Dw/143

Duct Pressure Class	Static Pressure Limit		Maximum Air Velocity m/s	Air leakage limits l/s/m ²
	Positive Pa	Negative Pa		
Low-pressure – Class A	500	500	10	$0.027 \times P_t^{0.65}$
Medium pressure – Class B	1000	750	20	$0.009 \times P_t^{0.65}$
High pressure – Class C	2000	750	40	$0.003 \times P_t^{0.65}$

4. EU Standards Eurovent 2/2

Air Tightness Class	Air leakage limit (fmax) m ³ /s/m ²
A	$\frac{0.027 \times P_t^{0.65}}{1000}$
B	$\frac{0.009 \times P_t^{0.65}}{1000}$
C	$\frac{0.003 \times P_t^{0.65}}{1000}$

5. US Standards SMACNA

Duct Class	1/2-, 1-, 2-inwg	3-inwg	4-, 6-, 10-inwg
Seal Class	C	B	A
Sealing Applicable	Transverse Joints Only	Transverse Joints and Seams	Joints, Seams and All Wall Penetrations
Leakage Class			
Rectangular Metal	24	12	6
Round Metal	12	6	3

Maximum air leakage is then defined as

$$F = C_L P^{0.65}$$

F = Maximum air leakage (cfm/100 ft²)

C_L = Leakage class

P = Pressure (inwg)

6. GB Standard GB50243

Rectangle Duct pressure class	Maximum Leakage $m^3/h/m^2$
Low-pressure system	$0.1056 \times P^{0.65}$
Medium pressure system	$0.0352 \times P^{0.65}$
High pressure system	$0.0117 \times P^{0.65}$

P-- Working pressure(Pa) of the Duct system.

1.The allowable air leakage for the Round Metal Duct of low pressure and medium pressure, composite material duct and Illegal orchid form of nonmetallic duct should be 50% of the regulated leakage value of the rectangle duct.

2. The allowable air leakage of brick concrete duct should be no more than 1.5times regulated leakage value of the rectangle duct.

3.Ventilation dedusting with low temperature air supply system should be according to and comply with the standard for Medium pressure system; 1-5 class air cleaning system should be according to and comply with the standard for High pressure system.

Appendix 2 Fan Performance Graph

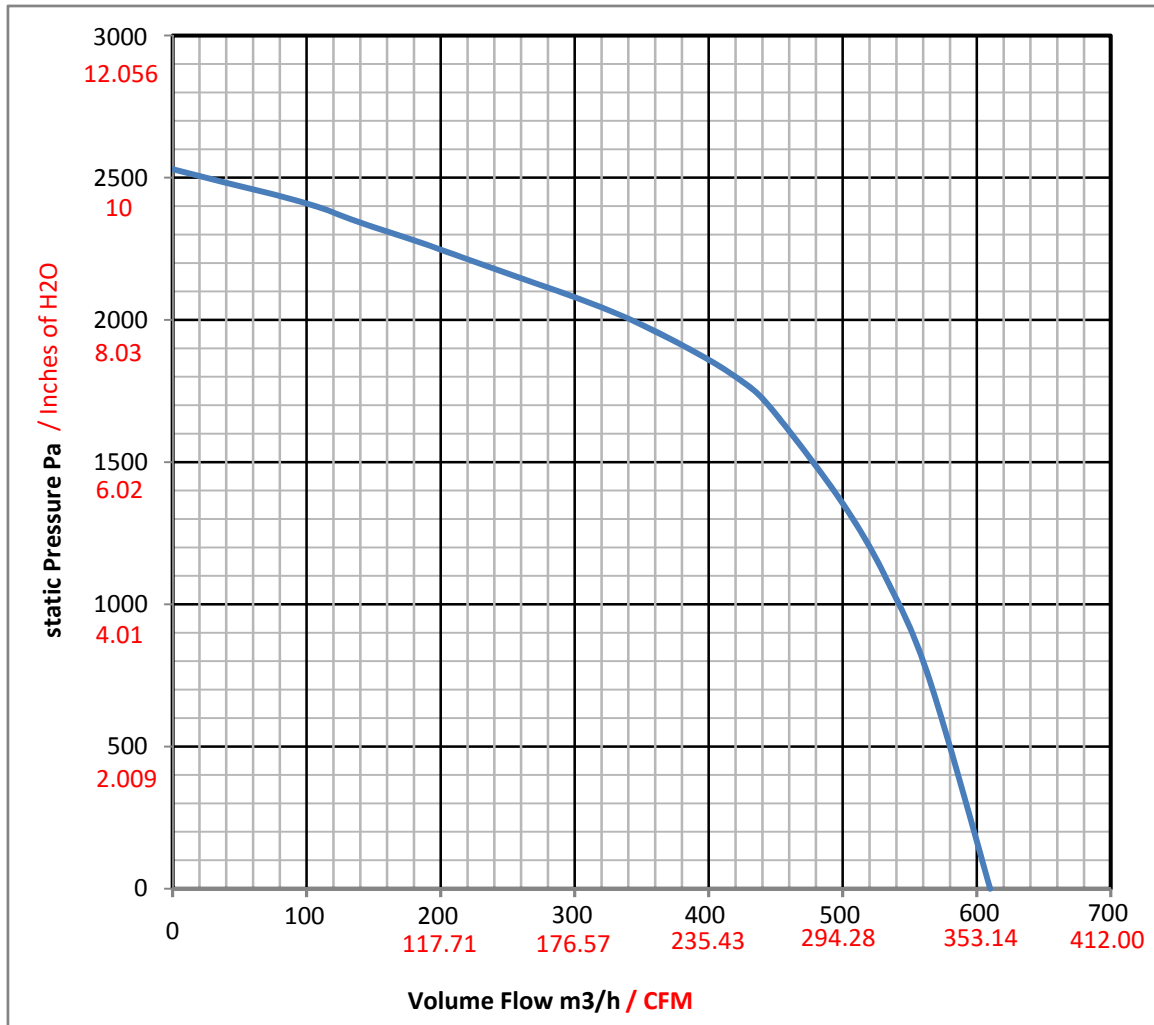

Note:

Static Pressure (left) units include both Pascale (Pa) and Inches of Water (H₂O)
 Pascale is the top number in black and Inches of H₂O is the bottom number in red

Volume Flow (bottom) units include both cubic meters per house (m³/H) and cubic feet per minute (CFM)
 Cubic meters per hour is the top number in black and cubic feet per minute is the bottom number in red

Appendix3 Installation Instruction

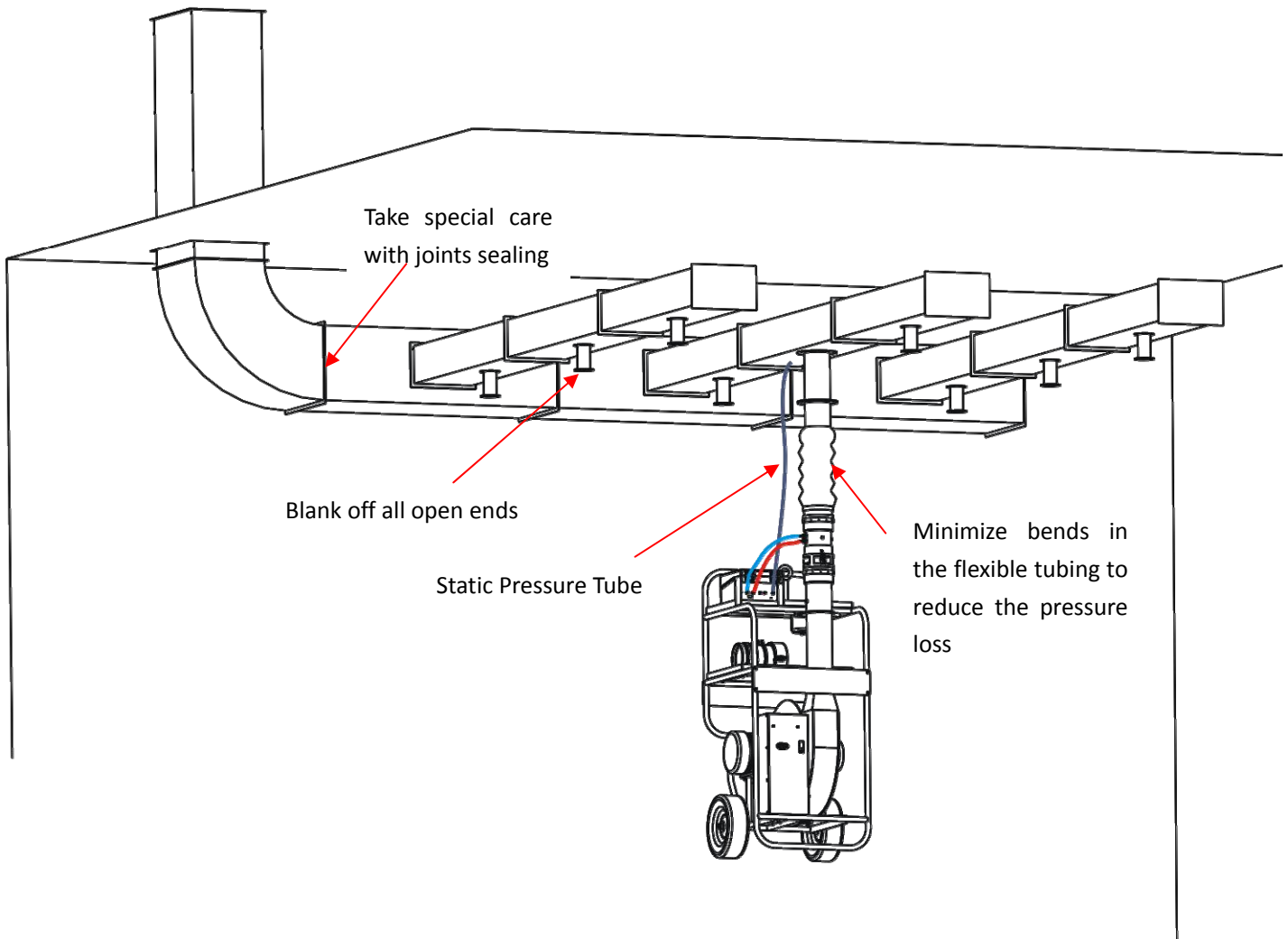

How to Find Leaks

1. Look - at blanks, access openings and difficult joints.
2. Listen - with test rig running, leaks should be audible.
3. Feel - running your hand (particularly if wet) over joints can help locate leaks.
4. Soap and Water - paint over joints and look for bubbles.
5. Smoke Pellet - placed inside ductwork (obtain permission for use).

Kanomax Group Companies

■ Americas, Europe, Mid-East, Africa, Oceania

KANOMAX USA, INC.

219 US Highway. 206, Andover, New Jersey 07821

TEL: 1-800-247-8887(USA) / 1-973-786-6386

FAX: 1-973-786-7586

URL:www.kanomax-usa.com

E-Mail:info@kanomax-usa.com

■ Japan & Asia

KANOMAX JAPAN, INC.

2-1 Shimizu Suita City, Osaka Japan 565-0805

TEL: 81-6-6877-0183

FAX: 81-6-6879-2080

URL:www.kanomax.co.jp

E-Mail:sales@kanomax.co.jp

■ China

Shenyang Kano Scientific Instrument Co., Ltd.

#2610, 51 Wulihe Street Heping District, Shenyang City, PRC

TEL:86-24-23845309

FAX:86-24-23898417

URL:<http://www.kanomax.com.cn/>

E-Mail:sales@kanomax.com.cn

Copyright © Kanomax USA, Inc. All rights reserved. 2016

No copying, distribution, publication, modification, or incorporation of this document, in whole or part, is permitted for commercial purposes without the express written permission of Kanomax.

The contents of this document may be changed without prior notice.