

Keysight 85053B

3.5 mm Verification Kit

User's and
Service Guide

Notices

© Keysight Technologies, Inc.
1995-2019

No part of this manual may be reproduced in any form or by any means (including electronic storage and retrieval or translation into a foreign language) without prior agreement and written consent from Keysight Technologies, Inc. as governed by United States and international copyright laws.

Trademark Acknowledgments

Manual Part Number

85053-90028

Edition

Edition 1, January 2019

Printed in USA/Malaysia

Published by:
Keysight Technologies
1400 Fountaingrove Parkway
Santa Rosa, CA 95403

Warranty

THE MATERIAL CONTAINED IN THIS DOCUMENT IS PROVIDED "AS IS," AND IS SUBJECT TO BEING CHANGED, WITHOUT NOTICE, IN FUTURE EDITIONS. FURTHER, TO THE MAXIMUM EXTENT PERMITTED BY APPLICABLE LAW, KEYSIGHT DISCLAIMS ALL WARRANTIES, EITHER EXPRESS OR IMPLIED WITH REGARD TO THIS MANUAL AND ANY INFORMATION CONTAINED HEREIN, INCLUDING BUT NOT LIMITED TO THE IMPLIED WARRANTIES OF MERCHANTABILITY AND FITNESS FOR A PARTICULAR PURPOSE. KEYSIGHT SHALL NOT BE LIABLE FOR ERRORS OR FOR INCIDENTAL OR CONSEQUENTIAL DAMAGES IN CONNECTION WITH THE FURNISHING, USE, OR PERFORMANCE OF THIS DOCUMENT OR ANY INFORMATION CONTAINED HEREIN. SHOULD KEYSIGHT AND THE USER HAVE A SEPARATE WRITTEN AGREEMENT WITH WARRANTY TERMS COVERING THE MATERIAL IN THIS

DOCUMENT THAT CONFLICT WITH THESE TERMS, THE WARRANTY TERMS IN THE SEPARATE AGREEMENT WILL CONTROL.

Technology Licenses

The hardware and/or software described in this document are furnished under a license and may be used or copied only in accordance with the terms of such license.

U.S. Government Rights

The Software is "commercial computer software," as defined by Federal Acquisition Regulation ("FAR") 2.101. Pursuant to FAR 12.212 and 27.405-3 and Department of Defense FAR Supplement ("DFARS") 227.7202, the U.S. government acquires commercial computer software under the same terms by which the software is customarily provided to the public.

Accordingly, Keysight provides the Software to U.S. government customers under its standard commercial license, which is embodied in its End User License Agreement (EULA), a copy of which can be found at

<http://www.keysight.com/find/sweula>

The license set forth in the EULA represents the exclusive authority by which the U.S. government may use, modify, distribute, or disclose the Software. The EULA and the license set forth therein, does not require or permit, among other things, that Keysight: (1) Furnish technical information related to commercial computer software or commercial computer software documentation that is not customarily provided to the public; or (2) Relinquish to, or otherwise provide, the government rights in excess of these rights customarily provided to the public to use, modify, reproduce, release, perform, display, or disclose commercial computer software or commercial computer software documentation. No additional

government requirements beyond those set forth in the EULA shall apply, except to the extent that those terms, rights, or licenses are explicitly required from all providers of commercial computer software pursuant to the FAR and the DFARS and are set forth specifically in writing elsewhere in the EULA. Keysight shall be under no obligation to update, revise or otherwise modify the Software. With respect to any technical data as defined by FAR 2.101, pursuant to FAR 12.211 and 27.404.2 and DFARS 227.7102, the U.S. government acquires no greater than Limited Rights as defined in FAR 27.401 or DFAR 227.7103-5 (c), as applicable in any technical data.

Safety Notices

CAUTION

A **CAUTION** notice denotes a hazard. It calls attention to an operating procedure, practice, or the like that, if not correctly performed or adhered to, could result in damage to the product or loss of important data. Do not proceed beyond a CAUTION notice until the indicated conditions are fully understood and met.

WARNING

A **WARNING** notice denotes a hazard. It calls attention to an operating procedure, practice, or the like that, if not correctly performed or adhered to, could result in personal injury or death. Do not proceed beyond a WARNING notice until the indicated conditions are fully understood and met.

1. General Information

Verification Kit Overview 1-1
 Kit Contents 1-1
 Calibration Definitions 1-2
 Installation of the Calibration Definitions 2
 Equipment Required but Not Supplied 1-2
 Options 1-2
 Incoming Inspection 1-2
 Recording the Device Serial Numbers 1-3
 Precision Slotless Connectors 1-4
 Clarifying the Terminology of a Connector Interface 1-5
 Preventive Maintenance 1-5

2. Specifications

Environmental Requirements 2-1
 Temperature—What To Watch Out For 2-1
 Mechanical Characteristics 2-3
 Pin Depth 2-3
 Airline Mechanical Characteristics 2-4
 Electrical Specifications 2-6

3. Use, Maintenance, and Care of the Devices

Electrostatic Discharge 3-1
 Visual Inspection 3-3
 Look for Obvious Defects and Damage First 3-3
 What Causes Connector Wear? 3
 Inspect the Mating Plane Surfaces 3-3
 Inspect Female Connectors 3-4
 Cleaning Connectors 3-5
 Gaging Connectors 3-7
 Connector Gage Accuracy 3-7
 When to Gage Connectors 3-7
 Gaging Procedures 3-9
 Gaging 3.5 mm Connectors 9
 Gaging the Airline 12
 Connections 3-16
 How to Make a Connection 3-16
 Preliminary Connection 16
 Final Connection Using a Torque Wrench 17
 Connecting the Airline 3-18
 How to Separate a Connection 3-20

Contents

Handling and Storage	3-21
4. Performance Verification	
Introduction	4-1
How Keysight Verifies the Devices in Your Kit.	4-1
Recertification	4-2
How Often to Recertify	4-2
Where to Send a Kit for Recertification	4-2
5. Troubleshooting	
Troubleshooting Process	5-1
Compatible Network Analyzers	5-3
Where to Look for More Information	5-4
Returning a Kit or Device to Keysight	5-4
Contacting Keysight	5-4
6. Replaceable Parts	
Replacing the Verification Data.	6-1
Copying Replacement Device Verification Data to the Original Verification Data Media . . .	6-2
Old Verification Device Data – Backup Process	6-2
New Verification Device Data – Transfer Process.	6-3
Replaceable Parts	6-4

1 General Information

Verification Kit Overview

The Keysight 85053B 3.5 mm verification kit provides a set of standards with known characteristics, traceable to a reference (golden) standard in Keysight Technologies calibration lab. This set of standards is used to verify your measurement calibration and also to verify that your network analyzer system is operating within its specifications. The frequency range covered by the 85053B is from 300 kHz to 26.5 GHz.

Kit Contents

The 85053B verification kit includes the following items:

- 20 dB attenuator
- 40 dB attenuator
- 25 Ω mismatch airline
- 50 Ω airline
- User's and Service Guide (this manual)
- Storage box
- USB drive that contains factory-measured verification data for use with the PNA system verification process
- Data sheet for each device that contains factory-measured verification data
- Anti-virus scan report

Refer to **Chapter 6** for a complete list of replaceable part numbers.

NOTE

IMPORTANT! Backup copies of the data sheets, anti-virus scan reports, and the data on the USB drive should be made immediately upon receipt of the verification kit.

NOTE

A file containing the verification data for your kit is maintained for one year from the time of measurement. If you lose this data, contact Keysight – see **“Contacting Keysight” on page 4** for a list of contacts.

Calibration Definitions

The 85053B verification kit is intended to be used with the 85033E and 85052B 3.5 mm calibration kits. Prior to performing a calibration with your network analyzer, the calibration kit must be selected and the calibration definitions for the devices in the kit installed in the network analyzer. Refer to your PNA Help system for instructions on selecting the calibration kit and performing a calibration.

Installation of the Calibration Definitions

The calibration definitions for the kit should be permanently installed in the internal memory or hard disk of the network analyzer. They may already be resident within the analyzer, or you can download them from Keysight's Calibration Kit Definitions Web page at <http://na.support.keysight.com/pna/caldefs/stddefs.html>. In addition, the calibration definitions may be entered manually from the front panel. Refer to your PNA Help system for instructions.

Equipment Required but Not Supplied

Some items are not supplied with the verification kit but are required to ensure successful operation of the kit. Refer to **Table 6-3, "Items Not Included in the Verification Kit,"** for a list of these items and for ordering information.

Options

The following option is available for the 85053B verification kit:

Option 910

This option adds an additional copy of the user's and service guide (this manual).

Incoming Inspection

Verify that the shipment is complete by referring to the contents list in the shipping container.

Check for damage. The foam-lined storage case provides protection during shipping. Verify that this case and its contents are not damaged.

If the case or any device appears damaged, or if the shipment is incomplete, contact Keysight Technologies – see **"Contacting Keysight" on page 4**. Keysight will arrange for repair or replacement of incomplete or damaged shipments without waiting for a settlement from the transportation company. Refer to **"Returning a Kit or Device to Keysight" on page 4** for instructions.

Recording the Device Serial Numbers

In addition to the kit serial number, the devices in this kit are individually serialized (serial numbers are labeled into the body of each device). Record these serial numbers in **Table 1-1**. Recording the serial numbers will prevent confusing the devices in this kit with similar devices from other kits.

Table 1-1 Serial Number Record for the 85053B

Device	Serial Number
Verification kit	_____
20 dB attenuator	_____
40 dB attenuator	_____
50 Ω airline	_____
25 Ω mismatch airline	_____

Precision Slotless Connectors

The female 3.5 mm connectors in this verification kit are metrology-grade, precision slotless connectors (PSC). A characteristic of metrology-grade connectors is direct traceability to national measurement standards through their well-defined mechanical dimensions.

Conventional female center conductors are slotted. When mated, the female center conductor is flared by the male pin. Because physical dimensions determine connector impedance, electrical characteristics of the female connector (and connection pair) are dependent upon the mechanical dimensions of the male pin. While connectors are used in pairs, their male and female halves are always specified separately as part of a standard, instrument, or device under test. Because of these facts, making precision measurements with the conventional slotted connector is very difficult, and establishing a direct traceability path to primary dimensional standards is nearly impossible.

The precision slotless connector was developed to eliminate these problems. All PSCs are female. A PSC incorporates a center conductor with a solid cylindrical shell that defines the outside diameter of the female center pin. Its outside diameter and, therefore, the impedance in its region does not change. The inner part provides an internal contact that flexes to accept the allowed range of male pin diameters.

The calibration of a network analyzer having a conventional slotted female connector on the test port remains valid only when the device under test and all calibration standards have identical male pin diameters. For this reason PSC test port adapters are supplied in most Keysight Technologies calibration kits.

Precision slotless connectors have the following characteristics:

- There is no loss of traceable calibration on test ports when the male pin diameter of the connector on the device under test is different from the male pin diameter of the calibration standard.
- The female PSC and its mating male connector can be measured and specified separately as part of the device either is attached to.
- All female connectors can have a known, stable impedance based only on the diameters of their inner and outer conductors.
- Female calibration standards can be fully specified. Their specifications and traceability are unaffected by the diameter of the male mating pin.
- A fully traceable performance verification is made using a precision 50Ω airline having a PSC.
- Measurement repeatability is enhanced due to non-changing connector characteristics with various pin diameters.

With PSCs on test ports and standards, the percentage of accuracy achieved when measuring at 50 dB return loss levels is comparable to using conventional slotted connectors measuring devices having only 30 dB return loss. This represents an accuracy improvement of about 10 times.

Clarifying the Terminology of a Connector Interface

In this document and in the prompts of the PNA calibration wizard, the gender of cable connectors and adapters is referred to in terms of the center conductor. For example, a connector or device designated as 1.85 mm –f– has a 1.85 mm female center conductor.

A connector gage is referred to in terms of the connector that it measures. For instance, a male connector gage has a female connector on the gage so that it can measure male devices.

Preventive Maintenance

The best techniques for maintaining the integrity of the devices in this kit include:

- routine visual inspection
- cleaning
- proper gaging
- proper connection techniques

All of these are described in **Chapter 3**. Failure to detect and remove dirt or metallic particles on a mating plane surface can degrade repeatability and accuracy and can damage any connector mated to it. Improper connections, resulting from pin depth values being out of specification (see **Table 2-2 on page 4**), or from bad connection techniques, can also damage these devices.

General Information
Preventive Maintenance

2 Specifications

Environmental Requirements

NOTE

Samples of this product have been type-tested in accordance with the Keysight Environmental Test Manual and verified to be robust against the environmental stresses of storage, transportation and end-use; those stresses include but are not limited to temperature, humidity, shock, vibration, altitude and power-line conditions. Test methods are aligned with IEC 60068-2 and levels are similar to MIL-PRF-28800F Class 3.

Table 2-1 Environmental Requirements

Parameter	Required Values/Ranges
Temperature	
Operating ^a	+20 °C to +26 °C
Storage	-40 °C to +71 °C
Error-corrected range ^b	±1 °C of measurement calibration temperature
Altitude	
Operating	< 4,500 meters (*15,000 feet)
Storage	< 15,000 meters (*50,000 feet)
Relative humidity	Type tested, 0% to 95% at 40 °C, non-condensing

a. The temperature range over which the calibration standards maintain conformance to their specifications.

b. The allowable network analyzer ambient temperature drift during measurement calibration and during measurements when the network analyzer error correction is turned on. Also, the range over which the network analyzer maintains its specified performance while correction is turned on.

Temperature—What To Watch Out For

Due to the small dimensions of the devices, electrical characteristics will change with temperature. Therefore, the operating temperature is a critical factor in their performance, and must be stable before use.

NOTE

IMPORTANT! Avoid unnecessary handling the devices during use because your fingers are a heat source.

Mechanical Characteristics

Mechanical characteristics such as center conductor protrusion and pin depth are not warranted performance specifications. They are, however, important supplemental characteristics related to electrical performance. Keysight Technologies verifies the mechanical characteristics of the devices in this kit with special gaging processes and electrical testing. This ensures that the device connectors do not exhibit any improper pin depth when the kit leaves the factory.

“Gaging Connectors” on page 7 explains how to use gages to determine if the kit devices have maintained their mechanical integrity. Refer to **Table 2-2 on page 4** for typical and observed pin depth limits.

Pin Depth

Pin depth is the distance the center conductor mating plane differs from being flush with the outer conductor mating plane. See **Figure 2-1**. The pin depth of a connector can be in one of two states: either protruding or recessed.

Protrusion is the condition in which the center conductor extends beyond the outer conductor mating plane. This condition will indicate a positive value on the connector gage.

Recession is the condition in which the center conductor is set back from the outer conductor mating plane. This condition will indicate a negative value on the connector gage.

Figure 2-1 Connector Pin Depth

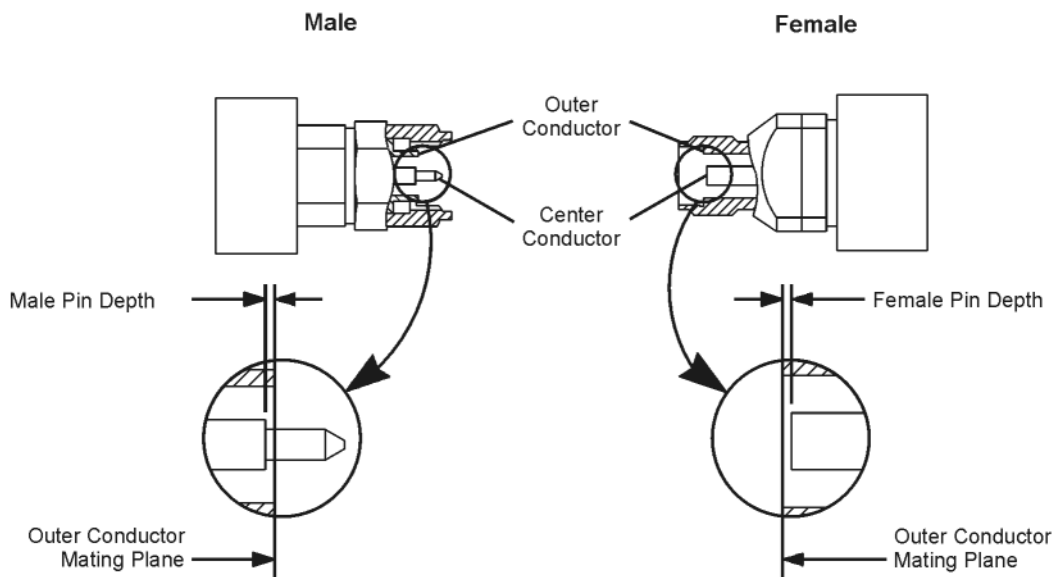

ph51b

Table 2-2 Connector Pin Depths

Connectors	Pin Depth ^{ab}	
	millimeters	inches
Attenuators		
Male	0.0000 to -0.0076	0.0000 to -0.0030
Female	0.0000 to -0.0076	0.0000 to -0.0030
Airlines ^c	+0.0025 ^d to -0.0100	-0.0001 ^d to -0.0004

- A positive number indicates pin protrusion. A negative number indicates pin recession.
- There is some degree of pin depth measurement uncertainty, due to the limits of the repeatability of the mechanical pin depth gage.
- The relationship between the length of the inner conductor and the length of the outer conductor determines the airline center conductor recession. Refer to **"Gaging the Airline" on page 12.**
- In this case, the center conductor is 0.0001 inch (0.0025 mm) longer than the outer conductor.

Airline Mechanical Characteristics

The dimensions of the airline outer conductor are shown in **Figure 2-2**. This outer conductor is common to both airlines. Two conductors are provided with the kit.

The dimensions of the 50Ω airline and the 25Ω mismatch airline are shown in [Figure 2-3](#) and [Figure 2-4](#).

CAUTION

The center and outer conductors of the airlines in this kit have been mechanically measured and matched. Do not use the center or outer conductors provided in this kit with a center or outer conductor from any other airline. Damage to the airline or attaching connector may result.

Figure 2-2 Airline Outer Conductor

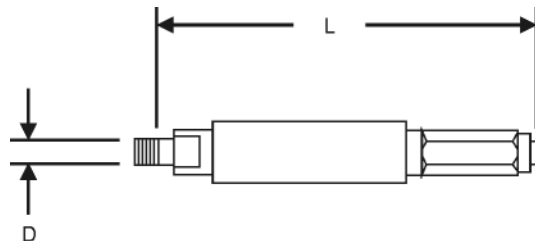

ph52b

Table 2-3

Dimension	millimeters	inches
D	3.500 ±0.004	0.13780 ±0.00016
L	74.924 ±0.025	2.950 ±0.001

Figure 2-3 50Ω Airline Center Conductor

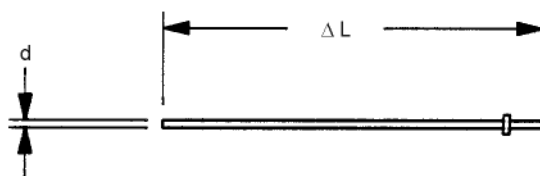

ph53b

Table 2-4

Dimension	millimeters	inches
d	1.520 ±0.003	0.0598 ±0.0001
ΔL	+0.0025 to -0.0100	+0.0001 to -0.0004

Figure 2-4 25Ω Mismatch Airline Center Conductor

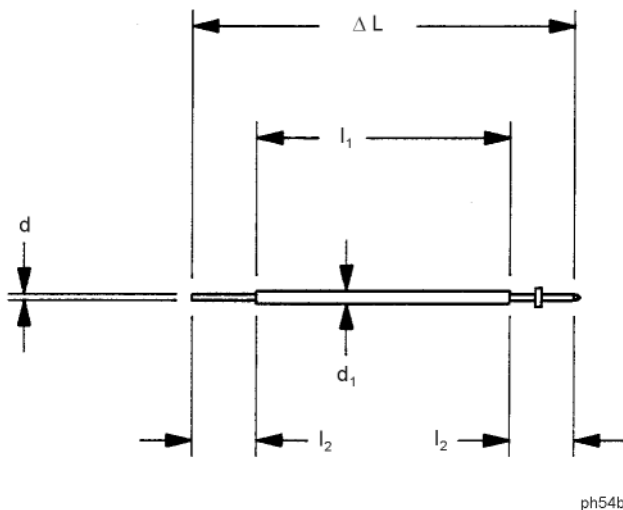

Table 2-5

Dimension	millimeters	inches
d	2.306 ±0.005	0.09087 ±0.0002
d ₁	1.520 ±0.008	0.0598 ±0.0003
l ₁	49.943 ±0.019	1.9663 ±0.0007
l ₂	12.521 ±0.050	0.4930 ±0.0020
ΔL	+0.0025 to -0.0100	+0.0001 to -0.0004

Electrical Specifications

At the factory, each verification device is electrically characterized on a network analyzer measurement system. These factory measurements are traceable to the National Institute of Standards and Technology (NIST) through mechanical and electrical paths (for more information on traceability, contact Keysight Technologies. Refer to **“Contacting Keysight” on page 4** for a list of contacts.

The factory-measured data for each device is supplied in print and on USB drive with your kit.

3 Use, Maintenance, and Care of the Devices

Electrostatic Discharge

Protection against electrostatic discharge (ESD) is essential while connecting, inspecting, or cleaning connectors attached to a static-sensitive circuit (such as those found in test sets).

Static electricity can build up on your body and can easily damage sensitive internal circuit elements when discharged. Static discharges too small to be felt can cause permanent damage. Devices such as calibration components and devices under test (DUT), can also carry an electrostatic charge. To prevent damage to the test set, components, and devices:

- **always** wear a grounded wrist strap having a 1 M Ω resistor in series with it when handling components and devices or when making connections to the test set.
- **always** use a grounded, conductive table mat while making connections.
- **always** wear a heel strap when working in an area with a conductive floor. If you are uncertain about the conductivity of your floor, wear a heel strap.
 1. Connect a short (from your calibration kit) to one end of the cable to short the center conductor to the outer conductor.
 2. While wearing a grounded wrist strap, grasp the outer shell of the cable connector.
 3. Connect the other end of the cable to the test port.
 4. Remove the short from the cable.

Figure 3-1 shows a typical ESD protection setup using a grounded mat an wrist strap. Refer to **Table 6-3 on page 5** for information on ordering supplies for ESD protection.

Figure 3-1 ESD Protection Setup

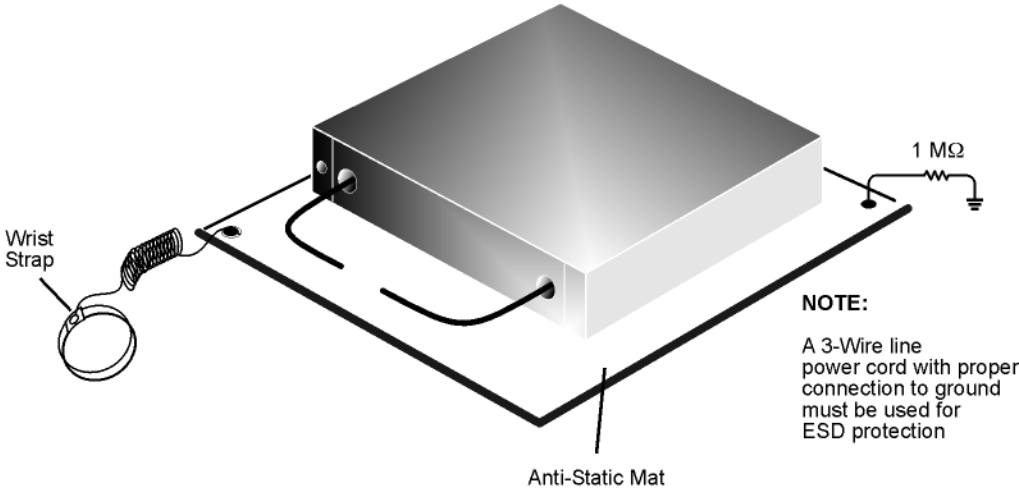

esd_setup

Visual Inspection

Visual inspection and, if necessary, cleaning should be done every time a connection is made. Metal particles from the connector threads may fall into the connector when it is disconnected.

CAUTION

Devices with damaged connectors should be immediately discarded or clearly marked and set aside for repair. A damaged device will in turn damage any good connector to which it is attached. Determine the cause of the damage before connecting a new, undamaged connector in the same configuration.

In some cases, magnification is necessary to see damage to a connector; a magnifying device with a magnification of $\geq 10\times$ is recommended. However, not all defects that are visible only under magnification will affect the electrical performance of the connector. Use the following guidelines when evaluating the integrity of a connector.

Look for Obvious Defects and Damage First

Examine the connectors first for obvious defects or damage: badly worn plating on the connector interface, deformed threads or bent, broken, or misaligned center conductors. Connector nuts should move smoothly and be free of burrs, loose metal particles, and rough spots.

What Causes Connector Wear?

Connector wear is caused by connecting and disconnecting the devices. The more use a connector gets, the faster it wears and degrades. The wear is greatly accelerated when connectors are not kept clean, or are not connected properly.

Connector wear eventually degrades performance of the device. Calibration devices should have a long life if their use is on the order of a few times per week. Replace devices with worn connectors.

The test port connectors on the network analyzer test set may have many connections each day, and are therefore more subject to wear. It is recommended that an adapter be used as a test port saver to minimize the wear on the test set's test port connectors.

Inspect the Mating Plane Surfaces

Flat contact between the connectors at all points on their mating plane surfaces is required for a good connection. See **Figure 2-1 on page 4**. Look especially for deep scratches or dents, and for dirt and metal particles on the connector mating plane surfaces. Also look for signs of damage due to excessive or uneven wear or misalignment.

Light burnishing of the mating plane surfaces is normal, and is evident as light scratches or shallow circular marks distributed more or less uniformly over the mating plane surface. Other small defects and cosmetic imperfections are also normal. None of these affect electrical or mechanical performance. If a connector shows deep scratches or dents, particles clinging to the mating plane surfaces, or uneven wear, clean and inspect it again.

Inspect Female Connectors

Inspect the contact fingers in the female center conductor carefully. These can be bent or broken, and damage to them is not always easy to see. A connector with damaged contact fingers will not make good electrical contact and must be replaced.

NOTE

This is particularly important when mating nonprecision to precision devices.

The female connectors in this calibration kit are metrology-grade, precision slotless connectors (PSC). Precision slotless female connectors are used to improve accuracy. With PSCs on test ports and standards, the accuracy achieved when measuring at 50 dB return loss levels is comparable to using conventional slotted connectors measuring devices having only 30 dB return loss. This represents an accuracy improvement of about 10 times.

Conventional female center conductors are slotted and, when mated, are flared by the male pin. Because physical dimensions determine connector impedance, this change in physical dimension affects electrical performance, making it very difficult to perform precision measurements with conventional slotted female connectors.

The precision slotless connector was developed to eliminate this problem. The PSC has a center conductor with a solid cylindrical shell, the outside diameter of which does not change when mated. Instead, this center conductor has an internal contact that flexes to accept the male pin.

Cleaning Connectors

1. Use Compressed Air or Nitrogen

Clean connectors are essential for ensuring the integrity of RF and microwave coaxial connections.

WARNING

Always use protective eyewear when using compressed air or nitrogen.

Use compressed air (or nitrogen) to loosen particles on the connector mating plane surfaces.

You can use any source of clean, dry, low-pressure compressed air or nitrogen that has an effective oil-vapor filter and liquid condensation trap placed just before the outlet hose.

Ground the hose nozzle to prevent electrostatic discharge, and set the air pressure to less than 414 kPa (60 psi) to control the velocity of the air stream. High-velocity streams of compressed air can cause electrostatic effects when directed into a connector. These electrostatic effects can damage the device. Refer to [“Electrostatic Discharge” on page 1](#) for additional information.

2. Clean the Connector Threads

WARNING

Keep isopropyl alcohol away from heat, sparks, and flame. Store in a tightly closed container. It is extremely flammable. In case of fire, use alcohol foam, dry chemical, or carbon dioxide; water may be ineffective.

Use isopropyl alcohol with adequate ventilation and avoid contact with eyes, skin, and clothing. It causes skin irritation, may cause eye damage, and is harmful if swallowed or inhaled. It may be harmful if absorbed through the skin. Wash thoroughly after handling.

In case of spill, soak up with sand or earth. Flush spill area with water.

Dispose of isopropyl alcohol in accordance with all applicable federal, state, and local environmental regulations.

Use a lint-free swab or cleaning cloth moistened with isopropyl alcohol to remove any dirt or stubborn contaminants on a connector that cannot be removed with compressed air or nitrogen. Refer to [Table 6-3 on page 5](#) for a part number for cleaning swabs.

- a. Apply a small amount of isopropyl alcohol to a lint-free cleaning swab.
- b. Clean the connector threads.

- c. Let the alcohol evaporate, then blow the threads dry with a gentle stream of clean, low-pressure compressed air or nitrogen. Always completely dry a connector before you reassemble or use it.

3. Clean the Mating Plane Surfaces

- a. Apply a small amount of isopropyl alcohol to a lint-free cleaning swab.
- b. Clean the center and outer conductor mating plane surfaces. Refer to **Figure 2-1 on page 4**. When cleaning a female connector, avoid snagging the swab on the center conductor contact fingers by using short strokes.
- c. Let the alcohol evaporate, then blow the connector dry with a gentle stream of clean, low-pressure compressed air or nitrogen. Always completely dry a connector before you reassemble or use it.

4. Inspect

Inspect the connector to make sure that no particles or residue remain. Refer to **“Visual Inspection” on page 3**.

Gaging Connectors

The gages available from Keysight Technologies are intended for preventive maintenance and troubleshooting purposes only. They are effective in detecting excessive center conductor protrusion or recession, and conductor damage on DUTs, test accessories, and the calibration kit devices. **Do not use the gages for precise pin depth measurements.**

Connector Gage Accuracy

The connector gages are only capable of performing coarse measurements. They do not provide the degree of accuracy necessary to precisely measure the pin depth of the kit devices. This is partially due to the repeatability uncertainties that are associated with the measurement. Only the factory—through special gaging processes and electrical testing— can accurately verify the mechanical characteristics of the devices.

With proper technique, the gages are useful in detecting gross pin depth errors on device connectors. To achieve maximum accuracy, random errors must be reduced by taking the average of at least three measurements having different gage orientations on the connector. Even then, the resultant average can be in error by as much as ± 0.0001 inch due to systematic (biasing) errors usually resulting from worn gages and gage masters. As the gages undergo more use, the systematic errors can become more significant in the accuracy of the measurement.

When to Gage Connectors

Gage a connector at the following times:

- Prior to using a device for the first time: record the pin depth measurement so that it can be compared with future readings. This serves as a good troubleshooting tool when you suspect damage may have occurred to the device.

NOTE

When measuring pin depth, the measured value (resultant average of three or more measurements) contains measurement uncertainty, and is not necessarily the true value. Always compare the measured value with the **observed** pin depth limits (which account for measurement uncertainties) in [Table 2-2 on page 4](#) and with previously recorded values to evaluate the condition of device connectors.

-
- If either visual inspection or electrical performance suggests that the connector interface may be out of typical range (due to wear or damage, for example).
 - If a verification device is used by someone else or on another system or piece of equipment.

Use, Maintenance, and Care of the Devices
Gaging Connectors

- Initially after every 100 connections, and after that as often as experience indicates.

Gaging Procedures

Gaging 3.5 mm Connectors

NOTE

Always hold a connector gage by the gage barrel, below the dial indicator. This gives the best stability, and improves measurement accuracy. (Cradling the gage in your hand or holding it by the dial applies stress to the gage plunger mechanism through the dial indicator housing.)

1. Select the proper gage for your connector. Refer to [Table 6-3 on page 5](#) for gage part numbers.
2. Inspect and clean the gage, gage master, and device to be gaged. Refer to [“Visual Inspection”](#) and [“Cleaning Connectors”](#) earlier in this chapter.
3. Zero the connector gage (refer to [Figure 3-2](#)):
 - a. While holding the gage by the barrel, and without turning the gage or the device, connect the gage to the gage master by interconnecting the male and female connectors. Connect the nut finger tight. Do not overtighten.
 - b. Using an open-end wrench to keep the device body from rotating, use the torque wrench included in the kit to tighten the connecting nut to the specified torque. Refer to [“Final Connection Using a Torque Wrench” on page 17](#) for additional information.
 - c. As you watch the gage pointer, gently tap the barrel of the gage to settle the reading.

The gage pointer should line up exactly with the zero mark on the gage. If not, adjust the zero set knob until the gage pointer lines up exactly with the zero mark.
 - d. Remove the gage master.
4. Gage the device connector (refer to [Figure 3-2](#)):
 - a. While holding the gage by the barrel, and without turning the gage or the device, connect the gage to the device by interconnecting the male and female connectors. Connect the nut finger-tight. Do not overtighten.
 - b. Using an open-end wrench to keep the device body from rotating, use the torque wrench included in the kit to tighten the connecting nut to the specified torque. Refer to [“Final Connection Using a Torque Wrench” on page 17](#) for additional information.
 - c. Gently tap the barrel of the gage with your finger to settle the gage reading.
 - d. Read the gage indicator dial. Read **only** the black \pm signs; **not** the red \pm signs.

For maximum accuracy, measure the connector a minimum of three times and take an average of the readings. After each measurement, rotate the gage a quarter-turn to reduce measurement variations that result from the gage or the connector face not being exactly perpendicular to the center axis.

- e. Compare the average reading with the observed pin depth limits in [Table 2-2 on page 4](#).

Figure 3-2 Gaging 3.5 mm Connectors

Note:

Although male devices are shown in this illustration, the procedure is essentially the same for female devices.

Zero the Connector Gage

- Connect the gage to the gage master.
- Torque the connecting nut.
- Gently tap the gage barrel to settle the reading.
- Using the zero set knob, adjust the gage pointer to line up exactly with the zero mark.
- Remove the gage master.

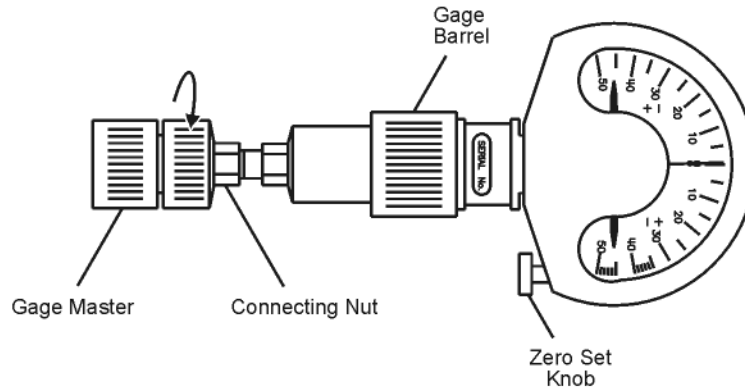

Gage the Device Connector

- Connect the gage to the device being measured.
- Torque the connecting nut.
- Gently tap the gage barrel to settle the reading.
- Read recession or protrusion from the gage.
- Remove the device.
- Repeat two additional times and average the three readings.

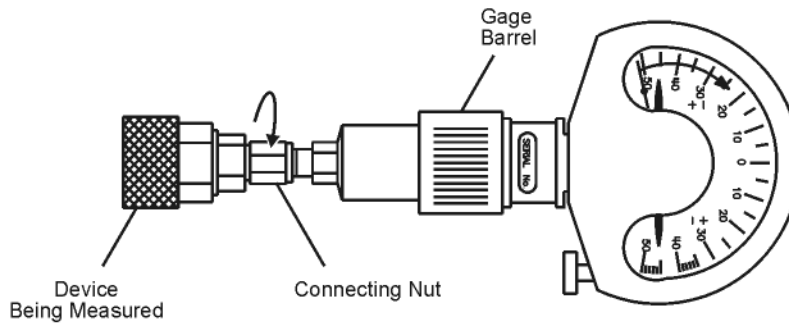

ph71a

Gaging the Airline

The airlines in this kit are measured and matched for length at the factory using special fixtures and gages. Because the gages supplied in the calibration kits do not have the accuracy of the factory gages, use the following procedure for very general results only. Perform this procedure whenever you suspect that a center conductor has been switched with another airline or that a device has been damaged.

NOTE

Always hold a connector gage by the gage barrel, below the dial indicator. This gives the best stability, and improves measurement accuracy.

1. Select a male connector gage and male short for this procedure. Refer to [Table 6-3 on page 5](#) for part numbers.
2. Inspect and clean the mating surfaces and connector threads of the short, airline, and gage. Refer to [“Visual Inspection”](#) and [“Cleaning Connectors”](#) earlier in this chapter.
3. Zero the connector gage (refer to [Figure 3-3](#)):
 - a. While holding the gage by the barrel and without turning the gage or the short, connect the gage to the short by interconnecting the male and female connectors. Connect the nut finger tight. Do not overtighten.
 - b. Using an open-end wrench to keep the device body from rotating, use the torque wrench recommended for use with this kit to tighten the connecting nut to the specified torque. Refer to [“Final Connection Using a Torque Wrench” on page 17](#) for additional information.
 - c. As you watch the gage pointer, gently tap the barrel of the gage to settle the reading.
 - d. The gage pointer should line up exactly with the zero mark on the gage. If not, loosen the dial lock screw on the gage and rotate the gage dial so that the pointer is aligned with the zero mark. Tighten the dial lock screw.
 - e. Without turning the short or the gage, remove the short from the gage. Refer to [“How to Separate a Connection” on page 20](#).

Figure 3-3 Zeroing the Connector Gage Using the Short

Zero the Connector Gage

- Connect the gage to the short.
- Torque the connecting nut.
- Gently tap the gage barrel to settle the reading.
- Using the zero set knob, adjust the gage pointer to line up exactly with the zero mark.
- Remove the short.

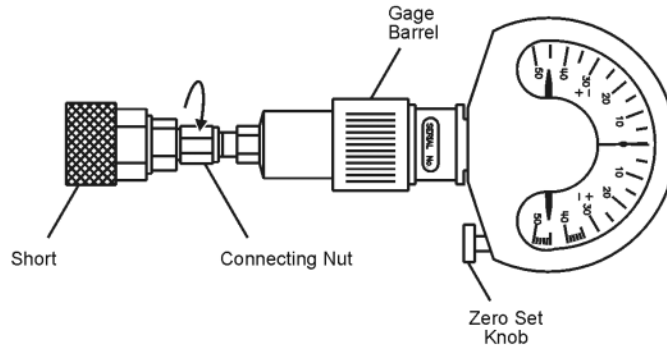

ph55b

4. Assemble the airline and center conductor (refer to [Figure 3-4](#)):

CAUTION

Wear gloves while performing the following steps. You will be touching the exposed center conductor of the airline. Do not transfer oil or dirt from your fingers to the center conductor. See [“Handling and Storage” on page 21](#).

- a. Remove the center conductor from its plastic case. Make sure you select the correct center conductor for the airline you are connecting. Refer to [Figure 2-3](#) and [Figure 2-4 on page 6](#) for illustrations of both center conductors.
- b. Remove the protective end cap from the female end (the end without the connecting nut) of the outer conductor.
- c. Leave the protective end cap on the male end of the airline to prevent the center conductor from falling out of the outer conductor.
- d. Insert the center conductor into the outer conductor so that the female end of the center conductor is toward the female end of the outer conductor (the end without the connector nut). Refer to [Figure 3-4](#).

Figure 3-4 Assembling the Airline and Center Conductor

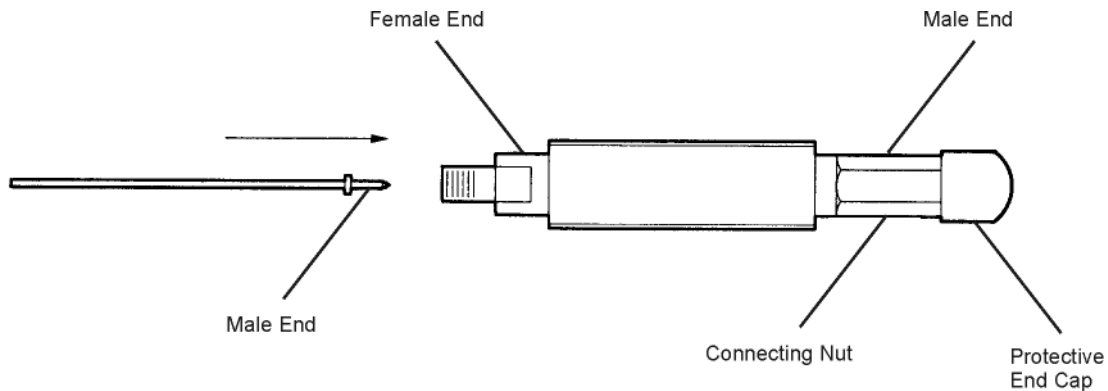

ph56b

5. Attach the short:

- a. Without turning the airline or the short, connect the airline to the short by interconnecting the male and female connectors. Connect the nut finger tight. Do not overtighten.
- b. Using an open-end wrench to keep the device body from rotating, use the torque wrench recommended for use with this kit to tighten the connecting nut to the specified torque. Refer to **“Final Connection Using a Torque Wrench” on page 17** for additional information.
- c. Remove the protective end cap from the male end of the airline.

NOTE

Do not allow either the center or outer conductor of the airline to come in contact with a metal or harder surface. The soft gold plating can be displaced, changing the pin depth and thus the performance of the airline.

- d. Carefully press the male end of the center conductor lightly against a firm flat object to seat the center conductor into the short.
- 6. Gage the airline (refer to Figure 3-5):**
- a. While holding the gage by the barrel, and without turning the gage or the airline, connect the gage to the airline by interconnecting the male and female connectors. Connect the nut finger tight. Do not overtighten.
 - b. Using an open-end wrench to keep the device body from rotating, use the torque wrench recommended for use with this kit to tighten the connecting nut to the specified torque. Refer to **“Final Connection Using a Torque Wrench” on page 17** for additional information.
 - c. Gently tap the barrel of the gage with your finger to settle the gage reading.

Figure 3-5 Gaging the Airline

Gage the Airline

- Connect the gage to the airline (with short attached).
- Torque the connecting nut.
- Gently tap the gage barrel to settle the reading.
- Read recession or protrusion from the gage.
- Remove the airline.
- Repeat two additional times and average the three readings.

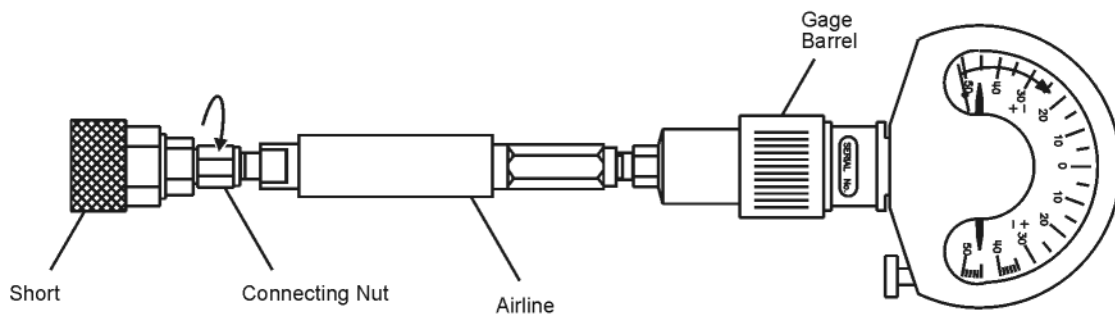

ph57b

- Wait approximately 5 minutes for the temperature to stabilize. Do not touch the airline, short, or gage during this time as your body temperature will affect the temperature of the devices.

The gage reading should be within the pin depth specifications listed in [Table 2-2 on page 4](#). Remember, the gage is intended for coarse measurements only and has an accuracy of ± 0.0001 in.

- Disconnect the short and gage from the airline:

NOTE

If the airline center conductor does not disengage from the device center conductor, gently pull the center conductors apart and then push the airline center conductor back inside the outer conductor of the airline.

- Without turning the airline or the gage, remove the gage from the airline. Refer to [“How to Separate a Connection” on page 20](#).
- Replace the protective end cap on the airline to prevent the center conductor from sliding out of the outer conductor.
- Without turning the airline or the short, remove the short from the airline. Refer to [“How to Separate a Connection” on page 20](#).
- If you will not be using the airline again immediately, slide the center conductor out of the outer conductor and store the center conductor in the plastic case provided.
- Replace the other protective end cap on the outer conductor and store the center and outer conductors in the foam lined storage case.

Connections

Good connections require a skilled operator. **The most common cause of measurement error is bad connections.** The following procedures illustrate how to make good connections.

How to Make a Connection

Preliminary Connection

1. Ground yourself and all devices. Wear a grounded wrist strap and work on a grounded, conductive table mat. Refer to **“Electrostatic Discharge” on page 1** for ESD precautions.
2. Visually inspect the connectors. Refer to **“Visual Inspection” on page 3**.
3. If necessary, clean the connectors. Refer to **“Cleaning Connectors” on page 5**.
4. Use a connector gage to verify that all center conductors are within the pin depth values listed in **Table 2-2 on page 4**. Refer to **“Gaging Connectors” on page 7**.
5. Carefully align the connectors. The male connector center pin must slip concentrically into the contact finger of the female connector.
6. Push the connectors straight together and tighten the connector nut finger tight.

CAUTION

Do **not** turn the device body. Turn only the connector nut. Damage to the center conductor can occur if the device body is rotated.

Do not twist or screw the connectors together. As the center conductors mate, there is usually a slight resistance.

7. The preliminary connection is tight enough when the mating plane surfaces make uniform, light contact. Do not overtighten this connection.

A connection in which the outer conductors make gentle contact at all points on both mating surfaces is sufficient. Very light finger pressure is enough to accomplish this.

8. Make sure the connectors are properly supported. Relieve any side pressure on the connection from long or heavy devices or cables.

Final Connection Using a Torque Wrench

Use a torque wrench to make a final connection. [Table 3-1](#) provides information about the torque wrench recommended for use with the calibration kit. A torque wrench is not included in the calibration kit. Refer to [Table 6-3 on page 5](#) for part number and ordering information.

Table 3-1 Torque Wrench Information

Connector Type	Torque Setting	Torque Tolerance
3.5 mm	90 N-cm (8 in-lb)	± 9.0 N-cm (± 0.8 in-lb)

Using a torque wrench guarantees that the connection is not too tight, preventing possible connector damage. It also guarantees that all connections are equally tight each time.

Prevent the rotation of anything other than the connector nut that you are tightening. It may be possible to do this by hand if one of the connectors is fixed (as on a test port). However, it is recommended that you use an open-end wrench to keep the body of the device from turning.

1. Position both wrenches within 90 degrees of each other before applying force. See [Figure 3-6](#). Wrenches opposing each other (greater than 90 degrees apart) will cause a lifting action which can misalign and stress the connections of the devices involved. This is especially true when several devices are connected together.

Figure 3-6 Wrench Positions

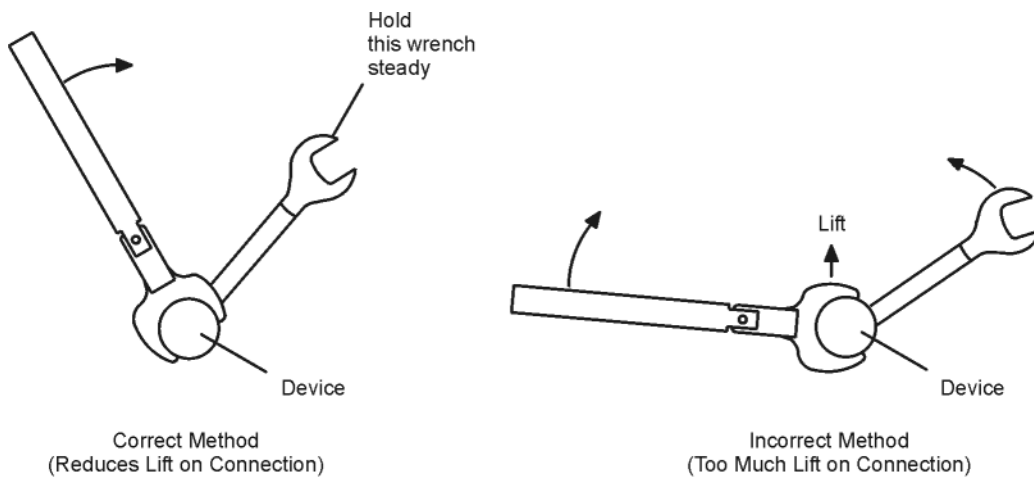

ph711a

2. Hold the torque wrench lightly, at the end of the handle only (beyond the groove). See [Figure 3-7](#).

Figure 3-7 Using the Torque Wrench

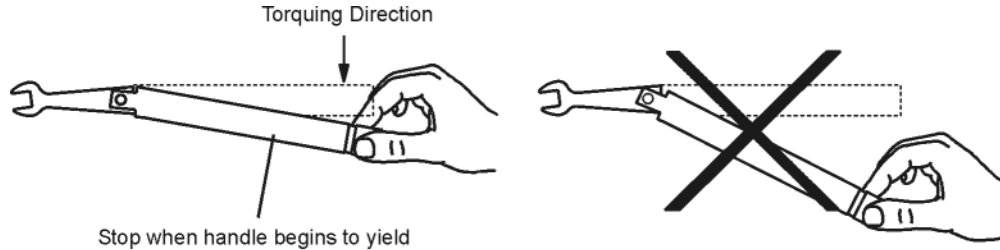

ph712a

3. Apply downward force perpendicular to the wrench handle. This applies torque to the connection through the wrench.

Do not hold the wrench so tightly that you push the handle straight down along its length rather than pivoting it, otherwise you apply an unknown amount of torque.

CAUTION

You don't have to fully break the handle of the torque wrench to reach the specified torque; doing so can cause the handle to kick back and loosen the connection. Any give at all in the handle is sufficient torque.

4. Tighten the connection just to the torque wrench break point. The wrench handle gives way at its internal pivot point. See [Figure 3-7](#). Do not tighten the connection further.

Connecting the Airline

CAUTION

Before making any connections to the test set, be sure that bias power to the test set is off, and take care to avoid electrostatic discharge. Refer to ["Electrostatic Discharge" on page 1](#).

CAUTION

Wear gloves while performing the following procedure. You will be touching the exposed center conductor of the airline. It is important that you do not transfer oil and dirt from your fingers to this center conductors. Refer to ["Handling and Storage" on page 21](#).

Before making the connection, refer to ["Preliminary Connection" on page 16](#).

Cables with the appropriate adapters on the ends should be connected to PORT 1 and PORT 2 of the network analyzer.

1. Remove the center conductor from its plastic case. Make sure you select the correct center conductor for the airline you are connecting. Refer to [Figure 2-3](#) and [Figure 2-4 on page 6](#) for illustrations of both center conductors.

2. Remove the protective end cap from the female end (the end without the connecting nut) of the airline.
3. Leave the protective end cap on the male end of the airline to prevent the center conductor from falling out of the outer conductor.

Figure 3-8 Airline Center Conductor Placement

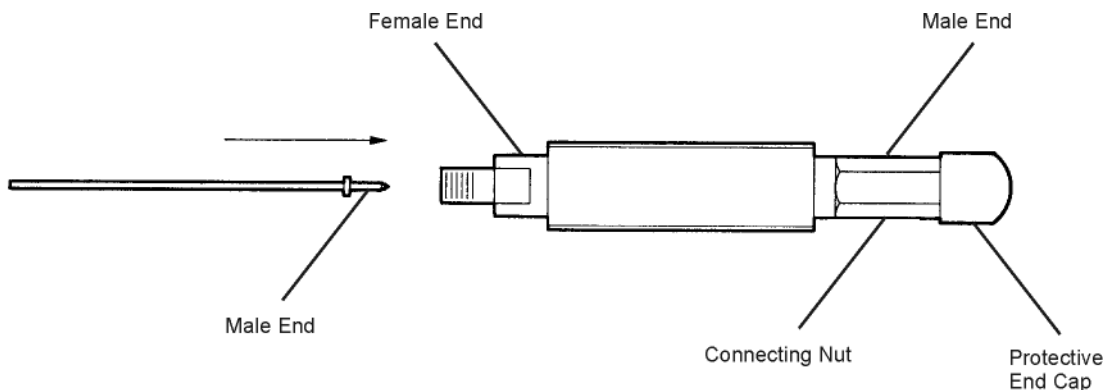

ph56b

4. Insert the female end of the center conductor into the outer conductor so that the female end of the center conductor is toward the female end of the outer conductor (the end without the connector nut). Refer to **Figure 3-8**.

NOTE

To avoid damaging the airline center conductor, always keep it in direct line with the center conductor of the device to which it is being connected.

5. Bring the airline—with center conductor installed—toward the cable connector and mate the female end of the airline center conductor with the center conductor of the cable connector. Refer to **Figure 3-9**.

Figure 3-9 Connecting the Airline

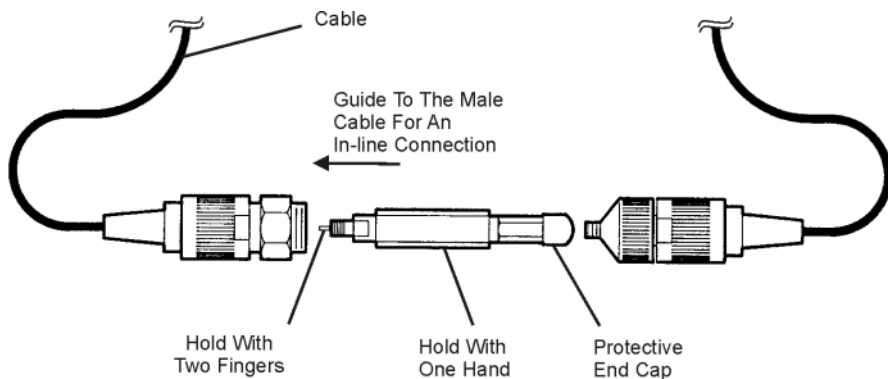

ph58b

6. Push the airline's female coupling sleeve forward and turn the connecting nut (of the adapter attached to the cable) to mate the outer conductor of the airline with the adapter. Connect the nut finger tight. Do not overtighten.
7. Remove the protective end cap from the male end of the airline. Align and insert the male end of the airline center conductor into the female end of the cable adapter and mate the outer conductors. Connect the nut finger tight. Do not overtighten.
8. Using an open-end wrench, hold the sliding female coupling sleeve on the female end of the outer conductor to keep it from rotating. Refer to [Figure 3-10](#). Use the torque wrench recommended for use with this kit to tighten the adapter connecting nut to the specified torque. Refer to [“Final Connection Using a Torque Wrench”](#) on page 17.
9. Using an open-end wrench to keep the cable adapter from rotating, use the torque wrench recommended for use with this kit to tighten the airline male-end connecting nut to the specified torque.

Figure 3-10 Torquing the Connections

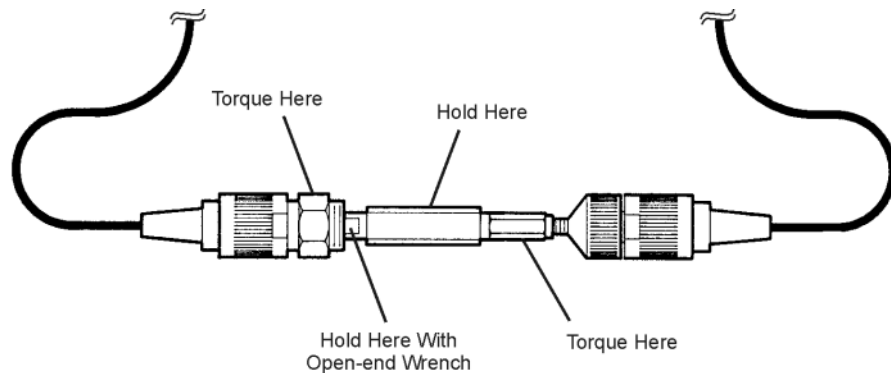

ph59b

How to Separate a Connection

NOTE

Do **not** turn the device body. Only turn the connector nut. Damage to the center conductor can occur if the device body is rotated.

1. Use an open-end wrench to prevent the device body from turning.
2. Use another open-end wrench to loosen the connector nut.
3. Complete the disconnection by hand, turning only the connector nut.

4. Pull the connectors straight apart without twisting, rocking, or bending either of the connectors.

NOTE

If disconnecting an airline and the airline center conductor does not disengage from the device center conductor, gently pull the center conductors apart and then push the airline center conductor back inside the outer conductor of the airline.

Handling and Storage

- **Do** install the protective end caps and store the devices in the foam-lined storage case when not in use.
- **Do** keep connectors and airlines clean.
- **Do not** store connectors and airlines loose in a box, or in a desk or bench drawer. This is the most common cause of connector damage during storage.
- **Do not** touch mating plane surfaces. Natural skin oils and microscopic particles of dirt are easily transferred to a connector interface and are very difficult to remove.
- **Do not** set connectors contact-end down on a hard surface. The plating and the mating plane surfaces can be damaged if the interface comes in contact with any hard surface.

Use, Maintenance, and Care of the Devices
Handling and Storage

4 Performance Verification

Introduction

The performance of your verification kit can only be verified by returning the kit to Keysight Technologies for recertification. The equipment required to verify the specifications of the devices in the kit has been specially manufactured and is not commercially available.

How Keysight Verifies the Devices in Your Kit

Keysight verifies the specifications of these devices as follows:

- 1. The residual microwave error terms of the test system are verified with precision airlines and shorts that are directly traced to the National Institute of Standards and Technology (NIST). The airline and short characteristics are developed from mechanical measurements. The mechanical measurements and material properties are carefully modeled to give very accurate electrical representation. The mechanical measurements are then traced to NIST through various plug and ring gages and other mechanical measurements.**
- 2. Each device is electrically tested on this system. For the initial (before sale) testing of the devices, Keysight includes the test measurement uncertainty as a guardband to guarantee each device meets the published specification. For recertifications (after sale), no guardband is used and the measured data is compared directly with the specification to determine the pass or fail status. The measurement uncertainty for each device is, however, recorded in the calibration report that accompanies recertified kits.**

These two steps establish a traceable link to NIST for Keysight to the extent allowed by the institute's calibration facility. The specifications data provided for the devices in the kit is traceable to- NIST through Keysight Technologies.

Recertification

The following will be provided with a recertified kit:

- a new calibration sticker affixed to the case
- a certificate of calibration
- a calibration report for each device in the kit listing measured values, specifications, and uncertainties

NOTE

A list of NIST traceable numbers may be purchased upon request to be included in the calibration report.

Keysight Technologies offers a **Standard** calibration for the recertification of the kit. For more information, contact Keysight Technologies – see [“Contacting Keysight” on page 4](#).

How Often to Recertify

The suggested initial interval for recertification is 12 months or sooner. The actual need for recertification depends on the use of the kit. After reviewing the results of the initial recertification, you may establish a different recertification interval that reflects the usage and wear of the kit.

NOTE

The recertification interval should begin on the date the kit is **first used** after the recertification date.

Where to Send a Kit for Recertification

Contact Keysight Technologies for information on where to send your kit for recertification. See [“Contacting Keysight” on page 4](#). Refer to [“Returning a Kit or Device to Keysight” on page 4](#) for details on sending your kit.

5 Troubleshooting

Troubleshooting Process

If your network analyzer does not pass performance verification, follow the steps in **Figure 5-1** to determine the cause of the failure and the correct action to take to correct the failure.

Figure 5-1 Troubleshooting Flowchart

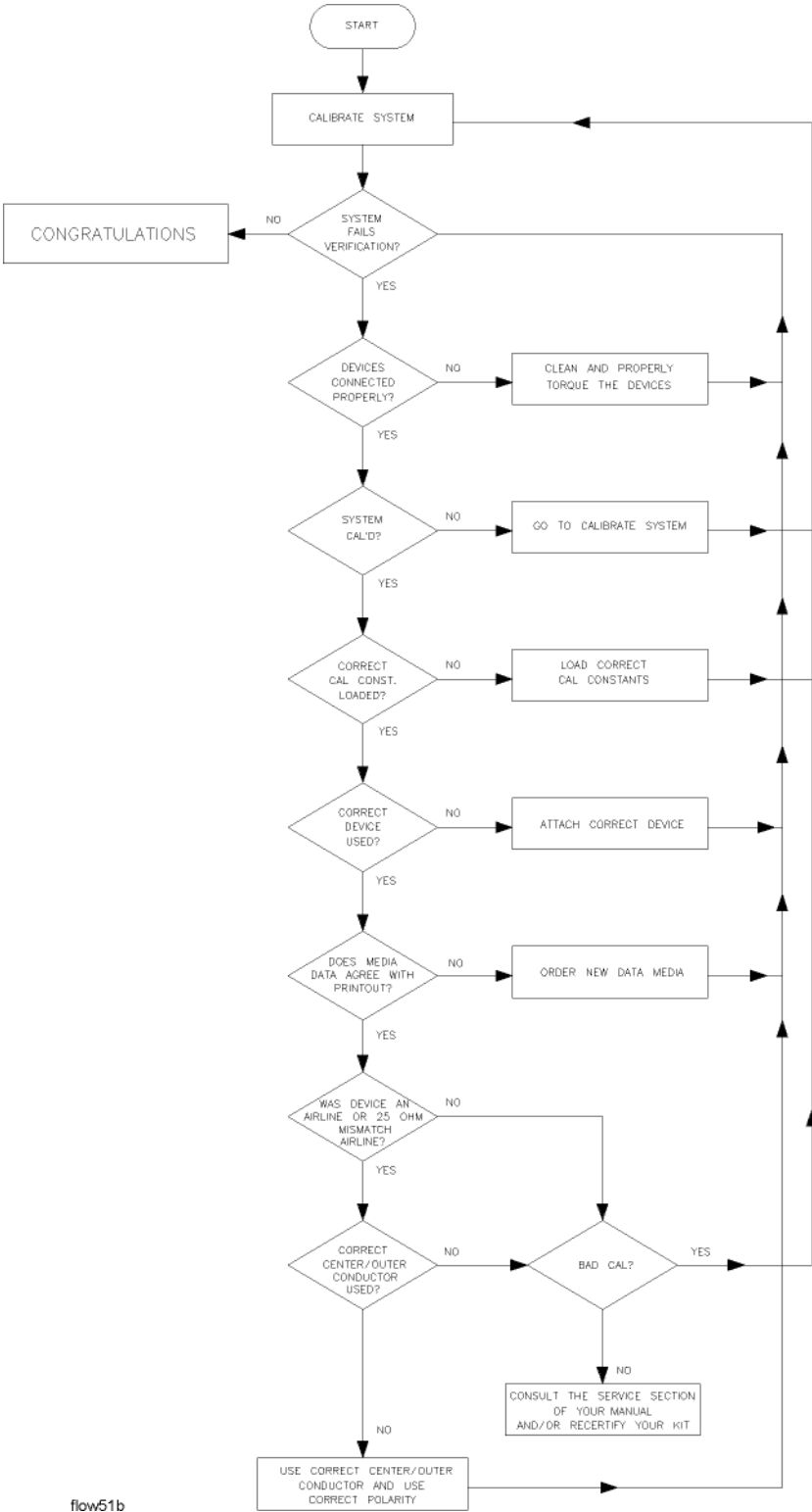

Compatible Network Analyzers

The devices in this kit and their data are compatible with the PNA series network analyzers. The USB drive provided contains the unique factory-measured S-parameter data for each device in this kit. It also contains the factory measurement uncertainty used in the PNA system verification procedure to calculate the test limits.

Older models of this verification kit provided data disks for the 8510, 8720 and 8722 analyzers. Since these analyzers have been discontinued, the data disks are no longer provided in new kits. When old verification kits that include the data disks are returned to Keysight for recertification, the disks will be reproduced with new data for each device in the kit. Please specify your VNA model(s) when returning kits for service or when ordering kit replacement parts.

Where to Look for More Information

This manual contains limited information about PNA series network analyzer system operation. For detailed information on using a PNA, refer to the PNA Help system. To do so, press the Help key on the front panel of the PNA.

If you need additional information, see **“Contacting Keysight” on page 4**.

Returning a Kit or Device to Keysight

If your kit or device requires service, contact Keysight Technologies for information on where to send it. See **“Contacting Keysight” on page 4**. Include a service tag (located near the end of this manual) on which you provide the following information:

- your company name and address
- a technical contact person within your company, and the person's complete telephone number
- the model number and serial number of the kit
- the part number and serial number of each device
- the type of service required
- a **detailed** description of the problem and how the device was being used when the problem occurred (such as calibration or measurement)

Contacting Keysight

Assistance with test and measurements needs and information on finding a local Keysight office are available on the Web at:

www.keysight.com/find/assist

If you do not have access to the Internet, please contact your Keysight field engineer.

NOTE

In any correspondence or telephone conversation, refer to the Keysight product by its model number and full serial number. With this information, the Keysight representative can determine whether your product is still within its warranty period.

6 Replaceable Parts

Replacing the Verification Data

The verification data contains unique performance data that applies to the individual verification devices. No two devices have the same performance data. It is not a trivial matter to replace lost or damaged data, so it is important to make one or more backup copies.

If your verification data is lost or damaged, and you have no backup copies, take one of the following actions:

- If recertification is not required in the near future.

Contact Keysight for replacement verification data – refer to **“Contacting Keysight” on page 4**. Please specify the information in the table below.

- If recertification will be required in the near future.

Keysight recommends that you have the verification kit recertified early. New verification data will be generated during the recertification process. Refer to **“Recertification” on page 2**.

Table 6-1 Information to Specify When Ordering Replacement Verification Data

Device	Model Number	Serial Number	Part Number
Kit			--
Device 1	--		
Device 2	--		
Device 3	--		
Device 4	--		
Needed: (check) PNA USB drive ___; Data sheets ___			
Last Recertification: Date _____; Serviced by: _____			

Copying Replacement Device Verification Data to the Original Verification Data Media

NOTE

IMPORTANT! The information in the following two processes applies only to writable USB drives. If the USB drive shipped with your verification kit or replacement device has either the Keysight or Keysight logo on it, it is read-only, and the following two processes do not apply. If this is the case, simply use the USB drive that was shipped with your replacement device when you connect that device during the system verification process.

This section describes how to copy the new replacement device verification data from the USB drive provided with the device, to the verification data media (floppy disk or USB) included with the original verification kit. Please be aware that once you write over the “old” data, the data cannot be recovered. Therefore, it is highly recommended that you follow the procedure below in “Old Verification Device Data – Backup Process” to make a backup copy of the “old” verification data BEFORE you perform the “New Verification Device Data – Transfer Process” procedure. Be sure to keep the new USB drive. It will be your backup copy of the new replacement device verification data.

NOTE

This procedure assumes you have access to a PC or a PNA to perform these tasks.

Old Verification Device Data – Backup Process

1. Insert the old verification device data media (floppy disk or USB) into your computer or PNA and view the contents with Windows Explorer.
2. Copy all of the files to the clipboard.
3. Remove the old verification device data media (floppy disk or USB) from your computer or PNA.
4. Insert the new USB drive into your computer or PNA and view the contents with Windows Explorer.
5. Create a new directory on the new USB drive and name it using the format Model_Serial_YYYYMMDD. Use your kit’s model number, serial number, and the current date. Example: 85055A_2815A01234_20120827.
6. Open the new directory you created in the previous step and paste the files from the clipboard.
All of the files (nine files: one .txt file, four .dat files, and four .unc files) you copied from the old verification device data media should be present. You now have a complete backup of the old verification device data on the new USB drive.

New Verification Device Data – Transfer Process

1. If not already done, insert the new USB drive into your computer or PNA and view the contents with Windows Explorer.
2. Copy all of the files with .DAT and .UNC file extensions to the clipboard, except the old files you copied in the new directory.
3. Note the dates of the files you just copied to the clipboard.
4. Remove the new USB drive from your computer or PNA.
5. Insert the old verification device data media (floppy disk or USB) into your computer or PNA and view the contents with Windows Explorer.
6. Paste the files from the clipboard into the top-level directory.
7. When prompted if you want to write-over existing files, click YES. The new .DAT and .UNC files should show newer dates relative to your original files.
8. Select the “kitparts.txt” file and open it with Notepad or Wordpad.
9. Locate the line for the verification device you just replaced (device 1, 2, 3 or 4).
10. Change the serial number at the end of the line to the serial number of the new device you received in the replacement kit.
11. Save and close the kitparts.txt file.
12. Remove the old verification device data media (floppy disk or USB) from your computer or PNA.
Your new replacement device is now ready to use with your PNA.

Replaceable Parts

Table 6-2 lists the replacement part numbers for items included in the 85053B verification kit.

Table 6-3 lists the replacement part numbers for items not included in the verification kit that are either required or recommended for successful operation of the kit.

To order a listed part, note the description, the part number, and the quantity desired. Telephone or send your order to Keysight Technologies – see **“Contacting Keysight” on page 4**.

Table 6-2 Replaceable Parts for the 85053B 3.5 mm Verification Kit

Description	Qty Per Kit	Keysight Part Number
Attenuators		
20 dB attenuator with data	1	85053BR01
40 dB attenuator with data	1	85053BR02
Airlines		
50 Ω airline with data	1	85053BR03
25 Ω mismatch airline with data	1	85053BR04
Verification Kit Storage Case		
Box (including foam pads)	1	85053-60007
Box (without foam pads)	1	5180-7899
Foam pad (for lid)	1	5180-8490
Foam pad (for lower case)	1	85053-80017
User's and Service Guide		
User's and service guide	1	85053-90028

Table 6-3 **Items Not Included in the Verification Kit**

Description	Qty	Keysight Part Number
Connector Gages (3.5 mm)		
Male connector gage set ^a	1	11752-60106
Female connector gage set ^a	1	11752-60105
Short (3.5 mm)		
Male short ^a (for gaging airlines)	1	85052-60006
Male short ^b (for gaging airlines)	1	85033-60020
Slotless Connector Repair Kit (3.5 mm)		
Slotless connector contact repair kit ^c	1	85052-60049
Wrenches		
5/16 in, 90N-cm (8 in-lb) torque wrench	1	8710-1765
5/16 in open-end wrench	1	8720-0015
ESD Protection Devices		
Grounding wrist strap	1	9300-1367
5 ft grounding cord for wrist strap	1	9300-0980
2 x 4 ft conductive table mat and 15 ft ground wire	1	9300-0797
Connector Cleaning Supplies		
Anhydrous isopropyl alcohol (>92% pure) ^d	--	--
Cleaning swabs	100	9301-1243

- a. Included in the 85052B 3.5 mm calibration kit.
- b. Included in the 85033E 3.5 mm calibration kit.
- c. All female connectors on the precision devices in this kit are slotless connectors. Refer to **“Precision Slotless Connectors” on page 4.**
- d. Keysight can no longer safely ship isopropyl alcohol, so customers should purchase it locally.

Figure 6-1

Component Identification Sheet



50 Ω Airline



25 Ω Mismatch Airline



20 dB Attenuator



40 dB Attenuator

Not Shown:

- Verification data USB drive
- User's and service guide
- Storage case

ph510b

- A
- airline
 - assembling 3-13, 3-18
 - attaching the short 3-14
 - connecting 3-18
 - dimensions 2-4
 - center conductor 2-5, 2-6
 - outer conductor 2-5
 - disconnecting 3-20
 - gaging 3-12, 3-14
 - mechanical characteristics 2-4
 - mismatch 2-5
 - part numbers 6-4
 - alcohol
 - isopropyl
 - as cleaning solvent 3-5
 - precautions for use of 3-5
 - altitude
 - specifications 2-1
 - attenuators
 - part numbers 6-4
- B
- box
 - pads
 - part numbers 6-4
 - part number 6-4
- C
- calibration
 - bad 5-1
 - certificate of 4-2
 - constants, See calibration definitions
 - definitions
 - entering 1-2
 - permanently stored 1-2
 - kits
 - intended to be used 1-1
 - report 4-2
 - temperature 2-1
 - case
 - storage
 - part number 6-4
 - certificate of calibration 4-2
 - characteristics
 - mechanical 2-3
 - supplemental 2-3
 - cleaning connectors 3-5
 - cleaning supplies 1-2
 - compatibility
 - with analyzers 5-3
 - compressed air or nitrogen 3-5
 - conductive table mat
 - for ESD protection 3-1
 - part number 6-5
 - conductor
 - mating plane 2-3
 - connections 3-1, 3-16
 - airline 3-18
 - ESD protection 3-16
 - final 3-17
 - preliminary 3-16
 - separating 3-20
 - using torque wrench 3-17
 - connector
 - cleaning 3-5
 - conventional 1-4, 3-4
 - damage 3-3
 - defects 3-3
 - female 1-4, 3-4
 - gage
 - accuracy 3-7
 - handling 3-7, 3-9, 3-12
 - part numbers 6-5
 - use of 3-7
 - zeroing 3-7, 3-9, 3-12
 - gaging 3-7, 3-9
 - to determine pin depth 3-7
 - when to do 3-7
 - gender 1-5
 - mating plane surfaces 2-3, 3-6
 - cleaning 3-6
 - slotless 1-4, 3-4
 - accuracy 1-4, 3-4
 - characteristics 1-4
 - slotless repair kit
 - part number 6-5
 - slotted 1-4, 3-4
 - accuracy 1-4, 3-4
 - terminology 1-5
 - threads
 - cleaning 3-5
 - inspecting 3-3
 - visual inspection 3-3
 - wear 3-3
 - affect on electrical performance 3-3
- constants, calibration, See calibration definitions
- contacting Keysight Technologies 5-4

- contents
 - drawing of 6-6
 - verification kit 6-6
- cord
 - grounding
 - part number 6-5
- D
- damage
 - caused by electrostatic discharge 3-1
 - device 3-3
 - inspecting for 1-2, 3-3
 - to connectors 3-3
 - what to do 1-2
- damaged connectors 3-3
- data
 - recertification 4-2
 - replacement device 6-2
 - replacing 6-1
- defective connectors 3-3
- defects
 - connector 3-3
- definitions
 - calibration 1-2
- device
 - compatibility
 - with analyzers 5-3
 - conductor
 - mating plane 2-3
 - connecting 3-16
 - damage 3-3
 - disconnecting 3-20
 - handling 3-21
 - maintenance 1-5
 - performance
 - verifying 4-1
 - pin depth 2-3
 - specifications 2-6
 - traceability 4-1, 4-2
 - storage 3-21
 - temperature 2-1
 - visual inspection 3-3
- dimensions
 - airline 2-4
 - center conductor 2-5, 2-6
 - outer conductor 2-5
 - device
 - center conductor 2-3
 - outer conductor 2-3
- disconnections 3-20
- E
- electrical specifications 2-6
- electrostatic discharge, See ESD
- environmental
 - regulations 3-5
 - requirements 2-1
 - specifications 2-1
- equipment required 1-2
- ESD 3-1
 - conductive floor 3-1
 - conductive table mat 3-1
 - heel strap 3-1
 - precautions 3-1, 3-5
 - protection 3-1
 - protection setup 3-1, 3-2
 - supplies 3-1
 - part numbers 6-5
 - wrist strap 3-1
- F
- female connectors 3-4
 - inspection of 3-4
- frequency range 1-1
- G
- gage
 - connector 1-2
 - handling 3-9, 3-12
 - part numbers 6-5
 - zeroing using short 3-12
 - zeroing 3-9
- gaging
 - airline 3-12, 3-14
 - connectors 3-7, 3-9
 - when to do 3-7
 - procedures 3-9
 - to determine pin depth 3-7
- gender, connector 1-5
- grounding cord
 - part number 6-5
- H
- handling 3-21
- heel strap
 - for ESD protection 3-1
- humidity
 - specifications 2-1

- I
- incoming inspection 1-2
- information, troubleshooting 5-4
- inspection
 - damage 3-3
 - defects 3-3
 - female connectors 3-4
 - incoming 1-2
 - mating plane surfaces 3-3
 - visual 3-3
- isopropyl alcohol
 - as cleaning solvent 3-5
 - precautions for use of 3-5
- K
- Keysight Technologies
 - contacting 5-4
- kit
 - calibration
 - intended to be used 1-1
 - contents 1-1, 6-6
 - drawing of 6-6
 - frequency range 1-1
 - overview 1-1
 - performance
 - how Keysight verifies 4-1
 - verifying 4-1
- M
- maintenance 3-1
 - of devices 1-5
 - preventive 1-5
- making connections 3-16
 - ESD protection 3-16
 - precautions 3-16
- manual
 - part number 6-4
- mat
 - conductive
 - part number 6-5
 - for ESD protection 3-1
- mating plane
 - conductor 2-3
 - surfaces
 - cleaning 3-6
 - connector 3-6
 - inspection of 3-3
- mechanical characteristics 2-3
 - verifying 3-7
- mechanical integrity 2-3
- mismatch airline 2-5
- N
- National Institute of Standards and Technology (NIST) 2-6, 4-1
- nitrogen 3-5
- numbers
 - replaceable parts 6-4
 - serial
 - recording 1-3
- O
- open-end
 - wrench
 - part number 6-5
- open-end wrench 3-20
- options 1-2
- ordering parts 6-4
- P
- part numbers 6-4
 - of items in kit 6-4
 - of items not in kit 6-5
- parts
 - included in kit 6-4
 - not included in kit 6-4, 6-5
 - ordering 6-4
 - replaceable 6-4
- performance verification
 - fail 5-1
- permanently stored calibration definitions 1-2
- pin depth 2-3
 - definition of 2-3
 - gaging to determine 3-7
 - observed limits 3-7
 - protrusion 2-3
 - recession 2-3
 - specifications 2-4
- precision slotless connector (PSC) 1-4, 3-4
- preventive maintenance 1-5
- protrusion, pin depth 2-3
- R
- recertification
 - how to order 4-2
 - interval 4-2
 - what's included 4-2
 - where it's done 4-2

- recession, pin depth 2-3
- regulations
 - environmental 3-5
- replaceable parts 6-4, 6-6
 - drawing of 6-6
- replacement device data 6-2
- report, calibration 4-2
- requirements
 - environmental 2-1
- return kit or device to Keysight 5-4
- S
- separating connections 3-20
- serial numbers
 - devices 1-3
 - recording 1-3
- service 5-4
- service tag 5-4
- shipment
 - verifying complete 1-2
- short
 - attaching to airline 3-14
 - part number 6-5
 - using to zero gage 3-12
- slotless connector 1-4, 3-4
 - accuracy 1-4, 3-4
 - characteristics 1-4
 - repair kit
 - part number 6-5
- specifications 2-1
 - altitude
 - operating 2-1
 - storage 2-1
 - device 2-6
 - electrical 2-6
 - environmental 2-1
 - humidity 2-1
 - pin depth 2-4
 - temperature 2-1
 - torque wrench 3-17
 - traceability 4-1, 4-2
- standards
 - National Institute of Standards and Technology (NIST) 4-1
- static discharge, See ESD
- storage 3-21
- storage case
 - part number 6-4
- strap
 - wrist
 - part number 6-5
- supplemental characteristics 2-3
- supplies
 - cleaning 1-2
- T
- table mat
 - for ESD protection 3-1
- tag
 - service 5-4
- temperature
 - affect on electrical performance 2-1
 - calibration 2-1
 - cautions about 2-1
 - changes in 2-1
 - device 2-1
 - error-corrected 2-1
 - measurement 2-1
 - specifications 2-1
 - operating 2-1
 - storage 2-1
 - verification and measurement 2-1
- test data 4-2
- threads
 - connector
 - cleaning 3-5
 - inspecting 3-3
- torque wrench 1-2
 - part number 6-5
 - specifications 3-17
- traceability
 - of device specifications 4-1, 4-2
- troubleshooting 5-1
- U
- USB drive 1-1
- user's and service guide
 - part number 6-4
- V
- verification
 - temperature 2-1
- verification kit
 - contents 1-1, 6-6
 - drawing of 6-6
 - data
 - replacing 6-1
 - frequency range 1-1

- overview 1-1
- performance
 - how Keysight verifies 4-1
 - verifying 4-1
- visual inspection 3-3

W

- wear
 - connector 3-3
 - affect on electrical performance 3-3
- wrench
 - open-end 1-2, 3-17, 3-20
 - part number 6-5
 - proper positioning of 3-17
 - torque 1-2, 3-17, 3-18
 - part number 6-5
 - precautions for use of 3-18
 - proper use of 3-18
- wrist strap
 - for ESD protection 3-1
 - part number 6-5

Z

- zeroing
 - connector gage 3-9
 - using short 3-12



This information is subject to change without notice.

© Keysight Technologies 1995-2019

Edition 1, January 2019



85053-90028

www.keysight.com