



85331B/85332B Solid State Switches

85331B SP2T 45 MHz to 50 GHz

85332B SP2T 45 MHz to 50 GHz

Key Features

- Maximizes your operating frequency range from 45 MHz up to 50 GHz
- Minimizes cross-talk with a high port-to-port isolation of above 90 dB
- Increases your switching speed, typically less than 1 μ s, suitable for high speed applications

Description

The Keysight Technologies, Inc. 85331B and 85332B are absorptive PIN diode solid state switches which provide superior performance in terms of high isolation and fast switching speed across a broad operating frequency range. The absorptive solid state switches are designed for high frequency, single- SP2T/SP4T operation and are extremely useful for applications in instrumentation, communications, radar, and many other test systems that require high speed RF & microwave switching.

The absorptive characteristic of the switches, provide a good impedance match, which is key to achieving accurate measurements.

Each output port has a PIN diode in series. The DC bias is used to turn on and off the pin diode depending on which port to select. There are some PIN diodes that shunt to ground in RF path, to improve the isolation of the switches.

Applications

Figure 1 shows a typical configuration with the PIN switches connected to the source antenna and antenna under test.

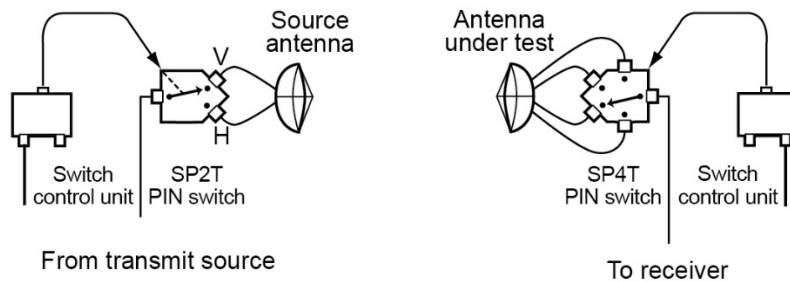

Figure 1. A typical multiple-channel, multiple frequency system configuration

Far-field antenna measurements

These products are ideally suited for antennas with multiple test ports, or applications that require measuring the co- and cross-polarization. One PIN switch can switch transmit polarization, and a second PIN switch can switch between the separate test ports of the antenna. With this technique, the co- and cross-polarization response of each test port can be measured in one rotation of the antenna.

Near-field antenna measurements

For near-field applications, both the co- and cross-polarized response of an antenna can be measured at multiple frequencies in a single scan across the antenna. For the dual polarized response, a PIN switch can be used to rapidly switch between the two probe polarizations.

Radar cross-section measurements

For Radar cross-section (RCS) applications, the ability to rapidly switch transmit and receive polarization allows full polarimetric RCS measurements to be made quickly and easily.

Complex switch configurations

Complex PIN switch trees with multiple outputs can be easily configured. Figure 2 shows conceptually how multiple PIN switches can be configured. Configurations such as these are used in making phased-array antenna measurements.

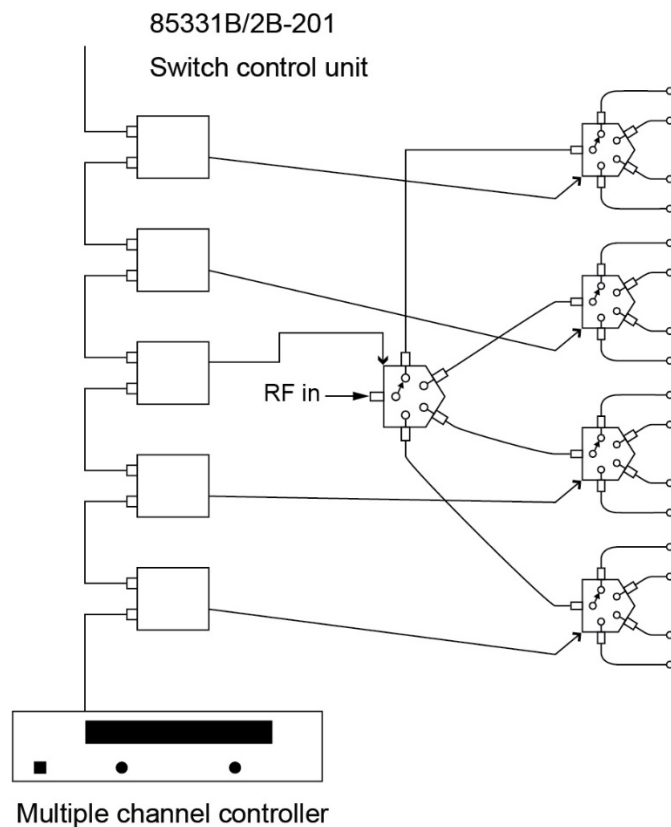

Figure 2. Example of a 1P16T switch configuration constructed from modular components

Specifications

Specifications refer to the performance standards or limits against which the PIN diode switches are tested.

Typical characteristics are included for additional information only and they are not specifications. These are denoted as “typical”, “nominal” or “approximate”.

Model number	Frequency range (GHz)	Insertion loss (dB)	Isolation (dB)	Return loss (OFF port) (dB)	Return loss (ON port) (dB)	Return loss (COM port) (dB)
85331B SP2T	0.045 to 0.5	-2.0	-85	-19.0	-10.0	-10.0
	0.5 to 18	-4.5	-90	-19.0	-10.0	-10.0
	18 to 26.5	-6.0	-90	-12.5	-6.0	-5.5
	26.5 to 40	-10.0	-85	-10.0	-6.0	-4.5
	40 to 50	-15.5	-75	-6.0	-4.5	-4.0

85332B SP4T	0.045 to 0.5	-2.0	-85	-19.0	-9.0	-10.0
	0.5 to 18	-4.5	-90	-19.0	-9.0	-10.0
	18 to 26.5	-7.0	-90	-12.5	-5.0	-5.5
	26.5 to 40	-12.0	-85	-10.0	-4.5	-4.0
	40 to 50	-21.5 ¹	-75	-6.0	-4.5	-4.0
	-15.5 ²					

Table 1. 85331/32B specifications

Typical switching speed: rise/fall time* 1.5 μ s.

*Risetime is the time it takes for the detected RF output (measured using a square law detector) to raise from 10% to 90% of the final value, when a switch arm is changed from an "off" state to an "on" state. Falltime is the time it takes for the detected RF output (measured using a square law detector) to drop from 90% to 10% of the final value, when a switch arm is changed from an "on" state to an "off" state.

	Min	Nominal	Max	Unit
RF input power (average)			+27	dBm
Vdc bias turn on a port	-6.65	-7	-7.35	V
Current drawn for On port		40		mA
Vdc bias turn off a port	5.98	6.3	6.62	V
Current drawn for Off port		120		mA

Table 2. Absolute maximum rating for 85331/32 B solid state switches

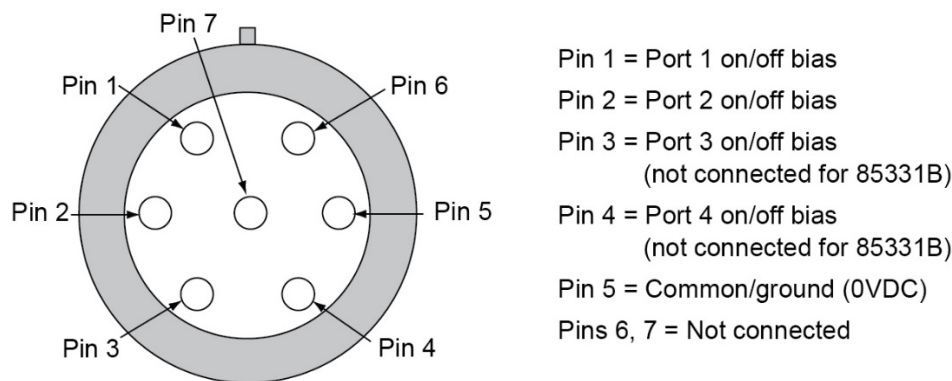

Figure 3. Bias connector pin locations

1. COM port-to-port 1 & 4.
2. COM port-to-port 2 & 3.

	Port 1 Vbias	Port 2 Vbias	Port 3 Vbias	Port 4 Vbias	Current draw -ve supply	Current drawn +ve supply
Port 1 ON, other ports OFF	-7.0 V	+6.3 V	+6.3 V	+6.3 V	40 mA	360 mA
Port 2 ON, other ports OFF	+6.3 V	-7.0 V	+6.3 V	+6.3 V	40 mA	360 mA
Port 3 ON, other ports OFF	+6.3 V	+6.3 V	-7.0 V	+6.3 V	40 mA	360 mA
Port 4 ON, other ports OFF	+6.3 V	+6.3 V	+6.3 V	-7.0 V	40 mA	360 mA
All ports OFF	+6.3 V	+6.3 V	+6.3 V	+6.3 V	0 mA	480 mA

Note: Only ONE port can be ON at a time, all ports can be OFF at the same time.

Table 3. Biasing voltage configuration

ON port	40 mA
OFF port	120 mA

Table 4. Typical current drawn

Environmental Specifications

The 85331/32B switches are designed to fully comply with Keysight's product operating environment specifications. The following summarizes the environmental specifications for these products.

Temperature:

Operating	-20 °C to 55 °C
Storage	-40 °C to 70 °C
Cycling	-45 °C to 70°C, 10 cycles @ 20 °C per minute, 20 minutes dwell time per MIL-STD-833F, Method 1010.8, Condition C (modified)

Humidity:

Operating	5% to 95% at to +40 °C or less (non condensing)
Storage	5% to 95% at to +65 °C or less (non condensing)

Shock:

Half-sine, smoothed	100 G @ 6 ms, 3 shock pulses per orientation
---------------------	----------------------------------------------

Vibration:

Broadband	50 to 2000 Hz, 7.0 G rms, 15 minutes, per MIL-STD-833F,
random	Method 2026-1 (modified)

Altitude:

- Operating < 4,600 meters (15,000 feet)
- Storage < 15,300 meters (50,000 feet)

ESD Immunity:

- Contact discharge 15 kV (to outer conductor) per IEC 61000-4-2
- Air discharge 6 kV (to center pin) per IEC 61000-4-2

Mechanical Dimensions

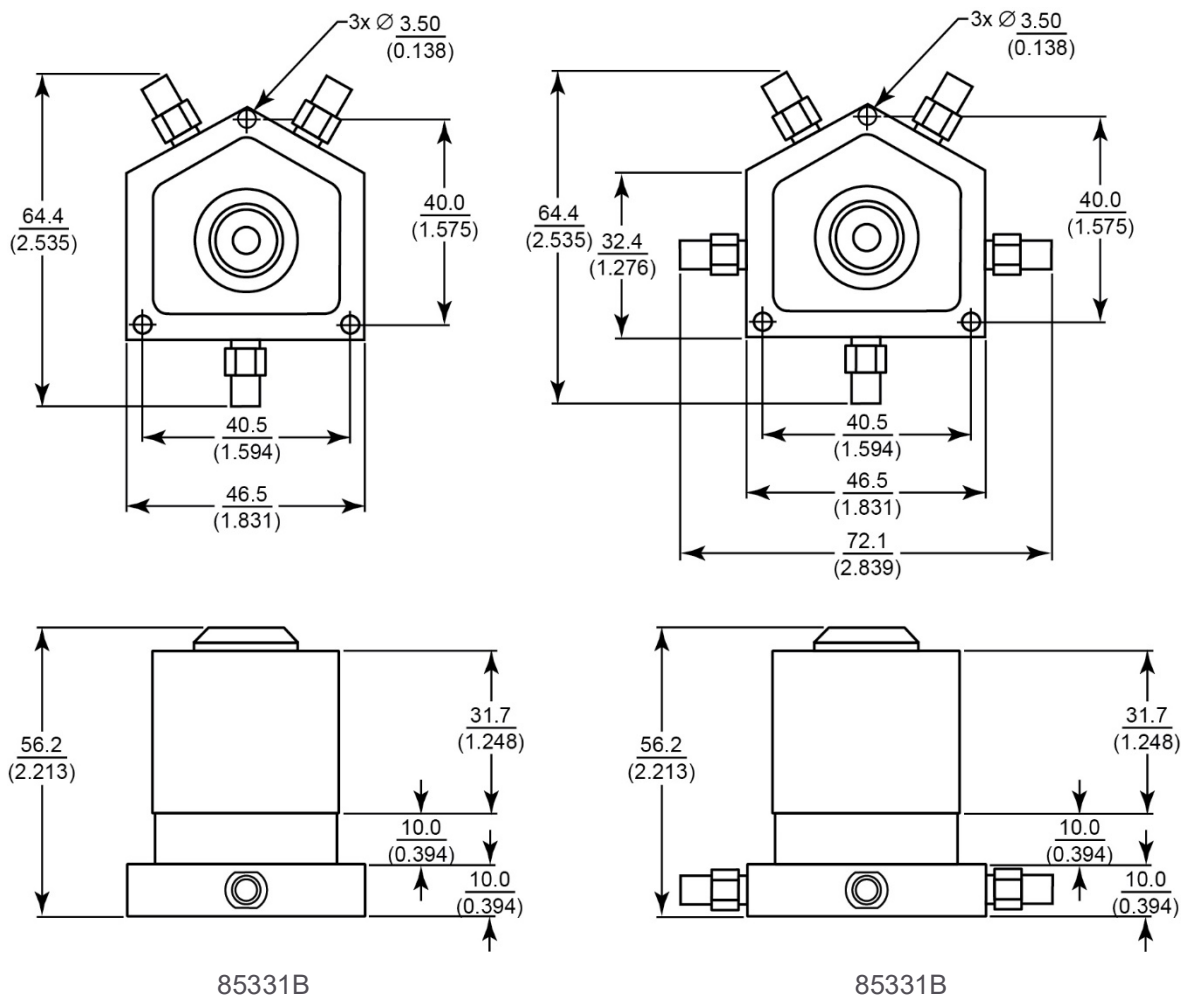

Figure 4. Product mechanical outline. Dimensions are in mm (inches) nominal, unless otherwise specified.

Size and weight:

57 mm (2.24") x 65 mm (2.56 mm) x 73 mm (2.88 mm) 0.36 kg (0.79 lbs)

Typical Performance 85331B

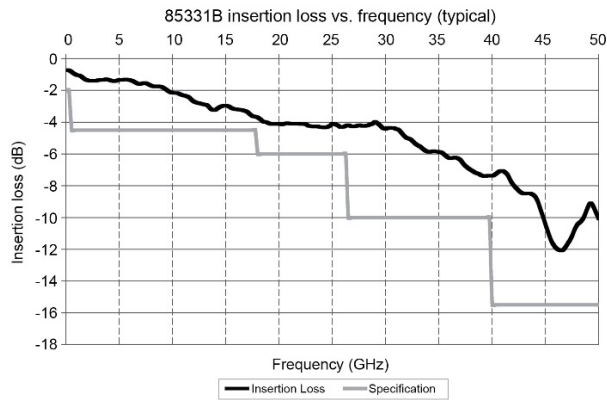

Figure 5. 85331B insertion loss vs. frequency (typical)

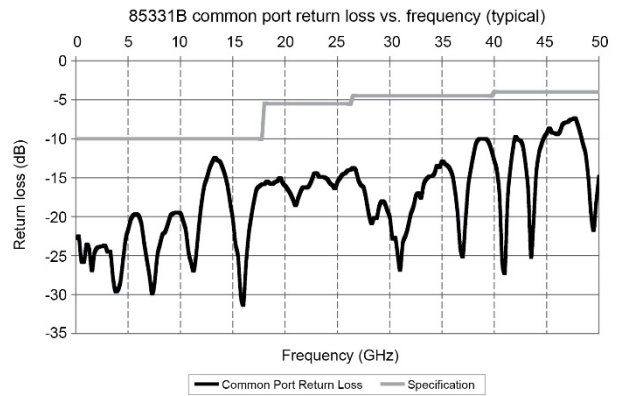

Figure 6. 85331B common port return loss vs. frequency (typical)

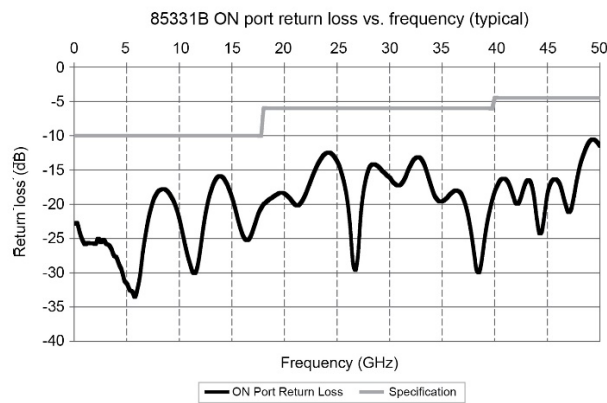

Figure 7. 85331B ON port return loss vs. frequency (typical)

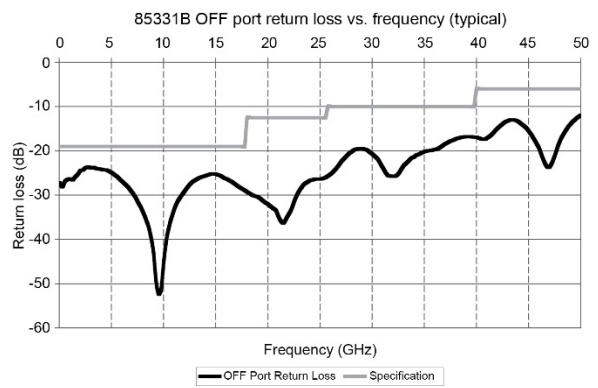

Figure 8. 85331B OFF port return loss vs. frequency (typical)

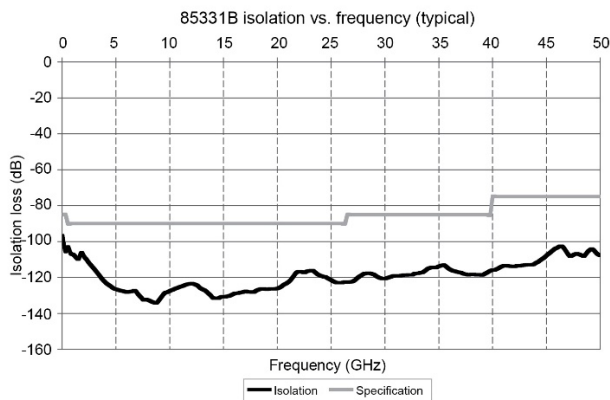

Figure 9. 85331B isolation vs. frequency (typical)

Typical Performance 85332B

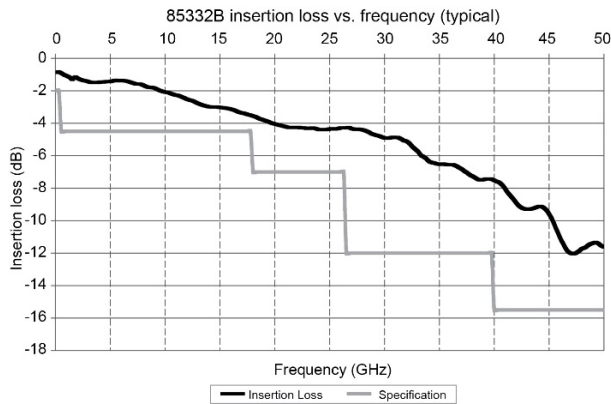

Figure 10. 85332B insertion loss vs. frequency (typical)

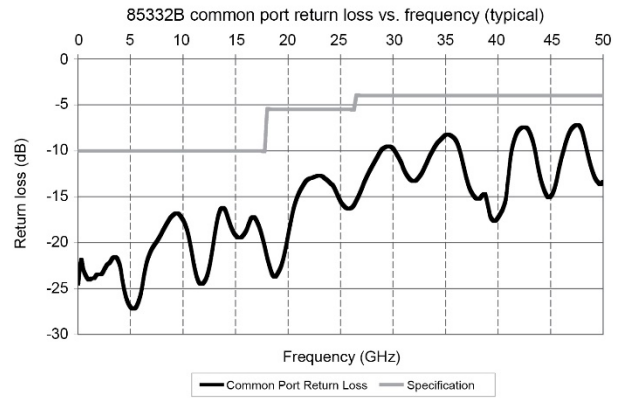

Figure 11. 85332B common port return loss vs. frequency (typical)

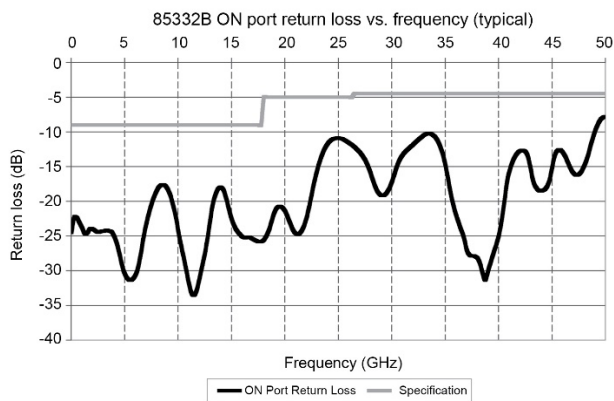

Figure 12. 85332B ON port return loss vs. frequency (typical)

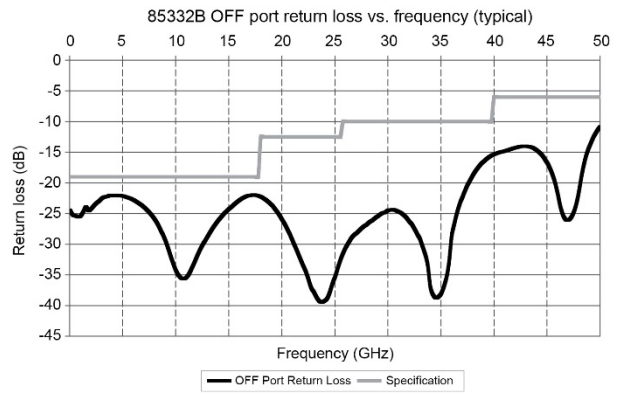

Figure 13. 85332B OFF port return loss vs. frequency (typical)

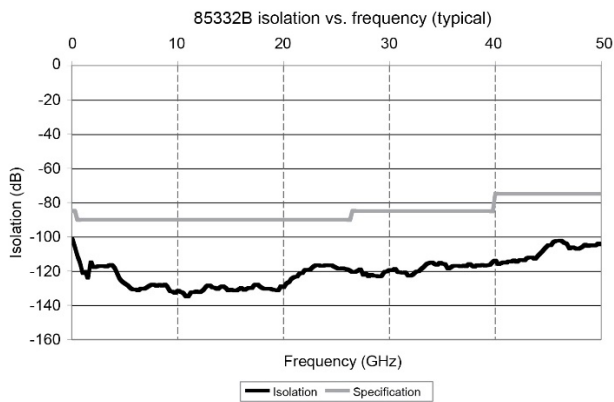

Figure 14. 85332B isolation vs. frequency (typical)

Ordering Information

85331B options	SP2T 45 MHz to 50 GHz solid state switch
85331B-001	Switch control cable - 1 meter
85331B-002	Switch control cable - 2 meter
85331B-005	Switch control cable - 5 meter
85331B-010	Switch control cable - 10 meter
85331B-015	Switch control cable - 15 meter
85331B-102	Switch control cable (one end bare wire) - 2 meter
85331B-115	Switch control cable (one end bare wire) - 15 meter
85331B-201	Switch control unit

85332B options	SP4T 45 MHz to 50 GHz solid state switch
85332B-001	Switch control cable - 1 meter
85332B-002	Switch control cable - 2 meter
85332B-005	Switch control cable - 5 meter
85332B-010	Switch control cable - 10 meter
85332B-015	Switch control cable - 15 meter
85331B-102	Switch control cable (one end bare wire) - 2 meter
85331B-115	Switch control cable (one end bare wire) - 15 meter
85332B-201	Switch control unit

Web Resource

<http://www.keysight.com/find/mta>

Related Literature

Publication title	Pub number
<i>N9397A/C Solid State Switches Flyer</i>	5989-3729EN
<i>N9397A/C Solid State Switches Technical Overview</i>	5989-4031EN
<i>Solid State Switches Application Note</i>	5989-5189EN
<i>Keysight Antenna Test Selection Guide</i>	5968-6759E

Learn more at: www.keysight.com

For more information on Keysight Technologies' products, applications or services, please contact your local Keysight office. The complete list is available at: www.keysight.com/find/contactus

