

Keysight 2-Port and 4-Port PNA-X Network Analyzer

N5247B – 900 Hz to 67 GHz

Data Sheet and
Technical
Specifications

Documentation Warranty

THE MATERIAL CONTAINED IN THIS DOCUMENT IS PROVIDED "AS IS," AND IS SUBJECT TO BEING CHANGED, WITHOUT NOTICE, IN FUTURE EDITIONS. FURTHER, TO THE MAXIMUM EXTENT PERMITTED BY APPLICABLE LAW, KEYSIGHT DISCLAIMS ALL WARRANTIES, EITHER EXPRESS OR IMPLIED WITH REGARD TO THIS MANUAL AND ANY INFORMATION CONTAINED HEREIN, INCLUDING BUT NOT LIMITED TO THE IMPLIED WARRANTIES OF MERCHANTABILITY AND FITNESS FOR A PARTICULAR PURPOSE. KEYSIGHT SHALL NOT BE LIABLE FOR ERRORS OR FOR INCIDENTAL OR CONSEQUENTIAL DAMAGES IN CONNECTION WITH THE FURNISHING, USE, OR PERFORMANCE OF THIS DOCUMENT OR ANY INFORMATION CONTAINED HEREIN. SHOULD KEYSIGHT AND THE USER HAVE A SEPARATE WRITTEN AGREEMENT WITH WARRANTY TERMS COVERING THE MATERIAL IN THIS DOCUMENT THAT CONFLICT WITH THESE TERMS, THE WARRANTY TERMS IN THE SEPARATE AGREEMENT WILL CONTROL.

U.S. Government Rights

U.S. Government Rights. The Software is "commercial computer software," as defined by Federal Acquisition Regulation ("FAR") 2.101. Pursuant to FAR 12.212 and 27.405-3 and Department of Defense FAR Supplement ("DFARS") 227.7202, the U.S. government acquires commercial computer software under the same terms by which the software is customarily provided to the public. Accordingly, Keysight provides the Software to U.S. government customers under its standard commercial license, which is embodied in its End User License Agreement (EULA), a copy of which can be found at <http://www.keysight.com/find/sweula>. The license set forth in the EULA represents the exclusive authority by which the U.S. government may use, modify, distribute, or disclose the Software. The EULA and the license set forth therein, does not require or permit, among other things, that Keysight: (1) Furnish technical information related to commercial computer software or commercial computer software documentation that is not customarily provided to the public; or (2) Relinquish to, or otherwise provide, the government rights in excess of these rights customarily provided to the public to use, modify, reproduce, release, perform, display, or disclose commercial computer software or commercial computer software documentation. No additional government requirements beyond those set forth in the EULA shall apply, except to the extent that those terms, rights, or licenses are explicitly required from all providers of commercial computer software pursuant to the FAR and the DFARS and are set forth specifically in writing elsewhere in the EULA. Keysight shall be under no obligation to update, revise or otherwise modify the Software. With respect to any technical data as defined by FAR 2.101, pursuant to FAR 12.211 and 27.404.2 and DFARS 227.7102, the U.S. government acquires no greater than Limited Rights as defined in FAR 27.401 or DFAR 227.7103-5 (c), as applicable in any technical data.

Dynamic Range.....	10
System Dynamic Range	11
Table 1a. System Dynamic Range at Test Port (dB), Options 201 or 401	11
Table 1b. System Dynamic Range at Test Port (dB), Options 219 or 419	12
Table 1c. System Dynamic Range at Test Port (dB), Option 224.....	13
Table 1d. System Dynamic Range at Test Port (dB), Options 224 or 423	14
Table 1e. System Dynamic Range at Test Port (dB), Options 224 or 423 with 029 ¹	15
Table 1f. System Dynamic Range at Test Port (dB), Option 425	16
Table 1g. System Dynamic Range at Test Port (dB), Option 425 (LFE Enabled)	17
Table 1h. System Dynamic Range at Test Port (dB), Option 425 (LFE Enabled), Combine Mode - Typical... 17	
Table 1i. System Dynamic Range at Test Port (dB), Option 425 with 029 - Specification	18
Table 1j. System Dynamic Range at Test Port (dB), Option 425 with 029 - Typical	19
Extended Dynamic Range	20
Table 2a. Extended Dynamic Range at Direct Receiver Access Input (dB) - Typical	20
Table 2b. Extended Dynamic Range at Direct Receiver Access Input (dB) - Typical	21
Table 2c. Extended Dynamic Range at Direct Receiver Access Input (dB) - Typical	22
Table 2d. Extended Dynamic Range at Direct Receiver Access Input (dB) - Typical	23
Table 2e. Extended Dynamic Range at Direct Receiver Access Input (dB) - Typical	24
Receiver Dynamic Range	25
Table 3a. Receiver Dynamic Range (dB), All Options	25
Table 3b. Receiver Dynamic Range (dB), All Ports, Option 425 (LFE Enabled)	25
N5247B Corrected System Performance, All Options	26
Table 4a. 85058B Calibration Kit	26
Table 4b. 85058B Calibration Kit, LFE Enabled (Option 425)	29
Table 5a. N4694A Calibration Kit.....	30
Table 5b. N4694A Calibration Kit, LFE Enabled (Option 425)	33
Table 5c. N4694D Calibration Kit.....	34
Table 5d. N4694D Calibration Kit, LFE Enabled (Option 425).....	36
Uncorrected System Performance	37
Table 6a. Uncorrected System Performance (dB), All Options, All Ports - Specification.....	37
Table 6b. Uncorrected System Performance (dB), All Options, All Ports - Typical	38
Table 6c. Noise Mode ¹ Uncorrected System Performance (dB), Option 029 - Specification.....	39
Table 6d. Noise Mode ¹ Uncorrected System Performance (dB), Option 029 - Typical.....	39
Table 6e. Uncorrected System Performance (dB), All Ports, Option 425, (LFE Enabled) - Specifications	40
Table 6f. Uncorrected System Performance (dB), All Ports, Option 425, (LFE Enabled) - Typical	40

Test Port Output	41
Table 7. Frequency Information, All Options	41
Table 8a. Maximum Leveled Power (dBm), Options 201 or 401	42
Table 8b. Maximum Leveled Power (dBm), Options 219 or 419	43
Table 8c. Maximum Leveled Power (dBm), Options 224 or 423	44
Table 8d. Maximum Leveled Power (dBm), Options 224 or 423, Combine Mode - Typical	45
Table 8e. Maximum Leveled Power (dBm), Option 224	46
Table 8f. Maximum Leveled Power (dBm), Options 224 or 423 with 029 ¹	47
Table 8g. Maximum Leveled Power (dBm), Options 224 or 423 with 029 ¹ , Combine Mode - Typical	48
Table 8h. Maximum Leveled Power (dBm), Noise Mode ¹ , Options 224 or 423 with 029 - Typical	49
Table 8i. Maximum Leveled Power (dBm), Option 425	50
Table 8j. Maximum Leveled Power (dBm), Options 425, Combine Mode - Typical	51
Table 8k. Maximum Leveled Power (dBm), Port 1 and 2, Option 425 with 029 ¹	52
Table 8l. Maximum Leveled Power (dBm), Port 3 and 4, Option 425 with 029	53
Table 8m. Maximum Leveled Power (dBm), Option 425 with 029, Combine Mode - Typical	54
Table 8n. Maximum Power (dBm), All Ports, Option 425 with 029 (LFE Enabled), Combine Mode - Typical	55
Table 8o. Maximum Leveled Power (dBm), Noise Mode ¹ , Options 425 with 029 - Typical	56
Table 8p. Maximum Power (dBm), All Ports - Option 425 and Option 425 with 029 (LFE Enabled)	57
Table 8q. SRC3 Rear Panel Maximum Output Power (dBm) - Option XSB ¹	57
Table 9a. Power Level Accuracy (dB) at Nominal Power ¹ , All Options	58
Table 9b. Power Level Accuracy (dB), All Ports, Option 425 and Option 425 with 029 (LFE Enabled)	59
Table 10a. Power Level Linearity ¹ (dB), All Options - Specification	59
Table 10b. Power Level Linearity ¹ (dB), All Options - Specification	60
Table 10c. Power Level Linearity ¹ (dB), Option 224 - Specification	60
Table 10d. Power Level Linearity ¹ (dB), All Ports, Option 425 and Option 425 with 029 (LFE Enabled)	60
Table 11a. Power Sweep Range (dB), Options 201 or 401	61
Table 11b. Power Sweep Range (dB), Options 219 or 419	62
Table 11c. Power Sweep Range (dB), Options 224 or 423	63
Table 11d. Power Sweep Range (dB), Option 224	64
Table 11e. Power Sweep Range (dB), Options 224 or 423 with 029 ¹	65
Table 11f. Power Sweep Range (dB), Option 425	66
Table 11g. Power Sweep Range (dB), Option 425 with 029	67
Table 11h. Power Sweep Range (dB) - Option 425 and Option 425 with 029 (LFE Enabled)	67
Table 12. N5247B Nominal Power (Preset Power, dBm)	68
Table 13. Power Resolution and Maximum/Minimum Settable Power, All Ports ¹	68
Table 14a. 2 nd and 3 rd Harmonics at Max Specified Power (dBc), All Options - Typical	68
Table 14b. 2 nd and 3 rd Harmonics at Max Specified Power (dBc), All Ports, Option 425, (LFE Enabled) - Typical	69

Table 15. Non-Harmonic Spurs ¹ at Nominal Power (dBc), All Options, All Ports - Typical	69
Table 16a. Phase Noise (dBc/Hz), All Options, with UNY, Port 1, 3, Src2Out1 - Typical.....	70
Table 16b. Phase Noise (dBc/Hz), All Options, with UNY, Port 2, 4, Src2Out2 - Typical.....	70
Table 16c. Phase Noise (dBc/Hz), Option 425, 425 with 029, and with UNY, All Ports (LFE Enabled) - Typical	71
Table 16d. Phase Noise (dBc/Hz), All Options, without UNY, All Ports - Typical.....	71
Test Port Input	72
Table 17a. Noise Floor ¹ (dBm) @ 10 Hz IFBW, All Ports, All Options	72
Table 17b. Noise Floor (dBm) @ 10 Hz IFBW, Option 425, (LFE Enabled)	73
Table 18a. 0.1 dB Compression, All Options, All Ports - Typical	73
Table 18b. 0.1 dB Compression, All Ports, Option 425, (LFE Enabled) - Typical	73
Table 18c. Compression, All Ports, Option 425, (LFE Enabled) - Specification.....	74
Table 19. Compression, All Ports - Specification	74
Table 20a. Trace Noise ¹ Magnitude (dB rms)	75
Table 20b. Trace Noise ¹ Magnitude (dB rms), All Ports, Option 425, (LFE Enabled).....	75
Table 20c. Trace Noise ¹ Phase (deg rms)	76
Table 20d. Trace Noise ¹ Phase (deg rms), All Ports, Option 425, (LFE Enabled).....	76
Table 21. Reference Level - Specification	76
Table 22a. Stability ¹ - Typical	77
Table 22b. Stability ¹ Option 425, (LFE Enabled) - Typical	77
Table 23. Damage Input Level - Specification.....	77
Noise Receiver Input (Option 029 only)	78
Table 24. Noise Receiver Bandwidth	78
Table 25a. Receiver Noise Figure (dB), Port 2, @ 4 MHz BW, High Gain Setting	78
Table 25b. Receiver Noise Figure (dB), Port 2, @ 4 MHz BW, High Gain Setting, Option 425 with 029	78
Table 26. Noise Figure Trace Noise ¹ (dB rms) @ 4 MHz BW, All Gain Settings	79
Table 27. Noise Receiver Linearity (dB) @ 4 MHz BW - Specification	79
Table 28a. Noise Receiver Input Range - Specification	79
Table 28b. Noise Receiver Input Range, Option 425 with 029 - Specification.....	80
Dynamic Accuracy	81
Table 29. Dynamic Accuracy - Specification	81
Table 30. Test Port Input (Group Delay) ¹	87
General Information	88
Table 31. Miscellaneous Information	88
Table 32. Front Panel Information, All Options.....	88
Table 32. (Continued) Front Panel Information, All Options	89

Table 33. Rear Panel Information, All Options.....	89
Table 33. (Continued) Rear Panel Information	90
Table 33. (Continued) Rear Panel Information	91
Table 33. (Continued) Rear Panel Information	92
Table 34. Analyzer Dimensions and Weight	93
Operating Environment	93
Measurement Throughput Summary	94
Table 35a. Cycle Time (ms) for Measurement Completion, All Options - Typical	94
Table 35b. Typical Cycle Time (ms) for Full-Span Measurement Completion - Typical.....	95
Table 36. Cycle Time vs. IF Bandwidth - Typical	95
Table 37. Cycle Time (ms) vs. Number of Points - Typical.....	96
Table 38. Data Transfer Time ¹ (ms) - Typical.....	97
Table 39. Typical Cycle Time for Amplifier Noise Figure Measurement (Option 029 and S93029A)	97
Table 40. Typical Cycle Time for Amplifier Gain Compression Measurement (Option S93086A)	98
Table 41. Typical Cycle Time for Amplifier Swept Intermodulation Distortion Measurement (Option S93087A).....	98
Table 42. Typical Cycle Time for Converter Noise Figure Measurement (Option 029 and S93029A)	98
Table 43. Typical Cycle Time for Converter Measurement with SMC + Phase (Option S93083A)	99
Table 44. Typical Cycle Time for Converter Gain Compression Measurement (Option S93086A)	99
Table 45. Typical Cycle Time for Converter Swept Intermodulation Distortion Measurement (Option S93087A).....	99
Specifications: Front-Panel Jumpers	100
Table 46. Measurement Receiver Inputs (dBm) - Typical	100
Table 47a. Reference Receiver Inputs and Reference Source Outputs (dBm) - Typical	101
Table 47b. Reference Receiver Inputs and Reference Source Outputs (dBm) - Typical	102
Table 47c. Reference Receiver Inputs and Reference Source Outputs (dBm) - Typical	103
Table 48a. Source Outputs (dBm) - Typical.....	104
Table 48b. Source Outputs (dBm) - Typical	105
Table 49. Coupler Inputs (dB) - Typical	106
Table 50. Damage Level.....	107
Test Set Block Diagrams	108
Figure 1. 2-Port N5247B Base Unit Option 201	108
Figure 2. 2-Port N5247B Option 219.....	109
Figure 3. 2-Port N5247B Option 224.....	109
Figure 4. 2-Port N5247B Option 224 with 029.....	110
Figure 5. 4-Port N5247B Base Unit Option 401	110
Figure 6. 4-Port N5247B Option 419.....	111

Figure 7. 4-Port N5247B Option 423	111
Figure 8. 4-Port N5247B Option 423 with XSB	112
Figure 9. 4-Port N5247B Option 423 with 029	112
Figure 10. Option 425 Low Frequency Extension	113
Figure 11. Receiver Block Diagram	113

This is a complete list of the technical specifications for the N5247B PNA-X network analyzer with the following options:

Option 029, adds hardware and firmware for high-accuracy noise figure measurements. It requires Option 224, 423, or 425. [See the block diagram.](#)

Option 201, 2-port standard test set (includes six front-panel access loops) and power range. [See the block diagram.](#)

Option 219, 2-port standard test set (includes six front-panel access loops), power range, source and receiver attenuators (extended power range), and bias-tees. [See the block diagram.](#)

Option 224, 2-port standard test set (includes six front-panel access loops), power range, source and receiver attenuators (extended power range), internal second source, a combiner, mechanical switches to the 2-port analyzer, and bias tees. [See the block diagram.](#)

Option 401, 4-port standard test set (includes twelve front-panel access loops), power range, and an internal second source (Option 080 recommended). [See the block diagram.](#)

Option 419, 4-port standard test set (includes twelve front-panel access loops), power range, internal second source (Option 080 recommended), and source and receiver attenuators (extended power range), and bias-tees. [See the block diagram.](#)

Option 423, 4-port standard test set (includes six front-panel access loops), power range, source and receiver attenuators (extended power range), internal second source, a combiner, mechanical switches to the 4-port analyzer, and bias tees. [See the block diagram.](#)

Option 425, 4-port configurable test set, source and receiver attenuators, internal second source, combiner, mechanical switches, low frequency extension (LFE), with or without dedicated 50 GHz noise receiver. [See the block diagram.](#)

Notes

This document provides technical specifications for the 85058B calibration kit, and the N4694A 2-Port ECal module. Please download our free Uncertainty Calculator from http://www.keysight.com/find/na_calculator to generate the curves for your calibration kit and PNA setup. Typical performance information between 67 GHz and 70 GHz is shown in this document where available. The performance is degraded at particular frequencies in this range due to the modes of the 1.85 mm connectors used in the analyzer, test port cables and adapters.

For all tables in this data sheet, the specified performance at the exact frequency of a break is the degraded value of the two specifications at that frequency.

Definitions

All specifications and characteristics apply over a $25\text{ }^{\circ}\text{C} \pm 5\text{ }^{\circ}\text{C}$ range (unless otherwise stated) and 90 minutes after the instrument has been turned on.

Specification (spec.): Warranted performance. Specifications include guardbands to account for the expected statistical performance distribution, measurement uncertainties, and changes in performance due to environmental conditions.

Characteristic (char.): A performance parameter that the product is expected to meet before it leaves the factory, but that is not verified in the field and is not covered by the product warranty. A characteristic includes the same guardbands as a specification.

Typical (typ.): Expected performance of an average unit which does not include guardbands. It is not covered by the product warranty.

Nominal (nom.): A general, descriptive term that does not imply a level of performance. It is not covered by the product warranty.

Calibration: The process of measuring known standards to characterize a network analyzer's systematic (repeatable) errors.

Corrected (residual): Indicates performance after error correction (calibration). It is determined by the quality of calibration standards and how well "known" they are, plus system repeatability, stability, and noise.

Uncorrected (raw): Indicates instrument performance without error correction. The uncorrected performance affects the stability of a calibration.

Standard: When referring to the analyzer, this includes no options unless noted otherwise.

Standard and LFE measurements: With option 425, which adds low frequency extension (LFE) hardware, the LFE measurement range overlaps with the standard measurement range from 10 MHz to 100 MHz. With LFE Enabled, measurements from 500 Hz to 100 MHz use LFE hardware. With LFE Disabled, measurements from 10 MHz to 100 MHz use standard hardware. To measure below 10 MHz, LFE must be enabled. All measurements above 100 MHz use standard hardware, regardless of the LFE Enabled/Disabled setting.

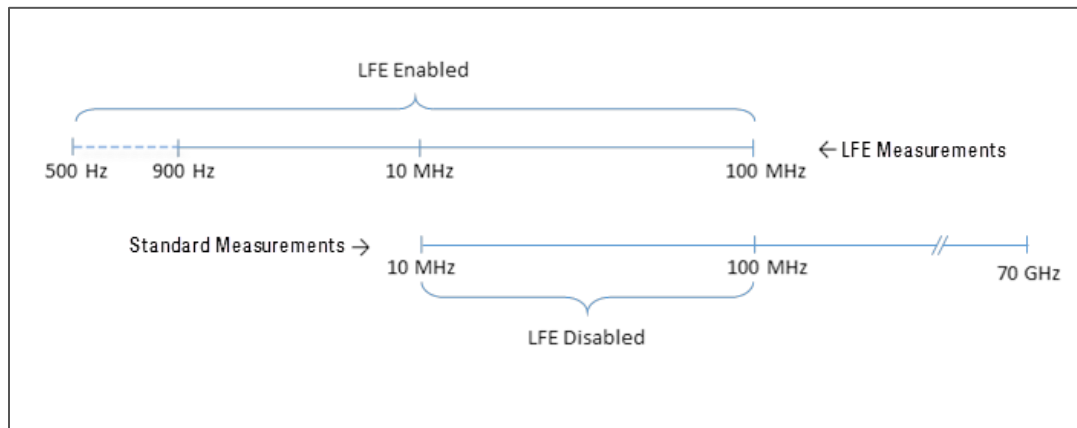

Dynamic Range

The specifications in this section apply for measurements made with the N5247B analyzer with the following conditions:

- 10 Hz IF bandwidth
 - No averaging applied to data
 - Isolation calibration with an averaging factor of 8
 - Source in filtered mode where applicable
-
- **System Dynamic Range** is defined as the measured source maximum output power (A) minus the measured noise floor (B).
 - **Extended Dynamic Range at Direct Access Input** is defined as the system dynamic range (typical) less the nominal loss associated with the test port coupler.
 - **Receiver Dynamic Range** is defined as the typical test port 0.1 dB compression (C) minus the typical noise floor (D).

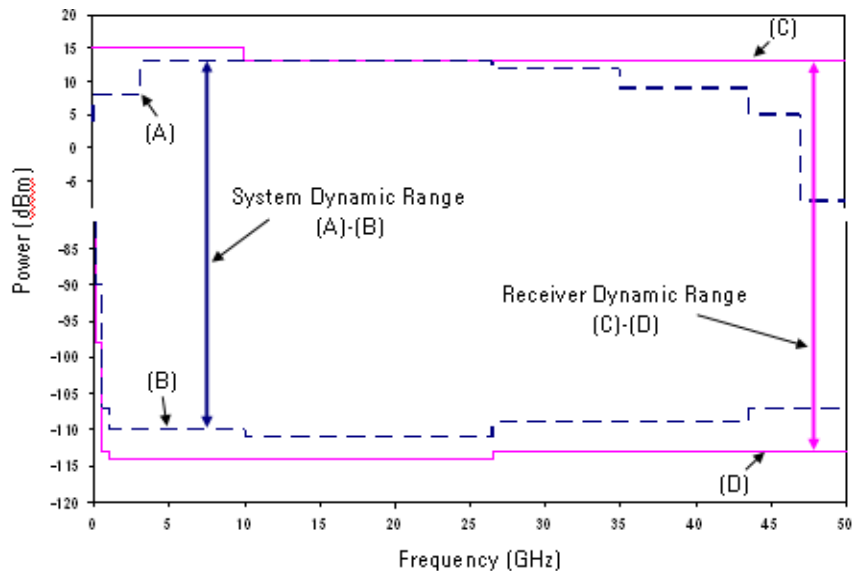

System Dynamic Range

Table 1a. System Dynamic Range at Test Port (dB), Options 201 or 401

Description	Specification		Typical	
	Ports ^{1,2} 1, 3	Ports ¹ 2, 4	Ports ^{1,2} 1, 3	Ports ¹ 2, 4
10 MHz to 50 MHz	87	87	96	96
50 MHz to 100 MHz	110	111	118	119
100 MHz to 500 MHz	117	117	131	131
500 MHz to 1 GHz	128	131	136	139
1 GHz to 2 GHz	131	132	138	139
2 GHz to 3.2 GHz	127	131	134	138
3.2 GHz to 10 GHz	131	130	139	138
10 GHz to 13.5 GHz	131	129	139	137
13.5 GHz to 16 GHz	131	129	138	137
16 GHz to 19 GHz	131	130	138	138
19 GHz to 24 GHz	131	130	138	137
24 GHz to 26.5 GHz	131	130	137	137
26.5 GHz to 30 GHz	122	122	130	129
30 GHz to 32 GHz	121	120	128	128
32 GHz to 35 GHz	121	120	128	128
35 GHz to 40 GHz	112	112	120	120
40 GHz to 43.5 GHz	117	118	125	125
43.5 GHz to 50 GHz	117	116	125	125
50 GHz to 60 GHz	115	114	124	123
60 GHz to 64 GHz	116	113	125	124
64 GHz to 67 GHz	117	114	126	125
67 GHz to 70 GHz	--	--	122	121

¹ Either port can be used as the source port. Any other port can be used as the receiver port.

² System Dynamic Range measured in High Power Mode.

Table 1b. System Dynamic Range at Test Port (dB), Options 219 or 419

Description	Specification		Typical	
	Ports ^{1,2} 1, 3	Ports ¹ 2, 4	Ports ^{1,2} 1, 3	Ports ¹ 2, 4
10 MHz to 50 MHz	84	81	94	93
50 MHz to 100 MHz	109	111	118	119
100 MHz to 500 MHz	116	117	130	131
500 MHz to 1 GHz	128	131	137	139
1 GHz to 2 GHz	130	132	138	139
2 GHz to 3.2 GHz	127	130	134	136
3.2 GHz to 10 GHz	130	131	139	138
10 GHz to 13.5 GHz	127	127	137	136
13.5 GHz to 16 GHz	127	127	136	136
16 GHz to 19 GHz	126	126	134	134
19 GHz to 24 GHz	126	126	134	134
24 GHz to 26.5 GHz	128	127	134	134
26.5 GHz to 30 GHz	116	114	125	124
30 GHz to 32 GHz	115	114	124	124
32 GHz to 35 GHz	115	113	124	123
35 GHz to 40 GHz	107	106	116	114
40 GHz to 43.5 GHz	112	113	120	121
43.5 GHz to 50 GHz	108	108	119	118
50 GHz to 60 GHz	107	107	118	117
60 GHz to 64 GHz	107	109	118	118
64 GHz to 67 GHz	109	110	119	119
67 GHz to 70 GHz	--	--	114	115

¹ Either port can be used as the source port. Any other port can be used as the receiver port.

² System Dynamic Range measured in High Power Mode.

Table 1c. System Dynamic Range at Test Port (dB), Option 224

Description	Specification		Typical	
	Source 2 Out 1 ¹	Source 2 Out 2	Source 2 Out 1 ¹	Source 2 Out 2
10 MHz to 50 MHz	85	85	95	95
50 MHz to 100 MHz	106	108	116	118
100 MHz to 500 MHz	115	116	130	132
500 MHz to 1 GHz	129	132	137	140
1 GHz to 2 GHz	130	133	138	141
2 GHz to 3.2 GHz	125	130	132	139
3.2 GHz to 10 GHz	132	132	140	141
10 GHz to 13.5 GHz	133	132	140	140
13.5 GHz to 16 GHz	132	133	139	141
16 GHz to 19 GHz	131	131	139	139
19 GHz to 24 GHz	132	132	139	139
24 GHz to 26.5 GHz	130	131	137	139
26.5 GHz to 30 GHz	119	119	129	129
30 GHz to 32 GHz	119	118	127	128
32 GHz to 35 GHz	119	119	127	128
35 GHz to 40 GHz	111	111	119	119
40 GHz to 43.5 GHz	114	115	124	125
43.5 GHz to 50 GHz	114	115	124	125
50 GHz to 60 GHz	113	115	123	123
60 GHz to 64 GHz	113	114	124	125
64 GHz to 67 GHz	115	115	126	126

¹ System Dynamic Range measured in High Power Mode.

Table 1d. System Dynamic Range at Test Port (dB), Options 224 or 423

Description	Specification		Typical			
	Ports ^{1,2} 1, 3	Ports ¹ 2, 4	Ports ^{1,2} 1, 3	Ports ¹ 2, 4	Source1 Port 1 Combine Mode	Source 2 Port 1 Combine Mode
10 MHz to 50 MHz	88	88	96	96	81	81
50 MHz to 100 MHz	112	112	119	119	104	104
100 MHz to 500 MHz	119	118	132	132	113	113
500 MHz to 1 GHz	130	130	137	137	123	123
1 GHz to 2 GHz	131	131	138	138	125	125
2 GHz to 3.2 GHz	127	128	133	133	127	127
3.2 GHz to 10 GHz	132	132	139	139	128	128
10 GHz to 13.5 GHz	131	131	138	138	127	127
13.5 GHz to 16 GHz	130	130	137	137	127	127
16 GHz to 19 GHz	128	128	135	135	126	126
19 GHz to 24 GHz	128	128	134	134	124	124
24 GHz to 26.5 GHz	128	127	134	134	124	124
26.5 GHz to 30 GHz	119	119	126	126	112	112
30 GHz to 32 GHz	117	117	124	124	109	109
32 GHz to 35 GHz	116	116	123	123	110	110
35 GHz to 40 GHz	108	108	116	116	107	107
40 GHz to 43.5 GHz	112	110	120	117	108	108
43.5 GHz to 50 GHz	111	111	119	119	108	108
50 GHz to 60 GHz	108	108	117	117	105	105
60 GHz to 64 GHz	109	109	118	118	104	104
64 GHz to 67 GHz	109	109	118	118	103	103

¹ Either port can be used as the source port. Any other port can be used as the receiver port.

² System Dynamic Range measured in High Power Mode.

Table 1e. System Dynamic Range at Test Port (dB), Options 224 or 423 with 029¹

Description	Specification		Typical			
	Port ² 1	Port 2	Port ² 1	Port 2	Source1 Port 1 Combine Mode	Source 2 Port 1 Combine Mode
10 MHz to 50 MHz	88	88	96	96	81	81
50 MHz to 100 MHz	113	113	119	120	104	104
100 MHz to 500 MHz	120	120	132	132	113	113
500 MHz to 1 GHz	131	132	137	139	123	123
1 GHz to 2 GHz	131	132	138	139	125	125
2 GHz to 3.2 GHz	127	130	134	137	127	127
3.2 GHz to 6 GHz	133	132	140	139	127	127
6 GHz to 10 GHz	132	131	138	137	127	127
10 GHz to 13.5 GHz	130	128	137	136	126	126
13.5 GHz to 16 GHz	130	130	137	136	127	127
16 GHz to 19 GHz	128	128	135	135	126	126
19 GHz to 24 GHz	127	127	134	134	124	124
24 GHz to 26.5 GHz	127	127	133	133	123	123
26.5 GHz to 30 GHz	118	118	125	125	111	111
30 GHz to 32 GHz	116	116	123	123	108	108
32 GHz to 35 GHz	116	116	123	123	109	109
35 GHz to 40 GHz	108	107	115	114	106	106
40 GHz to 43.5 GHz	112	111	119	119	106	106
43.5 GHz to 50 GHz	110	110	118	118	106	106
50 GHz to 60 GHz	107	107	116	116	103	103
60 GHz to 64 GHz	108	107	117	117	101	101
64 GHz to 67 GHz	108	108	117	117	101	101

¹ Option 029 affects system dynamic range with port 1 or port 2 as the source port. Refer to Table 1c for the system dynamic range with port 3 or port 4 as the source port. Port 1 impedance tuner switch is in bypass position and port 2 noise receiver switch is in normal position.

² System Dynamic Range measured in High Power Mode.

Table 1f. System Dynamic Range at Test Port (dB), Option 425

Description	Specification		Typical			
	Ports ^{2,3} 1, 3	Ports ³ 2, 4	Ports ^{2,3} 1, 3	Ports ³ 2, 4	Source1 Port 1 Combine Mode	Source 2 Port 1 Combine Mode
10 MHz to 50 MHz ¹	83	80	90	89	81	81
50 MHz to 100 MHz ¹	109	110	116	116	106	106
100 MHz to 500 MHz	116	116	128	128	115	115
500 MHz to 1 GHz	128	130	135	137	123	123
1 GHz to 2 GHz	131	131	138	138	128	128
2 GHz to 3.2 GHz	127	129	134	137	125	125
3.2 GHz to 10 GHz	131	129	138	137	126	126
10 GHz to 13.5 GHz	130	128	137	135	125	125
13.5 GHz to 16 GHz	127	128	136	137	125	125
16 GHz to 19 GHz	124	125	134	134	124	124
19 GHz to 24 GHz	124	126	134	134	123	123
24 GHz to 26.5 GHz	126	125	134	133	123	123
26.5 GHz to 30 GHz	116	115	125	125	111	111
30 GHz to 32 GHz	115	114	124	123	107	107
32 GHz to 35 GHz	116	113	124	123	108	108
35 GHz to 40 GHz	107	104	115	114	106	106
40 GHz to 43.5 GHz	111	108	120	117	107	107
43.5 GHz to 50 GHz	111	109	120	119	107	107
50 GHz to 60 GHz	108	106	117	116	104	104
60 GHz to 64 GHz	109	108	118	117	103	103
64 GHz to 67 GHz	108	109	118	118	101	101

¹ With Option 425 installed and LFE disabled, applied to frequencies \leq 100 MHz. Above 100 MHz, performance is the same for both LFE enabled or disabled. For LFE enabled performance \leq 100 MHz, see Table 1g.

² System Dynamic Range measured in High Power Mode.

³ Either port can be used as the source port. Any other port can be used as the receiver port.

Table 1g. System Dynamic Range at Test Port (dB), Option 425 (LFE Enabled)

Description	Specification		Typical	
	Ports 1, 3	Ports 2, 4	Ports 1, 3	Ports 2, 4
500 Hz to 900 Hz	--	--	105	105
900 Hz to 1 kHz	100	102	109	110
1 kHz to 10 kHz	103	105	110	111
10 kHz to 100 kHz	113	115	120	121
100 kHz to 1 MHz	120	121	124	125
1 MHz to 5 MHz	121	122	126	127
5 MHz to 10 MHz	112	114	118	119
10 MHz to 50 MHz	110	112	116	117
50 MHz to 100 MHz	110	112	116	117

Table 1h. System Dynamic Range at Test Port (dB), Option 425 (LFE Enabled), Combine Mode - Typical

Description	Source 1 Port 1	Source 2 Port 1
500 Hz to 900 Hz	99	98
900 Hz to 1 kHz	103	102
1 kHz to 10 kHz	104	103
10 kHz to 100 kHz	104	103
100 kHz to 1 MHz	118	118
1 MHz to 5 MHz	119	119
5 MHz to 10 MHz	111	110
10 MHz to 50 MHz	111	110
50 MHz to 100 MHz	111	110

Table 1i. System Dynamic Range at Test Port (dB), Option 425 with 029 - Specification

Description	Specification	
	Port ² 1	Port 2
10MHz to 50MHz ¹	82	81
50MHz to 100MHz ¹	109	108
100MHz to 500MHz	117	116
500MHz to 1GHz	129	130
1GHz to 2GHz	131	132
2GHz to 3.2GHz	126	130
3.2GHz to 6GHz	133	132
6GHz to 10GHz	131	130
10GHz to 13.5GHz	131	128
13.5GHz to 16GHz	130	128
16GHz to 19GHz	129	127
19GHz to 24GHz	128	128
24GHz to 26.5GHz	127	127
26.5GHz to 30GHz	118	116
30GHz to 32GHz	116	114
32GHz to 35GHz	116	114
35GHz to 40GHz	108	107
40GHz to 43.5GHz	111	111
43.5 GHz to 50GHz	111	111
50GHz to 60GHz	108	107
60GHz to 64GHz	109	108
64GHz to 67GHz	109	108

¹ With Option 425 installed and LFE disabled, applied to frequencies ≤ 100 MHz. Above 100 MHz, performance is the same for both LFE enabled or disabled. For LFE enabled performance ≤ 100 MHz, see Table 1g.

² System Dynamic Range measured in High Power Mode.

Table 1j. System Dynamic Range at Test Port (dB), Option 425 with 029 - Typical

Description	Option 425 with 029			
	Port ² 1	Port 2	Source1 Port 1 Combine Mode	Source 2 Port 1 Combine Mode
10MHz to 50MHz ¹	90	90	81	81
50MHz to 100MHz ¹	116	116	106	106
100MHz to 500MHz	128	128	115	115
500MHz to 1GHz	135	136	123	123
1GHz to 2GHz	138	138	128	128
2GHz to 3.2GHz	133	136	125	125
3.2GHz to 6GHz	139	139	125	125
6GHz to 10GHz	137	136	125	125
10GHz to 13.5GHz	137	135	124	124
13.5GHz to 16GHz	137	136	125	125
16GHz to 19GHz	135	135	124	124
19GHz to 24GHz	135	135	123	123
24GHz to 26.5GHz	134	133	122	122
26.5GHz to 30GHz	125	124	110	110
30GHz to 32GHz	123	122	106	106
32GHz to 35GHz	123	122	107	107
35GHz to 40GHz	115	115	105	105
40GHz to 43.5GHz	119	119	105	105
43.5GHz to 50GHz	118	119	105	105
50GHz to 60GHz	116	116	102	102
60GHz to 64GHz	117	117	100	100
64GHz to 67GHz	118	118	100	100

¹ With Option 425 installed and LFE disabled, applied to frequencies \leq 100 MHz. Above 100 MHz, performance is the same for both LFE enabled or disabled. For LFE enabled performance \leq 100 MHz, see Table 1g.

² System Dynamic Range measured in High Power Mode.

Extended Dynamic Range

Table 2a. Extended Dynamic Range at Direct Receiver Access Input (dB) - Typical

Description	Options 201, 401		Options 219, 419	
	Ports ¹ 1, 3	Ports ¹ 2, 4	Ports ¹ 1, 3	Ports ¹ 2, 4
10 MHz to 50 MHz	136	136	134	133
50 MHz to 100 MHz	146	147	146	147
100 MHz to 500 MHz	159	159	158	159
500 MHz to 1 GHz	164	167	165	167
1 GHz to 2 GHz	153	154	153	154
2 GHz to 3.2 GHz	149	153	149	151
3.2 GHz to 10 GHz	154	153	154	153
10 GHz to 13.5 GHz	153	151	151	150
13.5 GHz to 16 GHz	152	151	150	150
16 GHz to 19 GHz	152	152	148	148
19 GHz to 24 GHz	152	151	148	148
24 GHz to 26.5 GHz	151	151	148	148
26.5 GHz to 30 GHz	144	143	139	138
30 GHz to 32 GHz	142	142	138	138
32 GHz to 35 GHz	142	142	138	137
35 GHz to 40 GHz	134	134	130	128
40 GHz to 43.5 GHz	138	138	133	134
43.5 GHz to 50 GHz	138	138	132	131
50 GHz to 60 GHz	136	135	130	129
60 GHz to 64 GHz	136	135	129	129
64 GHz to 67 GHz	137	136	130	130
67 GHz to 70GHz	133	132	125	126

¹ Either port can be used as the source port. Any other port can be used as the receiver port.

Table 2b. Extended Dynamic Range at Direct Receiver Access Input (dB) - Typical

Description	Option 224		Option 224, 423		Options 224, 423	
	Source 2 Out 1	Source2 Out 2	Ports ¹ 1, 3	Ports ¹ 2, 4	Source 1 Port 1 Combine Mode	Source 2 Port 1 Combine Mode
10 MHz to 50 MHz	135	135	127	136	111	111
50 MHz to 100 MHz	144	146	138	147	117	117
100 MHz to 500 MHz	158	160	148	160	126	126
500 MHz to 1 GHz	165	168	157	165	136	136
1 GHz to 2 GHz	153	156	146	153	137	137
2 GHz to 3.2 GHz	147	154	148	148	139	139
3.2 GHz to 10 GHz	155	156	151	154	140	140
10 GHz to 13.5 GHz	154	154	149	152	139	139
13.5 GHz to 16 GHz	153	155	149	151	139	139
16 GHz to 19 GHz	153	153	148	149	137	137
19 GHz to 24 GHz	153	153	147	148	135	135
24 GHz to 26.5 GHz	151	153	147	148	135	135
26.5 GHz to 30 GHz	143	143	135	140	123	123
30 GHz to 32 GHz	141	142	133	138	120	120
32 GHz to 35 GHz	141	142	134	137	121	121
35 GHz to 40 GHz	133	133	131	130	118	118
40 GHz to 43.5 GHz	137	138	131	130	118	118
43.5 GHz to 50 GHz	137	138	131	132	118	118
50 GHz to 60 GHz	135	135	128	129	114	114
60 GHz to 64 GHz	135	136	127	129	112	112
64 GHz to 67 GHz	137	137	126	129	111	111

¹ Either port can be used as the source port. Any other port can be used as the receiver port.

Table 2c. Extended Dynamic Range at Direct Receiver Access Input (dB) - Typical

Description	Option 224 or 423 with 029		Option 224 or 423 with 029	
	Port 1	Port 2	Source 1 Port 1 Combine Mode	Source 2 Port 1 Combine Mode
10 MHz to 50 MHz	136	136	111	111
50 MHz to 100 MHz	147	148	117	117
100 MHz to 500 MHz	160	160	126	126
500 MHz to 1 GHz	165	167	136	136
1 GHz to 2 GHz	153	154	137	137
2 GHz to 3.2 GHz	149	152	139	139
3.2 GHz to 6 GHz	155	154	139	139
6 GHz to 10 GHz	153	152	139	139
10 GHz to 13.5 GHz	151	150	138	138
13.5 GHz to 16 GHz	151	150	139	139
16 GHz to 19 GHz	149	149	137	137
19 GHz to 24 GHz	148	148	134	134
24 GHz to 26.5 GHz	147	147	134	134
26.5 GHz to 30 GHz	139	139	122	122
30 GHz to 32 GHz	137	137	119	119
32 GHz to 35 GHz	137	137	120	120
35 GHz to 40 GHz	129	128	117	117
40 GHz to 43.5 GHz	132	132	116	116
43.5 GHz to 50 GHz	131	131	116	116
50 GHz to 60 GHz	128	128	112	112
60 GHz to 64 GHz	128	128	109	109
64 GHz to 67 GHz	128	128	109	109

¹ Option 029 affects system dynamic range with port 1 or port 2 as the source port. Refer to Table 2b for the extended dynamic range with port 3 or port 4 as the source port. Port 1 impedance tuner switch is in bypass position and port 2 noise receiver switch is in normal position.

Table 2d. Extended Dynamic Range at Direct Receiver Access Input (dB) - Typical

Description	Options 425	
	Ports ¹ 1, 3	Ports ¹ 2, 4
10 MHz to 50 MHz	130	129
50 MHz to 100 MHz	144	144
100 MHz to 500 MHz	156	156
500 MHz to 1 GHz	163	165
1 GHz to 2 GHz	153	153
2 GHz to 3.2 GHz	149	152
3.2 GHz to 10 GHz	153	152
10 GHz to 13.5 GHz	151	149
13.5 GHz to 16 GHz	150	151
16 GHz to 19 GHz	148	148
19 GHz to 24 GHz	148	148
24 GHz to 26.5 GHz	148	147
26.5 GHz to 30 GHz	139	139
30 GHz to 32 GHz	138	137
32 GHz to 35 GHz	138	137
35 GHz to 40 GHz	129	128
40 GHz to 43.5 GHz	133	130
43.5 GHz to 50 GHz	133	132
50 GHz to 60 GHz	129	128
60 GHz to 64 GHz	129	128
64 GHz to 67 GHz	129	129

¹ Either port can be used as the source port. Any other port can be used as the receiver port.

Table 2e. Extended Dynamic Range at Direct Receiver Access Input (dB) - Typical

Description	Option 425 029	
	Port 1	Port 2
10 MHz to 50 MHz	130	130
50 MHz to 100 MHz	144	144
100 MHz to 500 MHz	156	156
500 MHz to 1 GHz	163	164
1 GHz to 2 GHz	153	153
2 GHz to 3.2 GHz	148	151
3.2 GHz to 6 GHz	154	154
6 GHz to 10 GHz	152	151
10 GHz to 13.5 GHz	151	149
13.5 GHz to 16 GHz	151	150
16 GHz to 19 GHz	149	149
19 GHz to 24 GHz	149	149
24 GHz to 26.5 GHz	148	147
26.5 GHz to 30 GHz	139	138
30 GHz to 32 GHz	137	136
32 GHz to 35 GHz	137	136
35 GHz to 40 GHz	129	129
40 GHz to 43.5 GHz	132	132
43.5 GHz to 50 GHz	131	132
50 GHz to 60 GHz	128	128
60 GHz to 64 GHz	128	128
64 GHz to 67 GHz	129	129

Receiver Dynamic Range

Table 3a. Receiver Dynamic Range (dB), All Options

Description	Typical
10 MHz to 50 MHz	91
50 MHz to 100 MHz	113
100 MHz to 500 MHz	122
500 MHz to 1 GHz	131
1 GHz to 10 GHz	134
10 GHz to 16 GHz	133
16 GHz to 26.5 GHz	134
26.5 GHz to 30 GHz	122
30 GHz to 40 GHz	121
40 GHz to 50 GHz	119
50 GHz to 67 GHz	118
67 GHz to 70 GHz	106

Table 3b. Receiver Dynamic Range (dB), All Ports, Option 425 (LFE Enabled)

Description	Typical
500 Hz to 900 Hz	106
900 Hz to 1 kHz	109
1 kHz to 10 kHz	109
10 kHz to 100 kHz	118
100 kHz to 1 MHz	123
1 MHz to 5 MHz	123
5 MHz to 10 MHz	119
10 MHz to 50 MHz	120
50 MHz to 100 MHz	120

N5247B Corrected System Performance, All Options

Specifications are valid for temperatures of $23^{\circ}\pm 3^{\circ}\text{C}$ and $< 1^{\circ}\text{C}$ deviation from the calibration temperature. Specifications assume an N4697F flexible test port cable and a full 2-port calibration. For instruments with Option 029, the port 1 noise tuner switch is set to the bypass position, and the port 2 noise receiver switch is set to the normal position.

For any S_{ii} reflection measurement:

- $S_{jj} = 0$.

For any S_{ij} transmission measurement:

- $S_{ji} = S_{ij}$ when $S_{ij} \leq 1$
- $S_{ji} = 1/S_{ij}$ when $S_{ij} > 1$
- $S_{kk} = 0$ for all k

Please download our free Uncertainty Calculator from http://www.keysight.com/find/na_calculator for specifications for other calibration kits and measurement setups.

Table 4a. 85058B Calibration Kit

Description	Specification (dB)							
	10 MHz to 45 MHz	45 MHz to 2 GHz	2 GHz to 10 GHz	10 GHz to 20 GHz	20 GHz to 35 GHz	35 GHz to 50 GHz	50 GHz to 60 GHz	60 GHz to 67 GHz
Directivity	35	35	41	38	37	37	34	34
Source Match	34	34	44	40	41	42	40	40
Load Match	34	34	40	36	35	36	33	33
Reflection Tracking								
Mag	± 0.020	± 0.020	± 0.011	± 0.033	± 0.033	± 0.020	± 0.031	± 0.031
Phase ($^{\circ}$)	± 0.13	± 0.13	± 0.067	± 0.22	± 0.22	± 0.14	± 0.20	± 0.20
Transmission Tracking								
Mag	± 0.17	± 0.17	± 0.065	± 0.10	± 0.11	± 0.094	± 0.14	± 0.15
Phase ($^{\circ}$)	± 1.2	± 1.2	± 0.43	± 0.66	± 0.67	± 0.62	± 0.91	± 0.99

Transmission Uncertainty

S21 Magnitude Accuracy

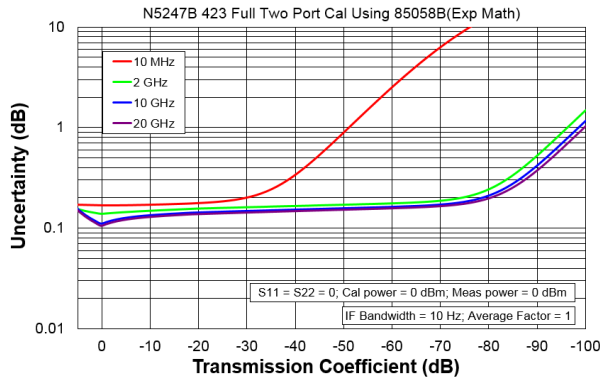

S21 Phase Accuracy

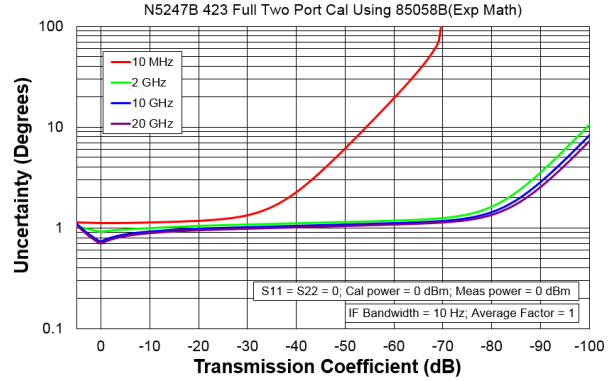

S21 Magnitude Accuracy

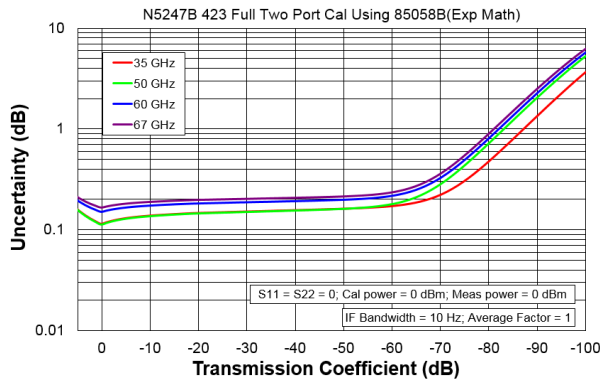

S21 Phase Accuracy

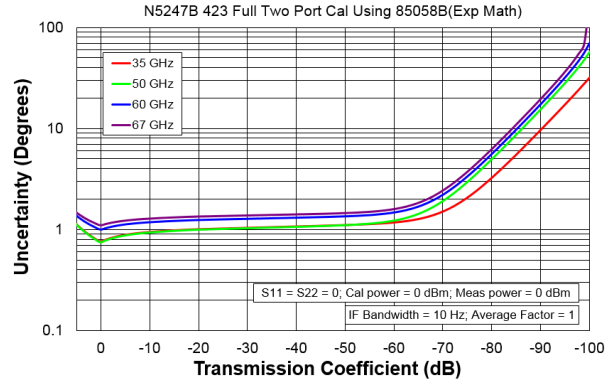

Reflection Uncertainty

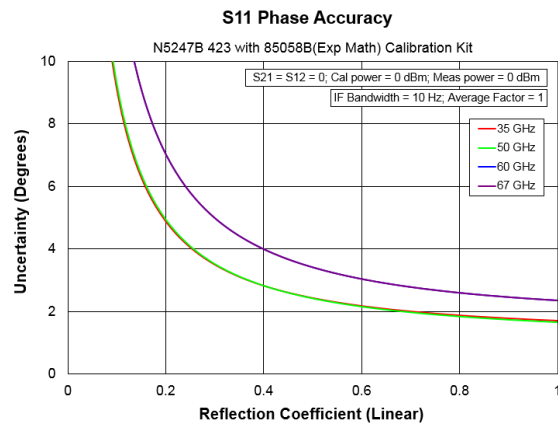
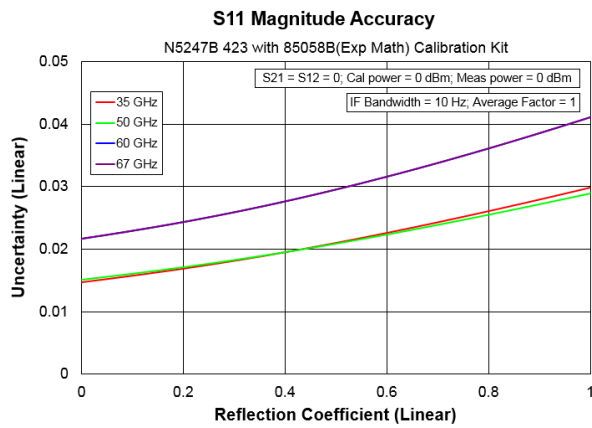
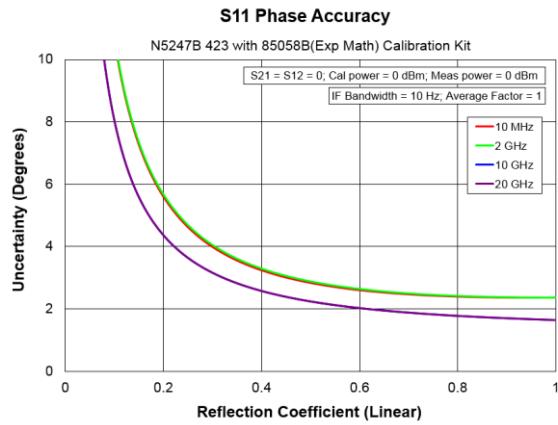
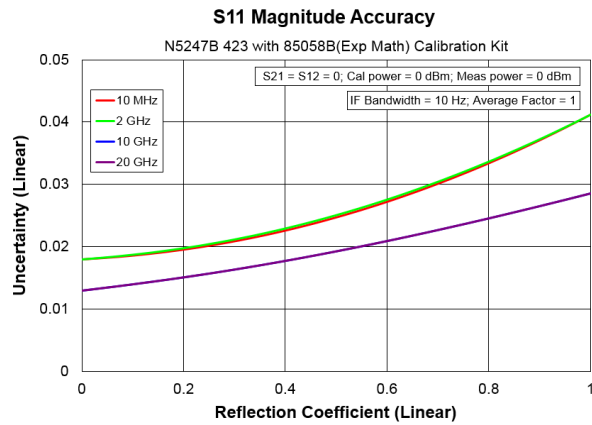
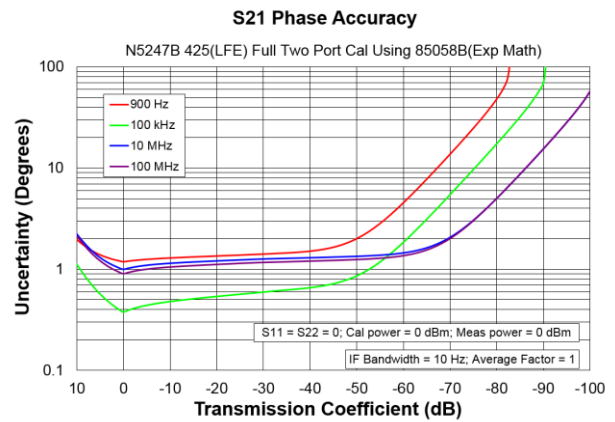
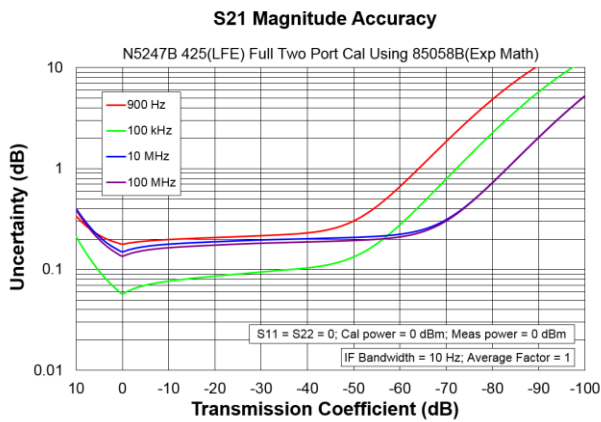

Table 4b. 85058B Calibration Kit, LFE Enabled (Option 425)

Description	Specification (dB)				
	1 kHz to 10 kHz	10 kHz to 1 MHz	1 MHz to 5 MHz	5 MHz to 50 MHz	50 MHz to 100 MHz
Directivity	35	35	35	35	35
Source Match	34	34	34	34	34
Load Match	34	35	35	34	34
Reflection Tracking					
Mag	±0.020	±0.020	±0.020	±0.020	±0.020
Phase (°)	±0.13	±0.13	±0.13	±0.13	±0.13
Transmission Tracking					
Mag	±0.15	±0.047	±0.11	±0.15	±0.13
Phase (°)	±1.0	±0.31	±0.69	±0.94	±0.83

Transmission Uncertainty, Option 425



Reflection Uncertainty, Option 425

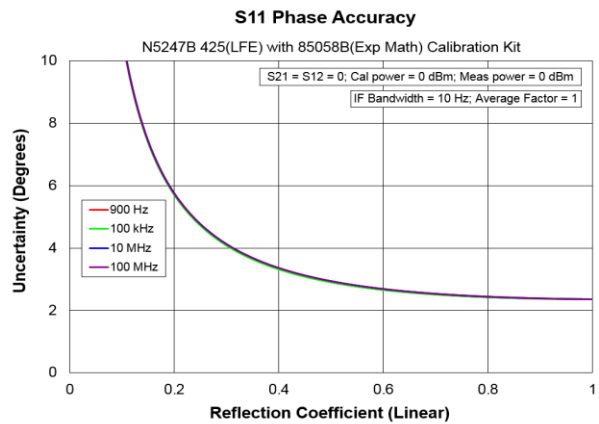
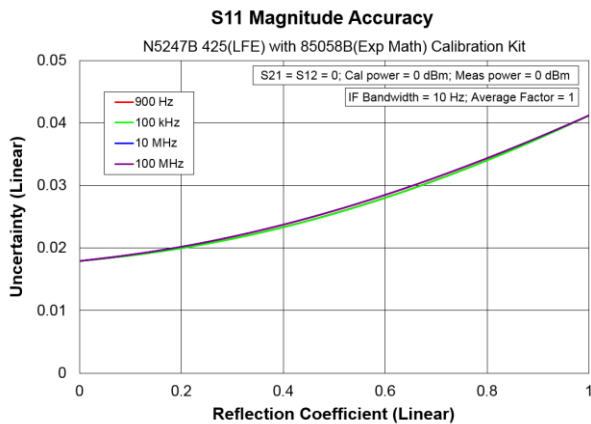
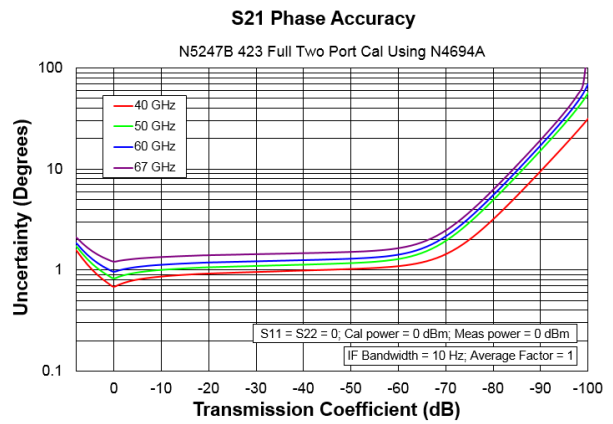
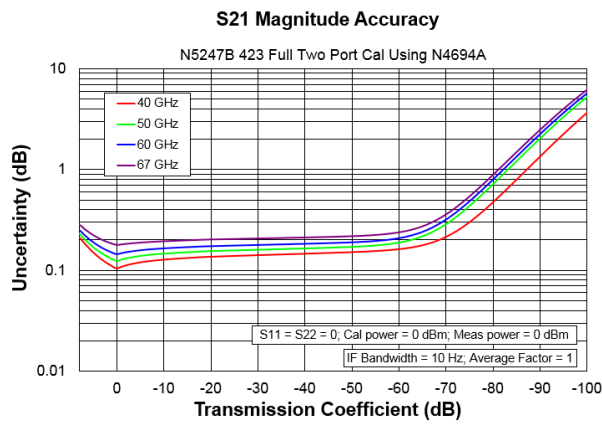
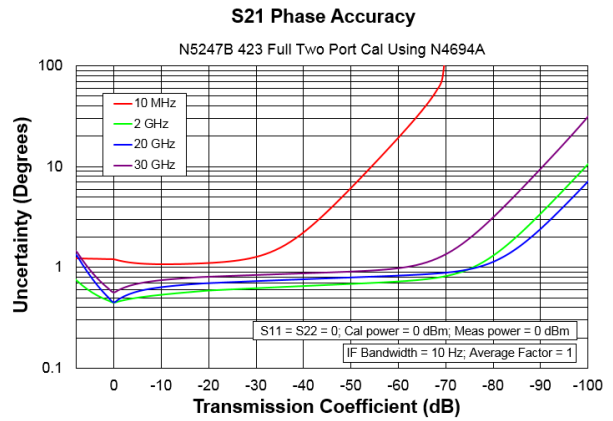
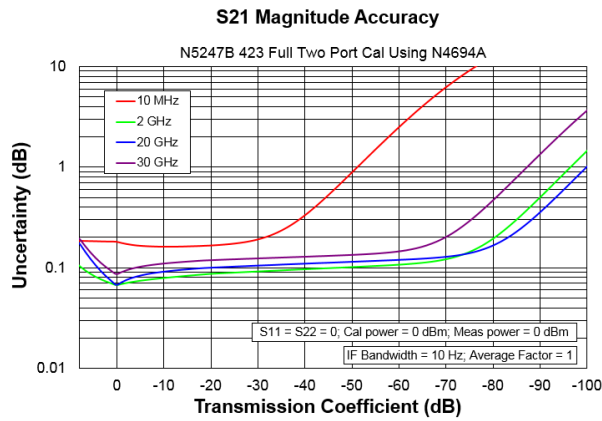

Table 5a. N4694A Calibration Kit

Description	Specification (dB)							
	10 MHz to 45 MHz	45 MHz to 2 GHz	2 GHz to 10 GHz	10 GHz to 20 GHz	20 GHz to 35 GHz	35 GHz to 50 GHz	50 GHz to 60 GHz	60 GHz to 67 GHz
Directivity	33	41	47	47	44	42	41	38
Source Match	25	38	39	39	34	33	30	27
Load Match	31	38	43	43	40	38	37	34
Reflection Tracking								
Mag	±0.051	±0.041	±0.041	±0.041	±0.061	±0.070	±0.081	±0.091
Phase (°)	±0.34	±0.27	±0.27	±0.27	±0.40	±0.47	±0.54	±0.60
Transmission Tracking								
Mag	±0.37	±0.11	±0.075	±0.075	±0.13	±0.15	±0.20	±0.28
Phase (°)	±2.5	±0.71	±0.50	±0.50	±0.83	±0.95	±1.3	±1.9

Transmission Uncertainty



Reflection Uncertainty

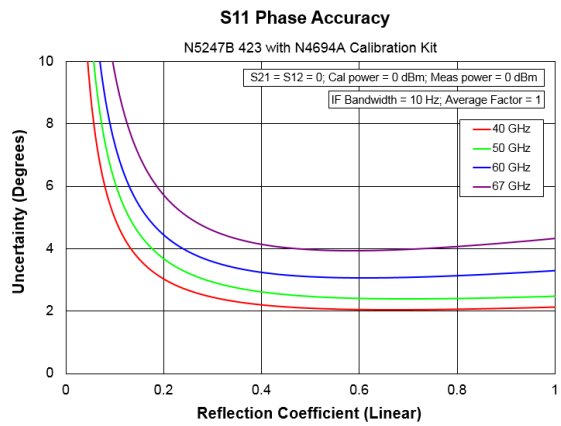
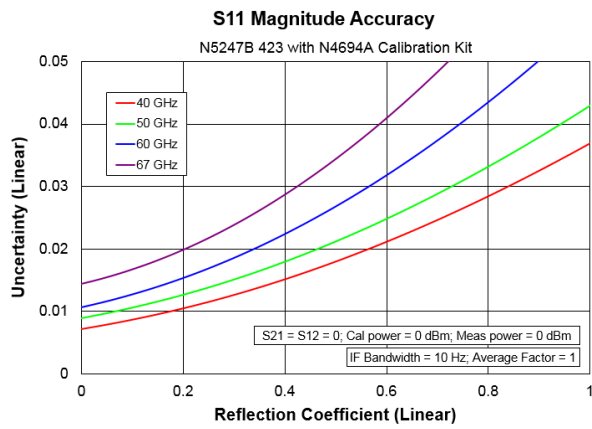
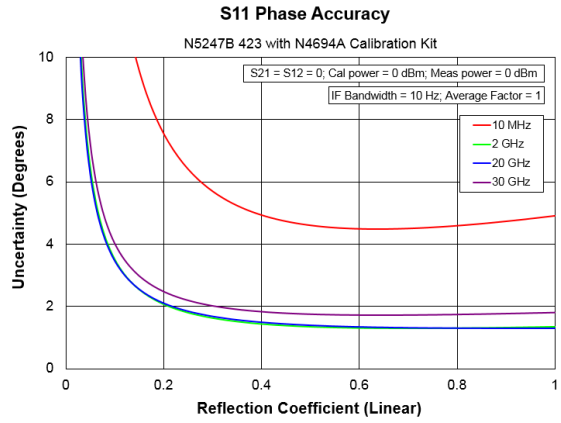
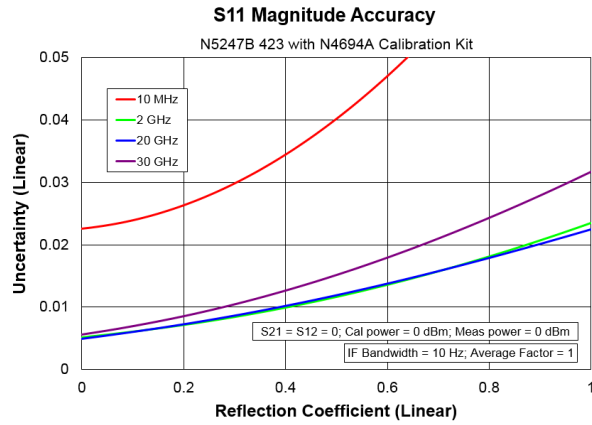
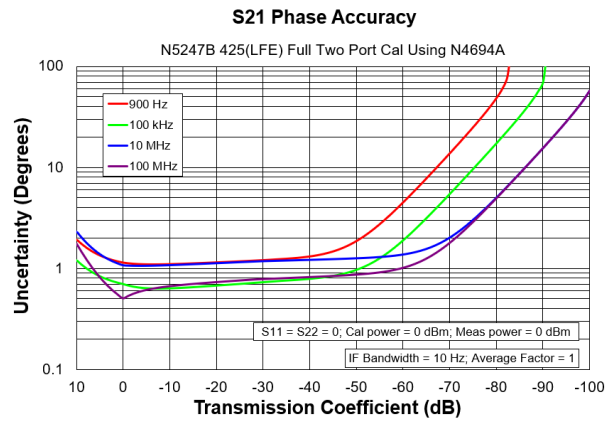
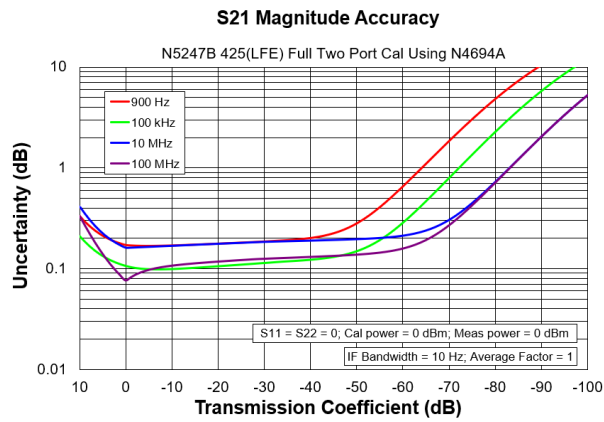

Table 5b. N4694A Calibration Kit, LFE Enabled (Option 425)

Description	Specification (dB)				
	1 kHz to 10 kHz	10 kHz to 1 MHz	1 MHz to 5 MHz	5 MHz to 50 MHz	50 MHz to 100 MHz
Directivity	33	33	33	33	41
Source Match	25	25	25	25	38
Load Match	24	24	24	24	36
Reflection Tracking					
Mag	±0.051	±0.051	±0.051	±0.051	±0.041
Phase (°)	±0.34	±0.34	±0.34	±0.34	±0.27
Transmission Tracking					
Mag	±0.14	±0.072	±0.11	±0.13	±0.068
Phase (°)	±0.91	±0.48	±0.70	±0.85	±0.45

Transmission Uncertainty, Option 425



Reflection Uncertainty, Option 425

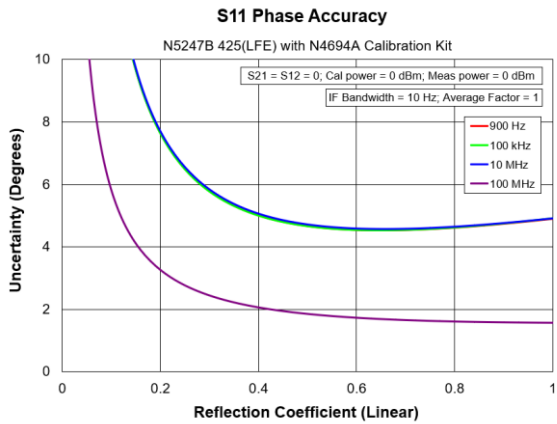
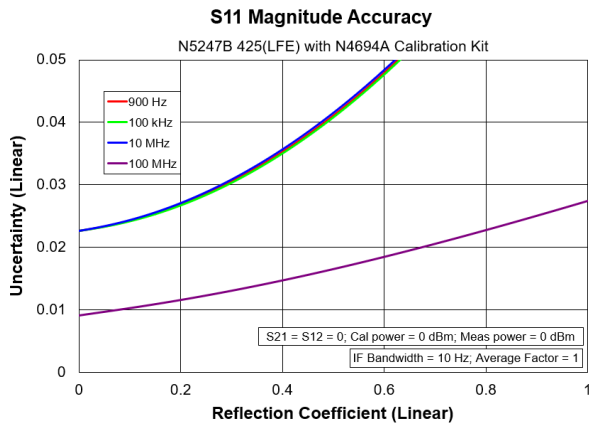
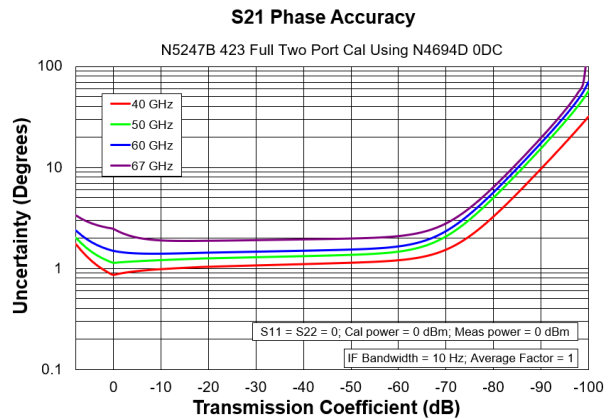
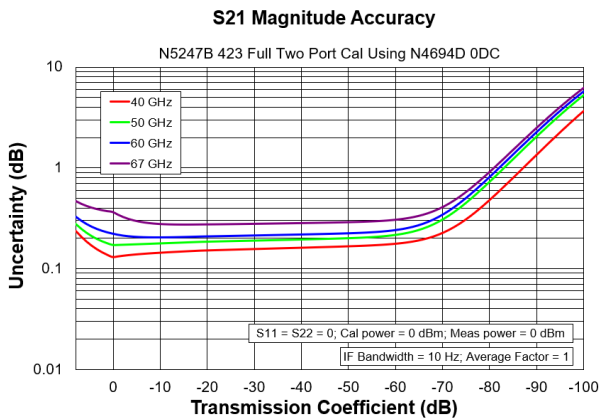
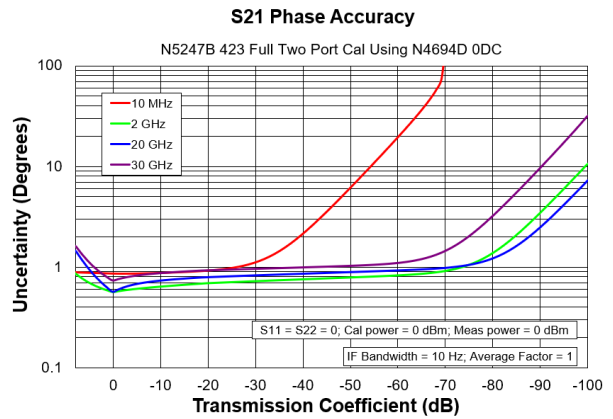
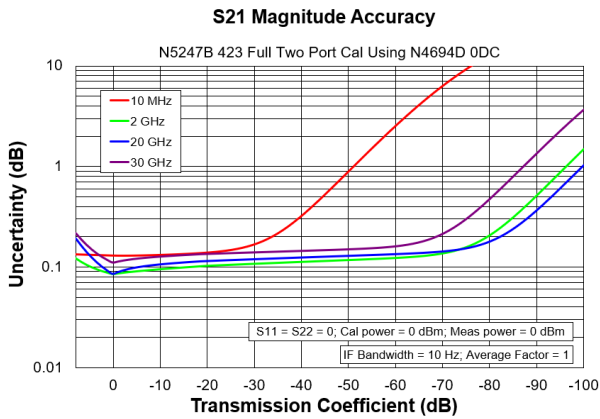

Table 5c. N4694D Calibration Kit

Description	Specification (dB)							
	10 MHz to 45 MHz	45 MHz to 2 GHz	2 GHz to 10 GHz	10 GHz to 20 GHz	20 GHz to 35 GHz	35 GHz to 50 GHz	50 GHz to 60 GHz	60 GHz to 67 GHz
Directivity	41	41	42	42	40	38	35	33
Source Match	38	38	39	39	34	33	30	26
Load Match	35	36	37	37	32	31	28	24
Reflection Tracking								
Mag	±0.081	±0.041	±0.041	±0.041	±0.061	±0.081	±0.081	±0.13
Phase (°)	±0.54	±0.27	±0.27	±0.27	±0.40	±0.54	±0.54	±0.80
Transmission Tracking								
Mag	±0.12	±0.079	±0.071	±0.075	±0.11	±0.14	±0.15	±0.22
Phase (°)	±0.79	±0.53	±0.47	±0.50	±0.69	±0.90	±0.99	±1.5

Transmission Uncertainty



Reflection Uncertainty

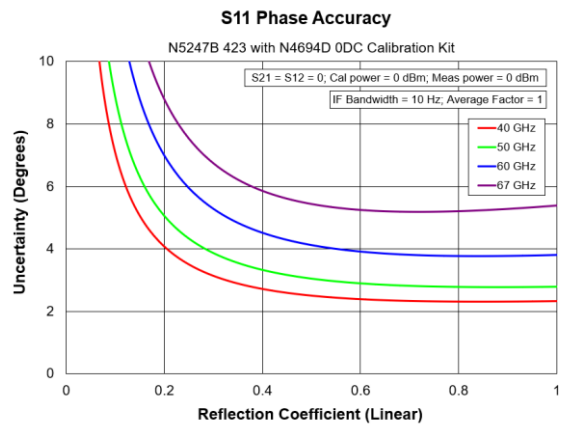
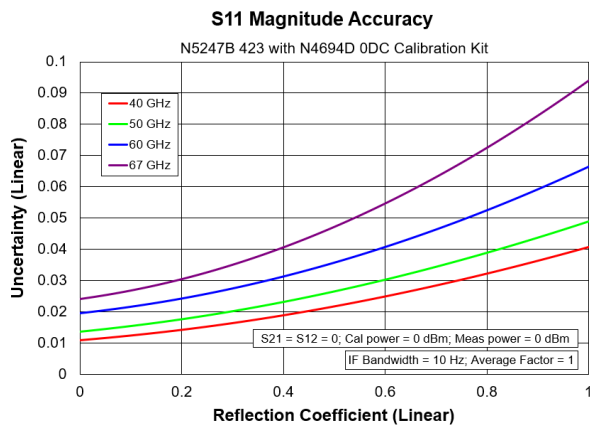
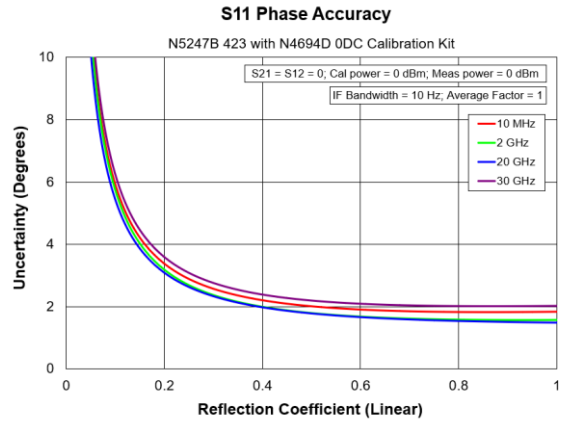
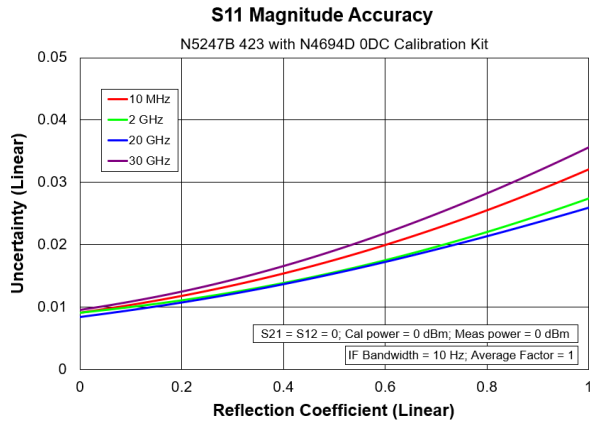
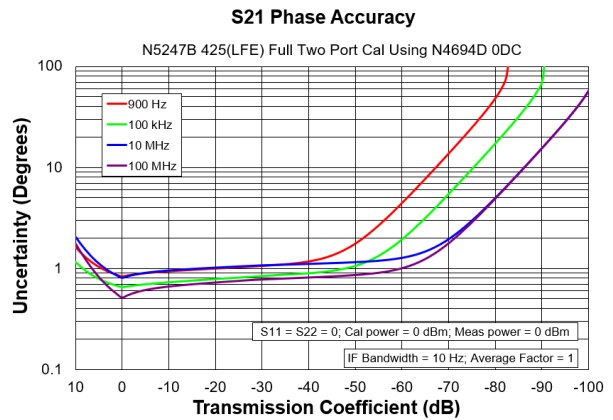
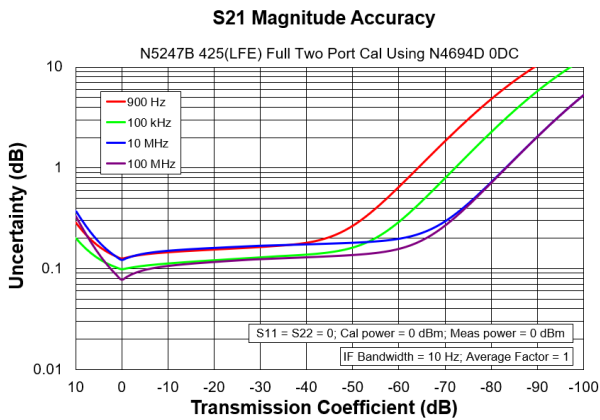

Table 5d. N4694D Calibration Kit, LFE Enabled (Option 425)

Description	Specification (dB)				
	1 kHz to 10 kHz	10 kHz to 1 MHz	1 MHz to 5 MHz	5 MHz to 50 MHz	50 MHz to 100 MHz
Directivity	41	41	41	41	41
Source Match	38	38	38	38	38
Load Match	35	37	36	35	36
Reflection Tracking					
Mag	±0.081	±0.081	±0.081	±0.081	±0.041
Phase (°)	±0.54	±0.54	±0.54	±0.54	±0.27
Transmission Tracking					
Mag	±0.12	±0.089	±0.11	±0.12	±0.068
Phase (°)	±0.76	±0.59	±0.68	±0.74	±0.45

Transmission Uncertainty, Option 425



Reflection Uncertainty, Option 425

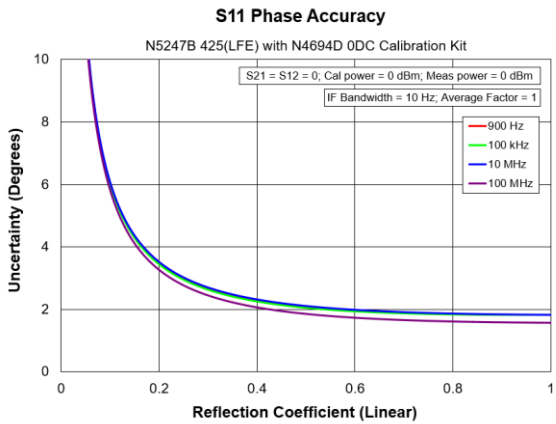
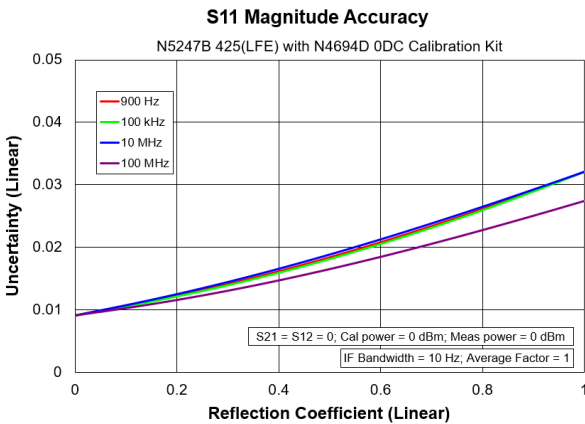

Uncorrected System Performance

Specifications apply to following conditions:

- Cable loss not included in Transmission Tracking.
- Crosstalk measurement conditions: normalized to a thru, measured with shorts on all ports, 10 Hz IF bandwidth, averaging factor of 8, alternate mode, source power set to the specified maximum power.
- With option 029, port 1 impedance tuner switch is in bypass position and port 2 noise receiver switch is in normal position unless specified.

Table 6a. Uncorrected System Performance (dB), All Options, All Ports - Specification

Description	Directivity	Source Match	Load Match
10 MHz to 50 MHz ¹	17 (17)	7 (7)	6 ² (6 ²)
50 MHz to 500 MHz ¹	24 (24)	15 (6)	11 (7)
500 MHz to 2 GHz	24 (24)	10 (6)	7 (7)
2 GHz to 3.2 GHz	20 (20)	10 (8)	7 (7)
3.2 GHz to 10 GHz	20 (20)	7 (7)	7 ² (7 ²)
10 GHz to 16 GHz	16 (16)	7 (7)	6 (6)
16 GHz to 20 GHz	16 (16)	7 (7)	7 ² (7 ²)
20 GHz to 26.5 GHz	14 (14)	7 (7)	7 ² (7 ²)
26.5 GHz to 50 GHz	13 (11)	7 (7)	6 (6)
50 GHz to 60 GHz	13 (13)	7 (6)	7 ² (7 ²)
60 GHz to 67 GHz	10 (10)	6 (5)	6 (6)

() With Option 425 installed.

¹ With Option 425 installed and LFE disabled, applied to frequencies \leq 100 MHz. Above 100 MHz, performance is the same for both LFE enabled or disabled. For LFE enabled performance \leq 100 MHz, see Table 6e and 6f.

² Port 1 and 2 load matches with Option 029 are degraded by 1 dB.

Table 6b. Uncorrected System Performance (dB), All Options, All Ports - Typical

Description	Directivity	Source Match	Load Match	Reflection Tracking	Transmission Tracking	Crosstalk
10 MHz to 50 MHz ¹	20	9 (9)	8 (8)	±1.5	±1.5	-84 (-81)
50 MHz to 100 MHz ¹	28	19 (10)	17 (11)	±1.5	±1.5	-107 (-103)
100 MHz to 500 MHz	28	19 (8)	17 (8)	±1.5	±1.5	-118 (-115)
500 MHz to 2 GHz	31	14 (9)	12 (8)	±1.5	±1.5	-126 (-122)
2 GHz to 3.2 GHz	28	14 (13)	12 (8)	±1.5	±1.5	-126 (-124)
3.2 GHz to 10 GHz	25	11 (11)	10 (10)	±1.5	±1.5	-128 (-126)
10 GHz to 13.5 GHz	23	10 (10)	10 (10)	±1.5	±1.5	-125 (-123)
13.5 GHz to 16 GHz	23	11 (11)	11 (11)	±1.5	±1.5	-128 (-125)
16 GHz to 20 GHz	20	11 (11)	11 (11)	±1.5	±1.5	-127 (-124)
20 GHz to 26.5 GHz	18	11 (11)	11 (11)	±1.5	±1.5	-126 (-124)
26.5 GHz to 35 GHz	16	11 (11)	11 (11)	±1.5	±1.5	-117 (-115)
35 GHz to 43.5 GHz	16	11 (11)	11 (11)	±1.5	±1.5	-111 (-109)
43.5 GHz to 46 GHz	19	11 (11)	11 (11)	±1.5	±1.5	-114 (-113)
46 GHz to 50 GHz	19	11 (11)	12 (12)	±1.5	±1.5	-116 (-114)
50 GHz to 60 GHz	16	11 (10)	12 (12)	±1.5	±1.5	-111 (-109)
60 GHz to 67 GHz	16	9 (8)	10 (10)	±1.5	±1.5	-110 (-108)
67 GHz to 70 GHz	15	10 (10)	10 (10)	+5/-10	±1.5	-107 (-105)

() With Option 425 installed.

¹ With Option 425 installed and LFE disabled, applied to frequencies ≤ 100 MHz. Above 100 MHz, performance is the same for both LFE enabled or disabled. For LFE enabled performance ≤ 100 MHz, see Table 6e and 6f.

Table 6c. Noise Mode¹ Uncorrected System Performance (dB), Option 029 - Specification

Description	Source Match		Load Match	
	Port 1	Port 2	Port 1	Port 2
10 MHz to 50 MHz ²	3 (7)	3 (9)	3 (9)	3 (9)
50 MHz to 500 MHz ²	8 (5)	12 (7)	8 (5)	12 (7)
500 MHz to 2 GHz	7 (5)	14 (7)	7 (6)	15 (7)
2 GHz to 3.2 GHz	7 (7)	14 (8)	7 (7)	14 (10)
3.2 GHz to 10 GHz	7 (7)	7 (7)	7 (7)	7 (7)
10 GHz to 50 GHz	6 (6)	6 (6)	6 (6)	6 (6)

¹Noise mode sets port 1 impedance tuner switch to tuner position and port 2 noise receiver switch to noise receiver position.

² With Option 425 installed and LFE disabled, applied to frequencies \leq 100 MHz. Above 100 MHz, performance is the same for both LFE enabled or disabled. For LFE enabled performance \leq 100 MHz, see Table 6e and 6f.

() With Option 425 installed.

Table 6d. Noise Mode¹ Uncorrected System Performance (dB), Option 029 - Typical

Description	Source Match		Load Match		Reflection Tracking		Transmission Tracking
	Port 1	Port 2	Port 1	Port 2	Port 1	Port 2	Port 1, 2
10 MHz to 50 MHz ²	4 (9)	4 (10)	3 (8)	4 (10)	-2.5/-5	\pm 2.5	\pm 1.5
50 MHz to 500 MHz ²	11 (10)	19 (8)	8 (8)	17 (12)	-2.5/-6.5	\pm 1.5	\pm 1.5
500 MHz to 2 GHz	12 (8)	14 (8)	7 (7)	20 (12)	-2.5/-6.5	\pm 1.5	\pm 1.5
2 GHz to 3.2 GHz	11 (9)	11 (9)	7 (7)	20 (12)	-2.5/-6.5	\pm 1.5	\pm 1.5
3.2 GHz to 10 GHz	10 (13)	10 (10)	6 (6)	10 (10)	-2.5/-6.5	\pm 1.5	\pm 1.5
10 GHz to 13.5 GHz	11 (11)	11 (11)	6 (6)	11 (11)	-2.5/-6.5	\pm 1.5	\pm 1.5
13.5 GHz to 16 GHz	11 (11)	11 (11)	6 (6)	11 (11)	-2.5/-6.5	\pm 1.5	\pm 1.5
16 GHz to 20 GHz	10 (10)	11 (11)	6 (6)	11 (11)	-4/-11	\pm 1.5	\pm 1.5
20 GHz to 24 GHz	11 (11)	11 (11)	6 (6)	11 (11)	-4/-11	\pm 1.5	\pm 1.5
24 GHz to 26.5 GHz	11 (11)	11 (11)	6 (6)	11 (11)	-4/-11	\pm 1.5	\pm 1.5
26.5 GHz to 43.5 GHz	11 (11)	11 (11)	6 (6)	11 (11)	-4/-9	\pm 2.5	\pm 1.5
43.5 GHz to 46 GHz	11 (11)	10 (10)	6 (6)	10 (10)	-5/-9.5	\pm 3	\pm 1.5
46 GHz to 50 GHz	11 (11)	11 (11)	6 (6)	11 (11)	-5/-9.5	\pm 3	\pm 1.5

¹Noise mode sets port 1 impedance tuner switch to tuner position and port 2 noise receiver switch to noise receiver position.

² With Option 425 installed and LFE disabled, applied to frequencies \leq 100 MHz. Above 100 MHz, performance is the same for both LFE enabled or disabled. For LFE enabled performance \leq 100 MHz, see Table 6e and 6f.

() With Option 425 installed.

Table 6e. Uncorrected System Performance (dB), All Ports, Option 425, (LFE Enabled) - Specifications

Description	Directivity	Source Match	Load Match	Transmission Tracking	Reflection Tracking	Crosstalk
1 kHz to 10 kHz	1	7	7	--	--	--
10 kHz to 1 MHz	16	15	19	--	--	--
1 MHz to 5 MHz	16	9	11	--	--	--
5 MHz to 50 MHz	5	7	8	--	--	--
50 MHz to 100 MHz	5	8	9	--	--	--

Table 6f. Uncorrected System Performance (dB), All Ports, Option 425, (LFE Enabled) - Typical

Description	Directivity	Source Match	Load Match	Transmission Tracking	Reflection Tracking	Crosstalk
500 Hz to 900 Hz	--	--	--	--	--	-102
900 Hz to 1 kHz	4	8	9	± 1.5	± 1.5	-106
1 kHz to 10 kHz	5	9	8	± 1.5	± 1.5	-100
10 kHz to 100 kHz	23	19	23	± 1.5	± 1.5	-106
100 kHz to 1 MHz	23	19	23	± 1.5	± 1.5	-126
1 MHz to 5 MHz	26	13	14	± 1.5	± 1.5	-121
5 MHz to 10 MHz	11	9	10	± 1.5	± 1.5	-121
10 MHz to 50 MHz	11	9	10	± 1.5	± 1.5	-117
50 MHz to 100 MHz	11	11	11	± 1.5	± 1.5	-117

Test Port Output

See Block diagrams for all models and options beginning on page 75.

With option 029, port 1 noise tuner switch is in bypass position and port 2 noise receiver switch is in normal position unless specified.

Table 7. Frequency Information, All Options

Description	Specification	Typical
Frequency Range	10 MHz to 67 GHz	67 GHz to 70 GHz
Frequency Range (Option 425)	900 Hz to 67 GHz	500 Hz to 900 Hz
Frequency Resolution	1 Hz	--
Frequency Accuracy	± 1 ppm	--
Frequency Stability	--	± 0.05 ppm, -10° to 70° C ¹ ± 0.1 ppm/yr maximum ²

¹ Assumes no variation in time.

² Assumes no variation in temperature.

Table 8a. Maximum Leveled Power (dBm), Options 201 or 401

Description	Specification			Typical		
	Ports ¹ 1, 3		Ports ¹ 2, 4	Ports ¹ 1, 3		Ports ¹ 2, 4
	Filtered Mode ²	Hi Power Mode ²		Filtered Mode ²	Hi Power Mode ²	
10 MHz to 50 MHz	4	10	10	12	19	17
50 MHz to 500 MHz	8	13	13	13	20	20
500 MHz to 1 GHz	8	13	13	14	19	20
1 GHz to 2 GHz	8	13	13	12	18	20
2 GHz to 3.2 GHz	10	10	13	15	16	17
3.2 GHz to 10 GHz	13	13	13	18	18	18
10 GHz to 13.5 GHz	11	11	11	16	16	15
13.5 GHz to 16 GHz	12	12	12	16	16	16
16 GHz to 19 GHz	10	10	10	15	15	15
19 GHz to 26.5 GHz	11	11	11	15	15	15
26.5 GHz to 30 GHz	10	10	10	14	14	14
30 GHz to 32 GHz	7	7	7	12	12	12
32 GHz to 35 GHz	9	9	9	13	13	13
35 GHz to 40 GHz	5	5	5	9	9	9
40 GHz to 67 GHz	10	10	10	13	13	13
67 GHz to 70 GHz	--	--	--	12	12	12

¹ Either port can be used as the source port.

² In Filtered Mode, the signal path goes through filters to minimize harmonics below 3.2 GHz. In Hi Power Mode, the signal bypasses the filters to maximize output power.

Table 8b. Maximum Leveled Power (dBm), Options 219 or 419

Description	Specification			Typical		
	Ports ¹ 1, 3		Ports ¹ 2, 4	Ports ¹ 1, 3		Ports ¹ 2, 4
	Filtered Mode ²	Hi Power Mode ²		Filtered Mode ²	Hi Power Mode ²	
10 MHz to 50 MHz	4	9	9	12	19	17
50 MHz to 500 MHz	8	13	13	13	20	20
500 MHz to 1 GHz	8	13	13	14	19	20
1 GHz to 2 GHz	8	13	13	12	18	20
2 GHz to 3.2 GHz	9	9	13	15	15	17
3.2 GHz to 10 GHz	11	11	12	18	18	18
10 GHz to 13.5 GHz	9	9	9	15	15	15
13.5 GHz to 16 GHz	10	10	10	15	15	15
16 GHz to 19 GHz	8	8	8	13	13	13
19 GHz to 24 GHz	8	8	8	12	12	12
24 GHz to 30 GHz	7	7	7	12	12	12
30 GHz to 32 GHz	5	5	5	10	10	10
32 GHz to 35 GHz	6	6	6	11	11	11
35 GHz to 40 GHz	1	1	1	8	8	8
40 GHz to 50 GHz	6	6	6	10	10	10
50 GHz to 60 GHz	5	5	5	10	10	10
60 GHz to 64 GHz	4	4	4	10	10	10
64 GHz to 67 GHz	4	4	4	9	9	9
67 GHz to 70 GHz	--	--	--	6	6	6

¹ Either port can be used as the source port.

² In Filtered Mode, the signal path goes through filters to minimize harmonics below 3.2 GHz. In Hi Power Mode, the signal bypasses the filters to maximize output power.

Table 8c. Maximum Levelled Power (dBm), Options 224 or 423

Description	Specification			Typical		
	Ports ¹ 1, 3		Ports ¹ 2, 4	Ports ¹ 1, 3		Ports ¹ 2, 4
	Filtered Mode ¹	Hi Power Mode ¹		Filtered Mode ¹	Hi Power Mode ¹	
10 MHz to 50 MHz	4	8	8	11	18	17
50 MHz to 500 MHz	7	13	13	12	19	19
500 MHz to 1 GHz	7	13	13	13	18	19
1 GHz to 2 GHz	7	13	13	12	17	19
2 GHz to 3.2 GHz	9	9	13	14	14	16
3.2 GHz to 10 GHz	11	11	12	17	17	17
10 GHz to 13.5 GHz	8	8	8	14	14	14
13.5 GHz to 16 GHz	9	9	9	14	14	14
16 GHz to 19 GHz	7	7	7	12	12	12
19 GHz to 24 GHz	7	7	7	11	11	11
24 GHz to 30 GHz	6	6	6	11	11	11
30 GHz to 32 GHz	4	4	4	9	9	9
32 GHz to 35 GHz	5	5	5	10	10	10
35 GHz to 40 GHz	0	0	0	7	7	7
40 GHz to 50 GHz	5	5	5	10	10	10
50 GHz to 60 GHz	4	4	4	9	9	9
60 GHz to 64 GHz	2	2	2	9	9	9
64 GHz to 67 GHz	2	2	2	8	8	8

¹ Either port can be used as the source port.

² In Filtered Mode, the signal path goes through filters to minimize harmonics below 3.2 GHz. In Hi Power Mode, the signal bypasses the filters to maximize output power.

Table 8d. Maximum Leveled Power (dBm), Options 224 or 423, Combine Mode - Typical

Description	Source 1 Port 1		Source 2 Port 1	
	Filtered Mode ¹	Hi Power Mode ¹	Filtered Mode ¹	Hi Power Mode ¹
10 MHz to 50 MHz	5	12	5	12
50 MHz to 500 MHz	6	13	6	13
500 MHz to 1 GHz	7	12	7	12
1 GHz to 2 GHz	6	11	6	11
2 GHz to 3.2 GHz	8	8	8	8
3.2 GHz to 10 GHz	9	9	9	9
10 GHz to 13.5 GHz	6	6	6	6
13.5 GHz to 16 GHz	6	6	6	6
16 GHz to 19 GHz	4	4	4	4
19 GHz to 24 GHz	2	2	2	2
24 GHz to 30 GHz	2	2	2	2
30 GHz to 32 GHz	-1	-1	-1	-1
32 GHz to 35 GHz	0	0	0	0
35 GHz to 40 GHz	-3	-3	-3	-3
40 GHz to 50 GHz	0	0	0	0
50 GHz to 60 GHz	-2	-2	-2	-2
60 GHz to 64 GHz	-3	-3	-3	-3
64 GHz to 67 GHz	-4	-5	-4	-5

¹ In Filtered Mode, the signal path goes through filters to minimize harmonics below 3.2 GHz. In Hi Power Mode, the signal bypasses the filters to maximize output power.

Table 8e. Maximum Leveled Power (dBm), Option 224

Description	Specification			Typical		
	Source 2 Out 1		Source 2 Out 2	Source 2 Out 1		Source 2 Out 2
	Filtered Mode ¹	Hi Power Mode ¹		Filtered Mode ¹	Hi Power Mode ¹	
10 MHz to 50 MHz	4	11	11	10	18	17
50 MHz to 500 MHz	8	17	15	12	21	21
500 MHz to 1 GHz	8	16	15	14	20	21
1 GHz to 2 GHz	8	15	15	14	19	21
2 GHz to 3.2 GHz	10	10	15	14	14	18
3.2 GHz to 10 GHz	14	14	16	19	19	20
10 GHz to 13.5 GHz	12	12	12	17	17	19
13.5 GHz to 16 GHz	13	13	13	17	17	18
16 GHz to 24 GHz	11	11	12	17	17	17
24 GHz to 30 GHz	11	11	12	16	16	16
30 GHz to 32 GHz	9	9	10	14	14	14
32 GHz to 35 GHz	11	11	11	15	15	15
35 GHz to 40 GHz	6	6	6	13	13	13
40 GHz to 50 GHz	11	11	11	16	16	17
50 GHz to 60 GHz	12	12	14	17	17	18
60 GHz to 67 GHz	12	12	14	17	17	19

¹ In Filtered Mode, the signal path goes through filters to minimize harmonics below 3.2 GHz. In Hi Power Mode, the signal bypasses the filters to maximize output power.

Table 8f. Maximum Leveled Power (dBm), Options 224 or 423 with 029¹

Description	Specification			Typical		
	Port 1		Port 2	Port 1		Port 2
	Filtered Mode ²	Hi Power Mode ²		Filtered Mode ²	Hi Power Mode ²	
10 MHz to 50 MHz	4	8	8	11	18	17
50 MHz to 500 MHz	7	13	13	12	19	19
500 MHz to 1 GHz	7	13	13	13	18	19
1 GHz to 2 GHz	7	13	13	12	17	19
2 GHz to 3.2 GHz	9	9	13	14	14	16
3.2 GHz to 10 GHz	9	9	10	16	16	16
10 GHz to 13.5 GHz	6	6	6	13	13	13
13.5 GHz to 16 GHz	6	6	6	14	14	14
16 GHz to 19 GHz	4	4	4	12	12	12
19 GHz to 24 GHz	4	4	4	11	11	11
24 GHz to 30 GHz	4	4	4	10	10	10
30 GHz to 32 GHz	2	2	2	8	8	8
32 GHz to 35 GHz	3	3	3	9	9	9
35 GHz to 40 GHz	-2	-2	-2	6	6	6
40 GHz to 50 GHz	4	4	4	8	8	8
50 GHz to 60 GHz	3	3	3	7	7	7
60 GHz to 64 GHz	1	1	1	6	6	6
64 GHz to 67 GHz	1	1	1	6	6	6

¹ Option 029 only affects port 1 and port 2 maximum leveled power. Refer to Table 8c and 8e for ports 3 and 4.

² In Filtered Mode, the signal path goes through filters to minimize harmonics below 3.2 GHz. In Hi Power Mode, the signal bypasses the filters to maximize output power.

Table 8g. Maximum Leveled Power (dBm), Options 224 or 423 with 029¹, Combine Mode - Typical

Description	Source 1 Port 1		Source 2 Port 1	
	Filtered Mode ²	Hi Power Mode ²	Filtered Mode ²	Hi Power Mode ²
10 MHz to 50 MHz	5	12	5	12
50 MHz to 500 MHz	6	13	6	13
500 MHz to 1 GHz	7	12	7	12
1 GHz to 2 GHz	6	11	6	11
2 GHz to 3.2 GHz	8	8	8	8
3.2 GHz to 10 GHz	8	8	8	8
10 GHz to 13.5 GHz	5	5	5	5
13.5 GHz to 16 GHz	6	6	6	6
16 GHz to 19 GHz	4	4	4	4
19 GHz to 24 GHz	2	2	2	2
24 GHz to 30 GHz	1	1	1	1
30 GHz to 32 GHz	-2	-2	-2	-2
32 GHz to 35 GHz	-1	-1	-1	-1
35 GHz to 40 GHz	-4	-4	-4	-4
40 GHz to 50 GHz	-2	-2	-2	-2
50 GHz to 60 GHz	-4	-4	-4	-4
60 GHz to 64 GHz	-6	-6	-6	-6
64 GHz to 67 GHz	-6	-7	-6	-7

¹ Option 029 only affects port 1 and port 2 maximum leveled power. Refer to Table 8c and 8e for ports 3 and 4.

² In Filtered Mode, the signal path goes through filters to minimize harmonics below 3.2 GHz. In Hi Power Mode, the signal bypasses the filters to maximize output power.

Table 8h. Maximum Leveled Power (dBm), Noise Mode¹, Options 224 or 423 with 029 - Typical

Description	Port 1				Port 1		Port 2
	Normal Mode		Source 1 Port 1 Combine Mode		Source 2 Port 1 Combine Mode		
	Filtered Mode ²	Hi Power Mode ²	Filtered Mode ²	Hi Power Mode ²	Filtered Mode ²	Hi Power Mode ²	
10 MHz to 50 MHz	6	13	0	7	0	7	5
50 MHz to 500 MHz	9	16	3	10	3	10	10
500 MHz to 2 GHz	9	14	3	8	3	8	10
2 GHz to 3.2 GHz	10	10	4	4	4	4	7
3.2 GHz to 10 GHz	12	12	4	4	4	4	6
10 GHz to 13.5 GHz	8	8	0	0	0	0	3
13.5 GHz to 16 GHz	9	9	1	1	1	1	4
16 GHz to 19 GHz	5	5	-3	-3	-3	-3	2
19 GHz to 30 GHz	4	4	-5	-5	-5	-5	0
30 GHz to 32 GHz	2	2	-8	-8	-8	-8	-2
32 GHz to 35 GHz	3	3	-7	-7	-7	-7	-1
35 GHz to 40 GHz	0	0	-10	-10	-10	-10	-4
40 GHz to 50 GHz	1	1	-9	-9	-9	-9	-2
50 GHz to 60 GHz	-1	-1	-12	-12	-12	-12	-3
60 GHz to 64 GHz	-2	-2	-14	-14	-14	-14	-8
64 GHz to 67 GHz	-2	-2	-14	-15	-15	-15	-8

¹ Noise mode sets port 1 impedance tuner switch to tuner position and port 2 noise receiver switch to noise receiver position.

² In Filtered Mode, the signal path goes through filters to minimize harmonics below 3.2 GHz. In Hi Power Mode, the signal bypasses the filters to maximize output power.

Table 8i. Maximum Leveled Power (dBm), Option 425

Description	Specification			Typical		
	Port 1, 3		Port 2, 4	Port 1, 3		Port 2, 4
	Filt. Mode ¹	Hi Pwr Mode ¹		Filt. Mode ¹	Hi Pwr Mode ¹	
10 MHz to 50 MHz ²	-3	1	1	4	11	10
50 MHz to 500 MHz ²	2	8	8	7	13	14
500 MHz to 2 GHz	2	8	8	7	12	14
2 GHz to 3.2 GHz	7	7	11	12	12	14
3.2 GHz to 10 GHz	9	9	10	15	15	15
10 GHz to 13.5 GHz	6	6	6	12	12	12
13.5 GHz to 16 GHz	7	7	7	12	12	12
16 GHz to 19 GHz	5	5	5	10	10	10
19 GHz to 24 GHz	6	6	6	10	10	10
24 GHz to 26.5 GHz	5	5	5	10	10	10
26.5 GHz to 30 GHz	5	5	5	10	10	10
30 GHz to 32 GHz	2	2	2	7	7	7
32 GHz to 35 GHz	3	3	3	8	8	8
35 GHz to 40 GHz	-1	-1	-1	6	6	6
40 GHz to 50 GHz	4	4	4	9	9	9
50 GHz to 60 GHz	3	3	3	8	8	8
60 GHz to 67 GHz	1	1	1	7	7	7

¹ In Filtered Mode, the signal path goes through filters to minimize harmonics below 3.2 GHz. In Hi Power Mode, the signal bypasses the filters to maximize output power.

² With Option 425 installed and LFE disabled, applied to frequencies ≤ 100 MHz. Above 100 MHz, performance is the same for both LFE enabled or disabled. For LFE enabled performance ≤ 100 MHz, see Table 8o.

Table 8j. Maximum Levelled Power (dBm), Options 425, Combine Mode - Typical

Description	Source 1 Port 1		Source 2 Port 1	
	Filtered Mode ¹	Hi Power Mode ¹	Filtered Mode ¹	Hi Power Mode ¹
10 MHz to 50 MHz ²	-2	5	-2	5
50 MHz to 500 MHz ²	1	8	1	8
500 MHz to 1 GHz	2	7	2	7
1 GHz to 2 GHz	4	9	4	9
2 GHz to 3.2 GHz	6	6	6	6
3.2 GHz to 10 GHz	7	7	7	7
10 GHz to 13.5 GHz	4	4	4	4
13.5 GHz to 16 GHz	4	4	4	4
16 GHz to 19 GHz	2	2	2	2
19 GHz to 24 GHz	1	1	1	1
24 GHz to 30 GHz	1	1	1	1
30 GHz to 32 GHz	-3	-3	-3	-3
32 GHz to 35 GHz	-2	-2	-2	-2
35 GHz to 40 GHz	-4	-4	-4	-4
40 GHz to 50 GHz	-1	-1	-1	-1
50 GHz to 60 GHz	-3	-3	-3	-3
60 GHz to 64 GHz	-4	-4	-4	-4
64 GHz to 67 GHz	-5	-6	-5	-6

¹ In Filtered Mode, the signal path goes through filters to minimize harmonics below 3.2 GHz. In Hi Power Mode, the signal bypasses the filters to maximize output power.

² With Option 425 installed and LFE disabled, applied to frequencies \leq 100 MHz. Above 100 MHz, performance is the same for both LFE enabled or disabled. For LFE enabled performance \leq 100 MHz, see Table 8o.

Table 8k. Maximum Leveled Power (dBm), Port 1 and 2, Option 425 with 029¹

Description	Specification			Typical		
	Port 1		Port 2	Port 1		Port 2
	Filt. Mode ²	Hi Pwr Mode ²		Filt. Mode ²	Hi Pwr Mode ²	
10 MHz to 50 MHz ³	-3	1	1	4	11	10
50 MHz to 500 MHz ³	2	8	8	7	13	14
500 MHz to 2 GHz	2	8	8	7	12	14
2 GHz to 3.2 GHz	7	7	11	12	12	14
3.2 GHz to 10 GHz	7	7	8	14	14	14
10 GHz to 13.5 GHz	4	4	4	11	11	11
13.5 GHz to 16 GHz	4	4	4	12	12	12
16 GHz to 19 GHz	2	2	2	10	10	10
19 GHz to 24 GHz	3	3	3	10	10	10
24 GHz to 26.5 GHz	3	3	3	9	9	9
26.5 GHz to 30 GHz	3	3	3	9	9	9
30 GHz to 32 GHz	0	0	0	6	6	6
32 GHz to 35 GHz	1	1	1	7	7	7
35 GHz to 40 GHz	-3	-3	-3	5	5	5
40 GHz to 50 GHz	3	3	3	7	7	7
50 GHz to 60 GHz	2	2	2	6	6	6
60 GHz to 67 GHz	0	0	0	5	5	5

¹ Option 029 only affects port 1 and port 2 maximum leveled power. Refer to Table 8l for ports 3 and 4.

² In Filtered Mode, the signal path goes through filters to minimize harmonics below 3.2 GHz. In Hi Power Mode, the signal bypasses the filters to maximize output power.

³ With Option 425 installed and LFE disabled, applied to frequencies ≤ 100 MHz. Above 100 MHz, performance is the same for both LFE enabled or disabled. For LFE enabled performance ≤ 100 MHz, see Table 8o.

Table 8L. Maximum Leveled Power (dBm), Port 3 and 4, Option 425 with 029

Description	Specification			Typical		
	Port 3		Port 4	Port 3		Port 4
	Filt. Mode ¹	Hi Pwr Mode ¹		Filt. Mode ¹	Hi Pwr Mode ¹	
10 MHz to 50 MHz ²	-3	1	1	4	11	10
50 MHz to 500 MHz ²	2	8	8	7	13	14
500 MHz to 2 GHz	2	8	8	7	12	14
2 GHz to 3.2 GHz	7	7	10	12	12	13
3.2 GHz to 10 GHz	9	9	10	15	15	15
10 GHz to 13.5 GHz	6	6	6	12	12	12
13.5 GHz to 16 GHz	7	7	7	12	12	12
16 GHz to 19 GHz	5	5	5	10	10	10
19 GHz to 24 GHz	6	6	6	10	10	10
24 GHz to 26.5 GHz	5	5	5	10	10	10
26.5 GHz to 30 GHz	5	5	5	10	10	10
30 GHz to 32 GHz	2	2	2	7	7	7
32 GHz to 35 GHz	3	3	3	8	8	8
35 GHz to 40 GHz	-1	-1	-1	6	6	6
40 GHz to 50 GHz	4	4	4	9	9	9
50 GHz to 60 GHz	3	3	3	8	8	8
60 GHz to 67 GHz	1	1	1	7	7	7

¹ In Filtered Mode, the signal path goes through filters to minimize harmonics below 3.2 GHz. In Hi Power Mode, the signal bypasses the filters to maximize output power.

² With Option 425 installed and LFE disabled, applied to frequencies \leq 100 MHz. Above 100 MHz, performance is the same for both LFE enabled or disabled. For LFE enabled performance \leq 100 MHz, see Table 8p.

Table 8m. Maximum Leveled Power (dBm), Option 425 with 029, Combine Mode - Typical

Description	Source 1 Port 1		Source 2 Port 1	
	Filtered Mode ¹	Hi Power Mode ¹	Filtered Mode ¹	Hi Power Mode ¹
10 MHz to 50 MHz ²	-2	5	-2	5
50 MHz to 500 MHz ²	1	8	1	8
500 MHz to 1 GHz	2	7	2	7
1 GHz to 2 GHz	4	9	4	9
2 GHz to 3.2 GHz	6	6	6	6
3.2 GHz to 10 GHz	6	6	6	6
10 GHz to 13.5 GHz	3	3	3	3
13.5 GHz to 16 GHz	4	4	4	4
16 GHz to 19 GHz	2	2	2	2
19 GHz to 24 GHz	1	1	1	1
24 GHz to 30 GHz	0	0	0	0
30 GHz to 32 GHz	-4	-4	-4	-4
32 GHz to 35 GHz	-3	-3	-3	-3
35 GHz to 40 GHz	-5	-5	-5	-5
40 GHz to 50 GHz	-3	-3	-3	-3
50 GHz to 60 GHz	-5	-5	-5	-5
60 GHz to 64 GHz	-7	-7	-7	-7
64 GHz to 67 GHz	-7	-8	-7	-8

¹ In Filtered Mode, the signal path goes through filters to minimize harmonics below 3.2 GHz. In Hi Power Mode, the signal bypasses the filters to maximize output power.

² With Option 425 installed and LFE disabled, applied to frequencies \leq 100 MHz. Above 100 MHz, performance is the same for both LFE enabled or disabled. For LFE enabled performance \leq 100 MHz, see Table 8n.

Table 8n. Maximum Power (dBm), All Ports, Option 425 with 029 (LFE Enabled), Combine Mode - Typical

Description	Source 1 Port 1	Source 2 Port 1
500 Hz to 900 Hz	6	6
900 Hz to 1 kHz	7	6
1 kHz to 10 kHz	7	7
10 kHz to 100 kHz	8	7
100 kHz to 1 MHz	8	7
1 MHz to 5 MHz	7	6
5 MHz to 10 MHz	5	4
10 MHz to 50 MHz	5	4
50 MHz to 100 MHz	5	4

Table 8o. Maximum Leveled Power (dBm), Noise Mode¹, Options 425 with 029 - Typical

Description	Port 1				Source 2 Port 1		Port 2
	Normal Mode		Combine Mode		Combine Mode		
	Filtered Mode ²	Hi Power Mode ²	Filtered Mode ²	Hi Power Mode ²	Filtered Mode ²	Hi Power Mode ²	
10 MHz to 50 MHz ³	-1	6	-7	0	-7	0	-2
50 MHz to 500 MHz ³	4	11	-2	5	-2	5	5
500 MHz to 2 GHz	4	9	-2	3	-2	3	5
2 GHz to 3.2 GHz	8	8	2	2	2	2	5
3.2 GHz to 10 GHz	10	10	2	2	2	2	4
10 GHz to 13.5 GHz	6	6	-2	-2	-2	-2	1
13.5 GHz to 16 GHz	7	7	-1	-1	-1	-1	2
16 GHz to 19 GHz	3	3	-5	-5	-5	-5	0
19 GHz to 30 GHz	3	3	-6	-6	-6	-6	-1
30 GHz to 32 GHz	0	0	-10	-10	-10	-10	-4
32 GHz to 35 GHz	1	1	-9	-9	-9	-9	-3
35 GHz to 40 GHz	-1	-1	-11	-11	-11	-11	-5
40 GHz to 50 GHz	0	0	-10	-10	-10	-10	-3
50 GHz to 60 GHz	-2	-2	-13	-13	-13	-13	-4
60 GHz to 64 GHz	-3	-3	-15	-15	-15	-15	-9
64 GHz to 67 GHz	-3	-3	-15	-16	-16	-16	-9

¹ Noise mode sets port 1 impedance tuner switch to tuner position and port 2 noise receiver switch to noise receiver position.

² In Filtered Mode, the signal path goes through filters to minimize harmonics below 3.2 GHz. In Hi Power Mode, the signal bypasses the filters to maximize output power.

³ With Option 425 installed and LFE disabled, applied to frequencies ≤ 100 MHz. Above 100 MHz, performance is the same for both LFE enabled or disabled.

Table 8p. Maximum Power (dBm), All Ports – Option 425 and Option 425 with 029 (LFE Enabled)

Description	Specification	Typical ¹
500 Hz to 900 Hz	--	12
900 Hz to 1 kHz	10	13
1 kHz to 10 kHz	12	13
10 kHz to 100 kHz	12	14
100 kHz to 1 MHz	12	14
1 MHz to 5 MHz	10	13
5 MHz to 10 MHz	9	11
10 MHz to 50 MHz	8	10
50 MHz to 100 MHz	8	10

¹ Values apply to all ports. Ports 2 and 4 typically 1 dB higher.

Table 8q. SRC3 Rear Panel Maximum Output Power (dBm) – Option XSB¹

Description	Typical
10 MHz to 6 GHz	9
6 GHz to 7.6 GHz	8.5
7.6 GHz to 9.6 GHz	8.5
9.6 GHz to 12 GHz	6.5
12 GHz to 13.5 GHz	7.5

¹ Option XSB requires Option 422 or Option 423.

Table 9a. Power Level Accuracy (dB) at Nominal Power¹, All Options

Description	Specification		Typical	
	Ports ² 1, 2, 3, 4	Source 2 Out 1 Source 2 Out 2	Ports ² 1, 2, 3, 4	Source 2 Out 1 Source 2 Out 2
10 MHz to 50 MHz ³	± 1.6	± 2.6	± 0.40	± 0.86
50 MHz to 1 GHz ³	± 1.0	± 2.0	± 0.29	± 0.40
1 GHz to 3.2 GHz	± 1.2	± 2.0	± 0.32	± 0.28
3.2 GHz to 10 GHz	± 1.5	± 2.0	± 0.39	± 0.80
10 GHz to 13.5 GHz	± 2.25	± 2.0	± 0.93	± 0.77
13.5 GHz to 20 GHz	± 2.25	± 2.5	± 0.51	± 0.68
20 GHz to 26.5 GHz	± 2.25	± 2.5	± 0.60	± 1.01
26.5 GHz to 40 GHz	± 3.0	± 3.5	± 0.83	± 1.26
40 GHz to 50 GHz	± 3.0	± 3.5	± 0.65	± 1.04
50 GHz to 60 GHz	± 4.0	± 4.0	± 1.03	± 1.57
60 GHz to 67 GHz	± 4.5	± 4.5	± 1.17	± 3.14
67 GHz to 70 GHz			± 4.62	± 7.22

¹ Level accuracy at power other than nominal power, Power Level Accuracy (dB) at Nominal Power + Power Level Linearity (dB)

² Any port can be used as the source port. Source in filtered mode where applicable.

³ With Option 425 installed and LFE disabled, applied to frequencies ≤ 100 MHz. Above 100 MHz, performance is the same for both LFE enabled or disabled. For LFE enabled performance ≤ 100 MHz, see Table 9b.

Table 9b. Power Level Accuracy (dB), All Ports, Option 425 and Option 425 with 029 (LFE Enabled)

Description	Specification	Typical
500 Hz to 900 Hz	--	± 0.1
900 Hz to 1 kHz	± 1.0	± 0.1
1 kHz to 10 kHz	± 1.0	± 0.1
10 kHz to 100 kHz	± 1.0	± 0.1
100 kHz to 1 MHz	± 1.0	± 0.15
1 MHz to 5 MHz	± 1.0	± 0.15
5 MHz to 10 MHz	± 1.0	± 0.2
10 MHz to 50 MHz	± 1.0	± 0.2
50 MHz to 100 MHz	± 1.0	± 0.2

Table 10a. Power Level Linearity¹ (dB), All Options - Specification

Description	Ports ² 1, 3 -25 dBm ≤ P < -20 dBm	Ports ² 1, 3 -20 dBm ≤ P < -15 dBm	Ports ² 1, 3 -15 dBm ≤ P ≤ Max Specified Port Power
10 MHz to 50 MHz ³	± 2.5	± 2.0	± 1.5
50 MHz to 67 GHz ³	± 1.5	± 1.5	± 1.5

¹ Referenced to nominal power

² Either port can be used as the source port. Source in filtered mode.

³ With Option 425 installed and LFE disabled, applied to frequencies ≤ 100 MHz. Above 100 MHz, performance is the same for both LFE enabled or disabled. For LFE enabled performance ≤ 100 MHz, see Table 10d.

Table 10b. Power Level Linearity¹ (dB), All Options - Specification

Description	Ports ² 2, 4	Ports ² 2, 4
	-25 dBm ≤ P < -20 dBm	-20 dBm ≤ P ≤ Max Specified Port Power
10 MHz to 50 MHz ³	± 4.0	± 2.0
50 MHz to 500 MHz ³	± 2.7	± 1.5
500 MHz to 10 GHz ³	± 2.5	± 1.5
10 GHz to 16 GHz	± 2.0	± 1.5
16 GHz to 67 GHz	± 1.5	± 1.5

¹ Referenced to nominal power.

² Either port can be used as the source port.

³ With Option 425 installed and LFE disabled, applied to frequencies ≤ 100 MHz. Above 100 MHz, performance is the same for both LFE enabled or disabled. For LFE enabled performance ≤ 100 MHz, see Table 10d.

Table 10c. Power Level Linearity¹ (dB), Option 224 - Specification

Description	Source 2 Out 1 ²	Source 2 Out 2
	-15 dBm ≤ P ≤ Max Specified Port Power	-15 dBm ≤ P ≤ Max Specified Port Power
10 MHz to 50 MHz ³	± 2.0	± 2.0
50 MHz to 67 GHz ³	± 1.5	± 1.5

¹ Referenced to nominal power.

² Source in filtered mode.

³ With Option 425 installed and LFE disabled, applied to frequencies ≤ 100 MHz. Above 100 MHz, performance is the same for both LFE enabled or disabled. For LFE enabled performance ≤ 100 MHz, see Table 10d.

Table 10d. Power Level Linearity¹ (dB), All Ports, Option 425 and Option 425 with 029 (LFE Enabled)

Description	Specification
500 Hz to 900 Hz	--
900 Hz to 100 MHz	±1.0

¹ Referenced to nominal power, from -25 dBm to max power.

Table 11a. Power Sweep Range (dB), Options 201 or 401

Description	Specification		Typical	
	Ports ¹ 1, 3	Ports ¹ 2, 4	Ports ¹ 1, 3	Ports ¹ 2, 4
10 MHz to 50 MHz	37	37	46	44
50 MHz to 500 MHz	38	38	47	47
500 MHz to 1 GHz	38	38	46	47
1 GHz to 2 GHz	38	38	45	47
2 GHz to 3.2 GHz	35	38	43	44
3.2 GHz to 10 GHz	38	38	45	45
10 GHz to 13.5 GHz	36	36	43	42
13.5 GHz to 16 GHz	37	37	43	43
16 GHz to 19 GHz	35	35	42	42
19 GHz to 24 GHz	36	36	42	42
24 GHz to 26.5 GHz	36	36	41	41
26.5 GHz to 30 GHz	35	35	41	41
30 GHz to 32 GHz	32	32	39	39
32 GHz to 35 GHz	34	34	40	40
35 GHz to 40 GHz	30	30	36	36
40 GHz to 67 GHz	35	35	40	40
67 GHz to 70 GHz	--	--	39	39

¹ Either port can be used as the source port. Source in Hi Power mode where applicable.

Table 11b. Power Sweep Range (dB), Options 219 or 419

Description	Specification		Typical	
	Ports ¹ 1, 3	Ports ¹ 2, 4	Ports ¹ 1, 3	Ports ¹ 2, 4
10 MHz to 50 MHz	36	36	46	44
50 MHz to 500 MHz	38	38	47	47
500 MHz to 1 GHz	38	38	46	47
1 GHz to 2 GHz	38	38	45	47
2 GHz to 3.2 GHz	34	38	42	44
3.2 GHz to 10 GHz	36	37	45	45
10 GHz to 13.5 GHz	34	34	42	42
13.5 GHz to 16 GHz	35	35	42	42
16 GHz to 19 GHz	33	33	40	40
19 GHz to 24 GHz	33	33	39	39
24 GHz to 30 GHz	32	32	39	39
30 GHz to 32 GHz	30	30	37	37
32 GHz to 35 GHz	31	31	38	38
35 GHz to 40 GHz	26	26	35	35
40 GHz to 50 GHz	31	31	37	37
50 GHz to 60 GHz	30	30	37	37
60 GHz to 64 GHz	29	29	37	37
64 GHz to 67 GHz	29	29	36	36
67 GHz to 70 GHz	--	--	33	33

¹ Either port can be used as the source port. Source in Hi Power mode where applicable.

Table 11c. Power Sweep Range (dB), Options 224 or 423

Description	Specification		Typical	
	Ports ¹ 1, 3	Ports ¹ 2, 4	Ports ¹ 1, 3	Ports ¹ 2, 4
10 MHz to 50 MHz	35	35	45	44
50 MHz to 500 MHz	38	38	46	46
500 MHz to 1 GHz	38	38	45	46
1 GHz to 2 GHz	38	38	44	46
2 GHz to 3.2 GHz	34	38	41	43
3.2 GHz to 10 GHz	36	37	44	44
10 GHz to 13.5 GHz	33	33	41	41
13.5 GHz to 16 GHz	34	34	41	41
16 GHz to 19 GHz	32	32	39	39
19 GHz to 24 GHz	32	32	38	38
24 GHz to 30 GHz	31	31	38	38
30 GHz to 32 GHz	29	29	36	36
32 GHz to 35 GHz	30	30	37	37
35 GHz to 40 GHz	25	25	34	34
40 GHz to 50 GHz	30	30	37	37
50 GHz to 60 GHz	29	29	36	36
60 GHz to 64 GHz	27	27	36	36
64 GHz to 67 GHz	27	27	35	35

¹ Either port can be used as the source port. Source in Hi Power mode where applicable.

Table 11d. Power Sweep Range (dB), Option 224

Description	Specification		Typical	
	Source 2 Out 1 ¹	Source 2 Out 2	Source 2 Out 1 ¹	Source 2 Out 2
10 MHz to 50 MHz	38	38	45	44
50 MHz to 500 MHz	42	40	48	48
500 MHz to 1 GHz	41	40	47	48
1 GHz to 2 GHz	40	40	46	48
2 GHz to 3.2 GHz	35	40	41	45
3.2 GHz to 10 GHz	39	41	46	47
10 GHz to 13.5 GHz	37	37	44	46
13.5 GHz to 16 GHz	38	38	44	45
16 GHz to 24 GHz	36	37	44	44
24 GHz to 30 GHz	36	37	43	43
30 GHz to 32 GHz	34	35	41	41
32 GHz to 35 GHz	36	36	42	42
35 GHz to 40 GHz	31	31	40	40
40 GHz to 50 GHz	36	36	43	44
50 GHz to 67 GHz	37	39	44	45

¹ Source in Hi Power mode where applicable.

Table 11e. Power Sweep Range (dB), Options 224 or 423 with 029¹

Description	Specification		Typical	
	Ports 1, 3 ²	Ports 2, 4 ²	Ports 1, 3 ²	Ports 2, 4 ²
10 MHz to 50 MHz	35	35	45	44
50 MHz to 500 MHz	38	38	46	46
500 MHz to 1 GHz	38	38	45	46
1 GHz to 2 GHz	38	38	44	46
2 GHz to 3.2 GHz	34	38	41	43
3.2 GHz to 10 GHz	34	35	43	43
10 GHz to 13.5 GHz	30	30	40	40
13.5 GHz to 16 GHz	31	31	41	41
16 GHz to 19 GHz	29	29	39	39
19 GHz to 24 GHz	29	29	38	38
24 GHz to 30 GHz	29	29	37	37
30 GHz to 32 GHz	27	27	35	35
32 GHz to 35 GHz	28	28	36	36
35 GHz to 40 GHz	23	23	33	33
40 GHz to 50 GHz	29	29	35	35
50 GHz to 60 GHz	28	28	34	34
60 GHz to 67 GHz	26	26	33	33

¹ Option 029 only affects port 1 and port 2 power sweep ranges. Refer to Table 11c and 11d for ports 3 and 4.

² Source in Hi Power mode where applicable.

Table 11f. Power Sweep Range (dB), Option 425

Description	Specification (dBm)				Typical (dBm)			
	Port 1	Port 2	Port 3	Port 4	Port 1	Port 2	Port 3	Port 4
10 MHz to 50 MHz ¹	26	26	26	26	38	37	38	37
50 MHz to 500 MHz ¹	33	33	33	33	40	41	40	41
500 MHz to 2 GHz	33	33	33	33	39	41	39	41
2 GHz to 3.2 GHz	32	36	32	36	39	41	39	41
3.2 GHz to 10 GHz	34	35	34	35	42	42	42	42
10 GHz to 13.5 GHz	31	31	31	31	39	39	39	39
13.5 GHz to 16 GHz	32	32	32	32	39	39	39	39
16 GHz to 19 GHz	30	30	30	30	37	37	37	37
19 GHz to 24 GHz	31	31	31	31	37	37	37	37
24 GHz to 26.5 GHz	30	30	30	30	37	37	37	37
26.5 GHz to 30 GHz	30	30	30	30	37	37	37	37
30 GHz to 32 GHz	27	27	27	27	34	34	34	34
32 GHz to 35 GHz	28	28	28	28	35	35	35	35
35 GHz to 40 GHz	24	24	24	24	33	33	33	33
40 GHz to 50 GHz	29	29	29	29	36	36	36	36
50 GHz to 60 GHz	28	28	28	28	35	35	35	35
60 GHz to 67 GHz	26	26	26	26	34	34	34	34

¹ With Option 425 installed and LFE disabled, applied to frequencies ≤ 100 MHz. Above 100 MHz, performance is the same for both LFE enabled or disabled. For LFE enabled performance ≤ 100 MHz, see Table 11h.

Table 11g. Power Sweep Range (dB), Option 425 with 029

Description	Specification (dBm)				Typical (dBm)			
	Port 1	Port 2	Port 3	Port 4	Port 1	Port 2	Port 3	Port 4
10 MHz to 50 MHz ¹	26	26	26	26	38	37	38	37
50 MHz to 500 MHz ¹	33	33	33	33	40	41	40	41
500 MHz to 2 GHz	33	33	33	33	39	41	39	41
2 GHz to 3.2 GHz	32	36	32	35	39	41	39	40
3.2 GHz to 10 GHz	32	33	34	35	41	41	42	42
10 GHz to 13.5 GHz	29	29	31	31	38	38	39	39
13.5 GHz to 16 GHz	29	29	32	32	39	39	39	39
16 GHz to 19 GHz	27	27	30	30	37	37	37	37
19 GHz to 24 GHz	28	28	31	31	37	37	37	37
24 GHz to 26.5 GHz	28	28	30	30	36	36	37	37
26.5 GHz to 30 GHz	28	28	30	30	36	36	37	37
30 GHz to 32 GHz	25	25	27	27	33	33	34	34
32 GHz to 35 GHz	26	26	28	28	34	34	35	35
35 GHz to 40 GHz	22	22	24	24	32	32	33	33
40 GHz to 50 GHz	28	28	29	29	34	34	36	36
50 GHz to 60 GHz	27	27	28	28	33	33	35	35
60 GHz to 67 GHz	25	25	26	26	32	32	34	34

¹ With Option 425 installed and LFE disabled, applied to frequencies ≤ 100 MHz. Above 100 MHz, performance is the same for both LFE enabled or disabled. For LFE enabled performance ≤ 100 MHz, see Table 11h.

Table 11h. Power Sweep Range (dB) –Option 425 and Option 425 with 029 (LFE Enabled)

Description	Specification	Typical
500 Hz to 900 Hz	--	39
900 Hz to 1 kHz	35	40
1 kHz to 10 kHz	37	40
10 kHz to 100 kHz	37	41
100 kHz to 1 MHz	37	41
1 MHz to 5 MHz	35	40
5 MHz to 10 MHz	34	38
10 MHz to 50 MHz	33	37
50 MHz to 100 MHz	33	37

Table 12. N5247B Nominal Power (Preset Power, dBm)

Description	Options 201, 401	Options 219, 419, 224, 423, 425	Option 224		Options 224, 423, 425	
	Ports ¹ 1, 2, 3, 4	Ports ¹ 1, 2, 3, 4	Source 2 Out 1	Source 2 Out 2	Source 1 Port 1 Combine Mode	Source 2 Port 1 Combine Mode
Preset Power	0	-5	0	0	-5	-5

¹ Any port can be used as the source port.

Table 13. Power Resolution and Maximum/Minimum Settable Power, All Ports¹

Description	Specification (dB)	Typical (dBm)		
	All Options	All Options	Options 201, 401	Options 219, 419, 224, 423, 425
Power Resolution	0.01	--	--	--
Maximum Settable Power	--	30	--	--
Minimum Settable Power	--	--	-30	-80

¹ Any port can be used as the source port.

Table 14a. 2nd and 3rd Harmonics at Max Specified Power (dBc), All Options - Typical

Listed frequency is fundamental frequency; test at max specified power.

Description	2 nd Harmonic		3 rd Harmonic	
	Ports ¹ 1, 3 Source 2 Out 1 ²	Ports ¹ 2, 4 Source 2 Out 2	Ports ¹ 1 3 Source 2 Out 1 ²	Ports ¹ 2, 4 Source 2 Out 2
10 MHz to 50 MHz ³	-51	-10	-51	-10
50 MHz to 2 GHz ³	-51	-13	-51	-13
2 GHz to 13.5 GHz	-60	-21	-60	-21
13.5 GHz to 23.4 GHz	-60	-60	-60	-60
23.4 GHz to 35 GHz	-60	-60	--	--

¹ Any port can be used as the source port. Source in Filtered mode where applicable.

² At port 1 max specified power.

³ With an LFE option installed and LFE disabled, applied to frequencies ≤ 100 MHz. Above 100 MHz, performance is the same for both LFE enabled or disabled. For LFE enabled performance ≤ 100 MHz, see Table 14b..

Table 14b. 2nd and 3rd Harmonics at Max Specified Power (dBc), All Ports, Option 425, (LFE Enabled) - Typical
 Listed frequency is fundamental frequency; test at max specified power.

Description	2nd Harmonic	3rd Harmonic
500 Hz to 900 Hz	-32	-31
900 Hz to 1 kHz	-22	-23
1 kHz to 10 kHz	-22	-23
10 kHz to 100 kHz	-22	-23
100 kHz to 1 MHz	-25	-22
1 MHz to 5 MHz	-28	-24
5 MHz to 10 MHz	-27	-22
10 MHz to 33 MHz	-28	-21
33 MHz to 50 MHz	-28	--

Table 15. Non-Harmonic Spurs¹ at Nominal Power (dBc), All Options, All Ports - Typical

Description	Spurious (dBc)
Non-Harmonic Spurious	-74
±600 MHz Tracking Spurious	-64

¹ Non-harmonic spurs are negligible with Option 425 installed and LFE enabled.

Table 16a. Phase Noise (dBc/Hz), All Options, with UNY, Port 1, 3, Src2Out1 - Typical

CW Frequency	100 Hz Offset	1 kHz Offset	10 kHz Offset	100 kHz Offset	1 MHz Offset	10 MHz Offset
1 GHz	-115	-130	-137	-143	-145	-144
5 GHz	-100	-119	-132	-136	-147	-150
10 GHz	-94	-113	-127	-131	-143	-146
20 GHz	-88	-107	-118	-124	-135	-140

Table 16b. Phase Noise (dBc/Hz), All Options, with UNY, Port 2, 4, Src2Out2 - Typical

CW Frequency	100 Hz Offset	1 kHz Offset	10 kHz Offset	100 kHz Offset	1 MHz Offset	10 MHz Offset
1 GHz	-111	-118	-133	-146	-150	-150
5 GHz	-100	-118	-127	-135	-144	-148
10 GHz	-95	-108	-120	-128	-140	-147
20 GHz	-89	-106	-116	-123	-134	-139

Phase Noise with Option UNY

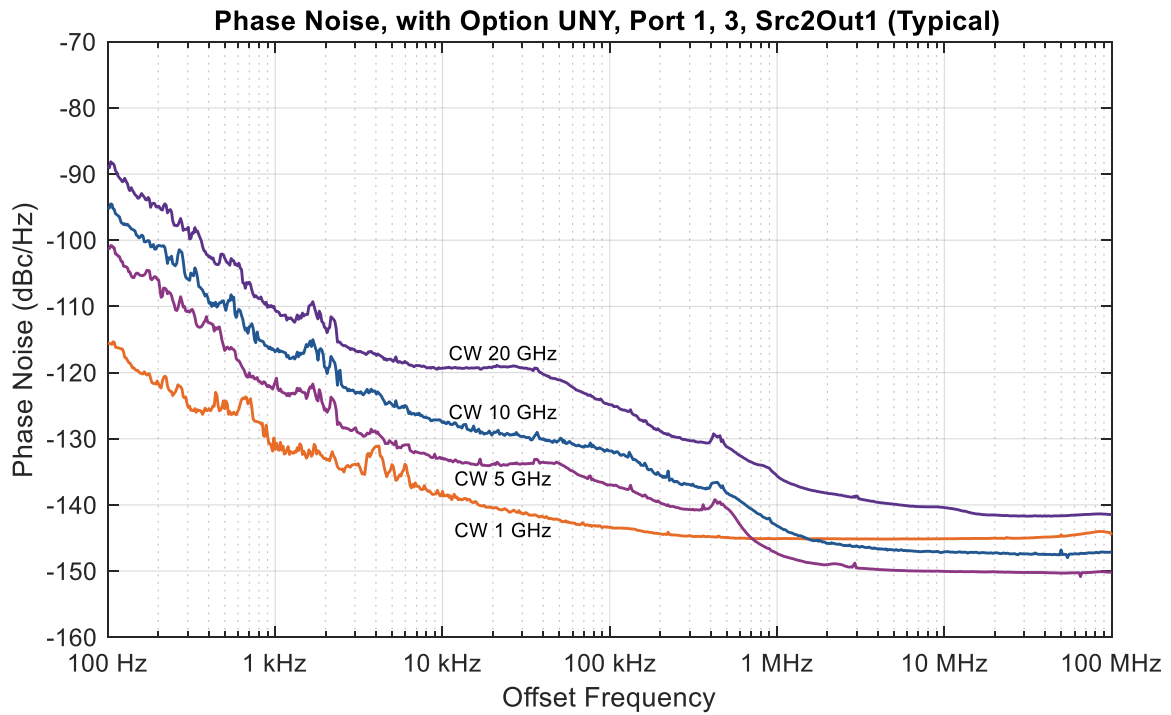

Table 16c. Phase Noise (dBc/Hz), Option 425, 425 with 029, and with UNY, All Ports (LFE Enabled) - Typical

Description	1 kHz Offset	10 kHz Offset	100 kHz Offset	1 MHz Offset
500 Hz to 100 MHz	-120	-130	-125	-135

Table 16d. Phase Noise (dBc/Hz), All Options, without UNY, All Ports - Typical

CW Frequency	100 Hz Offset	1 kHz Offset	10 kHz Offset	100 kHz Offset	1 MHz Offset	10 MHz Offset
1 GHz	-92	-115	-130	-140	-145	-145
5 GHz	-82	-104	-118	-128	-138	-146
10 GHz	-76	-98	-112	-122	-132	-141
20 GHz	-70	-92	-106	-116	-126	-134

Phase Noise, CW 10 GHz, with Option UNY and without Option UNY

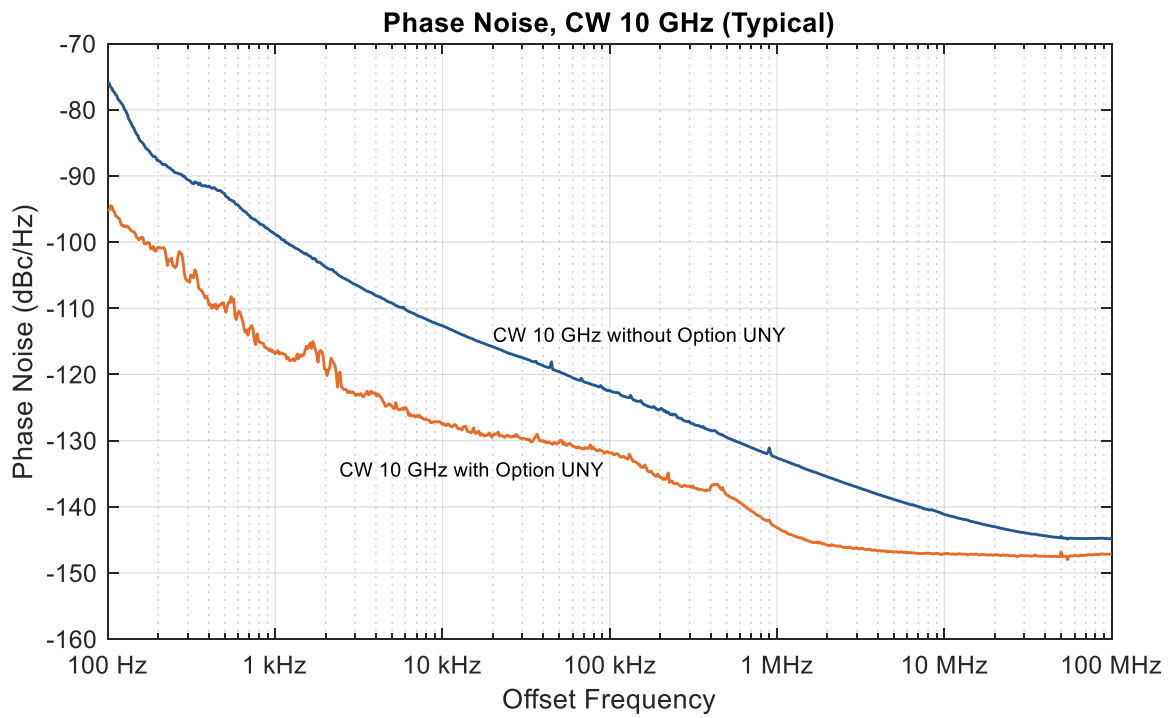

Test Port Input

Table 17a. Noise Floor¹ (dBm) @ 10 Hz IFBW, All Ports, All Options

Description	Specification		Typical	
	Test Port	Direct Receiver Access Input	Test Port	Direct Receiver Access Input
10 MHz to 50 MHz ^{2,3}	-70	-100	-76	-106
50 MHz to 100 MHz ^{2,3}	-92	-105	-98	-111
100 MHz to 500 MHz ²	-100	-113	-107	-120
500 MHz to 1 GHz	-110	-123	-116	-129
1 GHz to 10 GHz	-115	-127	-119	-131
10 GHz to 13.5 GHz	-116	-128	-121	-133
13.5 GHz to 16 GHz	-117	-129	-121	-133
16 GHz to 26.5 GHz	-118	-129	-122	-133
26.5 GHz to 35 GHz	-106	-117	-110	-121
35 GHz to 40 GHz	-105	-116	-110	-121
40 GHz to 50 GHz	-102	-112	-108	-118
50 GHz to 60 GHz	-101	-110	-107	-116
60 GHz to 67 GHz	-100	-108	-107	-115
67 GHz to 70 GHz	--	--	-95	-101

¹ Total average (rms) noise power calculated as the mean value of a linear magnitude trace expressed in dBm.

² May be degraded at particular frequencies below 500 MHz due to spurious receiver residuals.

³ With Option 425 installed and LFE disabled, applied to frequencies \leq 100 MHz. Above 100 MHz, performance is the same for both LFE enabled or disabled. For LFE enabled performance \leq 100 MHz, see Table 17b.

Table 17b. Noise Floor (dBm) @ 10 Hz IFBW, Option 425, (LFE Enabled)

Description	Specification	Typical
500 Hz to 900 Hz	--	-93
900 Hz to 1 kHz	-90	-96
1 kHz to 10 kHz	-91	-96
10 kHz to 100 kHz	-101	-105
100 kHz to 1 MHz	-107	-110
1 MHz to 5 MHz	-108	-112
5 MHz to 10 MHz	-102	-106
10 MHz to 50 MHz	-102	-106
50 MHz to 100 MHz	-102	-106

Table 18a. 0.1 dB Compression, All Options, All Ports - Typical

Description	Test Port Power (dBm)
10 MHz to 10 GHz ¹	15
10 GHz to 30 GHz	12
30 GHz to 67 GHz	11

¹ With Option 425 installed and LFE disabled, applied to frequencies \leq 100 MHz. Above 100 MHz, performance is the same for both LFE enabled or disabled. For LFE enabled performance \leq 100 MHz, see Table 18b.

Table 18b. 0.1 dB Compression, All Ports, Option 425, (LFE Enabled) - Typical

Description	Test Port Power (dBm)
500 Hz to 900 Hz	13
900 Hz to 1 kHz	13
1 kHz to 10 kHz	13
10 kHz to 100 kHz	13
100 kHz to 1 MHz	13
1 MHz to 5 MHz	11
5 MHz to 10 MHz	13
10 MHz to 50 MHz	14
50 MHz to 100 MHz	14

Table 18c. Compression, All Ports, Option 425, (LFE Enabled) - Specification

Description	Test Port Power (dBm)	Receiver Compression	
	All Options	Magnitude (dB)	Phase (degrees)
500 Hz to 900 Hz	--	--	--
900 Hz to 1 kHz	10	0.2	1
1 kHz to 10 kHz	12	0.2	1
10 kHz to 100 kHz	12	0.2	1
100 kHz to 1 MHz	12	0.2	1
1 MHz to 5 MHz	10	0.2	1
5 MHz to 10 MHz	9	0.2	1
10 MHz to 50 MHz	8	0.2	1
50 MHz to 100 MHz	8	0.2	1

Table 19. Compression, All Ports - Specification

Description	Test Port Power			Receiver compression	
	Options 201, 401	Options 219, 419	Options 224, 423, 425	Magnitude (dB)	Phase (degree)
500 MHz to 3.2 GHz ¹	13	13	13	0.15	1.2
3.2 GHz to 10 GHz	13	12	12	0.15	1.2
10 GHz to 13.5 GHz	11	9	8	0.15	1.2
13.5 GHz to 16 GHz	12	10	9	0.15	1.2
16 GHz to 19 GHz	10	8	8	0.15	1.2
19 GHz to 26.5 GHz	11	8	8	0.15	1.2
26.5 GHz to 30 GHz	10	8	8	0.15	1.2
30 GHz to 32 GHz	8	8	8	0.15	1.2
32 GHz to 35 GHz	9	8	8	0.15	1.2
35 GHz to 40 GHz	8	8	8	0.15	1.2
40 GHz to 67 GHz	10	8	8	0.15	1.2

¹ Test port receiver compression at input levels below 500 MHz is negligible due to coupler roll off.

Table 20a. Trace Noise¹ Magnitude (dB rms)

Description	Specification		Typical		
	1 kHz IFBW		1 kHz IFBW	100 kHz IFBW	600 kHz IFBW
10 MHz to 50 MHz ²	0.05		0.0249	0.240	0.580
50 MHz to 100 MHz ²	0.006		0.0017	0.016	0.040
100 MHz to 500 MHz	0.002		0.0007	0.007	0.016
500 MHz to 1 GHz	0.002		0.0004	0.003	0.007
1 GHz to 26.5 GHz	0.002		0.0005	0.003	0.006
26.5 GHz to 43.5 GHz	0.003		0.0008	0.008	0.017
43.5 GHz to 67 GHz	0.003		0.0009	0.008	0.017
67 GHz to 70 GHz	--		0.0015	0.023	0.028

¹ Ratioed measurement, nominal power at test port.

² With Option 425 installed and LFE disabled, applied to frequencies ≤ 100 MHz. Above 100 MHz, performance is the same for both LFE enabled or disabled. For LFE enabled performance ≤ 100 MHz, see Table 20b.

Table 20b. Trace Noise¹ Magnitude (dB rms), All Ports, Option 425, (LFE Enabled)

Description	Specification		Typical			
	100 Hz IFBW	1 kHz IFBW	100 Hz IFBW	1 kHz IFBW	100 kHz IFBW	600 kHz IFBW
500 Hz to 900 Hz	--	--	0.002	--	--	--
900 Hz to 4 kHz	0.004	--	0.001	--	--	--
4 kHz to 300 kHz	--	0.004	--	0.002	--	--
300 kHz to 2 MHz	--	0.004	--	0.001	0.01	--
2 MHz to 100 MHz	--	0.004	--	0.001	0.01	0.025

¹ Ratioed measurement, nominal power at test port.

Table 20c. Trace Noise¹ Phase (deg rms)

Description	Specification	Typical		
		1 kHz IFBW	100 kHz IFBW	600 kHz IFBW
10 MHz to 50 MHz ²	0.40	0.1441	1.400	4.000
50 MHz to 100 MHz ²	0.04	0.0095	0.092	0.220
100 MHz to 500 MHz	0.02	0.0046	0.044	0.110
500 MHz to 1 GHz	0.02	0.0018	0.017	0.041
1 GHz to 26.5 GHz	0.02	0.0075	0.016	0.039
26.5 GHz to 43.5 GHz	0.03	0.0120	0.044	0.130
43.5 GHz to 50 GHz	0.03	0.0193	0.055	0.130
50 GHz to 67 GHz	0.04	0.0193	0.055	0.130
67 GHz to 70 GHz	--	0.0200	0.086	0.200

¹ Ratioed measurement, nominal power at test port.

² With Option 425 installed and LFE disabled, applied to frequencies \leq 100 MHz. Above 100 MHz, performance is the same for both LFE enabled or disabled. For LFE enabled performance \leq 100 MHz, see Table 20d.

Table 20d. Trace Noise¹ Phase (deg rms), All Ports, Option 425, (LFE Enabled)

Description	Specification		Typical			
	100 Hz IFBW	1 kHz IFBW	100 Hz IFBW	1 kHz IFBW	100 kHz IFBW	600 kHz IFBW
500 Hz to 900 Hz	--	--	0.012	--	--	--
900 Hz to 4 kHz	0.03	--	0.008	--	--	--
4 kHz to 300 kHz	--	0.03	--	0.014	--	--
300 kHz to 2 MHz	--	0.03	--	0.007	0.064	--
2 MHz to 100 MHz	--	0.03	--	0.007	0.068	0.166

¹ Ratioed measurement, nominal power at test port.

Table 21. Reference Level - Specification

Description	Magnitude (dB)	Phase (degree)
Range	\pm 500	\pm 500
Resolution	0.001	0.01

Table 22a. Stability¹ - Typical

Description	Magnitude (dB/°C)	Phase (degree/°C)
10 MHz to 50 MHz ²	0.05	0.4
50 MHz to 16 GHz ²	0.01	0.2
16 GHz to 20 GHz	0.01	0.3
20 GHz to 50 GHz	0.02	0.7
50 GHz to 67 GHz	0.03	1.0
67 GHz to 70 GHz	0.05	1.1

¹ Stability is defined as a ratio measurement made at the test port.

² With Option 425 installed and LFE disabled, applied to frequencies \leq 100 MHz. Above 100 MHz, performance is the same for both LFE enabled or disabled. For LFE enabled performance \leq 100 MHz, see Table 22b.

Table 22b. Stability¹, Option 425, (LFE Enabled) - Typical

Description	Magnitude (dB/°C)	Phase (°/°C)
500 Hz to 900 Hz	0.010	0.2
900 Hz to 1 kHz	0.010	0.2
1 kHz to 10 kHz	0.010	0.2
10 kHz to 100 kHz	0.010	0.2
100 kHz to 1 MHz	0.010	0.1
1 MHz to 5 MHz	0.010	0.1
5 MHz to 10 MHz	0.010	0.1
10 MHz to 50 MHz	0.010	0.1
50 MHz to 100 MHz	0.020	0.1

¹ Stability is defined as a ratio measurement made at the test port.

Table 23. Damage Input Level - Specification

Description	RF (dBm)	DC (V)
Test Ports (All Options except those noted below)	> +24	>40
Source 2 Out 1, Source 2 Out 2 (Option 224)	> +24	>0
Test Port 1, Noise Mode ¹ (Option 029)	> +10	>40
Test Port 2, Noise Mode ¹ (Option 029 without Option 425)	> +27	>40
Test Ports (Option 425)	> +20	>50

¹ Noise mode sets port 2 noise receiver switch to noise receiver position.

Noise Receiver Input (Option 029 only)

Table 24. Noise Receiver Bandwidth

Description	Allowable Bandwidths
10 MHz to 25 MHz	800 kHz, 2 MHz
25 MHz to 60 MHz	800 kHz, 2/4 MHz
60 MHz to 150 MHz	800 kHz, 2/4/8 MHz ¹
150 MHz to 50 GHz	800 kHz, 2/4/8/24 MHz ¹

¹ 8 and 24 MHz bandwidths are available only with calibration using noise source.

Table 25a. Receiver Noise Figure (dB), Port 2, @ 4 MHz BW, High Gain Setting

Description	Specification	Typical
10 MHz to 50 MHz	--	9
50 MHz to 1.5 GHz	10	7
1.5 GHz MHz to 5 GHz	12	10
5 GHz to 20 GHz	15	11
20 GHz to 45 GHz	16	11
45 GHz to 50 GHz	18	14

Table 25b. Receiver Noise Figure (dB), Port 2, @ 4 MHz BW, High Gain Setting, Option 425 with 029

Description	Specification	Typical
10 MHz to 50 MHz	--	9
50 MHz to 1.5 GHz	15.5	12.5
1.5 GHz MHz to 5 GHz	14	12
5 GHz to 20 GHz	16	12
20 GHz to 45 GHz	16	11
45 GHz to 50 GHz	18	14

Table 26. Noise Figure Trace Noise¹ (dB rms) @ 4 MHz BW, All Gain Settings

Frequency	Specification	Typical
10 MHz to 50 MHz	--	0.07
50 MHz to 50 GHz	0.11	0.07

¹ Trace noise magnitude performance on noise figure trace or sometime called noise jitter, 201 points, 1 noise average, with terminated input. May typically be degraded at frequencies below 500 MHz due to spurious noise receiver residuals.

Table 27. Noise Receiver Linearity (dB) @ 4 MHz BW - Specification

Power Range (dBm)			Specification
Low Gain Setting Reference to -60 dBm	Medium Gain Setting Reference to -70 dBm	High Gain Setting Reference to -80 dBm	
-36 to -64	-48 to -76	-58 to -85	±0.05
-64 to -70	-76 to -87	-85 to -92	±0.07

Table 28a. Noise Receiver Input Range - Specification

Description	Max DUT NF + Gain (dB) ¹			Max Input Power (dBm) for <0.1 dB Compression ²		
	High Gain Setting	Medium Gain Setting	Low Gain Setting	High Gain Setting	Medium Gain Setting	Low Gain Setting
500 MHz to 4.5 GHz	37	53	68	≤-51	≤-35	≤-20
4.5 GHz to 6 GHz	38	53	71	≤-50	≤-35	≤-17
6 GHz to 24 GHz	47	57	66	≤-41	≤-31	≤-22
24 GHz to 26.5 GHz	45	58	66	≤-43	≤-30	≤-22
26.5 GHz to 36 GHz	45	56	57	≤-43	≤-32	≤-31
36 GHz to 50 GHz	39	51	58	≤-49	≤-37	≤-30

¹ Limited by 0.1 dB receiver compression. Applies to devices with bandwidth <400 MHz. For devices with higher bandwidths, calculate the DUT output noise power as $-174 \text{ dBm} + 10 \cdot \log_{10}(B) + \text{Gain (dB)} + \text{NF (dB)}$, where B is the bandwidth of the DUT in Hz, and use the Max Input Power specification.

² Derived from ensuring < 0.25 dB compression with a CW signal 5 dB higher than the stated max input power value for 0.1 dB compression. Referenced to test port 2.

Table 28b. Noise Receiver Input Range, Option 425 with 029 – Specification

Description	Max DUT NF + Gain (dB) ¹			Max Input Power (dBm) for <0.1 dB Compression ²		
	High Gain Setting	Medium Gain Setting	Low Gain Setting	High Gain Setting	Medium Gain Setting	Low Gain Setting
500 MHz to 4.5 GHz	37	53	68	≤-51	≤-35	≤-20
4.5 GHz to 6 GHz	38	53	71	≤-50	≤-35	≤-17
6 GHz to 24 GHz	47	57	66	≤-41	≤-31	≤-22
24 GHz to 26.5 GHz	45	58	66	≤-43	≤-30	≤-22
26.5 GHz to 36 GHz	45	56	57	≤-43	≤-32	≤-31
36 GHz to 50 GHz	39	51	58	≤-50	≤-38	≤-30

¹ Limited by 0.1 dB receiver compression. Applies to devices with bandwidth <400 MHz. For devices with higher bandwidths, calculate the DUT output noise power as $-174 \text{ dBm} + 10 \cdot \log_{10}(B) + \text{Gain (dB)} + \text{NF (dB)}$, where B is the bandwidth of the DUT in Hz, and use the Max Input Power specification.

² Derived from ensuring < 0.25 dB compression with a CW signal 5 dB higher than the stated max input power value for 0.1 dB compression. Referenced to test port 2.

Dynamic Accuracy

Table 29. Dynamic Accuracy - Specification

Standard receiver accuracy of the test port input power reading relative to the reference input power level. It is verified with the following measurements:

- Compression over frequency
- IF linearity at a single frequency of 1.998765 GHz using a reference level of -20 dBm for an input power range of 0 to -60 dBm. For value below -60 dBm, refer to [VNA Receiver Dynamic Accuracy Specifications and Uncertainties](#).

Dynamic Accuracy, 900 Hz (LFE Enabled) - Specification

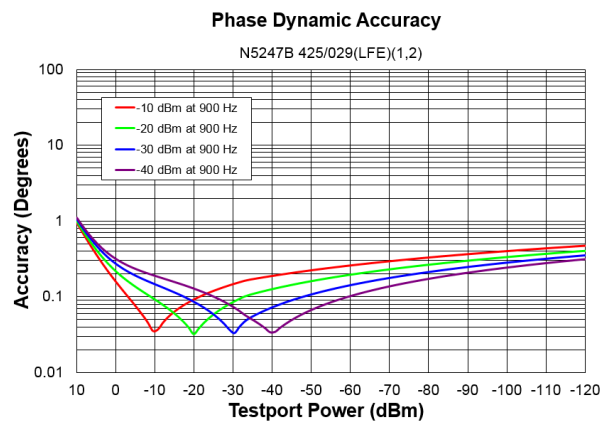
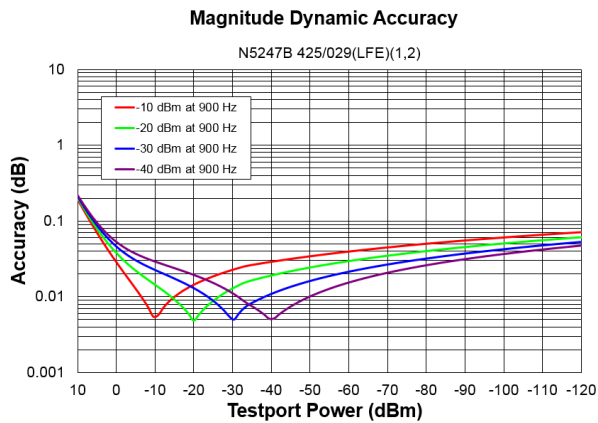

Dynamic Accuracy, 10 MHz (LFE Enabled) - Specification

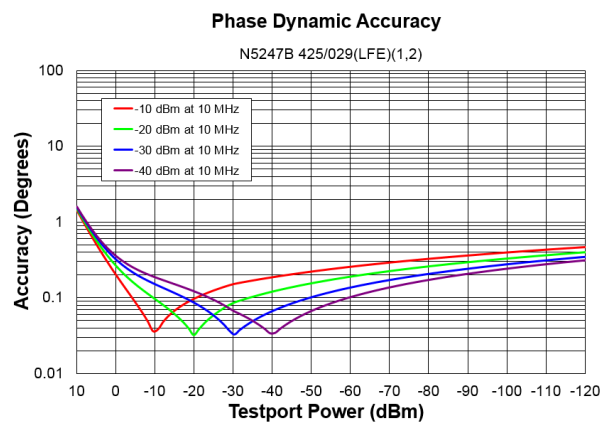
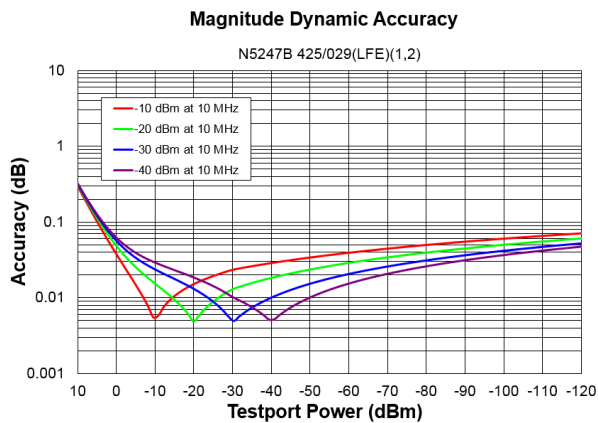

Dynamic Accuracy, 100 MHz (LFE Enabled) - Specification

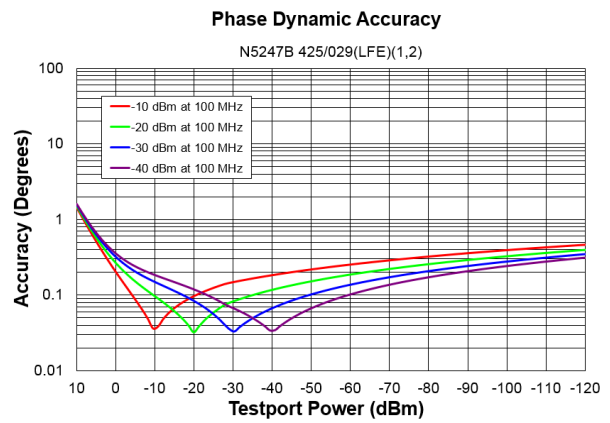
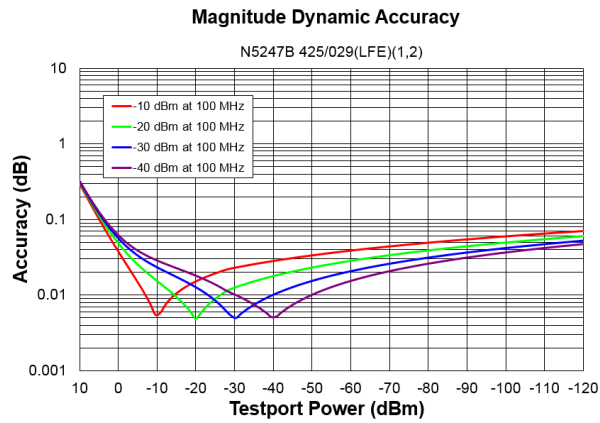

Dynamic Accuracy, 10 MHz

NOTE The plots are valid for all options.

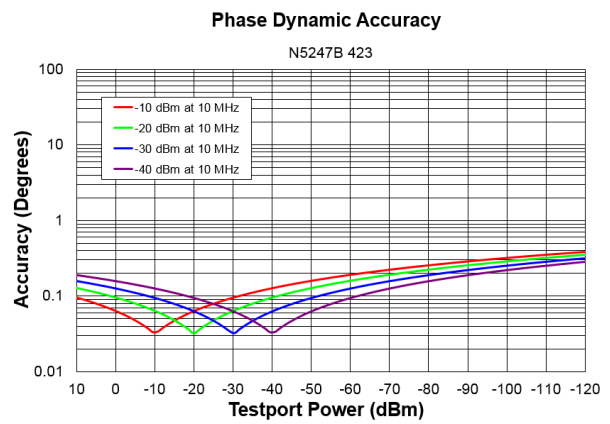
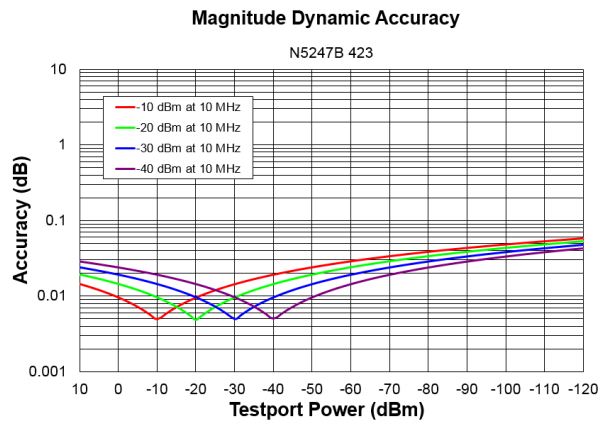

Dynamic Accuracy, 50 MHz

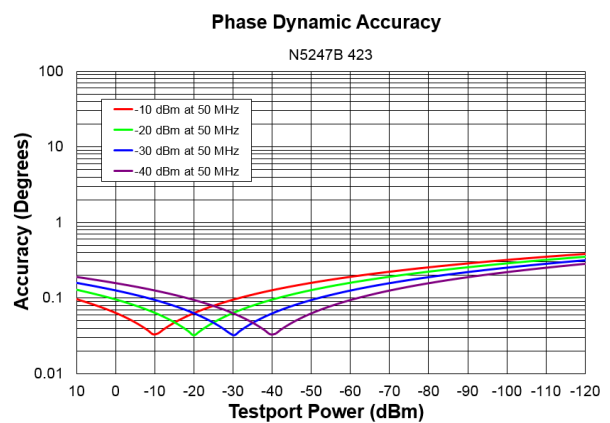
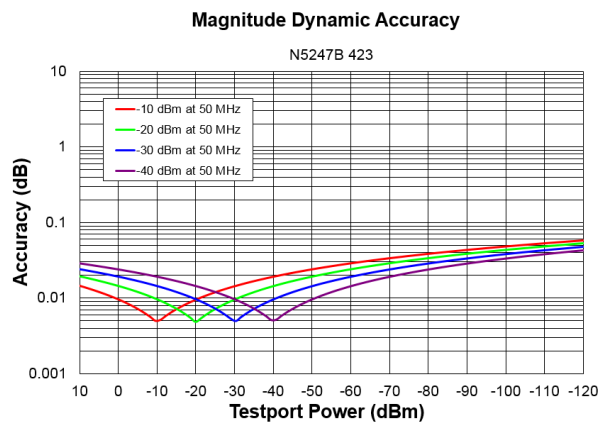

Dynamic Accuracy, 500 MHz

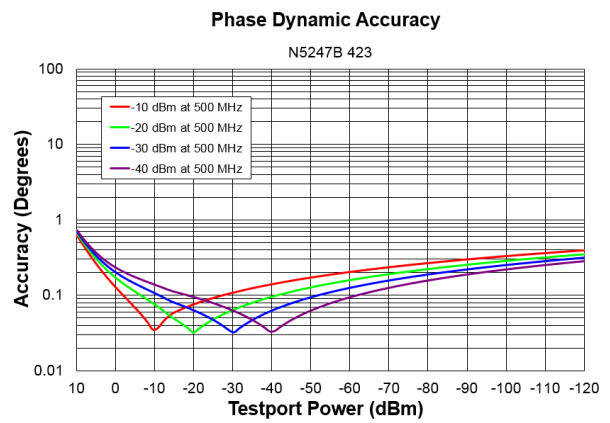
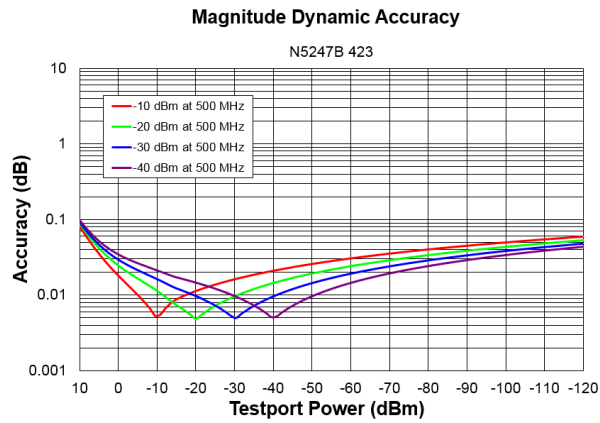

Dynamic Accuracy, 1 GHz

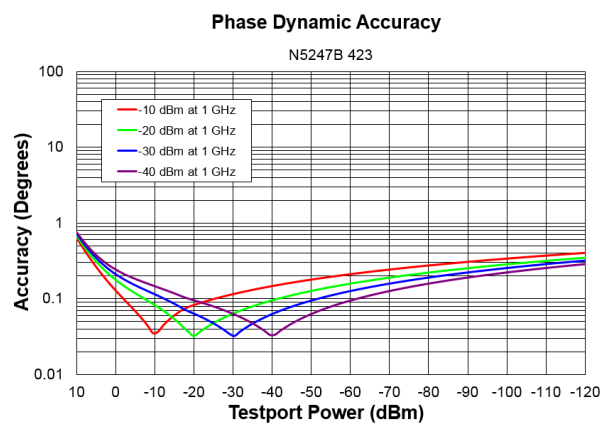
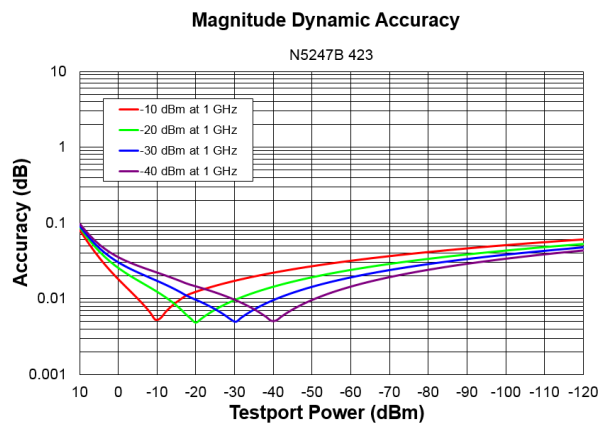

Dynamic Accuracy, 2 GHz

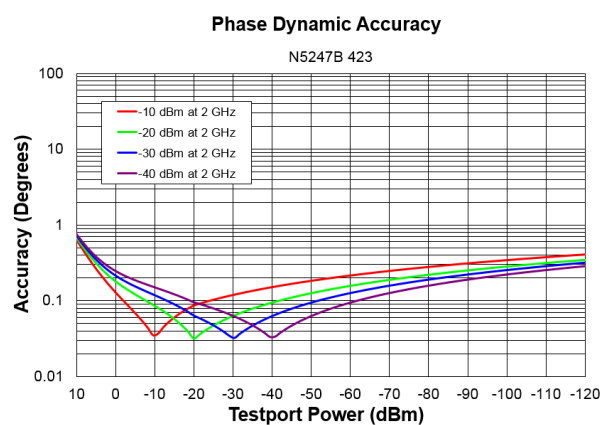
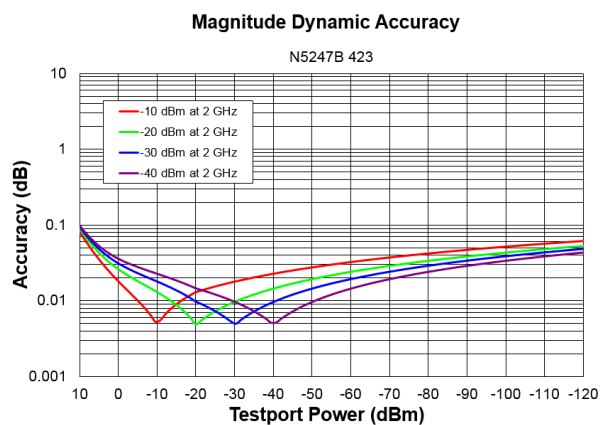

Dynamic Accuracy, 20 GHz

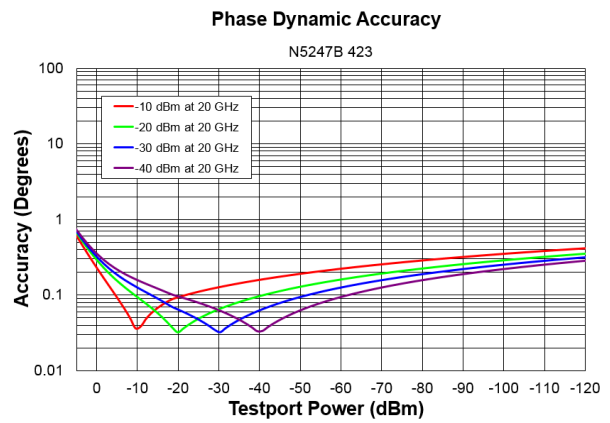
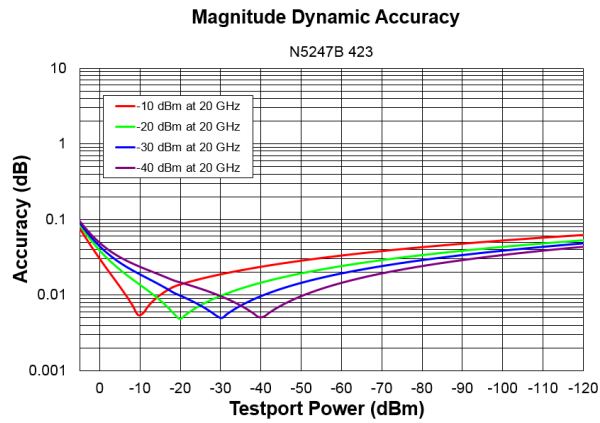

Dynamic Accuracy, 26.5 GHz

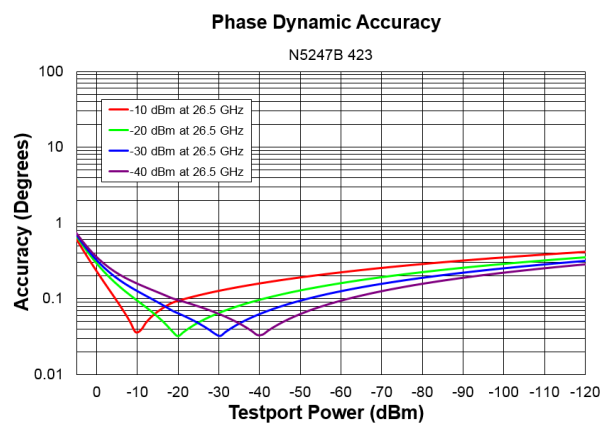
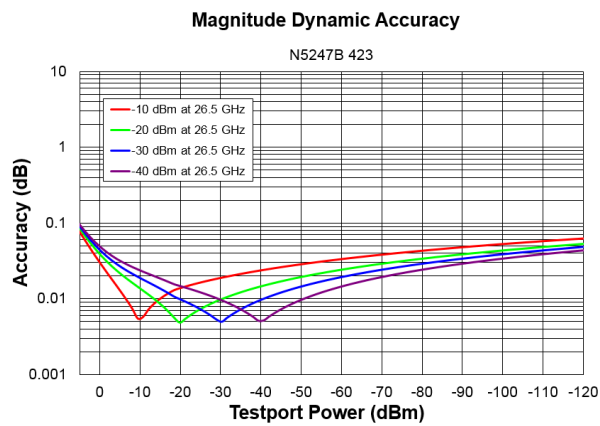

Dynamic Accuracy, 35 GHz

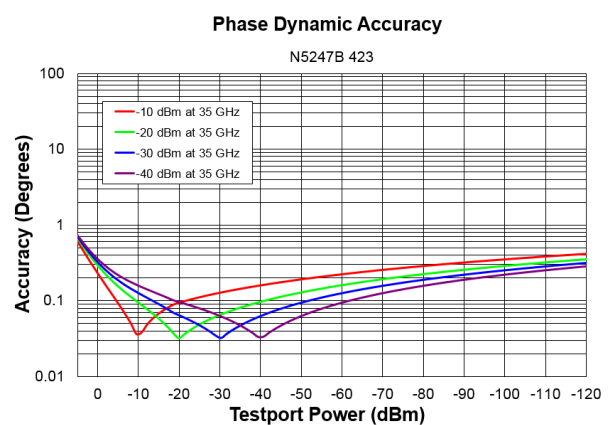
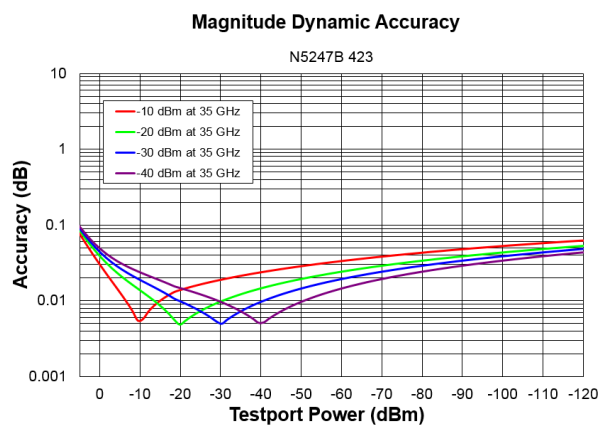

Dynamic Accuracy, 40 GHz

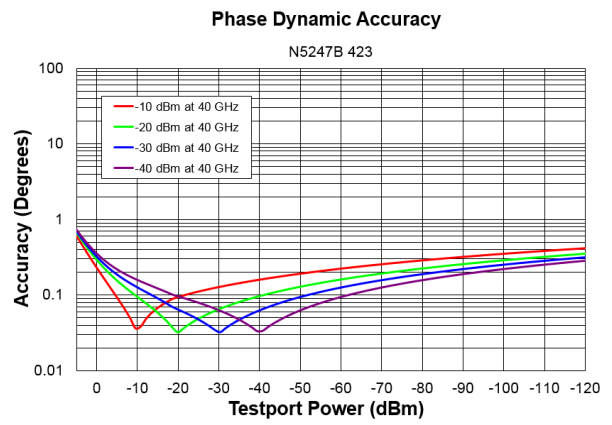
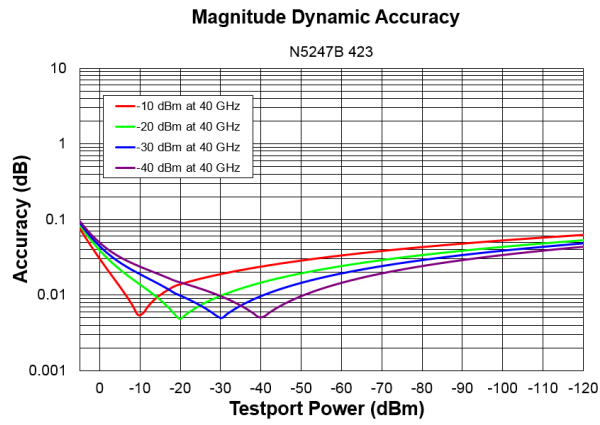

Dynamic Accuracy, 50 GHz

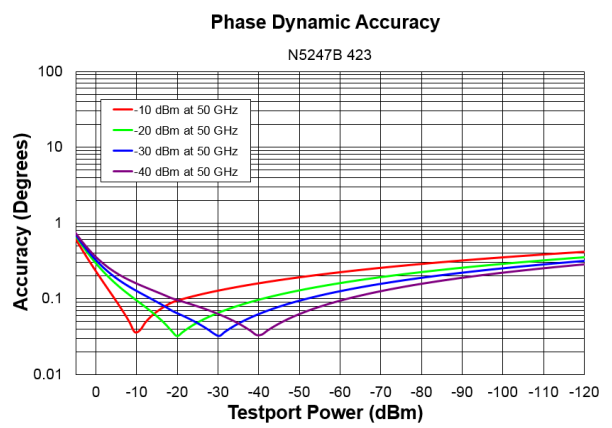
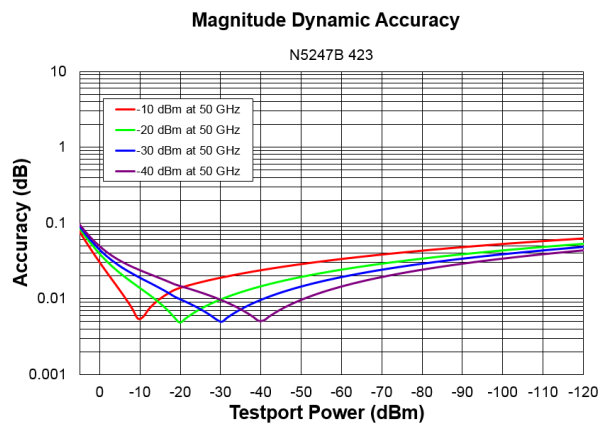

Dynamic Accuracy, 60 GHz

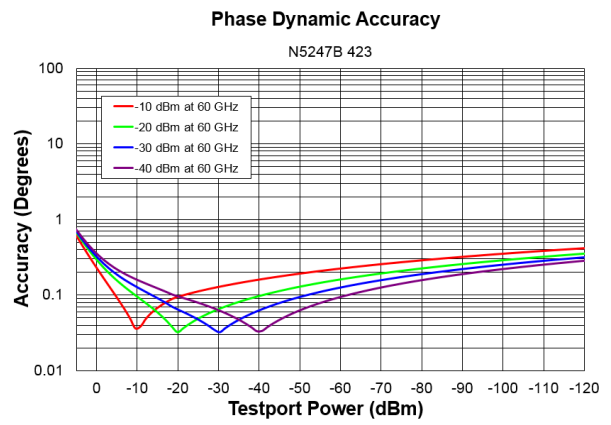
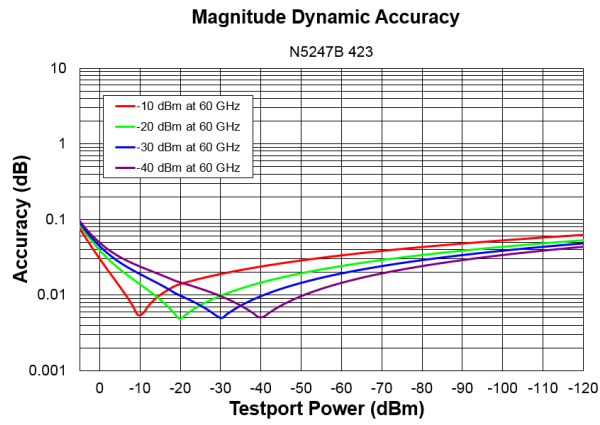

Dynamic Accuracy, 67 GHz

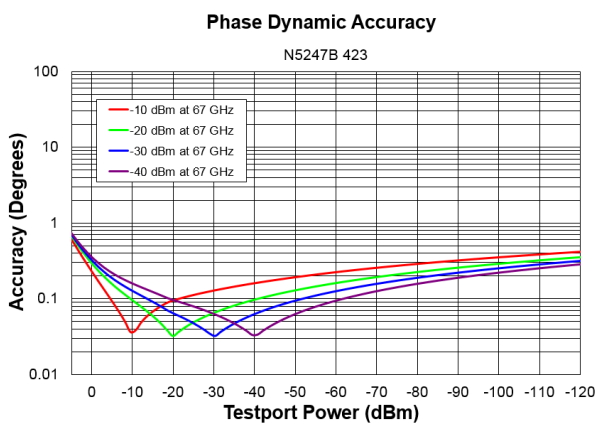
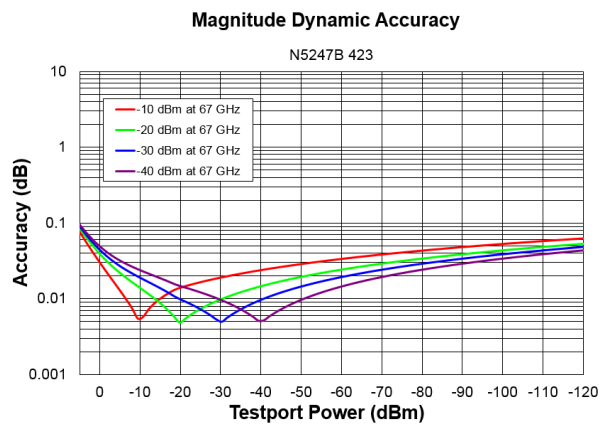

Table 30. Test Port Input (Group Delay)¹

Description	Typical Performance
Aperture (selectable)	(frequency span)/(number of points -1)
Maximum Aperture	20% of frequency span
Range	0.5 x (1/minimum aperture)
Maximum Delay	Limited to measuring no more than 180° of phase change within the minimum aperture.)
Accuracy	See graph below

The following graph shows characteristic group delay accuracy with full 2-port calibration and a 10 Hz IF bandwidth. Insertion loss is assumed to be < 2 dB and electrical length to be ten meters.

For any S_{ij} Group Delay measurement, $S_{ii} = 0$, $S_{ij} = 1$, $S_{ji} = 0$, $S_{kl} = 0$ for all $kl \neq ij$

Group Delay Accuracy (Typical)

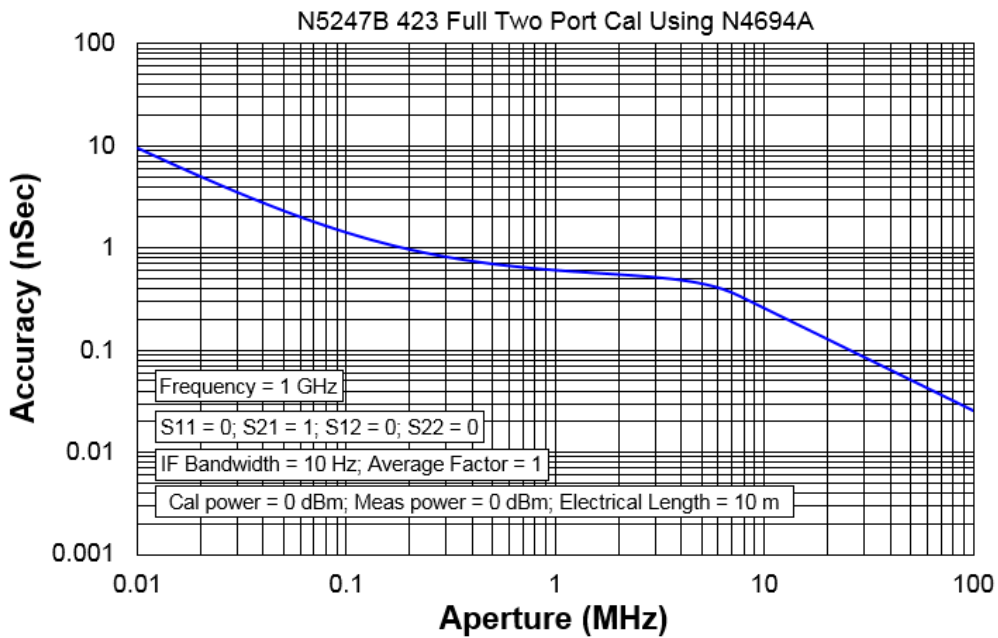

In general, the following formula can be used to determine the accuracy, in seconds, of specific group delay measurement:
 $\pm \text{Phase Accuracy (deg)} / [360 \times \text{Aperture (Hz)}]$
 Depending on the aperture and device length, the phase accuracy used is either incremental phase accuracy or worst-case phase accuracy.

¹ Group delay is computed by measuring the phase change within a specified frequency step (determined by the frequency span and the number of points per sweep).

General Information

- Miscellaneous Information
- Front Panel
- Rear Panel
- Environment and Dimensions

Table 31. Miscellaneous Information

Description	Supplemental Information
System IF Bandwidth Range	1 Hz to 15 MHz (7 MHz, 10 MHz, and 15 MHz IFBWs are available ONLY with FW A.09.42 and later, and with DSP version 5)
CPU	For the latest information on CPUs and associated hard drives, visit: http://na.support.keysight.com/pna/hdnumbers.html
LXI	Class C

Table 32. Front Panel Information, All Options

Description	Typical Performance
RF Connectors	
Test Ports	1.85 mm (male), 50 ohm (nominal), 0.002 in. Center Pin Recession (characteristic)
Jumpers	1.85 mm (female) connectors with 1.85 mm (male) jumper cables
USB 2.0 Ports - Master (4 ports)	
Standard	Compatible with USB 2.0
Connector	USB Type-A female
Display	
Size	31 cm (12.1 in) diagonal color active matrix LCD; 1280 (horizontal) X 800 (vertical) resolution
Refresh Rate	Vertical 60 Hz; Horizontal 49.31 kHz
Pixels	<p>Any of the following would cause a display to be considered faulty:</p> <ul style="list-style-type: none"> • A complete row or column consists of “stuck” or “dark” pixels. • More than six “stuck on” pixels (but not more than three green) or more than 0.002% of the total pixels are within the LCD specifications. • More than twelve “dark” pixels (but no more than seven of the same color) or more than 0.004% of the total pixels are within the LCD specifications. • Two or more consecutive "stuck on" pixels or three or more consecutive "dark" pixel (but no more than one set of two consecutive dark pixels). • “Stuck on” pixels or more than two “dark” pixels less than 6.5 mm apart (excluding consecutive pixels).

Table 32. (Continued) Front Panel Information, All Options

Description	Typical Performance
Display Range	
Magnitude	±2500 dB (at 500 dB/div), max
Phase	±2500° (at 500 degrees/div), max
Polar	10 pUnits, min 10,000 Units, max
Display Resolution	
Magnitude	0.001 dB/div, min
Phase	0.01°/div, min
Marker Resolution	
Magnitude	0.001 dB, min
Phase	0.01°, min
Polar	10 pUnit, min

Table 33. Rear Panel Information, All Options

Description	Typical Performance
10 MHz Reference In	
Connector	BNC, female
Input Frequency	10 MHz ±1 ppm, 100 MHz ±1 ppm
Input Level	-15 dBm to +20 dBm
Input Impedance	200 Ω, nom.
10 MHz Reference Out	
Connector	BNC, female
Output Frequency	10 MHz ±1 ppm, 100 MHz ±1 ppm
Signal Type	Sine Wave
Output Level	+10 dBm ±4 dB into 50 Ω
Output Impedance	50 Ω, nominal
Harmonics	<-40 dBc, typical
SRC3 (Option XSB)	
Connector	SMA, female
Output Frequency	10 MHz to 13.5 GHz
Maximum Output Power	See Table 8q

Table 33. (Continued) Rear Panel Information

Description	Typical Performance			
External IF Inputs				
Function	Allows use of external IF signals from remote mixers, bypassing the PNA's first converters			
Connectors	SMA (female); A, B, C, D, R (4-port); A, B, R1, R2 (2-port)			
Frequency				
Path	DSP Version	IF Bandwidth	RF Frequency	IF Frequency
Normal IF path:	5	≤ 600 kHz	< 53 MHz	2.479339 MHz
			≥ 53 MHz	7.438017 MHz
		1 MHz	All	7.692 MHz
		1.5 MHz	All	7.368 MHz
		2 MHz	All	8.450 MHz
		3 MHz	All	8.163 MHz
		5 MHz	All	6.897 MHz
		7 MHz	All	10.53 MHz
		10 MHz	All	15.38 MHz
		15 MHz	All	22.22 MHz
Narrowband IF path:	4 or 5	All	All	10.70 MHz
Input Impedance	50 Ω			
RF Damage Level	+23 dBm			
DC Damage Level	5.5 VDC			
0.1 dB Compression Point				
Normal IF path	-9.0 dBm at 7.438 MHz			
Narrowband IF path	-17 dBm at 10.70 MHz			
Pulse Inputs (IF Gates)				
Function	Internal receiver gates used for point-in-pulse and pulse-profile measurements			
Connectors	15-pin mini D-sub			
Input Impedance	1 K Ohm			
Minimum Pulse Width, Source Modulators	20 ns			
Minimum Pulse Width, Receiver Gates	20 ns			
DC Damage Level	5.5 VDC			
Drive Voltage	0 V (off), +3.3 V (on), nominal			

Table 33. (Continued) Rear Panel Information

Description	Typical Performance	
RF Pulse Modulator Input (Source Modulator)		
On/Off Ratio		
10 MHz to 3.2 GHz	-64 dB	
3.2 GHz to 67 GHz	-80 dB	
Pulse Period		
Minimum	20 ns	
Maximum	70 s	
Pulse Outputs		
Voltage (TTL)	High: 3.3V to 3.5V Low: <1V	
Impedance	50 Ohm	
External Test Set Driver		
Function	Used for driving remote mixers	
Connections	3.5 mm (female)	
RF Output Frequency Range	3.2 GHz to 19 GHz	
LO Output Frequency Range	0.01 GHz to 70 GHz	
Rear Panel LO Power¹	Upper Limit, Typical (dBm)	Lower Limit, Typical (dBm)
1.7 GHz to 6.759 GHz	5	-3
6.759 GHz to 15.5 GHz	0	-6
15.5 GHz to 26.5 GHz	4	-5
Rear Panel RF Power	Maximum Output Power, Typical (dBm)	
3.2 GHz to 5 GHz	+3	
5 GHz to 19 GHz	+8	

¹ LO output available in full analyzer's frequency range. The power is tested only from 3.2 GHz to 26.5 GHz.

Table 33. (Continued) Rear Panel Information

Description	Typical Performance
Devices Supported	Resolutions
Flat Panel (TFT)	1024 X 768, 800 X 600, 640 X 480
Flat Panel (DSTN)	800 X 600, 640 X 480
CRT Monitor	1280 X 1024, 1024 X 768, 800 X 600, 640 X 480
Simultaneous operation of the internal and external displays is allowed, but with 640 X 480 resolution only. If you change resolution, you can only view the external display (internal display will "white out").	
Bias Tee Inputs	
Connectors	BNC(f) for ports 1, 2, 3 and 4
Fuse	500 mA, bi-pin style
Maximum Bias Current	±200 mA with no degradation of RF specifications
Maximum Bias Voltage	±40 VDC
Trigger Inputs/Outputs	BNC(f), TTL/CMOS compatible
Test Set IO	25-pin D-Sub connector, available for external test set control
Power IO	9-pin D-Sub, female; analog and digital IO
Handler IO	36-pin parallel I/O port; all input/output signals are default set to negative logic; can be reset to positive logic via GPIB command
Pulse I/O	15-pin D connector provides access to Pulse Modulators and Generators
GPIB	Two ports - dedicated controller and dedicated talker/listener. 24-pin D-sub (Type D-24), female; compatible with IEEE-488
PCIe	Cabled PCIe x4 connector is a 4-lane slot (not currently used)
USB Ports	Two SuperSpeed USB ports (900 mA each), one USB port below LAN connector, and one USB device port. There are also four USB ports (500 mA each) on the front panel. The total current limit for all rear panel USB ports is 2.3 amps. The total current limit for all front panel USB ports is 2 amps.
LAN	10/100/1000 BaseT Ethernet, 8-pin configuration; auto selects between the data rates
Line Power	
Frequency, Voltage	50/60/400 Hz for 100 to 120 VAC 50/60 Hz for 220 to 240 VAC
	Power supply is auto switching
Max	450 watts

Table 34. Analyzer Dimensions and Weight

The N5247B is shipped with bottom feet, handles, and front and rear hardware.

See detailed PNA dimension drawings at: <http://na.support.keysight.com/pna/PNADimensions.pdf>

Cabinet Dimensions	Metric (mm)	Imperial (inches)
Height		
Without bottom feet: EIA RU ¹ = 6	266.1	10.5
With bottom feet	280.0	11.0
Width		
Without handles or rack-mount flanges	425.9	16.8
With handles, without rack-mount flanges	458.7	18.1
With handles and rack-mount flanges	482.9	19.0
Depth		
Without front and rear panel hardware	582.3	22.9
With front and rear panel hardware, handles	649.6	25.6
Weight (nominal)	Net	Shipping
2-port models (Option 224 with 029)	46.3 kg (102 lb)	62.1 kg (137 lb)
4-port models (Option 423 with 029)	49.0 kg (108 lb)	65.3 kg (144 lb)

¹ Electronics Industry Association rack units. 1 RU = 1.75 in.

Operating Environment

For Regulatory and Environmental information, refer to the PNA Series Installation and Quick Start Guide, located online at <http://literature.cdn.keysight.com/litweb/pdf/E8356-90001.pdf>.

Measurement Throughput Summary

- Typical Cycle Time for Measurement Completion
- Cycle Time vs. IF Bandwidth
- Cycle Time vs. Number of Points
- Data Transfer Time

Cycle time Includes sweep time, retrace time and band-crossing time. Analyzer display turned off with DISPLAY:ENABLE OFF. Add 21 ms for display on. Data for one trace (S_{11}) measurement. LF Auto BW off.

Table 35a. Cycle Time (ms) for Measurement Completion, All Options - Typical

Sweep Range	IF Bandwidth		Number of Points				
			201	401	1601	16001	32001
50 kHz to 100 MHz	10kHz	Uncorrected	75	141	515	4726	4169
		2-Port cal	155	285	1050	9505	18440
	1kHz	Uncorrected	306	599	2339	23000	31741
		2-Port cal	611	1200	4715	46185	91960
	100Hz	Uncorrected	2543	5085	20293	202691	28477
		2-Port cal	5120	10200	40640	405200	809800
9 GHz to 10 GHz	600 kHz	Uncorrected	3.2	3.5	7.4	56.4	110
		2-Port cal	6.9	7.4	15.1	112	220
	10 kHz	Uncorrected	41.4	51.7	201	1992	3982
		2-Port cal	84	104	456	4405	8822
	1 kHz	Uncorrected	230	451	1764	17219	34220
		2-Port cal	468	909	3536	34459	68474
10 GHz to 20 GHz	600 kHz	Uncorrected	19.8	20.98	28.5	77.7	122
		2-Port cal	39.7	42.4	57.1	149	240
	10 kHz	Uncorrected	65.7	123	313	1999	3989
		2-Port cal	131.3	276	582	4431	8844
	1 kHz	Uncorrected	238	464	1803	17564	34908
		2-Port cal	484	935	3613	35156	69849

Table 35b. Typical Cycle Time (ms) for Full-Span Measurement Completion - Typical

10 MHz to 67 GHz		Number of Points				
IF Bandwidth		201	401	1601	16001	32001
600 kHz	Uncorrected	50.5	75.4	101	203	262
	2-Port cal	100	150	206	401	520
10 kHz	Uncorrected	83	146	504	2313	4293
	2-Port cal	165	366	1143	5197	8767
1 kHz	Uncorrected	260	491	1856	17908	35559
	2-Port cal	879	1351	4259	38991	77239

Table 36. Cycle Time vs. IF Bandwidth - Typical

Applies to the **Preset condition** (201 points, correction off) except for the following changes:

- CF = 10 GHz
- Span = 100 MHz
- Display off (add 21 ms for display on)

Cycle time includes sweep and retrace time.

Description	Typical Performance	
	IF Bandwidth (Hz)	Cycle Time (ms)
600,000	2.27	0.035
100,000	3.58	0.013
30,000	7.01	0.009
10,000	26.75	0.005
3,000	69.1	0.0032
1,000	219	0.003
300	637	0.002
100	1821	0.0015
30	5978	0.0013
10	17831	0.0013
3	59272	0.0014

Table 37. Cycle Time (ms) vs. Number of Points - Typical

Applies to the Preset condition (correction off) except for the following changes:

- CF = 10 GHz
- Span = 100 MHz
- Display off (add 21 ms for display on)

Cycle time includes sweep and retrace time.

Description	IF Bandwidth (Hz)			
	1,000	10,000	30,000	600,000
3	4.98	2.34	2.11	1.8
11	13.89	5.7	3.52	1.72
51	57.48	7.97	3.36	1.8
101	111.56	14.18	4.28	1.95
201	218.75	26.76	7.03	2.81
401	432.03	51.62	12.01	3.12
801	854.88	101.41	22.15	4.53
1,601	1695.39	200.62	42.11	7.19
6,401	6682.81	797.27	162.5	23.44
16,001	16561.2	1990.89	399.74	52.08
32,001	32882.81	3976.56	805.99	109.38

Table 38. Data Transfer Time¹ (ms) - Typical

Description	Number of Points				
	201	401	1601	16,001	32,001
SCPI over GPIB (Program executed on external PC²)					
32-bit floating point	5.6	10.5	39.9	400	800
64-bit floating point	10.5	20.3	79.2	788	1576
ASCII	46	92.5	370	3702	5404
SCPI over SICL/LAN or TCP/IP Socket³ (Program executed in the analyzer)					
32-bit floating point	0.18	0.21	0.5	3.6	7.2
64-bit floating point	0.22	0.28	0.62	5.3	10.6
ASCII	6.3	12.3	47.3	47.0	940
COM³ (Program executed in the analyzer)					
32-bit floating point	<0.2	<0.2	<0.2	0.46	0.9
Variant type	0.6	1	3.5	35	75
DCOM over LAN³ (Program executed on external PC)					
32-bit floating point	0.35	0.35	0.54	2.65	5.3
Variant type	1.1	1.8	6.5	64	128

¹ Measured with the analyzer display off. Values will increase slightly if the analyzer display is on.

² Measured when using the SCPI command DISPlay: VISible OFF.

³ Values are for real and imaginary pairs, with the analyzer display off, using Gigabit Ethernet.

NOTE

Specifications for Recall & Sweep Speed are not provided for the N5247B analyzers.

Table 39. Typical Cycle Time for Amplifier Noise Figure Measurement (Option 029 and S93029A)

Conditions:

Frequency range: 4 – 6 GHz

IF bandwidth: 1 kHz

Noise settings: 4 MHz noise bandwidth, 10 averages, low-noise receiver

Impedance states for vector noise cal: 5

Other: NA application display on; correction on

Description	Number of Points			
	51	101	201	401
Scalar noise cal cycle time (ms, typical)	1154	2276	4512	8980
Vector noise cal cycle time (ms, typical)	5280	10,432	20,744	41,356

Table 40. Typical Cycle Time for Amplifier Gain Compression Measurement (Option S93086A)

Conditions:

Frequency range: 4 – 6 GHz
 IF bandwidth: 1 kHz
 Sweep type: Smart
 Compression type: 1 dB compression from linear gain (0.05 dB tolerance)
 Other: NA application display on; correction on

Description	Number of Points			
	51	101	201	401
Cycle time (ms, typical)	175	267	430	756

Table 41. Typical Cycle Time for Amplifier Swept Intermodulation Distortion Measurement (Option S93087A)

Conditions:

Frequency range: 4 – 6 GHz
 Main tone IF bandwidth: 10 kHz
 IM tone IF bandwidth: 1 kHz
 Measurement parameters: PwrMain (avg), IM3 (dB relative to carrier)
 Other: NA application display on; correction on

Description	Number of Points			
	51	101	201	401
Cycle time (ms, typical)	248	463	891	1752

Table 42. Typical Cycle Time for Converter Noise Figure Measurement (Option 029 and S93029A)

Conditions:

Input frequency: 3 GHz CF, 75 MHz span
 LO frequency: 2.12 GHz fixed
 Output frequency: 880 MHz CF, 75 MHz span
 IF bandwidth: 1 kHz
 Noise settings: 4 MHz noise bandwidth, 10 averages, low-noise receiver
 Impedance states for vector noise cal: 5
 Other: NA application display on; correction on

Description	Number of Points			
	51	101	201	401
Scalar noise cal cycle time (ms, typical)	1330	2617	5181	10,230
Vector noise cal cycle time (ms, typical)	5540	10,958	21,626	42,977

Table 43. Typical Cycle Time for Converter Measurement with SMC + Phase (Option S93083A)

Conditions:

Input frequency: 3 GHz CF, 75 MHz span
 LO frequency: 2.12 GHz fixed
 Output frequency: 880 MHz CF, 75 MHz span
 Other: NA application display on; correction on (includes match correction but not SC12 sweep)

Description	Number of Points			
	51	101	201	401
Cycle time, 10 kHz IF bandwidth (ms, typical)	87	123	193	330
Cycle time, 1 kHz IF bandwidth (ms, typical)	215	375	690	1320

Table 44. Typical Cycle Time for Converter Gain Compression Measurement (Option S93086A)

Conditions:

Input frequency: 3 GHz CF, 75 MHz span
 LO frequency: 2.12 GHz fixed
 Output frequency: 880 MHz CF, 75 MHz span
 IF bandwidth: 1 kHz
 Sweep type: Smart
 Compression type: 1 dB compression from linear gain (0.05 dB tolerance)
 Other: NA application display on; correction on

Description	Number of Points			
	51	101	201	401
Cycle time (ms, typical)	235	342	554	980

Table 45. Typical Cycle Time for Converter Swept Intermodulation Distortion Measurement (Option S93087A)

Conditions:

Input frequency: 3 GHz CF, 75 MHz span
 LO frequency: 2.12 GHz fixed
 Output frequency: 880 MHz CF, 75 MHz span
 Main tone IF bandwidth: 10 kHz
 IM tone IF bandwidth: 1 kHz
 Measurement parameters: PwrMain (avg), IM3 (dB relative to carrier)
 Other: NA application display on; correction on

Description	Number of Points			
	51	101	201	401
Cycle time (ms, typical)	474	905	1767	3517

Specifications: Front-Panel Jumpers

NOTE

All PNA-X options have the following front-panel jumpers for each port.

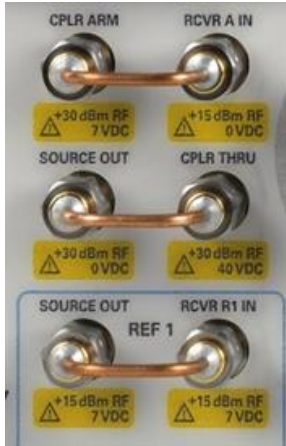

- Measurement Receiver Inputs
- Reference Receiver Inputs and Reference Source Outputs
- Source Outputs
- Coupler Inputs
- Damage Levels

Table 46. Measurement Receiver Inputs (dBm) - Typical

(RCVR A, B, C, D IN) @ 0.1dB Typical Compression

Description	All Options
10 MHz to 3.2 GHz	-4
3.2 GHz to 26.5 GHz	-5
26.5 GHz to 50 GHz	-4
50 GHz to 64 GHz	-3
64 GHz to 67 GHz	-4
67 GHz to 70 GHz	-2

Table 47a. Reference Receiver Inputs and Reference Source Outputs (dBm) - Typical

(RCVR R1 IN, REF 1 SOURCE OUT) @ Max Specified Output Power

Description	Options 201, 401		Options 219, 419		Options 224, 423	
	Filtered Mode ¹	Hi Power Mode ¹	Filtered Mode ¹	Hi Power Mode ¹	Filtered Mode ¹	Hi Power Mode ¹
10 MHz to 50 MHz	-33	-25	-32	-27	-32	-25
50 MHz to 500 MHz	-21	-16	-19	-14	-19	-14
500 MHz to 1 GHz	-14	-9	-14	-9	-15	-9
1 GHz to 2 GHz	-11	-6	-11	-5	-12	-6
2 GHz to 3.2 GHz	-10	-10	-11	-11	-11	-11
3.2 GHz to 10 GHz	-8	-8	-9	-9	-9	-9
10 GHz to 16 GHz	-10	-10	-11	-11	-12	-12
16 GHz to 26.5 GHz	-12	-12	-13	-13	-14	-14
26.5 GHz to 30 GHz	-13	-13	-14	-14	-15	-15
30 GHz to 32 GHz	-16	-16	-16	-16	-17	-17
32 GHz to 35 GHz	-14	-14	-15	-15	-16	-16
35 GHz to 40 GHz	-17	-17	-19	-19	-20	-20
40 GHz to 60 GHz	-12	-12	-14	-14	-15	-15
60 GHz to 64 GHz	-12	-12	-15	-15	-17	-17
64 GHz to 67 GHz	-12	-12	-14	-14	-16	-16
67 GHz to 70 GHz	-21	-21	-22	-22	--	--

¹ In Filtered Mode, the signal path goes through filters to minimize harmonics below 3.2 GHz. In Hi Power Mode, the signal bypasses the filters to maximize output power.

Table 47b. Reference Receiver Inputs and Reference Source Outputs (dBm) – Typical

(RCVR R2, R3, R4 IN, REF 2, 3, 4 SOURCE OUT) @ Max Specified Output Power

Description	Option 401		Options 201, 401	Option 419		Options 219, 419
	RCVR R3 IN, REF 3 SOURCE OUT	RCVR R3 IN, REF 3 SOURCE OUT	RCVR R2, R4 IN, REF 2, 3 SOURCE OUT	RCVR R3 IN, REF 3 SOURCE OUT	RCVR R3 IN, REF 3 SOURCE OUT	RCVR R2, R4 IN, REF 2, 3 SOURCE OUT
	Filtered Mode ¹	Hi Power Mode ¹		Filtered Mode ¹	Hi Power Mode ¹	
10 MHz to 50 MHz	-31	-23	-27	-31	-26	-25
50 MHz to 500 MHz	-19	-14	-14	-18	-13	-14
500 MHz to 1 GHz	-9	-4	-4	-9	-4	-4
1 GHz to 2 GHz	-6	-1	-1	-6	-1	-1
2 GHz to 3.2 GHz	-5	-5	-1	-6	-6	-1
3.2 GHz to 10 GHz	-2	-2	-2	-3	-3	-2
10 GHz to 16 GHz	-4	-4	-4	-5	-5	-5
16 GHz to 26.5 GHz	-5	-5	-5	-6	-6	-6
26.5 GHz to 30 GHz	-5	-5	-5	-7	-7	-7
30 GHz to 32 GHz	-9	-9	-9	-9	-9	-9
32 GHz to 35 GHz	-6	-6	-6	-7	-7	-8
35 GHz to 40 GHz	-10	-10	-10	-11	-11	-12
40 GHz to 50 GHz	-4	-4	-4	-5	-5	-6
50 GHz to 60 GHz	-3	-3	-3	-5	-5	-6
60 GHz to 64 GHz	-2	-2	-2	-4	-4	-6
64 GHz to 67 GHz	-1	-1	-1	-3	-3	-5
67 GHz to 70 GHz	-2	-2	-2	-6	-6	-8

¹ In Filtered Mode, the signal path goes through filters to minimize harmonics below 3.2 GHz. In Hi Power Mode, the signal bypasses the filters to maximize output power.

Table 47c. Reference Receiver Inputs and Reference Source Outputs (dBm) - Typical

(RCVR R2, R3, R4 IN, REF 2, 3, 4 SOURCE OUT) @ Max Specified Output Power

Description	Option 423		Options 224, 423
	RCVR R3 IN, REF 3 SOURCE OUT	RCVR R3 IN, REF 3 SOURCE OUT	RCVR R2, R4 IN, REF 2, 4 SOURCE OUT
	Filtered Mode ¹	Hi Power Mode ¹	
10 MHz to 50 MHz	-31	-25	-29
50 MHz to 500 MHz	-18	-13	-16
500 MHz to 1 GHz	-11	-5	-4
1 GHz to 2 GHz	-7	-1	-1
2 GHz to 3.2 GHz	-6	-6	-1
3.2 GHz to 10 GHz	-3	-3	-2
10 GHz to 16 GHz	-5	-5	-6
16 GHz to 26.5 GHz	-7	-7	-7
26.5 GHz to 30 GHz	-7	-7	-8
30 GHz to 32 GHz	-9	-9	-10
32 GHz to 35 GHz	-8	-8	-9
35 GHz to 40 GHz	-12	-12	-13
40 GHz to 60 GHz	-6	-6	-7
60 GHz to 64 GHz	-7	-7	-9
64 GHz to 67 GHz	-5	-5	-7

¹ In Filtered Mode, the signal path goes through filters to minimize harmonics below 3.2 GHz. In Hi Power Mode, the signal bypasses the filters to maximize output power.

Table 48a. Source Outputs (dBm) - Typical

(PORT 1, 2, 3, 4 SOURCE OUT) @ Max Specified Output Power

Description	Options 201, 401			Options 219, 419		
	PORT 1, 3 SOURCE OUT		PORT 2, 4 SOURCE OUT	PORT 1, 3 SOURCE OUT		PORT 2, 4 SOURCE OUT
	Filtered Mode ¹	Hi Power Mode ¹		Filtered Mode ¹	Hi Power Mode ¹	
10 MHz to 50 MHz	4	12	12	4	12	12
50 MHz to 1 GHz	8	13	13	8	13	13
1 GHz to 2 GHz	8	13	13	9	14	14
2 GHz to 3.2 GHz	10	10	13	10	10	14
3.2 GHz to 10 GHz	13	13	13	12	12	13
10 GHz to 16 GHz	12	12	12	11	11	11
16 GHz to 26.5 GHz	12	12	12	10	10	10
26.5 GHz to 30 GHz	11	11	11	10	10	10
30 GHz to 32 GHz	8	8	8	7	7	7
32 GHz to 35 GHz	10	10	10	8	8	8
35 GHz to 40 GHz	6	6	6	3	3	3
40 GHz to 50 GHz	11	11	11	9	9	9
50 GHz to 70 GHz	12	12	12	8	8	8

¹ In Filtered Mode, the signal path goes through filters to minimize harmonics below 3.2 GHz. In Hi Power Mode, the signal bypasses the filters to maximize output power.

Table 48b. Source Outputs (dBm) - Typical

(PORT 1, 2, 3, 4 SOURCE OUT) @ Max Specified Output Power

Description	Options 224, 423, 029		
	PORT 1, 3 SOURCE OUT		PORT 2, 4 SOURCE OUT
	Filtered Mode ¹	Hi Power Mode ¹	
10 MHz to 50 MHz	4	11	11
50 MHz to 1 GHz	7	13	13
1 GHz to 2 GHz	8	14	14
2 GHz to 3.2 GHz	10	10	14
3.2 GHz to 10 GHz	12	12	13
10 GHz to 16 GHz	10	10	10
16 GHz to 30 GHz	9	9	9
30 GHz to 32 GHz	6	6	6
32 GHz to 35 GHz	7	7	7
35 GHz to 40 GHz	2	2	2
40 GHz to 50 GHz	8	8	8
50 GHz to 60 GHz	7	7	7
60 GHz to 67 GHz	6	6	6

¹ In Filtered Mode, the signal path goes through filters to minimize harmonics below 3.2 GHz. In Hi Power Mode, the signal bypasses the filters to maximize output power.

Table 49. Coupler Inputs (dB) - Typical

(PORT 1, 2, 3, 4 CPLR THRU) Insertion Loss of Coupler Thru

Description	Options 201, 401	Options 219, 419, 224, 423	Option 029 ¹
	All Ports	All Ports	Ports 1, 2
10 MHz to 50 MHz	-0.2	-0.7	-1.7
50 MHz to 500 MHz	-0.2	-0.3	-1.3
500 MHz-to 1 GHz	-0.3	-0.5	-1.5
1 GHz to 2 GHz	-0.4	-0.7	-1.7
2 GHz to 3.2 GHz	-0.4	-0.8	-1.8
3.2 GHz to 10 GHz	-0.6	-1.3	-2.3
10 GHz to 16 GHz	-0.8	-1.8	-2.8
16 GHz to 26.5 GHz	-1.0	-2.7	-3.7
26.5 GHz to 30 GHz	-1.0	-2.6	-4.1
30 GHz to 35 GHz	-1.2	-2.2	-3.7
35 GHz to 40 GHz	-1.3	-2.4	-3.9
40 GHz to 50 GHz	-1.5	-2.8	-4.3
50 GHz to 60 GHz	-1.7	-3.2	-4.7
60 GHz to 64 GHz	-1.9	-3.7	-4.2
64 GHz to 67 GHz	-2.0	-4.0	-5
67 GHz to 70 GHz	-2.2	-4.5	-5.5

¹ Option 029 affects only port 1 and 2 coupler thru insertion loss. Refer to Options 219, 419, 224, 423 for the coupler thru insertion loss on port 3 or port 4. Port 1 impedance tuner switch is in bypass position and port 2 noise receiver switch is in normal position.

Table 50. Damage Level

Description	RF (dBm)	DC (V)
RCVR A, B, C, D IN	15	7
RCVR R1, R2, R3, R4 IN	15	7
REF 1 SOURCE OUT	15	7
REF 2, 3, 4 SOURCE OUT	30	7
PORT 1, 2, 3, 4 SOURCE OUT	27	5
PORT 1 CPLR THRU	27 (10 ¹)	40
PORT 2, 3, 4 CPLR THRU	27	40
PORT 1, 2, 3, 4 CPLR ARM	30	7

¹ When the source impedance tuner is switched in the path of Option 224 or 423 with Option S93029A configuration, +10 dBm input to port 1 CPLR THRU damages the tuner.

Test Set Block Diagrams

NOTE For best readability, use a color printer for printing the following graphics.

Legend

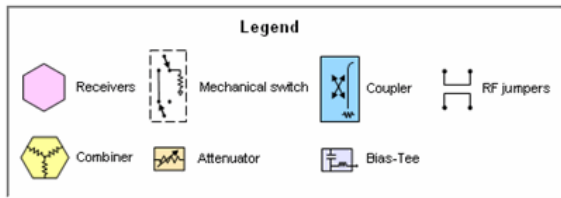

Figure 1. 2-Port N5247B Base Unit Option 201

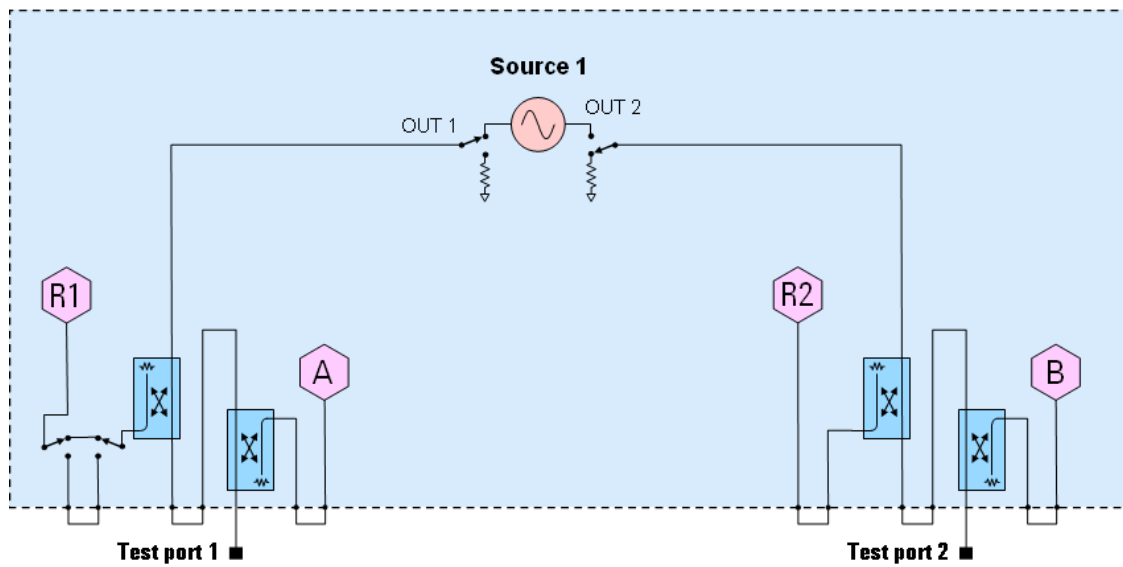

Figure 2. 2-Port N5247B Option 219

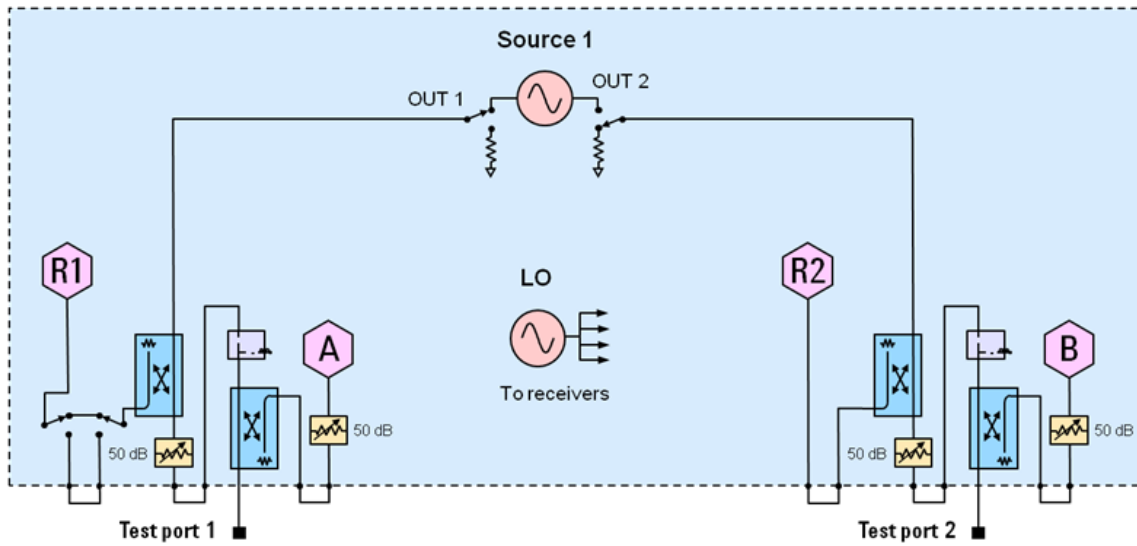

Figure 3. 2-Port N5247B Option 224

Also shown, Option 025 adds 4 pulse generators. Option 021 and 022 adds pulse modulators.

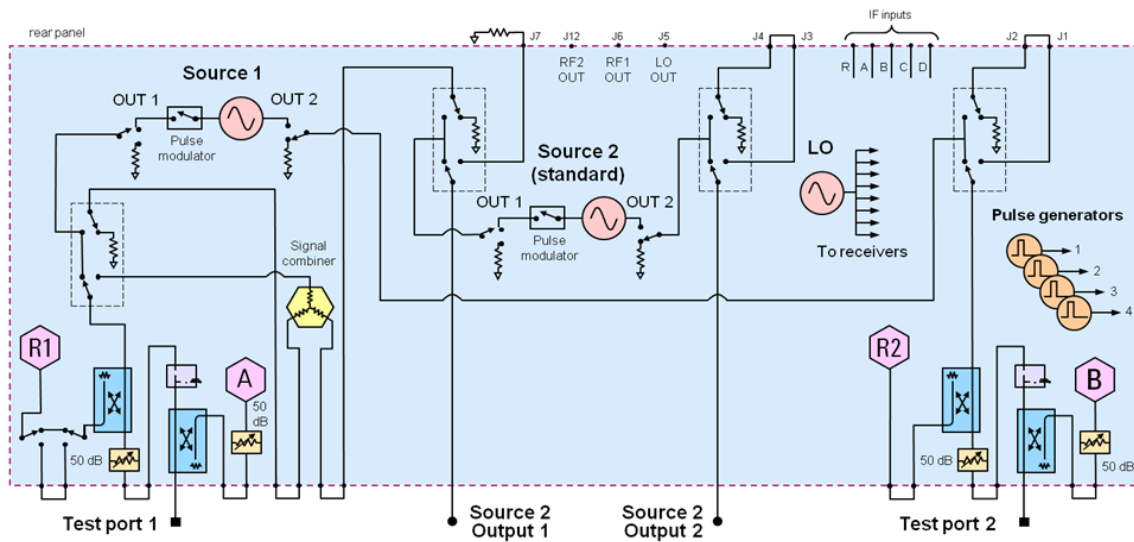

Figure 4. 2-Port N5247B Option 224 with 029

Also shown, Option 025 adds 4 pulse generators. Option 021 and 022 adds pulse modulators.

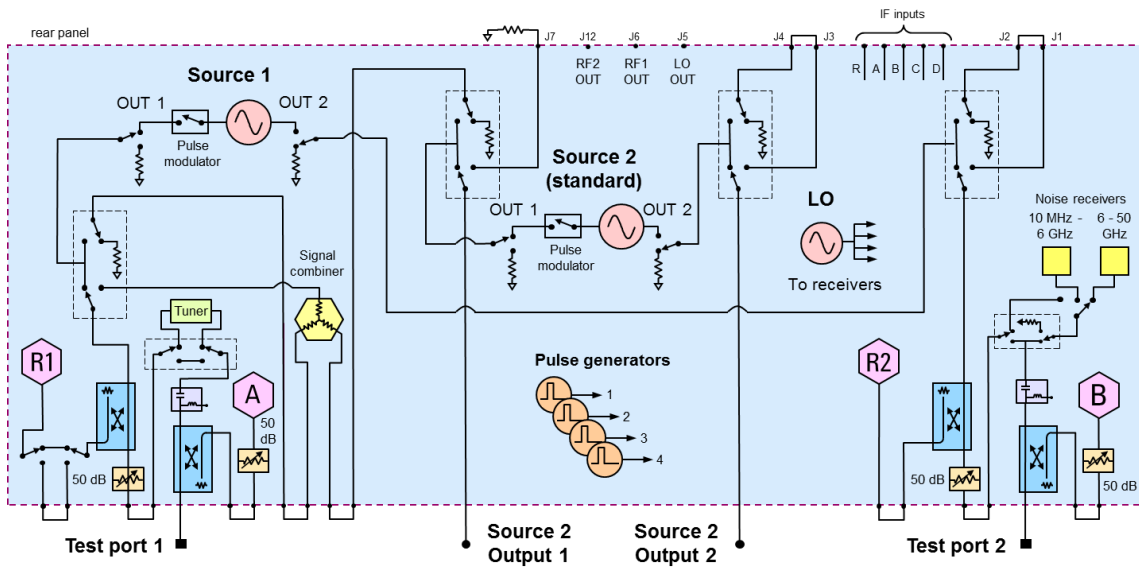

Figure 5. 4-Port N5247B Base Unit Option 401

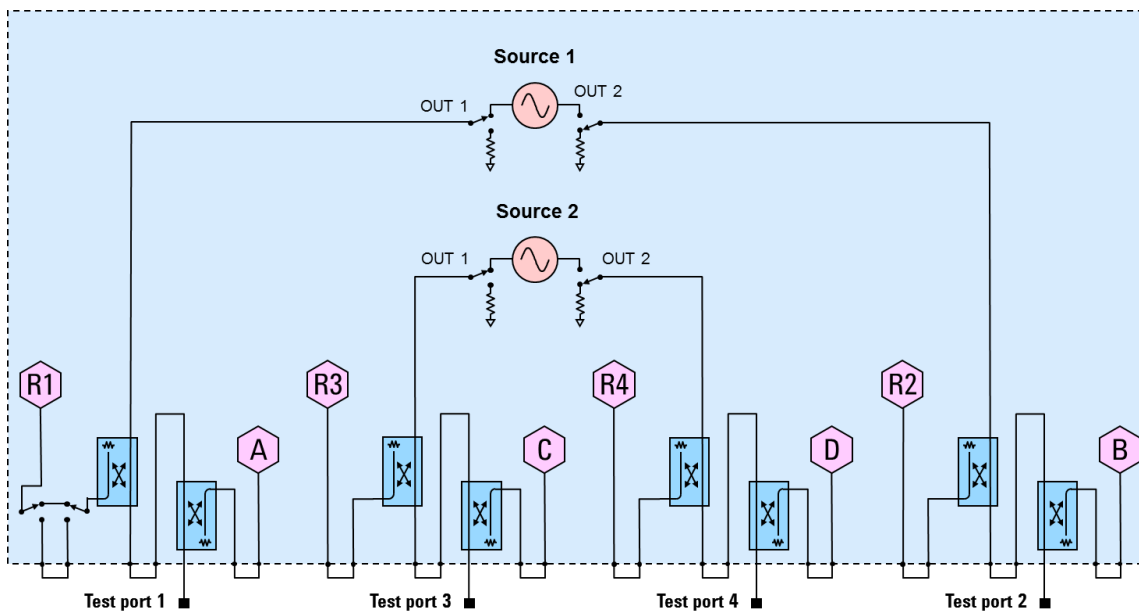

Figure 6. 4-Port N5247B Option 419

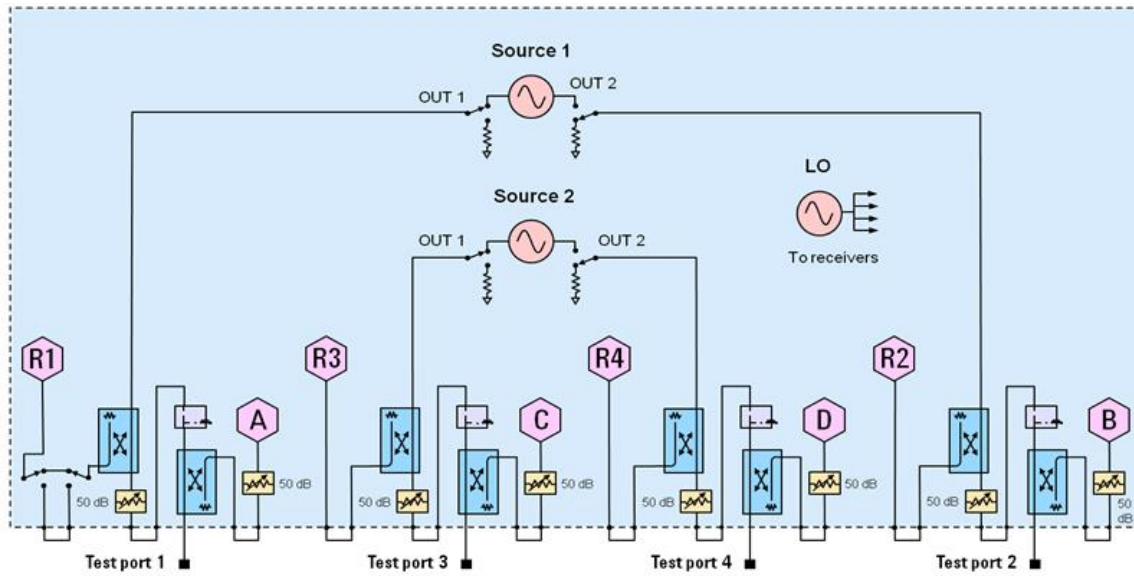

Figure 7. 4-Port N5247B Option 423

Also shown, Option 025 adds 4 pulse generators. Option 021 and 022 adds pulse modulators.

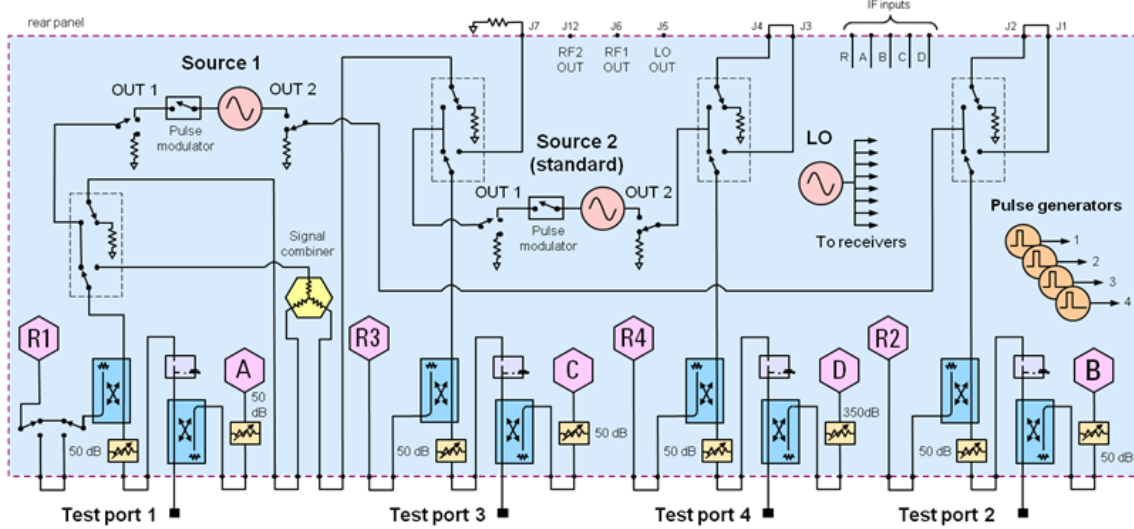
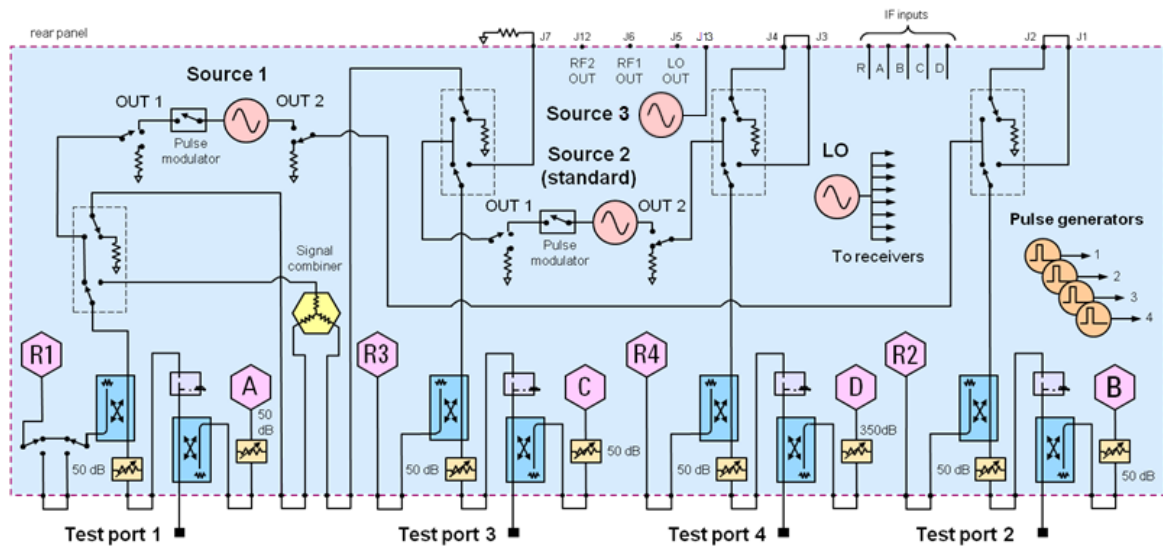

Figure 8. 4-Port N5247B Option 423 with XSB



NOTE Option XSB is available with Option 422 also. Option 422 does not have the bias tees.

Figure 9. 4-Port N5247B Option 423 with 029

Also shown, Option 025 adds 4 pulse generators. Option 021 and 022 adds pulse modulators.

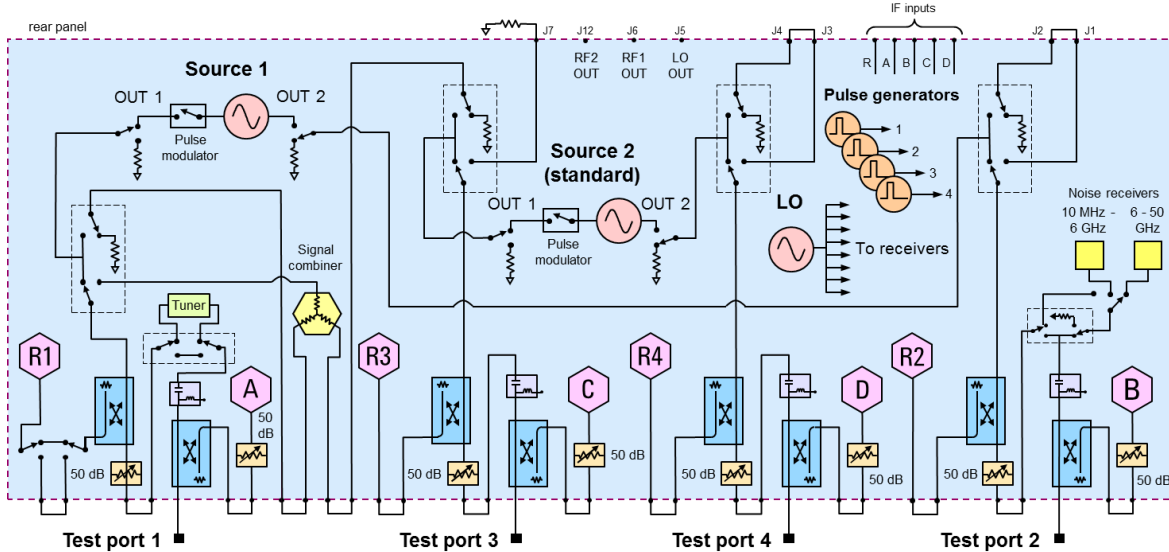

Figure 10. Option 425 Low Frequency Extension

The following LFE block diagram shows how the low-frequency hardware is configured for a single test port. The other ports are configured similarly.

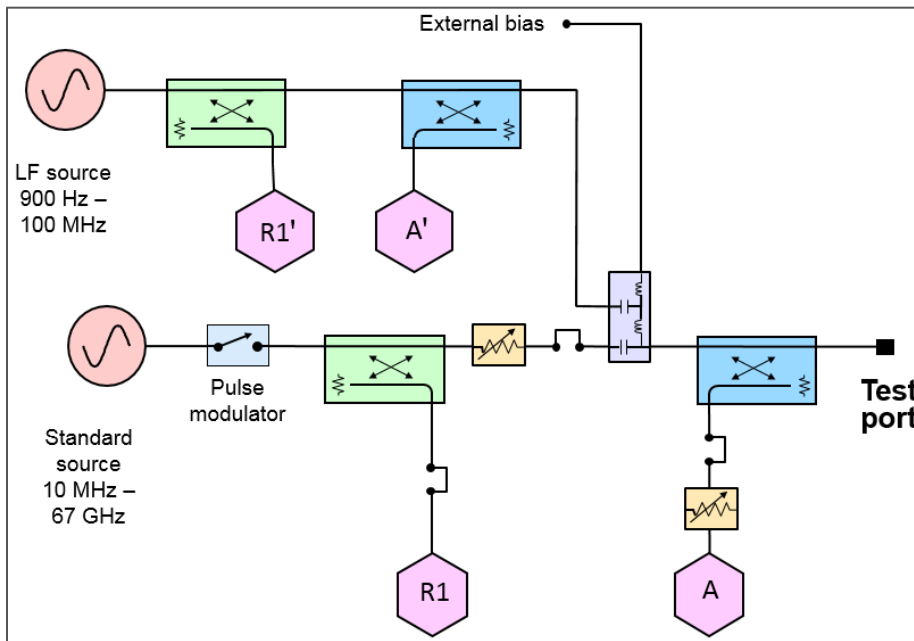
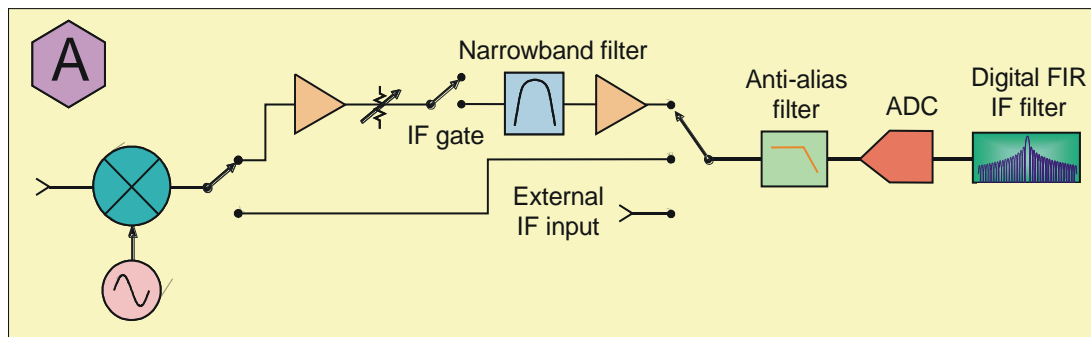

Figure 11. Receiver Block Diagram





This information is subject to change without notice.

© Keysight Technologies 2017 - 2020

Print Date: June 24, 2020



N5247-90029

www.keysight.com