

# Keysight Technologies

## N5280A

Notice: This document contains references to Agilent. Please note that Agilent's Test and Measurement business has become Keysight Technologies. For more information, go to [www.keysight.com](http://www.keysight.com).

User's and  
Service Guide

# Notices

© Keysight Technologies, Inc.  
2008-2017

No part of this manual may be reproduced in any form or by any means (including electronic storage and retrieval or translation into a foreign language) without prior agreement and written consent from Keysight Technologies, Inc. as governed by United States and international copyright laws.

## Trademark Acknowledgments

## Manual Part Number

N5280-90001

## Edition

June 2017

Supersedes: August 2015

Printed in USA

Published by:

Keysight Technologies

1400 Fountaingrove Parkway Santa Rosa, CA 95403

## Warranty

THE MATERIAL CONTAINED IN THIS DOCUMENT IS PROVIDED "AS IS," AND IS SUBJECT TO BEING CHANGED, WITHOUT NOTICE, IN FUTURE EDITIONS. FURTHER, TO THE MAXIMUM EXTENT PERMITTED BY APPLICABLE LAW, KEYSIGHT DISCLAIMS ALL WARRANTIES, EITHER EXPRESS OR IMPLIED WITH REGARD TO THIS MANUAL AND ANY INFORMATION CONTAINED HEREIN, INCLUDING BUT NOT LIMITED TO THE IMPLIED WARRANTIES OF MERCHANTABILITY AND FITNESS FOR A PARTICULAR PURPOSE. KEYSIGHT SHALL NOT BE LIABLE FOR ERRORS OR FOR INCIDENTAL OR CONSEQUENTIAL DAMAGES IN CONNECTION WITH THE FURNISHING, USE, OR PERFORMANCE OF THIS DOCUMENT OR ANY INFORMATION CONTAINED HEREIN. SHOULD KEYSIGHT AND THE USER HAVE A SEPARATE WRITTEN AGREEMENT WITH WARRANTY TERMS COVERING THE MATERIAL IN THIS

DOCUMENT THAT CONFLICT WITH THESE TERMS, THE WARRANTY TERMS IN THE SEPARATE AGREEMENT WILL CONTROL.

## Technology Licenses

The hardware and/or software described in this document are furnished under a license and may be used or copied only in accordance with the terms of such license.

## U.S. Government Rights

The Software is "commercial computer software," as defined by Federal Acquisition Regulation ("FAR") 2.101. Pursuant to FAR 12.212 and 27.405-3 and Department of Defense FAR Supplement ("DFARS") 227.7202, the U.S. government acquires commercial computer software under the same terms by which the software is customarily provided to the public.

Accordingly, Keysight provides the Software to U.S. government customers under its standard commercial license, which is embodied in its End User License Agreement (EULA), a copy of which can be found at

<http://www.keysight.com/find/sweula>

The license set forth in the EULA represents the exclusive authority by which the U.S. government may use, modify, distribute, or disclose the Software. The EULA and the license set forth therein, does not require or permit, among other things, that Keysight: (1) Furnish technical information related to commercial computer software or commercial computer software documentation that is not customarily provided to the public; or (2) Relinquish to, or otherwise provide, the government rights in excess of these rights customarily provided to the public to use, modify, reproduce, release, perform, display, or disclose commercial computer software or commercial computer software documentation. No additional

government requirements beyond those set forth in the EULA shall apply, except to the extent that those terms, rights, or licenses are explicitly required from all providers of commercial computer software pursuant to the FAR and the DFARS and are set forth specifically in writing elsewhere in the EULA. Keysight shall be under no obligation to update, revise or otherwise modify the Software. With respect to any technical data as defined by FAR 2.101, pursuant to FAR 12.211 and 27.404.2 and DFARS 227.7102, the U.S. government acquires no greater than Limited Rights as defined in FAR 27.401 or DFAR 227.7103-5 (c), as applicable in any technical data.

## Safety Notices

### CAUTION

A **CAUTION** notice denotes a hazard. It calls attention to an operating procedure, practice, or the like that, if not correctly performed or adhered to, could result in damage to the product or loss of important data. Do not proceed beyond a CAUTION notice until the indicated conditions are fully understood and met.

### WARNING

A **WARNING** notice denotes a hazard. It calls attention to an operating procedure, practice, or the like that, if not correctly performed or adhered to, could result in personal injury or death. Do not proceed beyond a WARNING notice until the indicated conditions are fully understood and met.

Table of Contents

**N5280A**

|   |    |
|---|----|
| Introduction . . . . .  | 5  |
| Description . . . . .   | 8  |
| Network Analyzer Requirements . . . . .                           | 8  |
| Verifying the Shipment. . . . .                                   | 8  |
| Available Options . . . . .                                       | 10 |
| Test Set Options. . . . .   | 10 |
| General Specifications . . . . .                                  | 11 |
| Power Requirements . . . . .                                      | 12 |
| Environmental Requirements . . . . .                              | 13 |
| Environmental . . . . .   | 13 |
| Equipment Heating and Cooling . . . . .                           | 13 |
| Required Conditions for Accuracy Enhanced Measurement. . . . .    | 13 |
| Dimensions and Space Requirements . . . . .                       | 14 |
| Maximum Power Levels . . . . .                                    | 14 |
| Front and Rear Panel Features. . . . .                            | 15 |
| RF INPUTS (A, B, C and D) (all options) . . . . .                 | 15 |
| IF OUTPUTS (A, B, C and D) (Option 002) . . . . .                 | 15 |
| LO INPUT (Option 002). . . . .                                    | 15 |
| Standby Switch . . . . .  | 15 |
| IF OUT (A, B, C/R1 and D/R2) (Option 700 and 001) . . . . .       | 16 |
| LO IN (Option 700 and 001) . . . . .                              | 17 |
| LO AUX (All Options) . . . . .                                    | 17 |
| Attenuators (A, B, C and D) (Option 001) . . . . .                | 17 |
| Line Module . . . . .   | 17 |
| Available Fuses. . . . .  | 17 |
| Controlling the Test Set with N5242A . . . . .                    | 18 |
| Controlling the Test Set with N5264A . . . . .                    | 20 |
| Controlling the N5280A Option 002 using an Oscilloscope . . . . . | 24 |
| Controlling the RF Receiver Attenuators . . . . .                 | 25 |
| Operational Check . . . . .                                       | 27 |
| Equipment Required. . . . .                                       | 27 |
| Verification Limits . . . . .                                     | 28 |
| Typical Plots . . . . .   | 31 |
| Operational Check Procedure (Option 700 and 001) . . . . .        | 33 |
| Preparing the N5242A . . . . .                                    | 33 |
| Attenuator Element Verification Procedure. . . . .                | 37 |
| Operational Check Procedure (Option 002). . . . .                 | 38 |
| Requirements for Operational Check. . . . .                       | 38 |

## Contents

|   |    |
|---|----|
| Required Hardware . . . . .                                       | 38 |
| Instrument Setup (Source Calibration) . . . . .                   | 39 |
| Check IF Output A . . . . .                                       | 40 |
| Check LO AUX . . . . .  | 42 |
| Safety and Information . . . . .                                  | 46 |
| Introduction . . . . .  | 46 |
| Safety Earth Ground . . . . .                                     | 46 |
| Statement of Compliance . . . . .                                 | 46 |
| Before Applying Power . . . . .                                   | 47 |
| Connector Care and Cleaning Precautions . . . . .                 | 48 |
| Regulatory Information . . . . .                                  | 49 |
| Instrument Markings . . . . .                                     | 49 |
| Battery . . . . .   | 51 |
| EMC . . . . .   | 51 |
| South Korean Class A EMC Declaration . . . . .                    | 51 |
| Safety . . . . .  | 51 |
| Acoustic Statement (European Machinery Directive): . . . . .      | 51 |
| Declaration of Conformity . . . . .                               | 52 |
| Electrostatic Discharge Protection . . . . .                      | 53 |
| Keysight Support, Services, and Assistance . . . . .              | 54 |
| Service and Support Options . . . . .                             | 54 |
| Contacting Keysight . . . . .                                     | 54 |
| Shipping Your Product to Keysight for Service or Repair . . . . . | 54 |

Keysight N5280A

User's and Service Guide

## N5280A

### Introduction

The N5280A replaces the 8511A Four Channel Frequency Converter Test Set. This document describes how to use the N5280A Test Set with the Keysight N5242A 2-Port, or 4-Port PNA-X Network Analyzer and N5264A Measurement Receiver.

Figure 1 N5242A 2-Port PNA-X with N5280A

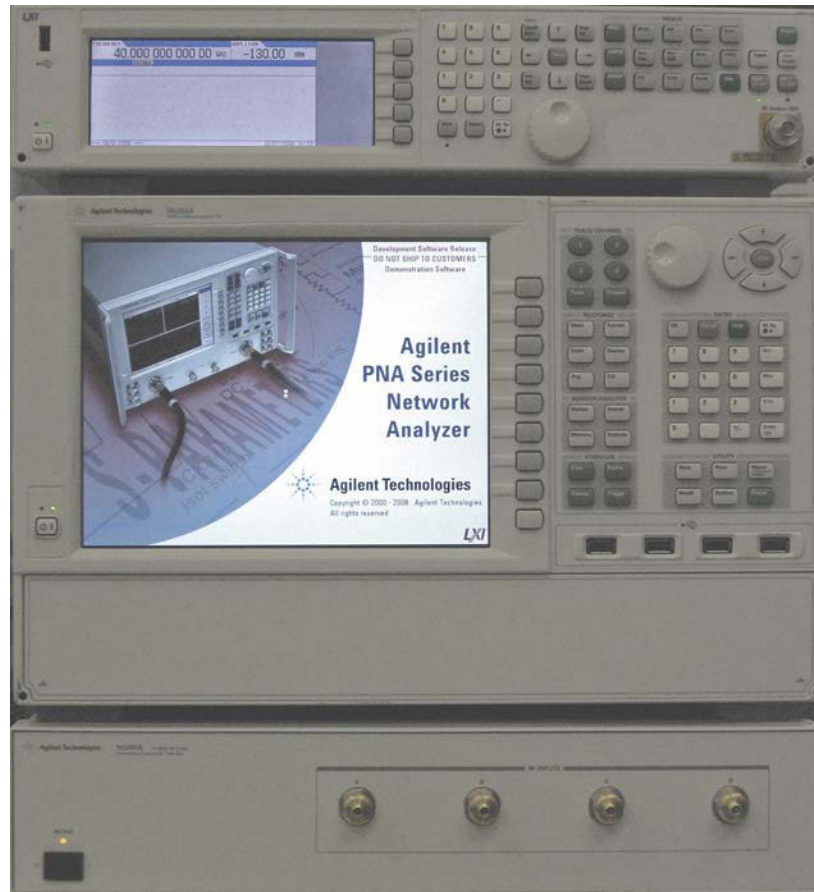

Figure 2

N5242A 4-Port PNA-X with N5280A



Figure 3 N5264A Measurement Receiver with N5280A



## Description

The Keysight N5280A is a four channel frequency converter Test Set. This Test Set is used with the Keysight N5242A 2-Port or 4-Port PNA-X Network Analyzer, and a N5264A Measurement Receiver. It can be operated with other microwave accessories (couplers, power splitters). The N5280A provides a convenient means of customizing a test configuration for a variety of applications within a frequency range of 10 MHz to 26.5 GHz. In addition to configurations for measuring reflection and transmission parameters of one-port or two-port devices, you can build configurations to characterize antenna parameters, radar cross sections and frequency translation devices. **Figure 4 on page 9** illustrates one possible measurement set-up configuration.

## Network Analyzer Requirements

- The N5242A 2-Port or 4-Port PNA-X Network Analyzer (10 MHz to 26.5 GHz) requires Option 020, which adds IF inputs.
- The N5264A Measurement Receiver requires Option 108, which adds LO Source 26.5 GHz.

More PNA information is available on the following websites:

- Documentation - <http://www.keysight.com/find/pna>
- Network Analyzer Firmware - <http://na.support.keysight.com/pna/firmware>

## Verifying the Shipment

To verify the contents shipped with your product, refer to **Table 1**.

Inspect the shipping container. If the container or packing material is damaged, it should be kept until the contents of the shipment have been checked mechanically and electrically. If there is physical damage refer to **“Contacting Keysight” on page 54**. Keep the damaged shipping materials (if any) for inspection by the carrier and an Keysight Technologies representative.

**Table 1** Content List

| Keysight Part Number | Description                 | Qty |
|----------------------|-----------------------------|-----|
| 9320-6636            | Functional Test Certificate | 1   |
| 9320-0333            | Envelope-Cal Certificate    | 1   |
| 5063-9232            | Rack Mount Kit with Handles | 1   |
| 5063-9226            | Front Handle Kit            | 1   |
| 5061-9038            | Cable Assembly              | 5   |
| N5280-90001          | User's and Service Guide    | 1   |



Figure 4 Measurement Setup

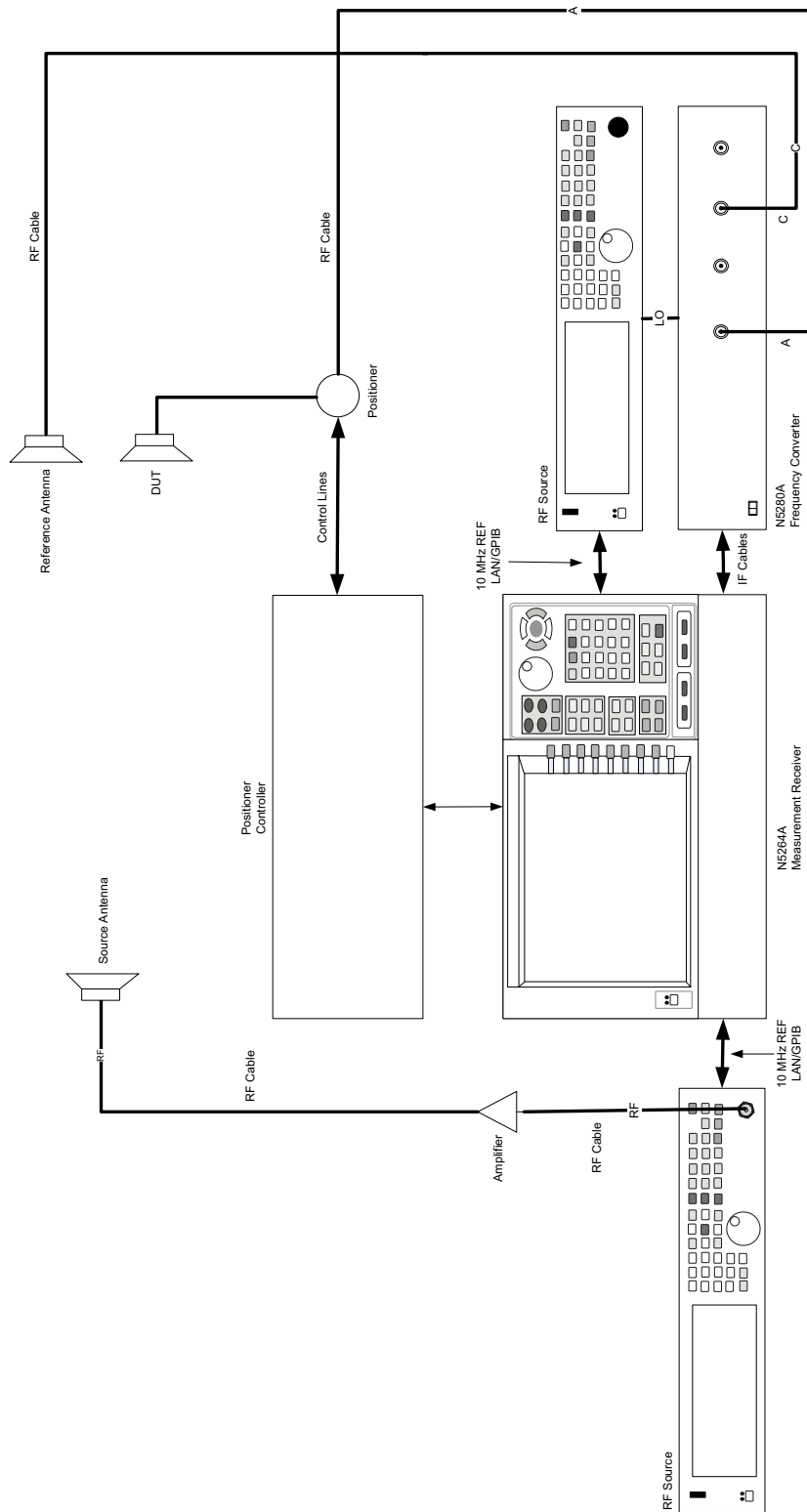

N5280A  
Description

## Available Options

### Test Set Options

The N5280A has two available Test Set options:

Refer to **Figure 29 on page 43**, **Figure 30 on page 44** and **Figure 31 on page 45**.

- Standard (700) - There are no attenuators in the RF Input paths.
- Option 001 - There are four attenuators (0 to 35 dB) in the RF Input paths to reduce the power levels.
- Option 002 - There are four IF Channels (A, B, C and D) and LO Input on the front panel.

## General Specifications

Specifications for the N5280A Frequency Converter Test Set (10 MHz to 26.5 GHz) are characteristic for the System performance of the PNA and Test Set. Actual performance of the system is based on the customers PNA that is used with the Test Set.

A functional certificate is supplied for the N5280A. The N5280A performance is based on external components such as the calibration kit, network analyzer, external sources, and measurement receiver. There are no internal adjustments in the N5280A, therefore an annual calibration is not required.

Frequency range and connectors are listed in **Table 2** for specific ports.

**Table 2** Frequency Range and Connectors

| Port    | Frequency Range  | Connectors    |
|---------|--|---------------|
| RF Port | 0.01 to 26.5 GHz   | 3.5 mm female |
| LO Port | 0.01 to 26.5 GHz   | 3.5 mm female |
| IF Port | 7 to 20 MHz (with jumper, LP OUT)<br>0.007 to 1.5 GHz (without jumper, Max BW) | SMA female    |

## Power Requirements

Verify that the required ac power is available before installing the Test Set to the PNA.

- 100/120/220/240 VAC (50/60Hz)
- The instruments can operate with mains supply voltage fluctuations up to  $\pm 10\%$  of the nominal voltage.
- Air conditioning equipment (or other motor-operated equipment) should not be placed on the same ac line that powers the Test Set and PNA.
- **Table 3** contains the maximum wattage for all instruments. This table can be use to determine the electrical and cooling requirements.

**Table 3** Maximum Power Requirements

| Standard Equipment |             |
|--------------------|-------------|
| Instrument         | Max Wattage |
| N5242A             | 450         |
| N5264A             | 450         |
| N5280A             | 350         |

### WARNING

This is a Safety Class I product (provided with a protective earthing ground incorporated in the power cord). The mains plug shall be inserted only into a socket outlet provided with a protective earth contact. Any interruption of the protective conductor, inside or outside the instrument, is likely to make the instrument dangerous. Intentional interruption is prohibited.

---

## Environmental Requirements

The environmental requirements of the Test Set are listed in [Table 4](#). Refer to the N5242A PNA-X and N5264A Measurement Receiver standard documentation for environmental requirements.

### CAUTION

**Ventilation Requirements:** When installing the instrument in a cabinet, the convection into and out of the instrument must not be restricted. The ambient temperature (outside the cabinet) must be less than the maximum operating temperature of the instrument by 4 °C for every 100 watts dissipated in the cabinet. If the total power dissipated in the cabinet is greater than 800 watts, forced convection must be used.

Table 4 PNA Operating Environment

| Operating Environmental Requirements: |   |
|---------------------------------------|---|
| Temperature                           | 0 °C to 40 °C (32 °F to 104 °F)   |
| Measurement Calibration               | 20 °C to 26 °C (68 °F to 79 °F)   |
| Performance Verification              | Temperature must be within 1 °C (1.8 °F) of the temperature at which the measurement calibration was performed. |
| Pressure Altitude (Operating)         | 3000 meters (9,842 feet)  |

### Environmental

The N5280A complies with all applicable safety and regulatory requirements for the intended location of use.

- The instrument can safely operate in a relative humidity of 80% for temperatures to 31 °C, decreasing linearly to 50% relative humidity at 40 °C.

### Equipment Heating and Cooling

If necessary, install air conditioning and heating to maintain the ambient temperature within the appropriate range. Air conditioning capacity must be consistent with the BTU ratings given in [Table 3](#).

### Required Conditions for Accuracy Enhanced Measurement

Accuracy-enhanced (error-corrected) measurements require the ambient temperature of the PNA and Test Set to be maintained within  $\pm 1$  °C of the ambient temperature at calibration.

## Dimensions and Space Requirements

Standard installation of the N5280A and PNA includes configuration and installation on a customer provided lab bench, or table top of adequate size and strength.

**Table 5 Instrument Dimensions**

| Model  | Weight                   | Height                | Width                 | Depth                 |
|--------|--------------------------|-----------------------|-----------------------|-----------------------|
| N5242A | 37 kg<br>82 lb (±0.5 lb) | 26.67 cm<br>(10.5 in) | 42.5 cm<br>(16.75 in) | 55.8 cm<br>(21.97 in) |
| N5264A | 22 kg<br>48 lb (±0.5 lb) | 26.67 cm<br>(10.5 in) | 42.5 cm<br>(16.75 in) | 55.8 cm<br>(21.97 in) |
| N5280A | 9.1 kg<br>(20 lb)        | 8.9 cm<br>(3.5 in)    | 42.5 cm<br>(16.75 in) | 48.3 cm<br>(19 in)    |

## Maximum Power Levels

**Table 6 Power Levels**

|                                       |               |
|---------------------------------------|---------------|
| RF Input Power Damage Levels          |               |
| RF Port                               | +18 dBm       |
| LO Port                               | +5 dBm        |
| Optimum LO Power                      | 0 dBm (±1 dB) |
| RF Input @ 0.1 dB Typical Compression |               |
| A- D Receiver                         | -10 dBm       |
| IF Output Level <sup>1</sup>          |               |
| Ports A- D                            | -10 dBm       |

1. IF Output level is based on the RF Input @ 0.1 dB typical compression.

**NOTE**

Refer to your PNA specifications to determine the maximum input power levels for the PNA access and test ports, or to optimize the power levels in the receivers.

**NOTE**

Damage and maximum levels are not necessarily the optimum level.

## Front and Rear Panel Features

Figure 5 Front Panel N5280A (Option 700 and 001)

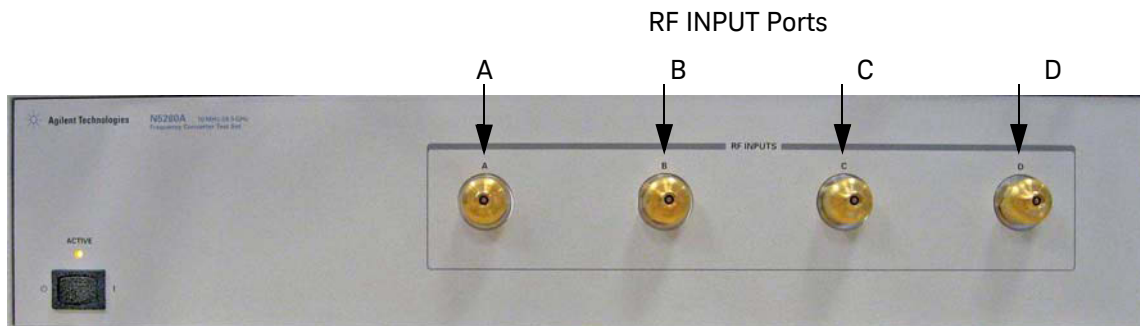
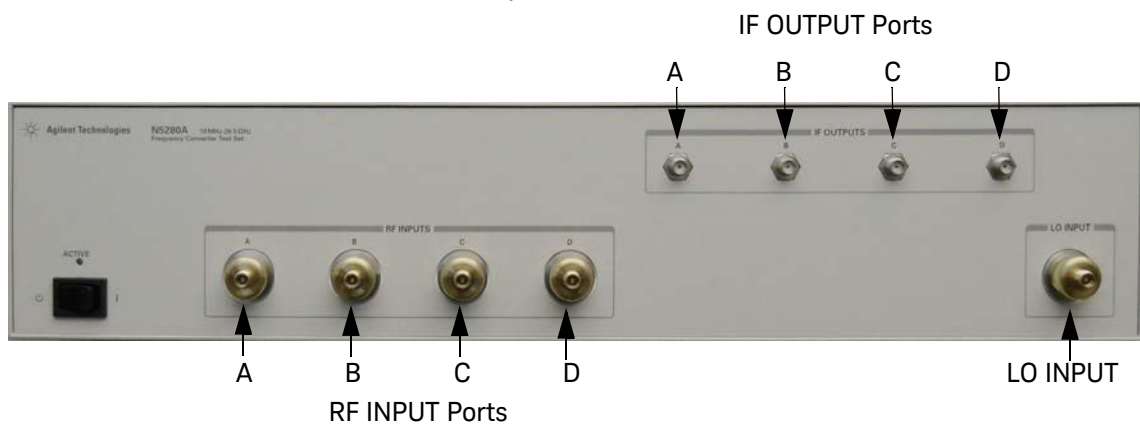

Figure 6 Front Panel N8280A (Option 002)



### RF INPUTS (A, B, C and D) (all options)

These input signals (10 MHz to 26.5 GHz) will be downconverted and directed to the IF Outputs.

### IF OUTPUTS (A, B, C and D) (Option 002)

These outputs transmit IF signals (10 MHz to 1.5 GHz) derived from the RF Inputs.

### LO INPUT (Option 002)

This input signal (10 MHz to 26.5 GHz) is used as the LO to downconvert the RF Inputs and to provide a buffered LO Output.

### Standby Switch

The switch is only a Standby switch, not a AC line power switch. The main power cord can be used as the system disconnecting device. It disconnects the mains circuits from the mains supply.

N5280A  
Front and Rear Panel Features

Figure 7 Rear Panel (Option 700 and 001)

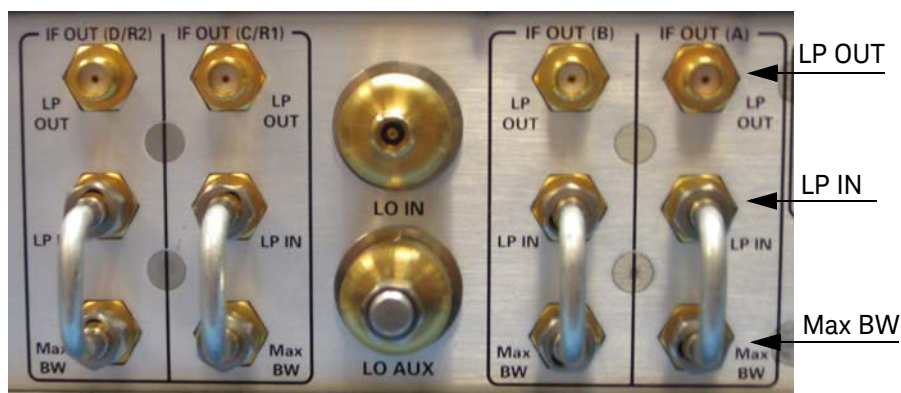
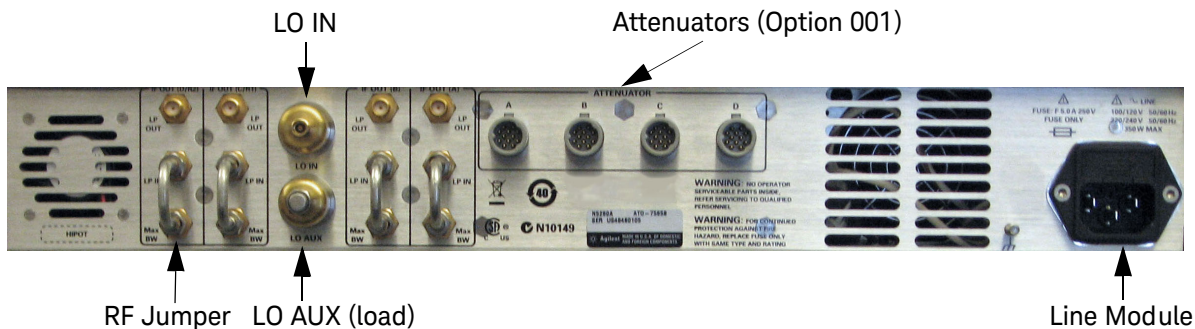

Figure 8 Rear Panel (Option 002)



IF OUT (A, B, C/R1 and D/R2) (Option 700 and 001)

LP OUT from the IF Outputs are connected to the IF Inputs on the PNA-X. The RF Jumper (N5222-20091 was E8356-20072) is connected between LP IN and Max BW. These connectors transmit the IF signal from the Test Set to the N5242A 2-Port or 4-Port PNA-X and N5264A Measurement Receiver.



### LO IN (Option 700 and 001)

LO IN is connected to the LO OUT from the EXT TSET DRIVE on the PNA-X.

### LO AUX (All Options)

The load (1810-0118) is connected to LO AUX.

### Attenuators (A, B, C and D) (Option 001)

These connectors are used only in Test Sets with Option 001. The four Viking attenuator connectors are controlled by the 11713C Attenuator Switch Driver.

### Line Module

The line fuse, as well as a spare, reside within the line module. **Figure 9** illustrates where the fuses are located and how to access them.

### Available Fuses

- Fuse (F 5 A/250V, 2110-0709) UL listed and CSA certified

#### **WARNING**

For continued protection against fire hazard replace line fuse only with same type and rating: Fuse 5A/250V, Part Number 2110-0709. The use of other fuses or material is prohibited.

---

Figure 9

Line Fuse



#### **CAUTION**

Verify that the premise electrical voltage supply is within the range specified on the instrument.

---

## Controlling the Test Set with N5242A

This section will describe how to setup and operate the N5280A Frequency Converter Test Set with the N5242A 2-Port or 4-Port PNA-X Network Analyzer.

A PNA-X must be used to control the N5280A. The internal LO Source from the PNA-X can be used for testing. Refer to **Figure 10** and **Figure 11** for cable connections from the N5280A to the N5242A PNA-X.

Figure 10 Front Panel N5280A and N5242A PNA-X

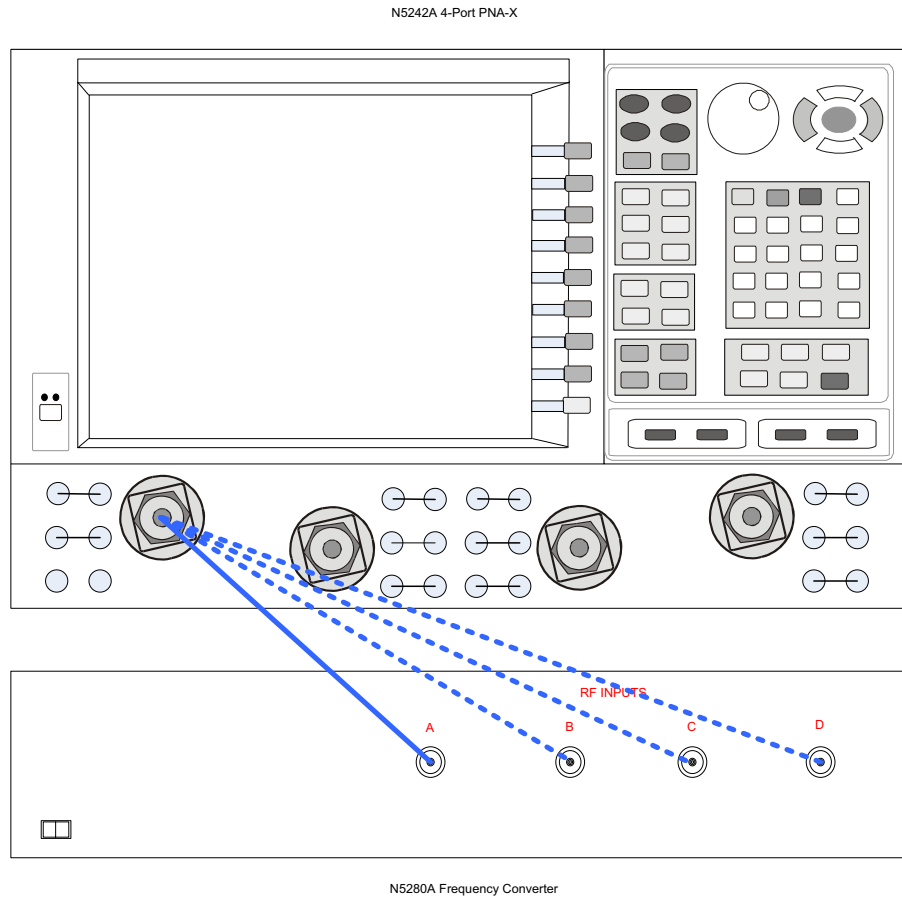
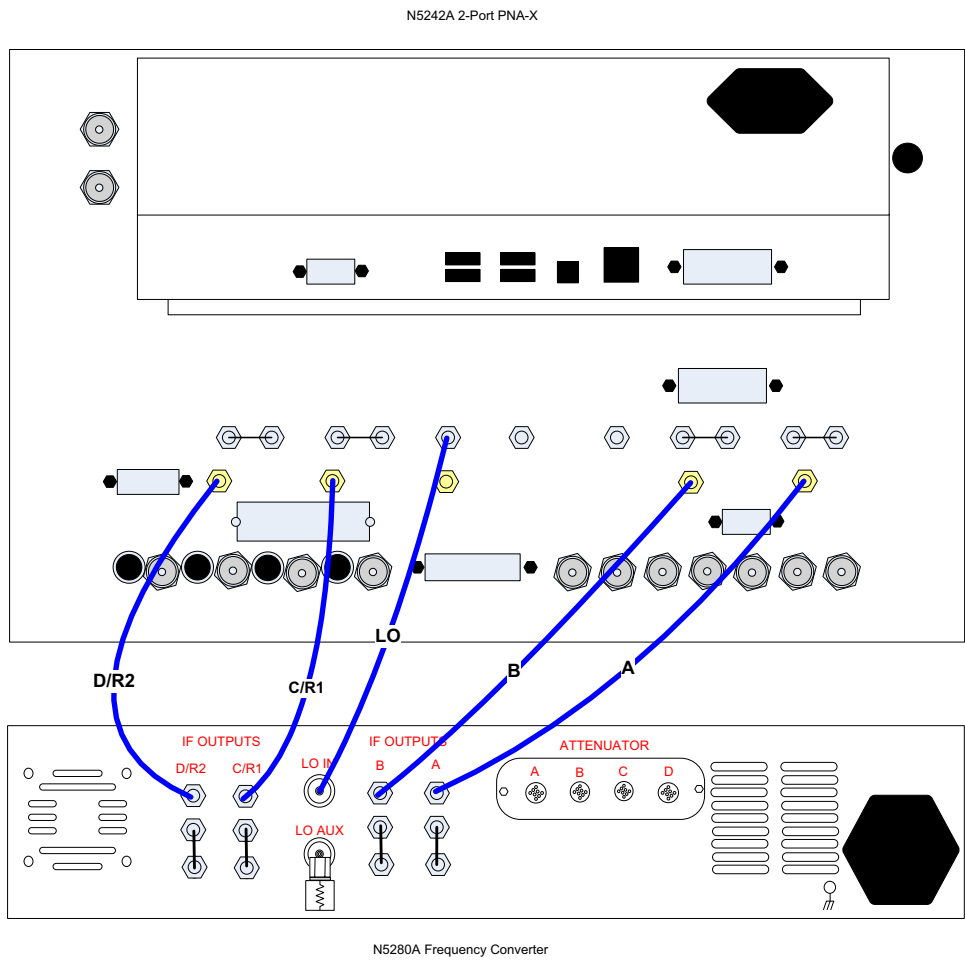

Figure 11 Rear Panel N5280A and N5242A PNA-X



## Controlling the Test Set with N5264A

This section will describe how to setup and operate the N5280A Frequency Converter Test Set with the N5264A Measurement Receiver.

A N5264A must be used to control the N5280A. The N5264A Option 108 adds an internal LO Source 26.5 GHz for testing. Refer to [Figure 12](#) and [Figure 16 on page 24](#) for cable connections.

You may also use an external LO Source for testing. Refer to [Figure 14 on page 22](#) and [Figure 15 on page 23](#) for cable connections.

Figure 12 Front Panel N5280A and N5264A with Option 108

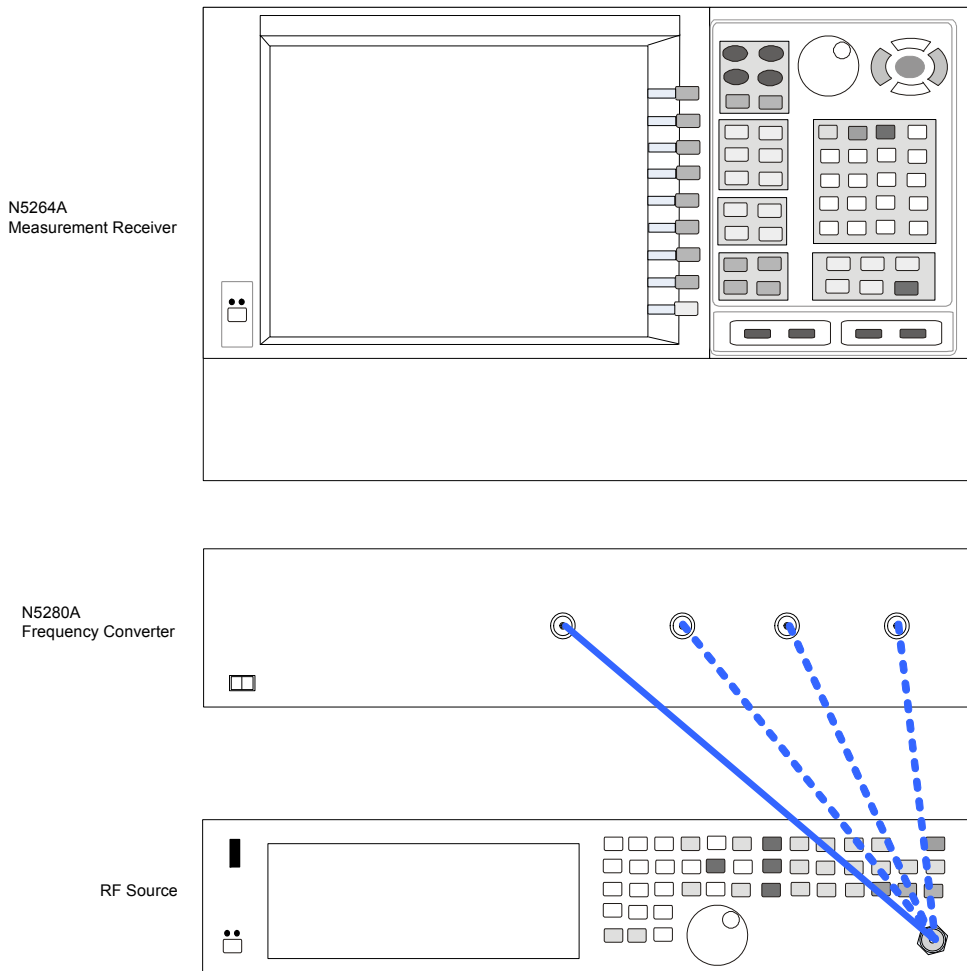

Figure 13

Rear Panel N5280A and N5264A with Option 108

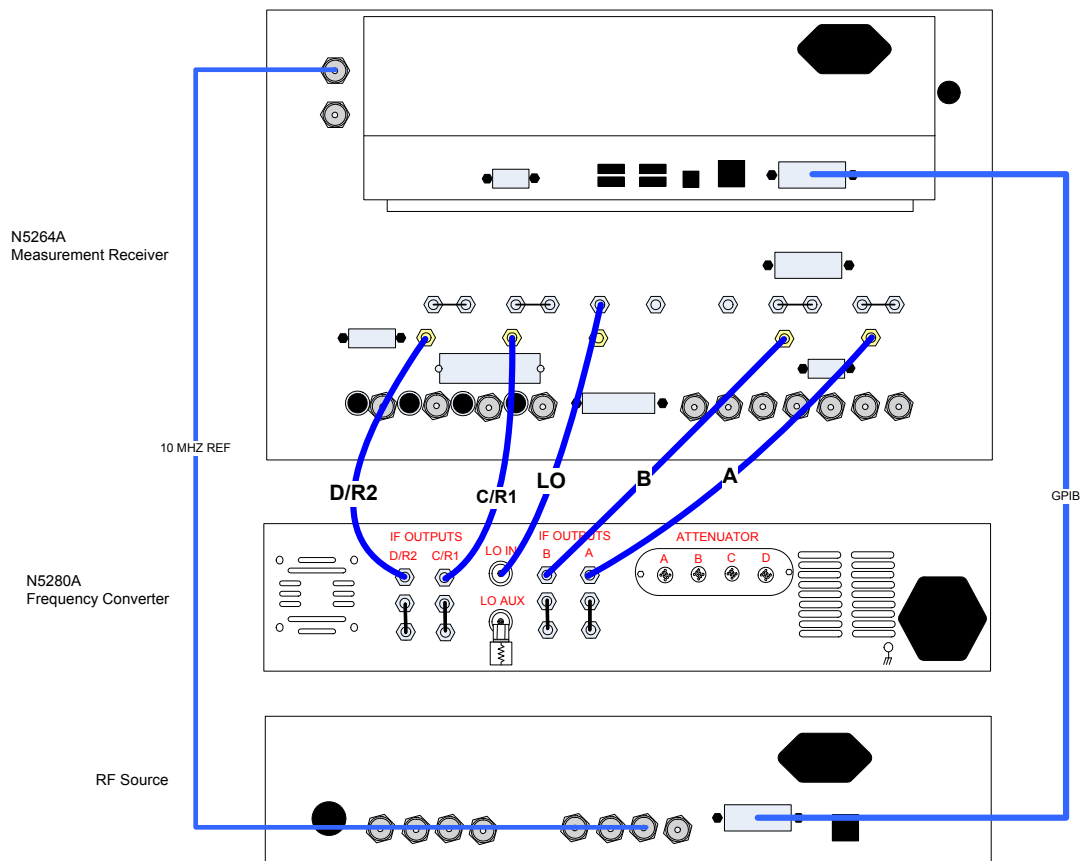

Figure 14 Front Panel N5280A and N5264A without Option 108

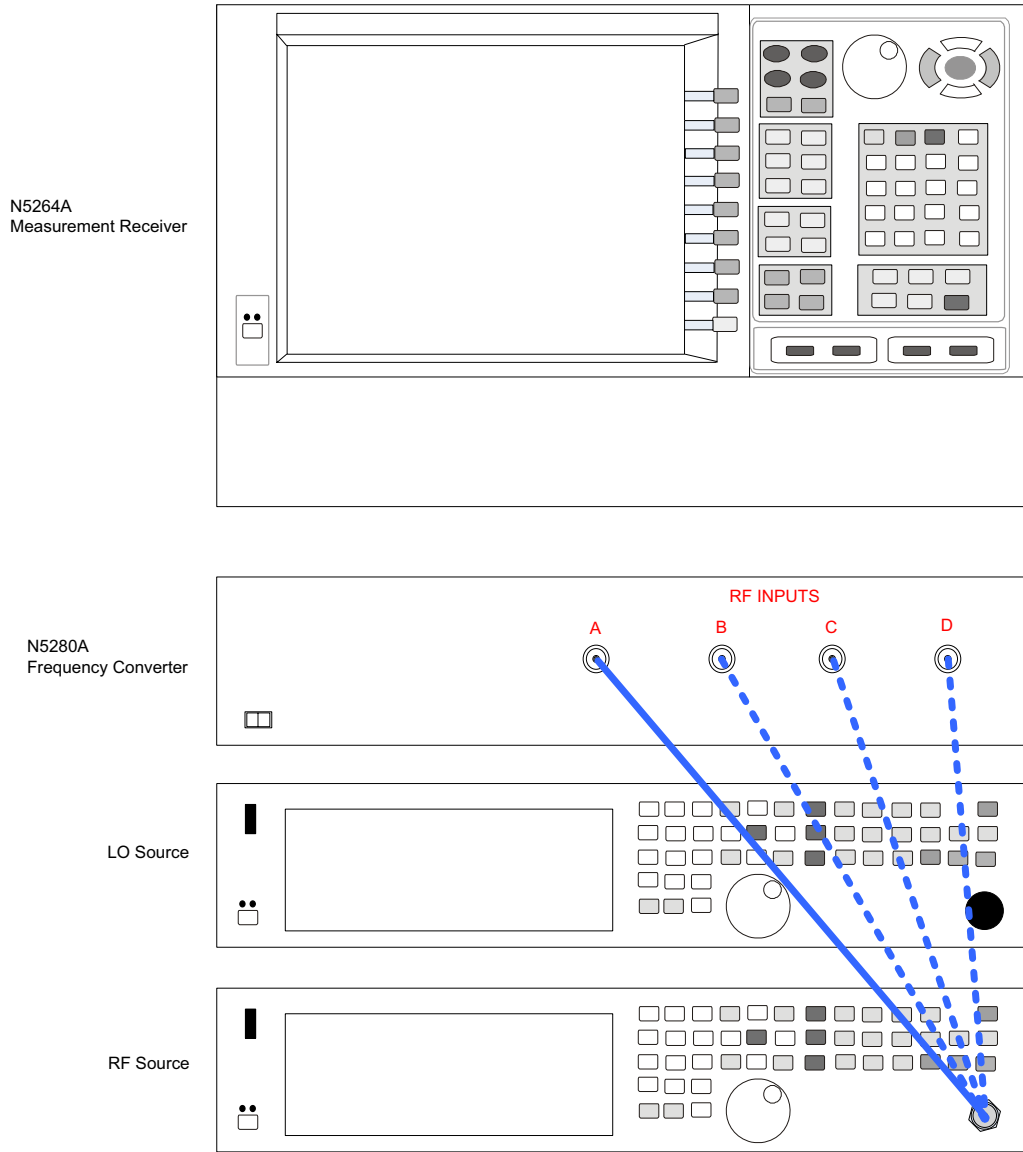
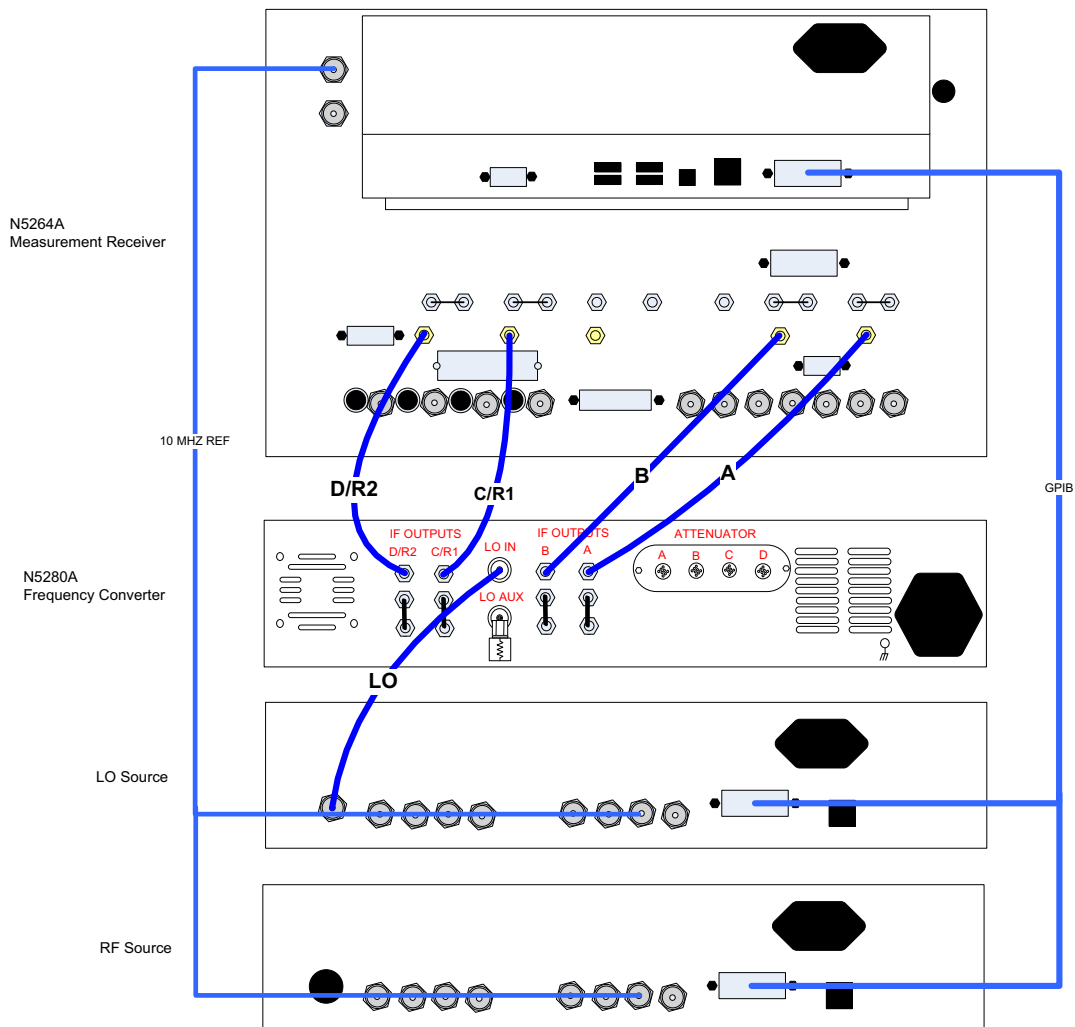
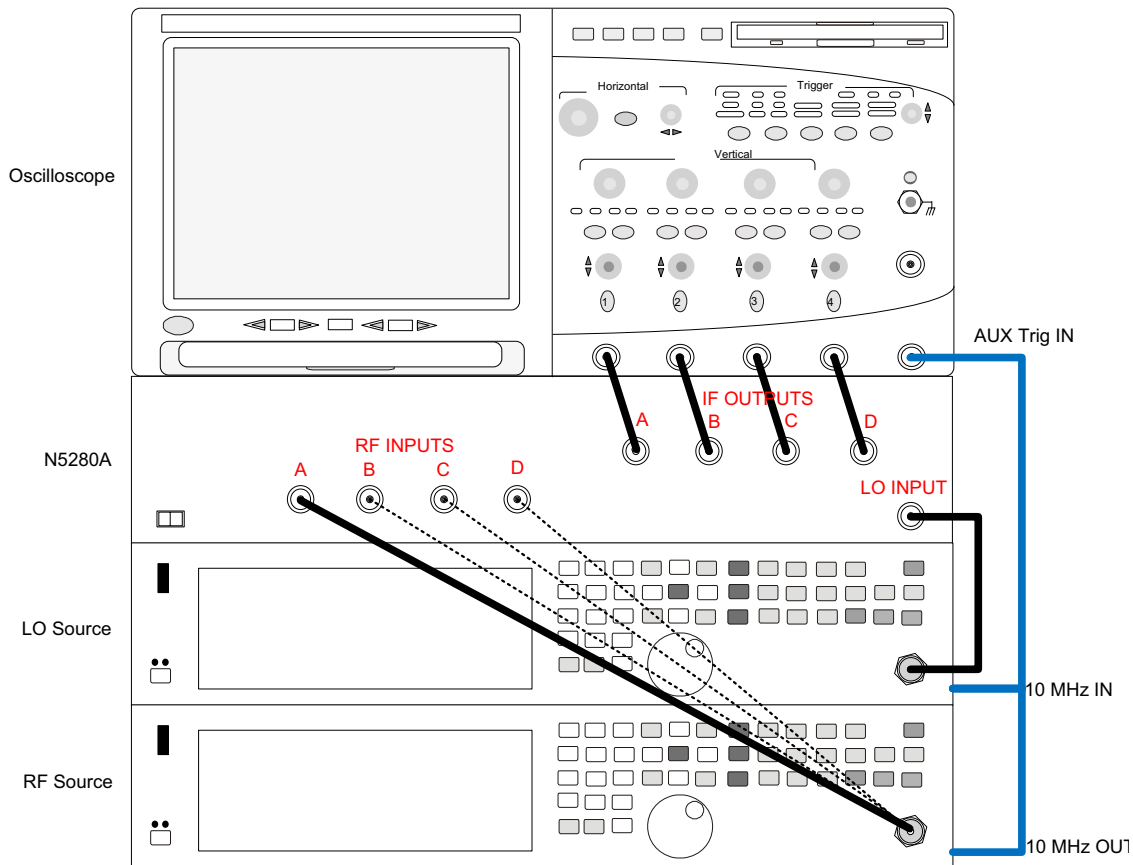

Figure 15 Rear Panel N5280A and N5264A without Option 108



# Controlling the N5280A Option 002 using an Oscilloscope

Figure 16 Front Panel N5280A and Oscilloscope





## Controlling the RF Receiver Attenuators

The 11713C attenuator switch driver controls the Test Set through the Viking connector on the rear panel.

Figure 17 Rear Panel N5280A Option 001 and 11713C

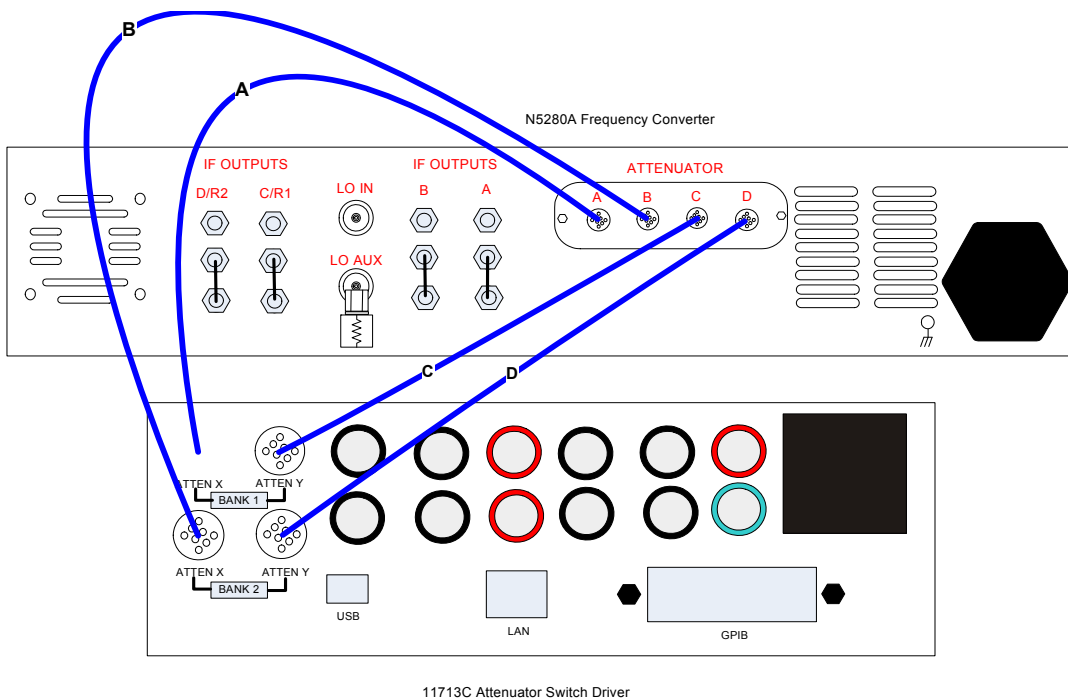

**Table 7** illustrates the key combinations that are required to set the attenuation.

Example: In the Attenuator X panel, press 1 & 3 to set A, RF INPUTS to 15 dB.

**Table 7 Attenuators**

|        | Attenuator X<br>(A, RF INPUTS) | Attenuator Y<br>(C, RF INPUTS) | Attenuation (dB) |
|--------|--------------------------------|--------------------------------|------------------|
| Bank 1 | 1                              | 5                              | 10               |
|        | 2                              | 6                              | 20               |
|        | 3                              | 7                              | 5                |
|        | Attenuator X<br>(B, RF INPUTS) | Attenuator Y<br>(D, RF INPUTS) | Attenuation (dB) |
| Bank 2 | 1                              | 5                              | 10               |
|        | 2                              | 6                              | 20               |
|        | 3                              | 7                              | 5                |

Figure 18 Front Panel

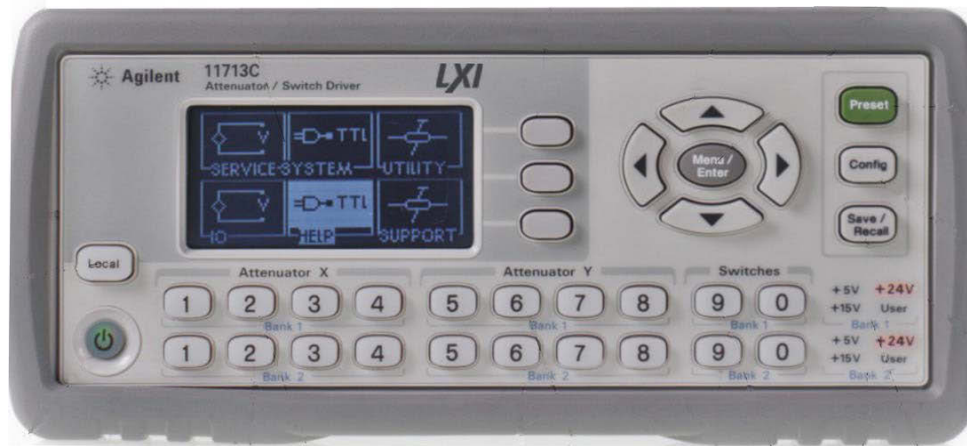

## Operational Check

This section provides operational check to confirm the N5280A and PNA-X operational performance. The operation verification limits provided ensure that your N5280A and PNA-X are operating properly.

### Equipment Required

The Keysight N5280A requires that the user be familiar with the equipment and components listed in **Table 8**.

This section provides an equipment list and setup of the PNA-X and Test Set.

**Table 8**                      **Equipment List**

| Description  | Qty |
|--|-----|
| N5242A 2-Port or 4-Port PNA-X Network Analyzer (Option 020) or | 1   |
| N5264A Measurement Receiver (Option 108)                       | 1   |

## Verification Limits

Specifications for the N5280A Multiport Test Set are typical. System performance for the PNA-X and Test Set are only characteristic and intended as non warranted information. Only a functional certificate is provided for the N5280A.

It is recommended that you return your instrument to Keysight Technologies for servicing or repair if the Test Set and PNA-X performance exceed the operational verification limits.

### NOTE

Typical specifications are based on 1 to 2 units performance.

**Table 9** RF Receiver Tracking

| RF Port Magnitude Tracking |         |
|----------------------------|---------|
| Frequency                  | Value   |
| 10 MHz to 20 GHz           | ±2.0 dB |
| 20 GHz to 22 GHz           | ±3.0 dB |
| 22 GHz to 26.5 GHz         | ±4.0 dB |

**Table 10** Noise Floor

| Direct Receiver Access Input Noise Floor <sup>1</sup><br>IF Band width equal to 10 Hz |                       |
|---|-----------------------|
| Frequency   | Receiver Access Input |
| 10 MHz to 100 MHz   | -128 dBm              |
| 100 MHz to 500 MHz  | -132 dBm              |
| 500 MHz to 2 GHz  | -133 dBm              |
| 2 GHz to 20 GHz   | -129 dBm              |
| 20 GHz to 24 GHz  | -122 dBm              |
| 24 GHz to 26.5 GHz  | -119 dBm              |

1. Noise floor measured with a 50 Ohm load at port, and measured as the mean value of a 801 point trace.

**Table 11 Trace Noise**

| Trace Noise Magnitude (dB, rms) <sup>1,2,3</sup><br>1 kHz IF Bandwidth |         |
|--|---------|
| Frequency  | Typical |
| 10 MHz to 100 MHz  | 0.02    |
| 100 MHz to 13.5 GHz  | 0.02    |
| 13.5 GHz to 16 GHz   | 0.02    |
| 16 GHz to 22.5 GHz   | 0.04    |
| 22.5 GHz to 24 GHz   | 0.04    |
| 24 GHz to 26.5 GHz   | 0.04    |

| Trace Noise Phase (deg, rms) <sup>1,4</sup><br>1 kHz IF Bandwidth |         |
|---|---------|
| Frequency   | Typical |
| 10 MHz to 100 MHz   | 0.15    |
| 100 MHz to 13.5 GHz   | 0.15    |
| 13.5 GHz to 16 GHz  | 0.15    |
| 16 GHz to 22.5 GHz  | 0.25    |
| 22.5 GHz to 26.5 GHz  | 0.25    |

1. Trace Noise, sweep to sweep variation.
2. Measured linear magnitude CW Frequency at 201 points.
3. Trace Noise in dB = 20 \* Log 10 (1+ standard deviation).
4. Trace Noise in degrees = standard deviation.

**Table 12 Port Match**

| RF/LO Port Match   |         |
|--------------------|---------|
| Frequency          | Value   |
| 10 MHz to 10 GHz   | < -9 dB |
| 10 GHz to 26.5 GHz | < -4 dB |

**Table 13**                      **Dynamic Range**

| <b>Dynamic Range @ 10 Hz IF Band width</b> |  |  |  |
|--|--|--|--|
| <b>Frequency</b>                           | <b>Typical (dB) Direct Receiver Access Input</b> | <b>Typical (dBm) Low-Level Noise Floor</b> | <b>Typical (dBm) Max Power<sup>1</sup></b> |
| 10 MHz to 50 MHz                           | 117  | 130  | -13  |
| 50 MHz to 100 MHz                          | 115  | 128  | -13  |
| 100 MHz to 500 MHz                         | 119  | 132  | -13  |
| 500 MHz to 2 GHz                           | 120  | 133  | -13  |
| 2 GHz to 20 GHz                            | 116  | 129  | -13  |
| 20 GHz to 24 GHz                           | 109  | 122  | -13  |
| 24 GHz to 26.5 GHz                         | 106  | 119  | -13  |

1. RCVR IN @ 0.1 dB typical compression at max power.

The receiver access input dynamic range is calculated as the difference between the receiver access input low-level noise floor, and the source maximum power to the receiver that results with a typical 0.1dB compression level.

Low-level noise floor measured with 50 Ohm load at the port.

The effective dynamic range must take measurement uncertainties and interfering signals into account. This set-up should only be used when the receiver input will not exceed its compression or damage level.

Typical Plots

Figure 19 CE Response at 10 MHz IF Outputs

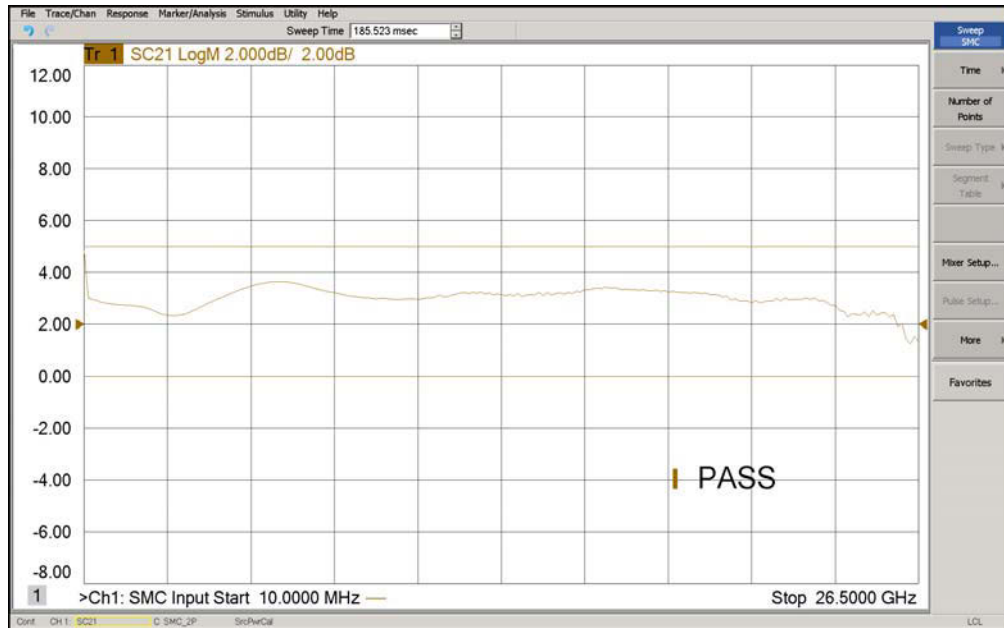
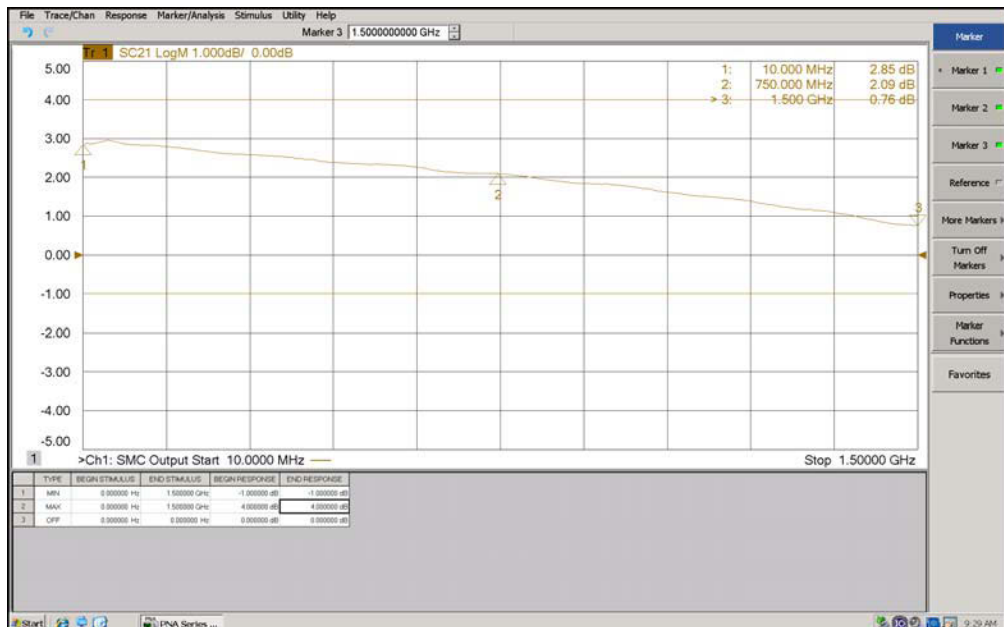

Figure 20 IF Bandwidth at 10 MHz to 1.5 GHz



N5280A  
Operational Check

Figure 21

LO AUX Output

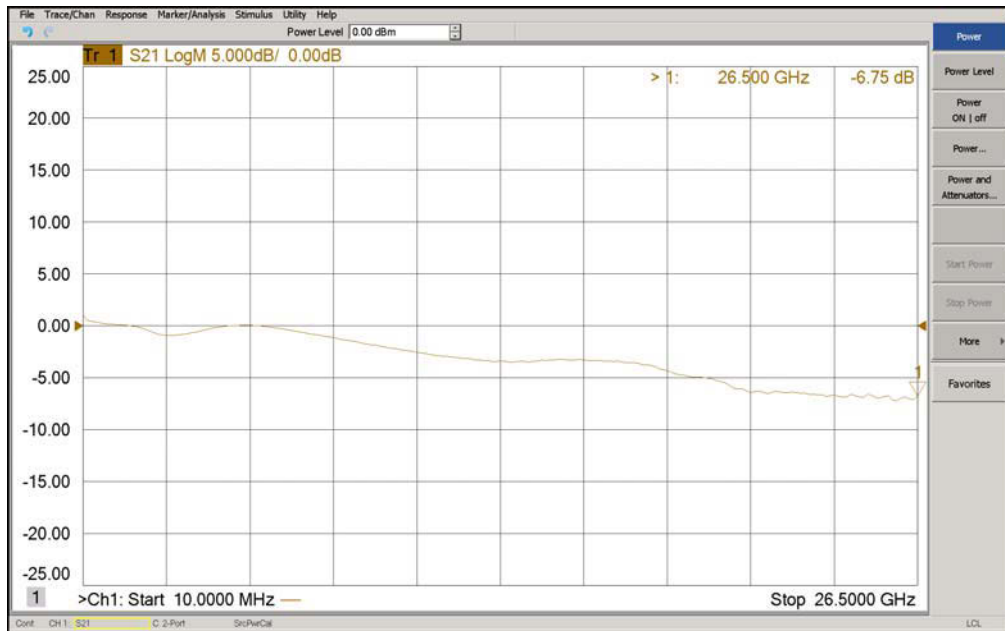



## Operational Check Procedure (Option 700 and 001)

The sequence of this procedure is very important and must be followed or the performance accuracy and results may vary from the reference plots provided.

The following procedures are used with the N5242A 4-Port PNA-X.

### NOTE

If you are using a N5242A 2-Port PNA-X, channels C and D will be replaced with R1 and R2.

---

### Preparing the N5242A

1. Connect the Test Set to the N5242A 4-Port PNA-X using the cables as shown in [Figure 10 on page 18](#) and [Figure 11 on page 19](#).
2. Connect the 10 dB attenuator to the PNA-X Reference port cable.
3. Turn On the Test Set.
4. Press [Preset].
5. Verify that the Stop Frequency is set to the maximum of the PNA-X and Test Set. If not, press [Freq] > Stop.
6. Verify that the Start Frequency is set to 10 MHz. If not, press [Freq] > Start > [10 MHz].
7. Verify that the Power is to set to -10 dBm. If not, press [Power] > Power Level and enter [-10 dBm].
8. Select [Avg] > IF Bandwidth > enter 1 kHz.
9. Select [Sweep] > Number of Points > enter 401.
10. Allow the Test Set and the PNA-X to warm up for a minimum of 30 minutes.
11. Set the IF Config On. Trace/Chan > Channel > Hardware Setup > IF Config.

Figure 22 IF Config

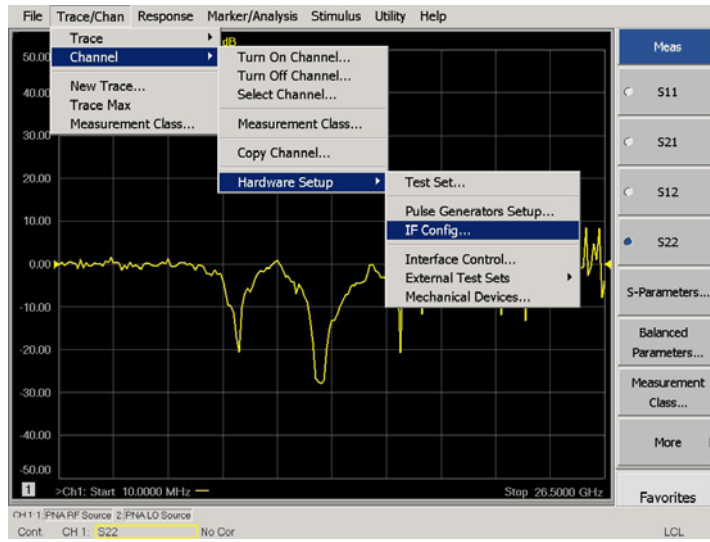

12. Select all of the IF Inputs External A, B, C and D > OK.

Figure 23 IF Input

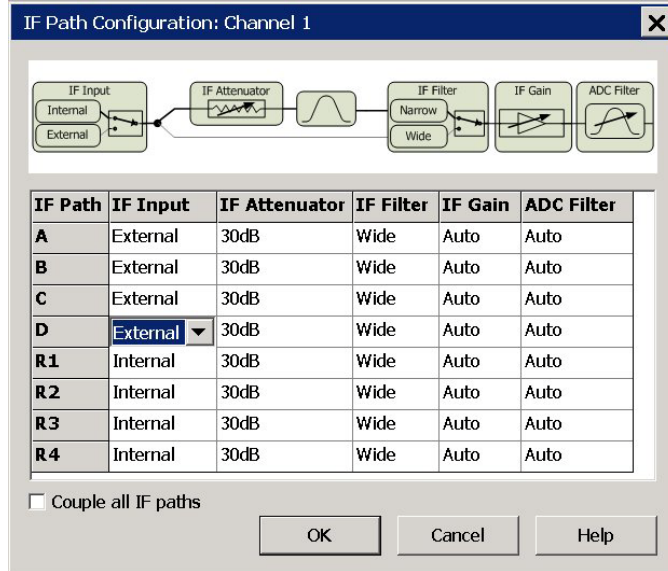

13. Connect the cable to A, RF INPUTS on the Test Set and select [Meas] > More > Receivers, select A > Apply > OK.

Figure 24 Receiver A

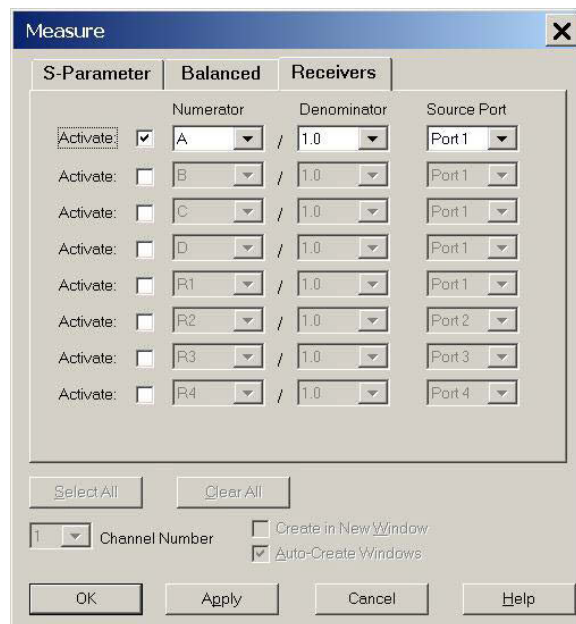

- Set the Reference level to  $-20$  dBm. Press [Scale] > Reference level > [ $-20$  dBm].

**NOTE**

All of the observed traces should decrease from  $-17$  dB ( $\pm 5$  dB) at 10 MHz to  $-34$  dB ( $\pm 5$  dB) at 26.5 GHz.

**Figure 25** Typical Receiver A

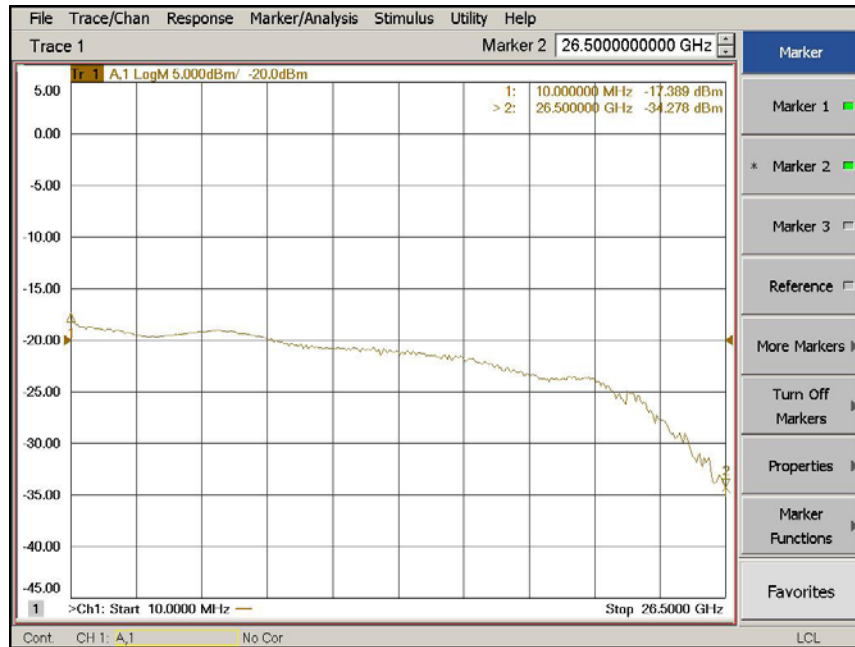

- Connect the cable to B, RF INPUTS on the Test Set. Select [Meas] > More > Receivers, select B > Apply > OK to observe the power level trace.
- Connect the cable to C, RF INPUTS on the Test Set. Select [Meas] > More > Receivers, select C > Apply > OK to observe the power level trace.
- Connect the cable to D, RF INPUTS on the Test Set. Select [Meas] > More > Receivers, select D > Apply > OK to observe the power level trace.

## Attenuator Element Verification Procedure

The Attenuator Element Verification Procedure is a functional test only. This test verifies the functionality of the variable attenuator in each channel RF path. The following procedures are used with the 11713C attenuator switch driver.

1. Connect the cables from the Test Set to the 11713C as shown in [Figure 17 on page 25](#).
2. Press [Preset].
3. Set the IF Config On. Select Trace/Chan > Channel > Hardware Setup > IF Config. Refer to [Figure 22 on page 34](#).
4. Select all of the IF Inputs External A, B, C and D > OK. Refer to [Figure 23 on page 35](#).
5. Select [Analysis] > Statistics On.
6. Select [Meas] > More > Receivers, select A > Apply > OK. Refer to [Figure 24 on page 35](#).
7. Select [Memory] > Normalize.
8. Select [1] on the 11713C. The mean value should read  $-10\text{ dB} (\pm 1\text{ dB})$ . Select [1] again, it should read 0 dB.
9. Select [2] on the 11713C. The mean value should read  $-20\text{ dB} (\pm 1\text{ dB})$ . Select [2] again, it should read 0 dB.
10. Select [3] on the 11713C. The mean value should read  $-5\text{ dB} (\pm 1\text{ dB})$ . Select [3] again, it should read 0 dB.
11. Repeat See “Select [Meas] > More > Receivers, select A > Apply > OK. Refer to [Figure 24 on page 35](#).” on page 37. through See “Select [3] on the 11713C. The mean value should read  $-5\text{ dB} (\pm 1\text{ dB})$ . Select [3] again, it should read 0 dB.” on page 37. for B, C and D RF INPUTS.

## Operational Check Procedure (Option 002)

The N5280A operational check can be verified using two Sources with a Power Meter and Power Sensor.

### Requirements for Operational Check

The N5280A operational check measures the signal paths from the LO INPUT to the LO OUTPUT (LO AUX) and each of the four internal mixers, using a power divider. Internally, the LO signal is mixed with RF input signals supplied through each of the RF INPUTS (A, B, C, and D) and measured at each of the IF OUTPUTS (A, B, C, and D). The following process demonstrates that all associated switches, connectors, cables and circuitry are operational.

### Required Hardware

To demonstrate that the N5280A is operating properly requires external equipment - the same equipment that would be used to perform a field calibration of the N5280A in a system. This external equipment includes two precision signal generators and a power meter with a power sensor and power sensor cable. The module interconnect cables are not used when performing this operational check; instead, two high-quality flexible 3.5 mm cables are needed along with adapters.

Please refer to the following table for recommended equipment.

**Table 14**                      **Keysight Recommended Equipment**

| Equipment                              | Description   |
|--|---|
| E8257D-532 or E8267D-532 or equivalent | PSG #1 and PSG #2<br>Precision Signal Generator (250 kHz to 31.8 GHz) |
| N1913A or N1914A or equivalent         | Single/Dual Channel Power Meter                                       |
| N8485A Option 100 or equivalent        | 10 MHz to 26.5 GHz Power Sensor                                       |
| 11730A or equivalent                   | Power Sensor Cable  |

### Instrument Setup (Source Calibration)

Using the power meter and power sensor, measure the PSG #1 (RF Source) and PSG #2 (LO Source) power levels at the frequencies listed in the **Table 15 on page 40** at the end of test port cables. Record The RF and LO values in the table.

Figure 26 Source and Power Meter Setup

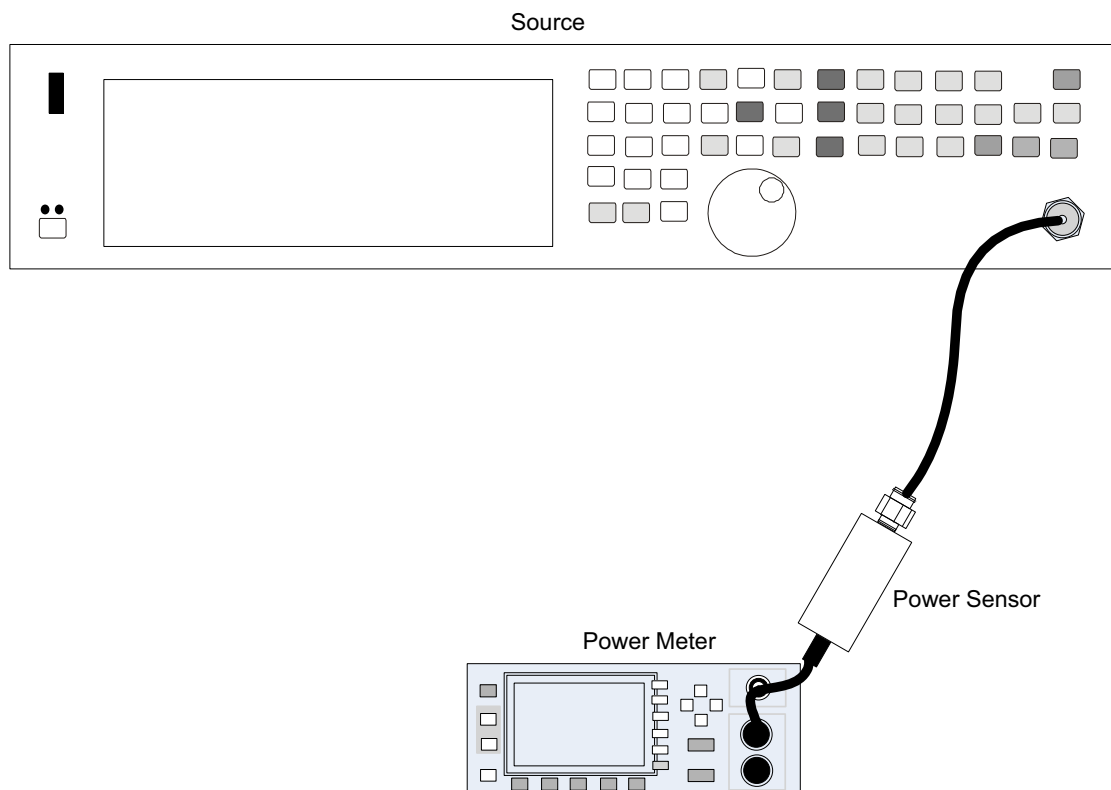

### Check IF Output A

1. On the PSG #1 connect RF OUT using a high-quality flexible cable to RF INPUT A on the N5280A.
2. On the PSG #2 connect RF OUT using a high-quality flexible cable to LO INPUT on the N5280A.
3. Connect the power meter to IF OUTPUT A on the N5280A.
4. Use the output frequencies and power levels from the [Table 15](#), set PSG #1 and PSG #2. Record the result in table for the measure IF OUTPUT A.
5. Repeat See “On the PSG #1 connect RF OUT using a high-quality flexible cable to RF INPUT A on the N5280A.” on page 40. to See “Use the output frequencies and power levels from the [Table 15](#), set PSG #1 and PSG #2. Record the result in table for the measure IF OUTPUT A.” on page 40. for IF Outputs B, C, and D.

Figure 27 IF Output Channel A Setup

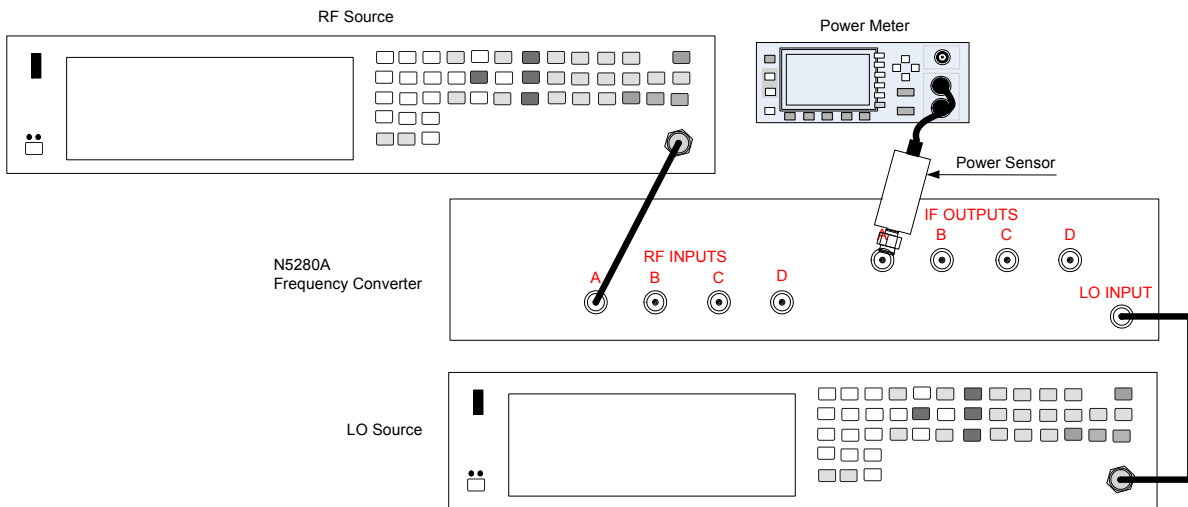

Table 15 Measured IF OUT Power Levels

| PSG #1<br>Output Freq<br>to RF IN A<br>(GHz) | RF IN<br>Power<br>Level (dBm) | PSG #2<br>Output Freq<br>to RF IN A<br>(GHz) | LO IN<br>Power<br>Level (dBm) | Power Level<br>Range Expected<br>at IF OUT A<br>(dBm) | Power Meter Reading Measured<br>for IF OUTputs and LO AUX (dBm) |
|--|-------------------------------|--|-------------------------------|---|---|
|  | -10 dBm                       |  | 0 dBm                         |   | A   |
| 3.5  |                               | 4  |                               | -5 to -11   |   |



Table 15 Measured IF OUT Power Levels

| PSG #1<br>Output Freq<br>to RF IN A<br>(GHz) | RF IN<br>Power<br>Level (dBm) | PSG #2<br>Output Freq<br>to RF IN A<br>(GHz) | LO IN<br>Power<br>Level (dBm) | Power Level<br>Range Expected<br>at IF OUT A<br>(dBm) | Power Meter Reading Measured<br>for IF OUtputs and LO AUX (dBm) |
|--|-------------------------------|--|-------------------------------|---|---|
|  | <b>-10 dBm</b>                |  | <b>0 dBm</b>                  |   | <b>A</b>  |
| 8.5  |                               | 9  |                               | -5 to -11   |   |
| 17.5   |                               | 18   |                               | -5 to -11   |   |
| 26.0   |                               | 26.5   |                               | -5 to -11   |   |

### Check LO AUX

1. Connect the power meter to the LO AUX on the N5280A.
2. Use the output frequencies and power levels from the [Table 15 on page 40](#). Record the result in table for the measure LO AUX. The LO AUX specification is greater than  $-10$  dBm.

Figure 28 IF LO AUX Setup

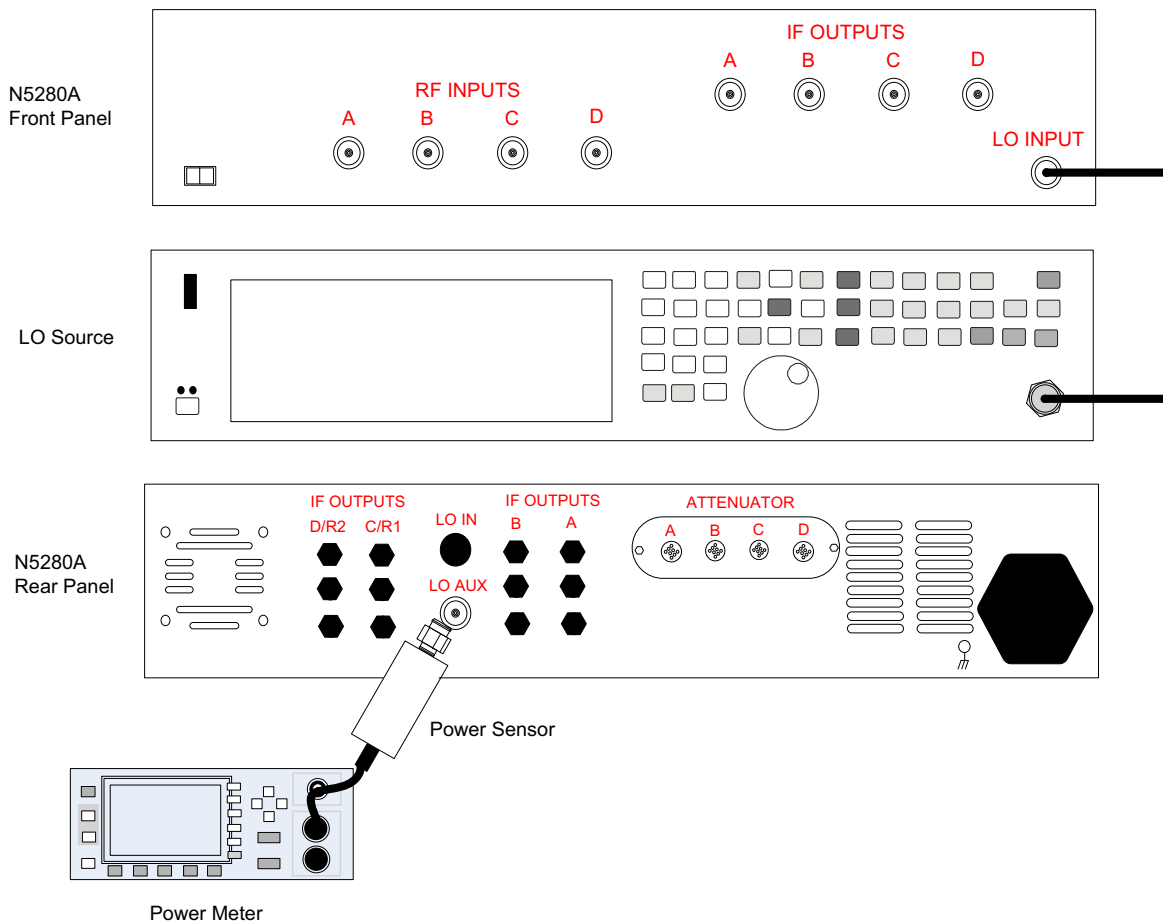
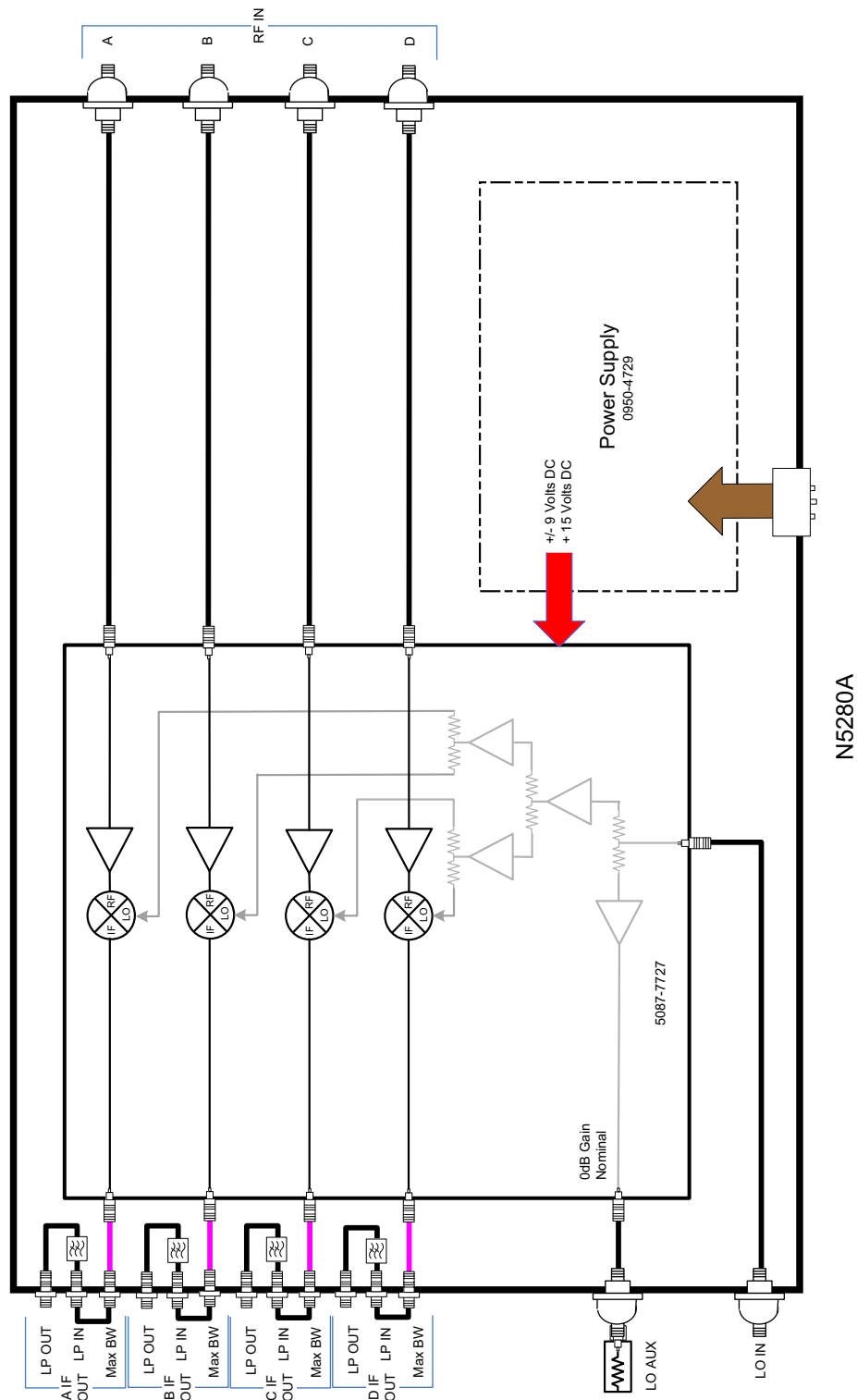

Figure 29

N5280A Block Diagram (Standard 700)



N5280A  
Operational Check

Figure 30

N5280A Block Diagram (Option 001)

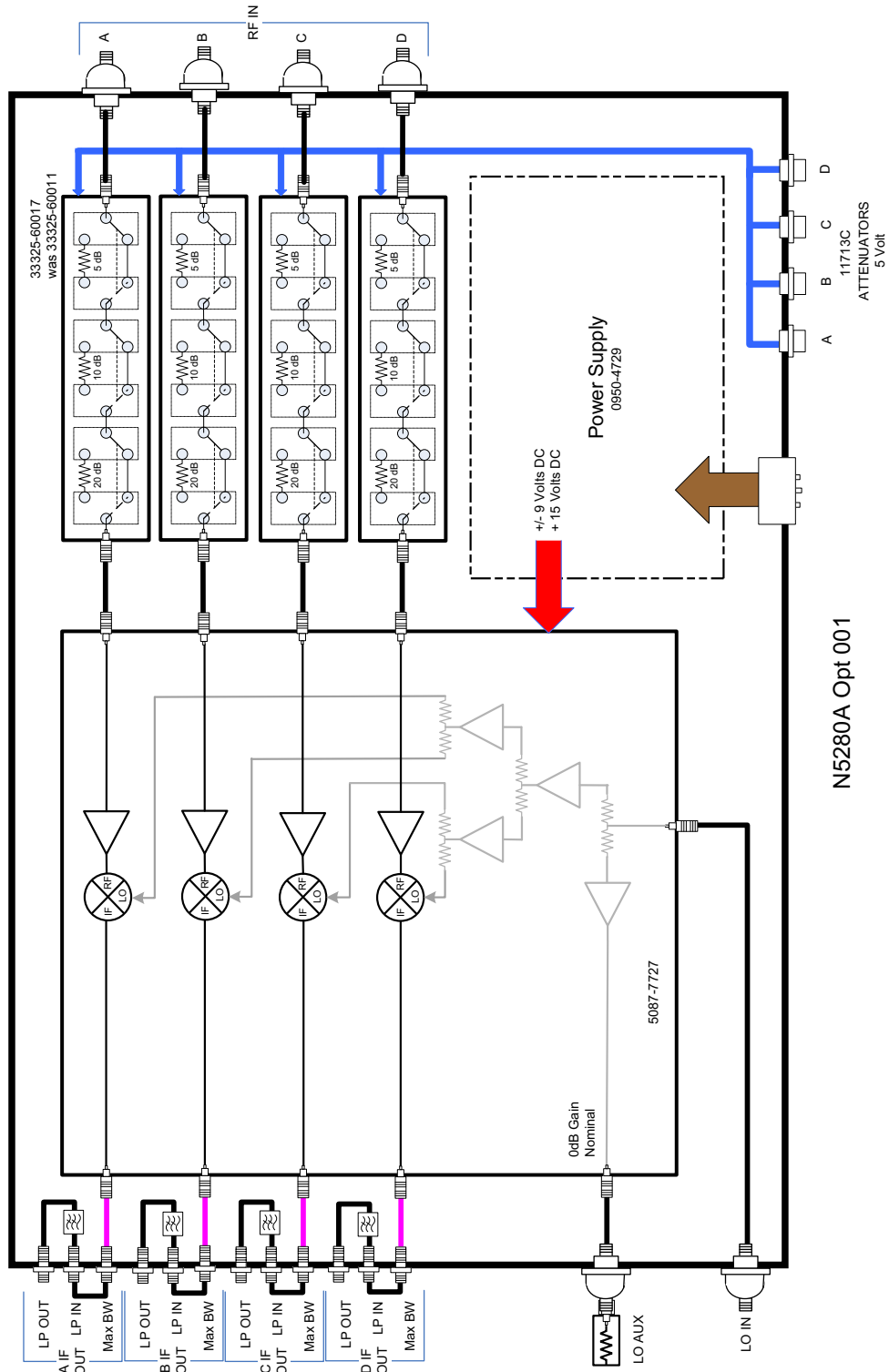
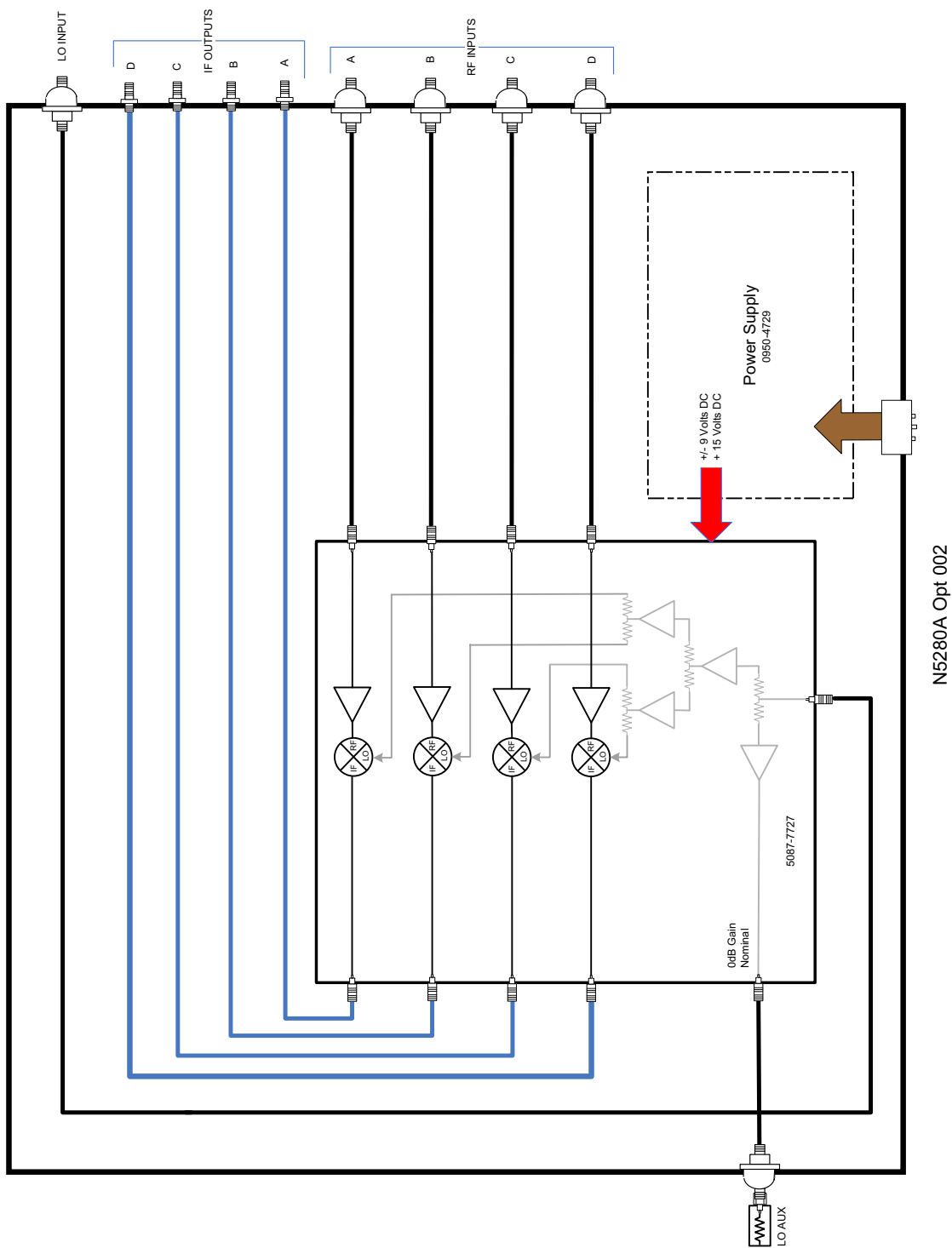

Figure 31

N5280A Block Diagram (Option 002)



## Safety and Information

### Introduction

Review this product and related documentation to familiarize yourself with safety markings and instructions before you operate the instrument.

This product has been designed and tested in accordance with accepted industry standards, and has been supplied in a safe condition. The documentation contains information and warnings that must be followed by the user to ensure safe operation and to maintain the product in a safe condition.

### Safety Earth Ground

#### **WARNING**

This is a Safety Class I Product (provided with a protective earthing ground incorporated in the power cord). The mains plug shall only be inserted in a socket outlet provided with a protective earth contact. Any interruption of the protective conductor inside or outside of the product is likely to make the product dangerous. Intentional interruption is prohibited.

---

#### **CAUTION**

Always use the three prong AC power cord supplied with this product. Failure to ensure adequate earth grounding by not using this cord may cause product damage and the risk of electrical shock.

---

### Statement of Compliance

This product has been designed and tested in accordance with accepted industry standards, and has been supplied in a safe condition. The documentation contains information and warnings that must be followed by the user to ensure safe operation and to maintain the product in a safe condition.

## Before Applying Power

Verify that the premises electrical supply is within the range of the instrument. The instrument has an autoranging power supply.

### WARNING

If this product is not used as specified, the protection provided by the equipment could be impaired. This product must be used in a normal condition (in which all means for protection are intact) only

---

### CAUTION

The Mains wiring and connectors shall be compatible with the connector used in the premise electrical system. Failure, to ensure adequate earth grounding by not using the correct components may cause product damage, and serious injury.

---

### CAUTION

Always use the three prong AC power cord supplied with this product. Failure to ensure adequate earth grounding by not using this cord may cause product damage and the risk of electrical shock.

---

### CAUTION

This product is designed for use in Installation Category II and Pollution Degree.

---

### CAUTION

Before switching on this instrument, make sure the supply voltage is in the specified range.

---

### CAUTION

Verify that the premise electrical voltage supply is within the range specified on the instrument.

---

### CAUTION

Ventilation Requirements: When installing the instrument in a cabinet, the convection into and out of the instrument must not be restricted. The ambient temperature (outside the cabinet) must be less than the maximum operating temperature of the instrument by 4 °C for every 100 watts dissipated in the cabinet. If the total power dissipated in the cabinet is greater than 800 watts, forced convection must be used.

---

**WARNING**

Danger of explosion if battery is incorrectly replaced. Replace only with the same or equivalent type recommended. Discard used batteries according to manufacturer's instructions.

---

**WARNING**

For continued protection against fire hazard replace line fuse only with same type and rating. The use of other fuses or material is prohibited.

---

**WARNING**

These servicing instructions are for use by qualified personnel only. To avoid electrical shock, do not perform any servicing unless you are qualified to do so

---

**WARNING**

The opening of covers or removal of parts is likely to expose the user to dangerous voltages. Disconnect the instrument from all voltage sources before opening.

---

**WARNING**

No operator serviceable parts inside. Refer servicing to qualified personnel. To prevent electrical shock, do not remove covers.

---

**WARNING**

The detachable power cord is the instrument disconnecting device. It disconnects the mains circuits from the mains supply before other parts of the instrument. The front panel switch is only a standby switch and is not a LINE switch (disconnecting device)

---

## Connector Care and Cleaning Precautions

Remove the power cord to the instrument. To clean the connectors use alcohol in a well ventilated area. Allow all residual alcohol moisture to evaporate, and fumes to dissipate prior to energizing the instrument.

**WARNING**

To prevent electrical shock, disconnect the Keysight **N5280A** from mains electrical supply before cleaning. Use a dry cloth or one slightly dampened with water to clean the external case parts. Do not attempt to clean internally.

---

**WARNING**

If flammable cleaning materials are used, the material shall not be stored, or left open in the area of the equipment. Adequate ventilation shall be assured to prevent the combustion of fumes, or vapors.















---



## Regulatory Information

This section contains information that is required by various government regulatory agencies.

### Instrument Markings

|   |   |
|---|---|
|    | The instruction documentation symbol. The product is marked with this symbol when it is necessary for the user to refer to the instructions in the documentation.   |
|    | The AC symbol indicates the required nature of the line module input power.   |
|    | This symbol indicates separate collection for electrical and electronic equipment, mandated under EU law as of August 13, 2005. All electric and electronic equipment are required to be separated from normal waste for disposal (Reference WEEE Directive, 2002/96/EC). |
|    | This symbol indicates that the power line switch is ON.   |
|    | This symbol indicates that the power line switch is in the STANDBY position.  |
|    | This symbol indicates that the power line switch is in the OFF position.  |
|   | This symbol is used to identify a terminal which is internally connected to the product frame or chassis.   |
|  | The CSA mark is a registered trademark of the CSA International.  |
|  | This mark designates the product is an Industrial Scientific and Medical Group 1 Class A product (reference CISPR 11, Clause 5)   |
|  | This is a marking to indicate product compliance with the Canadian Interference-Causing Equipment Standard (ICES-001).  |
|  | Direct Current.   |
| IP 2 0  | The instrument has been designed to meet the requirements of IP 2 0 for ingress and operational environment.  |
|  | The RCM mark is a registered trademark of the Australian Communications and Media Authority   |
|  | Indicates the time period during which no hazardous or toxic substance elements are expected to leak or deteriorate during normal use. Forty years is the expected useful life of the product.  |
|  | This symbol on all primary and secondary packaging indicates compliance to China standard GB 18455-2001.  |
|  | South Korean Certification (KC) mark; includes the marking's identifier code which follows the format: MSIP-REM-YYY-ZZZZZZZZZZZZZZ.   |

N5280A  
Regulatory Information

## Battery

Do not throw batteries away but collect as small chemical waste, or in accordance with your country's requirements. You may return the battery to Keysight Technologies for disposal. Refer to **“Contacting Keysight” on page 54** for assistance.

## EMC

Complies with the essential requirements of the European EMC Directive as well as current editions of the following standards (dates editions are cited in the Declaration of Conformity):

- IEC/EN 61326-1
- CISPR Pub 11 Group 1, class A
- AS/NZS CISPR 11
- ICES/NMB-001  
This ISM device complies with Canadian ICES-001.  
Cet appareil ISM est conforme a la norme NMB-001 du Canada.

## South Korean Class A EMC Declaration

This equipment is Class A suitable for professional use and is for use in electromagnetic environments outside of the home.

A 급 기기 ( 업무용 방송통신기자재 ) 이 기기는 업무용 ( A 급 ) 전자파적합 기기로서 판매자 또는 사용자는 이 점을 주의하시기 바라 며 , 가정외의 지역에서 사용하는 것을 목적으로 합니다 .

## Safety

Complies with the essential requirements of the European Low Voltage Directive as well as current editions of the following standards (dates and editions are cited in the Declaration of Conformity):

- IEC/EN 61010-1
- Canada: CSA C22.2 No. 61010-1
- USA: UL std no. 61010-1

## Acoustic Statement (European Machinery Directive):

- Accoustical noise emission  
LpA<70 dB  
Operator position  
Normal operation mode Per ISO 7779

## Declaration of Conformity

To find a current Declaration of Conformity for specific Keysight product, go to:  
<http://regulations.about.keysight.com/DoC/search.htm>

## Electrostatic Discharge Protection

Electrostatic discharge (ESD) can damage or destroy electronic components. The product is shipped in materials that prevent damage from static, and should only be removed from the packaging in an anti-static area ensuring that the correct anti-static precautions are taken.

Two types of ESD protection are listed below. Purchase acceptable ESD accessories from your local supplier.

- Conductive table-mat and wrist-strap combination
- Conductive floor-mat and heel-strap combination

Both types, when used together, provide a significant level of ESD protection. To ensure user safety, static-safe accessories must provide at least 1 M $\Omega$  of isolation from ground.

### **WARNING**

**These techniques for a static-safe work station should not be used when working on circuitry with a voltage potential greater than 500 volts.**

---

## Keysight Support, Services, and Assistance

### Service and Support Options

There are many other repair and calibration options available from the Keysight Technologies support organization. These options cover a range of service agreements with varying response times. Contact Keysight for additional information on available service agreements for this product.

### Contacting Keysight

Assistance with test and measurement needs, and information on finding a local Keysight office are available on the Internet at:

<http://www.keysight.com/find/assist>

If you do not have access to the Internet, contact your field engineer.

#### NOTE

In any correspondence or telephone conversation, refer to the Keysight product by its model number and full serial number. With this information, the Keysight representative can determine the warranty status of your unit.

---

### Shipping Your Product to Keysight for Service or Repair

#### NOTE

Keysight Technologies reserves the right to reformat or replace the internal hard disk drive in your analyzer as part of its repair. This will erase all user information stored on the hard disk. It is imperative, therefore, that you make a backup copy of your critical test data located on the analyzer's hard disk before shipping it to Keysight for repair.

---

If you wish to send your instrument to Keysight Technologies for service or repair:

- Include a complete description of the service requested or of the failure and a description of any failed test and any error message.
- Remove and retain the front handles and all rack mount hardware. The analyzer should be sent to Keysight in the same configuration as it was originally shipped.
- Remove and retain the front handles and all rack mount hardware. The analyzer should be sent to Keysight in the same configuration as it was originally shipped.
- Contact Keysight for instructions on where to ship your analyzer.





This information is subject to change without notice.  
© Keysight Technologies 2008 – 2017  
Edition 1: June 2017  
Supersedes: August 2015



N5280-90001

[www.keysight.com](http://www.keysight.com)