



**KIKUSUI**

Part No. IB032834  
Sep 2019

# User's Manual

PCR-MA Series AC Power Supply

**PCR500MA**

**PCR1000MA**

**PCR2000MA**

**PCR4000MA**

Contents 6

Component Names 8

Installation 11

Operation 22

Maintenance 47

Specifications 50

Appendix 61

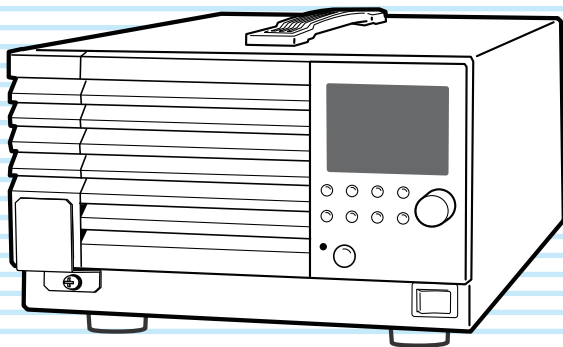







## About Manuals

These manuals provide an overview of the product and notes on usage. They also explain how to configure it, operate it, perform maintenance on it, and so on. Read these manuals thoroughly before use, and use the product properly.

### Intended readers

These manuals are intended for users of the product or persons teaching other users on how to operate the product. The manuals assume that the reader has knowledge about power supplies.

### Manual construction

- User's manual  (this manual)  
This document is intended for first-time users of this product. It provides an overview of the product, notes on usage, and specifications. It also explains how to connect the product, configure the product, operate the product, perform maintenance on the product, and so on.
- Communication Interface Manual  (partially in PDF)  
This document contains details about remote control. Interface manual is written for readers with sufficient basic knowledge of how to control measuring instruments using a personal computer.
- Quick Reference    
This document briefly explains the control panel and the basic operation of it.
- Safety Information    
This document contains general safety precautions. Keep them in mind and make sure to observe them.

PDF and HTML files are included in the accompanying CD-ROM. You can view the PDF files using Adobe Reader. Microsoft Internet Explorer or Google Chrome is required to view the HTML files.

The latest manual can be downloaded from the Kikusui website.

### Firmware versions that this manual covers

This document covers firmware versions 2.0X. For information on how to check the current firmware version, see "Turning the power on" ([p.15](#)).

When contacting us about the product, please provide us with:

- The model (marked in the top section of the front panel)
- Firmware version ([p.15](#))
- The serial number (marked on the rear panel)

## Trademarks

Microsoft is a registered trademark or trademark of Microsoft Corporation in the United States and/or other countries.

Other company names and product names used in this manual are generally trademarks or registered trademarks of the respective companies.

## Copyright

Reproduction and reprinting of this manual, whole or partially, without our permission is prohibited.

Both unit specifications and manual contents are subject to change without notice.

© Copyright 2018 Kikusui Electronics Corporation

## Accessories

For the PCR500MA (1 pc., cable length: 2.5 m)

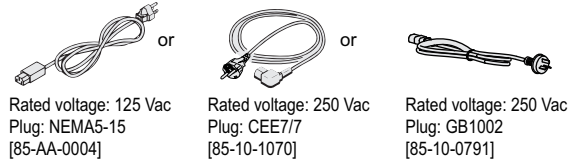

Rated voltage: 125 Vac  
Plug: NEMA5-15  
[85-AA-0004]

Rated voltage: 250 Vac  
Plug: CEE7/7  
[85-10-1070]

Rated voltage: 250 Vac  
Plug: GB1002  
[85-10-0791]

For the PCR1000MA (1 pc.)

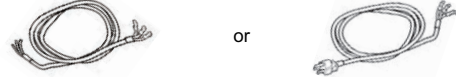

Cable length: approx. 3 m,  
thickness: 3.5 mm<sup>2</sup>  
[85-10-0630]

Plug: NEMA5-15  
Cable length: approx. 2.8 m,  
thickness: 2 mm<sup>2</sup>  
[85-10-0650]

The power cord with a plug can be used when the nominal supply voltage is in the range of 114 Vac to 125 Vac.

For the PCR2000MA  
(1 set, cable length: approx. 3 m,  
thickness: 5.5 mm<sup>2</sup>)

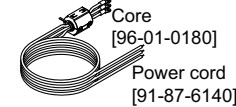

Core  
[96-01-0180]

Power cord  
[91-87-6140]

For the PCR4000MA  
(1 set, cable length: approx. 3 m,  
thickness: 14 mm<sup>2</sup>)



[91-87-6151]

- Power cord (The power cord for the PCR500MA and PCR1000MA varies depending on the shipment destination.)



- Cable tie (1 pc.)  
[P4-200-001]



- Core (1 pc.)  
[96-01-0180]

- Packing List  
(1 pc.)

- Quick Reference  
(Japanese 1 sheet,  
English 1 sheet)

- Safety Information (1 copy)

- CD-ROM (1 disc)

- Heavy object warning label (1 pc.)  
If necessary, attach to the product.  
Included only with the PCR4000MA [A8-900-154]

## Product Overview

This AC power supply is a refined version of the PCR-M series. While maintaining the compactness of the PCR-M series, the output voltage range has been expanded, and additional functions such as a LAN interface and sensing have been added. As with the previous product, there are four models depending on the output capacity: 500 VA, 1000 VA, 2000 VA, and 4000 VA.

### Features

The PCR-MA Series is equipped with the following functions.

#### Wide-range variable output voltage and frequency

The output voltage and frequency can be set over a wide range (310 Vrms max.). The nominal voltages (single phase) of various countries are supported. It can be used for testing power supplies installed in aircrafts, ships, and the like.

#### DC output

DC output (rating: 438 Vdc) is possible. DC voltage can be superimposed on AC voltage by using the optional analog interface board.

#### High-speed communication interface

LAN and USB interfaces are standard equipped. GPIB can also be supported by using an optional interface board.

#### Sensing function

Voltage drop in load cables can be corrected.

#### Compact, lightweight

The product employs a PWM inverter system, making the product compact and lightweight. Compared to a linear type AC power supply, the size is about 1/5, and the weight is about 1/4 (compared to our PCR500MA).

#### Memory function

Settings can be saved. Settings in memories can be recalled while the output is turned on. This allows tests with sudden voltage or frequency changes. Three memory areas are available from the panel while up to 11 memory areas are available through remote control.

#### Measurement function

Voltage, current, and power of AC and DC output can be monitored. For the output voltage, the true rms value and average value (DC) can be displayed. For the output current, the true rms value, peak value, and average value (DC) can be displayed.

#### Maximum peak current

Maximum peak current of up to three times the maximum rated current (rms value) can be output to a capacitor-input rectifier load.

#### PCR-M compatible mode

This mode makes it possible to use programs created for the conventional PCR-M series to be used on the PCR-MA series without making changes to the programs.

## Notations Used in This Manual

- In this manual, AC power supplies PCR500MA, PCR1000MA, PCR2000MA, and PCR4000MA are sometimes referred to as the PCR-MA.
- The term “PC” is used to refer generally to both personal computers and workstations.
- The screen captures and illustrations used in this text may differ from the actual items.
- The following markings are used in this manual.

### **WARNING**

Indicates a potentially hazardous situation which, if ignored, could result in death or serious injury.

### **CAUTION**

Indicates a potentially hazardous situation which, if ignored, may result in damage to the product or other property.

### **NOTE**

Indicates information that you should know.

## Safety Precautions

When installing this product, be sure to observe the precautions provided in the Safety information manual. Items specific to this product are given below.

## Precautions When Choosing the Installation Location

When installing this product, be sure to observe the “Precautions When Choosing the Installation Location” in the Safety information manual. Items specific to this product are given below.

- When installing this product, be sure to observe the temperature and humidity ranges indicated below.  
Operating temperature range: 0 °C to 40 °C  
Operating humidity range: 20 %rh to 80 %rh (no condensation)
- When storing this product, be sure to observe the temperature and humidity ranges indicated below.  
Storage temperature range: -10 °C to 60 °C  
Storage humidity range: 90 %rh or less (no condensation)
- Do not install the product vertically.  
It may cause injury to the operator or damage to the product when it falls down.

This page is intentionally blank.

# Contents

About Manuals.....	2
Accessories .....	3
Product Overview .....	3
Notations Used in This Manual.....	4
Safety Precautions .....	4
Precautions When Choosing the Installation Location .....	4
Component Names.....	8

## Installation

Connecting the Power Cord (PCR500MA).....	11
Connecting the Power Cord (PCR1000MA to PCR4000MA)12	
Connecting to the AC INPUT terminal block.....	13
Turning the Power On or Off .....	15
Turning the power on .....	15
Turning the power off .....	16
Connecting the Load .....	17
Connecting to the OUTPUT terminal block.....	17
Connecting to the front-panel outlet.....	21

## Operation

Switching the Output Mode .....	22
Voltage Range Setting.....	23
Voltage Setting .....	24
Frequency Setting .....	25
Turning the Output On/Off.....	26
Measurement Display.....	27
Setting Limits.....	28
Memory Usage .....	30
Saving to memory .....	30
Recalling from memory .....	31
Locking the Panel Controls.....	32
Protection Functions.....	33
Clearing alarm and error .....	34
CONFIG Settings.....	36
Displaying and setting CONFIG parameters.....	38
Sensing.....	40
Connecting sensing cables .....	40
Turning the sensing function on and off.....	41

Remote Control .....	42
Control Using External Analog Signals (Option)43	
Controlling the voltage of the output AC waveform using DC signals (EXT-AC mode) .....	44
Amplifying the input waveform (EXT-DC mode) ...	45

## Maintenance

Inspection.....	47
Overhaul .....	47
Calibration.....	47
Cleaning .....	48
Cleaning the dust filter .....	48

## Specifications

Input rating .....	50
Output rating AC mode .....	51
Output rating DC mode .....	51
Output voltage stability.....	52
Output frequency stability, output voltage waveform distortion ratio, output voltage response speed, efficiency, sensing function .....	52
Indicators .....	53
Setting range limit function.....	54
General .....	55
Common interface specifications.....	56
LAN interface .....	56
USB interface.....	56
GPIB interface (option IB22).....	56
Analog interface (option EX08-PCR-MA).....	57
External dimensions.....	58

## Appendix

Output and Load.....	61
Rated output current in AC mode .....	61
Rated output current in DC mode .....	63
Operating Characteristics.....	64
Overload Protection Function.....	66
Terminology.....	68
Options .....	71
Interface boards.....	71
Rack-mount frames and brackets .....	72

Factory Default Settings (Initialization).....	76
Troubleshooting.....	78
Index.....	81

# Component Names

## Front panel

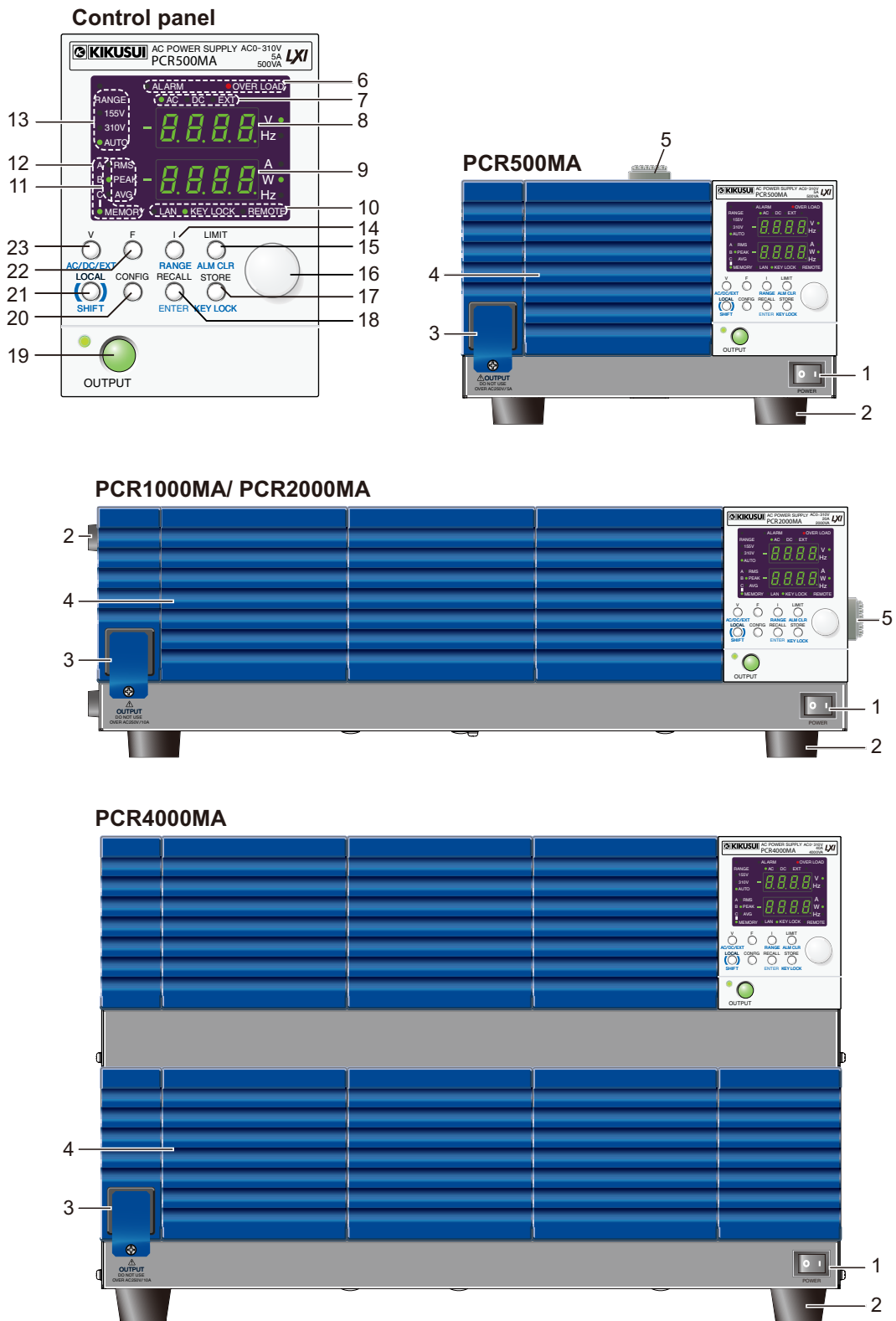



No.	Name	Function	See
1	POWER	Flip the switch to the (I) side to turn the power on. Flip it to the (O) side to turn the power off.	<a href="#">p.15</a>
2	Feet	PCR500MA/ PCR4000MA: 4 locations on the bottom panel. PCR1000MA/ PCR2000MA: 4 locations on the bottom panel, 4 locations on the side panel.	<a href="#">p.73</a>
3	Outlet	Front outlet (with cover).	<a href="#">p.21</a>
4	Air inlet	Air inlet for cooling with dust filters.	<a href="#">p.48</a>
5	Handle	Handle for carrying.	<a href="#">p.73</a>
6	ALARM/OVER LOAD	Lights when an alarm or overload occurs.	<a href="#">p.34</a>
7	AC/DC/EXT	The selected mode (AC, DC, or EXT) lights.	<a href="#">p.22</a>
8	Top numeric display	Displays voltage or frequency.	<a href="#">p.24</a> , <a href="#">p.25</a> , <a href="#">p.27</a>
9	Bottom numeric display	Displays current or power. Displays frequency when memory is in use.	<a href="#">p.27</a> , <a href="#">p.30</a>
10	LAN	Lights and blinks when the LAN interface is running. Green: no fault status, Red: fault status, Orange: standby status, Blinking green: identify status.	—
	KEY LOCK	Lights when the keys are locked.	<a href="#">p.32</a>
	REMOTE	Lights in remote mode.	<a href="#">p.42</a>
11	RMS/PEAK/AVG	Rms value (RMS), peak value (PEAK), or average value (AVG) lights according to the type of value shown on the numeric display.	<a href="#">p.27</a>
12	MEMORY	The selected memory area (A, B, or C) lights. MEMORY lights when settings are being saved and blinks when they are being recalled.	<a href="#">p.30</a>
13	RANGE	The selected voltage range (155 V, 310 V, or AUTO) lights.	<a href="#">p.23</a>
14	I	Selects the type of value to show in the bottom numeric display (RMS, PEAK, AVG, or W).	<a href="#">p.27</a>
	RANGE	Voltage range setting.	<a href="#">p.23</a>
15	LIMIT	Sets the limit. The key lights when pressed.	<a href="#">p.28</a>
	ALM CLR	Clears alarms.	<a href="#">p.34</a>
16	Rotary knob	Changes values.	—
17	STORE	Memory storage (memory areas A, B, or C).	<a href="#">p.30</a>
	KEY LOCK	Key lock.	<a href="#">p.32</a>
18	RECALL	Memory recall.	<a href="#">p.31</a>
	ENTER	Confirms a memory recall or storage.	—
19	OUTPUT	Turns output on and off.	<a href="#">p.26</a>
20	CONFIG	CONFIG settings.	<a href="#">p.36</a>
21	LOCAL	Switches to local mode.	<a href="#">p.42</a>
	SHIFT	SHIFT key.	—
22	F	Sets the frequency. The key lights when pressed.	<a href="#">p.25</a>
23	V	Sets the voltage. The key lights when pressed.	<a href="#">p.24</a>
	AC/DC/EXT	Selects the output mode.	<a href="#">p.22</a>



Pinch the rotary knob with your fingers to turn it. Turning it rapidly may cause it to malfunction.

## Rear Panel

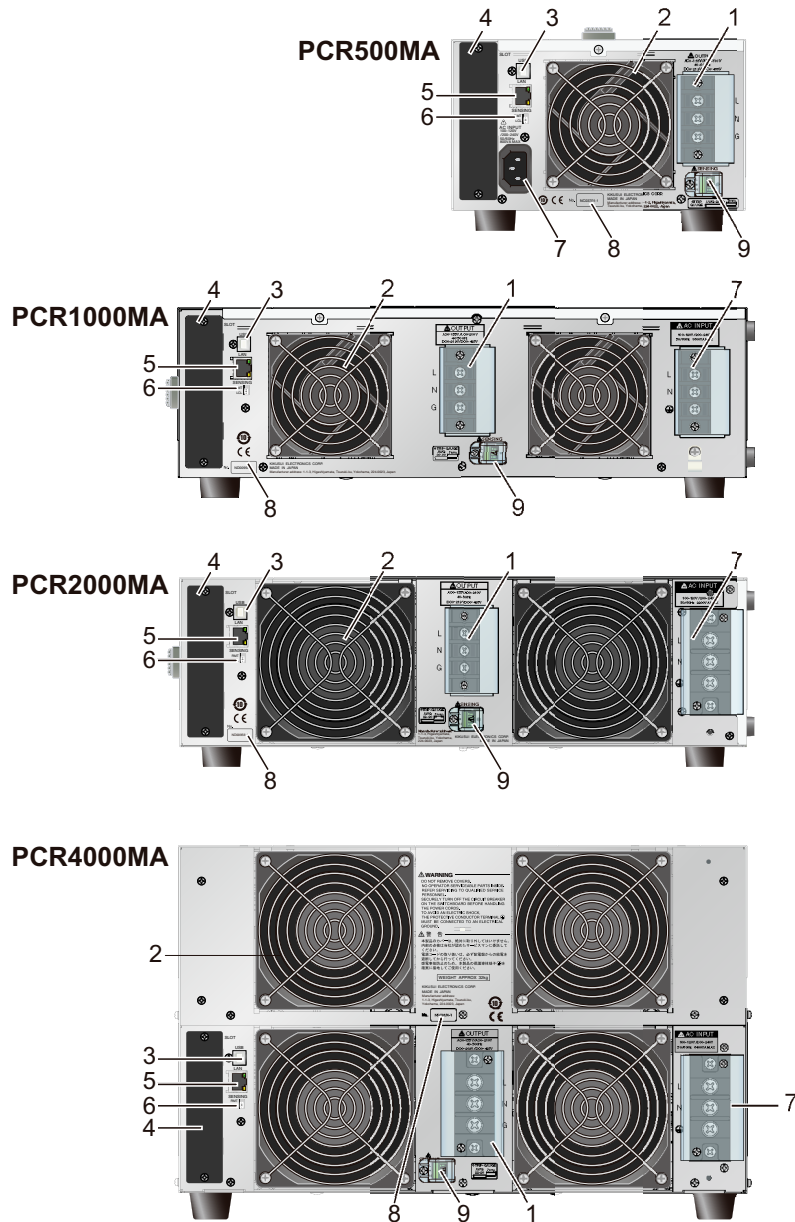

No.	Name	Function	See
1	OUTPUT terminal block	Rear-panel output terminal block (with a cover).	<a href="#">p.17</a>
2	Air outlet	Vent for cooling the <series name>.	—
3	USB	USB remote control port.	—
4	Option slot	Where an option board is installed.	<a href="#">p.71</a>
5	LAN	LAN remote control port.	—
6	SENSING switch	Sensing switch.	<a href="#">p.40</a>
7	AC INPUT	PCR500MA: AC inlet. PCR1000MA/PCR2000MA/PCR4000MA: IC INPUT Terminal block (with a cover).	<a href="#">p.11</a> , <a href="#">p.12</a>
8	Serial number	The product's serial number.	—
9	SENSING connector	Sensing cable connector (with a cover).	<a href="#">p.40</a>

# Installation

The included power cord varies depending on the PCR-MA model.

## Connecting the Power Cord (PCR500MA)

### **⚠ WARNING**

**Risk of electric shock.**

- **This product is IEC Safety Class I equipment (equipment with a protective conductor terminal). To prevent electric shock, be sure to connect the protective conductor terminal of the product to electrical ground (safety ground).**
- **The product is grounded through the power cord ground wire. Connect the protective conductor terminal to earth ground.**

### **⚠ CAUTION**

If the voltage distortion of the AC power line is large, the product may malfunction. The product cannot be connected to a generator or a similar device.

### **NOTE**

- Use the supplied power cord to connect to the AC line.  
If the supplied power cord cannot be used because the rated voltage or the plug shape is incompatible, have a qualified engineer replace it with an appropriate power cord that is 3 m or less in length. If obtaining a power cord is difficult, contact your Kikusui agent or distributor.
- The power cord with a plug can be used to disconnect the product from the AC power line in an emergency.
- Secure adequate space around the power plug. Do not insert the power plug to an outlet where accessibility to the plug is poor. And, do not place objects near the outlet that would result in poor accessibility to the plug.
- Do not use the supplied power cord with other instruments.

This product is designed as an equipment of IEC Overvoltage Category II (energy-consuming equipment supplied from a fixed installation).

**1 Turn off (○) the POWER switch on the front panel.**

**2 Check that the AC power line meets the nominal input rating of the product.**

The product can receive a nominal power supply voltage in the range of 100 Vac to 120 Vac or 200 Vac to 240 Vac at a frequency of 50 Hz or 60 Hz. (Frequency range: 47 Hz to 63 Hz)

**3 Connect the power cord to the AC INPUT inlet on the rear panel.**

**4 Connect the power cord plug to a properly grounded outlet.**

This completes the setting.

	PCR500MA
Protective conductor current <sup>1, 2</sup>	1 mA
Inrush current <sup>2</sup>	58 Amax

\*1 A current which flows through the protective conductor (ground wire).

\*2 At 264 V/60 Hz

## Connecting the Power Cord (PCR1000MA to PCR4000MA)

### **⚠ WARNING**

#### Risk of electric shock.

- This product is IEC Safety Class I equipment (equipment with a protective conductor terminal). To prevent electric shock, be sure to connect the protective conductor terminal of the product to electrical ground (safety ground).
- The product is grounded through the power cord ground wire. Connect the protective conductor terminal to earth ground.
- Turn off the circuit breaker of the switchboard before you connect the power cord.
- Do not use the terminal block with the terminal cover removed.

#### Risk of electric shock or fire.

- The circuit breaker of the switchboard that the product will be connected to must meet the requirements shown below.
- Have a qualified engineer connect the power cord to the switchboard.

### **⚠ CAUTION**

- If the voltage distortion of the AC power line is large, the product may malfunction. The product cannot be connected to a generator or a similar device.
- Inside the product, protective circuits such as input fuses are connected to match the polarity of the input terminal. Be sure to connect the power cord correctly by matching the colors of the wires and input terminals (L, N, and ⊕(GND)).

### **NOTE**

In an emergency, turn off the switchboard breaker to separate the product from the AC power line.

This product is designed as an equipment of IEC Overvoltage Category II (energy-consuming equipment supplied from a fixed installation).

### Switchboard breaker requirements

- Rated current:  
For safety reasons, circuit breakers that exceed the current shown below cannot be used.  
PCR1000MA: 20 A or less, PCR2000MA: 40 A or less, PCR4000MA: 80 A or less
- Only use the breaker with this product.
- Keep the breaker readily accessible at all times.
- Indicate that the circuit breaker is dedicated for use with this product and that it is used to disconnect the product from the AC power line.

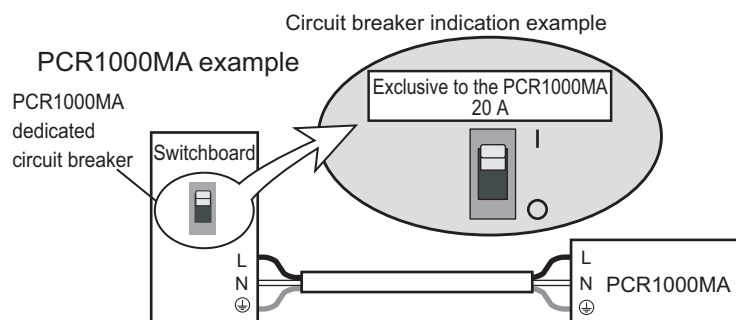

	PCR1000MA	PCR2000MA	PCR4000MA
Protective conductor current <sup>1, 2</sup>	1.4 mA	1 mA	2.2 mA
Inrush current <sup>2</sup>	104 Amax	58 Amax	128 Amax

- 1 A current which flows through the protective conductor (ground wire).
- 2 At 264 V/60 Hz

## Connecting to the AC INPUT terminal block

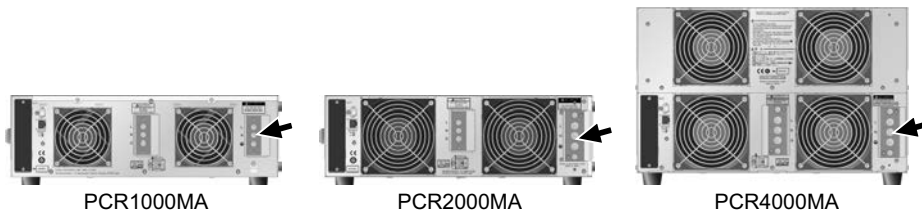

- 1** Turn off (O) the POWER switch on the front panel.
- 2** Check that the AC power line meets the nominal input rating of the product.

The product can receive a nominal power supply voltage in the range of 100 Vac to 120 Vac or 200 Vac to 240 Vac at a frequency of 50 Hz or 60 Hz. (Frequency range: 47 Hz to 63 Hz)

- 3** Remove the terminal cover from the AC INPUT terminal block.

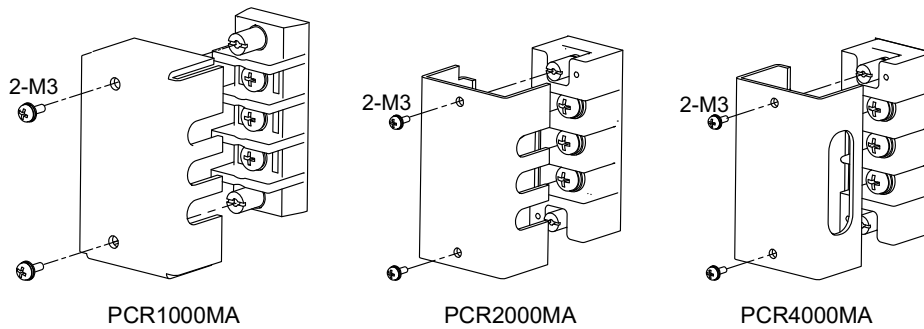

**4** Connect the power cord according to the indications on the AC INPUT terminal block.

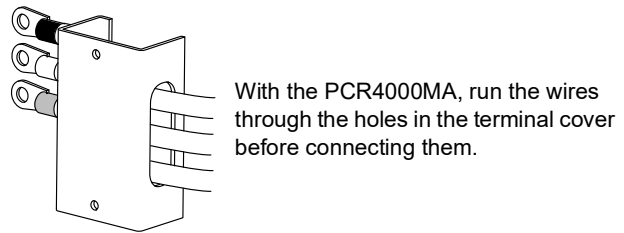
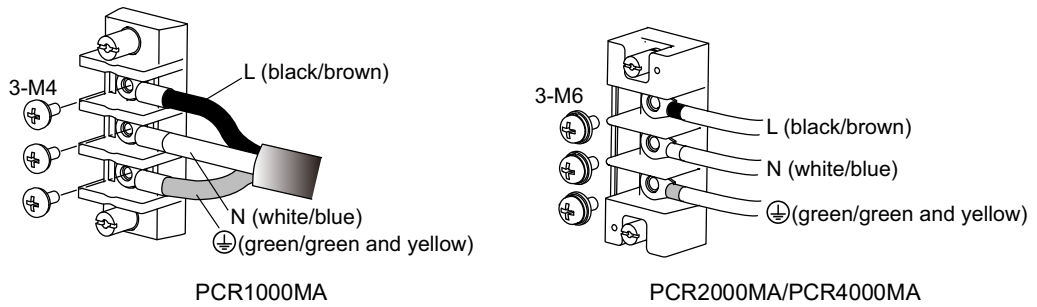

**5** Attach the terminal cover that you removed in step 3.

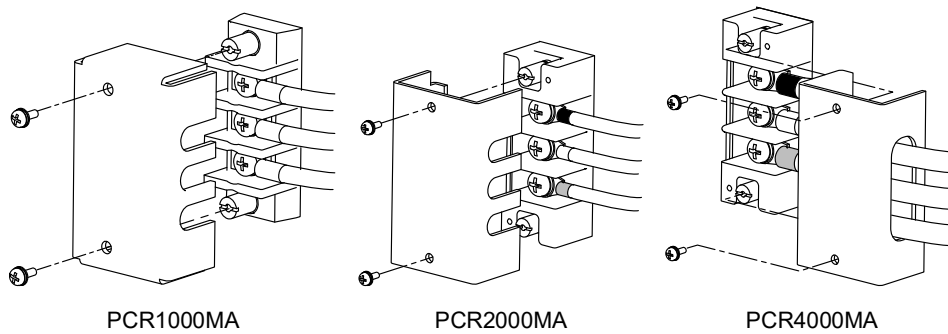

**6** Attach a crimping terminal to the switchboard end of the power cord.

No termination is provided on the switchboard end of the included power cord. To terminate it, attach crimping terminals or the like that are compatible with the screws of the switchboard that you are connecting to. Have a qualified engineer perform the work.

**7** Turn off the switchboard's circuit breaker.

**8** Connect the power cord according to the indication on the switchboard.

**9** Turn on the switchboard's breaker.

# Turning the Power On or Off

## Turning the power on

- 1 Check that the power cord is connected correctly.
- 2 Check that nothing is connected to the OUTPUT terminal block on the rear panel and the outlets on the front panel.
- 3 Turn the POWER switch on (I).

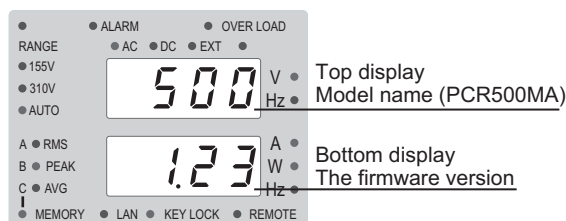

Firmware version check (example of a PCR500MA with firmware version Ver.1.23)

If the POWER switch is turned on for the first time after purchase, the product starts with factory default settings. For all other cases, the product starts up in the condition it was in the POWER switch was turned off the last time. You can use the CONFIG settings to set the state that the product is in when you turn the POWER switch on ([p.36](#)).

If the ALARM LED lights or an error number is displayed, see "Protection Functions" ([p.33](#)).

## Turning the power off

---

Press the (O) side of the POWER switch to turn the power off.

---

**⚠ CAUTION**

- If you want to turn the POWER switch back on, wait at least 5 seconds after the fan stops. Repeatedly turning the POWER switch on and off at short intervals will shorten the service life of the POWER switch and the internal input fuse.
- 

The product saves following settings at 5 second intervals. When the POWER switch is turned on, these items take on the values that were in use the last time that the POWER switch was turned off.

Output voltage and frequency settings

Output voltage range (155 V, 310 V, AUTO)

Output voltage, frequency, and current limit values, limit action setting

Output mode (AC, DC, EXT)

Measurement display (RMS, PEAK, AVG, W)

Panel control lock

CONFIG settings

The output on/off state is not stored. The product always starts up with the output turned off.

If the POWER switch is turned off immediately after the settings have been changed, the last settings may not be stored.



# Connecting the Load

The maximum current that the product can generate varies depending on the model. It also varies depending on the product's voltage mode, load type, and status. Ensure that the output power capacity is sufficient for the load capacity.

## Connecting to the OUTPUT terminal block

### Preparing load cables

Use noncombustible wires that have diameters that correspond to the output current to connect to the load.

#### ■ Requirements of single-core wires that are used to connect to the load

Nominal cross-sectional area (mm <sup>2</sup> )	AWG (reference cross-sectional area; mm <sup>2</sup> )	Allowable current <sup>1</sup> (A) (Ta = 30°C)	Kikusui-recommended current (A)
0.9	18 (0.82)	17	4
1.25	16 (1.31)	19	6
2	14 (2.08)	27	10
3.5	12 (3.31)	37	-
5.5	10 (5.26)	49	20
8	8 (8.37)	61	30
14	6 (13.3)	88	50

1 \* Excerpt from Japanese laws related to electrical equipment.

The values vary depending on conditions such as the wire covering (insulator), the wire material (allowable temperature), and whether there are multiple cores in the cable. For cables other than those specified in this table, consult with a qualified engineer.



#### **Risk of electric shock.**

- Use load cables whose capacity is adequate for the product's rated output current.
- The rated voltage of the load cables must be at least the product's isolation voltage (438 Vdc).
- Before you connect cables to the OUTPUT terminal block, be sure to turn the POWER switch off, and then remove the power plug from the outlet or turn off the switchboard.

#### **NOTE**

- The L and N terminals of the OUTPUT terminal block are isolated from the input power supply. The polarity does not constitute a problem in terms of safety. You can use either L or N to ground the product.
- In DC mode and AC+DC mode, N is the reference. When N has a positive polarity, L is positive electric potential. When N has a negative polarity, L is negative electric potential.
- When the POWER switch is on, even if the output is off, a dangerous voltage exists between the output terminal (L or N) and the chassis (G: ground). To eliminate the voltage between the output terminal and the chassis, connect N and G of the OUTPUT terminal block.

## Connecting the cables

**⚠ WARNING** Risk of electric shock. Do not use the terminal block with the terminal cover removed.

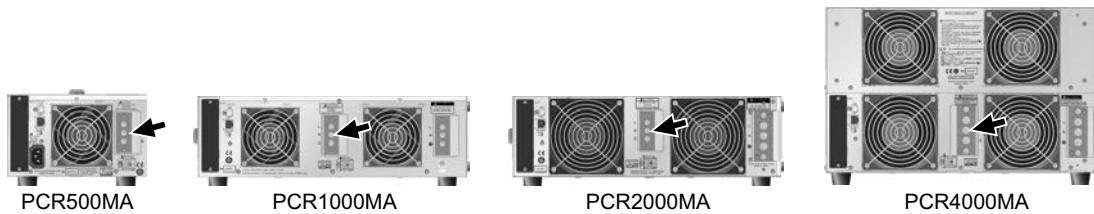

- 1** Turn the **POWER** switch off (○).
- 2** Check that the power cord is disconnected from the outlet or that the switchboard breaker is off.
- 3** Remove the terminal cover from the **OUTPUT** terminal block.

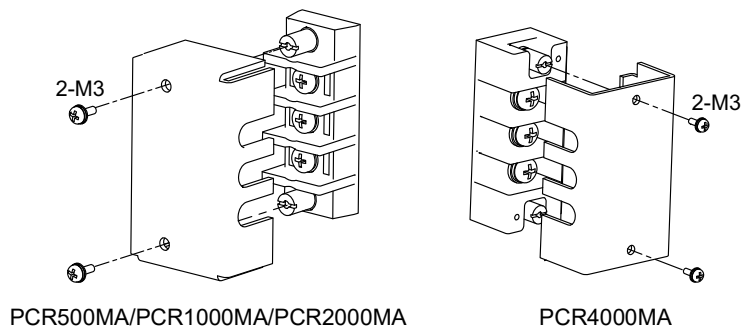

- 4** Securely connect the load cables to the **OUTPUT** terminal block.

If the load has a ground (GND) terminal, be sure to connect it to the G terminal of the product's OUTPUT terminal block. Be sure to use a wire whose diameter is greater than or equal to the diameter of the wires used to connect the load.

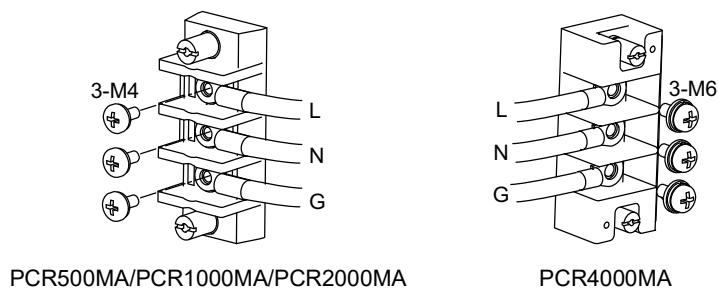

## 5 Attach the terminal cover that you removed in step 3.

Twist the load cables (L and N), and connect between the output terminal and load with the shortest cables possible. If you cannot twist the cables, we recommend that you run the cables alongside each other and tie them together at several points with cable ties.

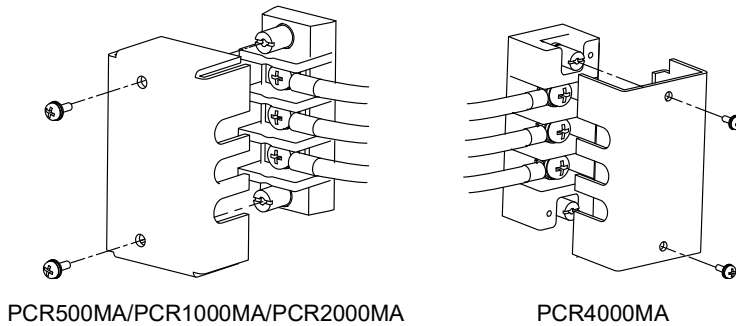

## Attaching a core

Attach a core to the load cables.

### 1 Unlock and open the core.

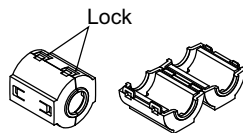

### 2 Attach the core, making sure not to pinch the cables.

Attach the core within 10 cm of the OUTPUT terminal block, and check that the core is locked securely.

### 3 Attach a cable tie to fix the position of the core.

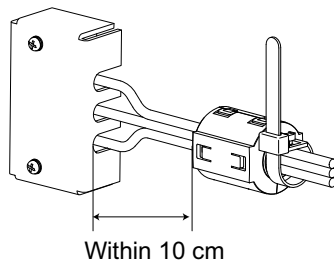

## When not using the OUTPUT terminal block

When you are not using the OUTPUT terminal block, attach the terminal cover.

## When the load is located at a remote location

Remote control can be used to turn the output off, but it cannot be used to turn the POWER switch off. If you want to connect the product to a load that is located at a remote location, install a switch between the OUTPUT terminal block and the load to prevent electric shock. Then, turn that switch off.



### **WARNING** Risk of electric shock.

- Before you install the switch between the OUTPUT terminal block and the load, be sure to turn the POWER switch off and remove the power plug from its outlet or turn off the breaker of the switchboard.
- The current rating of the switch must be at least the maximum current of the product.
- For the switch circuit, a two-pole type switch that can cut off the L and N wires simultaneously is required.
- Be sure to turn the switch off before connecting the load to the terminal at the load end of the switch.
- Do not touch the switch terminals when the POWER switch is on. Before connecting to the OUTPUT terminal block, be sure to turn the POWER switch off and remove the power plug from its outlet or turn off the switchboard breaker.

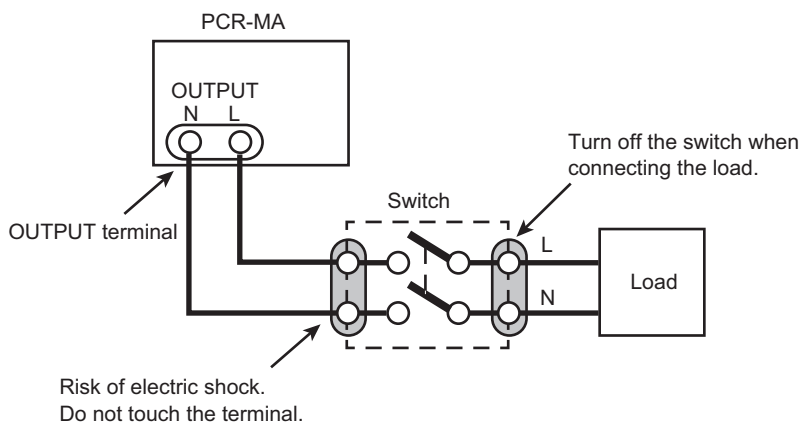

# Connecting to the front-panel outlet

The product can feed power from the OUTPUT terminal block on the rear panel and the outlet on the front panel. The specifications of the front-panel outlets are not regulated. Their performance may decrease.

**⚠ WARNING** Risk of electric shock. If you are not using the outlet, attach the outlet cover.

**⚠ CAUTION** Do not connect the load when the maximum rated voltage of the outlets has been exceeded or in DC mode. Risk of malfunction.

The outlets are designed for power plugs like those shown below.

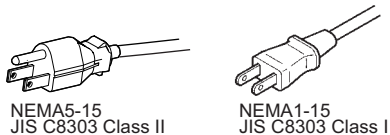

The following table shows the outlet ratings.

	PCR500MA	PCR1000MA	PCR2000MA	PCR4000MA
Max. rated voltage	250 Vac (rms)			
Max. rated current	5 Aac (rms)	10 Aac (rms)		

- 1 Check that the POWER switch is off.
- 2 Remove the outlet cover.

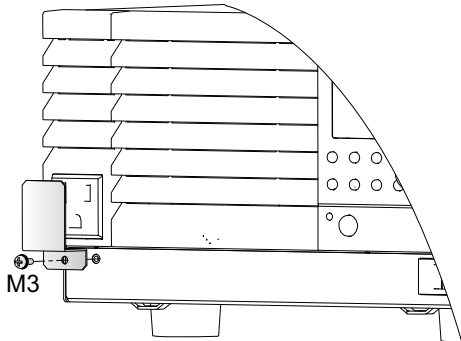

- 3 Connect the power cord of the load device to the outlet.

## Switching the Output Mode

You can select the output mode.

PCR-MA output mode

Output mode	LED that lights	Description
AC mode	AC	AC output.
DC mode	DC	DC output.
EXT-AC mode	AC, EXT	Outputs sine waves based on external DC signals (only when the analog interface board is installed).
EXT-DC mode	DC, EXT	Amplifies the waveforms that it receives and outputs the result (only when the analog interface board is installed).
AC+DC mode	AC, DC	Superimposes an AC on a DC and outputs the result (remote control only).

### NOTE

AC+DC mode is a function that superimposes a DC voltage on an AC voltage or AC voltage on a DC voltage. It can be used through the LAN, USB, or GPIB interface. For details, see the communication interface manual.

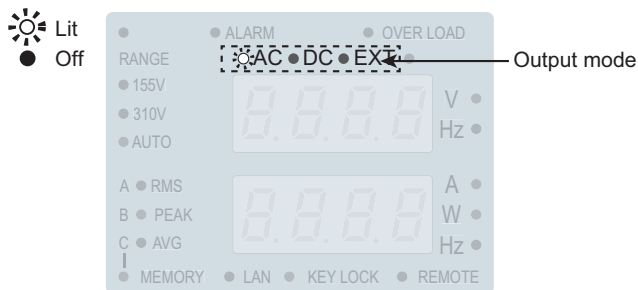
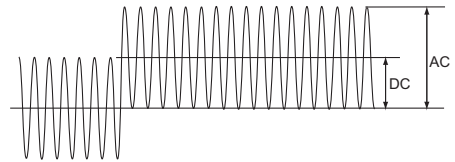

### 1 Press OUTPUT to turn output off.

The LED above and to the left of the OUTPUT key turns off.

### 2 Press AC/DC/EXT (SHIFT+V) to select the output mode.

The mode switches between AC and DC each time you press the key.

If the analog interface board is installed, the mode switches between AC, DC, EXT-AC, and EXT-DC.

The output mode LED lights according to the mode.

# Voltage Range Setting

You can select the voltage range. The available voltage ranges are 155 V, 310 V, and AUTO.

AUTO switches the range automatically between 155 V and 310 V.

AUTO cannot be selected in AC+DC, EXT-AC, or EXT-DC mode.

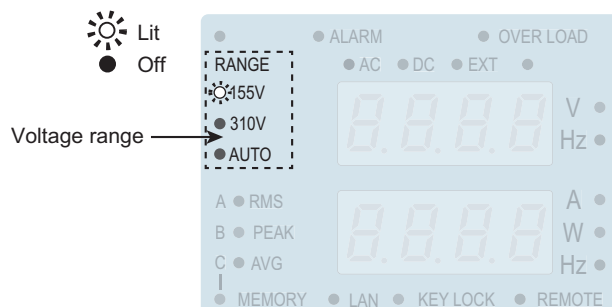

Voltage range and output voltage setting

Voltage range	Output voltage setting	
	AC mode	DC mode or AC+DC mode
155 V range	0.0 V to 157.5 V	-222.5 V to +222.5 V
310 V range	0.0 V to 315.0 V	-445 V to +445 V

Voltage range and maximum output current

Model	Voltage range	Output voltage setting	
		AC mode	DC mode or AC+DC mode
PCR500MA	155 V range	5 A	4 A
	310 V range	2.5 A	2 A
PCR1000MA	155 V range	10 A	8 A
	310 V range	5 A	4 A
PCR2000MA	155 V range	20 A	16 A
	310 V range	10 A	8 A
PCR4000MA	155 V range	40 A	32 A
	310 V range	20 A	16 A

## 1 Press OUTPUT to turn output off.

The LED above and to the left of the OUTPUT key turns off.

## 2 Press RANGE (SHIFT+I) to select the voltage range.

The range switches between 155 V, 310 V in AC mode, and AUTO each time you press the key. The LED corresponding to the range lights.

If you set a voltage exceeding the maximum value of the 155 V range when the range is set to 310 V or AUTO and you switch the range to 155 V, the output voltage will be set to 0.0 V.

# Voltage Setting

You can set the voltage regardless of whether the output is on or off.

If the voltage range is AUTO, the range switches automatically between 155 V or 310 V depending on the voltage setting. When the voltage range switches while the output is on, the output is turned off for about 0.5 seconds.

In DC mode, the factory default lower voltage limit is 0.0 V. Negative electric potential cannot be set unless you change this limit value.

In AC+DC mode, the voltage can be set only when the AC and DC voltage settings are within the voltage limit values and the peak value of the AC+DC waveform is within the -445 V to 445 V range.

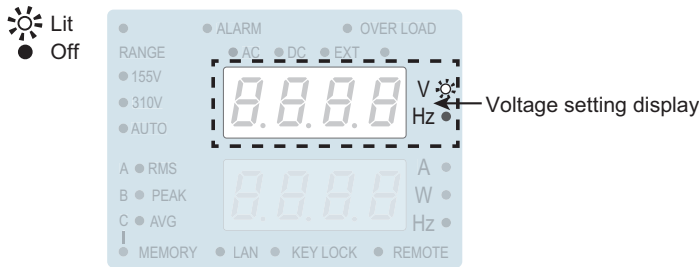

## 1 Press V.

The V key lights, and the voltage setting display appears.

## 2 Turn the rotary knob to set the voltage.

The top numeric display shows the voltage setting.

If the output is on, you can change the voltage setting (output voltage) by turning the rotary knob.

If the output is off, you can change the voltage setting by turning the rotary knob.

To display the voltage measurement, press V again. The V key turns off, and the voltage measurement appears.

Immediately after changing from the voltage setting display to the measurement display, you can change the output voltage by turning the rotary knob with the output turned on.

If you show another setting display and change to the measurement display, you cannot change the output voltage. In this case, press V again.

Range switching when the voltage range is AUTO

AC mode: Output voltage setting		
	0.0 V to 157.5 V	157.6 V to 315.0 V
Range	155 V	310 V

DC mode: Output voltage setting			
	-445.0 V to -222.6 V	-222.5 V to +222.5 V	222.6 V to 445.0 V
Range	310 V	155 V	310 V



# Frequency Setting

You can also set the frequency in AC mode or AC+DC mode. You can set the frequency while output is on or off.

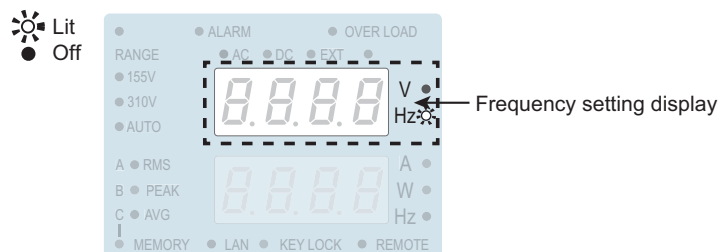

## 1 Press F.

The F key lights, and the frequency setting display appears.

The F key is disabled in DC mode.

## 2 Turn the rotary knob to set the frequency (40.0 Hz to 500.0 Hz).

The top numeric display shows the frequency setting.

Pressing F again turns off the key and shows the measurement display. The top numeric display shows the voltage measurement.

# Turning the Output On/Off

Each time that you press OUTPUT, the output toggles between on and off.

- Output on

The LED above and to the left of the OUTPUT key lights.

A voltage and frequency that correspond to the output mode and output range that you have specified are generated.

- Output off

The LED above and to the left of the OUTPUT key turns off.

The output is off immediately after the POWER switch turned on.

If a protection function is activated, the output is turned off. However, if the current limit action is set to LIMIT CONTROL and the overload protection function (current limit) is activated, the output is not turned off.



### **WARNING** Risk of electric shock.

- Do not touch the OUTPUT terminal block or the outlets.
- In DC mode, even if the output is off, if a capacitor, battery, or similar item is connected as the load, a voltage remains in the device that is connected to the OUTPUT terminal block and the outlets until the load's energy is discharged. The time required for the internal capacitors to discharge when no load is connected is approximately 0.1 seconds.



**CAUTION** When you turn the output on, several volts of undershoot or overshoot may occur for several tens of microseconds.

## Output on/off principle

This product does not separate the internal circuit from the output using a mechanical switch or relay. Rather, it turns the output off by electrically increasing the output impedance. This enables you to turn the output on and off without chattering. When the output is off, the output is at high impedance as shown in the following table.

	PCR500MA	PCR1000MA	PCR2000MA	PCR4000MA
155 V range	Approx. 40 kΩ	Approx. 20 kΩ	Approx. 10 kΩ	Approx. 5 kΩ
310 V range	Approx. 80 kΩ	Approx. 40 kΩ	Approx. 20 kΩ	Approx. 10 kΩ

## Output-on phase angle

In AC mode, you can set the output-on phase.

Use CONFIG settings to control the output-on phase angle. (p.36) Because the output capacitor inside the product is discharged under no load conditions, the output-off phase angle is controlled so that the output is off at the zero-crossing phase.



Use CONFIG settings to set the output-on phase angle.

Always turns off at the zero-crossing phase

# Measurement Display

You can monitor the present output value. When the output is off, this is nearly 0.

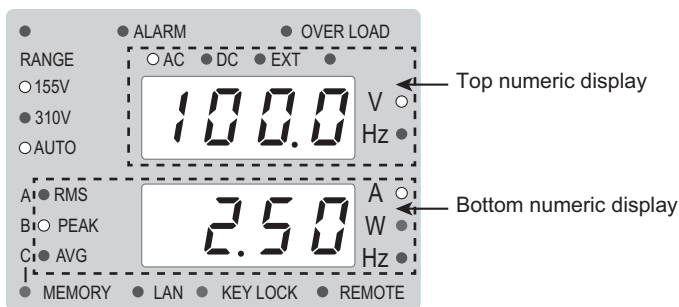

## ■ Top numeric display

AC mode	DC mode	AC+DC mode	EXT-AC mode	EXT-DC mode
Measured voltage (RMS)	Measured voltage (AVG)	Measured voltage (RMS)	Measured voltage (RMS)	Measured voltage (RMS)

## ■ Bottom numeric display

Press I to change the type of displayed value.

AC mode	DC mode
Measured rms current (RMS)	Measured peak current (PEAK)
Measured peak current (PEAK)	Measured average current (AVG)
Measured power (W)	Measured power (W)

Except for the peak current, the measurement averaging period can be set using CONFIG settings. [\(p.36\)](#)

This product measures the maximum instantaneous current and displays the measured peak current with an absolute value. In DC mode, even if you are generating negative voltage, the peak measured current is displayed as a positive value. The peak current hold time can be set using CONFIG settings. [\(p.36\)](#)

The measured current and power are shown in the bottom numeric display also for the voltage setting display and frequency setting display.

## ■ Switch the display.

The following table show the method to switch from another setting display to the measurement display.

Another setting display	Switching method
Voltage setting display (lit V key)	Press V.
Frequency setting display (lit F key)	Press F.
Limit setting display (lit LIMIT key)	
CONFIG setting display	Press I.
Memory storage display (lit MEMORY LED)	
Memory recall display (blinking MEMORY LED)	

# Setting Limits

Limits can be placed on the product's output setting. They prevent damage to the load caused by mistaken operations. Limits are set in advance according to the load conditions.

You can set them while output is on or off.

## 1 Press LIMIT.

The LIMIT key lights, and the limit setting display appears.

Each time you press the key, the limit value changes in order. Press LIMIT repeatedly until the limit you want to set appears. The last display is the measurement display.

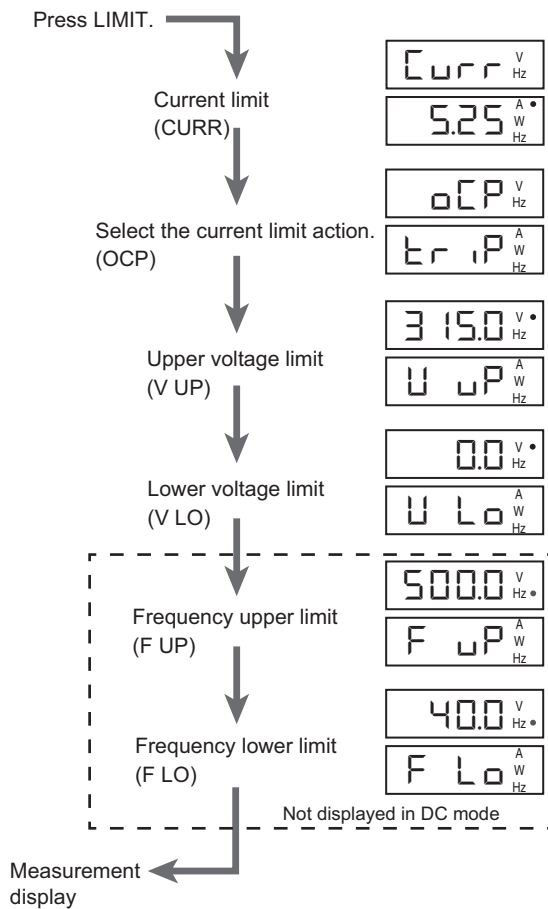

## 2 Turn the rotary knob to set the condition.

## 3 To set another limit, press LIMIT. To switch to another setting display or measurement display, press V, F, or I.

The voltage setting display, frequency setting display, or measurement display appears, respectively.

**NOTE** For voltage and frequency, limit values take precedence over the settings. If the voltage or frequency is changed to a value outside the limit range, the setting is set to the limit value.

### ■ Current limit (CURR)

You can set the current limit within the ranges shown in the following table.

Output mode	Limit			
	PCR500MA	PCR1000MA	PCR2000MA	PCR4000MA
AC mode EXT-AC mode	0.10 A to 5.25 A	0.20 A to 10.50 A	0.40 A to 21.00 A	0.80 A to 42.00 A
DC mode EXT-DC mode	0.10 A to 4.20 A	0.20 A to 8.40 A	0.40 A to 16.80 A	0.80 A to 33.60 A

### ■ Current limit action (OCP)

You can select how the product acts when the current limit is exceeded.

Current limit operation	Display	Function
TRIP	⊃⊃	If an overload lasts more than 3 seconds, an alarm occurs, and the output turns off.
LIMIT CONTROL	⊃⊃⊃	When an overload occurs, the output voltage is lowered so that it no longer exceeds the current limit (software CC mode). <sup>1</sup>

- <sup>1</sup> This is calculated as an rms value. The current limit may be exceeded for a few seconds because of the relationship between the measurement processing time and the voltage resolution.

### ■ Upper voltage limit (V UP) and lower voltage limit (V LO)

Set the limits so that the lower limit is less than or equal to the upper limit.

Output mode	Voltage range	Lower limit	Upper limit
AC mode	155 V	0.0 V to 157.0 V	0.0 V to 315.0 V
	310 V	0.0 V to 315.0 V	0.0 V to 315.0 V
DC mode	155 V	-445.0 V to +222.5 V	-222.5 V to +445.0 V
	310 V	-445.0 V to +445.0 V	-445.0 V to +445.0 V

### ■ Upper frequency limit (F UP) and lower frequency limit (F LO)

You cannot set these values in DC mode. Set the limits so that the lower limit is less than or equal to the upper limit.

Output mode	Lower limit	Upper limit
AC mode EXT-AC mode	40.0 Hz to 500.0 Hz	40.0 Hz to 500.0 Hz

# Memory Usage

Settings can be saved to memory. There are three memory areas (0 to 2): A, B, and C. This is useful for testing drastic changes in voltage or frequency.

In remote control mode, up to 11 sets of settings can be saved. Memory areas 3 to 10 can only be used in remote control mode. For details, see the communication interface manual.

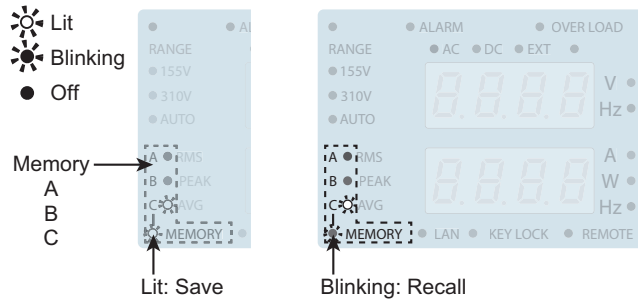

## Saving to memory

- 1 Set up the configuration that you want to save.**
- 2 Press STORE to select the memory area (A, B, or C) you want to save to.**  
 The MEMORY LED in the display area lights. Each time you press STORE, memory area A, B, or C is selected in order, and the corresponding LED lights. The top numeric display shows the voltage setting. In AC mode, the bottom numeric display shows the frequency setting.
- 3 Press ENTER (SHIFT+RECALL) to save to memory.**  
 The settings are saved to the selected memory. The MEMORY LED in the display area turns off. To cancel the save operation, press a key other than the STORE or ENTER (SHIFT+RECALL) key.

Saved contents		
Output mode (AC, DC, EXT)		
Voltage range (155 V, 310 V, AUTO)		
Voltage	AC	
	DC	
Frequency		
Measurement display (RMS, PEAK, AVG, W)		
Limits	AC	Upper voltage limit, lower voltage limit, current limit, upper frequency limit, lower frequency limit
	DC	Upper voltage limit, lower voltage limit, current limit
Current limit action (TRIP, LIMIT CONTROL)		
Output state (on, off)		

## Recalling from memory

---

When the output is on, if recalling settings from memory would cause the output mode or voltage range to change, a short alarm sound is generated, and recalling is not possible. If this happens, turn off the output, recall settings from memory, and then turn the output back on.

### 1 Press **RECALL** to select the memory area you want to recall from.

The MEMORY LED in the display area blinks. Each time you press RECALL, memory area A, B, or C is selected in order, and the corresponding LED lights.

The settings stored in memory are displayed (voltage setting in the top numeric display and frequency setting in the bottom numeric display).

### 2 Press **ENTER (SHIFT+RECALL)** to recall from memory.

The settings are recalled from the selected memory area and applied. The MEMORY LED in the display area turns off. To cancel the recall operation, press a key other than the RECALL or ENTER (SHIFT+RECALL) key.

# Locking the Panel Controls

To use a fixed voltage or frequency, you can lock the panel controls to prevent accidental changes to the settings. When the controls are locked, all controls other than the OUTPUT key and the KEY LOCK (SHIFT+STORE) key are disabled.

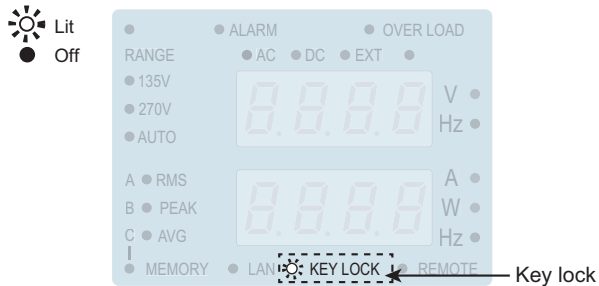

## ■ Enabling and disabling the lock

Each time you press KEYLOCK (SHIFT+STORE), the panel controls are locked or unlocked.

If the lock is enabled, the KEY LOCK LED in the display area lights. If the lock is disabled, the LED turns off.



# Protection Functions

This product is equipped with the following protection functions. When a protection function is activated, an alarm (A-xx) or an error (E-xx) is generated, and the output is turned off.

Protection function		Types of alarms and errors
Input voltage out-of-rated-range protection		Error E-10 or E-12
Overheat protection (OHP)		Alarm A-04
Overload protection	Overcurrent protection (OCP) (RMS, AVE)	Lit OVERLOAD, Alarm A-01
	Overpower protection (OPP)	Lit OVERLOAD, Alarm A-03
	Overcurrent peak protection (OCP) (PEAK)	Lit OVERLOAD, Alarm A-02
Abnormal voltage detection	Voltage rise protection (OVP)	Alarm A-00
	Voltage drop protection (LVP)	Alarm A-06
Abnormal sensing cable connection detection		Alarm A-05

- Alarms

An alarm occurs to indicate that a protection function has been activated.

- Errors

An error occurs when the product is used improperly, when it suspects a malfunction, or when there is a possibility that it will be damaged.

## Operation when the OVER LOAD LED is lit

The OVER LOAD LED in the display area lights when the conditions in the following table occur.

When OVER LOAD is lit, the output voltage may fluctuate.

OVER LOAD lights when	Operation performed after the LED lights
The measured current (RMS) exceeds the current limit or rated current.	Current limit action: TRIP <ul style="list-style-type: none"> <li>• If this condition lasts more than 3 seconds, an alarm (A-01) occurs, and the output turns off.</li> </ul> Current limit action: LIMIT CONTROL (software CC mode) <ul style="list-style-type: none"> <li>• The voltage setting is controlled.</li> <li>• No alarms occur.</li> </ul>
The measured current (PEAK) exceeds the maximum peak current or the maximum instantaneous current.	If this condition lasts 1 second, an alarm (A-02) occurs, and the output turns off. The time during which this condition lasts is integrated internally. Depending on the load condition, an alarm may occur even when the condition lasts less than 1 second.
The measured apparent power (VA) exceeds the rated apparent power.	If this condition lasts 10 seconds, an alarm (A-03) occurs, and the output turns off.
The measured voltage (RMS) is not within $\pm 8$ V of the voltage setting.	Current limit action: TRIP <ul style="list-style-type: none"> <li>• If this condition lasts 3 seconds, an alarm (A-00 or A-06) occurs, and the output turns off.</li> </ul>
The external signal input exceeds the maximum value of the range.	Current limit action: LIMIT CONTROL (software CC mode) <ul style="list-style-type: none"> <li>• No alarms occur.</li> </ul>

## Clearing alarm and error

When an alarm or error occurs, the ALARM LED in the display area lights along with an alarm sound. The bottom display shows the output voltage, and the bottom shows the alarm or error number.

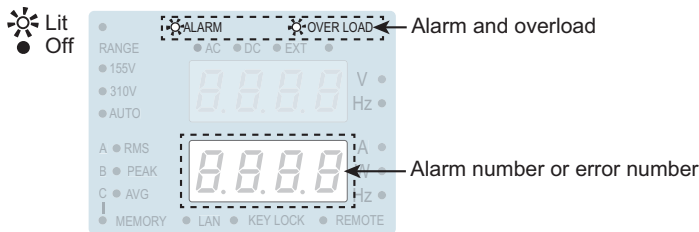

**NOTE**

If an alarm or error still occurs even after you have corrected all the causes of those, the product may be malfunctioning. Stop using it immediately, and contact your Kikusui agent or distributor. Tell the agent or distributor the displayed alarm or error number.

### Clearing alarms

**1 Check the alarm number.**

**2 Press ALM CLR (SHIFT+LIMIT).**

The alarm sound stops, and the alarm indication disappears.

Pressing ALM CLR (SHIFT+LIMIT) again shows the alarm number that disappeared.

**3 Eliminate the cause of the alarm.**

Eliminate the cause of the alarm by referring to the details of the displayed alarm number.

Alarm number	Description and corrective action
A-00	A voltage measurement that is more than 8 V higher than the voltage setting was detected (OVP). Or an external signal that exceeds the maximum value of the range was received. This alarm occurs when the current limit action is set to TRIP.
A-01	The overcurrent protection (RMS, AVE) was activated (OCP).
A-02	The overcurrent peak protection (PEAK) was activated (OCPP).
A-03	The power protection function was activated (OPP).
A-04	The overheat protection function was activated (OHP). The internal temperature may have risen to an abnormal level. If the alarm persists even after waiting about 10 minutes with the POWER switch turned on, there may be a problem with how the product is installed or the product may be in use outside the operating temperature range.
A-05	An abnormal sensing cable connection occurred. Check the connection and SENSE switch setting.
A-06	A voltage measurement that is less than 8 V less than the voltage setting was detected (LVP). This alarm occurs when the current limit action is set to TRIP.

**NOTE**

After the alarm is released, there is a period of approximately 10 seconds ("Busy" state) during which the output cannot be turned on. In the "Busy" state, the ALARM LED blinks.

## Clearing errors

**1** Check the error number.

**2** Turn the POWER switch off.

**3** Eliminate the cause of the error.

Eliminate the cause of the error by referring to the details of the displayed error number.

To restore the product, turn the POWER switch on again.

Error number	Description and corrective action
E-09	An error occurred in the internal communication. Turn the POWER switch off, wait at least 5 seconds, and then turn it back on.
E-10	The input voltage is outside of the rated range when the POWER switch is turned on. Check the input voltage.
E-11	An abnormal voltage occurred in the internal power unit. Turn the POWER switch off, wait at least 5 seconds, and then turn it back on.
E-12	While running, the input voltage may fell outside the rated range, or an error occurred in the internal input circuit. Check the input voltage. Turn the POWER switch off, wait at least 5 seconds, and then turn it back on.
E-13	An internal error occurred. Turn the POWER switch off, wait at least 5 seconds, and then turn it back on while holding down RECALL. The product is reset to its factory default conditions.
E-15	An error occurred in the calibration data. This error cannot be cleared. Contact your Kikusui agent or distributor to request repairs.

# CONFIG Settings

Use the CONFIG settings to perform system configuration of the product. You can set and display the following parameters in the CONFIG settings.

## CONFIG parameter

Parameter	Description
• Output-on phase (ONPH)	Sets the output-on phase control in AC mode.
ON (ON)	Output-on phase control enabled.
OFF (OFF) <sup>1</sup>	Free mode (no phase control).
• Phase angle (PHAN)	If you turn on phase control, you can set the phase angle (0° to 360°). (Factory default setting: 0°) (0° = 360°)
• Measurement averaging (AVER)	Selects the averaging period (1, 2, 4, 8, or 16) for measurements (excluding the peak current). (Factory default setting: 1) Measurements are displayed using the selected averaging period. Ex: If you select 16, the moving average of 0.33 × 16 = 5.28 s is displayed.
• Peak hold time (HOLD)	Selects the time to hold the peak current display.
SHORT (SHORT) <sup>1</sup>	The display is held for about 0.3 seconds.
LONG (LONG)	The display is held for about 5 seconds. If a higher peak value is measured when the display is held, the display is held for another 5 seconds.
• Interface setting (INTF)	Selects LAN or USB. GPIB becomes selectable if an interface board is installed in the option slot. Multiple interfaces can also be used simultaneously.
---	Proceeds to the next communication error trace function (ERRC) without changing the interface settings.
LAN (LAN)	LAN is selected.
USB (USB)	USB is selected.
488 (488)	GPIB is selected. (Selectable only when the optional interface board IB22 is installed)
• LAN (LAN)	Sets LAN.
ON (ON) <sup>1</sup>	LAN is enabled.
OFF (OFF)	LAN is disabled. Proceeds to the interface setting (INTF).
• IP1 to IP4 (IP 1 to IP4)	Displays the assigned IP address or the IP address that has just been assigned (0 to 254).
• MAC1 to MAC3 (MAC1 to MAC3)	Displays the product's MAC address.
• IP address (ADDR)	Selects the IP address assignment method.
AUTO (AUTO) <sup>1</sup>	The IP address is assigned automatically.
MANL (MANL)	The IP address is assigned manually.
• S IP1 to S IP4 (S IP 1 to S IP4)	Sets a fixed IP address (0 to 254).
• Subnet mask (SUBM)	Sets the subnet mask (16 to 31). If set to 16 255.255.0.0 If set to 24 255.255.255.0 If set to 31 255.255.255.254

Parameter	Description
• LAN boot (b o o t)	Selects whether to restart or reset the LAN. Press ENTER (SHIFT+RECALL) twice to restart/reset the LAN and proceed to LAN IF on/off. If you do not press ENTER, the LAN is not restarted.
APPL (R P P L)	The LAN is restarted. (The LAN settings are applied.)
LCI (L E I) LAN Configuration Initialization	The LAN is reset. (The LAN settings are reset to factory default.)
• USB (u s b)	Sets USB.
ON (o n) <sup>1</sup>	USB is enabled.
OFF (o f f)	USB is disabled. Proceeds to the interface setting ( i n t f).
• Vendor ID (U i d)	Displays the vendor ID (0x0B3E:0b3e). You cannot change this value.
• Product ID (P i d)	The product ID is displayed. You cannot change this value. 0x1050 ( i 0 5 0): PCR500MA 0x1051 ( i 0 5 1): PCR1000MA 0x1052 ( i 0 5 2): PCR2000MA 0x1053 ( i 0 5 3): PCR4000MA Proceeds to the interface setting ( i n t f).
• 488 (4 8 8)	Sets GPIB.
ON (o n) <sup>1</sup>	GPIB is enabled.
OFF (o f f)	GPIB is disabled. Proceeds to the interface setting ( i n t f).
• GPIB address setting (R d r)	Sets the GPIB address (1 to 30). (Factory default setting: 5) Proceeds to the interface setting ( i n t f).
• Communication error trace function (E r R E)	If, during remote control, there are errors in the SCPI error queue, you can select whether to display the error numbers.
ON (o n)	The bottom numeric display shows the error number.
OFF (o f f) <sup>1</sup>	Error numbers are not displayed.
• Language setting (L R n G)	The PCR-M compatible mode (SCPI language) setting is displayed. You cannot change this value. DEF (d e f): The compatible mode is set to default (PCR-MA series) and is disabled. PCRM (P C r M): A compatible mode that causes the product to operate in the same manner as a PCR-M series is enabled.
• PCR-M compatible mode ( i d E n)	A compatible mode that causes the PCR-MA series to operate as a PCR-M series is set. To switch the compatible mode, press ENTER (SHIFT+RECALL) to confirm the setting, turn the power off, and then turn the power on while holding down STORE.
DEF (d e f) <sup>1</sup>	Operates as a PCR-MA series.
PCRM (P C r M)	Operates as a PCR-M series. For details, see "PCR-M Compatible Mode" (p.42).
• Power-on status setting (P o n)	Sets the panel setting condition when the POWER switch is turned on.
AUTO (R u t o) <sup>1</sup>	The panel settings that were in use immediately before the POWER switch was turned off are reproduced.
RCL0 (r c l 0)	The panel settings saved in memory area A are reproduced.
RST (r s t)	The panel settings will be equivalent to those that result when an *RST command <sup>2</sup> is sent.

1 Factory default setting

2 For details on the settings, see the communication interface manual.

## Displaying and setting CONFIG parameters

---

### **1 Press CONFIG.**

The CONFIG setting display appears. See “CONFIG setting flowchart” ([p.39](#)).

Each time you press the key, the CONFIG settings change in order. Press CONFIG repeatedly until the operating condition you want to set appears. The last display is the measurement display.

### **2 Turn the rotary knob to set the condition.**

### **3 To set another operating condition, press CONFIG. To exit from CONFIG settings, press V, F, or I.**

The voltage setting display, frequency setting display, or measurement display appears, respectively.

### CONFIG setting flowchart

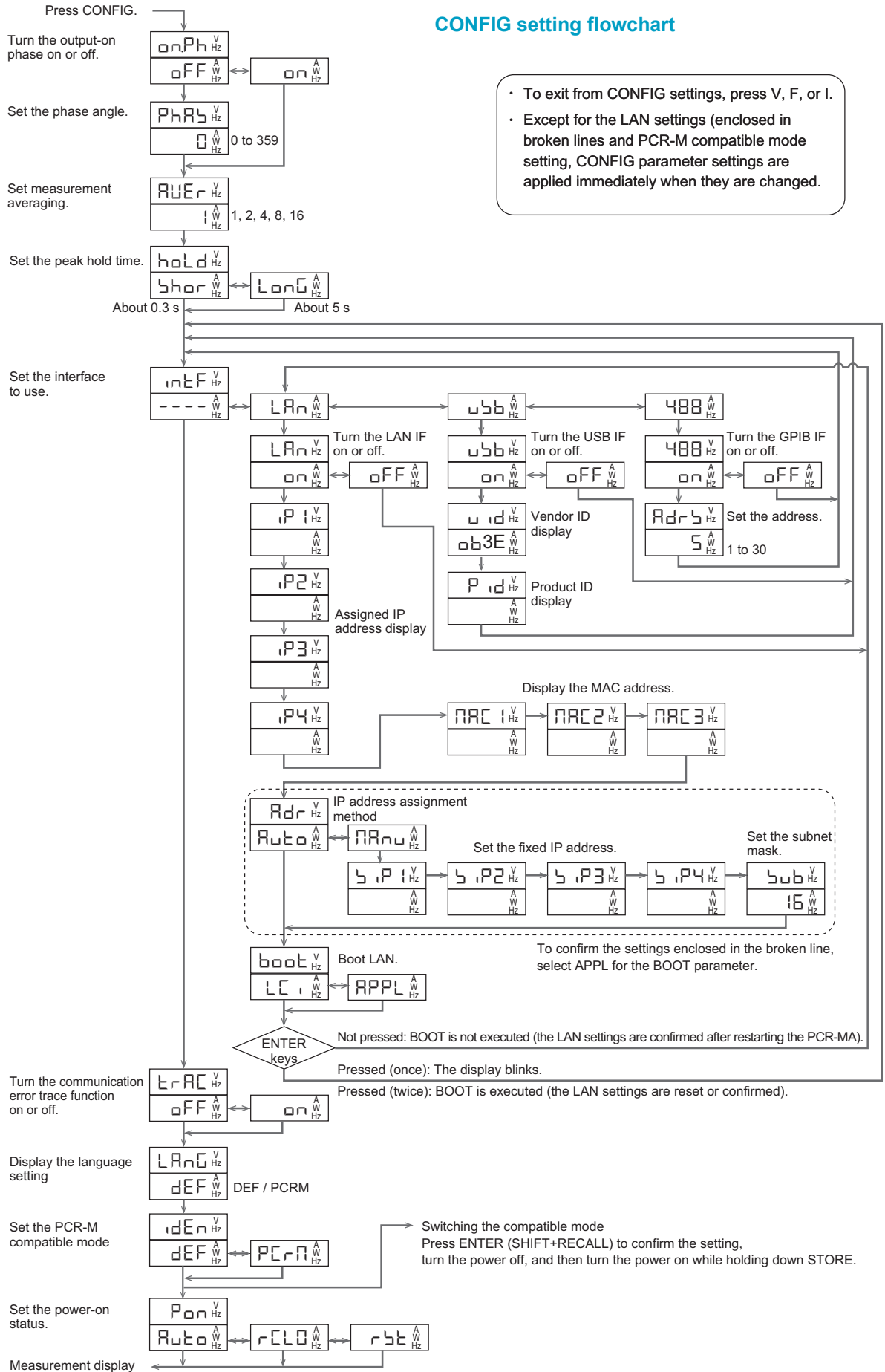

# Sensing

The sensing function compensates for voltage drops in the load cables when the load is connected to the product over a long distance.



**Risk of electric shock. Before you connect the load or sensing cables, turn the POWER switch off, and then remove the power plug from the outlet or turn off the switchboard.**

## Connecting sensing cables

Sensing can compensate to the voltage drop in the cable up to approximately 1 Vrms for a single line. Select a load cable that is thick enough to prevent the voltage drop in the cable from exceeding the compensation voltage.

If the sensing cables come loose, the output voltage will fluctuate by several volts.

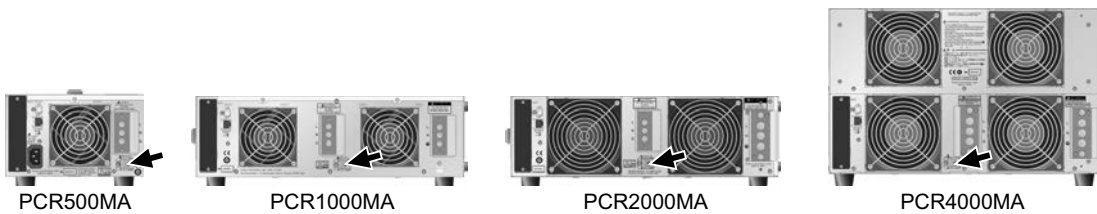

- 1** Turn the **POWER** switch off.
- 2** Remove the **SENSE** terminal cover and connector.

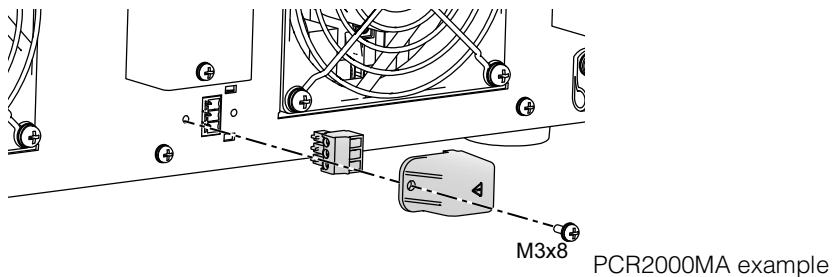

- 3** Connect the sensing cables to the connector.

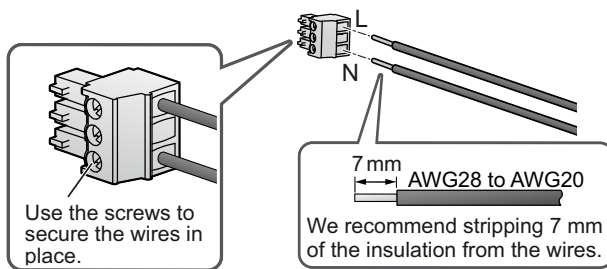



**4 Attach the connector and SENSE terminal cover.**

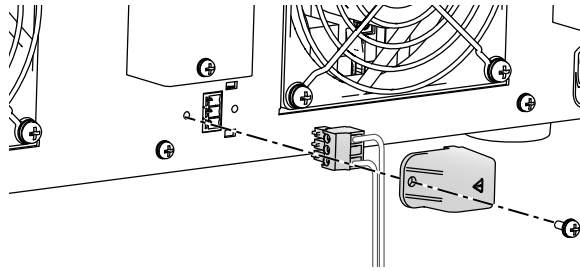

**5 Connect the N SENSE terminal of the product to the N terminal of the load using sensing cables. Likewise, connect the L SENSE terminal to the L terminal on the load.**

Make the sensing point as close to the load as possible.

Twist the load cables (L and N), and connect between the output terminal and load with the shortest cables possible. If you cannot twist the cables, we recommend that you run the cables alongside each other and tie them together at several points with cable ties.

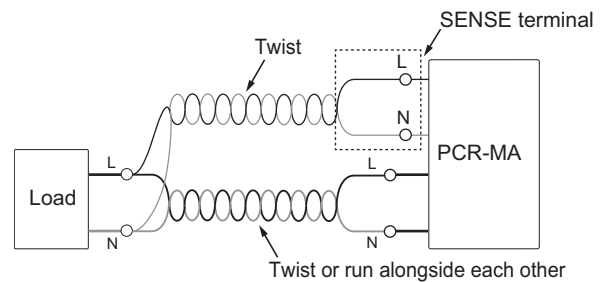

## Turning the sensing function on and off

You can turn the sensing function on and off using the SENSE switch.

**NOTE** If you change the SENSE switch while the output is on, overvoltage will occur.

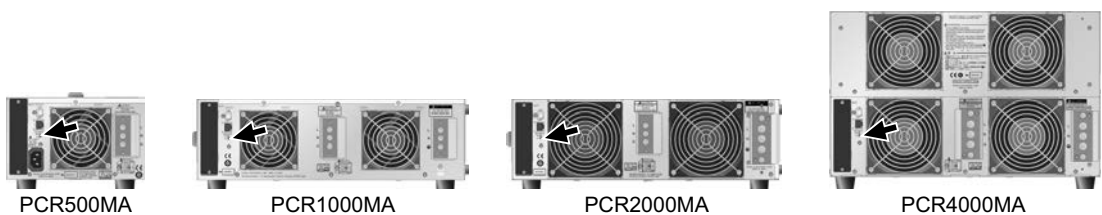

**1 Press OUTPUT to turn output off.**

The LED above and to the left of the OUTPUT key turns off.

**2 Setting the SENSE switch to RMT (remote sensing) enables the sensing function. Setting it to LCL (local sensing) disables it.**

SENSE  
 RMT   
 LCL  Example of the sensing function turned off

# Remote Control

You can remotely control the product from a PC using SCPI commands through the LAN, USB, or GPIB interface. The following functions are expanded in remote control mode.

- AC+DC mode, which enables you to overlay an AC with DC and generate the output, becomes selectable.
- The number of entries that you can store in memory increases from 3 to 11.

Moreover, with the LAN interface, you can use the Web browser interface of the product to remotely control the product from a virtual front panel. For details on remote control, see the Communication Interface Manual.

## Switching from Remote Mode to Local Mode

When the product is being controlled remotely, the REMOTE LED on the front panel lights. To switch the product back to local mode from the front panel, press LOCAL.

## PCR-M Compatible Mode

This mode makes it possible to use programs created for the conventional PCR-M series to be used on the PCR-MA series without making changes to the programs.

Because the PCR-MA series operates as a PCR-M series, the voltage setting range and other specifications and functions that have been expanded on the PCR-MA will basically be the same as those of the PCR-M series.

For details on PCR-M series commands, see the Communication Interface Manual.

### NOTE

- When you switch the PCR-M compatible mode setting (between DEF and PCRM) ([p.37](#)), this product starts with the default settings of the selected mode.

Compatible mode setting	Default settings
PCRM (enabled)	Factory default settings of the PCR-M series <sup>1</sup>
DEF (disabled)	Factory default settings of the PCR-MA series <sup>1</sup>

<sup>1</sup> Communication settings are excluded.

- In PCR-M compatible mode, the validity of the PCR-MA series commands is not guaranteed. If you are not operating the product as a PCR-M series, set the compatible mode to DEF (disabled).
- The analog interface board (EX08-PCR-MA) can be used in PCR-M compatible mode, but the output voltage in response to the input signal will be that of the PCR-MA series. It will not be the output voltage of the PCR-M series.
- To use the sequence creation software Wavy for PCR-M, set the PCR-M series compatible mode to PCRM (enabled) in advance.

## Control Using External Analog Signals (Option)

If you install the analog interface board (EX08-PCR-MA) into the option slot, you will be able to control the output using external analog signals. This cannot be used simultaneously with the GPIB interface.

There are two modes. EXT-AC mode controls the voltage of the output AC waveform (sine wave) using DC signals. EXT-DC mode simply amplifies the input signal waveform and outputs the result.

EXT-AC mode

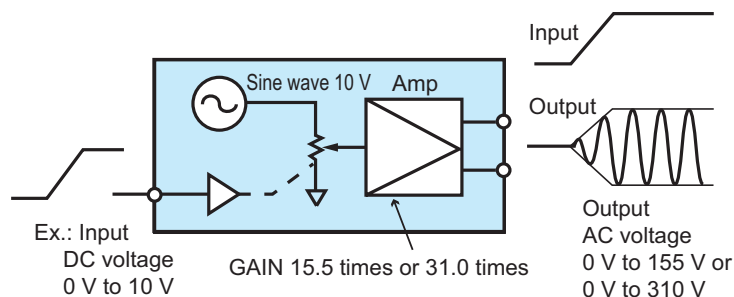

EXT-DC mode

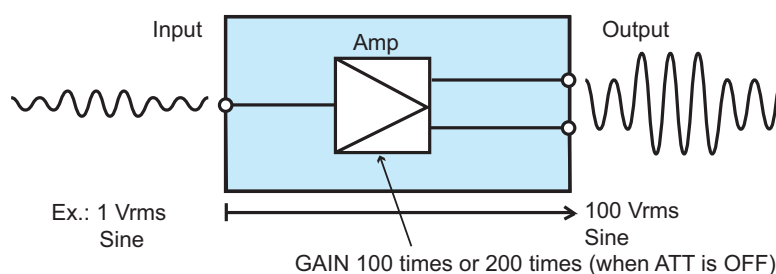

**CAUTION** When the product is being controlled using external analog signals, voltage limits cannot be set. Applying an excessive external voltage by mistake can damage the load.

### Names and functions of the components in the analog interface board input terminal area

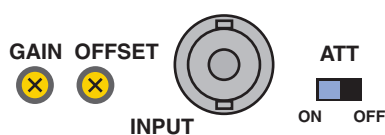

Name	Description
INPUT	A BNC terminal for applying external signals. The INPUT terminal and the PCR-MA output are electrically isolated.
ATT	Input attenuator switch
GAIN	Variable resistor for fine gain (voltage gain) adjustment.
OFFSET	Variable resistor for fine offset adjustment.

## Controlling the voltage of the output AC waveform using DC signals (EXT-AC mode)

---

The product outputs AC voltages in the 0 V to 155 V range (when 155 V range is selected) or the 0 V to 310 V range (when 310 V range is selected) in response to signals ranging from 0 V to  $\pm 10$  V (DC).

---

**⚠ CAUTION** Turn the ATT switch on. Otherwise, excessive voltage may be output, which can damage the load.

---

- 1** Turn the **POWER** switch off.
- 2** Turn the **ATT** switch on.
- 3** Connect an external signal (generator) to the **INPUT** terminal.
- 4** Turn the **POWER** switch on.
- 5** Press **AC/DC/EXT (SHIFT+V)** to set the output mode to **EXT-AC**.  
The EXT and AC LEDs light.
- 6** Press **RANGE (SHIFT+I)** to set the voltage range (**155 V** or **310 V**).  
The corresponding voltage range LED lights.  
You cannot select **AUTO**.
- 7** Press **F** to set the frequency (**40 Hz** to **500 Hz**).
- 8** Apply an external signal to the **INPUT** terminal.
- 9** Turn the output on.

### Setting limits

You can set frequency limits, current limits, and current limit action. For the setup procedure and setting range, see "Setting Limits" (p.28).

### Finely adjusting the offset

You can finely adjust the offset by turning the **OFFSET** variable resistor with an adjustment screwdriver. Adjust so that the output voltage is minimum with the **INPUT** terminal shorted.

### Finely adjusting the gain

You can finely adjust the gain by turning the **GAIN** variable resistor with an adjustment screwdriver. Adjust so that the output voltage is 155 Vac (155 V range) when 10 V (DC) is applied to the **INPUT** terminal.

## Measurement display

In the bottom numeric display, RMS, PEAK, and W are selected in order each time you press I. The top numeric display shows the rms voltage measurement.

## Amplifying the input waveform (EXT-DC mode)

The input waveform is simply amplified and output. The output varies depending on the ATT switch setting as follows.

ATT switch	Input signal	Voltage range	Gain	Output voltage
Off	0 V to $\pm 2.19$ V (peak)	155 V	100 times	0 V to 155 V (AC)
		310 V	200 times	0 V to 310 V (AC)
On	-10 V to +10 V (DC)	155 V	19 times	-219 V to +219 V (DC)
		310 V	38 times	-438 V to +438 V (DC)

- 1** Turn the **POWER** switch off.
- 2** Set the **ATT** switch to on or off.
- 3** Connect an external signal (generator) to the **INPUT** terminal.
- 4** Turn the **POWER** switch on.
- 5** Press **AC/DC/EXT (SHIFT+V)** to set the output mode to **EXT-DC**.  
The EXT and DC LEDs light.
- 6** Press **RANGE (SHIFT+I)** to set the voltage range (155 V or 310 V).  
The corresponding voltage range LED lights.  
You cannot select AUTO.
- 7** If you want to apply an AC signal (ATT switch off), press **F** to set the frequency (40 Hz to 500 Hz).  
To display the measurements accurately, set the frequency to match the frequency of the external input signal. Otherwise, measurements will not be stable.
- 8** Apply an external signal to the **INPUT** terminal.
- 9** Turn the output on.

## Setting limits

You can set frequency limits, current limits, and current limit action. For the setup procedure and setting range, see “Setting Limits” (p.28).

## Finely adjusting the offset

You can finely adjust the offset by turning the OFFSET variable resistor with an adjustment screwdriver. Adjust so that the output voltage is as close to 0 V (DC) as possible with the ATT switch turned off and the INPUT terminal shorted.

## Finely adjusting the gain

You can finely adjust the gain by turning the GAIN variable resistor with an adjustment screwdriver. With the ATT switch turned off, adjust so that the output voltage is 155 Vac (155 V range) when 155 Vac is applied to the INPUT terminal.

## Measurement display

In the bottom numeric display, RMS, PEAK, AVG, and W are selected in order each time you press I. The top numeric display shows the average voltage measurement when AVG is selected in the bottom numeric display or the rms voltage measurement otherwise.

# Maintenance

---

## Inspection

---

To purchase accessories or options, contact your Kikusui agent or distributor.

## Overhaul

---

The electrolytic capacitors and fan motor inside the product are consumable parts.

We recommend that you have the product overhauled every 10000 operating hours or so (the frequency depends on the usage conditions), along with internal inspection and cleaning. To have your unit overhauled, contact your Kikusui agent or distributor.

## Calibration

---

The product is calibrated before shipment. To maintain long-term performance, we recommend periodic calibration. To have your product calibrated, contact your Kikusui agent or distributor.

# Cleaning



**Risk of electric shock. Risk of death or serious injury. Before you perform maintenance, be sure to turn the POWER switch off and remove the power plug from the outlet or turn off the switchboard.**

## Cleaning the dust filter

Dust filters are installed on the inside of the louver on the front panel. Periodically clean the filter to prevent clogging.



**Clogged filters hinder the cooling of the inside of the product and can cause a malfunction and shortening of the service life.**

- 1 Hook your fingers on the second slat from the bottom of louver A. While pulling the first slat towards you, slide the entire louver down, and remove the louver from the panel.**

If the outlet cover is attached, remove it first.

Press down on the top slat, and the louver should be easy to remove.

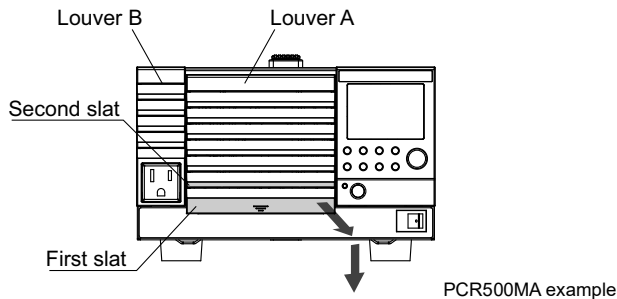

- 2 While pressing up on the bottom tab of louver B, pull it towards you. Slide the entire louver down, and remove the louver from the panel.**

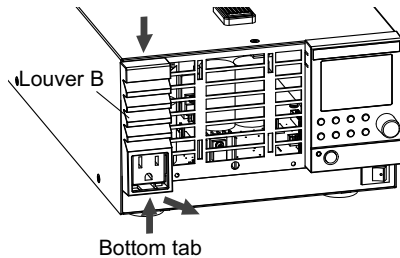



### 3 Remove the dust filter from the inside of each louver and clean it.

Use a vacuum cleaner to dispose of the dust and foreign particles that are attached to the dust filter. If the filter is extremely dirty, clean it using water-diluted neutral detergent, and dry it completely.



When the product is in operation, air is sucked through the dust filter to cool the inside of the device. If moisture is present in the dust filter, the temperature or humidity inside the product increases and may cause a malfunction.

### 4 Attach the dust filter to each louver.

Attach the dust filter so that the louver's tabs pass through the cuts in the dust filter.

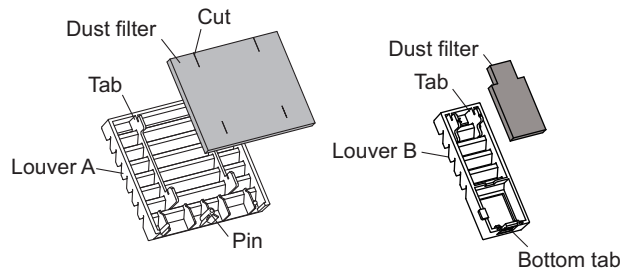

### 5 Attach louver B to the panel first.

Insert the top tab of the louver into the main unit, slide the louver up, and push the bottom area of the louver to secure it in place.

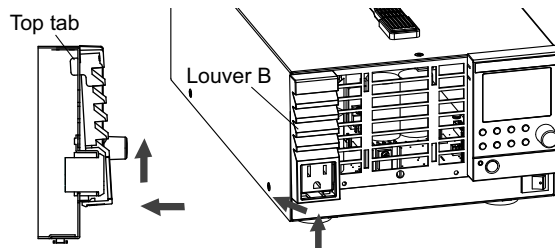

### 6 Attach louver A to the panel.

While holding the second slat from the bottom, slide the entire louver upward to secure the pin in place.

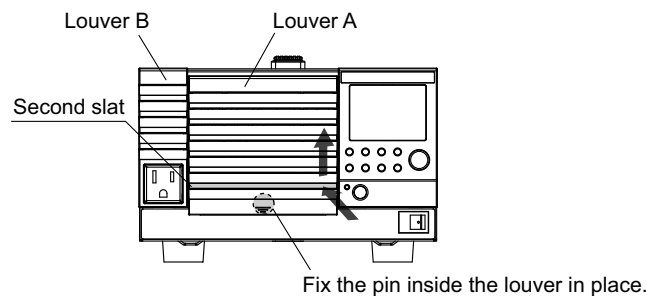

# Specifications

Unless specified otherwise, the specifications are for the following settings and conditions.

- The product is warmed up for at least 30 minutes.
- TYP: These are typical values that are representative of situations where the product operates in an environment with an ambient temperature of 23 °C. These values do not guarantee the performance of the <series name>.
- set: Indicates a setting.
- range: Indicates the rated value of each range.
- reading: Indicates a readout value.
- The specifications apply to the rear panel output terminals.

## Input rating

		PCR500MA	PCR1000MA	PCR2000MA	PCR4000MA
Nominal input rating		100 Vac to 120 Vac/200 Vac to 240 Vac, 50 Hz/60 Hz, single phase			
Voltage range		90Vac to 132Vac/180Vac to 264Vac (auto detection at power-on)			
Number of phases, frequency		Single phase, 47 Hz to 63 Hz			
Displays the apparent power.		Approx. 800 VA	Approx. 1600 VA	Approx. 3200 VA	Approx. 6400 VA
Power factor <sup>1</sup>		0.9 (standard value)			
Current	Input 90 V to 115 V	8 A/6.3 A or less (@90 V/115 V)	16 A/12.5 A or less (@90 V/115 V)	32 A/25 A or less (@90 V/115 V)	64 A/50 A or less (@90 V/115 V)
	Input 180 V to 230 V	4 A/3.2 A or less (@180V/230V)	8 A/6.3 A or less (@180V/230V)	16 A/12.5 A or less (@180V/230V)	32 A/25 A or less (@180V/230V)

1 At output voltage 100 V/200 V (output 155 V/310 V range), maximum current, load power factor 1.

## Output rating AC mode

Outlet can be used only in AC mode.

The outlet's maximum output voltage is 250 Vrms and maximum output current 10 A.

	PCR500MA	PCR1000MA	PCR2000MA	PCR4000MA
Rated voltage range (output 155 V/310 V range)	0 V to 155 V/0 V to 310 V			
Settable voltage range (output 155 V/310 V range)	0 V to 157.5 V/0 V to 315.0 V			
Voltage setting resolution	0.1 V			
Voltage setting accuracy <sup>1</sup>	±(1 % of set + 0.6 V/1.2 V)			
Number of output phases	Single phase			
Maximum current <sup>2</sup>	5 A/2.5 A	10 A/5 A	20 A/10 A	40 A/20 A
Maximum peak current <sup>3</sup>	15 A/7.5 A	30 A/15 A	60 A/30 A	120 A/60 A
Load power factor	0 to 1 (leading or lagging)			
Power capacity	500 VA	1 kVA	2 kVA	4 kVA
Frequency setting range	40.0 Hz to 500.0 Hz			
Frequency setting resolution	0.1 Hz			
Frequency setting accuracy	≤ ±2 × 10 <sup>-4</sup>			

1 At output voltage 13.5 V to 155 V/27 V to 310 V, output frequency 45 Hz to 65 Hz, no load, 23°C ±5°C.

2 At output voltage 1 V to 100 V/2 V to 200 V.

Limited by the power capacity at output voltage 100 V to 155 V/200 V to 310 V.

3 For capacitor-input rectifier loads. Limited by the maximum current.

## Output rating DC mode

	PCR500MA	PCR1000MA	PCR2000MA	PCR4000MA
Rated voltage range (output 155 V/310 V range)	-219 V to +219 V/-438 V to +438 V			
Settable voltage range (output 155 V/310 V range)	-222.5 V to +222.5V/-445.0 V to +445.0 V			
Voltage setting resolution	0.1 V			
Voltage setting accuracy <sup>1</sup>	±(1 % of set + 0.6 V/1.2 V)			
Maximum current (output 155 V/310 V range) <sup>2</sup>	4 A/2 A	8 A/4 A	16 A/8 A	32 A/16 A
Maximum instantaneous current (output 155 V/310 V range) <sup>3</sup>	12 A/6 A	24 A/12 A	48 A/24 A	96 A/48 A
Power capacity	400 W	800 W	1600 W	3200 W

1 At output voltage 19 V to 219 V/38 V to 438 V, no load, 23°C ±5°C.

2 At output voltage 1.4 V to 100 V/2.8 V to 200 V.

Limited by the power capacity at output voltage 100 V to 219 V/200 V to 438 V.

3 Limited by the maximum current.

## Output voltage stability

		PCR500MA	PCR1000MA	PCR2000MA	PCR4000MA
Line regulation <sup>1</sup>		≤ ±0.15 %			
Load variation (output 155 V/310 V range) <sup>2</sup>	40 Hz to 100 Hz, DC	≤ ±0.15 V/±0.3 V			
	Other than above	≤ ±0.5 V/±1 V			
Output frequency variation <sup>3</sup>		≤ ±1 %			
Ripple noise <sup>4</sup>		0.8 Vrms/1.6 Vrms (TYP)			
Ambient temperature variation <sup>5</sup>		100 ppm/°C (TYP)			

- 1 For changes within the rated range.
- 2 At output voltage 80 V to 155 V/160 V to 310 V, load power factor 1, output voltage variation between 0 A and maximum current, rear-panel output terminals.
- 3 At output voltage 100 V/200 V, load power factor 1. Output voltage variation when 60 Hz is reference.
- 4 In DC mode, at the rear-panel output terminals for 5 Hz to 1 MHz components.
- 5 At output voltage 100 V/200 V, output current 0 A, within the operating temperature range.

## Output frequency stability, output voltage waveform distortion ratio, output voltage response speed, efficiency, sensing function

		PCR500MA	PCR1000MA	PCR2000MA	PCR4000MA
Output frequency stability		≤ ±5 × 10 <sup>-5</sup>			
Output voltage waveform distortion ratio <sup>1</sup>		≤ 0.5 %			
Output voltage response speed <sup>2</sup>		150 μs (TYP)			
Efficiency <sup>3</sup>		≥70 %			
Sensing function		Compensates for the voltage drop in load cables up to approximately 1 Vrms for a single line.			

- 1 At output voltage 50 V to 155 V/100 V to 310 V, load power factor 1, in AC mode
- 2 At output voltage 100 V/200 V, load power factor 1, output current variation between 0 A and maximum current.
- 3 In AC mode, at output voltage 100 V/200 V, maximum current, load power factor 1, output frequency 40 Hz to 500 Hz.

## Indicators

The rms value (RMS), average value (AVE), and power (W) are determined using the following equations.

- $RMS$  (true rms value calculation) =  $\sqrt{(\sum(\text{square of the instantaneous voltage or instantaneous current}))/\text{sample count}}$
- $AVE = \sum(\text{instantaneous voltage or instantaneous current})/\text{sample count}$
- $W = \sum(\text{instantaneous voltage} \times \text{instantaneous current})/\text{sample count}$

Sample period: 100 ms to 125 ms for AC output (integer multiple of the output waveform period), 125 ms for DC output

Update interval: About 3 times/second, averaging over 2 seconds when averaging is on

Peak current (PEAK) holds the absolute maximum value of the peak current for about 0.3 or 5 seconds.

The voltage display shows RMS (rms value) in AC mode and AVE (average value) in DC mode.

		PCR500MA	PCR1000MA	PCR2000MA	PCR4000MA
Voltmeter	Resolution	0.1 V			
	Accuracy	RMS, AVE (output 155 V/310 V range) <sup>1</sup>			
		45 Hz to 65 Hz, DC	±(0.5 % of reading +0.3 V/0.6 V)		
	Other than above	±(0.7 % of reading +0.9 V/1.8 V)			
Ammeter	Resolution	0.01 A			0 A to 99.99 A (RMS, AVE): 0.01 A 100 A to (RMS, AVE), IPK: 0.1A
	Accuracy	RMS, AVE (output 155 V/310 V range) <sup>2</sup>			
		45 Hz to 65 Hz, DC	±(0.5 % of reading +0.02 A/ 0.01 A)	±(0.5 % of reading +0.04 A/ 0.02 A)	±(0.5 % of reading +0.08 A/ 0.04 A)
	Other than above	±(0.7 % of reading +0.04 A/ 0.02 A)	±(0.7 % of reading +0.08 A/ 0.04 A)	±(0.7 % of reading +0.16 A/ 0.08 A)	±(0.7 % of reading +0.32 A/ 0.16 A)
Wattmeter	Resolution	0.1 W	0.1W (<1 000 W), 1 W (1000 W≤)		
	Accuracy <sup>3</sup>	±(2 % of reading +0.5 W)	±(2 % of reading +1 W)	±(2 % of reading +2 W)	±(2 % of reading +4 W)

1 In AC mode, output voltage 13.5 V to 155 V/27 V to 310 V, 23°C ±5°C.

In DC mode, output voltage 19 V to 219 V/38 V to 138 V, 23°C ±5°C.

2 For waveforms with a crest factor of 3 or less. At 5 % to 100 % of the maximum rated current, 23°C ±5°C

3 At output voltage 50 V or more, output current 10 % to 100 % of the maximum rated current, load power factor 1, output frequency 45 Hz to 65 Hz or DC, 23°C ±5°C

## Setting range limit function

			PCR500MA	PCR1000MA	PCR2000MA	PCR4000MA
Limit value setting range	AC voltage	UPPER (output 155 V/ 310 V range)	0.0 V to 315.0 V/0.0 V to 315.0 V			
		LOWER (output 155 V/ 310 V range)	0.0 V to 157.0 V/0.0 V to 315.0 V			
	DC voltage	UPPER (output 155 V/ 310 V range)	-222.5 V to 445.0 V/-445.0 V to 445.0 V			
		LOWER (output 155 V/ 310 V range)	-445.0 V to 222.5 V/-445.0 V to 445.0 V			
	Frequency	UPPER	40.0 Hz to 500.0 Hz			
		LOWER	40.0 Hz to 500.0 Hz			
	Current	AC mode EXT-AC mode	0.100 A to 5.250 A	0.200 A to 10.50 A	0.400 A to 21.00 A	0.800 A to 42.00 A
		DC mode EXT-DC mode	0.100 A to 4.200 A	0.200 A to 8.400 A	0.400 A to 16.80 A	0.800 A to 33.60 A

## General

		PCR500MA	PCR1000MA	PCR2000MA	PCR4000MA
Insulation resistance	Between input and case, between output and case, between input and output	500 Vdc, 30 MΩ or more			
Withstanding voltage	Between input and case, between output and case, between input and output	1.5 kVac for 1 minute			
Isolation voltage		310 Vrms/438 Vdc			
Earth continuity		25 Aac/0.1 Ω or less			
Electromagnetic compatibility <sup>1 2</sup>		Complies with the requirements of the following directive and standards. EMC Directive 2014/30/EU EN 61326-1 (Class A <sup>3</sup> ) EN 55011 (Class A <sup>3</sup> , Group 1 <sup>4</sup> ) EN 61000-3-2 EN 61000-3-3 Applicable under the following conditions Load cables are less than 30 m. Other cables connected to the product are all less than 3 m.			
Safety <sup>1</sup>		Complies with the requirements of the following directive and standards. Low Voltage Directive 2014/35/EU <sup>2</sup> EN 61010-1 (Class I <sup>5</sup> , Pollution Degree 2 <sup>6</sup> )			
Circuit method		PWM inverter system			
Environment	Operating environment	Indoor use, overvoltage category II			
	Operating temperature and humidity range	0°C to 40°C, 20 % to 80 %rh (no condensation)			
	Storage temperature and humidity range	-10°C to 60°C, 0 % to 90 %rh (no condensation)			
	Altitude	Up to 2000 m			
Dimensions (chassis)		See "External dimensions" (p.58).			
Weight		Approx. 6.5 kg	Approx. 11 kg	Approx. 16 kg	Approx. 32 kg
I/O terminal block wire connection screw	Input terminal block	(Inlet)	M4	M6	M6
	Output terminal block	M4	M4	M4	M6
Accessories		See "Accessories" (p.3).			

- 1 Does not apply to specially ordered or modified products.
- 2 Only on models that have the CE marking on the panel.
- 3 This product confirms to Class A. This product is intended for use in an industrial environment. This product may cause interference if used in residential areas. Such use must be avoided unless the user takes special measures to reduce electromagnetic emissions to prevent interference to the reception of radio and television broadcasts.
- 4 This is a Group 1 instrument. This product does not generate and/or use intentionally radio-frequency energy, in the form of electromagnetic radiation, inductive and/or capacitive coupling, for the treatment of material or inspection/analysis purpose.
- 5 This product confirms to Class I. Be sure to ground the protective conductor terminal of this product. If not grounded properly, safety is not guaranteed.
- 6 Pollution is addition of foreign matter (solid, liquid or gaseous) that may produce a reduction of dielectric strength or surface resistivity. Pollution Degree 2 assumes that only non-conductive pollution will occur except for an occasional temporary conductivity caused by condensation.

## Common interface specifications

Software protocol	IEEE488.2 std 1992
Command language	SCPI Specification 1999.0
Operation description	<p>Can be used to set panel functions and read measured values (except for the power switch and key lock)</p> <p>Functions executable using commands</p> <ul style="list-style-type: none"> <li>• Apparent power measurement</li> <li>• Reactive power measurement</li> <li>• Power factor measurement</li> <li>• Crest factor</li> <li>• Peak hold current measurement</li> <li>• AC+DC mode (specifications of the voltage range, maximum current, power capacity, and other output ratings are the same as those of DC mode.)</li> <li>• Panel storage memory: 11 memory areas<sup>1</sup></li> </ul>

1 Includes 3 memory areas for standard operation.

## LAN interface

Hardware	Complies with IEEE 802.3 100base-TX/10Base-T Ethernet 1.5 LXI Device Specification 2016 RJ-45 connector
Communication protocol	VXI-11, SCPI-RAW, HiSLIP
Program message terminator	VXI-11, HiSLIP: LF or END for reception, LF+END for transmission, SCPI-RAW: LF for reception, LF for transmission

## USB interface

Hardware	Complies with the USB 2.0 specifications; data rate: 480 Mbps (HighSpeed), TypeB socket
Program message terminator	LF or EOM for reception, LF + EOM for transmission
Device class	Complies with the USBTMC-USB488 device class specifications

## GPIB interface (option IB22)

Hardware	Complies with IEEE Std 488.1-1978 SH1, AH1, T6, L4, SR1, RL1, PP0, DC1, DT1, C0, E1
Program message terminator	LF or EOI for reception, LF + EOI for transmission
Primary address	1 to 30



## Analog interface (option EX08-PCR-MA)

Input terminal	Maximum allowable input voltage	±15 V	
	Type	BNC	
	Input impedance	10 kΩ ±5 % (unbalanced)	
	Isolation voltage	42 Vpk	
EXT-AC mode <sup>1</sup>	Input voltage range	-10 V to +10 V (DC)	
	Voltage gain (155 V/310 V range)	15.5 times, 31 times (Outputs AC voltage ranging from 0 V to 155 V/0 V to 310V in response to DC voltage input ranging from 0 V to ±10 Vavg)	
	Frequency setting range	40 Hz to 500 Hz	
	Other output rating specifications	Same as those of AC mode output ratings	
EXT-DC mode	Input voltage range <sup>2</sup>	ATT OFF	-2.19 V to +2.19 Vpeak (0 V to 155 Vrms sine wave)
		ATT ON	-10 V to +10 V (DC)
	Input frequency range	ATT OFF	40 Hz to 500 Hz (sine wave), 40 Hz to 100 Hz (square wave), DC
	Frequency response	ATT OFF	500 Hz -0.3 dB (TYP) 55 Hz as the reference
	Voltage gain (155 V/310 V range)	ATT OFF	100 times, 200 times (Outputs AC voltage ranging from 0 V to 155 V/0 V to 310V in response to AC voltage input ranging from 0 V to 1.55 V)
		ATT ON	21.9 times, 43.8 times (Outputs DC voltage ranging from -219 V to +219 V/-438 V to +438 V in response to DC voltage input ranging from -10 V to +10 V)
	Other output rating specifications	Same as those of DC mode output ratings	
Waveform distortion ratio <sup>3</sup>		≤ main unit specifications +0.5 %	
Output voltage temperature coefficient		Main unit specifications +200 ppm/°C (TYP)	
Insulation resistance	Input (BNC) and case Input (BNC) and output	500 Vdc, 30 MΩ or more	
Withstanding voltage	Input (BNC) and case Input (BNC) and output	500 Vac for 1 minute	

1 ATT ON at all times

2 Measurable ranges of voltage, current, and power are DC and 40 Hz to 500 Hz. Set the frequency according to the input waveform period.

3 For DC input in EXT-AC mode and sine wave with 0.1% or less distortion in EXT-DC mode.

## External dimensions

### PCR500MA

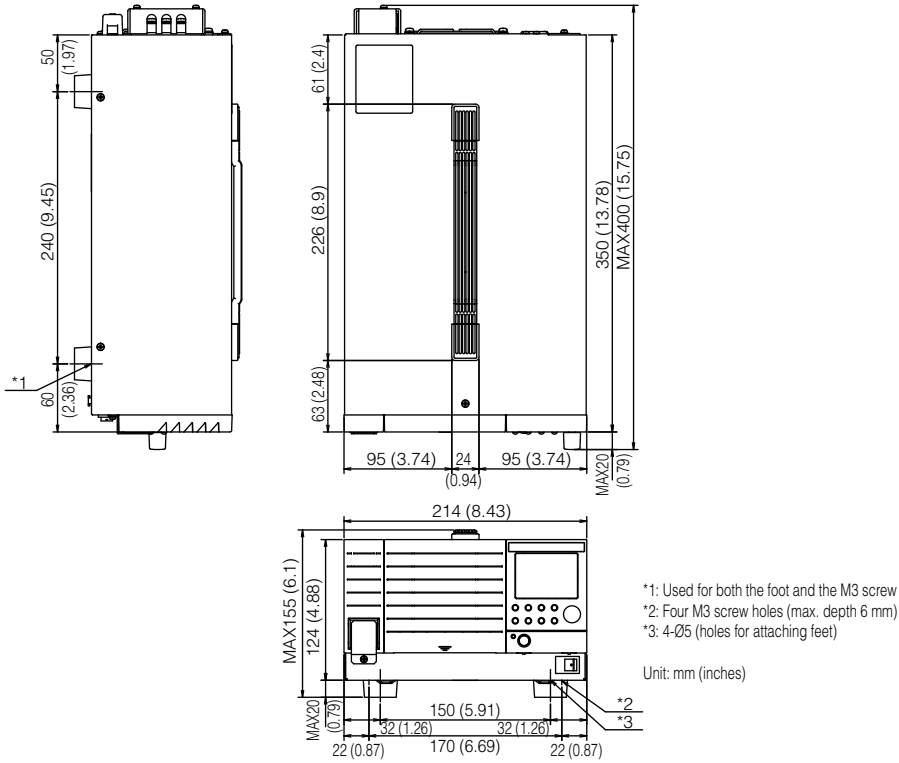

### PCR1000MA

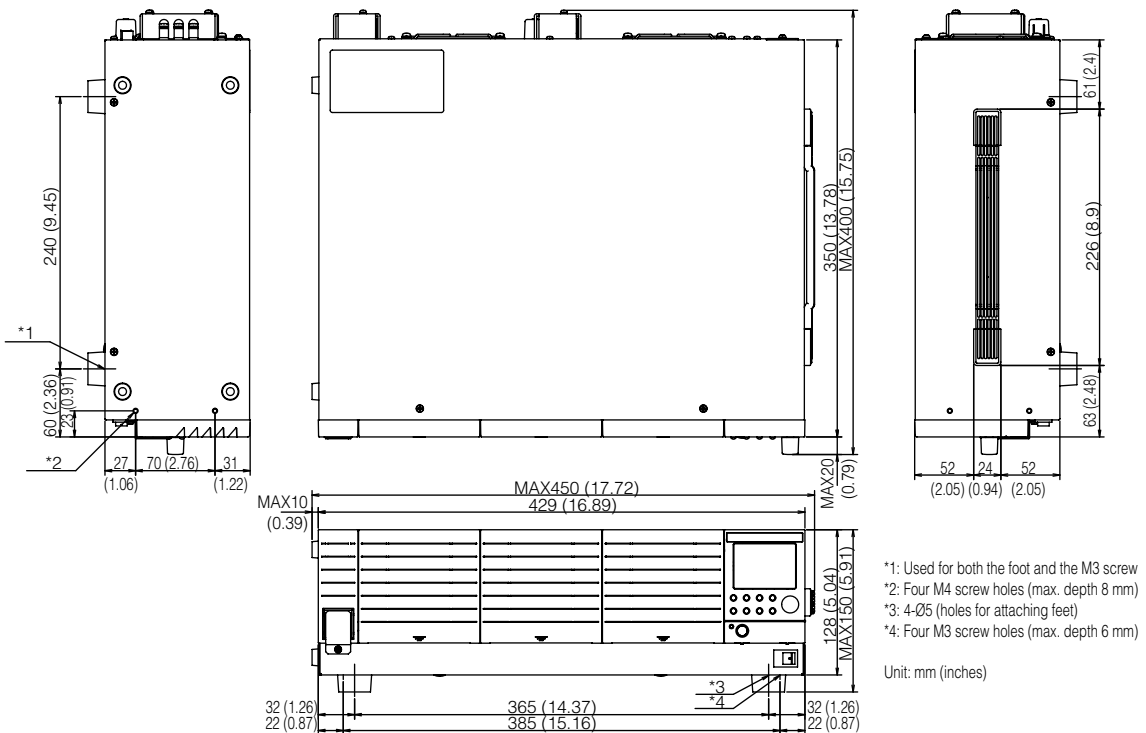

PCR2000MA

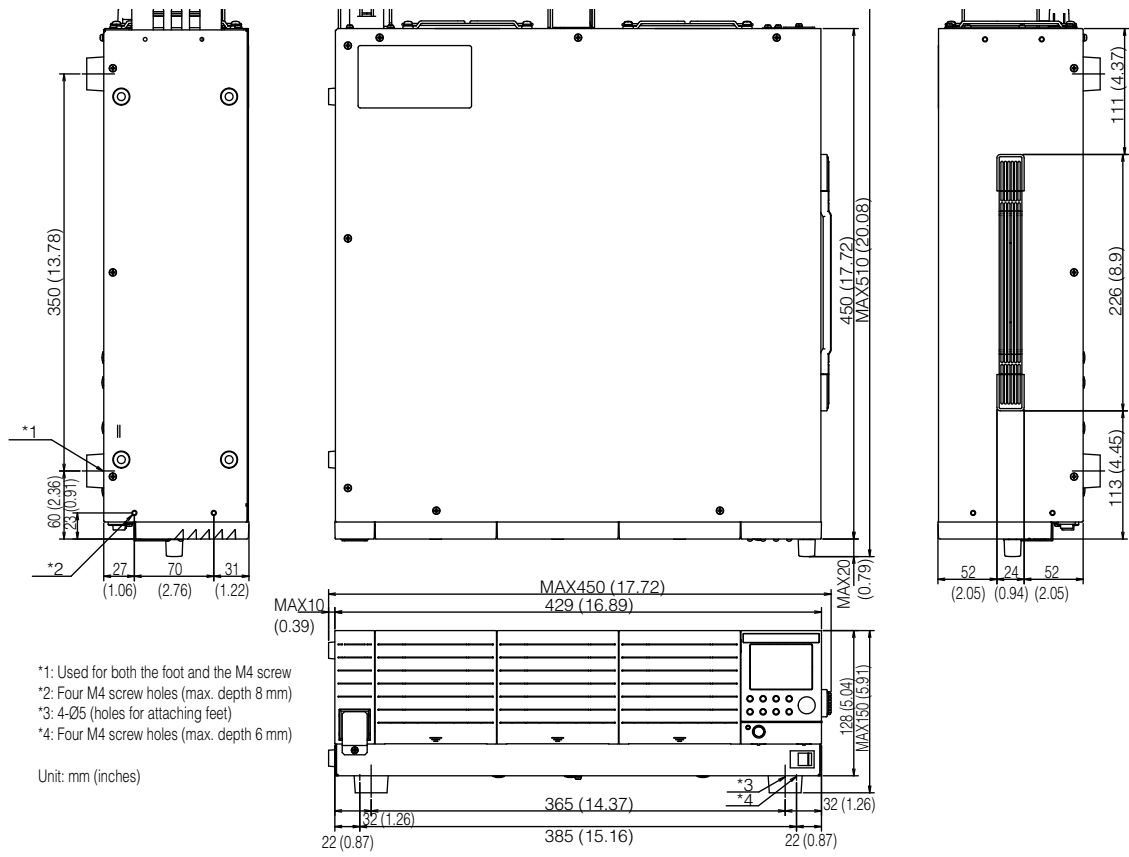

- \*1: Used for both the foot and the M4 screw
- \*2: Four M4 screw holes (max. depth 8 mm)
- \*3: 4-Ø5 (holes for attaching feet)
- \*4: Four M4 screw holes (max. depth 6 mm)

Unit: mm (inches)

### PCR4000MA

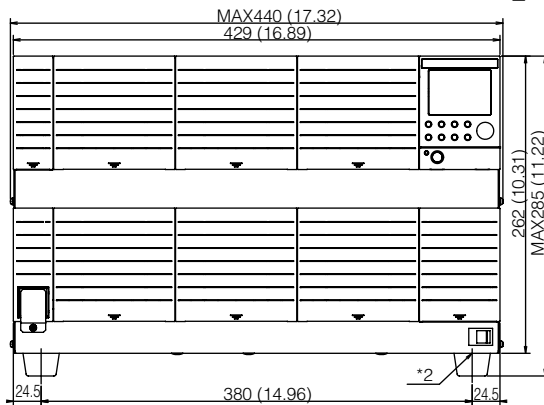
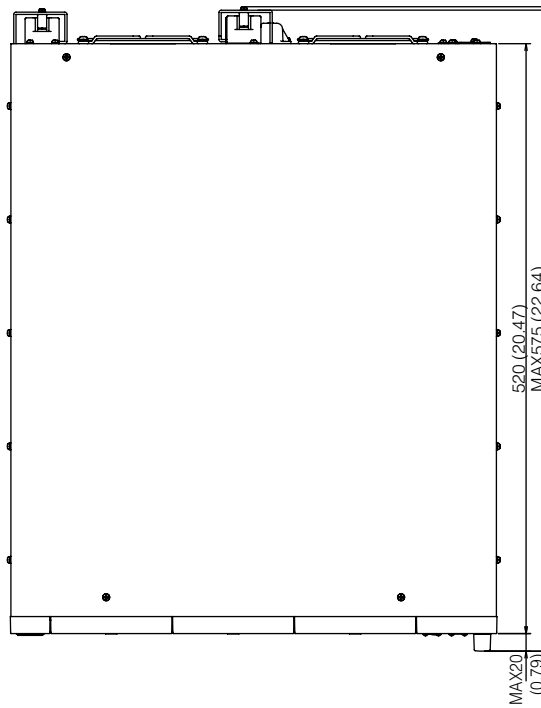
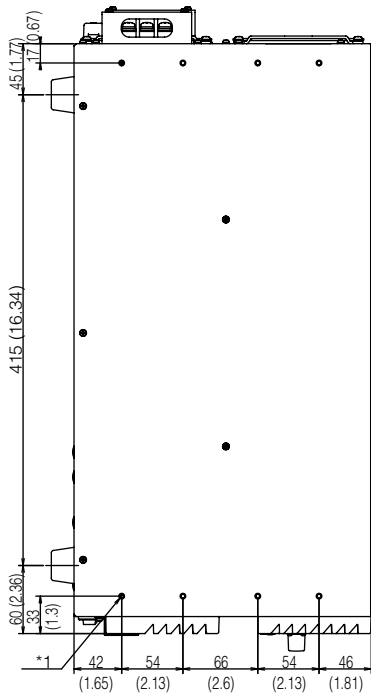

- \*1: Eight M4 screw holes (max. depth 8 mm)
- \*2: Four M4 screw holes (max. depth 8 mm)

Unit: mm (inches)

# Appendix

## Output and Load

### Rated output current in AC mode

#### Linear load

This product's rated AC output current is limited by the output capacity of this product.

	PCR500MA	PCR1000MA	PCR2000MA	PCR4000MA
Output capacity	500 VA	1 000 VA	2 000 VA	4 000 VA

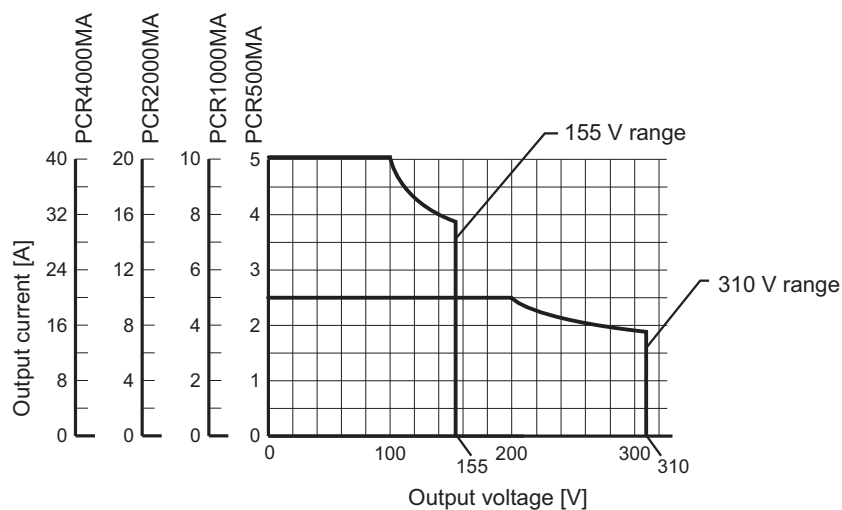

#### Capacitor-input rectifier load

In general, a peak current several times greater than the output current rms value flows near the peak of the output voltage.

In such a case, keep the maximum peak current from exceeding three times the maximum rated current.

$$155 \text{ V range: Maximum peak current} = (\text{rated output capacity}/100 \text{ V}) \times 3$$

$$310 \text{ V range: Maximum peak current} = (\text{rated output capacity}/200 \text{ V}) \times 3$$

If used exceeding the rated maximum peak current or maximum current, a protection function of this product may be activated, which may extremely distort the output voltage waveform or turn off the output.

To supply the above maximum peak current without distortion, keep the output voltage (setting) constant. If the output voltage setting is changed suddenly (increased), the voltage and current waveforms may become distorted.

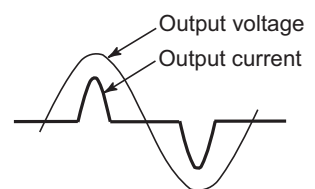

## Loads that draw an inrush current

For loads such as those listed below, when the voltage is applied to the load or when the voltage changes suddenly, an inrush current (several times to several tens of times the normal current) flows for several cycles to several tens of cycles of the output frequency.

- Transformer and slide transformer (SLIDAC) loads

When a voltage is applied to a transformer or a slide transformer, an inrush current of up to several hundreds of times the normal current will flow for several cycles depending on the timing that the voltage is applied or the residual magnetization in the transformer.

- Motor and lamp loads

When a voltage is applied to a motor or a lamp, an inrush current of several times to several tens of times the normal current flows for several tens of cycles to several hundreds of cycles.

- Capacitor-input rectifier loads

For electronic devices that have capacitor-input rectifier circuits in their input, if the device does not have an inrush current protection (limitation) circuit, an inrush current of several tens to several hundreds of times the normal current flows for several cycles.

The product can supply a maximum peak current up to three times the maximum rated current (rms value) to capacitor-input rectifier loads.

If an inrush current that exceeds the peak current flows, the protection circuit of the product will be activated, which may distort the output voltage waveform or turn off the output.

## Loads that generate surges

Some loads (for example, fluorescent lights) generate surges when the voltage is applied to the load or when the voltage is changed suddenly. When a surge occurs, the product may malfunction. Connect a noise filter or the like to the load end.

## Special loads

For loads that have a capacitor connected directly to the input, a current ranging from about 100 kHz to 150 kHz caused by the output ripple voltage of the PWM inverter system will flow through the capacitor.

## Rated output current in DC mode

The rated DC output current that can be drawn from this product is limited by the output capacity of this product as shown by the following graph.

	PCR500MA	PCR1000MA	PCR2000MA	PCR4000MA
Output capacity	400 W	800 W	1600 W	3200 W

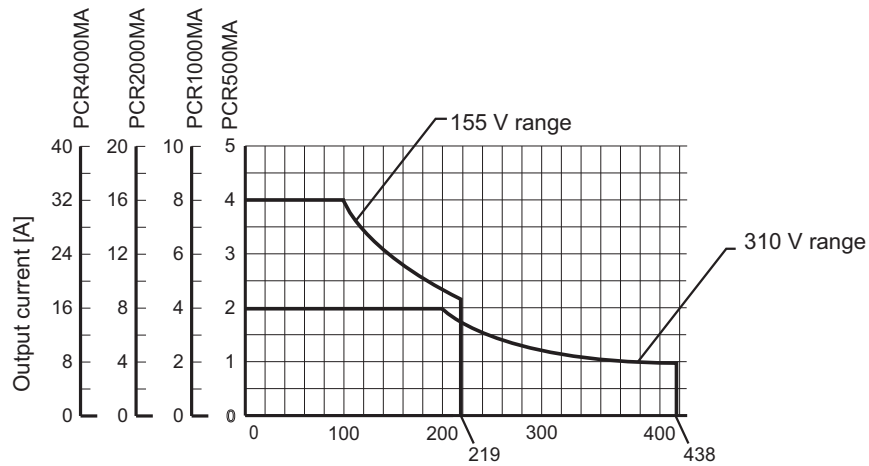

If you use the product with a current that exceeds the rated DC output current, the protection functions will be activated, which may cause the output voltage to drop or turn off the output.

# Operating Characteristics

## Output current versus input current and efficiency characteristics (typical values in AC mode)

The output current ratio is a percentage where 100 % represents the maximum rated output current.

### ■ PCR500MA/PCR1000MA

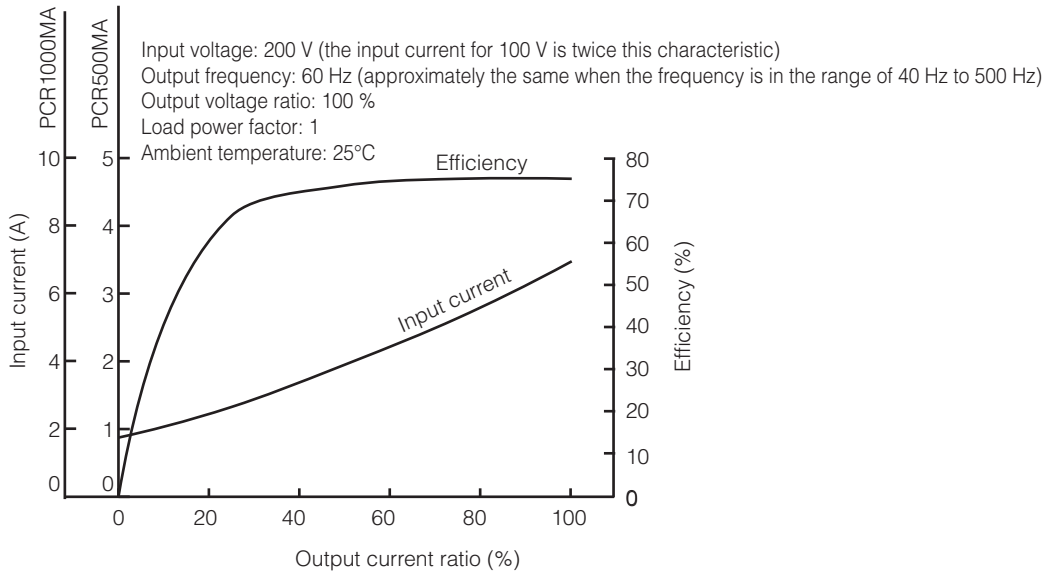

### ■ PCR2000MA/PCR4000MA

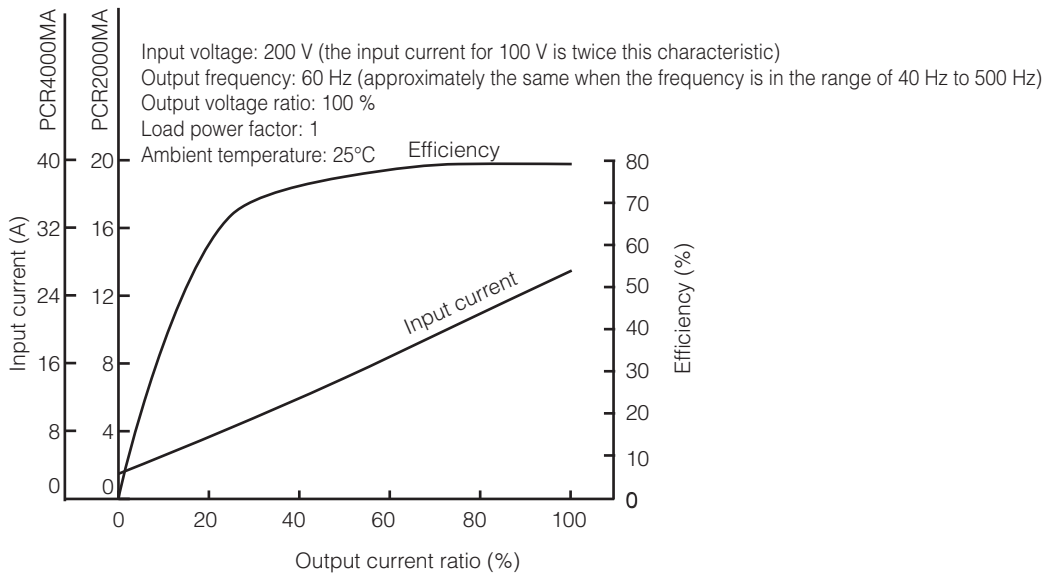



## Output voltage versus input current and efficiency characteristics (typical values in AC mode)

The output voltage ratio is a percentage where 100 % represents an output voltage of 100 V (155 V output range) or 200 V (310 V output range).

### ■ PCR500MA/PCR1000MA

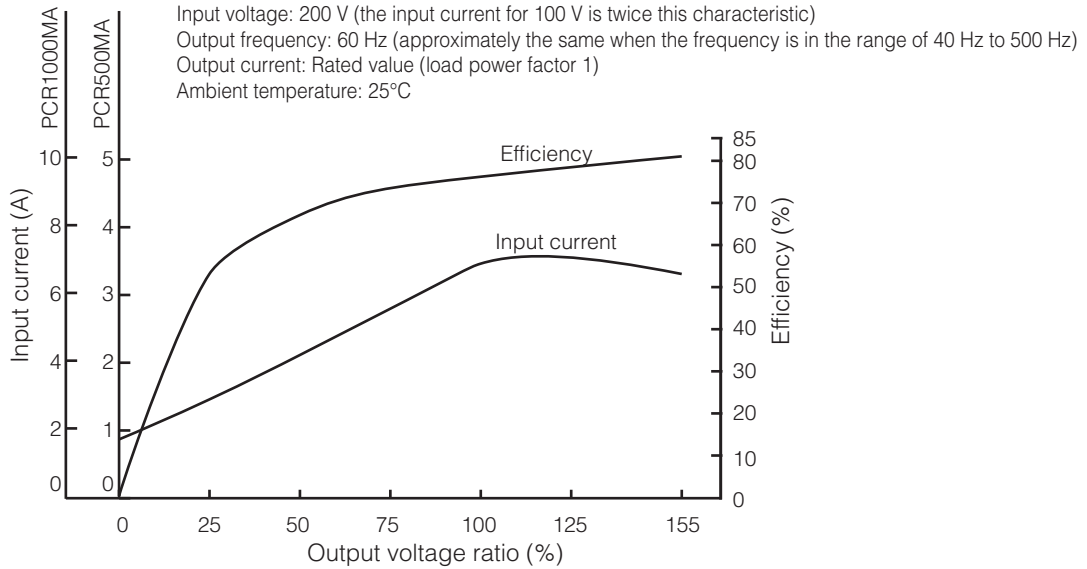

### ■ PCR2000MA/PCR4000MA

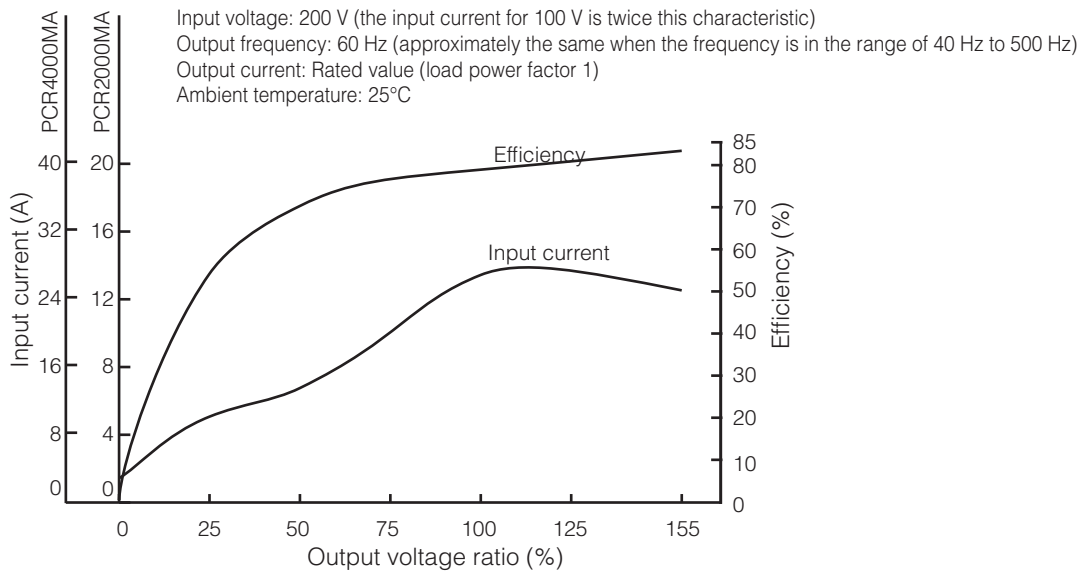

# Overload Protection Function

This product has the following three overload protection functions.

## ■ Overcurrent protection (OCP)

This function is activated when the output current exceeds the current limit (maximum setting: 1.05 times the maximum rated current). When the overcurrent protection is activated, OVER LOAD lights, and the output voltage drops gradually. If this condition continues for about 3 seconds, the output is automatically turned off.

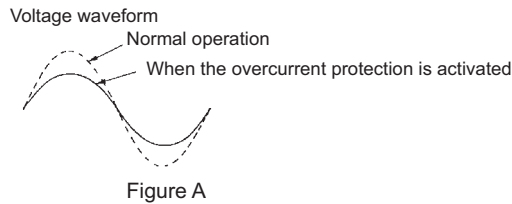

## ■ Overcurrent peak protection (OCP)

This function is activated when the peak current exceeds three times the maximum rated current. If such current flows through the load, OVER LOAD lights, the overcurrent peak protection is activated, and the waveform becomes distorted. If this condition continues for about 1 second, the output is automatically turned off.

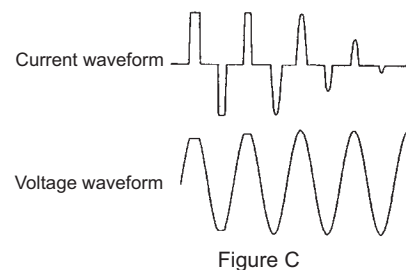
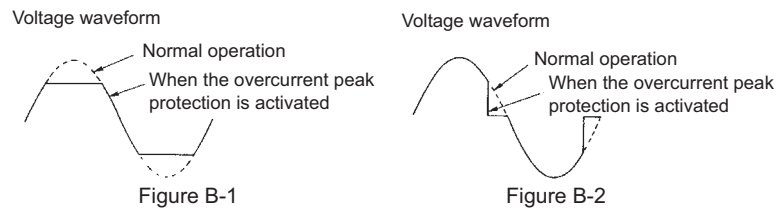

## ■ Overpower protection (OPP)

This function is activated when the output power exceeds 1.05 times the maximum rating. When the over-power protection is activated, OVERLOAD lights. If this condition continues for about 10 seconds, the output is automatically turned off.

## Causes of overload conditions and their remedies

If the overload protection function is activated, try the following remedies. Wait at least 1 minute before resuming operation.

If the cause of the overload is eliminated, the protection function is automatically released.

### ■ Linear load

Overload occurs when		Remedy
Output current is gradually increased.	If the voltage drops as shown in Figure A, the current limit function is activated. If the output voltage waveform is distorted as shown in Figure B-1 or B-2, the internal protection function is activated.	If the current limit is set low, change the value. If the maximum rated current is exceeded, reduce the load.
Output current is suddenly increased.	If the output voltage waveform is distorted as shown in Figure B-1, B-2, or C, the internal protection function is activated.	

### ■ Capacitor-input rectifier load

Overload occurs when		Remedy
Output current is increased.	If the voltage drops as shown in Figure A, the current limit function is activated.	If the current limit is set, change the value. If the maximum rated current is exceeded, reduce the load.
	If the voltage waveform is distorted as shown in Figure C, the internal protection function is activated based on the output peak current.	Decrease the peak current.

### ■ Loads that draw an inrush current

Overload occurs when		Remedy
A voltage is applied to the load or the voltage is suddenly changed.	If the voltage waveform is distorted as shown in Figure C, the internal protection function is activated based on the inrush current.	Decrease the inrush current.

# Terminology

## ■ Rated output (power) capacity or power capacity

The maximum output power capacity (in VA) that can be supplied continuously when the output voltage is 100 V to 155 V/200 V to 310 V (155 V range/310 V range) and the output frequency is 40 Hz to 500 Hz in AC mode and when the output voltage is 100 V to 319 V/200 V to 438 V (155 V range/310 V range) in DC mode.

	PCR500MA	PCR1000MA	PCR2000MA	PCR4000MA
Output capacity	500 VA	1 000 VA	2 000 VA	4 000 VA

The power capacity in DC mode is 80 % of that in AC mode.

## ■ Maximum rated current

The maximum output current (rms value) that can be supplied continuously when the output voltage is 100 V/200 V (155 V/310 V range) and the output frequency is 40 Hz to 500 Hz in AC mode and when the output voltage is 100 V/200 V (155 V/310 V range) in DC mode.

The maximum current in DC mode is 80 % of that in AC mode.

$$\text{Maximum rated current} = \frac{\text{Rated output (power) capacity [VA, W]}}{\text{Output voltage ratio 100 V or 200 V}}$$

## ■ Rated output current

- AC mode

The maximum continuous output current (rms value) that has been reduced by the output voltage.

- DC mode

The maximum continuous output current (in A) that has been reduced by the output voltage.

## ■ Maximum peak current (only in AC mode)

The maximum continuous output current (peak value) that can be supplied from this product for capacitor-input rectifier loads when the output voltage is 100 V to 155 V/200 V to 310 V (155 V/310 V range) and the output frequency is 40 Hz to 500 Hz.

Maximum peak current = rated maximum current (rms) × 3.

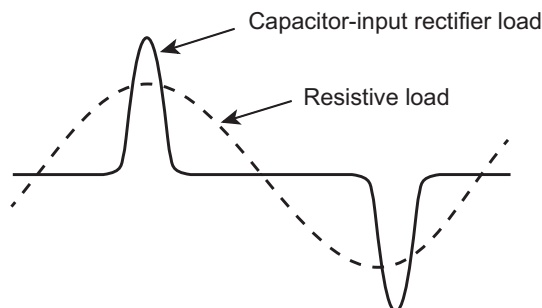

### ■ Output voltage waveform distortion ratio

The total harmonic distortion (%) of the output voltage waveform when the output voltage is 50 V to 155 V/ 100 V to 310 V (155 V/310 V range) and the load power factor is 1.

### ■ Output voltage response speed

The time (in seconds) from when the output voltage change exceeds 10 % of the total change to when it returns within 10 % when the output current ratio is varied from 0 % to 100 % when the output voltage is 100 V/200 V (155 V/310 V range) and the load power factor is 1 (in AC mode).

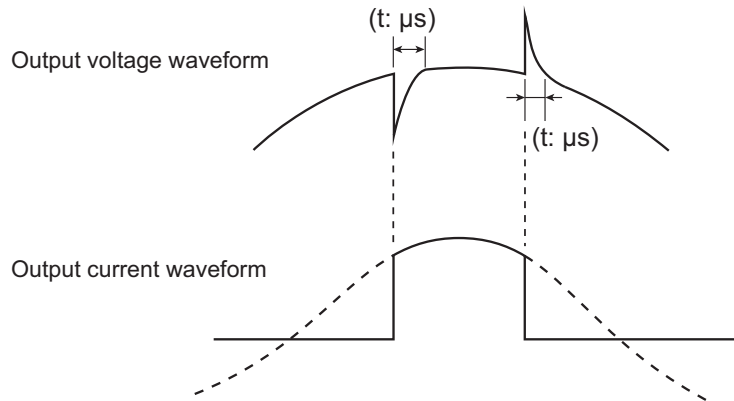

### ■ Power factor (PF)

The ratio of the active power to the apparent power. It indicates the level of inefficiency that results from the phase difference between the AC voltage and AC current.

$$\text{Power factor} = \frac{\text{Active power}}{\text{Apparent power}}$$

### ■ Form factor

The ratio of the rms value to the average value.

$$\text{Form factor} = \frac{\text{Rms value}}{\text{Average value}}$$

### ■ Crest factor (CF)

The ratio of the waveform peak value to the rms value.

$$\text{Crest factor} = \frac{\text{Peak value}}{\text{Rms value}}$$

The crest factor of a sine wave is 1.41.

### ■ Active filter

A circuit for reducing the waveform distortion (harmonic current) in the input current. It is employed in the input power section inside the product. It is an active filter that uses switching control. The power factor improves (0.9 (TYP)) as a result of the active filter.

### ■ Capacitor-input rectifier load (circuit)

A load whose rectifier circuit part is constructed as shown below. The rectifier circuit is used to convert the input AC voltage into the DC voltage that the device needs to operate.

The peak input current is normally approximately two to four times the rms value. The conduction angle (the period that the current is flowing for) centered on the peak output voltage (phase angle of 90 deg or 270 deg) is approximately 20 deg to 90 deg.

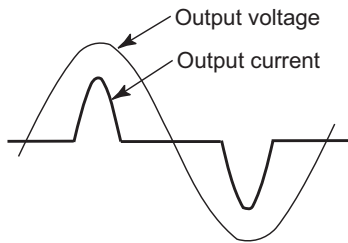
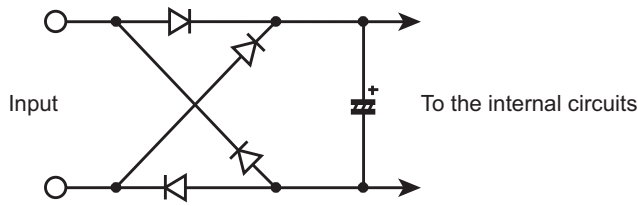
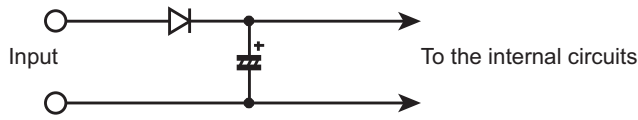

# Options

## Interface boards

The following two optional interface boards are available.

- GPIB interface board (IB22)

An interface board for controlling the product through GPIB.

- Analog interface board (EX08-PCR-MA)

An interface board for controlling the output with external analog signals. The following functions are expanded.

- EXT-AC mode controls the voltage of the output AC waveform (sine wave) using DC signals
- EXT-DC mode simply amplifies the input signal waveform and outputs the result

### Installing an interface board

Insert the interface board in the option slot on the rear panel.

- 1** Turn off the **POWER** switch.
- 2** Touch a grounded metal object (for example, the metal parts of the rear panel) to discharge any static electricity from your body.
- 3** Remove the screws that are holding the slot covers in place on the rear panel, and remove the covers from the panel.

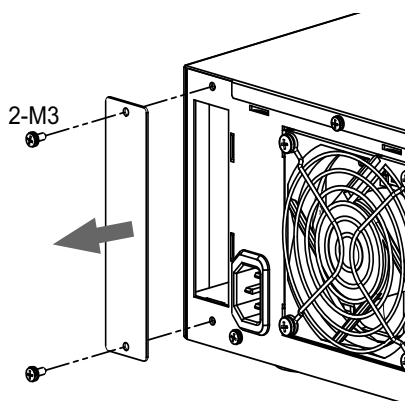

- 4** Hold the panel parts of the board so that the printed circuit board side is facing to the right.

- 5** Insert the board into the slot so that the printed circuit board's connector is inserted into the connector at the back of the slot.

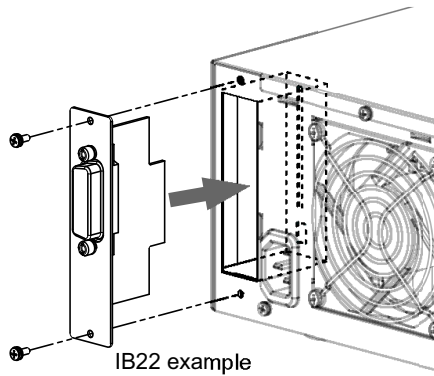

- 6** Insert the board all the way into the slot.
- 7** Secure the board to the panel using the screws that were holding the slot cover.

## Rack-mount frames and brackets

By using the rack mount frames, you can mount the PCR500MA to a standard Kikusui rack.

The PCR1000MA, PCR2000MA, and PCR4000MA can be mounted on a standard Kikusui rack by using the rack mount brackets.

The following table lists the frames and brackets that are used to rack mount the product. For information on rack mounting, see the operation manual of the relevant frame and bracket.

	Name	Description
PCR500MA	KRA3	EIA inch rack
	KRA150	JIS millimeter rack
	KBP3-2	Blank panel
PCR1000MA	KRB3-TOS	EIA inch rack
PCR2000MA	KRB150-TOS	JIS millimeter rack
PCR4000MA	KRB6	EIA inch rack
	KRB300	JIS millimeter rack

Detach the feet and handles before you mount the product to a rack mount frame.



## Removing the feet and handles

We recommend that you keep all pieces that you have removed from the product. You will need these pieces if you remove the product from the rack.

**NOTE** To reinstall the handle that has been removed, use screw locking agent (e.g., 1401B by ThreeBond International, Inc.) to prevent screws from loosening.

### ■ PCR500MA

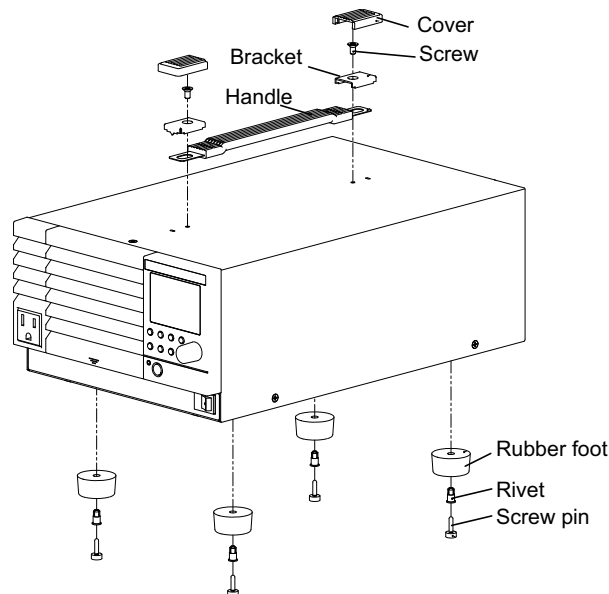

- 1** Remove the handle cover (two locations).
- 2** Unfasten the two screws, and remove the entire handle.
- 3** While pulling down on the feet (four locations) at the bottom of the product, remove the screw pins to detach the feet.

■ PCR1000MA/ PCR2000MA

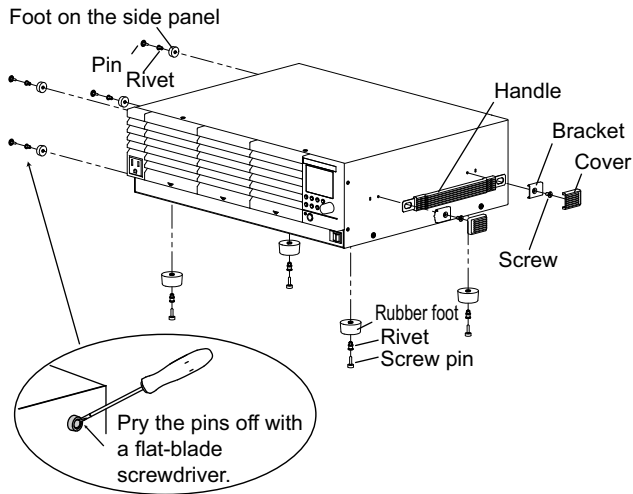

- 1** Remove the handle cover (two locations).
- 2** Unfasten the two screws, and remove the entire handle.
- 3** While pulling down on the feet (four locations) at the bottom of the product, remove the screw pins to detach the feet.
- 4** Unfasten the internal pins from the rubber feet (four locations) of the side panel using a flat-blade screwdriver, and then remove the feet.

■ PCR4000MA

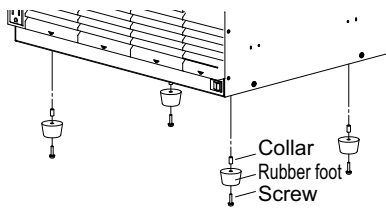

Remove the four screws holding the feet at the bottom of the product, and remove the feet.

## Outline diagram and dimensions

Unit: mm (inches)

### ■ PCR500MA

When mounting on an inch rack  
(Bracket model: KRA3)

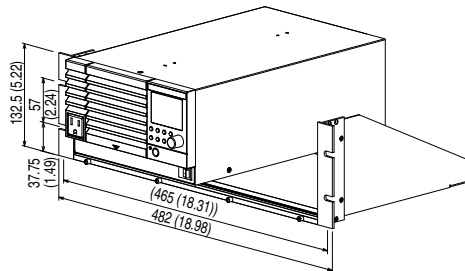

When mounting on a millimeter rack  
(Bracket model: KRA150)

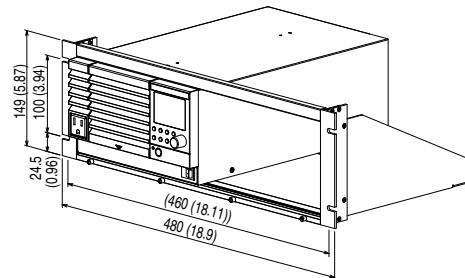

### ■ PCR1000MA/ PCR2000MA

When mounting on an inch rack  
(Bracket model: KRB3-TOS)

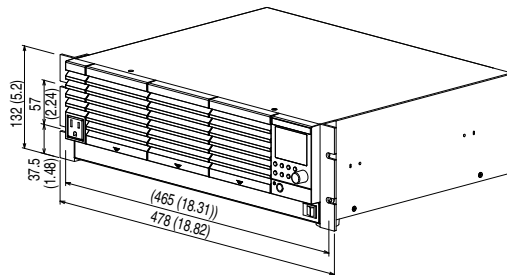

When mounting on a millimeter rack  
(Bracket model: KRB150-TOS)

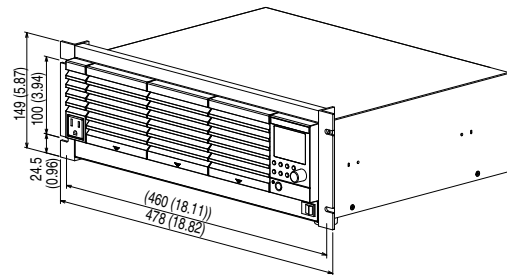

### ■ PCR4000MA

When mounting on an inch rack  
(Bracket model: KRB6)

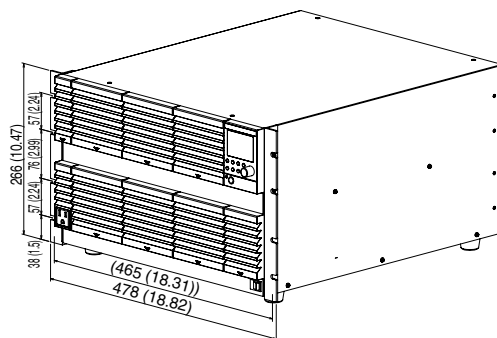

When mounting on a millimeter rack  
(Bracket model: KRB300)

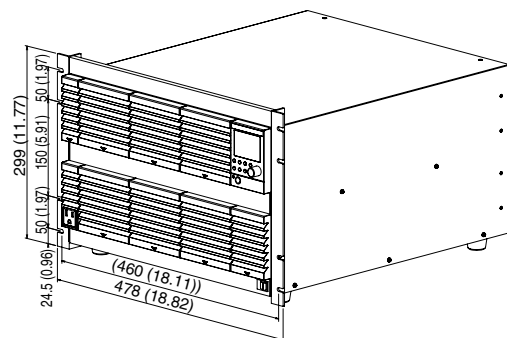

# Factory Default Settings (Initialization)

Turning on the POWER switch while holding RECALL resets all the parameters in the following table to their factory default settings.

Parameter	PCR-MA
Output	Off
Output mode	AC
Voltage range	155 V
Voltage	AC 0.0 V
	DC 0.0 V
Frequency	60.0 Hz
Measurement display	RMS
Panel setting lock	Unlocked

## ■ Limits

Parameter	PCR500MA	PCR1000MA	PCR2000MA	PCR4000MA	
AC	Upper AC voltage limit	315.0 V			
	Lower AC voltage limit	0.0 V			
	Current limit	5.25 A	10.50 A	21.00 A	42.00 A
	Frequency upper limit	500.0 Hz			
	Frequency lower limit	40.0 Hz			
DC	Upper AC voltage limit	445.0 V			
	Lower AC voltage limit	0.0 V			
	Current limit	4.20 A	8.40 A	16.80 A	33.60 A
Current limit operation	TRIP				

## ■ and Configuration

Parameter	PCR-MA
Output-on phase	OFF
Phase angle	0 deg
Measurement averaging	1
Peak hold time	SHORT
LAN interface	ON
IP address assignment	AUTO
Subnet mask	16
USB interface	ON
GPIB interface	ON
GPIB address	5
Communication error trace function	OFF
PCR-M compatible mode	DEF
Power-on status setting	AUTO

### ■ Memories A, B, and C

Parameter		PCR500MA	PCR1000MA	PCR2000MA	PCR4000MA
Voltage	AC	0.0 V			
	DC	0.0 V			
Frequency	60.0 Hz				
Voltage range	155 V				
Output mode	AC				
Limits AC	Upper AC voltage limit	315.0 V			
	Lower AC voltage limit	0.0 V			
	Current limit	5.25 A	10.50 A	21.00 A	42.00 A
	Frequency upper limit	500.0 Hz			
	Frequency lower limit	40.0 Hz			
Limits DC	Upper AC voltage limit	445 V			
	Lower AC voltage limit	0.0 V			
	Current limit	4.20 A	8.40 A	16.80 A	33.60 A
Current limit operation	TRIP				

# Troubleshooting

This section introduces troubleshooting measures. Typical symptoms are listed. In some cases, the problem can be solved quite easily.

If you can find an item that matches your situation, follow the remedies that are listed. If none of the items apply to your case, we recommend that you initialize the product (this will clear the contents of the memory). If following the remedy shown here does not solve the problem, contact your Kikusui agent or distributor.

## ■ The control panel display does not light when the POWER switch is turned on.

Check	Result	Possible cause	Remedy
Is the rated voltage being applied to the AC inlet/ INPUT terminal block?	No	<ul style="list-style-type: none"> <li>Broken power cord</li> <li>Bad connection at the AC inlet of the rear panel (PCR500MA)</li> <li>Incorrect connection of the power cord (other than PCR500MA)</li> </ul>	Check that the power cord is not broken and that the connection is secure. (PCR500MA: <a href="#">p.11</a> , other than PCR500MA: <a href="#">p.12</a> )
	Yes	The product is malfunctioning.	Remove the power plug from its outlet or turn off the breaker of the switchboard. Immediately stop using the product, and have it repaired.

## ■ An alarm sounds when the POWER switch is turned on.

Check	Result	Possible cause	Remedy
Is the ALARM LED lit or is an error number displayed?	Yes	An alarm or error occurred.	Check the alarm ( <a href="#">p.34</a> ) or error ( <a href="#">p.35</a> ) type.
	No	Memory error	The product was initialized due to a memory error. The contents of the memory are cleared. If an alarm sounds numerous times, have the product repaired.

## ■ An alarm sounds or the ALARM LED lights.

Check	Result	Possible cause	Remedy
Is an alarm number or error number displayed?	Yes	There is an internal or external error.	Check the alarm ( <a href="#">p.34</a> ) or error ( <a href="#">p.35</a> ) type.
Is the fan stopped?	Yes	Overheat protection (alarm A-04: <a href="#">p.34</a> ) was activated due to a fan failure.	Immediately stop using the product, and have it repaired.
Are the vent or inlet holes blocked?	Yes	<ul style="list-style-type: none"> <li>Overheat protection (alarm A-04:<a href="#">p.34</a> ) was activated.</li> <li>The dust filter is clogged.</li> </ul>	Move the product so that there is at least 20 cm of space between the vents and the surrounding walls. Do not place objects within 20 cm of the vents. Clean the dust filter to remove any clogs. ( <a href="#">p.48</a> )
Is the ambient temperature above 40°C?	Yes	Overheat protection (alarm A-04: <a href="#">p.34</a> ) was activated.	Use the product in an environment in which the ambient temperature is 40 °C or less. Keep devices that generate a high temperature away from the product.

If none of the items above applies, see "Clearing alarm and error" ([p.34](#)).

### ■ A portion of or the entire control panel does not work.

Check	Result	Possible cause	Remedy
Is the KEYLOCK LED lit?	Yes	The panel controls are locked.	Release the panel control lock. (p.32)
Is the input voltage within the rated range?	No	There is an input voltage error.	Connect to an AC power line that is compatible with the input ratings of this product. (PCR500MA: p.11 , other than PCR500MA:p.12 )
Is there a device nearby that is generating a lot of noise?	Yes	The product is malfunctioning because of noise.	Remove the product from the source of the noise.
Is the REMOTE LED lit?	Yes	The product is being controlled via the LAN, USB, or GPIB interface.	Normal. To control the product from the panel, press the LOCAL key to switch to local mode.
Are the voltage and frequency limits set to values within the settable ranges?	No	The limit settings are inappropriate.	Set the limits to correct values. (p.28)

### ■ The output voltage waveform is distorted.

Check	Result	Possible cause	Remedy
Is OVER LOAD lit?	Yes	The overload protection was activated.	The product may be overloaded. Inspect the load.
	No	The product is malfunctioning.	Immediately stop using the product, and have it repaired.

### ■ On the measurement display, the voltage does not change even when the rotary knob is turned.

Check	Result	Possible cause	Remedy
Did you press F, LIMIT, or CONFIG after pressing V?	Yes	The rotary knob is disabled.	Press V twice. The measurement display will appear, and the voltage will change.

### ■ The DC output cannot be set to a negative voltage.

Check	Result	Possible cause	Remedy
Is the lower voltage limit set to a negative voltage?	No	The limit settings are inappropriate.	Set the lower voltage limit to a negative value. (p.28) In DC mode, the factory default lower voltage limit is 0.0 V.

### ■ The product does not switch to local mode even when I press the LOCAL key.

Check	Result	Possible cause	Remedy
Was a local lockout (LLO) command sent through the communication interface?	Yes	Local keys are disabled through local lockout (LLO).	Use a communication command to clear the local lockout (LLO) command.

### ■ The specified voltage cannot be displayed.

Check	Result	Possible cause	Remedy
Is the SENSE switch turned on (RMT)?	Yes	The sensing function is turned on.	Turn off the SENSE switch (LCL). <a href="#">(p.41)</a>

### ■ The output operation is unstable.

Check	Result	Possible cause	Remedy
Are the load cables twisted (run alongside each other)?	Yes	The product is malfunctioning.	Immediately stop using the product, and have it repaired.
	No	The wiring conductance is large.	Connect by twisting the load wires (running them alongside each other).

### ■ No signal is output from the outlet.

Check	Result	Possible cause	Remedy
Is a signal being output from the OUTPUT terminal block of the rear panel?	Yes	The internal outlet fuse is blown.	Have the product repaired.



# Index

## A

AC mode .....	22
AC+DC mode .....	22
accessories .....	3
active filter .....	69
alarm number .....	34
alarms	
clearing .....	34
analog interface board .....	71
averaging period .....	36

## B

bottom numeric display .....	27
------------------------------	----

## C

calibration .....	47
Capacitor-input rectifier loads .....	70
Cleaning .....	48
communication error trace function .....	37
component names .....	8
CONFIG .....	36
CONFIG settings .....	36
Crest factor .....	69
Current limit .....	29

## D

DC mode .....	22
dust filter .....	48

## E

error number .....	35
errors	
clearing .....	35
EX08-PCR-MA .....	71
EXT-AC mode .....	22, 44
EXT-DC mode .....	22, 45
external analog signal .....	43
external dimensions .....	58

## F

factory default settings .....	76
feet, removing .....	73
firmware version .....	15
form factor .....	69
frequency	
limit .....	29
setting .....	25

## G

GPIB address .....	37
--------------------	----

## H

handles, removing .....	73
-------------------------	----

## I

IB22 .....	71
initialize .....	76
interface board, installation .....	71

## K

KEY LOCK .....	32
----------------	----

## L

LIMIT CONTROL .....	29
limit setting .....	28
LONG .....	36

## M

maximum peak current .....	68
maximum rated current .....	68
measurement	
averaging .....	36
display .....	27
memory .....	30

## O

options .....	71
outlet .....	21
OUTPUT	
on-phase .....	36
terminal block .....	17
output	
on phase angle .....	26
output mode .....	22
output on/off .....	26
output-on phase angle .....	26
OVER LOAD .....	33
overhaul .....	47

## P

panel control, locking .....	32
PCR-M compatible mode .....	37, 42
Peak hold time .....	36
phase angle .....	36
power .....	68
power cord	
connecting (PCR1000MA to PCR4000MA) .....	12

connecting (PCR500MA) .....	11
power factor .....	69
power on/off .....	15
POWER switch .....	15
power-on status setting .....	37
protection functions .....	33

## R

rack mount .....	72
rated output capacity .....	68
remote control .....	42
remote/local switching .....	42

## S

sensing .....	40
sensing function	
on/off .....	41
SHORT .....	36
single-core wires connected to the load .....	17
specifications .....	50

## T

top numeric display .....	27
TRIP .....	29
Troubleshooting .....	78

## V

voltage limit .....	29
voltage range .....	23
voltage setting .....	24



If you find any misplaced or missing pages in the manuals, they will be replaced. If the manual gets lost or soiled, a new copy can be provided for a fee. In either case, please contact your Kikusui agent or distributor. At that time, inform your agent or distributor of the "Part No." written on the front cover of this manual.

Every effort has been made to ensure the accuracy of this manual. However, if you have any questions or find any errors or omissions, please contact your Kikusui agent or distributor.

After you have finished reading this manual, store it so that you can use it for reference at any time.

## KIKUSUI ELECTRONICS CORP.

---

1-1-3 Higashiyamata, Tsuzuki-ku, Yokohama,  
224-0023, Japan

Phone: +81-45-482-6353

Facsimile: +81-45-482-6261

[www.kikusui.co.jp/en/](http://www.kikusui.co.jp/en/)

