



**KIKUSUI**

PART NO. IB026326

Jan. 2016

# User's Manual

## AC Power Supply PCR-M Series

**PCR500M**

**PCR1000M**

**PCR2000M**

**PCR4000M**

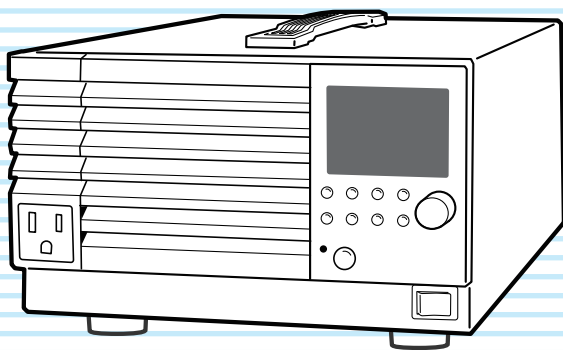

### Installation and Preparation

Connecting the Power Cord (PCR500M)	3
Connecting the Power Cord (PCR1000M - PCR4000M)	4
Turning the Power On	7
Connecting the Load	8

### Operation

Front panel	12
Rear panel	14
Switching the Output Mode	15
Setting the Voltage Range	15
Setting the Voltage	16
Setting the Frequency	16
Turning the OUTPUT On/Off	17
Measured value display	18
Setting the limit value	19
Using Memories	20
Switching from remote control to local control	21
Locking (Prohibiting) the Panel Operation	21
Protection Functions and Alarm Errors	22
Setting the Configuration	24
Controlling the Output Using External Analog Signals (Option)	26

### Specifications

Electrical specifications	29
General Specifications	32
Interface Specifications	33
Dimensions	35

### Appendix

Output and Load	39
Operating Characteristics	41
Overload Protection Functions	42
Glossary	43
Options	45
Factory Default Settings (Initialization)	48
Maintenance	49
Troubleshooting	51

### INDEX

This manuals are intended for users of the PCR-M Series AC Power Supply and their instructors.

Explanations are given under the presumption that the reader has knowledge related to electric safety tests.

Every effort has been made to ensure the accuracy of this manual. However, if you have any questions or find any errors or omissions, please contact your Kikusui agent or distributor.

If you find any misplaced or missing pages in this manual, it will be replaced. If the manual gets lost or soiled, a new copy can be provided for a fee. To replace or purchase a manual, please contact your Kikusui agent or distributor. At that time, inform your agent or distributor of the "Part No." written on the front cover of this manual.

After you have finished reading this manual, store it so that you can use it for reference at any time.

## Notations used in this manual

In this manual, the PCR-M Series AC Power Supply is also referred to as the PCR-M Series and the PCR-M.

The term "PC" is used to refer generally to both personal computers and workstations.

The screen captures used in this manual may differ from the actual screens that appear on the PCR-M. The screen captures are merely examples.

The following markings are used in the explanations in the manual.

**WARNING**  
Indicates a potentially hazardous situation which, if ignored, could result in death or serious injury.

**CAUTION**  
Indicates a potentially hazardous situation which, if ignored, may result in damage to the product or other property.

**-Note-**  
Indicates information that you should know.

**- DESCRIPTION -**  
Explanation of terminology or operation principle.

(SHIFT+key name)

Indicates an operation in which a key marked in blue is pressed while holding down the SHIFT key.

## Firmware version of the product to which this manual applies

This manual applies to PCR-Ms with firmware version 1.3x.

When making an inquiry about the product, please provide us with the following information.

Model (indicated at the top section on the front panel)

Firmware version

Serial number (indicated at the bottom section on the rear panel)

## Accessory

for PCR500M (1 pc., Length: approx. 2.5 m)



Rated voltage: 125 Vac  
PLUG: NEMA5-15  
[85-10-0740]

Rated voltage: 250 Vac  
PLUG: CEE7/7  
[85-AA-0005]

Rated voltage: 250 Vac  
PLUG: GB1002  
[85-10-0790]

for PCR1000M (1 pc.)



Length: approx. 3m  
Nominal cross-sectional area: 3.5 mm<sup>2</sup>  
[85-10-0630]

PLUG: NEMA5-15  
Length: approx. 2.8m  
Nominal cross-sectional area: 2 mm<sup>2</sup>  
[85-10-0650]

This power cord with the plug can be used for the input voltage of 114 Vac to 125 Vac. It can not be used except for those specified range.

for PCR2000M  
(1 set, Length: approx. 3 m,  
Nominal cross-sectional area: 5.5 mm<sup>2</sup>)

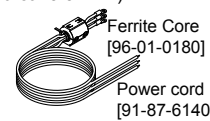

Ferrite Core  
[96-01-0180]

Power cord  
[91-87-6140]

for PCR4000M  
(1 set, Length: approx. 3 m  
Nominal cross-sectional area: 14 mm<sup>2</sup>)

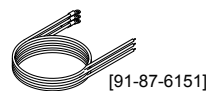

[91-87-6151]

- Power cord  
The power cord that is provided varies depending on the destination for the product at the factory-shipment.

- Cable Tie  
(Only PCR2000M) (1 pc.)  
[P4-200-001]

- Ferrite Core  
(Only PCR2000M) (1 pc.)  
[96-01-0180]

- Heavy object warning label  
If necessary, attach to the product.  
(Only PCR4000M)

- Read This First (1 pc.)

- Quick Reference  
English (1 pc.), Japanese (1 pc.)

- Safety Information (1 pc.)

- CD-ROM (1 pc.)

Copyright© 2008 Kikusui Electronics Corporation

# Installation and Preparation

## Connecting the Power Cord (PCR500M)

The power cord provided with the product varies depending on the type. This product is designed as an equipment of IEC Overvoltage Category II (energy-consuming equipment supplied from the fixed installation).

### WARNING

**Possible electric shock.**

- This product is an IEC Safety Class I equipment (equipment with a protective conductor terminal). Be sure to ground (earth) the unit.
- Connect the protective conductor terminal to earth ground.

### CAUTION

If the voltage distortion of the AC power line is large, it can lead to malfunction. The PCR-M cannot be connected to a generator or a similar device.

- Note -

- Use the supplied power cord to connect to the AC line. If the supplied power cord cannot be used due to the rated voltage or the plug shape, have a qualified engineer replace it with an appropriate power cord of length 3 m or less. If obtaining a power cord is difficult, consult your Kikusui agent or distributor.
- The power cord with a plug can be used to disconnect the PCR-M from the AC line in an emergency. Connect the plug to an easily accessible power outlet so that the plug can be removed from the outlet at any time. Be sure to allow enough space around the power outlet.
- Do not use the supplied power cord on other instruments.

### **1 Check that the AC power line complies with the input rating of the PCR-M.**

The voltage that can be applied is any of the nominal power supply voltages in the range of 100 Vac to 120 Vac or 200 Vac to 240 Vac. The frequency is 50 Hz or 60 Hz.

### **2 Check that the POWER switch is turned off.**

### **3 Connect the power cord to the AC INPUT inlet on the rear panel.**

### **4 Insert the power plug to an outlet.**

## Connecting the Power Cord (PCR1000M - PCR4000M)

This product conforms to IEC Overvoltage Category II (energy-consuming equipment that is supplied from a fixed installation).

### **⚠ WARNING**

#### **Possible electric shock.**

- **This product is an IEC Safety Class I equipment (equipment with a protective conductor terminal). Be sure to ground (earth) the unit.**
- **Connect the protective conductor terminal to earth ground.**
- **Turn off the circuit breaker of switchboard before connecting the cord.**
- **Do not use the terminal block with the terminal cover removed.**

#### **Possible Fire.**

- **The breaker of switchboard is required to meet following requirement.**
- **Have a qualified engineer connect the power cord to the switchboard.**

### **⚠ CAUTION**

If the voltage distortion of the AC power line is large, it can lead to malfunction. The PCR-M cannot be connected to a generator or a similar device.

Inside the product, protective circuits including input fuses are connected to match the polarity of the input terminal. Make sure the colors of the wires connected to the corresponding input terminals (L, N, and ⊕(GND)) are correct.

#### **- Note -**

Turn off the circuit breaker of switchboard to disconnect the PCR-M from the AC line in an emergency.

### **Circuit breaker of switchboard requirement**

- **Rated current**  
 PCR1000M: 20 A (The circuit breaker of which the rated current is more than 20 A is disabled for safety.)  
 PCR2000M: 40 A (The circuit breaker of which the rated current is more than 40 A is disabled for safety.)  
 PCR4000M: 80 A (The circuit breaker of which the rated current is more than 80 A is disabled for safety.)
- **Dedicate the circuit breaker for the PCR-M.**
- **Keep the switchboard easily accessible at any time.**
- **Require labeling to identify that the circuit breaker is dedicated for the PCR-M and disconnecting device.**

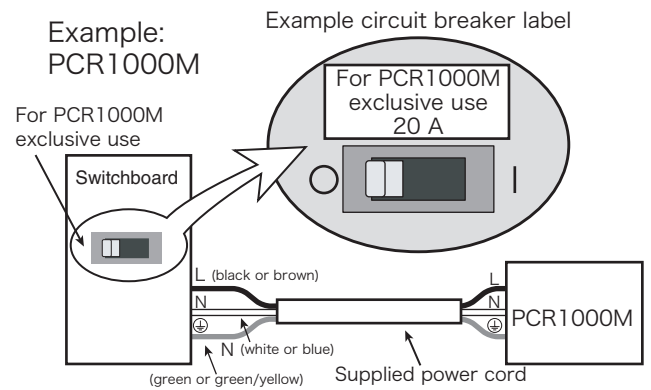

## For PCR1000M (power cord with plug)

### 1 Check that the AC power supply meets the nominal input rating of the PCR-M.

The voltage that can be applied is any of the nominal power supply voltages in the range of 100 Vac to 120 Vac or 200 Vac to 240 Vac. The frequency is 50 Hz or 60 Hz.

### 2 Turn off the POWER switch.

### 3 Remove the terminal cover that is attached to the AC INPUT terminal block.

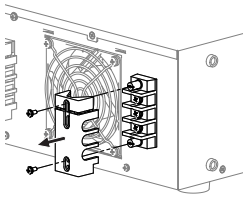

### 4 Securely connect the power codes to corresponding terminals of AC INPUT terminal block.

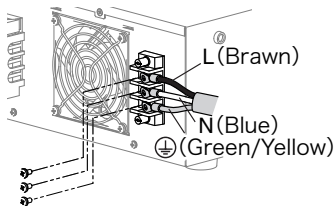

### 5 Put the terminal cover back to the terminal block that you removed in procedure 3 .

Use holes on lower side to attach the terminal cover.

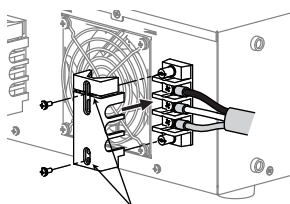

Use the lower holes.

### 6 Insert the power plug to an outlet

## For PCR1000M (power cord without plug)

### 1 Check that the AC power supply meets the nominal input rating of the PCR-M.

The voltage that can be applied is any of the nominal power supply voltages in the range of 100 Vac to 120 Vac or 200 Vac to 240 Vac. The frequency is 50 Hz or 60 Hz.

### 2 Turn off the POWER switch.

### 3 Remove the terminal cover that is attached to the AC INPUT terminal block.

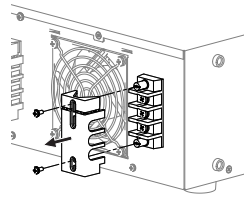

### 4 Securely connect the power codes to corresponding terminals of AC INPUT terminal block.

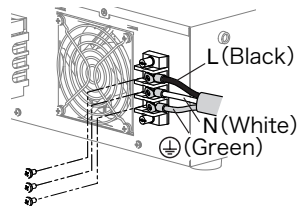

### 5 Put the terminal cover back to the terminal block that you removed in procedure 3 .

Use holes on lower side to attach the terminal cover.

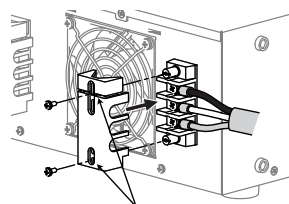

Use the lower holes.

### 6 Attach crimp terminals to the switchboard end of the power cord.

The switchboard end of the input power cable is not provided with terminals. For termination, attach a crimp-style terminal to each wire that meets the terminal screws of the switchboard to be connected, and then securely connect the wires to the terminal screws. Connection must be performed by qualified personnel.

### 7 Turn off the switchboard.

### 8 Securely connect the power codes to corresponding terminals of switchboard's breaker.

### 9 Turn on the switchboard.

## Connecting the Power Cord (PCR1000M - PCR4000M)

### For PCR2000M/ PCR4000M

The figure is an example of the PCR2000M.

**1 Check that the AC power supply meets the nominal input rating of the PCR-M.**

The voltage that can be applied is any of the nominal power supply voltages in the range of 100 Vac to 120 Vac or 200 Vac to 240 Vac. The frequency is 50 Hz or 60 Hz.

**2 Turn off the POWER switch.**

**3 Remove the terminal cover that is attached to the AC INPUT terminal block.**

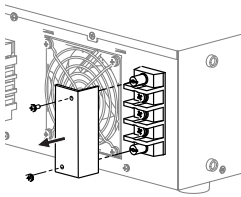

**4 Securely connect the power codes to corresponding terminals of AC INPUT terminal block.**

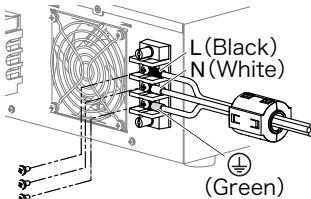

**5 Put the terminal cover back to the terminal block that you removed in procedure 3 .**

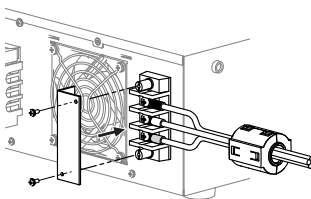

**6 Attach crimp terminals to the switchboard end of the power cord.**

The switchboard end of the input power cable is not provided with terminals. For termination, attach a crimp-style terminal to each wire that meets the terminal screws of the switchboard to be connected, and then securely connect the wires to the terminal screws. Connection must be performed by qualified personnel.

**7 Turn off the switchboard.**

**8 Securely connect the power codes to corresponding terminals of switchboard's breaker.**

**9 Turn on the switchboard.**

## Turning the Power On

### Turning the POWER switch on

Turn the power on without the load connected.

- 1 Check that nothing is connected to the OUTPUT terminal block on the rear panel and the OUTPUT outlet on the front panel.**
- 2 Check that the power cord is correctly connected.**
- 3 Flip the POWER switch to the ( | ) side to turn the PCR-M Series on.**

If an odd sound, odd odor, fire, or smoke occurs around or in the PCR-M, remove the power plug from the outlet or turn off the switchboard.

The firmware version is displayed for few seconds, and a self-test is carried out. If no error is detected, the measured value display appears.

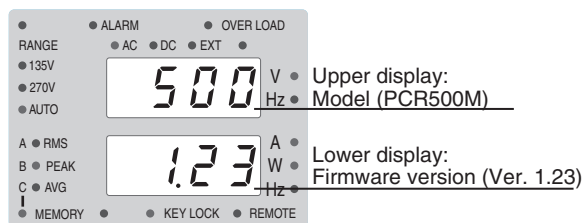

Checking the firmware version  
(Example: Ver.1.23, PCR500M)

If the POWER switch is turned on for the first time after purchasing the PCR-M, the PCR-M starts up using factory default settings. For all other cases, the PCR-M starts up using the settings that existed when the POWER switch was turned off the last time.

If the ALARM LED illuminates or an error number is displayed, see page 22 “Protection Functions and Alarm Errors”.

### Turning the POWER switch off

Push the ( ○ ) side of the POWER switch to turn the PCR-M off.

The PCR-M stores the values below at 5-second intervals. When the POWER switch is turned on, these items start up with the values that existed when the POWER switch was turned off the last time.

- Output voltage and frequency settings
- Output voltage range (135 V, 270 V, or AUTO)
- Limit value settings
- Output mode (AC, DC, or EXT)
- Measured value display (RMS, PEAK, AVG, or W)
- Locking the Panel Operation
- Configuration

The output on/off state is not stored. The PCR-M always starts up with the output turned off when the power is turned on.

If the POWER switch is turned off immediately after changing the settings, the last settings may not be stored.

#### CAUTION

Risk of malfunction. After turning the POWER switch off, wait at least 5 seconds before turning it back on.

## Connecting the Load

The maximum current that the PCR-M Series can generate varies depending on the model. It also varies depending on the PCR-M Series' output mode, load type, and status. Ensure that the output power capacity is sufficient for the load capacity. The maximum output currents (in AC mode - AC rms, with an output voltage of 1 V to 100 V or 2 V to 200 V, and with a load power factor of 0.8 to 1) for the different models are shown in the table.

Voltage range	PCR500M	PCR1000M	PCR2000M	PCR4000M
135V	5 A	10 A	20 A	40 A
270V	2.5 A	5 A	10 A	20 A

### Connecting to the OUTPUT terminal block

#### ■ Preparation of Wire

For connecting the load, use the noncombustible type of load wires which must be rated to carry the maximum rated output current.

#### Requirements for single-core cables used to connect to the load

Nominal Cross-Sectional Area[mm <sup>2</sup> ]	AWG	(Reference cross-sectional area) [mm <sup>2</sup> ]	Allowable Current*[A] (Ta = 30 °C )
0.9	18	(0.82)	17
1.25	16	(1.31)	19
2	14	(2.08)	27
3.5	12	(3.31)	37
5.5	10	(5.26)	49
8	8	(8.37)	61
14	6	(13.3)	88

\*1. Excerpts from Japanese laws related to electrical equipment.

The values vary depending on conditions such as the wire covering (insulator), the wire material (allowable temperature), and whether there are multiple cores in the cable. For cables other than those specified in this table, consult with a qualified engineer.

**⚠ WARNING**  
**Risk of electric shock.**

- Use load cables whose capacity is adequate for the PCR-M series' rated output current.
- Use load cables with a voltage rating that meets or exceeds the PCR-M series' isolation voltage (380 Vdc).
- Before you connect cables to the OUTPUT terminal block, be sure to turn the POWER switch off, and then remove the power plug from the outlet or turn off the switchboard.

- Note -  
 The L and N terminals of the OUTPUT terminal block are isolated from the input power supply. The polarity does not constitute a problem in terms of safety. You can use either L or N to ground the product.  
 In DC mode and AC+DC mode, N is the reference. When N has a positive polarity, L is positive electric potential. When N has a negative polarity, L is negative electric potential.  
 When the POWER switch is on, even if the output is off, a dangerous voltage exists between the output terminal (L or N) and the chassis (G-ground). To eliminate the voltage between the output terminal and the chassis, connect N and G of the OUTPUT terminal block.

#### Screw diameter of OUTPUT terminals

PCR500M/ PCR1000M/ PCR2000M : M4  
 PCR4000M : M6



■ Connecting the load cables (PCR500M - PCR4000M)

When shipped from the factory, the terminal cover is attached using the upper holes so that the OUTPUT terminals are not exposed.

**⚠ WARNING**  
**There is a danger of electric shock. Do not use the terminal block with the terminal cover removed.**

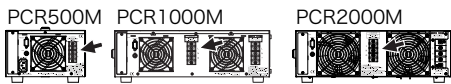

- 1 Check that the POWER switch is turned off.
- 2 Check that the power cord is disconnected from the outlet or the breaker of the switchboard is off.
- 3 Remove the terminal cover that is attached to the OUTPUT terminal block.

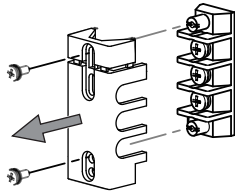

- 4 Securely connect the load wires to the OUTPUT terminal block.  
 If the load has a ground (GND) terminal, be sure to connect it to the G terminal of the PCR-M OUTPUT terminal block. Be sure to use a wire that is greater than or equal to the diameter of the wires used to connect the load.

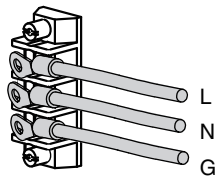

- 5 Attach the terminal cover that you removed in procedure 3 using the lower holes.

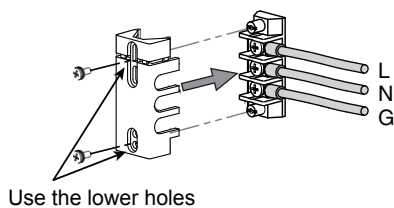

Twist the load wires (L and N), and connect between the output terminal and load with the shortest wires possible. If you cannot twist the wires, we recommend that you run the wires alongside each other and tie them together at several points with cable ties.  
 PCR-M

■ Connecting the load cables (PCR4000M)

When shipped from the factory, the terminal cover is attached so that the OUTPUT terminals are not exposed.

**⚠ WARNING**  
**There is a danger of electric shock. Do not use the terminal block with the terminal cover removed.**

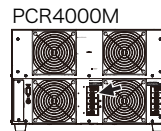

- 1 Check that the POWER switch is turned off.
- 2 Check that the breaker of the switchboard is off.
- 3 Remove the terminal cover that is attached to the OUTPUT terminal block.

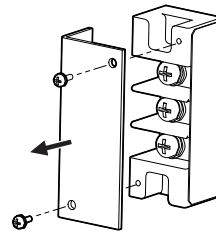

- 4 Securely connect the load wires to the OUTPUT terminal block.  
 If the load has a ground (GND) terminal, be sure to connect it to the G terminal of the PCR-M OUTPUT terminal block. Be sure to use a wire that is greater than or equal to the diameter of the wires used to connect the load.

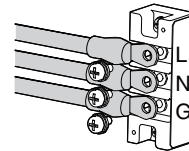

- 5 Attach the terminal cover that you removed in procedure 3.

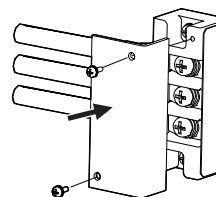

Twist the load wires (L and N), and connect between the output terminal and load with the shortest wires possible. If you cannot twist the wires, we recommend that you run the wires alongside each other and tie them together at several points with cable ties.

## Connecting the Load (Cont.)

### Connecting to the OUTPUT terminal block (Cont.)

#### ■ Attaching a ferrite core (PCR2000M only).

With the PCR2000M, attach a ferrite core to the wires.

##### 1 Unlock the ferrite core and open it.

Unlock the ferrite core and open it.

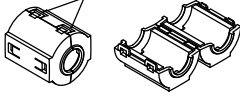

##### 2 Close the ferrite core. Avoid catching the wire on the ferrite core.

Attach the ferrite core within 10 cm from the OUTPUT terminal block. Lock it securely in place.

##### 3 To avoid moving the ferrite core, attach the cable tie to fix the position of the ferrite core.

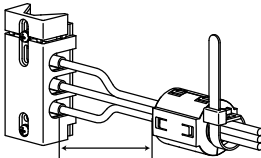

Within 10 cm

#### ■ When not using the OUTPUT terminal block

If you are not using the OUTPUT terminal block, attach the terminal cover.

PCR500M to PCR2000M

Use the upper holes to attach the terminal cover.

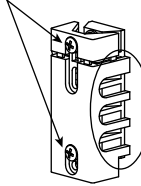

When the terminal cover is attached using the upper holes, the output terminals are not exposed.

PCR4000M

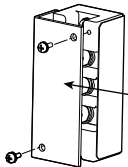

When the terminal cover is attached upside down, the output terminals are not exposed.

#### ■ When the load is located at a distance from the PCR-M

The remote control enables to turn the output off, but not for the POWER switch off. If the load is used connecting at a distance from the PCR-M, install the switch between the OUTPUT terminal block and the load to prevent electric shock, then turn the switch off.

##### ⚠ WARNING

##### Possible electric shock

- When installing the switch between the OUTPUT terminal block and the load, be sure to turn the POWER switch off and removing the power plug from an outlet or turn off the circuit breaker of switchboard.
- The current rating of the switch must be greater than or equal to the maximum current of the PCR-M.
- For the switch circuit, use a two-pole type switch that cuts off L and N wires simultaneously.
- Be sure to turn the switch off before connecting the load to the terminal at the load end of the switch.
- Do not touch the switch terminal when the output is on. Do not touch the switch terminals when the POWER switch is on. Before you connect cables to the OUTPUT terminal block, be sure to turn the POWER switch off, and then turn off the switchboard.

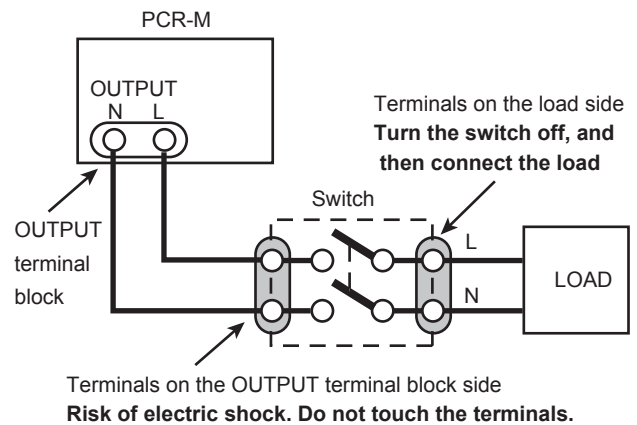

## Connecting to the outlet on the front panel

The PCR-M can output power from the OUTPUT terminal block on the rear panel and the OUTPUT outlet on the front panel. Specifications are not defined for the OUTPUT outlet. A portion of the performance may be degraded.

### CAUTION

The following table shows the maximum rated voltage and maximum rated current of the outlet on the front panel.

	PCR500M	PCR1000M	PCR2000M	PCR4000M
Maximum rated voltage	250 Vac(rms)			
Maximum rated current	5 Aac(rms)	10 Aac(rms)		

Do not connect the load when the maximum rated voltage of the OUTPUT outlet is exceeded or when in DC mode, as it can lead to malfunction.

The OUTPUT outlet is dedicated to a type of power plug shown in the figure.

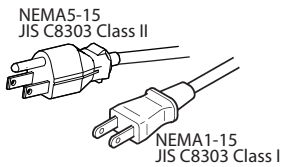

- 1** Turn the **POWER** switch off.
- 2** Connect the power cord of the load device to the **OUTPUT** outlet.

## Front panel

### Operation Panel

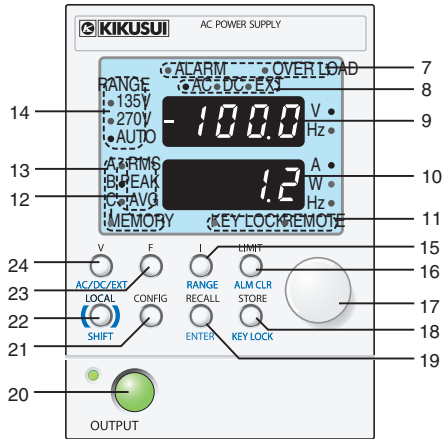

### PCR1000M/ PCR2000M

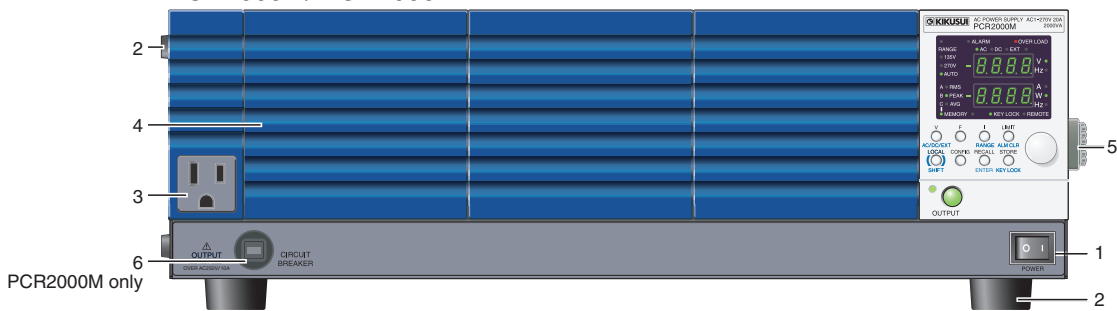

### PCR4000M

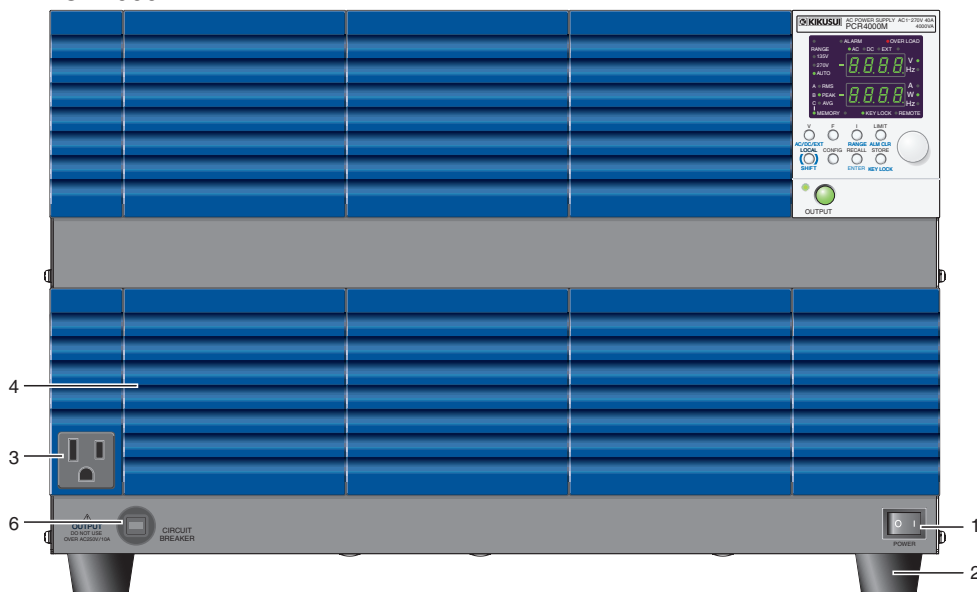

No.	Name	Description
1	POWER	POWER switch. Push (   ) to turn on; push (○) to turn off.
2	Feet	PCR500M/ PCR4000M: Four locations on the bottom PCR1000M/ PCR2000M: Four locations on the bottom, four locations on the side.
3	OUTLET	Front panel output
4	Air inlet	Air inlet for internal cooling. A dust filter is built in.
5	Handle	Handle for transporting
6	CIRCUIT BREAKER	Reset button of the circuit breaker.
7	ALARM/OVER LOAD	Illuminates when an alarm or overload occurs.
8	Output mode	The selected mode illuminates (AC, DC, or EXT).
9	Upper numeric display	Displays voltage or frequency.
10	Lower numeric display	Displays current or power. Displays the frequency when the memory is used.
11	Key lock/remote	Illuminates when the key is locked or when in remote mode.
12	Rms value, peak value, and average value	RMS, PEAK, or AVG illuminates according to the type of value shown on the numeric display.
13	Memories A, B, and C	The selected memory (A, B, or C) illuminates. MEMORY illuminates when saving settings and blinks when recalling settings.
14	Voltage range	The selected voltage range (135 V, 270 V, or AUTO) illuminates.
15	I	Selects the type of value shown on the lower numeric display (RMS, PEAK, AVG, or W).
	RANGE	Sets the voltage range.
16	LIMIT	Sets the limit value. The key illuminates when active.
	ALM CLR	Clears alarms.
17	Rotary knob	Changes the settings.
18	STORE	Saves to the memory (memories A, B, or C).
	KEY LOCK	Locks the keys
19	RECALL	Recalls from memory.
	ENTER	Confirms memory recall or storage.
20	OUTPUT	Turns the output on/off.
21	CONFIG	Sets the configuration.
22	LOCAL	Switches to local mode.
	SHIFT	SHIFT key
23	F	Sets the frequency. The key illuminates when active.
24	V	Sets the voltage. The key illuminates when active.
	AC/DC/EXT	Selects the output mode.



#### CAUTION

Pinch the rotary knob with your fingers to turn it. Turning it rapidly may cause it to malfunction.

# Rear panel

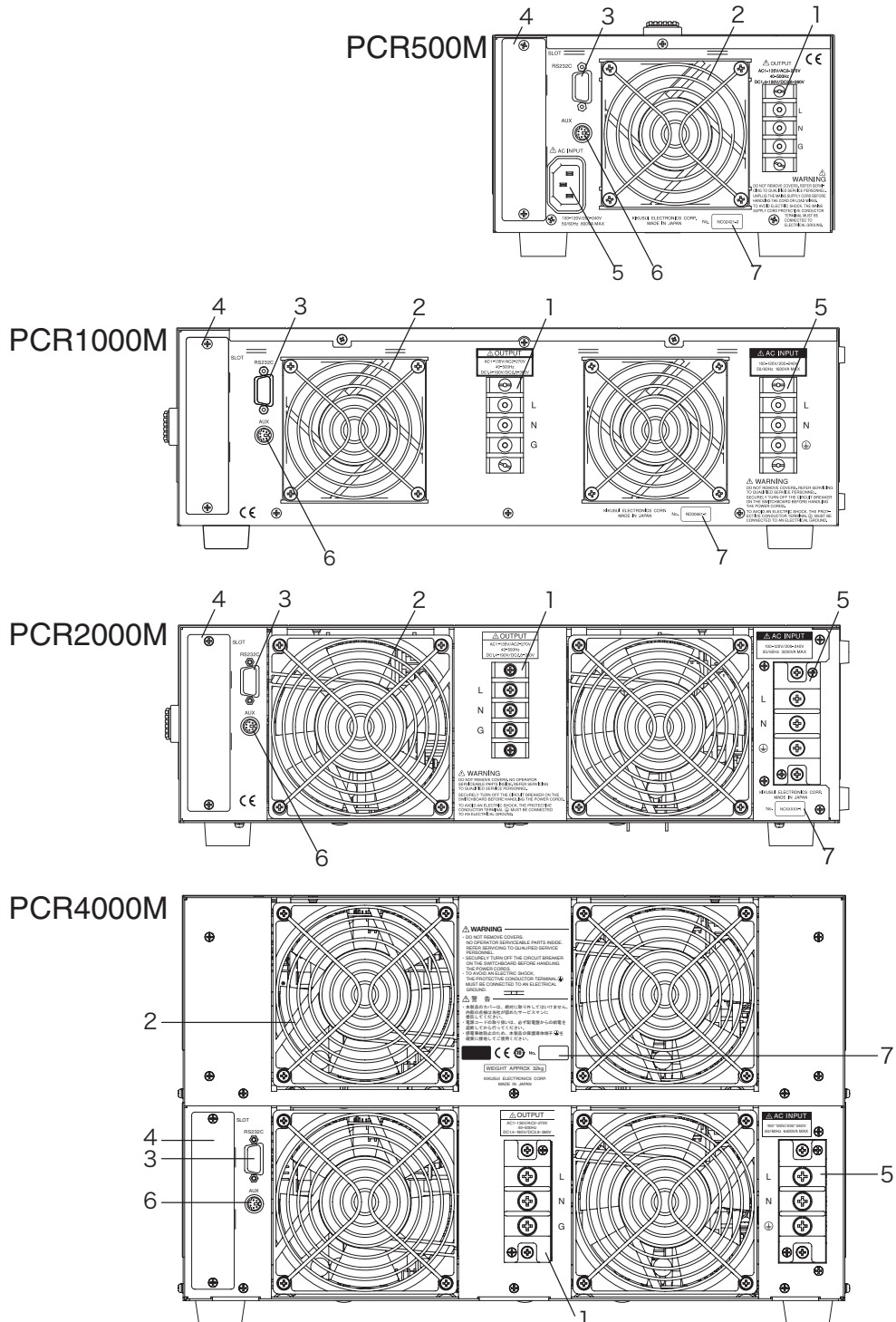

No.	Name	Description
1	OUTPUT terminal block	Output terminal block with a cover
2	Air outlet	Exhaust port for cooling
3	RS232C	A connector for RS232C remote control
4	Option slot	Installs an option board.
5	AC INPUT	PCR500M: AC inlet PCR1000M/ PCR2000M/ PCR4000M: AC input terminal block
6	AUX	A connector for functional expansion
7	Serial number	Serial number of PCR-M series

## Switching the Output Mode

The output mode can be switched between AC mode and DC mode when the OUTPUT is turned off. If an optional interface board is installed in the option slot on the PCR-M rear panel, EXT mode (analog interface board only) and AC+DC mode can also be selected.

The AC/DC/EXT key is disabled when the OUTPUT is turned on.

AC+DC mode can be selected only during remote control. For details, see the Communication Interface Manual.

Output Mode	LEDs That Illuminate	Description
AC mode	AC	AC output
DC mode	DC	DC output
EXT-AC mode	AC EXT	Output sine waves using external DC signals (only when the analog option board is installed)
EXT-DC mode	DC EXT	Simply amplify and output the waveform applied externally (only when the analog option board is installed)
AC+DC mode	AC DC	Superimpose DC voltage on the AC voltage and output. (only when the optional interface board is installed)

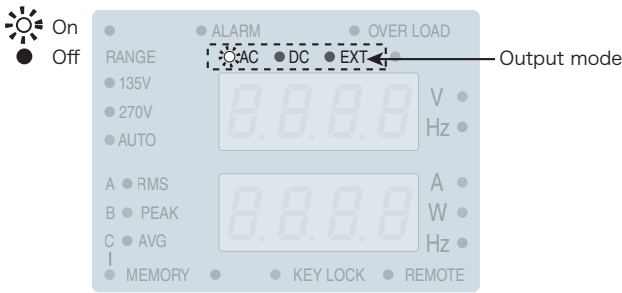

**1 Press the OUTPUT key to turn the OUTPUT off.**

The LED above on the left of the OUTPUT key turns off.

**2 Press the AC/DC/EXT key (SHIFT+V) to select the output mode.**

The mode switches between AC and DC each time the key is pressed.

The mode switches among AC, DC, EXT-AC, and EXT-DC when the analog interface board is installed.

The output mode LEDs illuminate according to the mode.

**- Note -**  
AC+DC mode is a function used to superimpose DC voltage on AC voltage or AC voltage on DC voltage. It can be used via the RS232C, GPIB, or USB interface. For details on the commands, see the Communication Interface Manual.

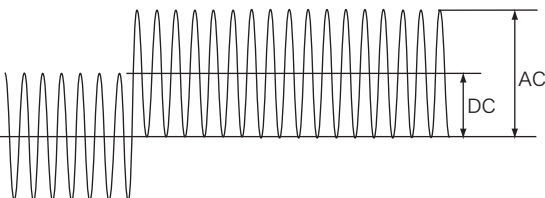

## Setting the Voltage Range

The voltage range is switched with the OUTPUT turned off. The selectable voltage ranges are 135 V, 270 V, and AUTO..

The RANGE key is disabled when the OUTPUT is turned on.

The AUTO setting automatically switches between 135 V range and 270 V range.

AUTO cannot be selected in AC+DC mode, EXT-AC mode, or EXT-DC mode.

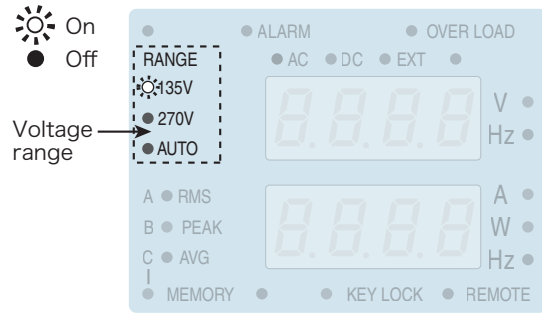

Voltage range and output voltage setting

Voltage Range	Output Voltage Setting		
	AC mode	DC mode	AC+DC mode
135 V range	0.0 V to 137.5 V	-194.0 V to +194.0 V	
270 V range	0.0 V to 275.0 V	-388.0 V to +388.0 V	

Voltage range and maximum output current

	Voltage Range	Maximum Output Current		
		AC mode	DC mode	AC+DC mode
PCR500M	135 V range	5 A	4 A	
	270 V range	2.5 A	2 A	
PCR1000M	135 V range	10 A	8 A	
	270 V range	5 A	4 A	
PCR2000M	135 V range	20 A	16 A	
	270 V range	10 A	8 A	
PCR4000M	135 V range	40 A	32 A	
	270 V range	20 A	16 A	

**1 Press the OUTPUT key to turn the OUTPUT off.**

The LED above on the left of the OUTPUT key turns off.

**2 Press the RANGE key (SHIFT+I) to select the voltage range.**

The range switches among 135 V, 270 V, and AUTO each time the key is pressed. The LED corresponding to the range illuminates.

If the voltage is set above 137.5 V in the 270 V range or AUTO setting and the range is switched to 135 V, the output voltage is set to 0.0 V.

## Setting the Voltage

You can set the voltage regardless of whether the OUTPUT is on or off.

If the voltage range is set to AUTO, the range automatically switches to 135 V or 270 V range according to the specified voltage. When the voltage range switches, the OUTPUT is turned off for approximately 0.5 seconds. After the voltage range switches, the OUTPUT is turned on again.

The factory default voltage lower limit of DC mode is 0.0 V. You must change the limit to set a negative electric potential.

In AC+DC mode, the voltage can be specified only when the AC and DC voltage settings are within the voltage limit range and the peak value of the AC+DC waveform is within the range of -388 V to 388 V.

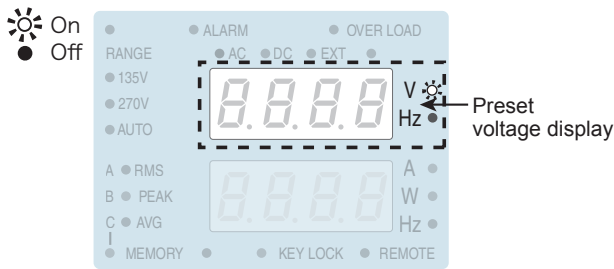

### 1 Press the V key.

The V key illuminates, and the voltage setting display appears.

### 2 Turn the rotary knob to set the voltage.

The specified voltage is shown on the upper numeric display.

If the OUTPUT is on, you can change the set voltage (output voltage) by turning the rotary knob.

If the OUTPUT is off, you can change the preset voltage by turning the rotary knob.

The specified voltage is delivered when the OUTPUT is turned on.

To display the measured value, press the V key again. The V key turns off and measured value display appears.

You can also change the output voltage by turning the rotary knob on the measured value display immediately after changing from the voltage setting display if the OUTPUT is on.

If you show the measured value display after displaying another setting display, you cannot change the output voltage. In this case, press the V key again.

Switching of the range when the voltage range is set to AUTO

AC mode: Output Voltage Setting		
	0 V to 135 V	135.1 V to 275 V
Range	135V	270V

DC mode: Output Voltage Setting		
	-388 V to -190.1 V	-190 V to 190 V
		190.1 V to 388 V
Range	270V	135V
		270V

## Setting the Frequency

Frequency setting is a function for AC mode and AC+DC mode. You can set the frequency regardless of whether the OUTPUT is on or off.

The F key is disabled in DC mode.

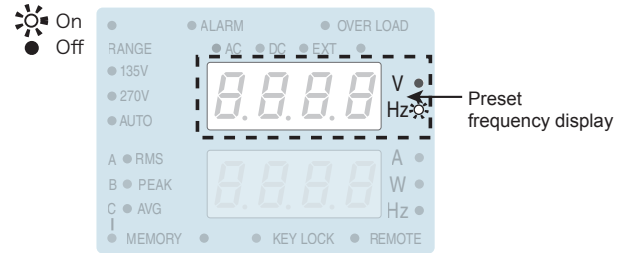

### 1 Press the F key.

The F key illuminates, and the frequency setting display appears.

### 2 Turn the rotary knob to set the frequency (40.0 Hz to 500.0 Hz).

The specified frequency is shown on the upper numeric display.

Press the F key again, then F key light off and the measured value display appears to show the value of measured voltage in the upper numeric display.



## Turning the OUTPUT On/Off

The OUTPUT turns on/off each time the OUTPUT key is pressed.

- **OUTPUT on**

The LED above on the left of the OUTPUT key illuminates.

The voltage and frequency according to the specified output mode and voltage range are output.

- **OUTPUT off**

The LED above on the left of the OUTPUT key turns off.

The OUTPUT is always off when the POWER switch is turned on.

If a protection function trips, the OUTPUT is turned off. However, if the current limit operation is set to LIMIT CONTROL and the overload protection function (current limit) trips, the OUTPUT is not turned off.

### **WARNING**

#### **Possible electric shock**

- **Do not touch the OUTPUT terminal block and OUTPUT outlet.**
- **If a capacitor, battery, or a similar device is connected as a load in DC mode, voltage remains at the section connected to the OUTPUT terminal block or OUTPUT outlet even when the OUTPUT is off until the load energy is discharged. The discharge time of the internal capacitor when no load is connected is approximately 0.1 seconds. To prevent the possibility of electric shock, do not touch the OUTPUT terminal block and OUTPUT outlet.**

### **CAUTION**

When the OUTPUT is turned on, several volts of undershoot or overshoot may appear on the order of ten microseconds.

### ■ Principle of OUTPUT on/off

The PCR-M does not cut off output from the internal circuits mechanically using switches and relays, but rather increases output impedance electrically to turn the output off. Therefore, the output can be turned on/off without chattering. When the OUTPUT is off, the output is in high-impedance condition.

	PCR500M	PCR1000M	PCR2000M	PCR4000M
135 V range	approx. 40 k $\Omega$	approx. 20 k $\Omega$	approx. 10 k $\Omega$	approx. 5 k $\Omega$
270 V range	approx. 80 k $\Omega$	approx. 40 k $\Omega$	approx. 20 k $\Omega$	approx. 10 k $\Omega$

### ■ OUTPUT on phase angle

The OUTPUT on phase can be set in AC mode.

The control of the OUTPUT on phase angle is specified in the configuration. Because the output capacitor inside the PCR-M is discharged when there is no load, OUTPUT turns off at the zero-crossing phase.

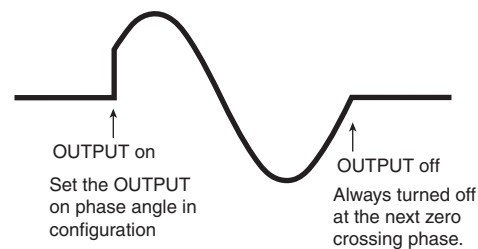

## Measured value display

The current output value is monitored. Upper numeric display and lower numeric display indicate approximately 0 when the OUTPUT is off.

### ■ Display on the upper numeric display

The upper numeric display indicates the measured values below.

- AC mode  
Measured voltage (RMS)
- DC mode  
Measured voltage (AVG)

### ■ Display on the lower numeric display

The lower numeric display indicates the measured values below.

You can change the type of displayed value by pressing the I key.

- AC mode  
Measured rms current (RMS)  
Measured peak current (PEAK)  
Measured power (W)
- DC mode  
Measured peak current (PEAK)  
Measured average current (AVG)  
Measured power (W)

The measured peak current indicates the absolute value by measuring the maximum instantaneous value of current. The measured peak current is displayed using a positive value even when negative voltage is being output in DC mode. The hold time of peak current is set in the configuration.

The measured current or power is displayed in the lower numeric display even when the voltage setting display or frequency setting display is shown.

### ■ Switching the display

Table below shows how to switch to the measured value display from other setting displays.

Other Setting Display	Switching Procedure
Voltage setting display (V key illuminated)	Press the V key.
Frequency setting display (F key illuminated)	Press the F key.
Limit setting display (LIMIT key illuminated)	Press the I key.
Configuration setting display	
Memory storage display (MEMORY LED illuminated)	
Memory recall display (MEMORY LED blinked)	

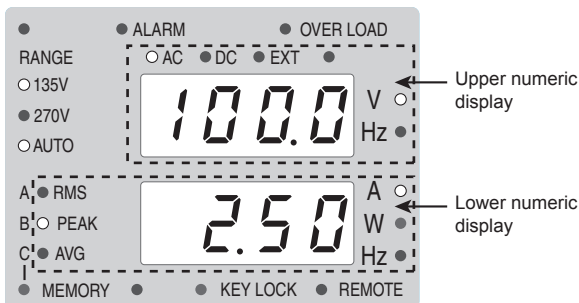

## Setting the limit value

The limit function prevents damaging the load caused by operation errors by setting a limit on the output setting of the PCR-M. The limit value can be specified to match the load conditions in advance.

The limit can be set regardless of whether the OUTPUT is on or off.

### 1 Press the LIMIT key.

The LIMIT key illuminates, and the limit setting display appears.

The limit settings switch in order each time the LIMIT key is pressed. Press the LIMIT key repeatedly until the desired limit setting is displayed. The measured value display is shown after all limit settings are shown.

### 2 Turn the rotary knob to set the condition.

### 3 To set other limit values, press the LIMIT key. To show another setting display or the measured value display, press the V, F, or I key.

The voltage setting display, frequency setting display, or measured value display is shown, respectively.

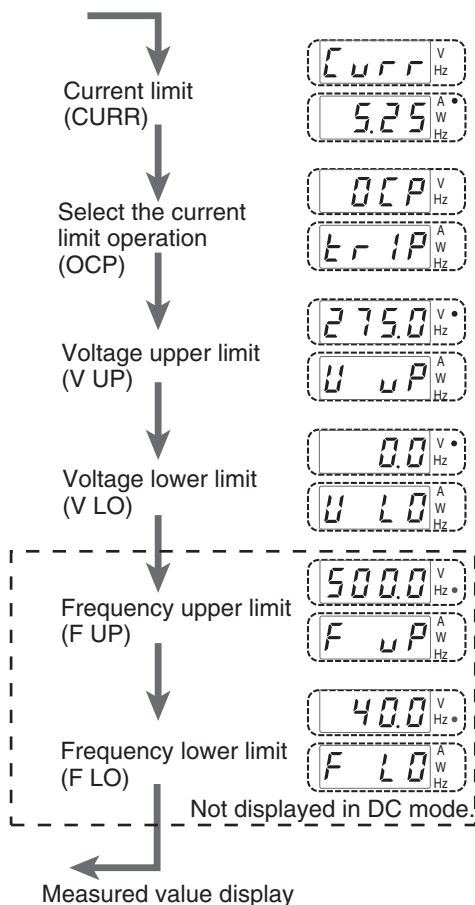

**- Note -**

The limit value takes precedence over the setting value for voltage and frequency. If the current setting value exceeds the limit range when the voltage or frequency limit value is changed, the setting value (voltage or frequency) is set to a limit value that is closest to the current setting value.

## Current limit value and current limit operation

The current limit value of the output current can be specified.

Output Mode	Limit			
	PCR500M	PCR1000M	PCR2000M	PCR4000M
AC mode	0.10 A to 5.25 A	0.20 A to 10.50 A	0.40 A to 21.00 A	0.80 A to 42.00 A
DC mode	0.10 A to 4.20 A	0.20 A to 8.40 A	0.40 A to 16.80 A	0.80 A to 33.60 A

The operation to be carried out when the current limit is exceeded can be selected.

Current Limit Operation	Display	Function
TRIP	TRIP	Turns the OUTPUT off and activates the alarm when an overload condition lasts more than 3 seconds.
LIMIT CONTROL	L.L.L.	Decreases the output voltage so that the current does not exceed the limit when an overload occurs (software CC operation <sup>*1</sup> ).

\*1. It is calculated for the RMS value. Due to the relation between the processing time of measurement and the voltage resolution, it may take a few seconds to exceed the value of current limit.

## Setting the voltage upper and lower limits

You cannot set the voltage outside the limit range. Set the limit so that the upper limit is greater than or equal to the lower limit.

Output Mode	Voltage Range	Lower Limit	Upper Limit
AC mode	135 V	0.0 V to 137.5 V	0.0 V to 275.0 V
	270 V	0.0 V to 275.0 V	0.0 V to 275.0 V
DC mode	135 V	-388.0 V to 194.0 V	-194.0 V to 388.0 V
	270 V	-388.0 V to 388.0 V	-388.0 V to 388.0 V

## Frequency upper and lower limits

Cannot be set in DC mode. You cannot set the frequency outside the limit range. Set the limit so that the upper limit is greater than or equal to the lower limit.

Output Mode	Lower Limit	Upper Limit
AC mode	40.0 Hz to 500.0 Hz	40.0 Hz to 500.0 Hz

## Using Memories

The settings can be stored to memory. There are three memories, A, B, and C.

Memories are effective when testing drastic changes in voltage or frequency.

In case the optional interface board is installed in the optional slot on the rear panel, the setting condition can be stored up to 10 memories. The memory 4 through 10 can be used only under the remote control operation. For details, see the Communication Interface Manual.

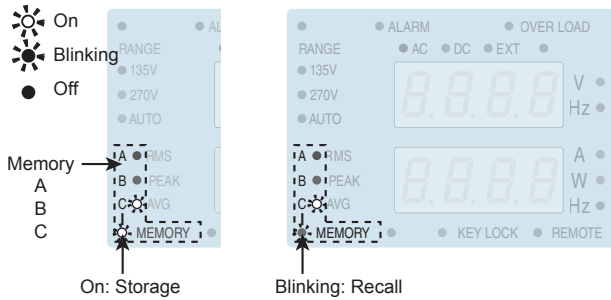

### Saving to the memory

- 1 Configure the PCR-M to the settings you wish to store.**
- 2 Press the STORE key to select the destination memory (A, B, or C).**  
The MEMORY LED on the display illuminates. Memories A, B, and C are selected in order each time the STORE key is pressed, and the corresponding LED illuminates. The upper numeric display indicates the preset voltage. In AC mode, the lower numeric display indicates the preset frequency.
- 3 Press the ENTER (SHIFT+RECALL) key to store the settings to the memory.**  
The settings are stored to the selected memory. The MEMORY LED on the display turns off. To cancel the storage operation, press a key other than the STORE key or ENTER (SHIFT+RECALL) key.

Stored Settings		
Output mode (AC, DC, or EXT)		
Voltage range (135 V, 270 V, or AUTO)		
Voltage	AC	
	DC	
Frequency		
Measured value display (RMS, PEAK, AVG, or W)		
Limit values	AC	Voltage upper limit
		Voltage lower limit
		Current limit
	DC	Frequency upper limit
		Frequency lower limit
		Current limit
Current limit operation		

### Recalling the memory

If a memory is recalled with the OUTPUT turned on, a short alarm sounds and the recalling is disabled when the output mode or voltage range switches. If this happens, turn the OUTPUT off, recall the memory, and then turn the OUTPUT back on.

- 1 Press the RECALL key to select the memory you wish to recall.**  
The MEMORY LED on the display blinks. Memories A, B, and C are selected in order each time the RECALL key is pressed, and the corresponding LED illuminates. The settings stored to memory (preset voltage on the upper numeric display and preset frequency on the lower numeric display) are displayed.
- 2 Press the ENTER (SHIFT+RECALL) key to recall the settings from the memory.**  
The settings of the selected memory are recalled, and new settings are activated. The MEMORY LED on the display turns off. To cancel the recall operation, press a key other than the RECALL key or ENTER (SHIFT+RECALL) key.

## Switching from remote control to local control

The RMT LED illuminates when the remote control is activated. Press the LOCAL key to switch from remote control to local control (Front panel operation).

## Locking (Prohibiting) the Panel Operation

The operation from the panel can be locked to prevent the settings from being changed inadvertently when using the PCR-M with fixed voltage or frequency. When the panel is locked, all keys other than the OUTPUT and KEY LOCK (SHIFT+STORE) keys are disabled.

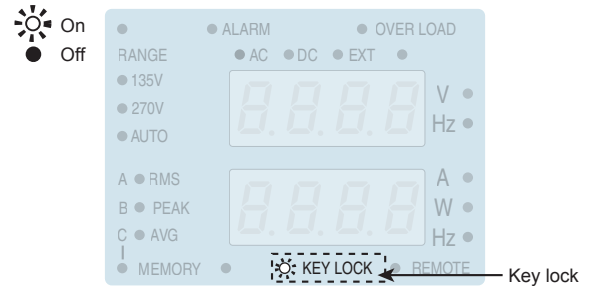

### ■ Setting and releasing the lock

The panel lock can be set or released each time the KEY-LOCK (SHIFT+STORE) key is pressed.

If the lock is set, the KEY LOCK LED on the display illuminates; if the lock is released, the LED turns off.

## Protection Functions and Alarm Errors

The PCR-M is equipped with the protection functions below. When a protection function is activated, an alarm (A-xx) or an error (E-xx) occurs as shown Table below in and the OUTPUT is turned off.

- Alarm  
Occurs to notify the user that a protection function has been activated.
- Error  
Occurs on a major operation error or when there is a possibility of malfunction or damage.

Protection Function		Alarm or Error Type
Protection against exceeding the input voltage rating range		Error E-10 or E-12
Overheat protection (OHP)		Alarm A-04
Overload protection	Overcurrent (RMS or AVE) protection (OCP)	OVERLOAD illuminates. Alarm A-01.
	Overpower protection (OPP)	OVERLOAD illuminates. Alarm A-03.
	Overcurrent (PEAK) protection (OCP)	OVERLOAD illuminates. Alarm A-02.
Voltage error detection	Overvoltage (OVP)	Alarm A-00
	Low voltage (LVP)	Alarm A-06

### Alarm Occurrence

When an alarm or error occurs, an alarm sounds and the ALARM LED on the display illuminates. The upper numeric display shows the output voltage, and the lower numeric display shows the alarm or error number.

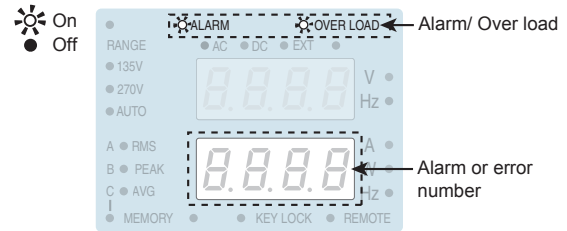

#### ■ Clearing Alarms

- 1 Check the alarm number.**
- 2 Press the ALM CLR (SHIFT+LIMIT) key.**  
The alarm sound stops, and the alarm indication also clears.  
If you press the ALM CLR (SHIFT+LIMIT) key again, the last alarm number is displayed.
- 3 Eliminate the cause of the alarm.**  
Eliminate the cause of the alarm that occurred according to the description of the displayed alarm number.

#### ■ Clearing Errors

- 1 Check the error number.**
- 2 Turn the POWER switch off.**
- 3 Eliminate the cause of the error.**  
Eliminate the cause of the error that occurred according to the description of the displayed error number.  
Turn the POWER switch on again to restore.

■ Alarm or error number, description, and remedy

Alarm Number or Error Number	Description and Remedy	
nOEr	No alarm or error	
Alarm	A-00	Detected more than 8 V of measured voltage against the setting voltage (OVP, Current limit function: TRIP) or the external signal which exceeds maximum value of the range is applied.
	A-01	The overload protection function (overcurrent (RMS or AVE) protection) tripped (OCP).
	A-02	The overload protection function (overcurrent (PEAK) protection) tripped (OCP).
	A-03	Power protection function tripped (OPP).
	A-04	The overheat protection function tripped (OHP). The internal temperature may be abnormally high. If the alarm continues to occur after 10 minutes with the POWER switch turned on, it may be caused by an inappropriate installation of the PCR-M or the ambient temperature being outside the operating temperature specifications.
	A-06	Detected less than 8 V of measured voltage against the setting voltage (LVP, Current limit function: TRIP).
Error	E-09	An error is occurring in the internal communication. Turn the POWER switch off, wait at least 5 seconds, and then turn the POWER switch back on.
	E-10	The input voltage is outside the rated range when the power is turned on. Check the input voltage.
	E-11	A voltage error occurred in the internal power unit. Turn the POWER switch off, wait at least 5 seconds, and then turn the POWER switch back on.
	E-12	While the operation, the error has been occurred either the input voltage becomes out of the rated range or the abnormal state is detected in the input circuit. Check the input voltage. Turn off the POWER switch and wait for more than 5 seconds, then turn on the POWER switch again.
	E-13	An error occurred inside the PCR-M. Turn the POWER switch off. Wait at least 5 seconds, and then turn the POWER switch on while holding down the RECALL key. The PCR-M is reset to factory default settings.
	E-15	An error occurred in the calibration data. The error cannot be cleared. Contact your Kikusui agent or distributor for repairs.

- Note -

If you cannot clear the alarm even when all of the causes of the alarm are eliminated, the PCR-M may have malfunctioned. Stop using the PCR-M and contact your Kikusui agent or distributor. When making an inquiry, please provide us with the displayed alarm or error number.

Operation when the protection function is activated

The OVER LOAD LED on the display illuminates for conditions listed in Table below.

The output voltage may vary while the OVER LOAD LED is illuminated.

OVER LOAD LED is illuminated	Operation after an alarm occurred
The measured current (RMS) is greater than or equal to the current limit value or rated current.	Current limit operation : TRIP If this condition lasts for 3 seconds or longer, an alarm (A-01) occurs and the output is shut down. Current limit operation : LIMIT CONTROL (software CC operation) The preset voltage is controlled internally by the PCR-M when an overcurrent condition occurs. An alarm does not occur.
The measured current (PEAK) is greater than or equal to the maximum peak current	If the condition "100 % of the maximum peak current < measured current ÷ 115 % of the maximum peak current" lasts for 10 seconds or longer or the condition "115 % of the maximum peak current < measured current" lasts for 1 second or longer, an alarm (A-03) occurs and the output is shut down.
The measured apparent power (VA) is greater than or equal to the rated apparent power.	If this condition lasts for 10 seconds, an alarm (A-03) occurs and the output is shut down.
The measured voltage (RMS) is not within ±8 V of the preset voltage.	Current limit operation : TRIP If this condition lasts for 3 seconds, an alarm (A-00 or A-06) occurs and the output is shut down.
The external input signal exceeds the maximum of the range.	Current limit operation : LIMIT CONTROL (software CC operation) An alarm does not occur.

Steps to be taken if the circuit breaker trips (PCR2000M/ PCR4000M only)

For the PCR2000M/ PCR4000M, if more than 10 A of output current flows from the OUTPUT outlet, the circuit breaker may trip to shut down the output from the OUTPUT outlet. Once the breaker is tripped, the red button (Breaker button) on the front panel will be come out.

- 1 Turn the POWER switch off.
- 2 Push the breaker button.
- 3 Adjust the load so that the output current is 10 A or less.
- 4 Turn the POWER switch on.

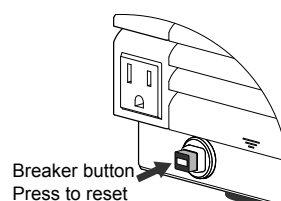

# Setting the Configuration

The operating conditions are specified.

**1 Press the CONFIG key.**  
 The configuration setting display appears.  
 The configuration setting switches in order each time the CONFIG key is pressed. Press the CONFIG key repeatedly until the operating condition you wish to set is displayed. The measured value display is shown after all configuration settings are shown.

**2 Turn the rotary knob to set the condition.**

**3 To set other operating conditions, press the CONFIG key. To show another setting display or the measured value display, press the V, F, or I key.**

The voltage setting display, frequency setting display, or measured value display is shown, respectively.

If you change the communication interface type or change the RS232C settings, you must wait at least 5 seconds, turn the POWER switch off, and then turn it back on.

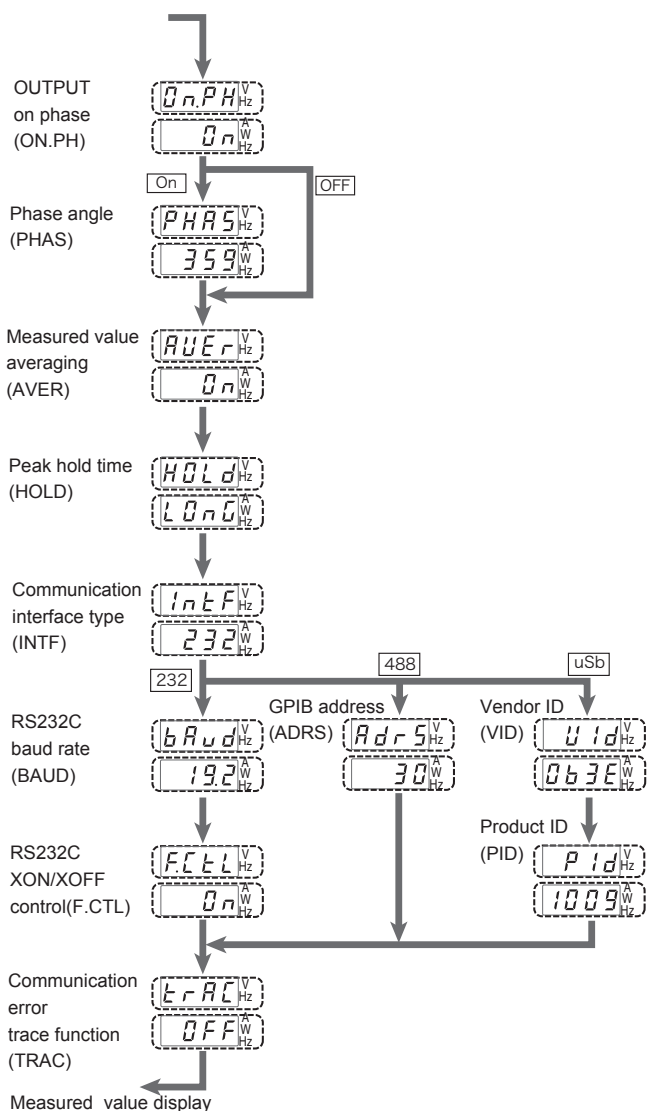

## ■ OUTPUT on phase

Set the OUTPUT on phase for AC mode.  
 When using the OUTPUT on phase control, also set the phase angle.

- OUTPUT on phase  
 ON (  ): OUTPUT on phase control enabled  
 OFF (  ): FREE operation (no phase control)
- Phase angle  
 0 deg to 359 deg : Range for phase angle setting

## ■ Averaging period

You can select the averaging period of the measured values (excluding the peak current).

- Measured value averaging  
 ON (  ): Displays the moving average over approximately 3 seconds  
 OFF (  ): Updates and displays approximately every 0.3 s

## ■ Hold time of peak current

You can change the hold time of the peak current.

- Peak hold time  
 SHORT (  ): Updates approximately every 0.3 s  
 LONG (  ): Holds the peak value for approximately 5 seconds. If a greater peak value is measured while holding, the new peak value is held for approximately 5 seconds from that point.



## ■ Communication interface

The functions of the PCR-M can be expanded by installing an interface board to the option slot. However, the GPIB, RS232C, and USB interfaces cannot be used simultaneously.

- Communication interface type

To activate the settings, the POWER switch must be turned off when at least 5 seconds elapses after changing the settings and then turned back on.

232 (  232 ): RS232C (standard equipped)

488 (  488 ): GPIB (selectable only when the optional interface board is installed)

USB (  55b ): USB (selectable only when the optional interface board is installed)

## RS232C

If you select RS232C, set the baud rate and the XON/XOFF flow control.

To activate the settings, the POWER switch must be turned off when at least 5 seconds elapses after changing the settings and then turned back on.

- RS232C baud rate

1.2/2.4 ... 19.2 : 1 200 bps, 2 400 bps, 4 800 bps,  
9 600 bps, 19 200 bps

- RS232C XON/XOFF control

ON (  0n ): XON/XOFF control

OFF (  0FF ): XON/XOFF control

## GPIB

If you select GPIB, select the GPIB address. The dipswitches mounted on the IB21 are not used.

- GPIB address

1 to 30 : Address

## USB

If you select USB, an ID that is required is displayed. You cannot change the settings.

- Vendor ID (  1b3E ): display

- Product ID display

0x1009 (  1009 ): PCR500M

0x100A (  100A ): PCR1000M

0x100B (  100b ): PCR2000M

0x1043 (  1043 ): PCR4000M

## ■ Error display during remote control

Select whether to show or hide the error number on the lower numeric display when there is an error log in the SCPI error queue during remote control.

- Communication error trace function

ON (  0n ): Show the error number

OFF (  0FF ): Hide the error number

## Controlling the Output Using External Analog Signals (Option)

The output can be controlled using external analog signals by installing the analog interface board to the option slot. The analog interface board cannot be used together with the GPIB interface or USB interface.

There are two available modes: EXT-AC mode in which the voltage of the output AC waveform (sine wave) is varied according to the input DC signal and EXT-DC mode in which the input waveform is simply amplified and output.

### EXT-AC mode

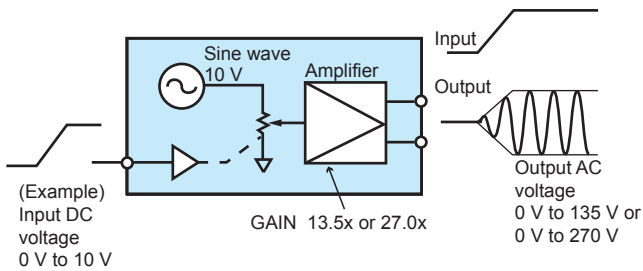

### EXT-DC mode

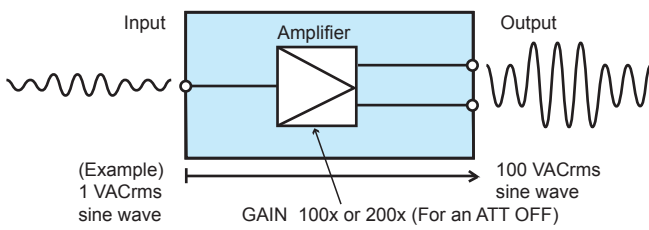

### Names and functions of the parts of the analog interface board

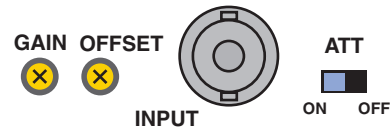

Name	Description
INPUT	BNC terminal for applying the external signal Input terminals is electrically isolated from the output terminals of the PCR-M.
ATT	Input attenuator switch
GAIN	Variable resistor for fine adjusting the gain (voltage amplification ratio)
OFFSET	Variable resistor for fine adjusting the offset

### CAUTION

You cannot set the voltage limit when the PCR-M is being controlled using external analog signals. Accidentally applying an excessive external voltage may damage the load.

## Varying the voltage of the output AC waveform using DC signals (EXT-AC mode)

The PCR-M outputs AC voltage ranging from 0 V to 135 V (when 135 V range is selected) or 0 V to 270 V (when 270 V range is selected) with respect to a DC signal input ranging from 0 V to  $\pm 10$  V.

### CAUTION

You have to set the ATT switch to ON. Otherwise the load can be damaged because of PCR500M output an excessive voltage to it.

- 1 Check that the POWER switch is turned off.**
- 2 Turn the ATT switch on.**  
The allowable input DC voltage range is -10 V to +10 V.
- 3 Connect an external signal (generator) to the INPUT terminal.**
- 4 Turn the POWER switch on.**
- 5 Press the AC/DC/EXT key (SHIFT+V) to set the OUTPUT mode to EXT-AC.**  
The EXT and AC LEDs illuminate.
- 6 Press the RANGE key (SHIFT+I) to set the voltage range (135 V or 270 V).**  
The LED corresponding to the voltage range illuminates. AUTO cannot be selected.
- 7 Press the F key to set the frequency (40 Hz to 500 Hz).**
- 8 Apply an external signal to the INPUT terminal.**
- 9 Turn the OUTPUT on.**

### ■ Setting the limit value

You can set the frequency limit (40 Hz to 500 Hz), the current limit, and the current limit operation (TRIP or LIMIT CONTROL).

	PCR500M	PCR1000M	PCR2000M	PCR4000M
Limit value	0.1 A to 5.25 A	0.2 A to 10.5 A	0.4 A to 21.0 A	0.8 A to 42.0 A

### ■ Fine adjusting the offset

You can fine adjust the offset by turning the OFFSET variable resistor using the adjustment screwdriver. Adjust the offset so that the output voltage is minimum with the input terminal shorted.

### ■ Fine adjusting the gain

You can fine adjust the gain by turning the GAIN variable resistor using the adjustment screwdriver. Adjust the gain so that the output voltage is 135 Vac (135 V range) when 10 Vdc is applied to the input terminal.

### ■ Measured value display

The lower numeric display shows RMS, PEAK, and W in order each time the I key is pressed.

The upper numeric display shows the measured RMS voltage.

# Controlling the Output Using External Analog Signals (Option, Cont.)

## Amplifying the input waveform (EXT-DC mode)

The input waveform is simply amplified and output in this mode.

- Turn ATT off  
Peak value: The PCR-M outputs a voltage 100 or 200 times the voltage ranging from -1.90 V to +1.90 V.
- Turn ATT on  
The PCR-M outputs voltage ranging from -190 V to +190 V (when 135 V range is selected) or -380 V to +380 V (when 270 V range is selected) with respect to a signal input ranging from -10 V to +10 V.

- 1 Check that the POWER switch is turned off.**
- 2 Set the ATT switch.**  
Off: The input voltage range is -1.90 V to +1.90 V (peak value)  
On: The input voltage range is -10 V to +10 V.
- 3 Connect an external signal (generator) to the INPUT terminal.**
- 4 Turn the POWER switch on.**
- 5 Press the AC/DC/EXT key (SHIFT+V) to set the OUTPUT mode to EXT-DC.**  
The EXT and DC LEDs illuminate.
- 6 Press the RANGE key (SHIFT+I) to set the voltage range (135 V or 270 V).**  
The LED corresponding to the voltage range illuminates. AUTO cannot be selected.
- 7 If an AC voltage is being applied, press the F key to set the frequency (40 Hz to 500 Hz).**  
To display the measured value accurately, set the frequency so that it matches the frequency of the external input signal. If the set frequency is out of synchronization, the measured value will be unstable.
- 8 Apply an external signal to the INPUT terminal.**
- 9 Turn the OUTPUT on.**

### ■ Setting limit values

You can set the frequency limit (40 Hz to 500 Hz), the current limit (0.1 A to 4.2 A), and the current limit operation (TRIP or LIMIT CONTROL).

	PCR500M	PCR1000M	PCR2000M	PCR4000M
Limit value	0.1 A to 4.2 A	0.2 A to 8.4 A	0.4 A to 16.8 A	0.8 A to 33.6 A

### ■ Fine adjusting the offset

You can fine adjust the offset by turning the OFFSET variable resistor using the adjustment screwdriver. Adjust the offset so that the output voltage is as close to 0 V (DC) as possible with the ATT switch turned off and the input terminal shorted.

### ■ Fine adjusting the gain

You can fine adjust the gain by turning the GAIN variable resistor using the adjustment screwdriver. Adjust the gain so that the output voltage is 135 Vac (135 V range) when 1.35 Vac is applied to the input terminal with the ATT switch turned off.

### ■ Measured value display

The lower numeric display shows RMS, PEAK, AVG, and W in order each time the I key is pressed.

The upper numeric display shows the average measured voltage if AVG is selected on the lower numeric display. Otherwise, the upper numeric display shows the measured RMS voltage.

## Electrical specifications

Unless specified otherwise, the specifications are for the following settings and conditions.

The warm-up time is 30 minutes (with current flowing).

TYP: Typical values do not guarantee the performance.

set: Indicates the setting.

reading: Indicates the reading.

### Input ratings (AC rms)

	PCR500M	PCR1000M	PCR2000M	PCR4000M
Nominal input voltage	100 Vac to 120 Vac/ 200 Vac to 240 Vac			
Input voltage range	90 Vac to 132 Vac/180 Vac to 250 Vac (auto detected when the power is turned on)			
Phase	Single phase , Two-wire			
Nominal input Frequency	50 Hz to 60 Hz			
Input frequency range	47 Hz to 63 Hz			
Apparent power	800 VA or less	1600 VA or less	3200 VA or less	6400 VA or less
Power factor <sup>*1</sup>	0.9 (TYP)			
Current (Input voltage 90 Vac to 132 Vac/180 Vac to 250 Vac)	9 A/ 4.5 A or less	18 A/ 9A or less	36 A/ 18 A or less	72 A/ 36 A or less

\*1. For an output voltage of 100 V/200 V (135 V/270 V range), maximum current, and a load power factor of 1.

### AC mode output ratings (AC rms)

	PCR500M	PCR1000M	PCR2000M	PCR4000M
Voltage (Rated voltage range) <sup>*1</sup>	1 V to 135 V / 2 V to 270 V			
Voltage (Preset voltage range) <sup>*1</sup>	0 V to 137.5 V / 0 V to 275.0 V			
Voltage setting resolution	0.1 V			
Voltage setting accuracy <sup>*2</sup>	$\pm(1\% \text{ of set} + 0.6 \text{ V}/1.2 \text{ V})$			
Output phase	Single phase , Two-wire			
Maximum current <sup>*3</sup>	5 A / 2.5 A	10 A / 5 A	20 A / 10 A	40 A / 20 A
Maximum peak current <sup>*4</sup>	15 A / 7.5 A	30 A / 15 A	60 A / 30 A	120 A / 60 A
Load power factor	0 to 1 (leading phase or lagging phase)			
Power capacity	500 VA	1 000 VA	2000 VA	4000 VA
Frequency setting range	40.0 Hz to 500.0 Hz			
Frequency setting resolution	0.1 Hz			
Frequency accuracy	Within $\pm 2 \times 10^{-4}$			

\*1. 135V/ 270V range

\*2. For an output voltage of 13.5 V to 135 V/27 V to 270 V, an output frequency of 45 Hz to 65 Hz, no load, and 23 °C  $\pm$  5 °C.

\*3. For an output voltage of 1 V to 100 V/2 V to 200 V.

Limited by the power capacity when the output voltage is 100 V to 135 V /200 V to 270 V.

\*4. With respect to the capacitor-input rectifying load. Limited by the maximum current.

## Electrical specifications (Cont.)

### Output rating for DC mode

	PCR500M	PCR1000M	PCR2000M	PCR4000M
Voltage (Rated voltage range) <sup>*1</sup>	1.4 V to 190 V / 2.8 V to 380 V			
Voltage (Preset voltage range) <sup>*1</sup>	-194.0 V to 194.0 V / -388.0 V to 388.0 V			
Voltage setting resolution	0.1 V			
Voltage setting accuracy <sup>*2</sup>	$\pm(1\% \text{ of set} + 0.6 \text{ V}/1.2 \text{ V})$			
Maximum current <sup>*3</sup>	4 A / 2 A	8 A / 4 A	16 A / 8 A	32 A / 16 A
Maximum instantaneous current <sup>*4</sup>	12 A / 6 A	24 A / 12 A	48 A / 24 A	96 A / 48 A
Power capacity	400 W	800 W	1600 W	3200 W

\*1. 135V/ 270V range

\*2. For an output voltage of 19 V to 190 V/38 V to 380 V, no load, and 23 °C  $\pm$  5 °C.

\*3. For an output voltage of 1.4 V to 100 V/2.8 V to 200 V. Limited by the power capacity when the output voltage is 100 V to 190 V/200 V to 380 V.

\*4. Limited by the maximum current.

### Output voltage stability

	PCR500M	PCR1000M	PCR2000M	PCR4000M
Line voltage variation <sup>*1</sup>	Within $\pm 0.15\%$			
Output current variation (135 V/270 V range) <sup>*2</sup>	For 40 Hz to 100 Hz: Within $\pm 0.15 \text{ V}/\pm 0.3 \text{ V}$ For other frequencies: Within $\pm 0.5 \text{ V}/\pm 1 \text{ V}$			
Output frequency variation <sup>*3</sup>	Within $\pm 1\%$			
Ripple noise <sup>*4</sup>	0.7 Vrms/ 1.4 Vrms (TYP)			
Ambient temperature variation <sup>*5</sup>	100 ppm/ °C (TYP)			

\*1. For changes in the rated range.

\*2. For an output voltage of 80 V to 135 V/160 V to 270 V, a load power factor of 1, stepwise change from an output current of 0 A to maximum current (or its reverse), using the output terminal on the rear panel.

\*3. For an output voltage of 100 V/200 V and a load power factor of 1. Output voltage variation with 55 Hz as reference.

\*4. For 5 Hz to 1 MHz components in DC mode using the output terminal on the rear panel.

\*5. For an output voltage of 100 V/200 V, an output current of 0 A, and within the operating temperature range.

### Output voltage waveform distortion ratio, Output voltage response time, Efficiency

	PCR500M	PCR1000M	PCR2000M	PCR4000M
Output voltage waveform distortion ratio <sup>*1</sup>	0.5 % or less			
Output voltage response time <sup>*2</sup>	150 $\mu\text{s}$ (TYP)			
Efficiency <sup>*3</sup>	70 % or more			

\*1. At an output voltage of 50 V to 135 V/100 V to 270 V, a load power factor of 1, and in AC mode.

\*2. For an output voltage of 100 V/200 V, a load power factor of 1, with respect to stepwise change from an output current of 0 A to the maximum current (or its reverse).

\*3. For AC mode, at an output voltage of 100 V/200 V, maximum current, load power factor of 1, and an output frequency of 40 Hz to 500 Hz.

## Measured value display

RMS, average (AVG), and power (W) are derived using the following equations.

$RMS$  (true rms computation) =  $\sqrt{(\sum(\text{square of the instantaneous voltage or instantaneous current})/\text{the number of samples.})}$

$AVG$  =  $\sum(\text{instantaneous voltage or instantaneous current})/\text{the number of samples}$

$W_{AC}$  =  $\sum(\text{instantaneous voltage} \times \text{instantaneous current})/\text{the number of samples}$

$W_{DC}$  =  $V_{AVG} \times I_{AVG}$

Sample period: 100 ms to 125 ms for AC output (an integer multiple of the output waveform period, 125 ms for DC output)

Update interval: Approx. 3 times/s, averaging over 3 s when averaging is turned on

		PCR500M	PCR1000M	PCR2000M	PCR4000M	
Voltage measurement <sup>*1</sup>	Resolution	0.1 V				
	Accuracy (135 V/270 V range) <sup>*2</sup>	For 45 Hz to 65 Hz and DC: $\pm(0.5\%$ of reading + 0.3 V/0.6 V) For all other frequencies: $\pm(0.7\%$ of reading + 0.9 V/1.8 V)				
Current measurement <sup>*3</sup>	Resolution	R M S AVG	0.01 A			0 A to 99.99 A: 0.01 A 100 A or more: 0.1 A
		PEAK	0.01 A			0.1 A
	Accuracy (135 V/270 V range)	R M S AVG <sup>*4</sup>	For 45 Hz to 65 Hz and DC: $\pm(0.5\%$ of reading + 0.02 A/0.01 A) For all other frequencies: $\pm(0.7\%$ of reading + 0.04 A/0.02 A)	For 45 Hz to 65 Hz and DC: $\pm(0.5\%$ of reading + 0.04 A/0.02 A) For all other frequencies: $\pm(0.7\%$ of reading + 0.08 A/0.04 A)	For 45 Hz to 65 Hz and DC: $\pm(0.5\%$ of reading + 0.08 A/0.04 A) For all other frequencies: $\pm(0.7\%$ of reading + 0.16 A/0.08 A)	For 45 Hz to 65 Hz and DC: $\pm(0.5\%$ of reading + 0.16 A/0.08 A) For all other frequencies: $\pm(0.7\%$ of reading + 0.32 A/0.16 A)
		PEAK <sup>*5</sup>	$\pm(2\%$ of reading + 0.1 A/0.05 A) (TYP)	$\pm(2\%$ of reading + 0.2 A/0.1 A) (TYP)	$\pm(2\%$ of reading + 0.4 A/0.2 A) (TYP)	$\pm(2\%$ of reading + 0.8 A/0.4 A) (TYP)
Power measurement	Resolution	0.1 W, 1 W (For 1 000 W or more)				
	Accuracy <sup>*6</sup>	$\pm(2\%$ of reading + 0.5 W)	$\pm(2\%$ of reading + 1 W)	$\pm(2\%$ of reading + 2 W)	$\pm(2\%$ of reading + 4 W)	

\*1. The voltage display is set to RMS in AC mode and AVG in DC mode.

\*2. AC mode: For an output voltage of 13.5 V to 135 V/27 V to 270 V and 23 °C  $\pm$  5 °C.

DC mode: For an output voltage of 19 V to 190 V/38 V to 380 V and 23 °C  $\pm$  5 °C.

\*3. Peak current value holds the maximum value of the absolute value of the peak current for 0.3 s or approximately 5 s.

\*4. For a waveform of crest factor 3 or less, an output current in the range of 5 % to 100 % of the maximum current, and 23 °C  $\pm$  5 °C.

\*5. For a waveform of crest factor 3 or less, an output current in the range of 5 % to 100 % of the maximum peak current in AC mode, an output current in the range of 5 % to 100 % of the maximum instantaneous current in DC mode, and 23 °C  $\pm$  5 °C.

\*6. For an output voltage of 50 V or greater, an output current in the range of 10 % to 100 % of the maximum current, DC or an output frequency of 45 Hz to 65 Hz, a load power factor of 1, and 23 °C  $\pm$  5 °C.

## General Specifications

		PCR500M	PCR1000M	PCR2000M	PCR4000M
Insulation resistance	Between input and chassis, output and chassis, input and output	500 Vdc, 30 MΩ or more			
Withstand voltage	Between input and chassis, output and chassis, input and output	1.5 kVac, 1 minute			
Isolation voltage		±380 Vdc			
Earth continuity		25 Aac, 0.1 Ω or less			
Electromagnetic Compatibility (EMC) <sup>1, 2</sup>		Complies with the requirements of the following directive and standards. EMC Directive 2014/30/EC EN 61326-1 (Class A <sup>3</sup> ) EN 61000-3-2 (Class A <sup>3</sup> , Group 1 <sup>4</sup> ) EN 61000-3-3 (Class A <sup>3</sup> , Group 1 <sup>4</sup> ) The maximum length of all cables and wires connected to the PCR-M Series must be less than 3 m.		Complies with the requirements of the following directive and standards. EMC Directive 2014/30/EC EN 61326-1 (Class A <sup>3</sup> ) The maximum length of all cables and wires connected to the PCR-M Series must be less than 3 m.	
Safety <sup>1</sup>		Complies with the requirements of the following directive and standard. Low Voltage Directive 2014/35/EC <sup>2</sup> EN 61010-1 (Class I <sup>5</sup> , Pollution Degree2)			
Circuit system		PWM inverter system			
Environment	Operating environment	Indoor use, Overvoltage Category II			
	Operating temperature range	00 °C to 40 °C (32 °F to 104 °F)			
	Storage temperature range	-10 °C to 60 °C (14 °F to 140 °F)			
	Operating humidity range	20 %rh to 80 %rh (no condensation)			
	Storage humidity range	90 %rh or less (no condensation)			
	Altitude	Up to 2 000 m			
External dimensions		See "Dimensions"			
Weight		Approx. 6 kg (13.23 lb)	Approx. 11 kg (24.25 lb)	Approx. 15 kg (33.07 lb)	Approx. 32 kg (70.55 lb)
Input terminal		Inlet	M4	M6	
Output terminal		M4			M6
Accessories	Power cord	See "Accessory" -> p2			
	Ferrite core	--		1 pc.	--
	Cable tie	--		1 pc.	--
	Read This First	1 copy			
	Quick Reference	English: 1 copy, Japanese: 1 copy			
	Safety information	1 copy			
	CD-ROM	1 disc			

\*1. Does not apply to specially ordered or modified PCR-Ms.

\*2. Only on models that have the CE marking on the panel. PCR-M series will not be in compliance with EMC limits if the OUTPUT outlet on the front panel is used. PCR2000M will not be in compliance with EMC limits unless the ferrite core is attached on the load wires.

\*3. This is a Class A equipment. This product is intended for use in an industrial environment. This product may cause interference if used in residential areas. Such use must be avoided unless the user takes special measures to reduce electromagnetic emissions to prevent interference to the reception of radio and television broadcasts.

\*4. This is a Group 1 equipment. This product does not generate and/or use intentionally radio-frequency energy, in the form of electromagnetic radiation, inductive and/or capacitive coupling, for the treatment of material or inspection/analysis purpose.

\*5. This is a Class I equipment. Be sure to ground this product's protective conductor terminal. The safety of this product is only guaranteed when the product is properly grounded.

\*6. Pollution is addition of foreign matter (solid, liquid or gaseous) that may produce a reduction of dielectric strength or surface resistivity. Pollution Degree 2 assumes that only non-conductive pollution will occur except for an occasional temporary conductivity caused by condensation.



## Interface Specifications

### Common interface specifications

Software protocol	IEEE488.2 Std 1992
Command language	SCPI Specification 1999.0
Operation details	Functions expanded during remote control <sup>*1</sup>
	Functions expanded when an option is installed <sup>*2</sup>
	Apparent power measurement Reactive power measurement Power factor measurement Crest factor Peak hold current measurement AC + DC mode (The specifications of output rating such as the voltage range, maximum current, and power capacity are the same as those of the DC mode.) Panel storage memory: 10 memories <sup>*3</sup>

\*1. There are no specifications for the accuracy.

\*2. Activated when the GPIB, USB, or analog interface is installed and during remote control.

\*3. Includes the three standard memories.

### RS232C interface specifications

Hardware	EComplies with EIA-232-D D-SUB 9-pin connector (male) <sup>*1</sup> Baud rate: 1 200, 2 400, 4 800, 9 600, or 19 200 bps Data length: 8 bits, stop bit: 1 bit, and parity bit: None Flow control: Xon/Xoff
Program message terminator	LF during reception, CR+LF during transmission

\*1. Use a cross cable (null modem cable).

### GPIB interface specifications (IB21 option)

Hardware	Complies with IEEE Std 488.1-1978 SH1, AH1, T6, L4, SR1, RL1, PP0, DC1, DT1, C0, E1
Program message terminator	LF or EOI during reception, LF+EOI during transmission
Primary address	1 to 30

### USB interface specifications (US21 option)

Hardware	Complies with USB 2.0. Data rate: 12 Mbps (full speed).
Program message terminator	LF or EOM during reception, LF+EOM during transmission
Device class	Complies with the USBTMC-USB488 device class specifications

## Interface Specifications (Cont.)

### Analog interface specifications (EX04-PCR-M option)

Total performance when the EX04-PCR-M is installed in the PCR-M. Items not listed below conform to the specifications of the PCR-M.

Input terminal	Maximum allowable input voltage	±15 V	
	Type	BNC	
	Input impedance	10 kΩ ±5 % (unbalanced)	
	Isolation voltage	±100 Vmax	
EXT-AC mode <sup>*1</sup>	Input voltage range	0 V to ±10 V (DC)	
	Voltage amplification ratio (135 V/270 V range)	13.5x/ 27x (Outputs an AC voltage of 0 V to 135 V/0 V to 270 V with respect to a DC voltage input of 0 V to 10 V)	
	Frequency setting range	40 Hz to 500 Hz	
	Other output rating specifications	Same as the specifications of the output rating for AC mode	
EXT-DC mode	Input voltage range	ATT : OFF	0 V to ±1.90 Vpeak (0 V to 1.35 Vrms sine wave)
		ATT : ON	0 V to ±10 V (DC)
	Input frequency range	ATT : OFF <sup>*2</sup>	40 Hz to 500 Hz (Sine wave) /40 Hz to 100 Hz (Rectangular wave) /DC
	Frequency characteristics	ATT : OFF	-0.3 dB at 500 Hz with respect to 55 Hz (typical value)
	Voltage amplification ratio (135 V/270 V range)	ATT : OFF	100x/ 200x (Outputs an AC voltage of 0 V to 135 V/0 V to 270 V with respect to a AC voltage input of 0 V to 1.35 V)
ATT : ON		19x/ 38x (Outputs a DC voltage of 0 V to ±190 V/0 V to ±380 V with respect to a DC voltage input of 0 V to ±10 V)	
Other output rating specifications		Same as the specifications of the output rating for DC mode	
Output voltage distortion ratio <sup>*3</sup>		PCR-M specifications + 0.5 % or less	
Output voltage temperature coefficient		PCR-M specifications + 200 ppm/°C (typical value)	
Insulation resistance	Between input (BNC) and chassi, input (BNC) and output	500 Vdc, 30 MΩ or more	
Withstand voltage	Between input (BNC) and chassi, input (BNC) and output	500 Vac, 1 minute	

\*1. ATT ON at all times

\*2. The measurable range of voltage, current, and power is DC and 40 Hz to 500 Hz. Set the frequency according to the input waveform period.

\*3. When DC voltage is applied for EXT-AC mode or when a sine wave with distortion ratio of 0.1 % or less is applied for EXT-DC mode.

# Dimensions

Unit: mm (inch)

## ■ PCR500M

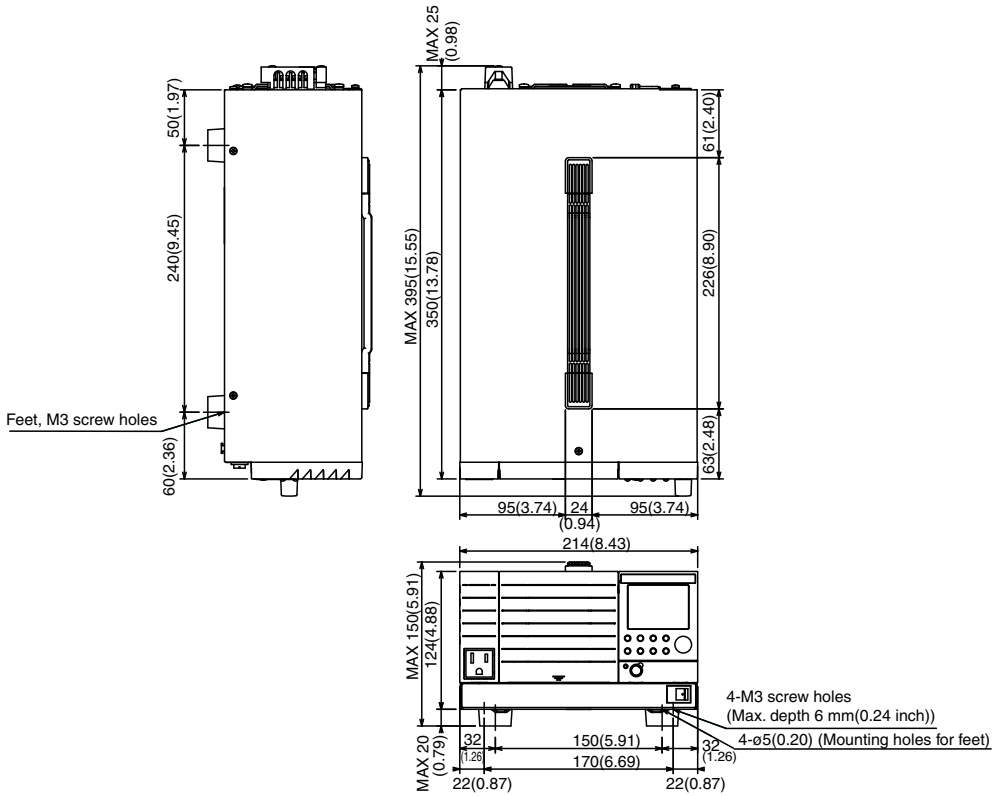

## ■ PCR1000M

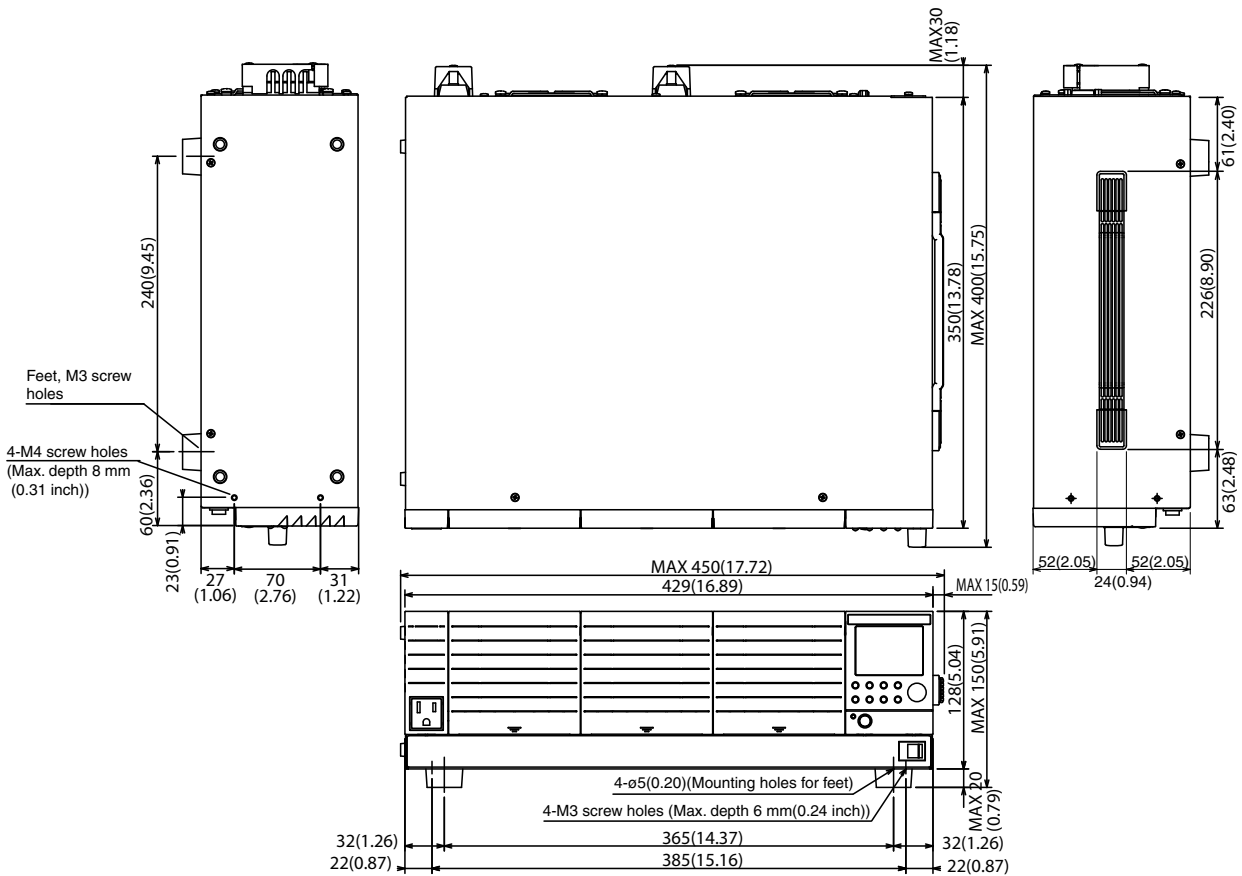

# Dimensions (Cont.)

■ PCR2000M

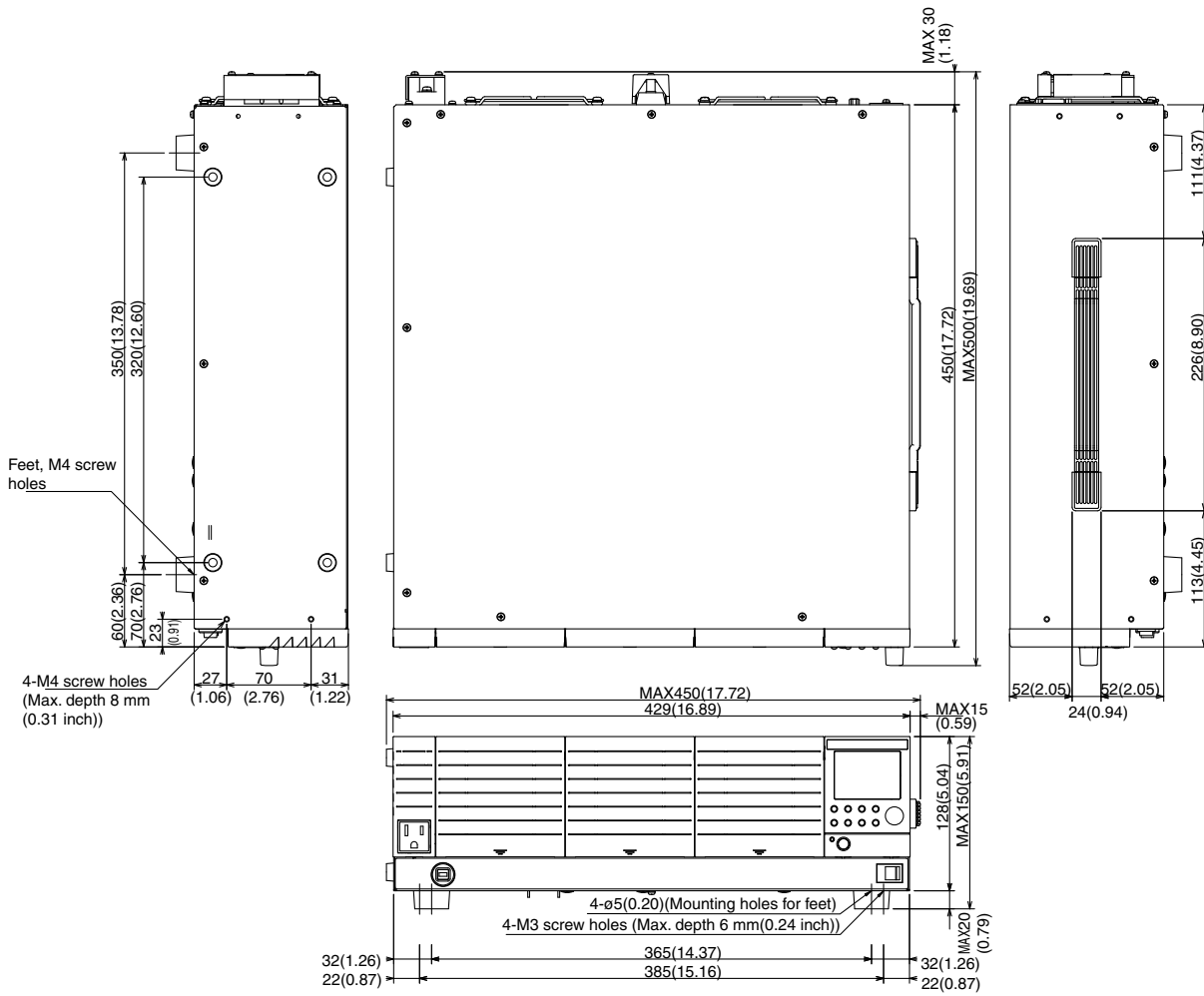

■ PCR4000M

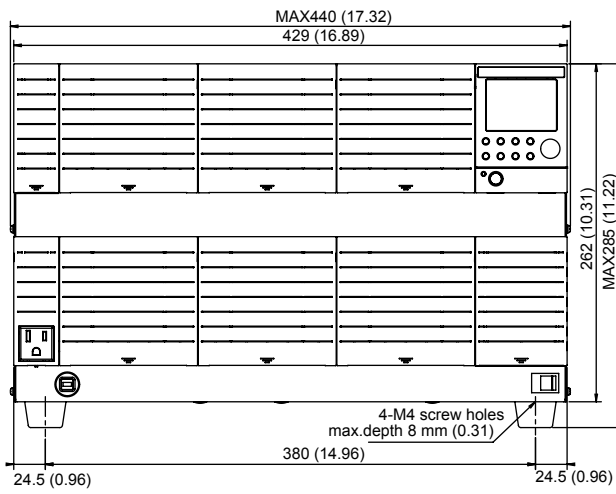
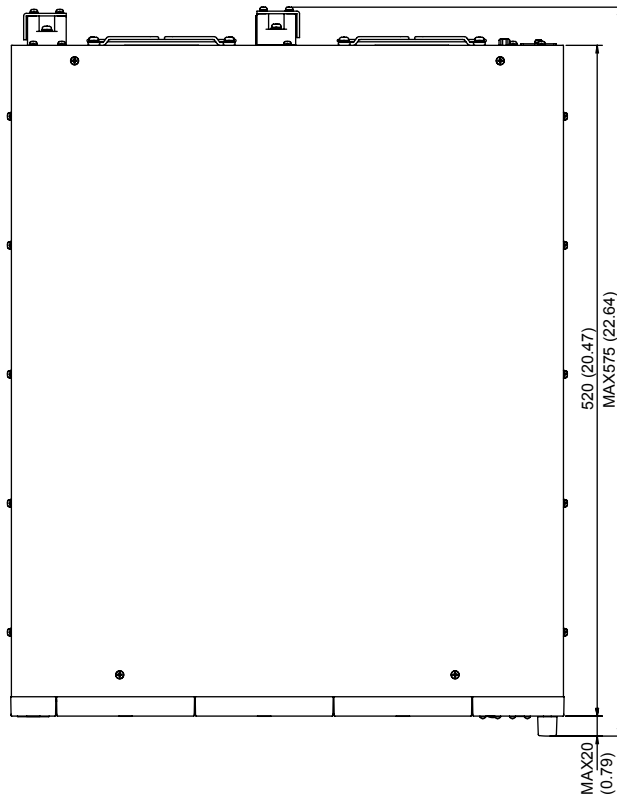
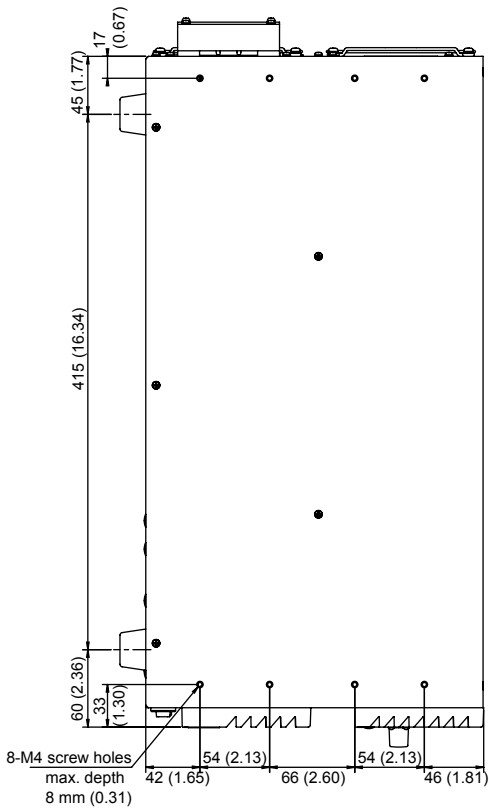



## Output and Load

### Rated output current of AC mode

#### ■ For linear loads

The rated AC output current of the PCR-M is limited by the PCR-M output capacity.

	PCR500M	PCR1000M	PCR2000M	PCR4000M
Output capacity	500 VA	1 000 VA	2 000 VA	4 000 VA

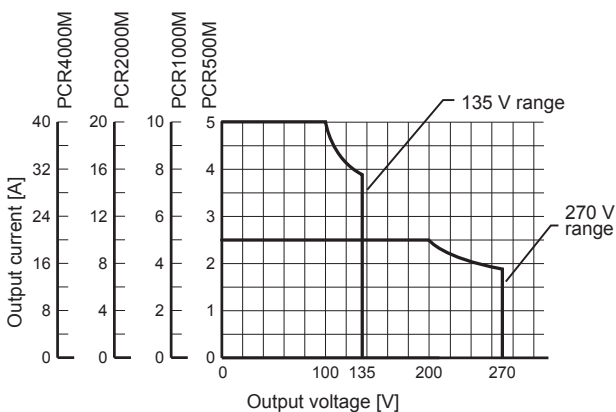

#### ■ For capacitor-input rectifying loads

In general, a peak current several times the output current rms flows near the peak output voltage as the output current.

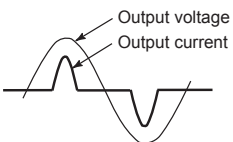

In this case, the maximum output peak current must not exceed three times the rated maximum current.

135 V range: Maximum peak current = (Rated output capacity/100 V) x 3

270 V range: Maximum peak current = (Rated output capacity/200 V) x 3

If the PCR-M is used with a current exceeding the maximum rated peak current or the maximum current, the protection function of the PCR-M activates and may extremely distort the output voltage waveform or cut off the output.

To supply the maximum peak current above, hold the output voltage (setting) constant. If you suddenly change (increase) the output voltage setting, the output or current waveform may be distorted.

#### ■ For loads that draw an inrush current

For the loads specified below, an inrush current (several to several tens of times the normal current) may flow during several to several tens of cycles of output frequency when voltage is applied or when the voltage changes suddenly.

##### • Transformers and slide transformers

When voltage is applied to a transformer or slide transformer load, an inrush current of a maximum of several tens to hundreds of times the normal current may flow for several cycles, depending on the voltage application timing or the state of biased magnetization.

##### • Motor and lamp loads

When voltage is applied to a motor or lamp load, an inrush current of several to several tens of times the normal current may flow for several tens to hundreds of cycles.

##### • For capacitor-input rectifying loads

For electronics devices with a capacitor input-type rectifier circuit at the input, if a protective (limiting) circuit against an inrush current is not provided, an inrush current several tens to hundreds of times the normal current may flow for several cycles.

The PCR-M is capable of feeding a maximum output peak current up to three times the rated maximum rms current to a capacitor input-type rectifying load.

If an inrush current exceeding the peak current flows, the protection function of the PCR-M activates and distort the output voltage waveform or cut off the output.

#### ■ For loads that generate surges

Loads (such as a fluorescent lamp) that generate surges when voltage is applied or when the voltage changes suddenly may cause the PCR-M to malfunction. For these types of loads, install a noise filter in the load end.

#### ■ For special loads

A current of 100 kHz to 150 kHz caused by the OUTPUT ripple voltage of a PWM inverter method flows to a capacitor when the capacitor is directly connected to the INPUT terminal of a load.

## Output and Load (Cont.)

### Rated output current of DC mode

The rated DC output current that can be drawn from the PCR-M is limited by the PCR-M output capacity.

	PCR500M	PCR1000M	PCR2000M	PCR4000M
Output capacity	400 W	800 W	1 600 W	3 200 W

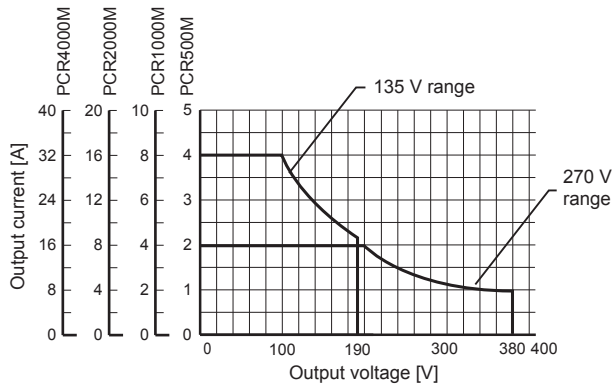

If the PCR-M is used with a current exceeding the rated DC output current, the protection function of the PCR-M activates and may cause the output voltage to drop or to be cut off.



# Operating Characteristics

## ■ Output current versus input current and efficiency characteristics (typical values in AC mode)

The output current ratio is a percentage where 100 % represents the maximum rated output current.

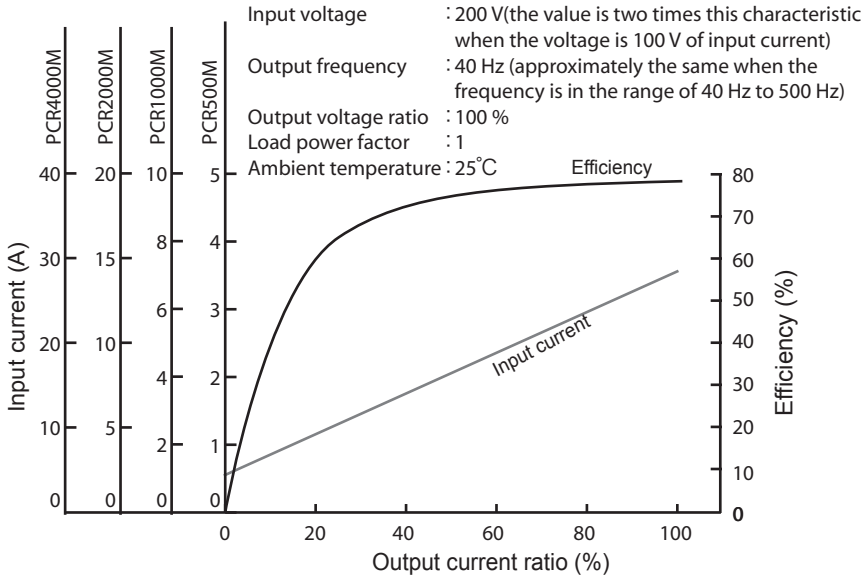

## ■ Output voltage versus input current and efficiency characteristics (typical values in AC mode)

The output voltage ratio is a percentage where 100 % represents an output voltage of 100 V (output 135 V range) or 200 V (output 270 V range).

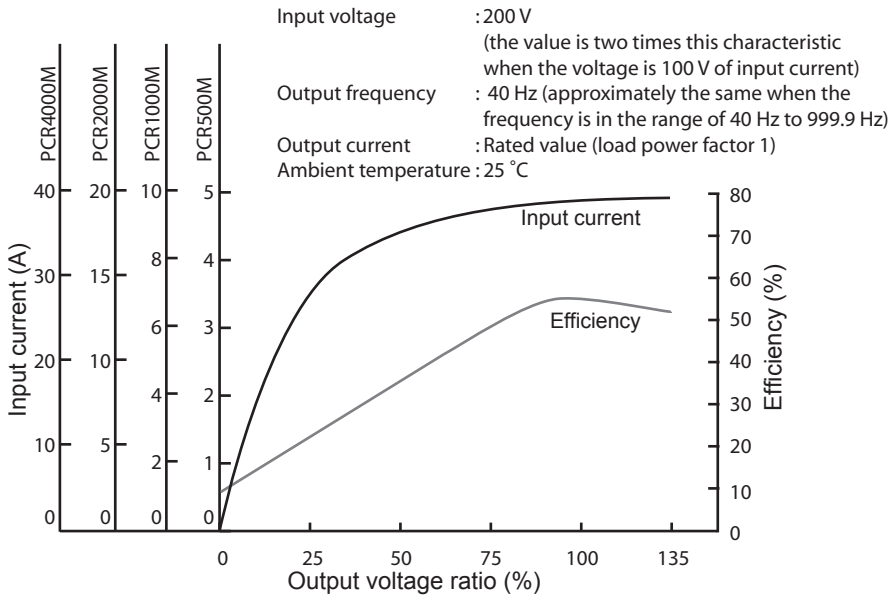

# Overload Protection Functions

## ■ Current limiting function

This function is activated if the PCR-M's output current exceeds the current limit value (maximum setting: 1.05 times the rated maximum current). If the current limiting function is activated, OVER LOAD illuminates, and the output voltage gradually drops. If this condition lasts approximately 3 seconds, the output is automatically turned off.

## ■ Peak current and power monitor functions

This function is activated if the PCR-M's peak current exceeds three times the rated maximum current. If a current exceeding three times the rated maximum current flows through the load, OVER LOAD illuminates, and the output voltage drops or the waveform is distorted. If this condition lasts approximately 10 seconds, the output is automatically turned off.

## ■ Causes of and remedies for overload status

If the overload protection function is activated, take the remedies below. Then, wait at least 1 minute before resuming operations.

When the cause of the overload is eliminated, the protection function is automatically deactivated.

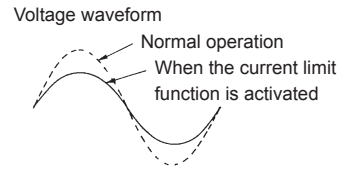

Fig. A

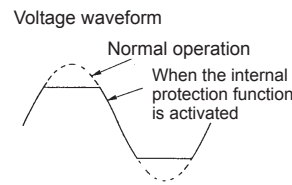

Fig. B-1

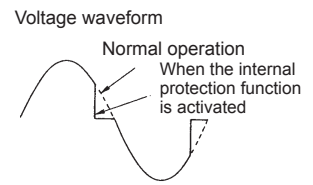

Fig. B-2

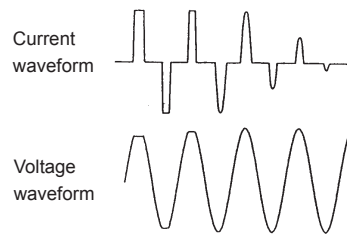

Fig. C

### For linear loads

Overload Condition		Remedy
Gradual output current increase	If the voltage drops as shown in Fig. A, the current limiting function is activated.	If the current limit value is set low, change the setting.
	If the output voltage waveform is distorted as shown in Fig. B-1 or B-2, the internal protection function is activated.	If the rated maximum current is exceeded, reduce the load.
Sudden output current increase	If the output voltage waveform is distorted as shown in Fig. B-1, B-2, or C, the internal protection function is activated.	

### For capacitor-input rectifying loads

Overload Condition		Remedy
Output current increase	If the voltage drops as shown in Fig. A, the current limiting function is activated.	If the current limit value is set, change the setting. If the rated maximum current is exceeded, reduce the load.
	If the voltage waveform is distorted as shown in Fig. C, the internal protection function is activated due to the output peak current.	Reduce the peak current.

### For loads that draw an inrush current

Overload Condition		Remedy
When voltage is applied to the load or when the voltage suddenly changes	If the voltage waveform is distorted as shown in Fig. C, the internal protection function is activated due to the inrush current.	Reduce the inrush current.

## Glossary

### ■ Rated output (power) capacity or power capacity

The maximum value (unit: VA) of the output power capacity that can be continuously supplied when the output voltage is 100 V to 135 V (for the 135 V range) or 200 V to 270 V (for the 270 V range) and the output frequency is 40 Hz to 500 Hz in AC mode or when the output voltage is 100 V to 190 V (for the 135 V range) or 200 V to 380 V (for the 270 V range) in DC mode.

	PCR500M	PCR1000M	PCR2000M	PCR4000M
Power capacity	500 VA	1 000 VA	2 000 VA	4 000 VA

The power capacity in DC mode is 80 % of that of AC mode.

### ■ Rated maximum current

The maximum value (unit: A) of the output current (rms value) that can be continuously supplied when the output voltage is 100 V (for the 135 V range) or 200 V (for the 270 V range) and the output frequency is 40 Hz to 500 Hz in AC mode or when the output voltage is 100 V (for the 135 V range) or 200 V (for the 270 V range) in DC mode.

The maximum current in DC mode is 80 % of that of AC mode.

$$\text{Rated maximum current} = \frac{\text{Rated output (power) capacity [VA, W]}}{\text{Output voltage 100 V or 200 V}}$$

### ■ Rated output current

- For AC mode

The maximum continuous value of the output current (rms value) that has been reduced by the output voltage.

- For DC mode

The maximum continuous value of the output current (unit: A) that has been reduced by the output voltage.

### ■ Maximum peak current (AC mode only)

The maximum continuous value (unit: A<sub>peak</sub>) of the output current (peak value) that the PCR-M can supply to a capacitor input-type rectifying load when the output voltage is 100 V to 135 V (for the 135 V range) or 200 V to 270 V (for the 270 V range) and the output frequency is 40 Hz to 500 Hz.

Maximum peak current = Rated maximum current (rms value) × 3

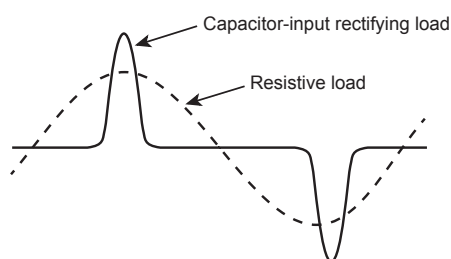

### ■ Output voltage waveform distortion ratio

The total harmonic distortion factor (%) of the output voltage waveform when the output voltage is 50 V to 135 V (for the 135 V range) or 100 V to 270 V (for the 270 V range) and the load power factor is 1.

### ■ Output voltage response time

The time (unit: μs) for the output voltage change to exceed 10 % of the overall change and return within 10 % of the overall change, when the output current percentage is changed from 0 % to 100 % given that the output voltage is 100 V (for the 135 V range) or 200 V (for the 270 V range) and the load power factor is 1 (in the AC mode).

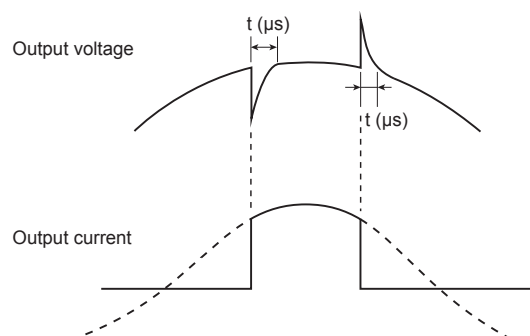

### ■ Power factor (PF)

The power factor is the ratio of the active power with respect to the apparent power. It indicates the level of degradation in the efficiency caused by the phase difference between the AC voltage and AC current.

$$\text{Power factor} = \frac{\text{Active power}}{\text{Apparent power}}$$

### ■ Form factor

The form factor is the ratio of the rms value with respect to the average value.

$$\text{Form factor} = \frac{\text{Rms value}}{\text{Average value}}$$

### ■ Crest factor (CF)

The crest factor is the ratio of the rms value with respect to the peak value (crest value) of the waveform.

$$\text{Crest factor} = \frac{\text{Peak value}}{\text{Rms value}}$$

The crest factor is 1.41 for sine waves.

### ■ Active filter

A circuit used to reduce the input current distortion factor (harmonic current). This filter is used in the input power-supply block of the PCR-M. It is a switching-controlled active filter. The use of the filter improves the power factor (0.9 (typical value)).

## Glossary (Cont.)

### ■ Capacitor input-type rectifying (circuit) load

This is a load whose rectifier circuit part is constructed as shown below. The rectifier circuit is used to convert the input AC voltage into the DC voltage that the device needs to operate.

The peak input current is normally approximately two to four times the rms value. The conduction angle (the period that the current is flowing for) centered on the peak output voltage (phase angle of 90 deg or 270 deg) is approximately 20 deg to 90 deg.

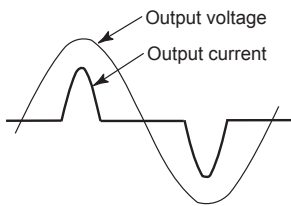
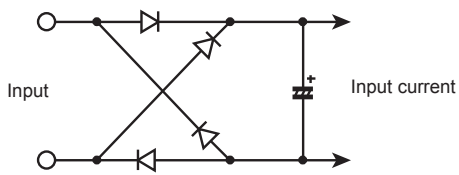
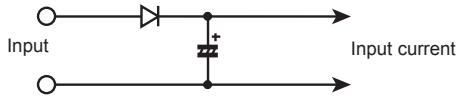

## Options

### Interface boards

The functions below are expanded depending on the interface board that is installed in the PCR-M.

Selection of AC+DC mode in which DC power is superimposed on the AC power

Increased number of memory sets from 3 to 10.

- GPIB interface board (IB21)

This is an interface board used to control the PCR-M with the GPIB.

- USB interface board (US21)

This is an interface board used to control the PCR-M with the USB.

- Analog interface board (EX04-PCR-M)

This is an interface board used to control the output with external analog signals. The following functions are expanded.

The voltage of the output AC waveform (sine wave) is varied according to the input DC signal (EXT-AC mode).

The input waveform is simply amplified and output (EXT-DC mode).

#### ■ Attachment of the Optional Interface Board

Install an interface board to the option slot on the rear panel if you wish to control the PCR-M.

- 1 Check that the **POWER** switch is turned off.
- 2 Touch the grounded metal to discharge your physical static electricity.
- 3 Unfasten the screws that are holding the slot cover in place, and remove the cover from the panel.

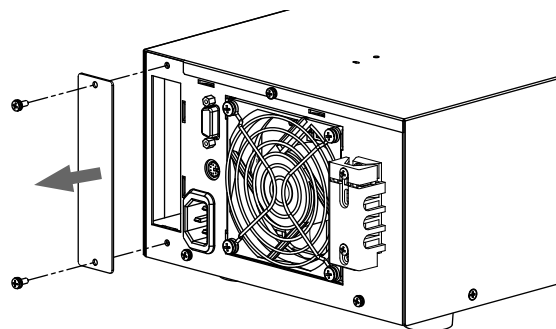

- 4 Hold the panel section of the board so that the component side of the printed circuit board is facing right.
- 5 Slide the board into the slot so that the connector section of the printed circuit board is inserted into the connector at the back of the slot.

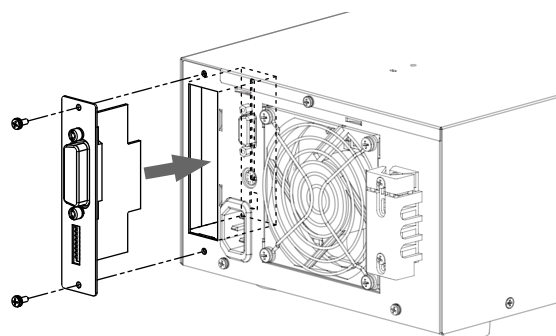

- 6 Push the board all the way in
- 7 Use the screws that were holding the slot cover in place to fix the board to the panel.

## Options (Cont.)

### Rack mount Frame/ Rack mount bracket

By using the rack mount frame, you can mount the PCR500M to the standard racks made by Kikusui. By using the rack mount brackets, you can mount the PCR1000M, PCR2000M, and PCR4000LE to the standard racks made by Kikusui.

The following table lists the frame/brackets that are used to attach the PCR-M Series to EIA inch racks or JIS millimeter racks. For details on how to mount the product to the rack, see the each operation manual.

	Frame/Bracket model	Description
PCR500M	KRA3	EIA inch rack
	KRA150	JIS millimeter rack
	KBP3-2	Blank panel
PCR1000M	KRB3-TOS	EIA inch rack
PCR2000M	KRB150-TOS	JIS millimeter rack
PCR4000M	KRB6	EIA inch rack
	KRB300	JIS millimeter rack

Detach the handle and the feet before you mount the PCR-M Series to a rack mount frame/brackets.

#### ■ Detaching the feet and handle

We recommend that you keep all pieces that you have removed from the PCR-M Series. You will need these pieces if you remove the PCR-M Series from the rack.

#### PCR500M

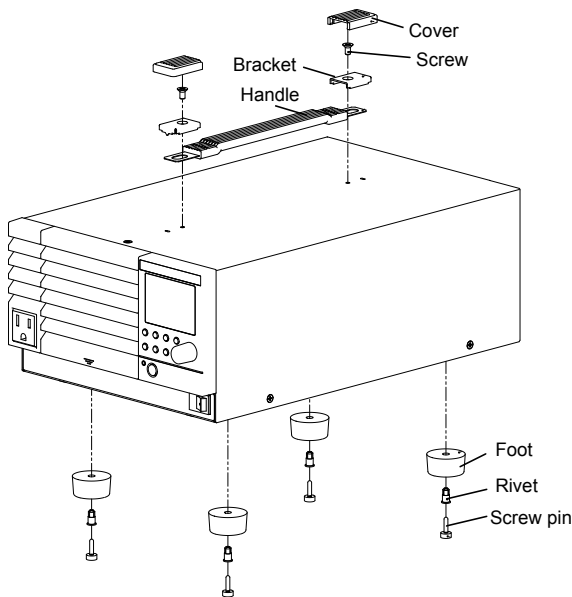

- 1** Pull up on the handle cover (two locations).
- 2** Unfasten the screws (two locations) and remove the entire handle.
- 3** While pulling down on each foot on the bottom (four locations), turn the screw pin, and remove the foot. Remove all four feet.

#### PCR1000M/ PCR2000M

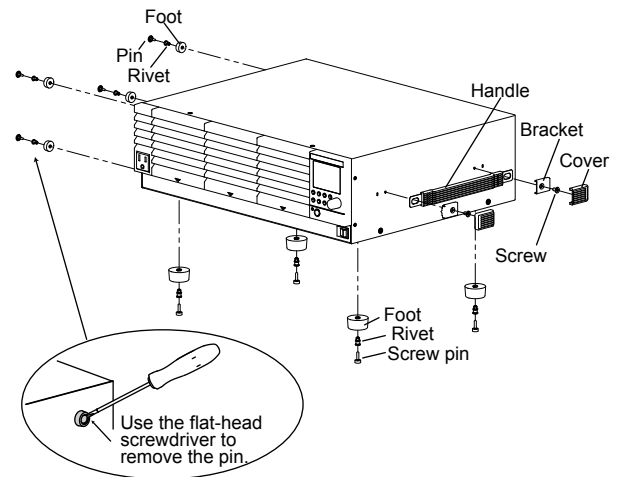

- 1** Pull up on the handle cover (two locations).
- 2** Unfasten the screws (two locations) and remove the entire handle.
- 3** While pulling down on each foot on the bottom (four locations), turn the screw pin, and remove the foot. Remove all four feet.
- 4** Unlatch the pin in the foot on the side (four locations) using a flat-head screwdriver, and remove the foot. Remove all four feet. (PCR1000M / PCR2000M only)

#### PCR4000M

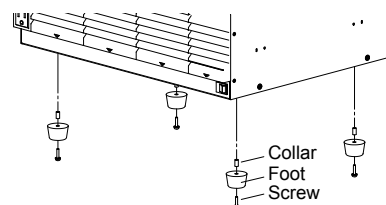

Remove the screw that hold each foot in place to detach the four feet.

■ Outline diagram and dimensions

Unit: mm (inch)

**PCR500M**

When mounting on an inch rack (frame model KRA3)

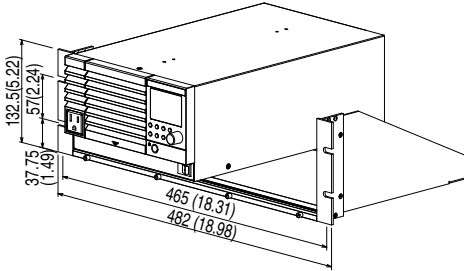

When mounting on a millimeter rack (frame model KRA150)

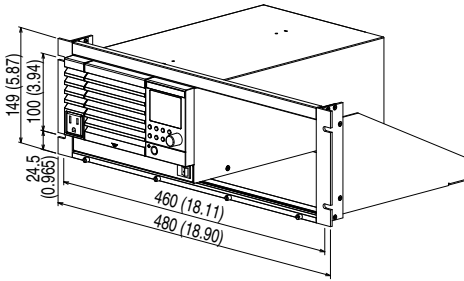

**PCR1000M/ PCR2000M**

When mounting on an inch rack (bracket model KRB3-TOS)

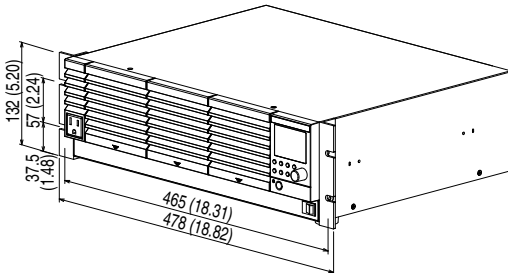

When mounting on a millimeter rack (bracket model KRB150-TOS)

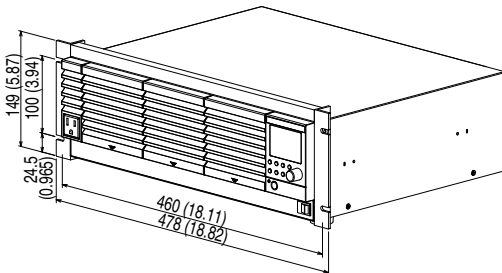

**PCR4000M**

When mounting on an inch rack (bracket model KRB6)

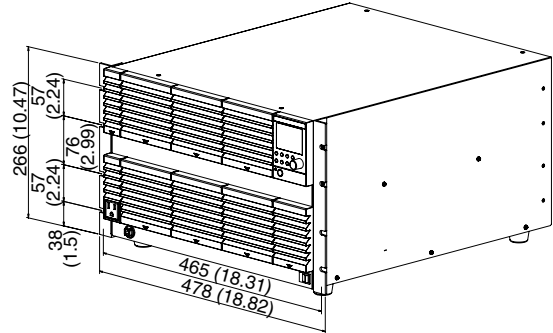

When mounting on a millimeter rack (bracket model KRB300)

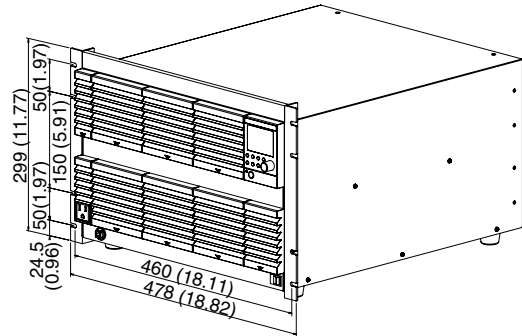

## Factory Default Settings (Initialization)

If you turn the POWER switch on while holding down the RECALL key, all items listed in table are set to factory default settings.

Item	PCR-M
Output	Off
Output mode	AC
Voltage range	135 V
Voltage	AC 0.0 V
	DC 0.0 V
Frequency	60.0 Hz
Measured value display	RMS
Locking the Panel Operation	Released

### Limit values

Item	PCR500M	PCR1000M	PCR2000M	PCR4000M
AC	Voltage upper limit			
	275.0 V			
	Voltage lower limit			
	0.0 V			
	Current limit			
	5.25 A	10.50 A	21.00 A	42.00 A
DC	Frequency upper limit			
	500.0 Hz			
	Frequency lower limit			
	40.0 Hz			
	Voltage upper limit			
	388.0 V			
DC	Voltage lower limit			
	0.0 V			
	Current limit			
	4.20 A	8.40 A	16.80 A	33.60 A
Current limit operation	TRIP			

### Configuration

Item	PCR-M
OUTPUT on phase	OFF
Phase angle	0 deg
Measured value averaging	OFF
Peak hold time	SHOr (SHORT)
Communication interface type	232 (RS232C)
RS232C baud rate	19.2 (19200 bps)
RS232C XON/XOFF control	On
GPIB address	5
Communication error trace function	OFF

### Memory A, B, C

Item	PCR500M	PCR1000M	PCR2000M	PCR4000M
Voltage	AC 0.0 V			
	DC 0.0 V			
Frequency	60.0 Hz			
Voltage range	135 V			
Output mode	AC			
Limit values AC	Voltage upper limit			
	275.0 V			
	Voltage lower limit			
	0.0 V			
	Current limit			
	5.25 A	10.50 A	21.00 A	42.00 A
Limit values DC	Frequency upper limit			
	500.0 Hz			
	Frequency lower limit			
	40.0 Hz			
	Voltage upper limit			
	388.0 V			
Limit values DC	Voltage lower limit			
	0.0 V			
	Current limit			
	4.20 A	8.40 A	16.80 A	33.60 A
Current limit operation	TRIP			



## Maintenance

### Calibration

The PCR-M is shipped after carrying out appropriate calibrations. We recommend periodic calibration to maintain the performance.

For calibration, contact your Kikusui agent or distributor.

### Cleaning

#### **WARNING**

**Possible electric shock. May lead to death or injury. Before carrying out maintenance work, be sure to turn the POWER switch off and removing the plug of power cord from an outlet or turn off the circuit breaker of switchboard.**

#### ■ **Cleaning the Panels**

If the panel needs cleaning, gently wipe using a soft cloth with water-diluted neutral detergent.

#### **CAUTION**

Do not use volatile chemicals such as benzene or thinner as they may discolor the surface, erase printed characters, cloud the display, and so on.

## Maintenance (Cont.)

### Cleaning (Cont.)

#### ■ Cleaning the Dust Filter

A dust filter is installed on the inside of the louver on the front panel. Periodically clean the filter to prevent clogging.

**⚠ CAUTION**

Clogged dust filters hinder the cooling of the inside of the instrument and can cause a malfunction and shortening of the service life.

- 1 Remove the louver A from the panel by placing a finger on the 2nd level of the louver and pulling down the entire louver while pulling the 1st level toward you.**

Pressing down the top level of the louver will ease the work.

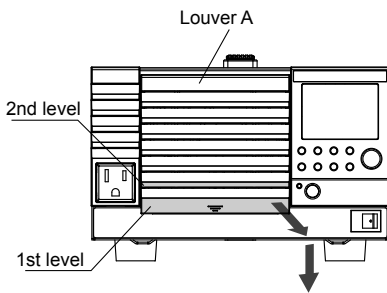

- 2 Pull the lower tab of louver B while pressing it upward, slide the entire louver downward, and remove the louver from the panel.**

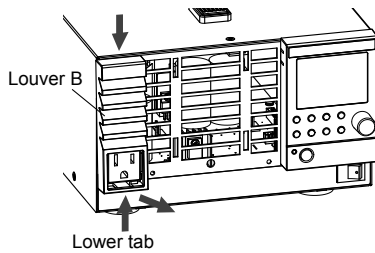

- 3 Remove the dust filter from the inside of the louver and clean it.**

Dispose of foreign particles and dust from the dust filter using a vacuum cleaner. If the filter is extremely dirty, clean it using a water-diluted neutral detergent and dry it completely.

**⚠ CAUTION**

When the PCR-M is in operation, air is sucked through the dust filter to cool the inside. If moisture is present in the dust filter, the temperature or humidity inside the PCR-M increases and may cause a malfunction.

- 4 Attach the dust filters to the louver.**

Attach them so that the tab on the louver fits into the cut on the dust filter.

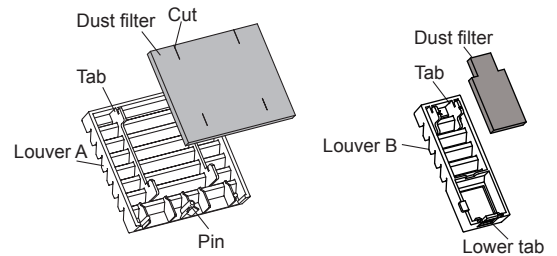

- 5 Attach louver B to the panel first.**

Insert the top tab of the louver into the panel, slide the louver up, and press the bottom area in to fix the louver in place.

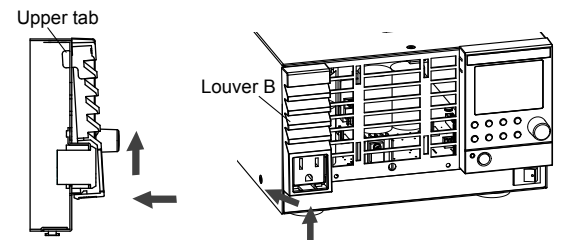

- 6 Attach louver A to the panel.**

Slide the entire louver up while holding the 2nd level from the bottom of the louver, and fix the pins in place.

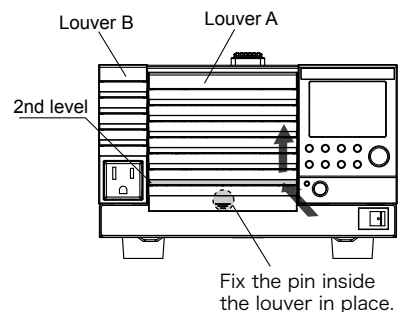

## Troubleshooting

If you suspect that the PCR-M has malfunctioned, check whether any of the items below apply to your case. In some cases, the problem can be solved quite easily. For details on remote control, see the FAQ section in the Communication Interface Manual.

If you find an item that corresponds to your case, follow the remedy for the item. If you do not, we recommend that you initialize the PCR-M (memory contents are cleared). If the remedy does not correct the problem, contact your Kikusui agent or distributor.

### ■ The control panel display does not turn on even when the POWER switch is turned on.

Check Item	Check	Possible Cause	Remedy
Is the rated voltage being applied to the AC inlet/ INPUT terminal block?	No	<ul style="list-style-type: none"> <li>Broken power cord</li> <li>Bad contact at the AC inlet of the rear panel (PCR500M)</li> <li>Improper connection of the power cord (except PCR500M)</li> </ul>	Check that the power cord is not broken and that the AC inlet connection is secure.
	Yes	Malfunction	Remove the power plug from the outlet. (PCR500M) Turn off the circuit breaker of switchboard. (except PCR500M) Immediately stop the use of the instrument and request repairs.

### ■ A alarm sounds when the POWER switch is turned on.

Check Item	Check	Possible Cause	Remedy
Is the ALARM LED illuminated or an error number displayed?	Yes	An alarm or error occurs.	Check the alarm or error type.
	No	Memory error	The PCR-M has been initialized due to memory error. Memory contents have been cleared. If a alarm sounds many times, request repairs.

### ■ The ALARM LED illuminates.

Check Item	Check	Possible Cause	Remedy
Is an alarm/error number displayed?	Yes	An internal or external error occurred on the PCR-M.	Check the alarm type.
Is the fan stopped?	Yes	The overheat protection (alarm A-04) tripped due to a fan failure.	Immediately stop the use of the instrument and request repairs.
Is the air inlet or outlet obstructed?	Yes	<ul style="list-style-type: none"> <li>The overheat protection (alarm A-04) tripped.</li> <li>Clogged dust filter.</li> </ul>	Allow at least 20 cm between the air outlet and the wall. Do not place objects within 20 cm. Clean the dust filter.
Is the ambient temperature exceeding 40 °C?	Yes	The overheat protection (alarm A-04) tripped.	Use the PCR-M in an ambient temperature of less than or equal to 40 °C. Move equipment that generate heat at high temperatures away from the PCR-M.

If your case does not correspond to any of the items above, see “Protection Functions and Alarm Errors.”

### ■ A portion or all of the control panel do not work.

Check Item	Check	Possible Cause	Remedy
Is the KEYLOCK LED illuminated?	Yes	Key lock is enabled.	Release the panel lock.
Is the input voltage within the rated range?	No	Abnormal input voltage	Set the input voltage so that it is within the rated voltage range.
Is there a device generating strong noise nearby?	Yes	Erroneous operation due to noise	Move the PCR-M away from the noise source.
Is the REMOTE LED illuminated?	Yes	The PCR-M is controlled via the RS232C, GPIB, or USB interface.	This is a normal behavior. To control the PCR-M from the panel, press the LOCAL key to enable local mode.
Are the voltage limit and frequency limit within the selectable range?	No	The limit values are not set correctly.	Set the limit values correctly.

### ■ The output voltage waveform is distorted.

Check Item	Check	Possible Cause	Remedy
Is OVER LOAD illuminated?	Yes	The overload protection tripped.	The PCR-M may be overloaded. Check the load.
	No	Malfunction	Immediately stop the use of the instrument and request repairs.

### ■ The voltage does not change even when the rotary knob is turned when the PCR-M is showing the measured value display.

Check Item	Check	Possible Cause	Remedy
Did you press the F, LIMIT, or CONFIG key after pressing the V key?	Yes	The rotary knob is disabled.	Press the V key twice again. The voltage changes on the measured value display.

## Troubleshooting (Cont.)

### ■ The DC output cannot be set to negative voltage.

Check Item	Check	Possible Cause	Remedy
Is the voltage lower limit set to a negative value?	No	The limit value is not set correctly.	Set the voltage lower limit to a negative value. The factory default voltage lower limit of DC mode is 0.0 V.

### ■ The PCR-M does not switch to local mode even when the local key is pressed.

Check Item	Check	Possible Cause	Remedy
Was a local lockout (LLO) command sent via the communication interface?	Yes	Local key operation disabled by local lockout (LLO).	Use a communication command to clear the local lockout (LLO) command.

### ■ The communication type or RS232C settings do not take effect.

Check Item	Check	Possible Cause	Remedy
Did you turn off the POWER switch after changing the settings?	No	The power has not been restarted.	The product saves its settings at 5 second intervals. After you change the settings, wait 5 seconds, turn the POWER switch off, and then turn it back on.
	Yes	The POWER switch was turned off before the product was able to save the new settings.	

### ■ The output operation is unstable.

Check Item	Check	Possible Cause	Remedy
Are the load wires twisted (run alongside each other)?	Yes	The product is malfunctioning.	Immediately stop using the PCR-M Series, and have it repaired.
	No	The wiring conductance is large.	Connect by twisting the load wires (running them alongside each other).

## I N D E X

### A

- accessory 2
- AC+DC mode 15
- AC mode 15
- active filter 43
- Air inlet 13
- air outlet 14
- alarm
  - clearing 22
  - description and remedy 23
- analog interface
  - specifications 34
- analog interface board 26
- averaging period 24

### B

- baud rate 25

### C

- calibration 49
- capacitor input-type rectifying load 44
- circuit breaker
  - requirement 4
- cleaning 49
  - dust filter 50
  - panel 49
- communication error trace 25
- communication interface 25
- CONFIG 24
- config settings 24
- crest factor 43
- current limit 19

### D

- DC mode 15
- dimensions 35
- dustfilter
  - cleaning 50

### E

- efficiency 30
- error
  - clearing 22
  - description and remedy 23
- EX04-PCR-M 45
- EXT-AC mode 15
- EXT-DC mode 15
- external analog signal 26

### F

- factory default settings 48
- feet
  - detaching 46
- ferrite core 10
- firmware version 7
- form factor 43
- frequency 16
- frequency limit 19
- Front panel 12

### G

- GPIB address 25

### H

- hangle
  - detaching 46

### I

- IB21 45
- initialization 48
- input ratings 29
- interface 45
  - attachment 45
  - specifications 33

### K

- key lock 21

### L

- LIMIT CONTROL 19
- limit value
  - setting 19
- load
  - cables 8
- LONG 24
- louver 50
- lower numeric display 18

### M

- maintenance 49
- maximum peak current 43
- measured value
  - display 18
- measured value averaging 24
- memory 20

### O

- options 45
- outlet 11
- output
  - on/off 17

- on phase 17, 24
- on phase angle 17
- principle of output on/off 17
- output and load 39
- output mode 15
- output rating
  - DC mode 30
- output ratings
  - AC mode 29
- OUTPUT terminal block 9
  - screw diameter 8
- output voltage
  - response time 30, 43
  - stability 30
  - waveform 30
- output voltage waveform distortion ratio 43
- OVER LOAD 23
- overload protection functions 42

### P

- panel
  - cleaning 49
- panel operation
  - locking 21
- peak current
  - hold time 24
- phase angle 24
- power capacity 43
- POWER cord
  - Connection (PCR500M) 3
  - Connection (PCR1000M to PCR4000M) 4
- power factor 43
- POWER switch 7
- product ID 25
- protection functions 22

### R

- rack mount bracket 46
- rack mount frame 46
- rated maximum current 43
- rated output capacity 43
- rated output current 43
- Rear panel 14
- remote control
  - error display 25

### S

- serial number 14
- SHORT 24
- specifications 29

analog interface **34**  
interface **33**

## T

TRIP **19**  
troubleshooting **51**

## U

upper numeric display **18**  
US21 **45**

## V

vender ID **25**  
voltage **16**  
voltage limit **19**  
voltage range **15**

## X

XON/XOFF **25**

## KIKUSUI ELECTRONICS CORP.

1-1-3 Higashiyamata, Tsuzuki-ku, Yokohama,  
224-0023, Japan  
Tel: +81-45-593-7570 Fax: +81-45-593-7571



Website

<http://www.kikusui.co.jp/en>