



**KIKUSUI**

PART NO. IB02528D  
Oct. 2017

# User's Manual

AC Power Supply PCR-LE2 series

**PCR6000LE2**

**PCR9000LE2**

**PCR12000LE2**

**PCR18000LE2**

**PCR27000LE2**

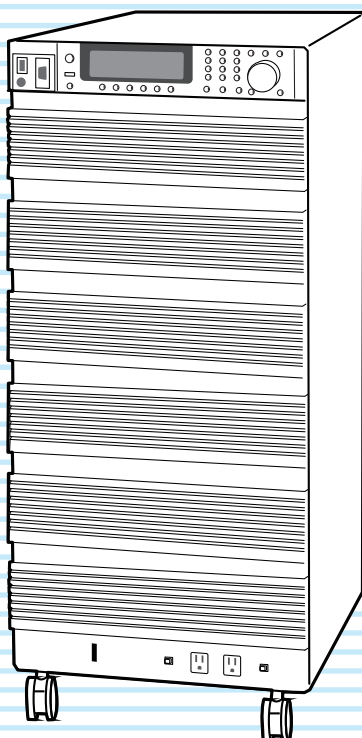

Checking the Package Contents 3

Features 3

About the PCR-LE2 Documentation 4

PCR-LE2 Series models 6

Precautions Concerning Installation 6

Moving the product 6

Handling the Terminal Block Tray (PCR6000LE2/ PCR9000LE2) 7

Connecting the power cord 8

Turning the Power On 10

Connecting the Load 12

## - Basic -

Front Panel 17

Rear Panel 19

Panel Operation Basics 20

Selecting the Output Mode 24

Setting the Output Voltage 25

Setting the Frequency 30

Turning Output On and Off 30

Displaying Measured Values 32

Limit Values and Protection Functions 34

Setting Limits 35

Using Protection Functions 40

Using Memory 42

## - Advanced -

Using the Synchronization Function 49

Using the Voltage compensation Function 50

Using Power Line Abnormality Simulations 55

Using the Sequence Function 58

Using the Harmonic Current Analysis Function 67

Generating Special Waveforms (Waveform bank) 68

Setting the Output Impedance 69

Setting Soft Starts (The voltage rise time) 69

Fixing the Internal Vcc 70

Selecting the Response 70

Using the Power Management Functions 71

Controlling the Output Using External Analog Signals 72

## - Specifications -

Main Unit Specifications 81

Option Specifications 88

Outline Drawings 89

## - Appendix -

Glossary 95

Operating Characteristics 97

About the output and the load 98

Peak hold current measurement 106

Sequence tutorial 107

Option 119

Factory Default Settings (Initialization) 126

Maintenance 129

Troubleshooting 130

Alarms and Trouble 132

Error Message 135

**Index 136**

This manual is intended for users of the PCR-LE2 Series AC Power Supply and their instructors.

Explanations are given under the presumption that the reader has knowledge related to electric safety tests.

Every effort has been made to ensure the accuracy of this manual. However, if you have any questions or find any errors or omissions, please contact your Kikusui agent or distributor.

## **Firmware version of the product to which this manual applies**

---

This manual applies to PCR-LE2s with firmware version 5.0x.

When making an inquiry about the product, please provide us with the following information.

Model (indicated at the top section on the front panel)

Firmware version

Serial number (indicated at the bottom section on the rear panel)

Copyright 2012 Kikusui Electronics Corporation

Thank you for purchasing the PCR-LE2 Series AC Power Supply.

The PCR-LE2 Series is a special version of the PCR-LE Series that can produce highly pure AC signals through the combination of its high-speed linear amplifier and arbitrary waveform synthesizer. It features switchable single-phase, single-phase three-wire, and three-phase outputs.

## Checking the Package Contents

When you receive the product, check that all accessories are included and that the accessories have not been damaged during transportation. If any of the accessories are damaged or missing, contact your Kikusui agent or distributor. We recommend that you save all packing materials, in case the product needs to be transported at a later date.

### Accessory

	Accessory	QTY.	Note
<input type="checkbox"/>	Heavy object warning label	1	PCR6000LE2/PCR9000LE2 only [A8-900-158]
<input type="checkbox"/>	Setup Guide	1	
<input type="checkbox"/>	CD-ROM	1	
<input type="checkbox"/>	Quick Reference	English: 1 pc. Japanese: 1 pc.	
<input type="checkbox"/>	Safety information	1	

## Features

The PCR-LE2 Series is equipped with the following features.

- Switchable between single-phase output, single-phase three-wire output, and three-phase output  
Three types of output are available on a single unit.
- Various power supply simulations  
Power line abnormalities such as outages and voltage dips can be simulated. This is a basic feature for power-supply-environment testing.
- Various measurements  
The rms voltage and current, the peak voltage and current, the active power, apparent power, and power factor of the output can be measured. Harmonic analysis (up to the 40th harmonic) can be performed on the output current.
- DC output  
The PCR-LE2 Series can generate DC output (single-phase output or single-phase three-wire output only) and AC + DC output (single-phase output only). This makes it possible to use the PCR-LE2 Series in a wide variety of fields, including chemistry and physics.
- Sequences  
The output voltage, frequency, and waveform can be changed over time. Power-supply-environment testing can be automated. In addition to the AC output sequences, DC output (single-phase output or single-phase three-wire output only) and AC + DC output (single-phase output only) sequences are also available. A variety of standard tests can also be performed.
- Sensing and regulation adjustment  
Even if the load device is at a remote location, the PCR-LE2 Series can stabilize the voltage across the load by correcting for voltage drops.  
There are two types of sensing: hard sensing (single-phase output only) and soft sensing. The different types of sensing are used depending on the load conditions and how you will use the PCR-LE2 Series.
- Output current control  
The output limit function can be used to limit the output current (rms) to a fixed value to perform continuous operation. Continuity tests on electrical equipment (such as switchboards, breakers, and wiring devices) can be performed under stable conditions.
- Power management function (power saving function)  
A sleep function, which turns the power units off to reduce power consumption when output is not generated for the specified length of time, and a power-saving function, which operates the power units at the bare minimum settings as required by the supply load, are available.
- Memory function  
Up to 99 entries of output frequency, voltage (AC or DC), and waveform bank settings can be saved to the internal memory.  
The contents of internal memory, panel settings, power line abnormality simulations, sequence data, and waveform bank data can be saved to a USB memory device.
- External communications  
The PCR-LE2 Series can be controlled remotely through its RS232C interface. If an optional interface board is used, the PCR-LE2 Series can be controlled remotely through USB, GPIB, and LAN interfaces.
- External analog signal control (optional)  
The EX05-PCR-LE/EX06-PCR-LE option enables you to control the PCR-LE2 Series output using external analog signals.

## About the PCR-LE2 Documentation

These manuals are intended for users of the PCR-LE2 Series AC Power Supply and their instructors.

Explanations are given under the presumption that the reader has knowledge related to electric safety tests.

You can view the PDF file using Adobe Reader 6.0 or later.

The HTML can be viewed using the following browser.

Browser: Microsoft Internet Explorer 9.0 or later

Every effort has been made to ensure the accuracy of this manual. However, if you have any questions or find any errors or omissions, please contact your Kikusui agent or distributor.

If you find any misplaced or missing pages in this manual, it will be replaced. If the manual gets lost or soiled, a new copy can be provided for a fee. To replace or purchase a manual, please contact your Kikusui agent or distributor. At that time, inform your agent or distributor of the "Part No." written on the front cover of this manual.

After you have finished reading this manual, store it so that you can use it for reference at any time.

### Notations used in the PCR-LE2 manual

In the PCR-LE2 manual, the PCR-LE2 Series AC Power Supply is also referred to as the PCR-LE2 Series and the PCR-LE2.

The term "PC" is used to refer generally to both personal computers and workstations.

The screen captures used in this manual may differ from the actual screens that appear on the PCR-LE2. The screen captures are merely examples.

The following markings are used in the explanations in the manual.

**⚠ WARNING**  
Indicates a potentially hazardous situation which, if ignored, could result in death or serious injury.

**⚠ CAUTION**  
Indicates a potentially hazardous situation which, if ignored, may result in damage to the product or other property.

- Note -  
Indicates information that you should know.

- DESCRIPTION -  
Explanation of terminology or operation principle.

(SHIFT+key name)

Indicates an operation that requires you to press a key indicated in blue characters (the lower row of text to the left of the key) while holding down the SHIFT key.

## Contents of the Included CD-ROM

Put the included CD-ROM into the CD-ROM drive. In a few moments, a start window will appear. If the start window does not appear, open the CD-ROM folder in Windows Explorer, and then double-click index.html to display the start window.



Accompanying CD-ROM contains following the items.

- KI-VISA x.x.x
- IVI-COM
- Operation Manual

Click the "See the Manual" to move to the Manual page.

- Tips -

### How to view ePub files on a tablet

To view an ePub file on a tablet, an ePub reader (e.g., iBooks, Himawari Reader) must be installed in the tablet. You can download ePub readers for free.

There are several ways to copy ePub files to your tablet, but we recommend that you download them from the Kikusui Electronics Corporation website.

1. Using a browser on your iPad, visit Kikusui Electronics Corporation website's Operation Manual Database (<http://www.kikusui.co.jp/en/download/>), and search for your PCR-LE2 series.
2. Tap the appropriate ePub file to download it.



When an ePub file is downloaded to your tablet, you can view it even when the tablet is not connected to the Web.

## Documentation Structure

The PCR-LE2 Series manual comprises the following documentation.

### ■ User's Manual -Basic-

- Front panel and Rear panel
- Panel Operation Basics
- Selecting the Output Mode
- Setting the Output Voltage/ Frequency
- Turning Output On and Off
- Displaying Measurement Values  
How to switch the display of measured value.
- Setting Limits  
Limits can be placed on the PCR-LE2 output voltage setting and frequency setting. They prevent damage to the load caused by mistaken operations and limit the current that flows through the load. You can set limits in advance according to the load conditions.
- Using Protection Functions  
The PCR-LE2 has the following protection functions.  
Input voltage drop protection  
Overheat protection (OHP)  
Overload protection  
Internal semiconductor protection (OCP)  
Output undervoltage protection (UVP)  
Output overvoltage protection (OVP)
- Using Memory  
You can store data to the PCR-LE2's internal memory and save data to a USB memory device.

### ■ User's Manual -Specifications-

Specifications contains the electrical specifications and outline drawings.

### ■ User's Manual -Appendix-

- Glossary, Operation Characteristics, Output and load
- Peak hold current measurement
- Sequence tutorial
- Option
- Factory Default Settings
- Maintenance
- Troubleshooting
- Alarms and Trouble
- Error Message

### ■ Setup Guide (This guide)

This guide is intended for first-time users of the product. It gives an overview of the product, connecting procedures, etc. Please read through and understand this guide before operating the product.

### ■ Quick Reference

The quick reference briefly explains the panel description and the basic operation of the product.

### ■ Safety information

This document contains general safety precautions for this product. Keep them in mind and make sure to observe them.

### ■ Programming Sheet

- Table for Recording Power Line Abnormality Simulation Operation Settings (XLS)
- Table for Recording Sequence Operation Settings (XLS)

### ■ User's Manual -Advanced-

- Using the synchronization Function  
The synchronization function synchronizes the frequency and phase of the PCR-LE2 output voltage with a 50 Hz or 60 Hz input power supply.
- Using the Voltage Compensation Function  
The compensation function compensates for voltage drops in the load cables when the load is connected to the PCR-LE2 over a long distance.
- Using Power Line Abnormality Simulations  
In AC mode, you can simulate power supply line errors by stopping the PCR-LE2 output and decreasing and increasing the voltage (to simulate voltage dips and pops).
- Using the Sequence Function  
A sequence is a series of settings - values such as the output voltage, frequency, and time - that are saved in advance and are then recalled and automatically carried out in order at a later time.
- Using the Harmonic Current Analysis Function  
You can perform harmonic analysis of the output current.
- Generating Special Waveforms (Waveform bank)  
You can generate peak-clipped sine waveforms.
- Setting the Output Impedance  
The PCR-LE2 output impedance (output resistance) is approximately  $0 \Omega$ . Commercial power supplies have an impedance (resistance) of several milliohms to several ohms. You can set the PCR-LE2 output impedance. This enables you to simulate the same environment as that which is provided by commercial power supplies.
- Setting Soft Starts (The voltage rise time)  
To prevent the output from being turned off (the alarm from being activated) and the voltage from dropping due to the load device's inrush current that exceeds the rated capacity of the PCR-LE2, you can control the inrush current by having the output voltage rise gradually when the output is turned on.
- Fixing the Internal Vcc  
To minimize loss in the linear amplifier section, the PCR-LE2 automatically adjusts the linear amplifier supply voltage (Vcc) to a level that is suitable for the output voltage. You can fix the Vcc voltage of the PCR-LE2. This is useful when you want to prioritize the output voltage response over the product's efficiency.
- Selecting the Response  
The PCR-LE2 uses a high-speed amplifier. Depending on the load circuits (especially in the case of capacitive loads) and the wiring conditions, the output may become unstable may oscillate. You can set the response speed of the internal amplifier according to the load conditions and how you will use the PCR-LE2.
- Using the Power Management Functions  
The PCR-LE2 has the following two power management functions: a sleep function and a power-saving function
- External analog signal control (optional)  
You can use the optional analog signal interface board to control the product with external analog signals.

### ■ Communication Interface Manual

This manual contains details about remote control.

Interface manual is written for readers with sufficient basic knowledge of how to control instruments using a personal computer.

## PCR-LE2 Series models

The PCR-LE2 Series generates single-phase output. The following models are available

Model	Rated output capacity		Maximum output current			
	Single-phase, Three-phase	Single-phase three-wire	Single-phase		Single-phase three-wire, Three-phase	
			100 V output	200 V output	100 V output	200 V output
PCR6000LE2	6 kVA	4 kVA	60 A	30 A	20 A	10 A
PCR9000LE2	9 kVA	6 kVA	90 A	45 A	30 A	15 A
PCR12000LE2	12 kVA	8 kVA	120 A	60 A	40 A	20 A
PCR18000LE2	18 kVA	12 kVA	180 A	90 A	60 A	30 A
PCR27000LE2	27 kVA	18 kVA	270 A	135 A	90 A	45 A

This product consists of three power unit groups.

Model	Output capacity per group
PCR6000LE2	2 kVA
PCR9000LE2	3 kVA
PCR12000LE2	4 kVA
PCR18000LE2	6 kVA
PCR27000LE2	9 kVA

During single-phase output, all groups are used.

During single-phase three-wire output or three-phase output, each phase (U, V and W) is assigned to a separate group.

During single-phase three-wire output, the phase W group is not used. During three-phase output, all groups are used.

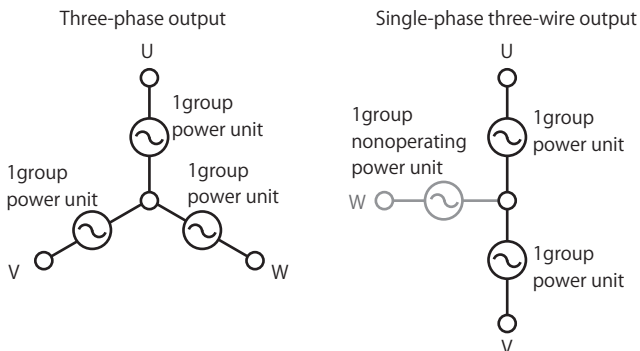

## Precautions Concerning Installation

When installing this product, be sure to observe the precautions provided in "Precautions Concerning Installation Location" in the Safety information manual. Items specific to this product are given below.

- When you install the product, be sure to observe the temperature and humidity ranges indicated below.
  - Operating temperature range: 0 °C to 50 °C (32 °F to 122 °F)
  - Operating humidity range: 20 %rh to 80 %rh (no condensation)
- When you store the product, be sure to observe the temperature and humidity ranges indicated below.
  - Storage temperature range: -10 °C to 60 °C (14 °F to 140 °F)
  - Storage humidity range: 90 %rh or less (no condensation)
- Allow at least 20 cm of space between the air inlet/outlet and the wall (or obstacles).
- Fix PCR6000LE2s and PCR9000LE2s to the floor using L-shaped or other similar brackets.
  - Base Hold Angles (OP03-KRC) are available as options.

## Moving the product

### Precautions when moving the PCR6000LE2/ PCR9000LE2

Note the following points when moving the product to the installation location or when transporting the product.

- Raise the stopper.
  - Moving the product with the stopper lowered may cause injuries due to the product falling over.
- Unlock the casters.
- Do not move the product by yourself.

Be sure to have two or more people move the product. Exercise special care when carrying the product over a slope or across steps.

Hold the product from underneath.

Check the product's weight before you transport it. The weight is displayed in the bottom of the rear panel.

If you are using a forklift, be sure to slide the forks under the bottom of the product, check that the product is stable, and then raise the product.

If you are using a band or similar item to raise the product with a crane, be sure to slide the band under the bottom of the product, check that the product is stable, and then raise the product.

- When you move the product, do not tip the product on its side or turn it upside down.

### Locking the casters and using the stopper

This product has casters on its bottom side, so it is easy to move the product. To ensure that the product is not moved accidentally while it is being operated, use the stopper to fix the product in place, and lock the casters.

Looking down at the stopper from above, turning the stopper to the left (counterclockwise) raises the stopper, and turning the stopper to the right (clockwise) lowers the stopper.

Lowering the lock lever on a caster locks the caster, and raising the lock lever unlocks the caster.

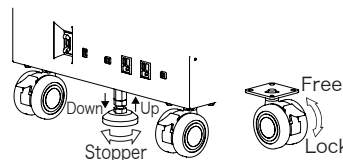

### Precautions when moving the PCR12000LE2/ PCR18000LE2/ PCR27000LE2

The PCR12000LE2/ PCR18000LE2/ PCR27000LE2 cannot be moved after it has been installed. If you need to move it, contact your Kikusui agent or distributor.

## Handling the Terminal Block Tray (PCR600LE2/ PCR9000LE2)

The PCR-LE2 Series AC INPUT, OUTPUT terminal block, SENSING terminal block, and J1 to J4 connectors are designed so that they can only be wired after you first pull out the terminal block tray. The terminal box covers ensure that you don't touch the unwired terminals. Use a Phillips-head screwdriver to insert and remove the screws.

**1** Check that the **POWER** switch is turned off.

**2** Loosen the six terminal box cover screws, and then slide the three covers up.

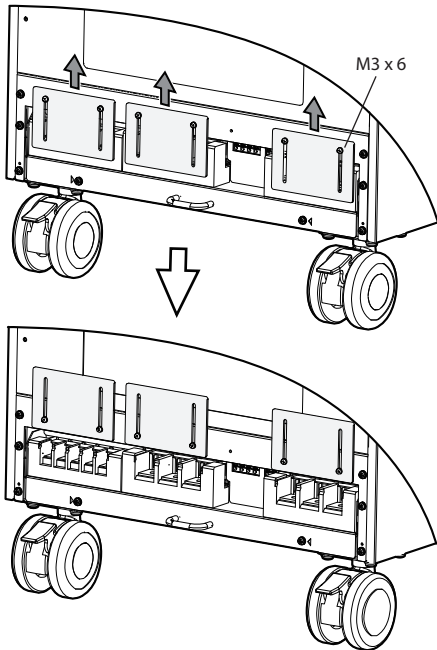

**3** Remove the two terminal block tray screws, and then pull the tray out.

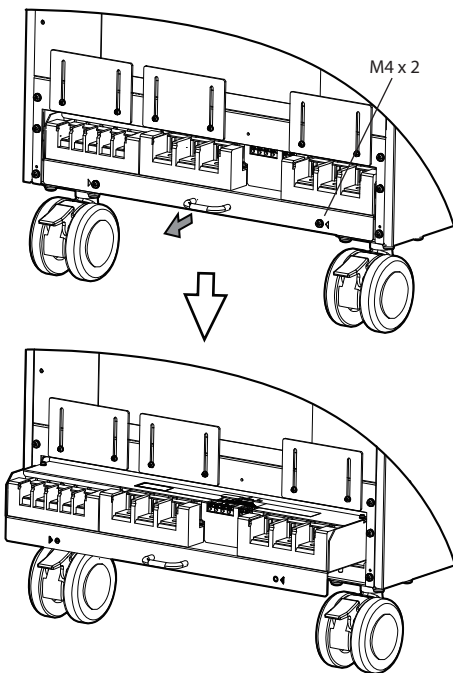

**4** Pull out the stopper to lock the terminal block tray in place.

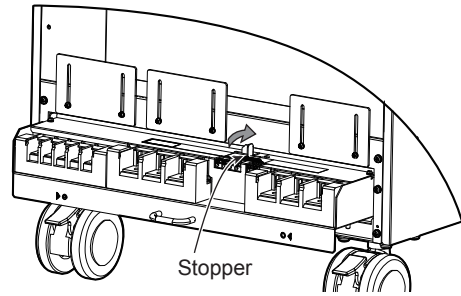

**5** Connect the wires and cables to the terminal block and connectors as necessary.

**6** Return the stopper to its previous position.

**7** Return the terminal block tray to its previous position, and then attach the two screws that you removed in step 3

If you do not insert the terminal block tray all the way into its storage compartment, an electric current will not flow through the PCR-LE2 even if the POWER switch is turned on.

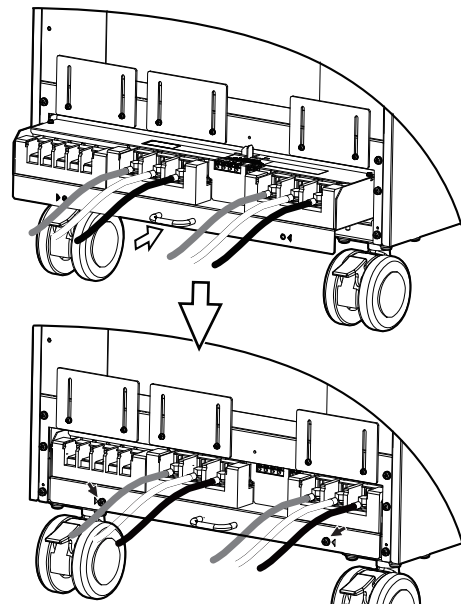

**8** Slide the two terminal box covers down until they are touching the wires, and then use the four screws to fix the terminal box covers in place. Slide the terminal box cover all the way down if none of their terminals have wires connected to them, and use the two screws to fix the covers in place.

The figure below is an example for when the OUTPUT terminal blocks for single-phase output are in use.

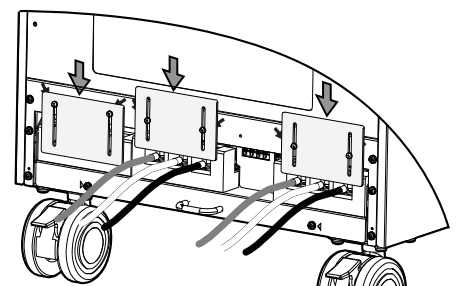

# Connecting the power cord

This product conforms to IEC Overvoltage Category II (energy-consuming equipment that is supplied from a fixed installation).

## ⚠ WARNING

Risk of electric shock.

- This product conforms to IEC Safety Class I (equipment that has a protective conductor terminal). Be sure to earth ground the product to prevent electric shock.
- Connect the protective conductor terminal to earth ground.
- Turn off the circuit breaker of the switchboard before you connect the power cord.
- Do not use the product with the terminal box covers removed.

Risk of electric shock or fire.

- For the connected switchboard, select a breaker that has a cut-off current that can handle the maximum input current of the product
- Have a qualified engineer connect the power cord to the switchboard.

## ⚠ CAUTION

If the voltage distortion of the AC power line is large, the product may malfunction. The PCR-LE2 Series cannot be connected to a generator or a similar device.

Inside the product, protective circuits such as input fuses are connected to match the polarity of the input terminal. Be sure to match the colors of the wires and the input terminals to connect the wires correctly.

Single-phase, 200 V input (PCR6000LE2 only):

L, N, and  $\oplus$  (GND)

Three-phase, 200 V input: R, S, T, and  $\oplus$  (GND)

Three-phase, 400 V input: R, S, T, N, and  $\oplus$  (GND)

### - Note -

The POWER switch can be used to disconnect the product from the AC power line in an emergency (On the PCR27000LE2, the MASTER POWER switch and the two SLAVE POWER switches must be turned off.). Provide enough space around the POWER switch to ensure that it can be turned off at any time.

A power cord is not supplied with the PCR-LE2 Series.

Input power cords are available as options. When you are wiring the switchboard, attach crimping terminals that match the screws of the switchboard that has been connected by a qualified engineer.

If you will not use one of the optional input power cords, prepare a power cord that meets the following specifications.

	Cable	Nominal cross-sectional area	Input terminal
Single-phase, 200 V input	PCR6000LE2 Three single-core cables	14 mm <sup>2</sup> or more	M8
Three-phase, 200 V input	PCR6000LE2	8 mm <sup>2</sup> or more	M5
	PCR9000LE2	14 mm <sup>2</sup> or more	M5
	PCR12000LE2	22 mm <sup>2</sup> or more	M8
	PCR18000LE2	38 mm <sup>2</sup> or more	M8
	PCR27000LE2	60 mm <sup>2</sup> or more	M8
Three-phase, 400 V input	PCR6000LE2	5.5 mm <sup>2</sup> or more	M5
	PCR9000LE2	5.5 mm <sup>2</sup> or more	M5
	PCR12000LE2	8 mm <sup>2</sup> or more	M8
	PCR18000LE2	14 mm <sup>2</sup> or more	M8
	PCR27000LE2	38 mm <sup>2</sup> or more	M8

## Connecting power cords to the PCR6000LE2 or PCR9000LE2

### 1 Check that the AC power line meets the nominal input rating of the product.

The product can receive a nominal power supply voltage:  
 Single-phase, 200 V input (PCR6000LE2 only):  
 200 Vac to 240 Vac  
 Three-phase 200 V input: 200 Vac to 240 Vac (Line Voltage)  
 Three-phase, 400 V input: 220 Vac to 240 Vac (Phase Voltage)  
 Frequency: 50 Hz or 60 Hz.

### 2 Check that the POWER switch is turned off.

### 3 Pull out the terminal block tray.

### 4 Securely connect the power codes to corresponding terminals of AC INPUT terminal block.

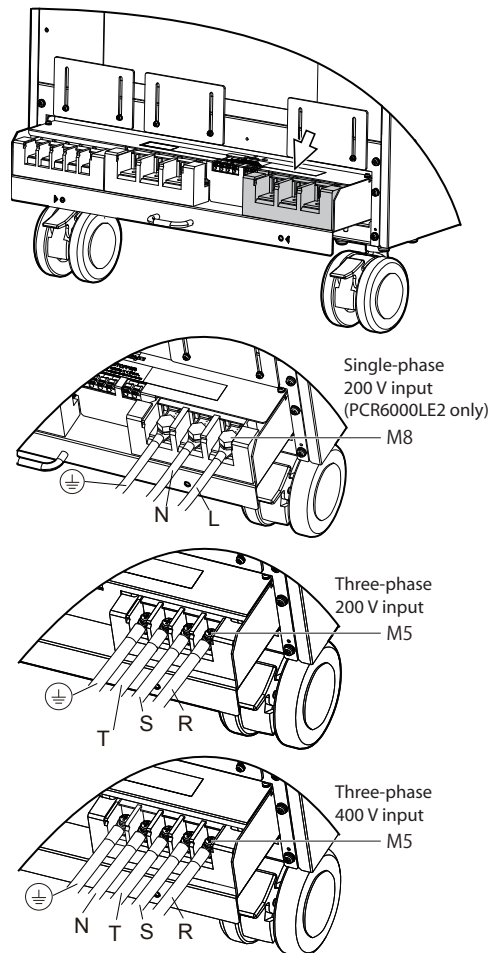

### 5 Turn off the switchboard's breaker.

### 6 Securely connect the power codes to corresponding terminals of switchboard's breaker.

### 7 Return the terminal block tray to its previous position.

If you do not insert the terminal block tray all the way into its storage compartment, an electric current will not flow through the PCR-LE2 Series even if the POWER switch is turned on.

### 8 Turn on the switchboard's breaker.



## Connecting power cords to the PCR1200LE2, PCR1800LE2, or PCR2700LE2

### 1 Check that the AC power line meets the nominal input rating of the product.

The product can receive a nominal power supply voltage:  
Three-phase 200 V input: 200 Vac to 240 Vac (Line Voltage)  
Three-phase, 400 V input: 220 Vac to 240 Vac (Phase Voltage)  
Frequency: 50 Hz or 60 Hz.

### 2 Check that the POWER switch is turned off.

### 3 Unfasten the screws (two locations) of the AC INPUT terminal block cover, and remove the cover.

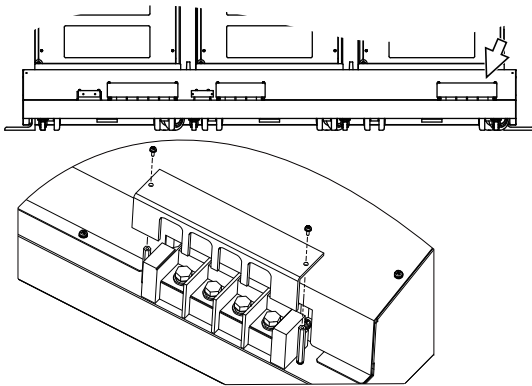

### 4 Connect the power cords according to the indications on the terminal block.

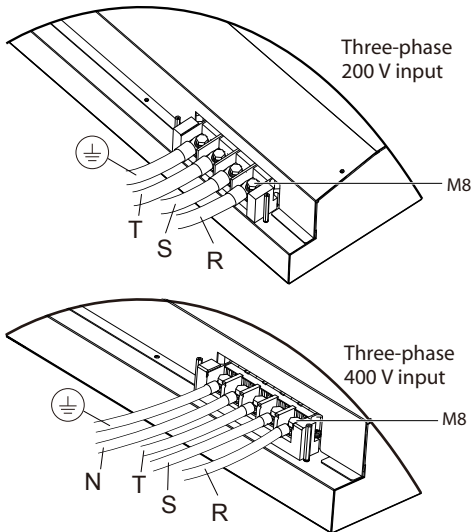

### 5 Turn off the switchboard's breaker.

### 6 Securely connect the power codes to corresponding terminals of switchboard's breaker.

### 7 Fasten the cover that you removed in step 3 with the screws (two locations).

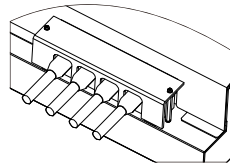

### 8 Turn on the switchboard's breaker.

# Turning the Power On

## Turning the POWER switch on

Turn the power on without the load connected.

If the POWER switch is turned on for the first time after purchasing the PCR-LE2 Series, the PCR-LE2 Series starts up using factory default settings. For all other cases, the PCR-LE2 starts up using the settings that were in use the last time that the POWER switch was turned off.

You can set the output on/off state at power on. For details, see "User's Manual -Basic-" on the accompanying CD-ROM.

If "ALARM" or an error number is displayed, see "Alarms and Trouble" on the accompanying CD-ROM.

### ■ Turning on the POWER switch on the PCR600LE2 or PCR900LE2.

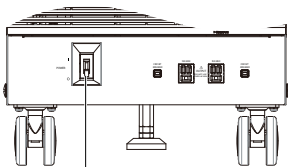

POWER switch

- 1 Check that nothing is connected to the OUTPUT terminal block on the rear panel and the outlets on the front panel.
- 2 Check that the power cord is connected correctly.
- 3 Flip the POWER switch to the ( | ) side to turn the PCR-LE2 Series on.

The firmware version is displayed for a few seconds. If no errors are detected, the home position (the basic screen) appears.

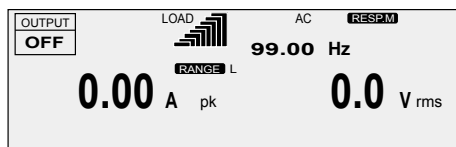

### ■ Turning on the POWER switch on the PCR12000LE2, PCR18000LE2, or 27000LE2

The PCR-LE2 series has a MASTER POWER switch and SLAVE POWER switches. You can turn off a SLAVE POWER switch to disconnect the product from the AC power line in an emergency. Normally, leave the SLAVE POWER switches turned on at all times, and use the MASTER POWER switch to turn on the product.

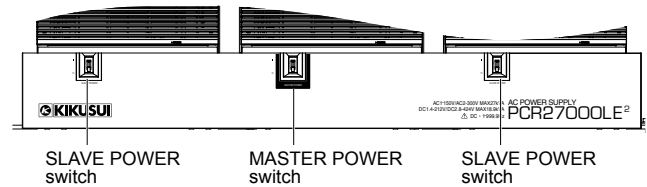

- 1 Check that nothing is connected to the OUTPUT terminal block on the rear panel and the outlets on the front panel.
- 2 Check that the power cord is connected correctly.
- 3 Check that the two SLAVE POWER switches are flipped to the ( | ) side.  
If not, flip them to the ( | ) side.
- 4 Flip the MASTER POWER switch to the ( | ) side to turn the PCR-LE2 Series on.

The firmware version is displayed for a few seconds. If no errors are detected, the home position (the basic screen) appears.

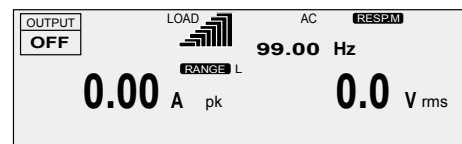

## Turning the POWER switch off

- PCR6000LE2, PCR9000LE2  
Flip the POWER switch to the ( ○ ) side to turn the PCR-LE2 Series off.
- PCR12000LE2, PCR18000LE2, PCR27000LE2  
Flip the MASTER POWER switch to the ( ○ ) side to turn the PCR-LE2 Series off.

When the POWER switch is turned on, all items except for the following items take on the values that were in use the last time that the POWER switch was turned off.

Waveform bank contents from number 24 to number 63

Output on/off state

If the POWER switch is turned off immediately after the settings have been changed, the last settings may not be stored.



### CAUTION

Risk of malfunction. After turning the POWER switch off, wait at least 5 seconds before turning it back on.

### ■ Turning off the POWER switch in an emergency

- PCR6000LE2, PCR9000LE2  
Turning off the POWER switch disconnects the product from the AC power line.
- PCR12000LE2, PCR18000LE2, PCR27000LE2  
Turning off the MASTER POWER switch and the two SLAVE POWER switches disconnects the product from the AC power line.

Provide enough space around the POWER switches to ensure that them can be turned off at any time.

## Connecting the Load

The maximum current that the PCR-LE2 Series can generate varies depending on the model. It also varies depending on the PCR-LE2 Series' voltage mode, load type, and status. Ensure that the output power capacity is sufficient for the load capacity. The maximum output currents (in AC mode—AC rms, with an output voltage of 1 V to 100 V or 2 V to 200 V, and with a load power factor of 0.8 to 1) for the different models are shown in the table.

Model	Maximum output current			
	Single-phase output		Single-phase three-wire output Three-phase output	
	L range	H range	L range	H range
PCR6000LE2	60 A	30 A	20 A	10 A
PCR9000LE2	90 A	45 A	30 A	15 A
PCR12000LE2	120 A	60 A	40 A	20 A
PCR18000LE2	180 A	90 A	60 A	30 A
PCR27000LE2	270 A	135 A	90 A	45 A

### - DESCRIPTION -

When the POWER switch is on, even if the output is off, a dangerous voltage exists between the output terminal (L/N or U/V/W/N) and the chassis (G-ground). To eliminate the voltage between the output terminal and the chassis, connect N and G of the OUTPUT terminal block.

## Connecting to the OUTPUT terminal block

We recommend that you run the load wires alongside each other and tie them together at several points with cable ties. Connect between the output terminal and load with the shortest wires possible.

### ■ Preparing wires

Use noncombustible wires that have diameters that correspond to the output current to connect to the load.

### Requirements of single-core wires that are used to connect to the load

Nominal cross-sectional area[mm <sup>2</sup> ]	AWG	(reference cross-sectional area; mm <sup>2</sup> )	Allowable current* (A; at Ta = 30 °C, 86 °F)
0.9	18	(0.82)	17
1.25	16	(1.31)	19
2	14	(2.08)	27
3.5	12	(3.31)	37
5.5	10	(5.26)	49
8	8	(8.37)	61
14	6	(13.3)	88
22	4	(21.15)	115
38	1	(42.41)	162
60	2/0	(67.42)	217
80	3/0	(85.03)	257
100	4/0	(107.2)	298

\* Excerpt from Japanese laws related to electrical equipment.

The values vary depending on conditions such as the wire covering (insulator), the wire material (allowable temperature), and whether there are multiple cores in the cable. For cables other than those specified in this table, consult with a qualified engineer.

### WARNING

**Risk of electric shock. Before you connect cables to the OUTPUT terminal block, be sure to turn the POWER switch off, and then turn off the switchboard.**

### - Note -

The L and N terminals of the OUTPUT terminal block are isolated from the input power supply. The polarity does not constitute a problem in terms of safety. The polarity matters in synchro mode (in which the product is synchronized with the input power supply) and DC mode, so check the polarity of the load before you connect it to the product. You can use either L or N to ground the product.

In DC mode and AC+DC mode, N is the reference. When N has a positive polarity, L is positive electric potential. When N has a negative polarity, L is negative electric potential.

### Screw diameter of OUTPUT terminals

- PCR6000LE2, PCR9000LE2  
Single-phase output: M8  
Single-phase three-wire output, Three-phase output: M5
- PCR12000LE2, PCR18000LE2, PCR27000LE2  
M8

## Connecting cables to the PCR600LE2 or PCR9000LE2

### ■ Single-phase output

- 1** Check that the POWER switch is turned off.
- 2** Check that the breaker of the switchboard is off.
- 3** Pull out the terminal block tray.
- 4** **Securely connect the load cables to the OUTPUT 1P2W terminal block.**  
If the load has a ground (GND) terminal, be sure to connect it to the G terminal of the PCR-LE2 Series OUTPUT 1P2W terminal block. Be sure to use a wire whose diameter is greater than or equal to the diameter of the wires used to connect the load.

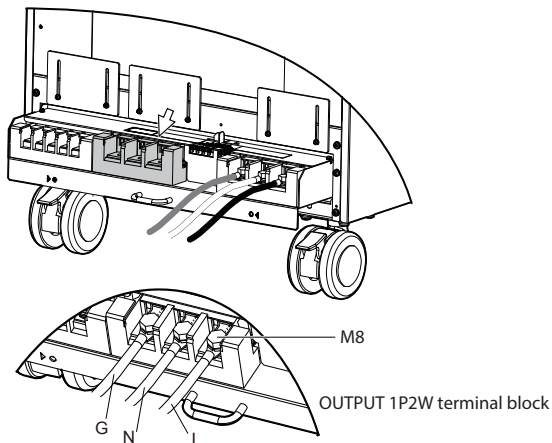

- 5** **Return the terminal block tray to its previous position.**  
If you do not insert the terminal block tray all the way into its storage compartment, an electric current will not flow through the PCR-LE2 Series even if the POWER switch is turned on.

### ■ Single-phase three-wire output or three-phase output

- 1** Check that the POWER switch is turned off.
- 2** Check that the breaker of the switchboard is off.
- 3** Pull out the terminal block tray.
- 4** **Securely connect the load cables to the OUTPUT 3P4W(1P3W) terminal block.**  
If the load has a ground (GND) terminal, be sure to connect it to the G terminal of the PCR-LE2 Series OUTPUT 3P4W(1P3W) terminal block. Be sure to use a wire whose diameter is greater than or equal to the diameter of the wires used to connect the load.

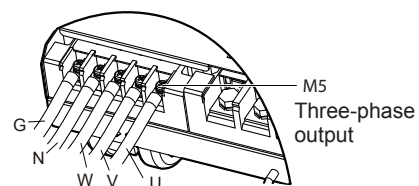
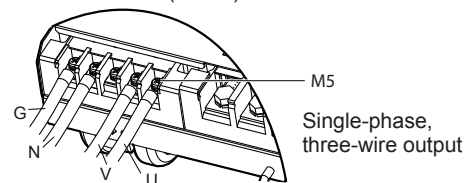
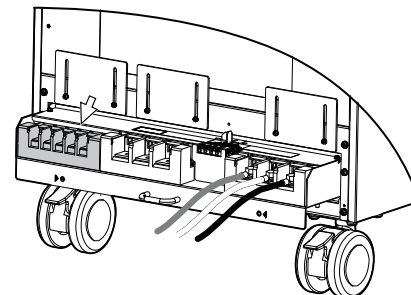

- 5** **Return the terminal block tray to its previous position.**  
If you do not insert the terminal block tray all the way into its storage compartment, an electric current will not flow through the PCR-LE2 Series even if the POWER switch is turned on.

## Connecting the Load (Cont.)

### Connecting wires to the PCR1200LE2, PCR1800LE2, or PCR2700LE2

#### ■ Handling the output terminal cover

When shipped from the factory, the terminal cover is attached using the left holes so that the OUTPUT terminals are not exposed.

If you are not using the OUTPUT terminal block, attach the terminal cover as figure below.

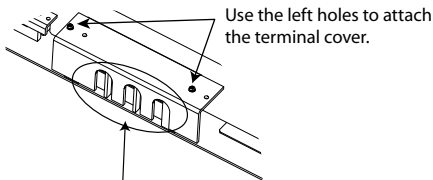

When the terminal cover is attached using the left holes, the output terminals are not exposed

When the load cable you use is 38 mm<sup>2</sup> (AWG1) or more, use the right holes to attach the terminal cover.

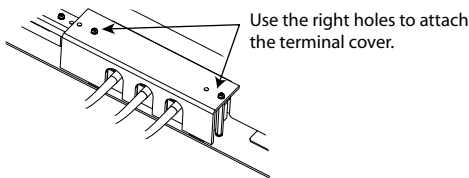

When the load cable you use is 60 mm<sup>2</sup> (AWG0/2) or less, flip the terminal cover upside down and attach it.

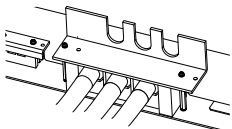

#### ■ Single-phase output

- 1 Check that the **POWER switch is turned off.**
- 2 Check that the **breaker of the switchboard is off.**
- 3 Unfasten the screws (two locations) of the **OUTPUT 1P2W terminal block cover**, and remove the cover.

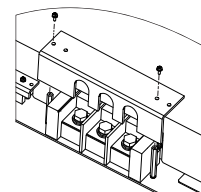
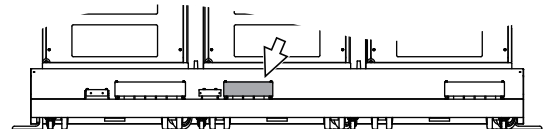

OUTPUT 1P2W terminal block

- 4 **Securely connect the load cables to the OUTPUT 1P2W terminal block.**

If the load has a ground (GND) terminal, be sure to connect it to the G terminal of the PCR2700LE2 OUTPUT 1P2W terminal block. Be sure to use a wire whose diameter is greater than or equal to the diameter of the wires used to connect the load.

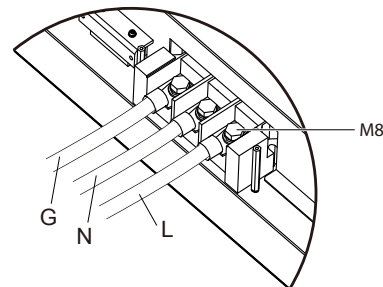

- 5 **Fasten the cover that you removed in step 3 with the screws (two locations).**

## ■ Single-phase three-wire output or three-phase output

**1** Check that the POWER switch is turned off.

**2** Check that the breaker of the switchboard is off.

**3** Unfasten the screws (two locations) of the OUTPUT 3P4W(1P3W) terminal block cover, and remove the cover.

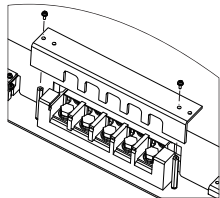
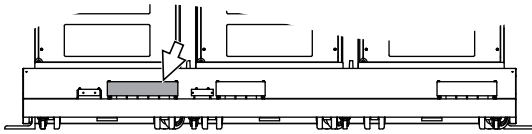

OUTPUT 3P4W(1P3W) terminal block

**4** Securely connect the load cables to the OUTPUT 3P4W(1P3W) terminal block.

If the load has a ground (GND) terminal, be sure to connect it to the G terminal of the PCR27000LE2 OUTPUT 3P4W(1P3W) terminal block. Be sure to use a wire whose diameter is greater than or equal to the diameter of the wires used to connect the load.

Single-phase three-wire output

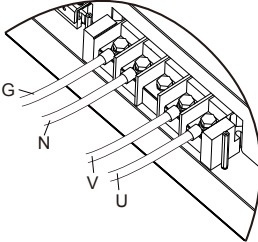

Three-phase output

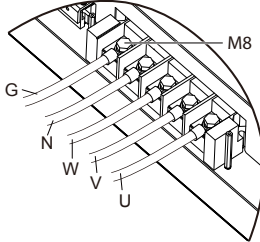

**5** Fasten the cover that you removed in step 3 with the screws (two locations).

## When the load is located at a remote location

Remote control can be used to turn the output off, but it cannot be used to turn the POWER switch off. If you want to connect the PCR-LE2 Series to a load that is located at a remote location, install a switch between the OUTPUT terminal block and the load to prevent electric shock. Then, turn that switch off.

### ⚠ WARNING

Risk of electric shock.

- Before you install the switch between the OUTPUT terminal block and the load, be sure to turn the POWER switch off and turn off the breaker of the switchboard.
- The current rating of the switch must be greater than or equal to the maximum current of the PCR-LE2 Series.
- For the switch circuit, use a multi-pole switch that can cut off all lines simultaneously (two poles for single-phase output, three poles for single-phase three-phase output, and four poles for three-phase output).
- Be sure to turn the switch off before connecting the load to the terminal at the load end of the switch.
- Do not touch the switch terminals when the POWER switch is on. Before you connect cables to the OUTPUT terminal block, be sure to turn the POWER switch off, and then turn off the switchboard.

Before you connect the cables, be sure to turn the POWER switch off and turn off the breaker of the switchboard.

OUTPUT terminal block

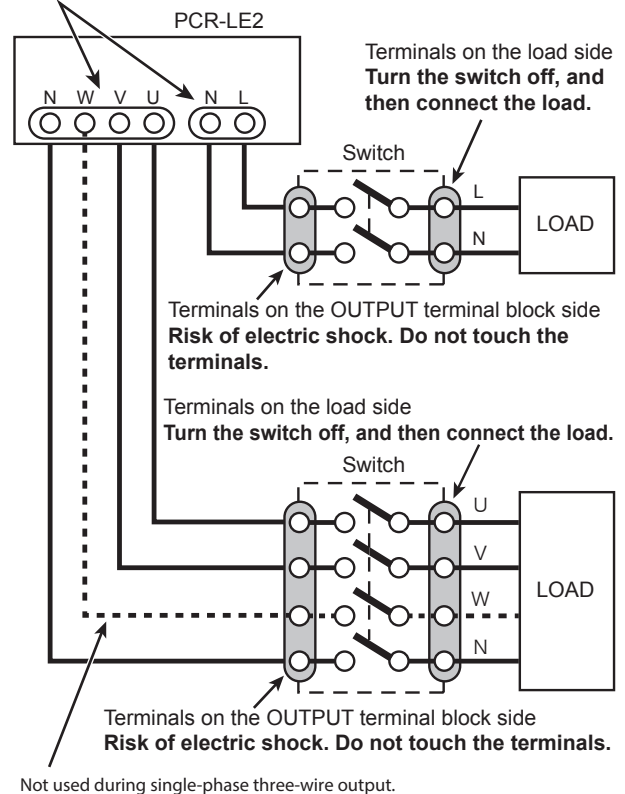

## Connecting to the front-panel outlets (PCR6000LE2/ PCR9000LE2 only)

The PCR-LE2 Series can generate power from the OUTPUT terminal block on the rear panel and the outlets on the front panel.

The outlets on the front panel are valid for single-phase output. Electric current does not flow through the outlets during single-phase three-wire output or three-phase output.

The specifications of the front-panel outlets are not regulated. Their performance may decrease.

### CAUTION

The maximum rated voltage of the front-panel outlets is 250 Vac.

Max. output voltage: 250 Vac(rms)

Maximum output current: 10 Aac (rms) per outlet

Do not disconnect the load when the maximum rated voltage of the outlets has been exceeded or in DC mode. Doing so may cause the product to malfunction.

On the PCR-LE2 Series, if an overcurrent is detected, the breaker trips, and the output is cut off.

The outlets are designed for power plugs like those shown below.

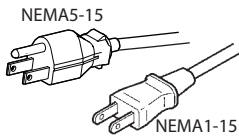

- 1** Turn the POWER switch off.
- 2** Connect the power cord of the load device to a front-panel outlet.



This chapter explains the basic operating procedures of the PCR-LE2 Series.

## Front Panel

### PCR-LE6000LE2/ PCR9000LE2 (example of the PCR6000LE2)

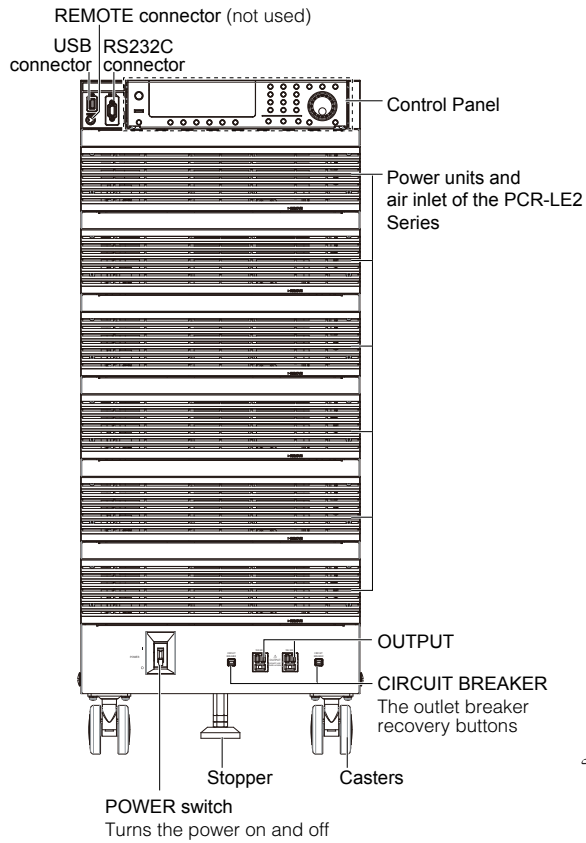

### PCR12000LE2/ PCR18000LE2/ 27000LE2 (example of the PCR27000LE2)

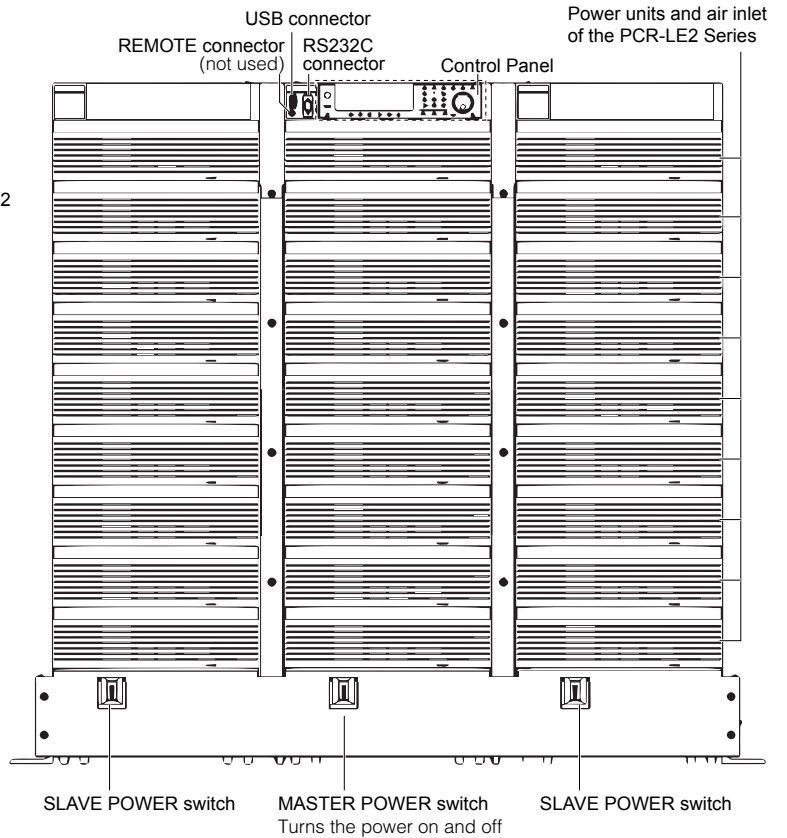

# Front Panel (Cont.)

## Control Panel

### Numeric keypad/ Setting key

- Numeric keypad Enter numeric values directly
- CLR key Clear the numeric keypad input.
- ON PHASE key Set the output on phase
- RANGE key Switch between output voltage ranges
- SYNC key Enable the synchronization function
- OFF PHASE key Set the output off phase
- KEYLOCK key Lock and unlock the keys
- RESET key Reset the product
- SLEEP key Configure the sleep mode settings
- LOCAL key Switch between remote mode and local mode
- +/- key Switch the polarity (+ or -) of the voltage in DC mode
- DIGIT key The cursor moves to the left (the higher-order digit) each time this key is pressed
- ALM CLR key Clear alarms.

- I key**  
Configure the current settings
- I/P/S/A-MEAS key**  
Switch the current/power measurement mode

- F key**  
Set the frequency
- PHASE key**  
Switch between different displays during multiphase operation
- V key**  
Configure the voltage settings
- V-MEAS key**  
Switch the voltage measurement mode

**OUTPUT key**  
Turn output on and off

**Display**

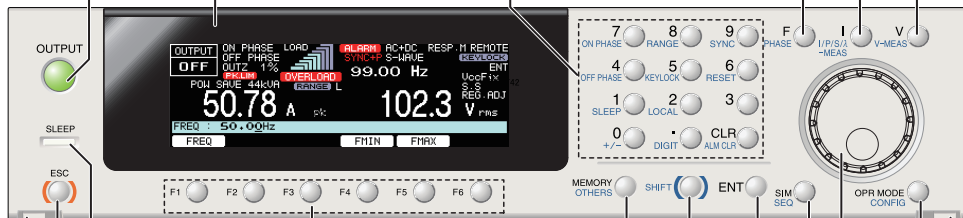

**SLEEP LED**

**Function keys**

**ESC key**  
return to the previous level's operation and to cancel operations

**Detachment button**  
Detach the control panel (There are two)

**MEMORY key**  
Save settings to and load settings from memory

**OTHERS key**  
Configure advanced operation settings

**SHIFT key**  
Enable the functions that are indicated in blue characters in the bottom row to the left of each key

**ENT key**  
apply settings

**Detachment button**

**OPR MODE key**  
Configure the operation environment settings

**CONFIG key**  
Specify the configuration settings

**Rotary knob**

**SIM key**  
Configure power line abnormality simulations

**SEQ key**  
Configure sequence operations

# Rear Panel

## PCR6000LE2/ PCR9000LE2 (example of the PCR6000LE2)

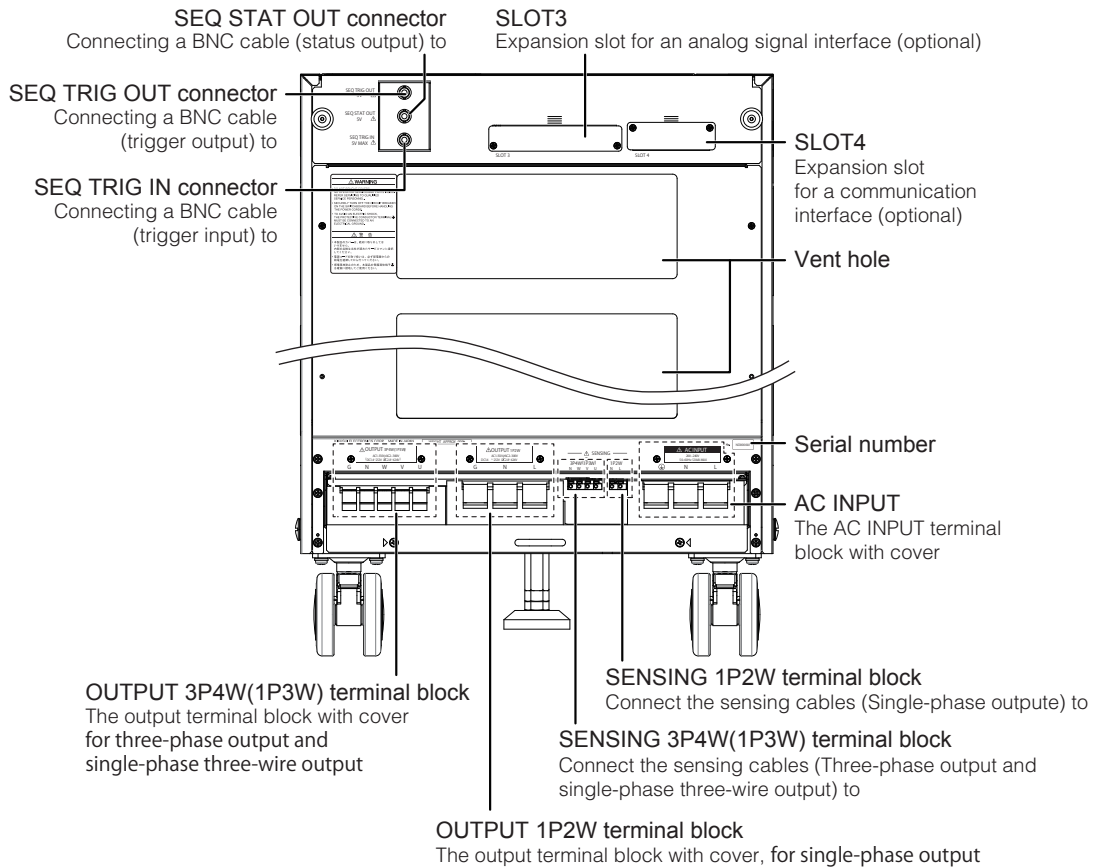

## PCR12000LE2/ PCR18000LE2/ PCR27000LE2 (example of the PCR27000LE2)

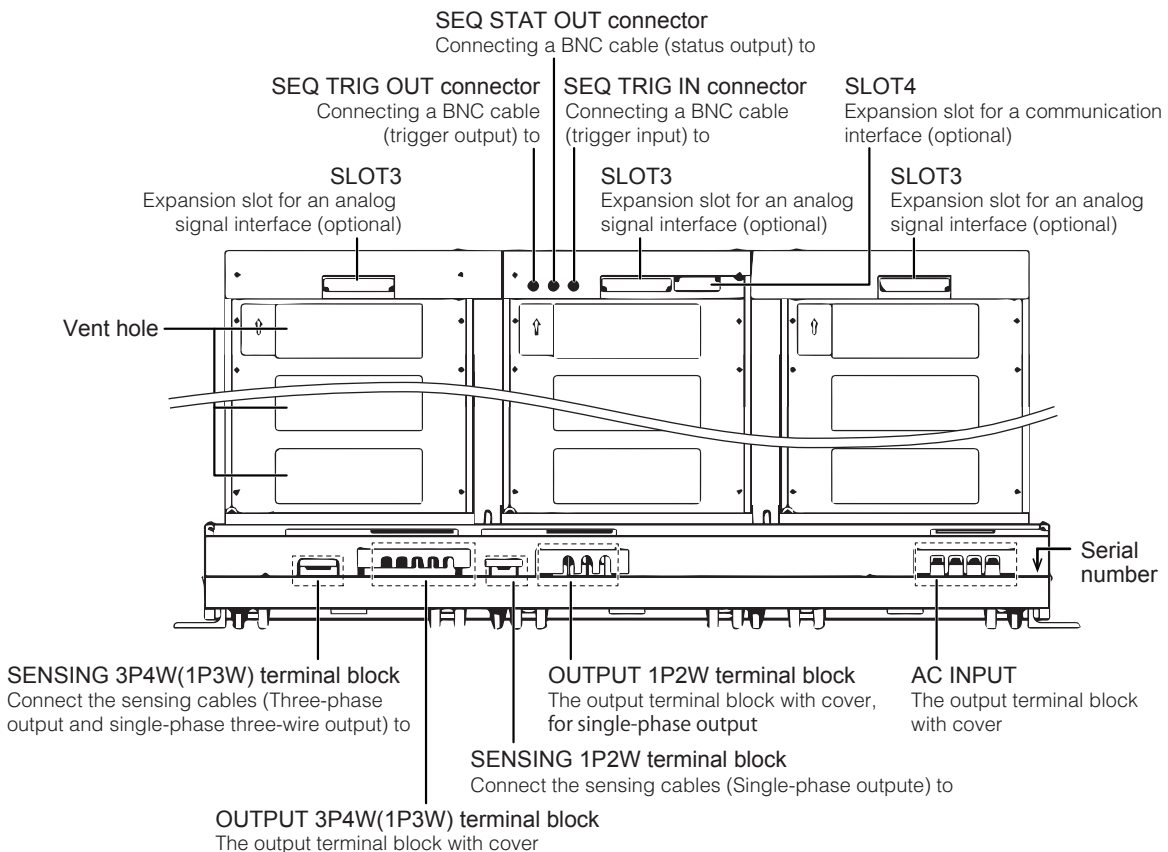

# Panel Operation Basics

This section explains the status indicators of the product and the basics of operating the product from the front panel.

## Control panel

You can pull out the control panel and tilt it to one of the two available settings.

If you use the optional EC05-PCR extension cable, you can use the control panel while it is detached from the PCR-LE2 Series.

### ■ Detaching the control panel

Hold down the two control panel detachment buttons, and pull the control panel toward you.

The control panel will come free of the PCR-LE2 Series. The control panel and the PCR-LE2 Series are connected by a cable. Do not pull hard on the control panel.

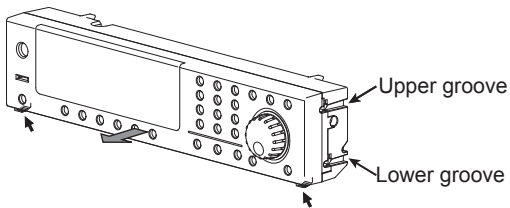

While pressing in the two locations (indicated by this arrow in the figure), detach the panel by pulling it toward you.

### ■ Attaching the control panel

The control panel detachment buttons are not used when you attach the control panel to the PCR-LE2 Series. Simply press on the control panel until you hear a click.

#### • Factory default

Align the upper groove and the lower groove on the control panel with the upper pin and lower pin on the PCR-LE2 Series, respectively, and then push the control panel back into the PCR-LE2 Series.

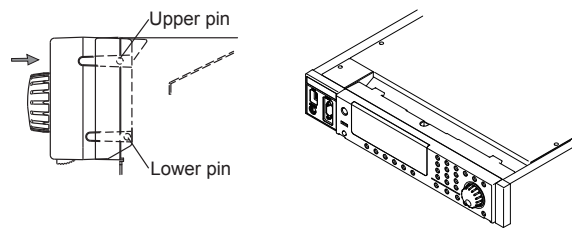

#### • Tilt slightly

Align the upper groove on the control panel with the upper pin on the PCR-LE2 Series, and then push the control panel back into the PCR-LE2 Series until the protruding part of the control panel lines up with the slanted surface of the PCR-LE2 Series.

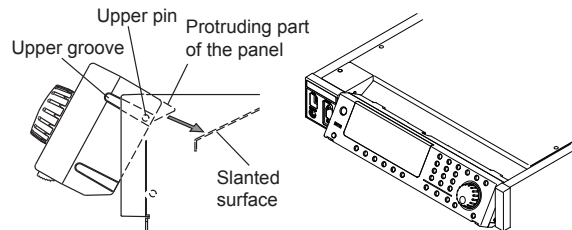

#### • Make it easily viewable from above.

Align the lower groove on the control panel with the upper pin on the PCR-LE2 Series, and then push the control panel back into the PCR-LE2 Series until the protruding part of the control panel sits on the slanted surface of the PCR-LE2 Series.

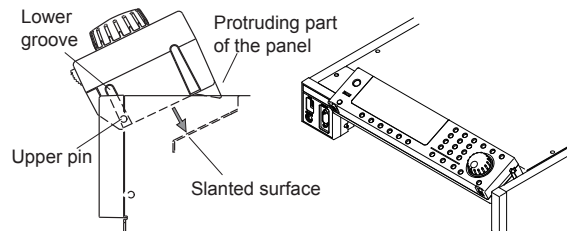

## Parts of the screen

The screen consists of the following three parts.

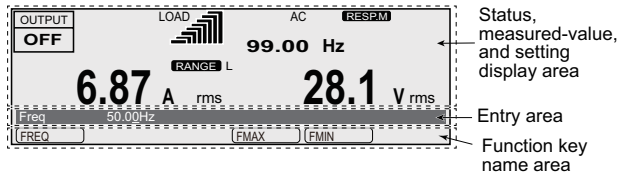

### ■ Status, measured-value, and setting display area

This displays the product's present status, measured values, and settings.

### ■ Entry area

Settings and system settings are entered in this area.

This area displays a title and its corresponding setting.

If an alarm or trouble occurs, the alarm code or the trouble code is displayed here.

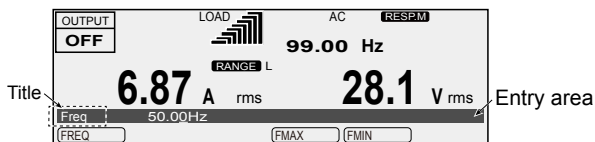

### ■ Function key name area

The present functions are displayed above the function keys (F1 to F6). The displayed contents vary depending on the selected output voltage mode.

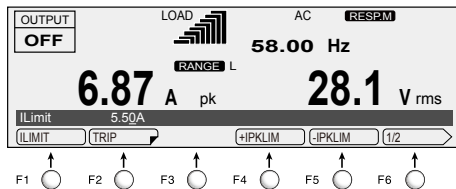

	This indicates that you can set the displayed item by pressing the function key.
	This indicates that there is a sub level in the function menu hierarchy.
	This indicates that there is another page in the function menu. The function key name indicates the following: "present page/total number of pages." The PCR-LE2 Series switches between the pages each time that you press this function key.

## Explanation of function keys in this manual

The function keys in this manual are explained in a tabular form as shown below.

Item	Title	Description	Conditions in which the function key cannot be used	Valid modes
The item name that is displayed in the function key name area	The title that is displayed in the entry area	An explanation of the function key	When the PCR-LE2 Series is being used under the conditions listed here, the contents that are listed for the item cannot be selected.	This indicates the PCR-LE2 Series modes during which the function key is valid. If the valid modes are not listed, the function key is valid in all modes.

## Home position

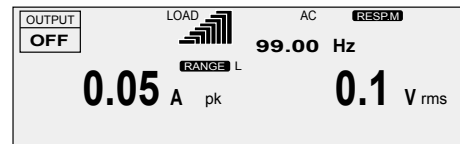

The screen that is displayed that you turn the POWER switch on is called the "home position" (the basic screen). The home position is the top level in the menu hierarchy. All functions are arranged within the menu hierarchy. The home position screen varies depending on the output mode. The figure above is an example for the single-phase output mode.

No matter which function you are using, if you repeatedly press ESC, you will move back up through the menu hierarchy towards the home position.

## Canceling settings

Press ESC to return to the previous screen.

If you want to cancel settings that you have made, repeatedly press ESC until you return to the home position. If you press ESC at the home position, a buzzer will sound.

## ENT wait

The PCR-LE2 Series has an "ENT wait" state during which you can confirm the operation results (the ENT indicator blinks). The ENT wait state continues until the ENT key is pressed. Press ENT to apply the settings.

Press ESC to cancel the settings.

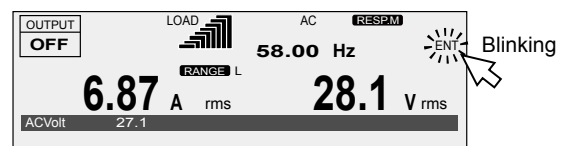

## Restoring to factory default settings

You can return all the settings to their factory defaults or return just a portion of the settings to their factory defaults. For details, see Appendix.A Restoring to factory default settings.

# Panel Operation Basics (Cont.)

## Switching from remote mode to local mode

When the PCR-LE2 Series is in remote mode, "RMT" is displayed on the screen. To switch the PCR-LE2 Series to local mode from the panel, press LOCAL (SHIFT+2).

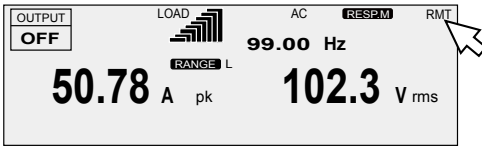

## Displaying single-phase, three-wire output and three-phase output

With an unbalanced configuration, the unbalance icon is displayed.

Output	Voltage of each phase	Phase differences		Display
		U and V	U and W	
Single-phase	Same	Other than 180°	--	UNBAL.PHAS
	Different	180°	--	UNBAL.VOLT
three-wire	Different	Other than 180°	--	UNBAL.PHAS, VOLT
	Same	Other than 120°	Other than 240°	UNBAL.PHAS*1
Three-phase	Different	120°	240°	UNBAL.VOLT
	Different	Other than 120°	Other than 240°	UNBAL.PHAS, VOLT*1

\*1. If either the "U and V" or "U and W" condition applies, the configuration is considered unbalanced.

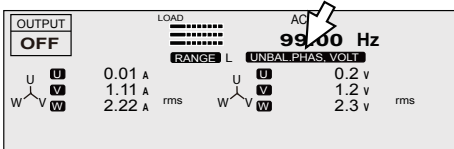

Only one phase can be displayed. Select the phase that you want to display using the PHASE (SHIFT+F) key.

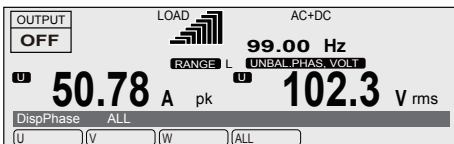

Item	Title	Description
U	DispPhase	The U phase is displayed. The line voltage is the voltage between U and V.
V		The V phase is displayed. The line voltage is the voltage between V and W.
W*1		The W phase is displayed. The line voltage is the voltage between W and U.
ALL		All phases are displayed.

\*1. Three-phase output only

You can display the line voltage. -> p32

- Note -

### Phase voltage and line voltage

In three-phase AC output, when the phase difference between U, V, and W is 120° and the output voltages are equal,

$$\text{Line Voltage} = \sqrt{3} \times \text{Phase voltage} \quad \text{Phase voltage} = \text{Line voltage} / \sqrt{3}$$

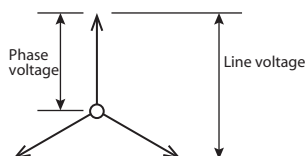

## Specifying values

To specify values, use the numeric keypad or the rotary knob. When the cursor is displayed in the entry area, you can use the numeric keypad or the rotary knob to specify a value.

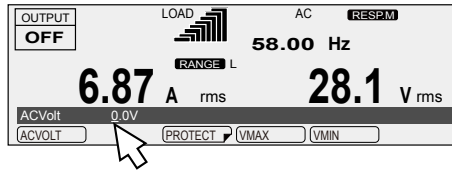

### Numeric keypad operations

If you use the numeric keypad to enter a value, the value that you entered is displayed in the entry area.

To enter a negative value, first press +/- (SHIFT+0).

Press CLR to clear any settings that you have made before pressing ENT.

Press ENT to apply the values that you have specified. If you press ESC before you press ENT, any settings that you have made will be canceled.

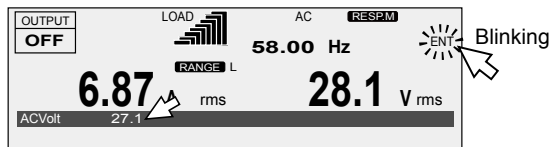

## Rotary knob operations

Turn the rotary knob to the right to increase the displayed value. Turn the rotary knob to the left to decrease the displayed value. You do not need to press ENT.

### CAUTION

A voltage or frequency that is greater than is necessary may cause damage to the load or put the operator in danger. Be sure to set the voltage and frequency limits. For details, see "Setting Limits".

## Digit function

The digit function enables you to use the rotary knob to change only the specified digit and the higher digits when you are setting the voltage or frequency. This function is useful when you are changing the voltage or frequency in steps.

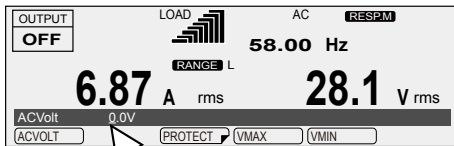

Each time that you press DIGIT (SHIFT+.), the cursor moves.

### 3 Check that the PCR-LE2 Series is in a state in which you can specify a value.

The digit function is valid when the cursor is displayed at a value in the entry area.

### 4 Press DIGIT (SHIFT+.) until the cursor is displayed at the digit that you want to change.

Only the digit that is indicated by the cursor and the higher digits will be changed (except when the value that you are changing reaches the maximum or minimum settable value).

Each time that you press DIGIT (SHIFT+.), the cursor moves to the left. If the cursor is at the highest digit and you press DIGIT (SHIFT+.), the cursor will move to the lowest digit.

### 5 Use the rotary knob to set the value.

The digit function is not valid if you are using the numeric keypad to enter the value.

## Adjusting the screen brightness

You can set the screen brightness to one of three levels (1 to 3). The larger the number, the brighter the screen.

Press CONFIG (SHIFT+OPR MODE) and then DISPLAY (F4) to set the screen brightness.

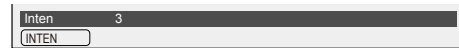
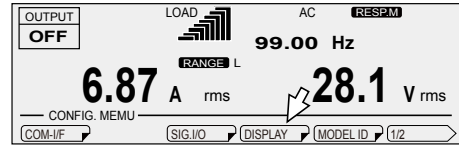

Item	Title	Description
INTEN	Inten	Sets the screen brightness

## Viewing the firmware version

To view the PCR-LE2's firmware version, press CONFIG (SHIFT+OPR MODE) and then MODEL ID (F5).

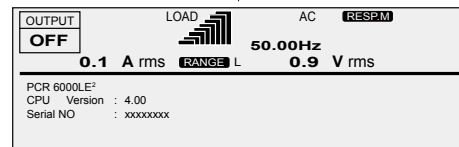
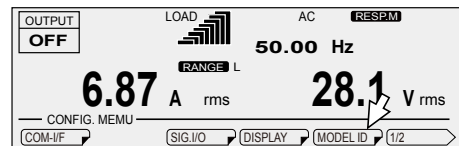

## Locking panel operations (key lock)

You can lock the PCR-LE2's keys to prevent mistaken operations such as changes to the settings and overwriting of memory entries.

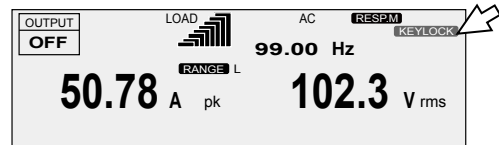

### Locking keys

Press KEYLOCK (SHIFT+5) to lock the panel keys except the OUTPUT key and the KEYLOCK (SHIFT+F5) key. When the keys are locked, "KEYLOCK" is displayed on the screen.

### Unlocking keys

While the keys are locked, press KEYLOCK (SHIFT+5) again to unlock the keys.

# Selecting the Output Mode

Select the output mode (single-phase output, single-phase three-wire output, or three-phase output).

If you select single-phase output, power is output from the OUTPUT 1P2W terminal block.

If you select single-phase three-wire output or three-phase output, power is output from the OUTPUT 3P4W (1P3W) terminal block. During single-phase three-wire output, current will not flow through the W terminal.

The factory default setting is single-phase.

## Switching between single-phase output and three-phase output or between single-phase output and single-phase three-wire output

### 1 Press OPR MODE and then WIRING (F5).

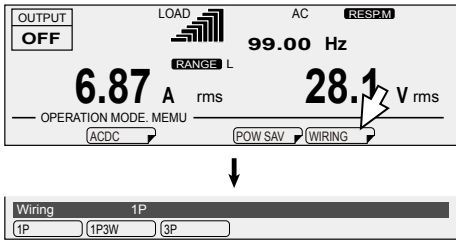

### 2 Select the output mode you want to use.

Item	Title	Description	Condition in which the function key cannot be used
1P	Wiring	Single-phase output Power will be output from the OUTPUT 1P2W terminal block.	Output on
1P3W		Single-phase three-wire output Power will be output from the OUTPUT 3P4W(1P3W) terminal block.	
3P		Three-phase output Power will be output from the OUTPUT 3P4W(1P3W) terminal block.	

### 3 Press ENT.

The output cannot be turned on for a few seconds after the output method is switched (Busy state)  
Some settings will be reset to their factory default values (reset condition; see Appendix, "Factory Default Settings").  
The setting of the power-saving function is changed to the rated output capacity.

If the message "Turn the power back on to validate the setting value" appears,<sup>1</sup> you must turn the POWER switch off and then back on.

\*1. If you change from single-phase three-wire output to single-phase output and then to three-phase output, you must turn the POWER switch off and then back on after you switch from single-phase output to three-phase output. Likewise, if you change from three-phase output to single-phase output and then to single-phase three-wire output, you must turn the POWER switch off and then back on after you switch from single-phase output to single-phase three-wire output.

## Switching between single-phase three-wire output and three-phase output

Single-phase three-wire output and three-phase output use the same OUTPUT terminal block. If you switch between single-phase three-wire output and three-phase output, you must turn the PCR-LE2 series off and then back on.

### 1 Press OPR MODE and then WIRING (F5).

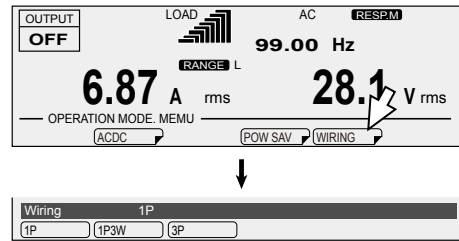

### 2 Select the output mode you want to use.

Item	Title	Description	Condition in which the function key cannot be used
1P3W	Wiring	Single-phase three-wire output	Output on
3P		Three-phase output	

### 3 Press ENT.

The following message appears. To cancel, press CANCEL (F5).

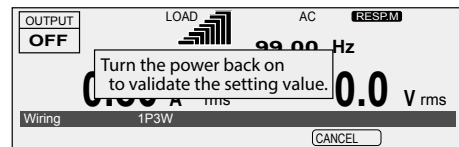

### 4 Turn off the power switch.

### 5 Change the load connection of the OUTPUT 3P4W (1P3W) terminal block.

### 6 Turn on the power switch.

The output mode setting takes effect.



# Setting the Output Voltage

To set the output voltage, set the output voltage mode, the output voltage range, and the output voltage value.

## Setting the output voltage mode

The PCR-LE2 Series has the following output voltage modes: AC, DC, and AC+DC.

You can switch between modes when the output is off.

The AC voltage setting is shared between AC and AC+DC modes.

The DC voltage setting is shared between DC and AC+DC modes.

During three-phase output, only AC mode and AC+DC mode are available.

- AC mode**

AC output is generated. "AC" and the frequency are displayed.

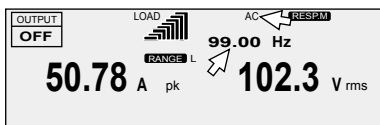

- DC mode**

DC output is generated. "DC" is displayed.

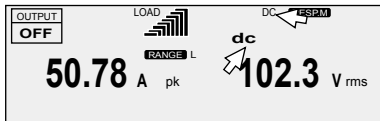

- AC+DC mode**

Voltage waveforms in which AC has been superimposed on DC and voltage waveforms in which DC has been superimposed on AC are generated. "AC+DC" and the frequency of the AC component are displayed.

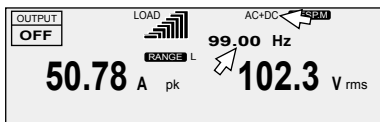

### Output voltage mode setup procedure

Press OPR MODE and then ACDC (F2) to select the output voltage mode. Then, press ENT to confirm the selection.

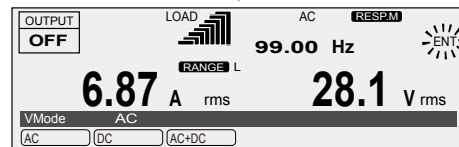
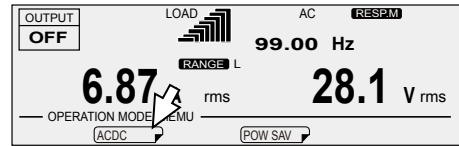

Item	Title	Description	Condition in which the function key cannot be used
AC	VMode	AC mode is selected.	Output on
DC		DC mode is selected.	
AC+DC		AC+DC mode is selected.*1	

\*1. If the output voltage mode is changed from AC or DC to AC+DC and the peak voltage of the resultant AC+DC waveform falls outside the -215.5 V to 215.5 V range (L range) or -431 V to 431 V range (H range), the DC voltage setting is forced to 0 V.

Output mode	Example) Output voltage
Single-phase output Three-phase output	
Three-phase output	U-phase 
	V-phase*1 

\*1. The V phase is automatically set to the same amplitude as the U phase but with opposite polarity.

# Setting the Output Voltage (Cont.)

## Setting the output voltage range

The PCR-LE2 Series has the following output voltage ranges: L and H.

The maximum output current varies depending on the output voltage range. The maximum output current of the H range is half of the maximum output current of the L range.

You can switch between settings when the output is off.

### ■ Output voltage range setup procedure

Press RANGE (SHIFT+8) to select the output voltage range.

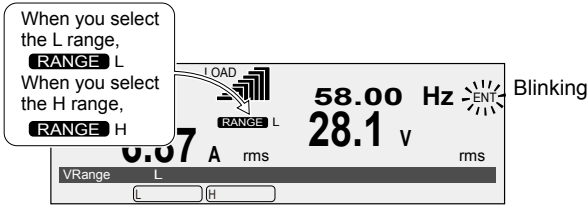

Item	Title	Description	Condition in which the function key cannot be used
L	VRange	The L range is selected. If you specify a value that is greater than 152.5 V with the H range selected and then switch to the L range, the output voltage will be set to 0 V.	Output on
H		The H range is selected.	

	Output voltage setting range	
	AC voltage	DC voltage
L range	0 V to 152.5 V	-215.5 V to +215.5 V
H range	0 V to 305.0 V	-431.0 V to +431.0 V

The output cannot be turned on for approximately 0.6 ms after the range is switched (Busy state).

## Setting the output voltage

You can set the output voltage while output is on or off. The measured value is always displayed.

Set the voltage limit to prevent the PCR-LE2 Series from generating a voltage that is greater than is necessary.

Be sure to set the output mode (single-phase, three-wire output or two-phase output) before you set the voltage. -> p24

The PCR-LE2 Series output impedance is extremely low, so depending on the load, a current may flow even if the voltage is set to 0.0 V. Be sure to turn the output off or turn the POWER switch off when you do not want any current to flow and before you connect a load.

### • AC mode

Specify the AC voltage that you want to generate.

You can specify an output voltage as low as 0.0 V, but the voltage that is actually generated will not be lower than a value in the range of 0.1 V to 0.6 V (the value varies depending on factors such as the output voltage range and the temperature).

### • DC mode

Specify the DC voltage that you want to generate.

### • AC+DC mode

Specify the AC and DC voltages that you want to generate.

The AC voltage setting is shared between AC and AC+DC modes.

The DC voltage setting is shared between DC and AC+DC modes.

The set AC and DC voltages must meet the following conditions: (1) they must be within the setting range of the voltage limit and (2) the AC+DC waveform's peak value must be within -431 V to 431 V when the H range is selected and within -215.5 V and 215.5 V when the L range is selected.

### ■ When the output is on

If the output is on, the measured value (output terminal voltage) and the setting are displayed. You can adjust the output voltage while viewing the output voltage setting and the measured value.

If you are using the rotary knob to set the value, you may increase or decrease the value too much because the display response is slow. Until you have an intuitive understanding of the display response speed, change the output voltage while viewing the voltage setting or make small changes to the output voltage.

## Output voltage setup procedure

To set the AC voltage, press V and then ACVOLT (F1).

To set the DC voltage, press V and then DCVOLT (F2).

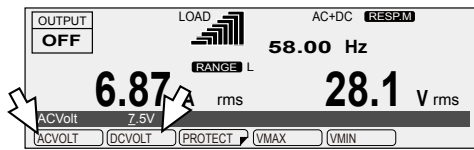

Item	Title	Description	Valid modes
ACVOLT	ACVolt	Sets the AC voltage	AC, AC+DC
DCVOLT	DCVolt	Sets the DC voltage	DC, AC+DC

Output voltage setting range		
	AC voltage	DC voltage
L range	0 V to 152.5 V	-215.5 V to +215.5 V
H range	0 V to 305.0 V	-431.0 V to +431.0 V

# Setting the Output Voltage (Cont.)

## Single-phase, three-wire output voltage setup procedure

### ■ Voltage setting range

- Phase voltage setting range

	AC voltage setting range	DC voltage setting range
L range	0 V to 152.5 V	-215.5 V to +215.5 V
H range	0 V to 305.0 V	-431.0 V to +431.0 V

- Line voltage setting range

The line voltage is twice the phase voltage.

	AC voltage setting range	DC voltage setting range
L range	0 V to 305.0 V	-431.0 V to +431.0 V
H range	0 V to 610.0 V	-862.0 V to +862.0 V

### ■ AC mode

#### Specifying the AC voltage with phase voltages

To set all the phases at the same time, press V and then PHAS VOLT (F1).

To set the U phase, press V, 1/2(F6), and then U VOLT(F1).

To set V phase, press V, 1/2(F6), and then V VOLT(F2).

With an unbalanced configuration, the unbalance icon is displayed.

Item	Title	Description
PHAS VOLT	AC PhaseVolt	Sets the AC voltage of all the phases
U VOLT	U AC PhaseVolt	Sets the AC voltage of U phase
V VOLT	V AC PhaseVolt	Sets the AC voltage of V phase

- Sets the phase difference

You can set the phase difference between U and V. To do so, press V, 1/2 (F6), and then UV PHASE (F4). If you set the phase difference to a value other than 180°, the unbalance icon is displayed.

Item	Title	Description
UV PHASE	U V Phase	Sets the U-V phase difference (0 deg to 359 deg)

#### Specifying the AC voltage with line voltages

You can set the line voltage. The line voltage is valid when the phase difference between U and V is 180°.

To do so, press V, and then LINE VOLT (F2).

Item	Title	Description
LINE VOLT	AC LineVolt	Sets the line voltage

### ■ DC mode

#### Specifying the DC voltage with phase voltages

Set a voltage that is 1/2 the voltage that is necessary between the lines.

To set the DC voltage to assign to the U phase, press V and then PHAS VOLT(F1). The V phase is automatically set to the same amplitude as the U phase but with opposite polarity.

Item	Title	Description
PHAS VOLT	DC PhaseVolt	Sets the DC voltage

#### Specifying the DC voltage with line voltages

You can set the line voltage.

To do so, press V, and then LINE VOLT (F2).

Item	Title	Description
LINE VOLT	DC LineVolt	Sets the line voltage

### ■ AC+DC mode

#### Specifying the AC voltage with phase voltages

To set all the phases at the same time, press V and then AC PHAS VOLT (F1).

To set the U phase, press V, 1/x(F6), and then U ACVOLT(F1).

To set V phase, press V, 1/x(F6), and then V ACVOLT(F2).

With an unbalanced configuration, the unbalance icon is displayed.

Item	Title	Description
AC PH VOLT	AC PhaseVolt	Sets the AC voltage of all the phases
U ACVOLT	U AC PhaseVolt	Sets the AC voltage of U phase
V ACVOLT	V AC PhaseVolt	Sets the AC voltage of V phase

#### Specifying the AC voltage with line voltages

You can set the line voltage. In two-phase output (2P MODE ON), the line voltage is valid when the phase difference between U and V is 180°.

To do so, press V, and then LINE VOLT (F2).

Item	Title	Description
LINE VOLT	AC LineVolt	Sets the line voltage

#### Setting the DC voltage

Set the DC voltage with phase voltages.

Set a voltage that is 1/2 the voltage that is necessary between the lines.

To set the DC voltage to assign to the U phase, press V and then DC PHAS VOLT(F3). The V phase is automatically set to the same amplitude as the U phase but with opposite polarity.

Item	Title	Description
DC PH VOLT	DC PhaseVolt	Sets the DC voltage

## Three-phase output voltage setup procedure

### ■ Voltage setting range

- Phase voltage setting range

	AC voltage setting range	DC voltage setting range
L range	0 V to 152.5 V	-215.5 V to +215.5 V
H range	0 V to 305.0 V	-431.0 V to +431.0 V

- Line voltage setting range

The line voltage is  $\sqrt{3}$  times the phase voltage.

	AC voltage setting range
L range	0 V to 264.1 V
H range	0 V to 528.2 V

### ■ AC Mode

#### Specifying the AC voltage with phase voltages

To set all the phases at the same time, press V and then PHAS VOLT (F1).

To set the U phase, press V, 1/2(F6), and then U VOLT(F1).

To set V phase, press V, 1/2(F6), and then V VOLT(F2).

To set W phase, press V, 1/2(F6), and then W VOLT(F3).

With an unbalanced configuration, the unbalance icon is displayed.

Item	Title	Description
PHAS VOLT	AC PhaseVolt	Sets the AC voltage of all the phases
U VOLT	U AC PhaseVolt	Sets the AC voltage of U phase
V VOLT	V AC PhaseVolt	Sets the AC voltage of V phase
W VOLT	W AC PhaseVolt	Sets the AC voltage of W phase

- Sets the phase difference

You can set the phase differences between U and V and between U and W.

To set the phase difference between U and V, press V, 1/2 (F6), and then UV PHASE (F4). To set the phase difference between U and W, press V, 1/2 (F6), and then UW PHASE (F5).

If the phase difference between U and V is set to a value other than 120° or the phase angle between U and W is set to a value other than 240°, the unbalance icon is displayed.

Item	Title	Description
UV PHASE	U V Phase	Sets the U-V phase difference (0 deg to 359 deg)
UW PHASE	U W Phase	Sets the U-W phase difference (0 deg to 359 deg)

#### Specifying the AC voltage with line voltages

You can set the line voltage when the phase difference between U and V is 120° and the phase difference between U and W is 240°. To do so, press V and then LINE VOLT (F2).

Item	Title	Description
LINE VOLT	AC LineVolt	Sets the line voltage

### ■ AC+DC Mode

#### Specifying the AC voltage with phase voltages

To set all the phases at the same time, press V and then AC PH VOLT (F1).

To set the U phase, press V, 1/4(F6), and then U AC VOLT(F1).

To set V phase, press V, 1/4(F6), and then V ACVOLT(F2).

To set W phase, press V, 1/4(F6), and then W ACVOLT(F3).

With an unbalanced configuration, the unbalance icon is displayed.

Item	Title	Description
AC PH VOLT	AC PhaseVolt	Sets the AC voltage of all the phases
U ACVOLT	U AC PhaseVolt	Sets the AC voltage of U phase
V ACVOLT	V AC PhaseVolt	Sets the AC voltage of V phase
W ACVOLT	W AC PhaseVolt	Sets the AC voltage of W phase

- Sets the phase difference

You can set the phase differences between U and V and between U and W.

To set the phase difference between U and V, press V, 1/4 (F6), and then UV PHASE (F4). To set the phase difference between U and W, press V, 1/4 (F6), and then UW PHASE (F5).

If the phase difference between U and V is set to a value other than 120° or the phase angle between U and W is set to a value other than 240°, the unbalance icon is displayed.

Item	Title	Description
UV PHASE	U V Phase	Sets the U-V phase difference (0 deg to 359 deg)
UW PHASE	U W Phase	Sets the U-W phase difference (0 deg to 359 deg)

#### Specifying the AC voltage with line voltages

You can set the line voltage when the phase difference between U and V is 120° and the phase difference between U and W is 240°. To do so, press V and then AC LIN VOLT (F2).

Item	Title	Description
AC LIN VOLT	AC LineVolt	Sets the line voltage

#### Setting the DC voltage

Set the DC voltage with phase voltages.

To set all the phases at the same time, press V and then DC PH VOLT (F3).

To set the U phase, press V, 1/4(F6), 2/4(F6), and then U DCVOLT(F1). To set V phase, press V, 1/4(F6), 2/4(F6), and then V DCVOLT(F2). To set W phase, press V, 1/4(F6), 2/4(F6), and then W DCVOLT(F3).

With an unbalanced configuration, the unbalance icon is displayed.

Item	Title	Description
DC PH VOLT	DC PhaseVolt	Sets the DC voltage of all the phases
U DCVOLT	U DC PhaseVolt	Sets the DC voltage of U phase
V DCVOLT	V DC PhaseVolt	Sets the DC voltage of V phase
W DCVOLT	W DC PhaseVolt	Sets the DC voltage of W phase

## Setting the Frequency

You can set the frequency in AC mode and AC+DC mode. The F key is disabled in DC mode.

You can set the frequency while output is on or off.

Set the frequency limit to prevent the PCR-LE2 Series from generating a frequency that is greater than is necessary.

### ■ Frequency setup procedure

Press F and then FREQ (F1) to set the frequency.

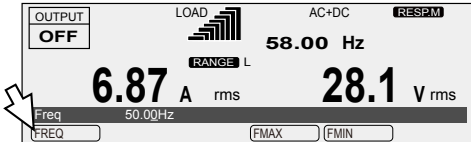

Item	Title	Description	Valid modes
FREQ	Freq	Sets the frequency (1.00 Hz to 999.9 Hz)	AC and AC+DC

## Turning Output On and Off

### ⚠ WARNING

**Risk of electric shock.**

Do not touch the **OUTPUT terminal block, the outlets, and the sensing terminal block.** The time required for the internal capacitors to discharge when no load is connected is approximately 0.1 seconds.

In DC mode, even if the output is off, if a capacitor, battery, or similar item is connected as the load, a voltage remains in the device that is connected to the **OUTPUT terminal block, the outlets, and the sensing terminal block** until the load's energy is discharged.

### ⚠ CAUTION

When you turn the output on, several volts of undershoot or overshoot may occur for several tens of microseconds.

Each time that you press OUTPUT, the output toggles between on and off.

#### • Output on

"OUTPUT ON" is shown on the display.

A voltage and frequency that correspond to the output mode and output range that you have specified are generated.

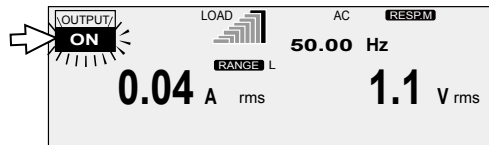

#### • Output off

"OUTPUT OFF" is shown on the display.

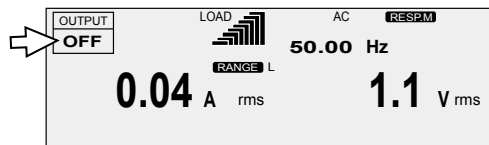

If a protection function is activated and the product is in the alarm state, the output is turned off.

### ■ power is turned on

You can select the state of the output when the POWER switch is turned on.

Press OTHERS (SHIFT+MEMORY), 1/3 (F6), and then PON OUTP(F4) to set the state of output.

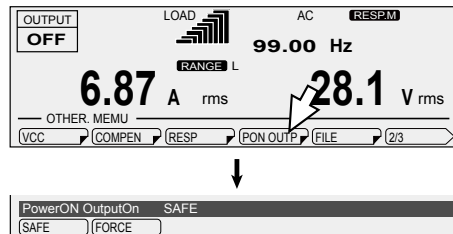

Item	Title	Description
SAFE	PowerOn	The output is off when the power is turned on.
FORCE	OutputOn	The output is on when the power is turned on.

### ■ Impedance when the output is off

The internal circuits and the output of the PCR-LE2 Series are not separated by a mechanical switch or relay. The PCR-LE2 Series turns the output off by electrically increasing the output impedance. This enables you to turn the output on and off without chattering. When the output is off, the output is set to high impedance, and the output voltage is nearly 0 V.

Even when the output is on, the following impedances are present, so if the load is a battery or a similar device, a slight current may flow into the PCR-LE2 Series, and the load may be discharged.

	Single-phase output		Single-phase three-wire output Three-phase output	
	L range	H range	L range	H range
PCR6000LE2	Approx. 1.3 kΩ	Approx. 5.3 kΩ	Approx. 4 kΩ	Approx. 16 kΩ
PCR9000LE2	Approx. 0.89 kΩ	Approx. 3.6 kΩ	Approx. 2.7 kΩ	Approx. 10.7 kΩ
PCR12000LE2	Approx. 0.67 kΩ	Approx. 2.7 kΩ	Approx. 2 kΩ	Approx. 8 kΩ
PCR18000LE2	Approx. 0.44 kΩ	Approx. 1.8 kΩ	Approx. 1.3 kΩ	Approx. 5.3 kΩ
PCR27000LE2	Approx. 0.30 kΩ	Approx. 1.2 kΩ	Approx. 0.89 kΩ	Approx. 3.6 kΩ

### ■ Voltage surge suppression when the output is turned off

You can set the voltage surge suppression that is activated when the output is turned off.

When the output is off, the output of this product is at high impedance.

If voltage surge suppression is set to ON (factory default setting), immediately after the output is turned off, the output voltage is set to 0 V (low output impedance), and then the impedance is changed to high. To prevent large overshooting and undershooting by the load immediately after the output is turned off, we recommend that you use the PCR-LE2 Series with the voltage surge suppression set to on.

When voltage surge suppression is on, an unexpected current may flow through the product immediately after the output is turned off depending on the connected load (power conditioner, regenerative inverter, battery, etc.). This may affect the test. Turn voltage surge suppression off for the above loads.

Press CONFIG (SHIFT+OPR MODE), 1/2 (F6), and then SURGE S (F2) to set voltage surge suppression.

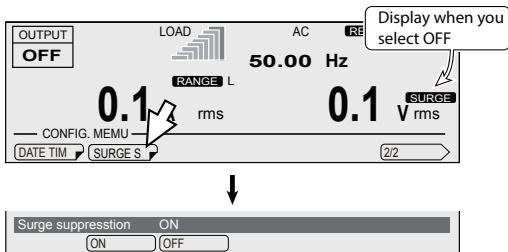

Item	Title	Description
ON	Surge suppression	Voltage surge suppression on The output is turned off after the output voltage is set to 0 V.
OFF		Voltage surge suppression off The output is turned off with the output left at high impedance.

### Output on/off phase control

You can set the AC mode output on/off phase. You can set the output on and output off phases separately. This is valid in AC mode and AC+DC mode.

During single-phase, three-wire output and three-phase output, set the phase of the U-phase unit.

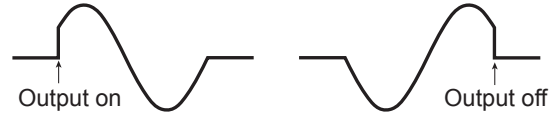

### ■ Output on phase setup procedure

When you are controlling the output on phase, set the phase angle as well.

Press ON PHASE (SHIFT+7) to set the output on phase.

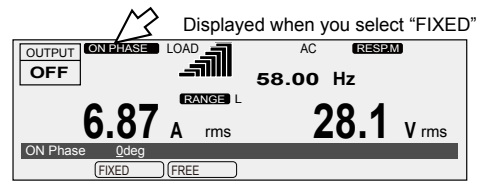

Item	Title	Description	Valid modes
FIXED	ON Phase	Sets the output on phase angle (0 deg to 359 deg) The output on phase is controlled.	AC and AC+DC
FREE		The output on phase is not controlled.	

### ■ Output off phase setup procedure

When you are controlling the output of phase, set the phase angle as well.

Press OFF PHASE (SHIFT+4) to set the output off phase.

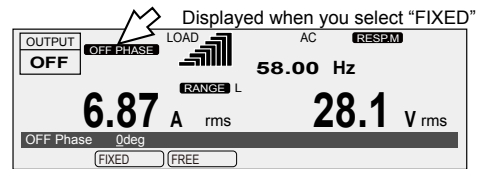

Item	Title	Description	Valid modes
FIXED	OFF Phase	Sets the output off phase angle (0 deg to 359 deg) The output off phase is controlled.	AC and AC+DC
FREE		The output off phase is not controlled.	

# Displaying Measured Values

You can monitor the present output value. When the output is off, this is nearly 0.

## Setting the aperture time (measurement time)

With a longer aperture time, the measurements become more stable, but it takes longer to update the display of the measured values. Guidelines for the aperture time when the signal includes an AC component are given below.

- When the period of the AC is known, you can obtain the most accurate measurement results if you set the aperture time to an integer multiple of the period.

Example: If the period of the AC component is 0.1 s, you can obtain the best results in the shortest time if you set the aperture time to 0.1 s.

- When the period of the AC component is unknown, you can obtain comparatively stable measurement results if you set the aperture time to a value that is at least 10 times the expected period.

If the period is set greater than the aperture time, line voltages cannot be measured correctly.

If the harmonic current analysis function is in use and the period is set greater than the aperture time, correct measurements cannot be made.

Press OTHERS (SHIFT+MEMORY), 1/3 (F6), 2/3 (F6), and then APERTUR (F1) to set the aperture time.

Factory default is 0.4 s.

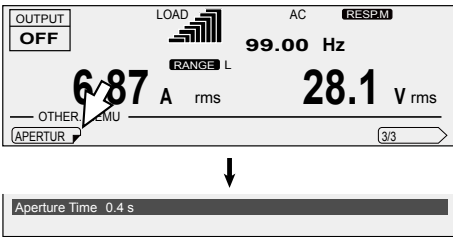

Item	Title	Description	Valid modes
APERTUR	Aperture Time	Sets the aperture time (0.1 s to 1.0 s, resolution: 0.001 s).	All

The aperture time setting was added in firmware version 5.00. As a result, the function for averaging measured values that was available in firmware version 4.99 and earlier is no longer available.

## Displaying the voltage

The measured voltage is displayed in the status, measured-value, and setting display area.

The voltage is displayed as an rms value, peak value, or average value.

To switch the display, press V-MEAS (SHIFT+V) to select the item that you want to display.

During single-phase, three-wire output and three-phase output, you can select to display phase voltage or line voltage.

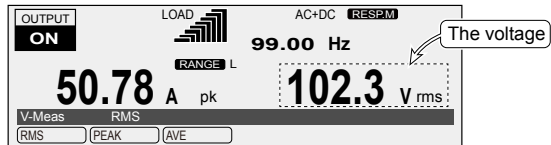

Item	Title	Unit	Description	Valid modes
RMS	V-Meas	V rms	Displays the rms voltage	All
PEAK		V pk	Displays the peak voltage	
AVE		V ave	Displays the average voltage	DC and AC+DC
LINE*1	ON	V-Line	Displays the line voltage	AC and DC
	OFF		Displays the phase voltage	

\*1. Single-phase three-wire output or three-phase output only

## Line voltage display and Phase voltage display

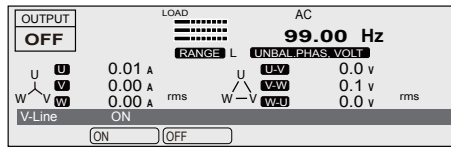

V-LINE	OFF (Phase voltage display)	ON (Line voltage display)
When a single phase is displayed	<b>U</b> U example	<b>U-V</b> U-V example
When all phases are displayed (single-phase, three-wire output)	<b>U</b> <b>V</b>	<b>U-V</b> <b>V-U</b>
When all phases are displayed (three-phase output)	<b>U</b> <b>V</b> <b>W</b>	<b>U-V</b> <b>V-W</b> <b>W-U</b>



## Load level meter

The load level meter displays the ratio of the output current (which is detected as the current flowing through the load) to the rated current on a bar graph. This can be used to determine the approximate output current supply capability. The full scale of the load level meter is 1.1 times the rated current or the current limit, whichever is less.

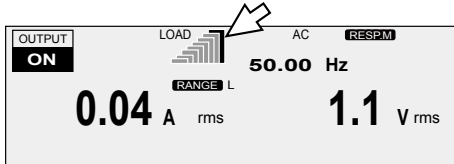

During single-phase, three-wire output, the load level meter displays the U phase at the top and then the V phase.

During three-wire output, the load level meter displays the U phase at the top followed by the V phase and W phase.

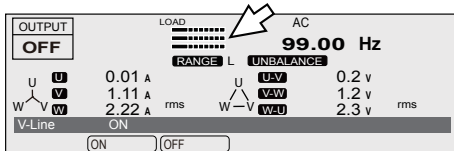

The full scale bar (the right-most bar that lights red) of the load level meter lights on the verge of an overload.

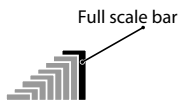

When the PCR-LE is on the verge of an overload, the internal temperature increases. Even if the load is reduced, the full scale bar may continue to light dimly in red. When cooling is complete, the full scale bar turns off.

If overload conditions occur repeatedly while the full scale bar is lit, an alarm (ALM-06: OVERLOAD) may be generated.

### Rated current and load level meter display

The output current varies depending on the load. The rated current is automatically derated (reduced) depending on the output conditions (output voltage, frequency, and load power factor).

For details of rated output current, see "About the output and the load". -> p98

The rated current is automatically derated (reduced) depending on the output conditions (output voltage, frequency, and load power factor).

Examples of calculating the rated currents for single-phase three-wire output and three-phase output for the PCR6000LE2 are given below.

- If the output phase voltage is 80 V, the load power factor is 0.6, and the output frequency is 50 Hz, the rated current is  $20 \text{ A} \times 0.825 = 16.5 \text{ A}$ .
- If the output phase voltage is 250 V, the load power factor is 0.4, and the output frequency is 60 Hz, the rated output current is  $2000 \text{ W}/250 \text{ V} \times 0.65 = 5.3 \text{ A}$ .
- If the output phase voltage is 80 V, the load power factor is 0.6, and the output frequency is 10 Hz, the rated current is  $20 \text{ A} \times 0.775 = 15.5 \text{ A} (\leq 16.5 \text{ A})$ .

## Displaying the current, power, and power factor

The rms current, peak current, average current, power, apparent power, or power factor is displayed in the status, measured-value, and setting display area.

To switch the display, press I/P/S/λ-MEAS (SHIFT+I) to select the item that you want to display.

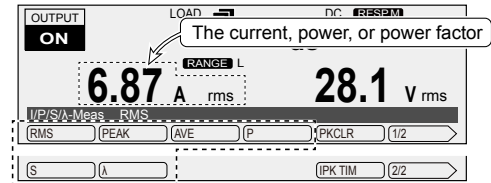

Item	Title	Unit	Description	Valid modes
RMS	I/P/S/λ-Meas	A rms	Displays the rms current	All
PEAK		A pk	Displays the peak current	
AVE		A ave	Displays the average current	DC and AC+DC
P		W/kW	Displays the power	All
S		VA	Displays the apparent power	AC and AC+DC
λ		λ	Displays the power factor	AC+DC
TOTAL P <sup>*1</sup>		W	Displays the total power	All
TOTAL S <sup>*1</sup>		VA	Displays the total apparent power	AC and AC+DC
TOTAL λ <sup>*1</sup>		λ	Displays the total power factor	

\*1. Single-phase three-wire output or three-phase output only

### ■ Holding the peak current

The peak current measurement is displayed as an absolute value of the maximum instantaneous current measured. In DC mode, even if you are generating negative voltage, the peak measured current is displayed as a positive value.

If you have selected the peak current measurement as the measured value that is displayed, you can hold the peak current measurement.

Press I/P/S/λ-MEAS (SHIFT+I), 1/2 (F6), and then IPK TIM (F5) to set the hold time.

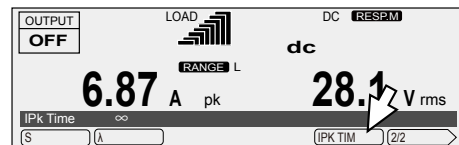

Item	Title	Description	Valid modes
IPK TIM	IPk Time	Sets the hold time (0 s to 10 s or ∞). If you use the numeric key pad to specify a value that is greater than or equal to 10, infinity (∞) will be specified.	All (only when the peak current measurement is being displayed)

### ■ Clearing the peak current

Press I/P/S/λ-MEAS (SHIFT+I) and then PKCLR (F5) to clear the peak current.

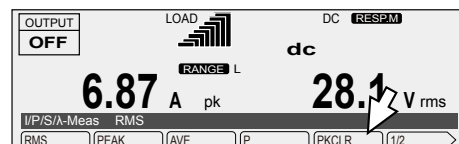

Item	Description
PKCLR	Clears the peak current

## Limit Values and Protection Functions

This product has the following limit functions and protection functions.

- Limit Functions

Limits can be placed on the PCR-LE2 Series output voltage setting and frequency setting. They prevent damage to the load caused by mistaken operations and limit the current that flows through the load.

- Protection Functions

Protection functions apply limits when there is a danger of damaging the internal circuitry of the PCR-LE2 Series or to protect the DUT.

When a protection function is activated, an alarm (ALM-xx) or a trouble indication (TRBL-xx) is generated, and the output is turned off.

Item	Function	Description	Output off
Voltage upper limit	Limit	You will not be able to specify voltages that are outside of the set limit range.	No
Voltage lower limit	Limit	You will not be able to specify voltages that are outside of the set limit range.	No
Output overvoltage protection (OVP)	Protection	If the measured voltage exceeds the OVP value, an alarm occurs, and the output turns off.	Yes
Output undervoltage protection (UVP)	Protection	If the measured voltage falls below the UVP value, an alarm occurs, and the output turns off.	Yes
Frequency upper limit	Limit	You will not be able to specify frequencies that are outside of the set limit range.	No
Frequency lower limit	Limit	You will not be able to specify frequencies that are outside of the set limit range.	No
Current limit	Limit	If the upper limit is exceeded, the output turns off, or the output voltage is controlled so that the limit value is not exceeded. You cannot set the lower limit. You can set how the PCR-LE2 Series behaves when the limit is exceeded (whether to turn off the output or control the output voltage). If you select to turn off the output, you can set the time that must elapse before the output is turned off when the current limit is exceeded. If you select to control the output voltage, the following functions will not be available. <ul style="list-style-type: none"> <li>• Turn soft start on (set the rise time)</li> <li>• Execute power line abnormality simulations</li> <li>• Run sequences</li> <li>• Use the compensation function's software sensing and regulation adjustment</li> </ul>	Selectable
Peak current limit	Limit	This function instantly limits the peak output current. You can set positive and negative limits.	No
Internal semiconductor protection (OCP)	Protection	This function protects the internal semiconductors of the PCR-LE2 Series. If a temporary overcurrent—such as an inrush current—occurs, an alarm occurs, and the output turns off.	Yes
Input voltage drop protection	Protection	If the input voltage falls below the rating, a trouble indication occurs, and the output turns off.	Yes
Overload protection	Protection	If the output current exceeds the rated current or current limit, an alarm occurs, and the output turns off.	Yes
Overheat protection (OHP)	Protection	If the internal temperature increases abnormally, an alarm occurs, and the output turns off.	Yes

## Setting Limits

Limits can be placed on the PCR-LE2 Series output voltage setting and frequency setting. They prevent damage to the load caused by mistaken operations and limit the current that flows through the load. You can set limits in advance according to the load conditions.

You can set these values while output is on or off.

### Voltage upper and lower limits

Limits can be placed on the PCR-LE2 Series output setting. They prevent damage to the load caused by mistaken operations. You can set limits in advance according to the load conditions.

After you set the voltage limits, you will no longer be able to specify voltage values that are outside of the range that you have set. The only exception is 0 V. You can still use the numeric keypad to specify this value.

Set the limits so that the lower limit is less than or equal to the upper limit.

In AC+DC mode, there are AC limits and DC limits. Check the title in the entry area, and then set the value.

During single-phase, three-wire output and three-phase output (optional), set the limits using phase voltages.

To set the voltage upper limit, press V and then VMAX (F4).

To set the voltage lower limit, press V and then VMIN (F5).

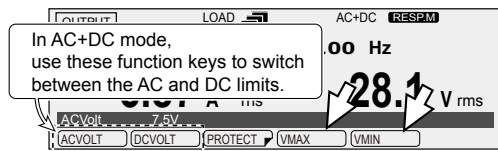

Item	Title	Description	Valid modes
VMAX	ACVoltMax	Sets the AC voltage upper limit (0.0 V to 305.0 V)	AC and AC+DC
	AC PhaseVoltMax <sup>*1</sup>	Sets the AC phase voltage upper limit (0.0 V to 305.0 V)	
VMIN	DCVoltMax	Sets the DC voltage upper limit (-431.0 V to 431.0 V)	DC and AC+DC
	DC PhaseVoltMax <sup>*1</sup>	Sets the DC phase voltage upper limit (-431.0 V to 431.0 V)	
VMAX	ACVoltMin	Sets the AC voltage lower limit (0.0 V to 305.0 V)	AC and AC+DC
	AC PhaseVoltMin <sup>*1</sup>	Sets the AC phase voltage lower limit (0.0 V to 305.0 V)	
VMIN	DCVoltMin	Sets the DC voltage lower limit (-431.0 V to 431.0 V)	DC and AC+DC
	DC PhaseVoltMin <sup>*1</sup>	Sets the DC phase voltage lower limit (-431.0 V to 431.0 V)	

\*1. The display during single-phase, three-wire output and three-phase output

### Frequency upper and lower limits

Limits can be placed on the PCR-LE2 Series output setting. They prevent damage to the load caused by mistaken operations. You can set limits in advance according to the load conditions.

After you set the frequency limits, you will no longer be able to specify frequency values that are outside of the range that you have set.

You cannot set these values in DC mode.

Set the limits so that the lower limit is less than or equal to the upper limit.

Press F and then FMAX (F4) to set the frequency upper limit.

Press F and then FMIN (F5) to set the frequency lower limit.

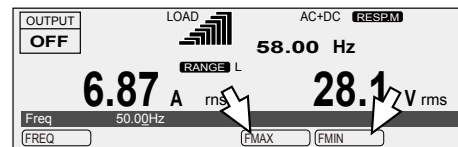

Item	Title	Description	Valid modes
FMAX	FreqMax	Sets the frequency upper limit (1.00 Hz to 999.9 Hz)	AC and AC+DC
FMIN	FreqMin	Sets the frequency lower limit (1.00 Hz to 999.9 Hz)	

## Setting Limits (Cont.)

### Current limit and peak current limits

Limits can be placed on the current that flows through the load. There is a current limit, a positive peak current limit, and a negative peak current limit. You can set limits according to the load conditions.

- **Current limit**

You can set the output current's upper limit. You cannot set the lower limit.

The limit operates on the rms value of the output current.

You can set how the PCR-LE2 Series acts (turn the output off/ do not turn the output off) when the current limit is exceeded.

The actual current limit is activated at 1.1 times the rated current or the current limit, whichever is less. The rated current is automatically derated (reduced) depending on the output conditions (output voltage, frequency, and load power factor). For details of rated output current, see "About the output and the load". -> p98

- **Positive peak current limit and negative peak current limit**

You can set positive and negative peak current limits.

These instantly limit the peak output current.

If the peak current approaches the peak current limit (approximately 94 % of the peak current limit), "IPK.LIM" is displayed.

Setting the peak current limits does not change the load level meter's full scale.

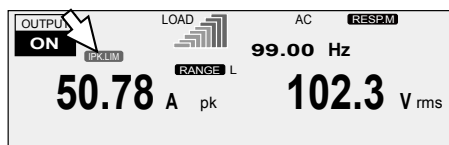

Press I and then ILIMIT (F1) to set the current limit.

Press I and then +IPKLIM (F4) to set the positive peak current limit.

Press I and then -IPKLIM (F5) to set the negative peak current limit.

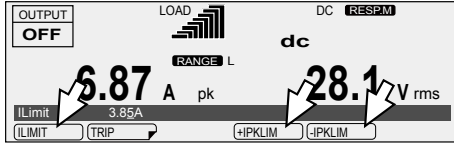

Item	Title	Description
ILIMIT	ILimit	Sets the current limit (the rated current × 0.1 to the rated current × 1.1)
	U <sup>*1</sup>	U ILimit Sets the current limit of U phase (the rated current × 0.1 to the rated current × 1.1)
	V <sup>*1</sup>	V ILimit Sets the current limit of V phase (the rated current × 0.1 to the rated current × 1.1)
+IPKMAX	W <sup>*2</sup>	W ILimit Sets the current limit of W phase (the rated current × 0.1 to the rated current × 1.1)
	+IPKLimit	Sets the positive peak current limit (the rated current × 0.1 to the rated current × 4.4)
	U <sup>*1</sup>	U +IPKLimit Sets the positive peak current limit of U phase (the rated current × 0.1 to the rated current × 4.4)
-IPKMAX	V <sup>*1</sup>	V +IPKLimit Sets the positive peak current limit of V phase (the rated current × 0.1 to the rated current × 4.4)
	W <sup>*2</sup>	W +IPKLimit Sets the positive peak current limit of W phase (the rated current × 0.1 to the rated current × 4.4)
	-IPKLimit	Sets the negative peak current limit (the rated current × 0.1 to the rated current × 4.4)
U <sup>*1</sup>	U -IPKLimit	Sets the negative peak current limit of U phase (the rated current × 0.1 to the rated current × 4.4)
	V <sup>*1</sup>	V -IPKLimit Sets the negative peak current limit of V phase (the rated current × 0.1 to the rated current × 4.4)
	W <sup>*2</sup>	W -IPKLimit Sets the negative peak current limit of W phase (the rated current × 0.1 to the rated current × 4.4)

\*1. Single-phase three-wire output or three-phase output only

\*2. Three-phase output only

	Output mode	Setting									
		PCR6000LE2		PCR9000LE2		PCR12000LE2		PCR18000LE2		PCR27000LE2	
		Single-phase output	Single-phase three-wire output Three-phase output	Single-phase output	Single-phase three-wire output Three-phase output	Single-phase output	Single-phase three-wire output Three-phase output	Single-phase output	Single-phase three-wire output Three-phase output	Single-phase output	Single-phase three-wire output Three-phase output
Current limit <sup>*1</sup>	AC	6.00 A to 66.00 A	2.00 A to 22.00 A	9.00 A to 99.00 A	3.00 A to 33.00 A	12.00 A to 132.0 A	4.00 A to 44.00 A	18.00 A to 198.0 A	6.00 A to 66.00 A	27.00 A to 297.0 A	9.00 A to 99.00 A
	DC <sup>*2</sup> and AC+DC	4.20 A to 46.20 A	1.40 A to 15.40 A	6.30 A to 69.30 A	2.10 A to 23.10 A	8.40 A to 92.40 A	2.80 A to 30.80 A	12.60 A to 138.6 A	4.20 A to 46.20 A	18.90 A to 207.9 A	6.30 A to 69.30 A
Positive peak current limit <sup>*3</sup>	All	6.00 A to 264.0 A	2.00 A to 88.00 A	9.00 A to 396.0 A	3.00 A to 132.0 A	12.00 A to 528.0 A	4.00 A to 176.0 A	18.00 A to 792.0 A	6.00 A to 264.0 A	27.00 A to 1188 A	9.00 A to 396.0 A
Negative peak current limit <sup>*3</sup>	All	-6.00 A to -264.0 A	-2.00 A to -88.00 A	-9.00 A to -396.0 A	-3.00 A to -132.0 A	-12.00 A to -528.0 A	-4.00 A to -176.0 A	-18.00 A to -792.0 A	-6.00 A to -264.0 A	-27.00 A to -1188 A	-9.00 A to -396.0 A

\*1. The current that can actually be supplied is 1.1 times the rated current or the current limit, whichever is less. For details, see "Rated output current characteristics (Derating)". -> p87

\*2. Single-phase output or single-phase three-wire output only

\*3. The current that can actually be supplied is the maximum peak current or the current limit, whichever is less. For details of maximum peak current, see "AC mode output (AC rms)". -> p82

## Setting Limits (Cont.)

### Current limit and peak current limits (Cont.)

#### ■ Action to perform when the current limit is exceeded

You can set the action to perform (whether the output is turned off) when the current exceeds the current limit. In AC mode, you can set the time that elapses before the output is turned off when the current limit is exceeded.

The current limit function operates on the rms value of the current.

#### Action: Turn the output off (ENABLE)

- The limit has not been exceeded

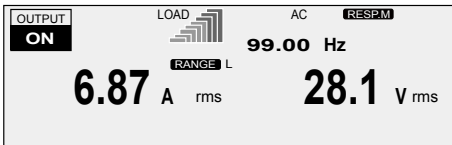

- The limit has been exceeded

In AC mode, the output is turned off after the specified trip time has elapsed.

In DC mode and AC+DC mode, the output is turned off 1 second after the limit has been exceeded.

There is a delay in the response depending on the aperture time setting. After the output is turned off, there is a period of approximately 120 seconds (the "Busy" state) during which the output cannot be turned on.

Cleared after approximately 120 seconds.  
Counts down the time until the indication is cleared.

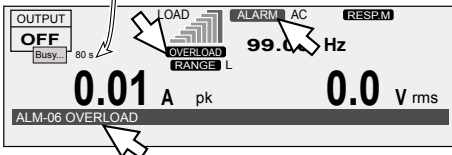

#### Action: Do not turn the output off (DISABLE)

- The limit has not been exceeded

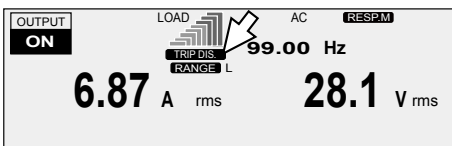

- The limit has been exceeded

The output voltage is controlled so that the current limit is not exceeded.

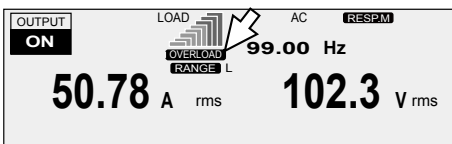

Press I and then TRIP (F2) to select the action to perform when the limit is exceeded.

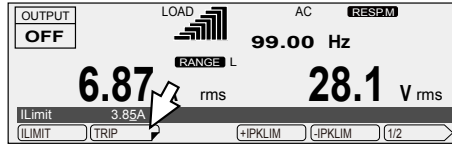

Item	Title	Description
ENABLE	Trip	If the current exceeds the current limit for more than a set amount of time, "OVERLOAD" lights, the output is turned off, and an alarm (ALM-06: OVERLOAD) is generated.
DISABLE		If the current is less than the current limit, "TRIP DIS." lights. If a current that is greater than the current limit flows, "OVERLOAD" lights, and the output voltage is controlled so that the current does not exceed the current limit. <sup>*1</sup>

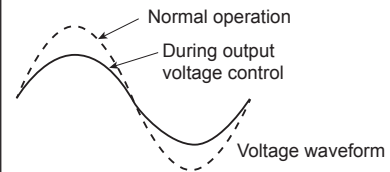

\*1. This is calculated as an rms value. The current limit may be exceeded for a few seconds because of the relationship between the measurement processing time and the voltage resolution. The current may oscillate (increase and decrease) while it is being controlled.

#### If you have selected ENABLE (to turn the output off)

To clear the alarm, press ALM CLR (SHIFT+CLR).

#### ⚠ CAUTION

Risk of product malfunction. If an overload occurs, be sure to remove the cause of the problem, and then press OUTPUT.

#### If you have selected DISABLE (to not turn the output off)

If you have selected to not turn the output off (DISABLE), you will not be able to:

Turn soft start on (set the rise time).

Execute power line abnormality simulations.

Execute sequences.

Use the compensation function's software sensing and regulation adjustment.

#### - Note -

If the load short-circuits, if an extreme overload occurs, or if the difference between the output voltage and the output voltage setting during output voltage control is large (the output voltage setting is high), (1) the internal semiconductor protection (OCP) may be activated and the output voltage waveform may be distorted or (2) an alarm (ALM-03: OCP) may occur.

**Setting the time (Trip time) that elapses before the output is turned off when the current limit is exceeded**

In AC mode, you can set the amount of time that elapses after the current limit is exceeded (the amount of time during which the current limit is continuously exceeded) before the output is turned off. This is useful when you don't want the output to be turned off due to issues such as inrush current causing short-term overloads.

If the voltage setting is at or lower than 10 V (L range) or 20 V (H range), the output will turn off after 3 s even if you set the trip time to 4 s or longer.

The amount time until the output is turned off may become large due to the state of the load or the timing of the PCR-LE2 Series internal current measurement. There is a delay in the response depending on the aperture time setting.

If the full scale bar of the load level meter continues to be lit, the temperature inside the PCR-LE2 is high. If an overload occurs repeatedly, the time until the output is turned off may be shortened.

Press I, TRIP (F2), and then TRIP TIM (F5) to set the time that elapses before the output is turned off.

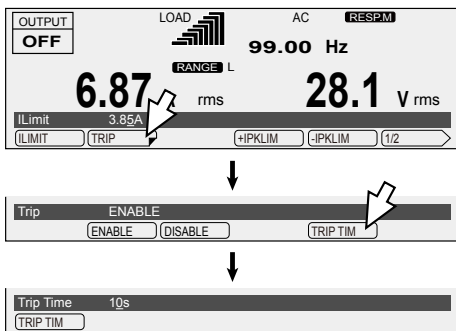

Item	Title	Description	Valid mode
TRIP TIM	Trip Time	Sets the time that elapses (0 s to 10 s) before the output is turned off when the current limit is exceeded	AC

# Using Protection Functions

The PCR-LE2 Series has the following protection functions.

- Input voltage drop protection
- Overheat protection (OHP)
- Overload protection
- Internal semiconductor protection (OCP)
- Output undervoltage protection (UVP)
- Output overvoltage protection (OVP)

If a protection function is activated, an alarm sounds, "ALARM" is displayed on the screen, and the output is turned off.

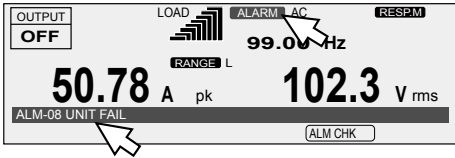

During master-slave parallel operation(optional), if an alarm occurs on one unit, the entire system's output will be turned off.

## ■ Clearing alarms

Press ALM CLR (SHIFT+CLR) to clear the alarm, and then fix the problem that caused the alarm.

If an alarm still occurs even after you have corrected all the causes of alarms, the PCR-LE2 Series may be malfunctioning. Stop using it immediately, and contact your Kikusui agent or distributor. Inform the individual that you contact of the alarm code that is displayed.

## ■ Input voltage drop protection

If the input voltage drops lower than the rating, the input voltage drop protection function is activated, and an alarm (AC INPUT LOW) is generated. Adjust the input voltage so that it is within the range in the specifications. If the input power supply wiring is long, use wires that have a large diameter to make the voltage drops smaller.

## ■ Overheat protection (OHP)

If the internal temperature rises to an abnormal level, the overheat protection is activated, and an alarm (ALM-02: OHP) is generated. Leave the PCR-LE2 Series on, and wait for approximately 10 minutes.

If the alarm has stopped occurring after 10 minutes, the PCR-LE2 Series may have been installed incorrectly, or the dust filter may be clogged.

If there are no problems with the installation or the dust filter, stop using the PCR-LE2 Series immediately, and contact your Kikusui agent or distributor to request repairs.

## ■ Overload protection

If the output current exceeds the rated current or the current limit (-> p36), the overload protection is activated, and an alarm is generated (ALM-06: OVERLOAD).

During reverse power flow, the protection is activated at 30% of the rated current or the current limit, whichever is less.

You can set how the PCR-LE2 Series acts when the current limit is exceeded.

## ■ Output undervoltage protection (UVP) and output overvoltage protection (OVP)

UVP and OVP judgment varies depending on the voltage mode.

AC mode: Judgment is based on the rms voltage measurements.

DC mode: Judgment is based on the averaged voltage measurements.

AC+DC mode: Judgment is based on both the rms and averaged voltage measurements.

### • Output undervoltage protection (UVP)

If the output voltage drops below the UVP setting and remains there for approximately 1 second, the output undervoltage protection will be activated. An alarm (ALM-07: UVP) will be generated.

### • Output overvoltage protection (OVP)

If the output voltage exceeds the OVP setting and remains there for approximately 1 second, the output overvoltage protection will be activated. An alarm (ALM-00: OVP) will be generated.

### • Setting UVP and OVP

In AC mode, specify an rms value. In DC mode, specify an average value.

In AC+DC mode, specify an rms value. To set an average value, change to DC mode, set the average value, and then return to AC+DC mode.

For single-phase three-wire output and three-phase output, set the limits using phase voltages.

During single-phase three-wire output and three-phase output (optional), set the limits using phase voltages.

To set the OVP value, press V, PROTECT (F3), and then OVP (F1).

To set the UVP value, press V, PROTECT (F3), and then UVP (F2).

If PROTECT(F3) does not appear, hold down F6 until it appears.

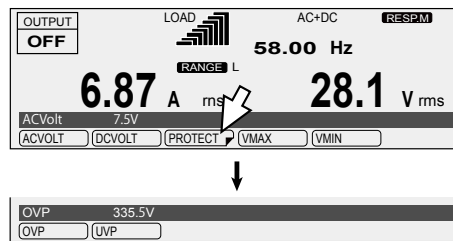

Item	Title	Description
OVP	OVP	Sets the OVP value (0.0 V to 474.1 V in AC mode and AC+DC mode, -474.1 V to 474.1 V in DC mode)
UVP	UVP	Sets the UVP value (0.0 V to 474.1 V in AC mode and AC+DC mode, -474.1 V to 474.1 V in DC mode)



## Internal semiconductor protection (OCP)

This protection function protects the internal semiconductors of the PCR-LE2 Series. The internal semiconductor protection function will not be activated if you follow the PCR-LE2 Series usage guidelines outlined in the specifications. If a temporary overcurrent - such as an inrush current - occurs, the internal semiconductor protection function will be activated. If the internal semiconductor protection function remains activated for a set amount of time, an alarm (ALM-03: OCP) will be generated.

If the internal semiconductor protection function is activated, the output voltage waveform will be distorted.

Voltage waveform

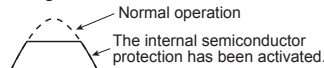

Voltage waveform

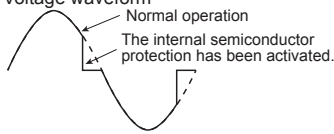

Current waveform



Voltage waveform

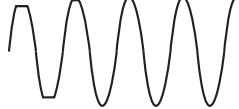

Example of the waveforms when the internal semiconductor protection has been activated.

In AC mode, you can set the time that elapses after the internal semiconductor protection function is activated before an alarm is generated. An alarm will only be generated if the internal semiconductor protection function circuit remains activated continually for the specified length of time. This is useful when you don't want alarms to be generated due to short-term overloads such as those caused by inrush current.

In DC mode and AC+DC mode, an alarm is generated 1 second after the internal semiconductor protection is activated.

"OCP" is displayed when the internal semiconductor protection is activated.

After the alarm is generated, there is a period of approximately 120 seconds (the "Busy" state) during which the output cannot be turned on. The time until the "Busy" indication is cleared is displayed. The time until the "Busy" indication is cleared is displayed.

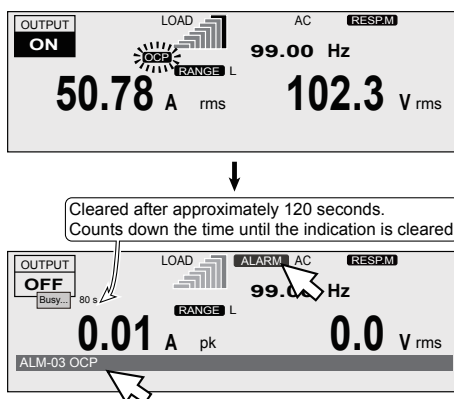

If the internal semiconductor protection is activated repeatedly, the PCR-LE2 Series may malfunction.

## Setting the time that elapses before an alarm is generated

In AC mode, you can set the time that elapses after the internal semiconductor protection has been activated (the amount of time during which the internal semiconductor protection is continually activated) before an alarm is generated.

The amount time that elapses before an alarm is generated may increase depending on the overload state.

Even if an alarm is not generated, the output voltage waveform will be distorted because the internal semiconductor protection circuit has been activated.

Press I, 1/2 (F6), and then OCP TIM (F1) to set the time that elapses before an alarm is generated.

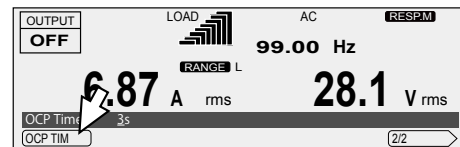

Item	Title	Description	Valid mode
OCPTIM	OCPTIME	Sets the time that elapses after the internal semiconductor protection function is activated before an alarm is generated (1 s to 3 s)	AC

## Dealing with alarms

If an alarm has occurred, follow the remedies shown below, wait for at least 1 minute, and then resume the operation.

If you remove the problem that caused the internal semiconductor protection to be activated, the alarm will be cleared automatically. While the internal semiconductor protection is activated, pressing ALM CLR (SHIFT+CLR) will not clear the alarm.

### Linear load

If the current has exceeded the rated current, decrease the load.

If the power factor is low (the phase is lagging), use a phase-advancing capacitor or similar device to increase the power factor.

If the power factor is low (the phase is leading), connect a dummy resistance in parallel to the load to increase the power factor.

### Capacitor-input rectifier load

Decrease the peak current.

### Load that draw an inrush current

Decrease the inrush current.

Configure soft starts (the voltage rise time).

## Using Protection Functions (Cont.)

### What to do if the breaker trips

The PCR12000LE2/PCR18000LE2/PCR27000LE2 do not have a breaker.

On the PCR6000LE2 and PCR9000LE2, if an output current of 10 A or greater flows from one of the outlets on the front panel, the breaker next to the outlet may trip, which will cut off the outlet's output. If the breaker trips, the red button (the breaker button) will pop out.

The total output current that can be generated from the two outlets and the OUTPUT terminal block on the rear panel is the rated output current. If the rated value is exceeded, the overload protection function is activated.

For example, during single-phase output on the PCR6000LE2, when the output voltage is 100 V (the 100 V range), the load power factor is 1, and the output frequency is 50 Hz, if an output current of 10 A is flowing from each outlet, the maximum output current that can be generated from the OUTPUT terminal block is  $(60 \text{ A} - 10 \text{ A} - 10 \text{ A}) = 40 \text{ A}$ .

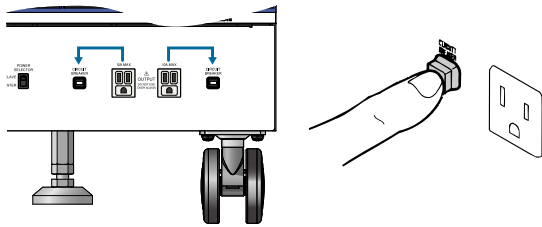

- 1** Turn the **POWER** switch off.
- 2** Press the breaker button in.
- 3** Adjust the load so that the output current is less than or equal to 10 A.
- 4** Turn the **POWER** switch on.

## Using Memory

You can store data to the PCR-LE2's internal memory and save data to a USB memory device.

### • Internal memory

This is useful when you are testing drastic changes in voltage or frequency.

You can store up to 99 sets of settings (the memory numbers are 0 to 99, but "0" is only for recalling settings).

The following settings can be stored to and recalled from memory.

	AC	DC	AC+DC
Frequency	Yes	No	Yes
AC voltage	Yes	No	Yes
DC voltage	No	Yes	Yes
Waveform bank number	Yes	No	Yes

### • USB memory device

The internal memory, panel settings, power line abnormality simulations, sequence data, and the data of one waveform bank can be saved.

## Using internal memory

The frequency, AC voltage, DC voltage, and waveform bank number can be stored to and recalled from the internal memory. During single-phase, three-wire output and three-phase output, phase voltages are stored. Line voltages are calculated from phase voltages.

### ■ Storing data to the internal memory

**1 Set up the configuration that you want to store.**

**2 Press MEMORY, STR No (F3).**

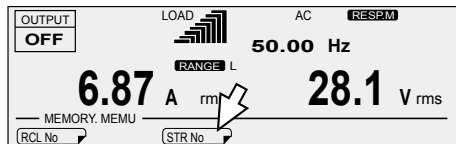

**3 Use the numeric keypad or the rotary knob to select the memory number where you want to store the configuration.**

The settings that will be stored (frequency, AC voltage, DC voltage, and waveform bank number) are displayed in the entry area.

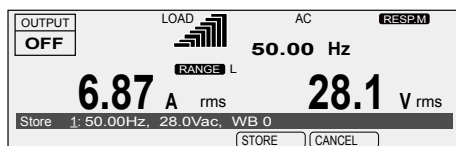

**4 Press STORE (F4) to store the settings.**  
The present settings are stored.

### ■ Recalling settings from memory

If the frequency that you recall is lower than the present frequency lower limit, the frequency will be set to the lower limit. If the frequency that you recall is higher than the present frequency upper limit, the frequency will be set to the upper limit.

If (1) the voltage that you recall is lower than the voltage lower limit or is higher than the voltage upper limit, (2) the voltage that you recall is outside of the set range when the L range has been selected, or (3) the peak voltage in AC+DC mode is outside of the following ranges: -431 V to 431 V (H range) or -215.5 V to 215.5 V (L range), the output voltage will be set to 0 V.

**1 Press MEMORY and then RCL No (F1).**

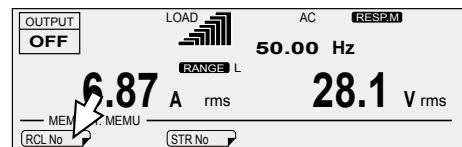

**2 Use the numeric keypad or the rotary knob to select the memory number that you want to recall.**

The settings that will be recalled (frequency, AC voltage, DC voltage, and waveform bank number) are displayed in the entry area.

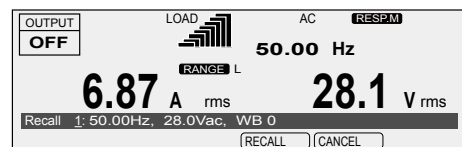

**3 Press RECALL (F4) to recall the settings from memory.**

The new values will be applied.

# Using Memory (Cont.)

## Using USB memory devices

The data of one waveform bank, internal memory (entries number 1 to 99), panel settings, power line abnormality simulations, and sequence data can be saved to a USB memory device. Data cannot be saved to or recalled from a USB memory device while power line abnormality simulations or sequences are being performed.

You cannot use a USB memory device that has a capacity greater than 16 GB.

Use a PC to format the USB memory device (into FAT32 format).

Some USB memory devices may not operate correctly.

### ■ Setting the date and time

The date and time are used in the timestamps of files saved to USB memory devices. If the product is left turned off for two to three weeks, the date and time settings will be cleared.

- 1 Press CONFIG (SHIFT+OPR MODE), 1/2 (F6), and then DATE TIM (F1).**

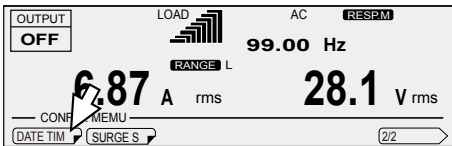

- 2 Use the left arrow and right arrow function keys to move the cursor to the setting that you want to change (year, month, day, hour, or minute), and then use the rotary knob to set the value.**

You cannot use the numeric keypad. You cannot set the seconds.

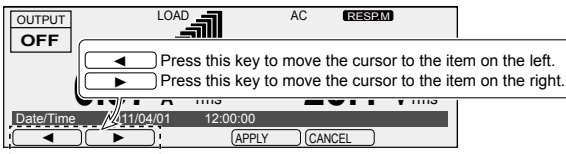

- 3 Press APPLY (F4) to confirm the date and time.**

The new values will be applied.

If you specify a day that does not exist (for example, February 30), the settings will be changed to the first day of the following month.

### ■ Folders where the files are saved and file names

The following folders are created on the USB memory device. The files—whose names are “folder name + a three-digit number (001 to 999).txt”—are then saved in these folders.

You cannot use the PCR-LE2 Series to delete or rename files. Use a PC to perform these operations.

Use alphanumeric characters for the file names. You cannot use forward slashes, back slashes, asterisks, question marks, double quotation marks, angled brackets (left or right), or vertical bars.

Do not store more than 100 files in each folder.

Saved contents	Created folder	File name <sup>*1</sup>
Internal memory	MEM	MEMxxx.txt
Panel settings	SET	SETxxx.txt
Power line abnormality simulations	SIM	SIMxxx.txt
Sequence data	SEQ	SEQxxx.txt
Waveform bank contents	WAVE	WAVExxx.txt

\*1. The “xxx” in the file name is a sequence number (001 to 999) that is automatically appended to the file name.

## ■ Saving data to USB memory devices

- 1 Set up the configuration that you want to save.
- 2 Connect a USB memory device to the USB port on the front panel.
- 3 Press OTHERS (SHIFT+MEMORY), 1/3 (F6), FILE (F5), and then SAVE (F3).

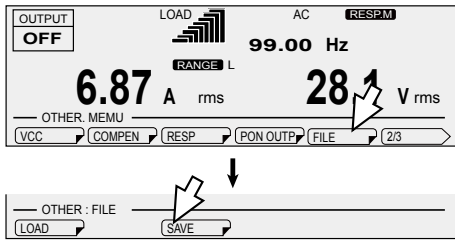

- 4 Select the item that you want to save.

Item	Description
MEM	Internal memory
SET	Panel settings
SIM	Power line abnormality simulations
SEQ	Sequence data
WAVE	Waveform bank contents

The name of the file that the data will be saved to is displayed in the entry area. When you are saving a waveform bank, the number of the waveform bank that you are saving and the file name are displayed.

You cannot use the numeric keypad.

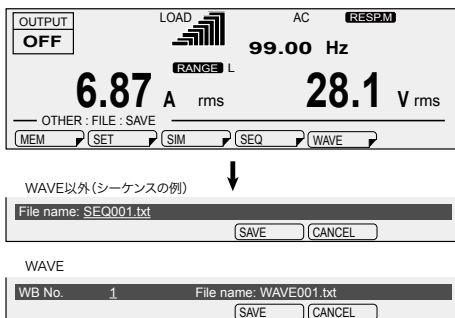

- 5 To save a waveform bank, first select the waveform bank item, and then use the rotary knob to select the number of the waveform bank that you want to save.

During single-phase, three-wire output or three-phase output, if you are saving a user-defined waveform, select the phase that you want to save using PHASE SEL (F3).

- 6 Press SAVE (F4) to save the settings. Do not remove the USB memory device until "File was saved" disappears.

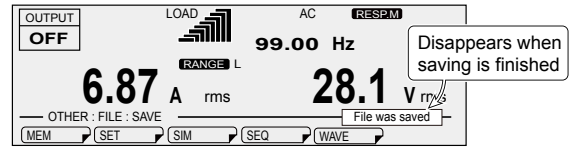

- 7 Remove the USB memory device from the USB port.

# Using Memory (Cont.)

## Using USB memory devices (Cont.)

### ■ Recalling settings from a USB memory device

**1** Connect a USB memory device to the USB port on the front panel.

**2** Press **OTHERS (SHIFT+MEMORY)**, **1/3 (F6)**, **FILE (F5)**, and then **LOAD (F1)**.

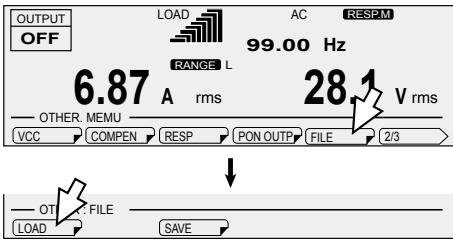

**3** Select the item that you want to recall.

Item	Description
MEM	Internal memory
SET	Panel settings
SIM	Power line abnormality simulations
SEQ	Sequence data
WAVE	Waveform bank contents

The name of the file saved to the USB memory device is displayed.

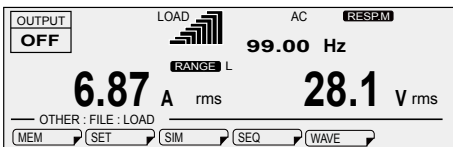

**4** To recall a waveform bank, use the rotary knob to specify the number of the waveform bank that the recalled waveform bank will be saved in, and then press **FILE SEL (F2)**.

You cannot use the numeric keypad.

During single-phase, three-wire output or three-phase output (optional), if you are recalling a user-defined waveform, select the phase that you want to recall using **PHASE SEL (F3)**.

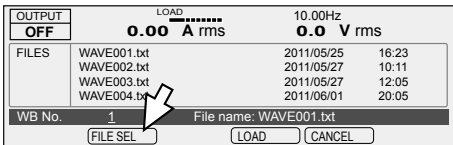

**5** Use the rotary knob to select the file that you want to recall.

When you are recalling a waveform bank, press **WB No. (F1)** to change the number of the waveform bank that the recalled waveform bank will be saved in. You cannot use the numeric keypad.

A value other than WAVE (panel settings in this example)

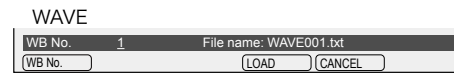
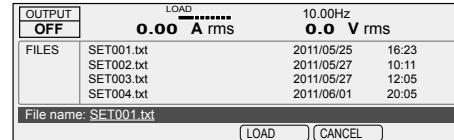

**6** Press **LOAD (F4)** to recall the file.

Do not remove the USB memory device until "File was loaded" disappears.

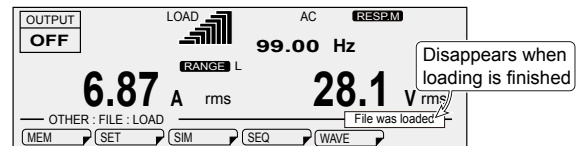

**7** Remove the USB memory device from the USB port.

## ■ Error messages

If there is a problem with the USB memory device, an error will occur. Error messages are displayed when errors occur.

Error message	Description
Data out of range. (Line = the line number)	A setting is outside of its range.
Disk access error. (Error code)	A USB memory device read or write error occurred.
Disk error. (Error code; line = the line number)	An error not listed here occurred.
Disk full.	There is no free space on the USB memory device.
Disk mount error.	The mounting of the USB memory device failed.
File not found.	The file could not be found.
Illegal parameter. (Line = the line number)	A parameter was illegal.
No disk.	The USB memory device is not connected.
Not supported. (Line = the line number)	The read operation is not supported.
Path not found.	The path (folder) could not be found.
Settings conflict. (Line = the line number)	The PCR-LE2 Series is in a condition in which the function key cannot be used.
Syntax error. (Line = the line number)	The delimiter character could not be found.





This chapter explains the advanced operations of the PCR-LE2 Series.

## Using the Synchronization Function

The synchronization function synchronizes the frequency and phase of the PCR-LE2 Series output voltage with a 50 Hz or 60 Hz input power supply. This is valid in AC mode and AC+DC mode.

This is useful in situations such as when the display of an external measuring instrument is not stable.

Setting the synchronization delay phase angle enables you to manage the synchronization phase of the input voltage on the three-phase input model with a high degree of precision.

Turning the synchronization function on disables the frequency limit function.

### Turning the synchronization function on and off

If the input voltage frequency is outside of the rated range or if the input power supply voltage distortion and the noise are extremely large, synchronization is not possible. In these situations, "SYNC NG" is displayed.

Press SYNC (SHIFT+9) to turn the synchronization function on and off.

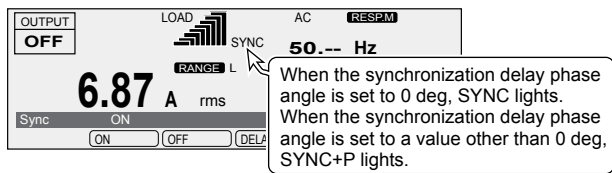

Item	Title	Description	Valid modes
ON	Sync	The synchronization function is enabled. "SYNC" or "SYNC+P" blinks until synchronization is established. After a few seconds, the frequency and the phase are synchronized, "SYNC" or "SYNC+P" lights, and the synchronized frequency is displayed.	AC and AC+DC
OFF		The synchronization function is disabled.	

### Setting the synchronization delay phase angle

Press SYNC (SHIFT+9) and then DELAY (F4) to set the value.

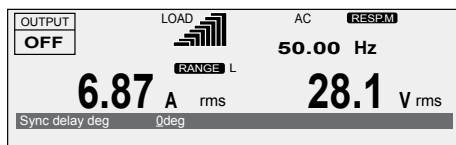

Item	Title	Description	Valid modes
DELAY	Sync delay deg	Sets the synchronization delay phase angle (0 deg to 359 deg)	AC and AC+DC

### The frequency that is used when the synchronization function is cleared

If the frequency when you are using the synchronization function is within the frequency limits, the frequency is set to the 50 Hz or 60 Hz, whichever the PCR-LE2 Series was synchronized to.

If the frequency when you are using the synchronization function is outside the frequency limits, the frequency limit function will be activated.

If the frequency when you are using the synchronization function is lower than the lower limit, the frequency is set to the lower limit.

If the frequency when you are using the synchronization function is higher than the upper limit, the frequency is set to the upper limit.

### Phase

The figure below shows the phase synchronization behavior for different input-wiring and output configurations.

Input wiring	Single-phase output Single-phase, three-wire output	Three-phase output
Single-phase input (PCR6000LE2) 	In-phase with the input 	Three-phase output 
Three-phase, three-wire 200 V input 	In-phase with input 	Three-phase output 
Three-phase, four-wire input 400 V input 	In-phase with input 	Three-phase output 

# Using the Voltage compensation Function

The compensation function compensates for voltage drops in the load cables when the load is connected to the PCR-LE2 Series over a long distance. The PCR-LE2 Series has three types of compensation functions: soft sensing, hard sensing, and regulation adjustment. Use the different compensation functions depending on how you need to use the PCR-LE2 Series.

During single-phase, three-wire output and three-phase output, regulation adjustment is invalid.

## WARNING

### Risk of electric shock.

- Before you connect the load or the sensing cables, turn the POWER switch off, and then turn off the switchboard.
- Firmly attach the terminal box cover.

#### • Hard sensing

Connect the PCR-LE2's internal output voltage compensation point directly across the load. Because compensation is performed in real time, the output voltage can be stabilized at a high speed.

Because the impedance (the combination of the resistance and the inductance) of the power line across the load will be included in the compensation circuit, the power circuit's stability decreases. The PCR-LE2 Series operations may become unstable (for example, it may oscillate) depending on the wiring and the load type. Because the power wires of each phase (L and N) are not paired during single-phase three-wire output or three-phase three-wire output, the operation tends to be more unstable than during single-phase output. If the operations become unstable, use soft sensing.

It is recommended that you use soft sensing if you are using a load that does not require a fast output voltage response speed.

You cannot use hard sensing in the following situations.

- When the output is on
- When you are setting the output impedance (ON)
- When you have selected the normal response speed (MEDIUM).

#### • Soft sensing

The voltage of the sensing point is measured by the PCR-LE2 Series measurement functions, and any insufficiencies in the voltage are automatically compensated for. The performance of the PCR-LE2 Series such as the stability of the voltage, output voltage response to sudden changes in the load current, and waveform quality (distortion ratio) is lower than that available during normal operation.

Even in DC mode, the performance is lower than that available during remote sensing of a normal DC power supply.

The maximum voltage that soft sensing can compensate is "the PCR-LE2 Series' output voltage  $\pm 10\%$ ." The maximum output voltage during compensation is limited by the rated voltage of the PCR-LE2 Series.

If the frequency is less than 40 Hz, soft sensing is disabled.

You cannot use soft sensing in the following situations.

- When the output is on
- When in AC+DC mode
- When you are setting the output impedance (ON)
- When you have configured the PCR-LE2 Series so that it does not turn output off when the current limit is exceeded (DISABLE)
- When you have specified the waveform bank
- When power line abnormality simulations are being performed
- When sequences are being performed
- When soft start is on.

#### • Regulation adjustment

This function calculates the voltage drops that are caused by the output current and increases the output voltage just by the calculated voltage drops.

Use this function when there is a great distance between the PCR-LE2 Series and the load and you want to stabilize the voltage across the load. This function does not require you to connect the sensing cables that the hard sensing and soft sensing functions require.

The performance of the stabilization accuracy, distortion ratio, and response speed of the voltage is lower than the normal performance of the PCR-LE2 Series. Depending on how you are using the PCR-LE2 Series, you may not be able to use this function. Check the operation that you will perform before you use the regulation adjustment function.

The maximum voltage that regulation adjustment can compensate is "the PCR-LE2 Series' output voltage + 10%." The maximum output voltage during compensation is limited by the rated voltage of the PCR-LE2 Series. If the output current is 10% or less of the maximum rated current, the voltage is not compensated.

You cannot use regulation adjustment in the following situations.

- When the output is on
- When in AC+DC mode, in DC mode
- When you are setting the output impedance (ON)
- When you have configured the PCR-LE2 Series so that it does not turn output off when the current limit is exceeded (DISABLE)
- When you have specified the waveform bank
- When power line abnormality simulations are being performed
- When sequences are being performed
- When soft start is on.

## Wiring the hard sensing and soft sensing functions

We recommend that you run the load wires alongside each other and tie them together at several points with cable ties. Connect between the output terminal and load with the shortest wires possible.

The sensing feature can compensate up to 1.5 V for a single line. Select a load cable that has sufficient current capacity to prevent the voltage drop in the cable from exceeding the compensation voltage.

As the PCR-LE2 Series output voltage becomes small, so too does the detected voltage. If the PCR-LE2 Series output voltage is small, reduce the voltage drops in the cables by using cables that have large diameters to wire the load, connecting the load so that the cables are as short as possible, and taking other similar precautions.

### CAUTION

Risk of damage to the product and the load. If the sensing cables become disconnected or the polarities are incorrect, an overvoltage will be generated in the output. The protection function will be activated and the output will be turned off, but an overvoltage will be generated for the several hundreds of milliseconds before the protection function is activated.

On the PCR6000LE2 and PCR9000LE2, pull out the terminal block tray, and then connect the sensing cables.

On the PCR12000LE2, PCR18000LE2, and PCR27000LE2, remove the SENSING terminal cover, and then connect the sensing cables.

Use AWG22 to AWG16 cables when connecting to the sensing terminals. Strip approximately 10 mm of coating from the end of the cables.

The following figure illustrates how to connect sensing cables to the PCR6000LE2 for single-phase output.

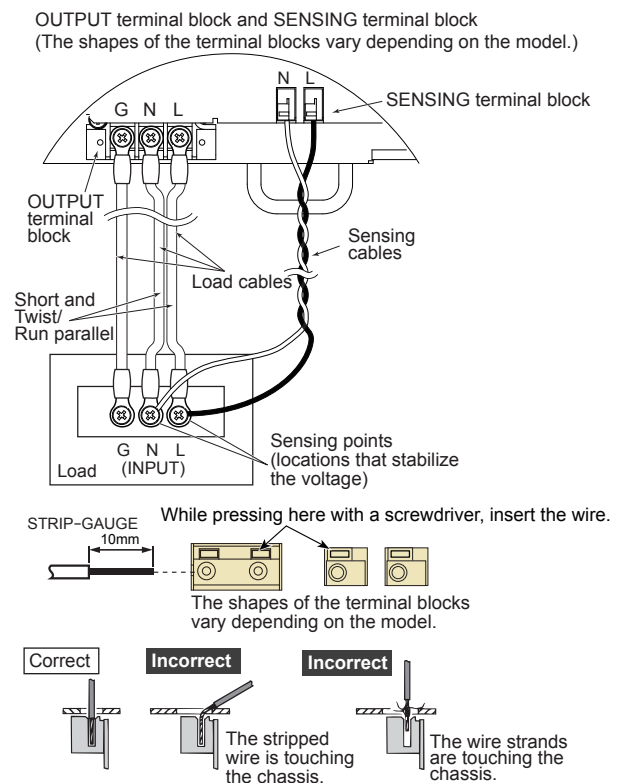

- 1** Check that the **POWER** switch is turned off.
- 2** Check that the **load's power switch is off**.  
If you cannot turn the load off, install a dedicated terminal block for sensing. Do not connect the load to this dedicated terminal block for sensing.
- 3** **Connect the N SENSING terminal to the N terminal on the DUT using sensing cables. In the same way, connect the L SENSING terminal to the L terminal on the DUT.**  
Connect the wiring so that the product is as close to the load as possible.

# Using the Voltage compensation Function (Cont.)

## Wiring the hard sensing and soft sensing functions (Cont.)

- Single-phase output

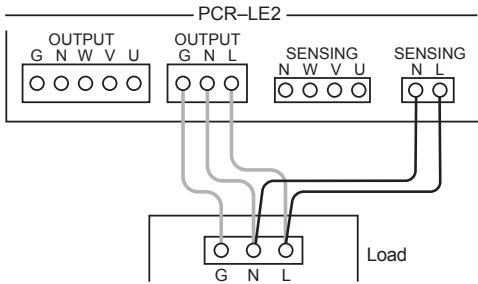

- Single-phase three-wire output

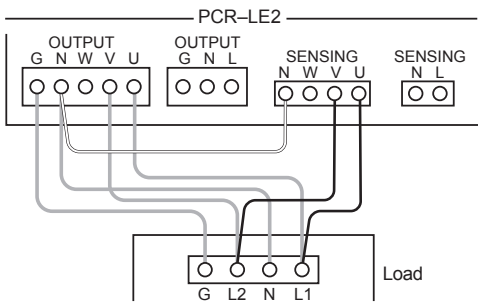

- Three-phase output

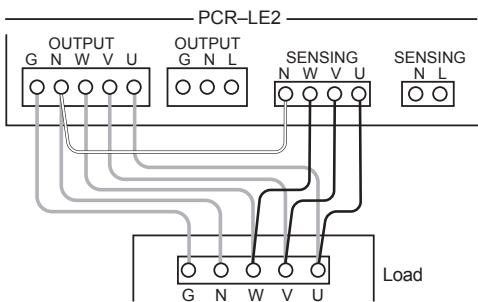

## Wiring the regulation adjustment function

After you finish connecting the load, turn the output on. Then, set the output voltage to the voltage that is required across the load. Because of voltage drops in the load wiring, the voltage across the load is lower than the voltage generated by the PCR-LE2 Series. Use a voltmeter (or other instrument that enables you to measure voltage) to check whether the voltage across the load is the required voltage.

The maximum voltage that regulation adjustment can compensate is "the PCR-LE2 Series' output voltage + 10 %."

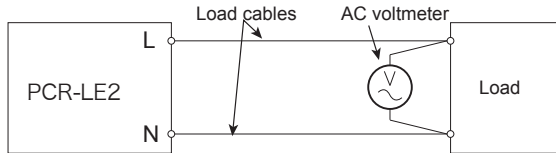

## Compensation function setup procedure

Set the voltage and the frequency that you want to stabilize at the sensing point. In DC mode, set only the voltage. Press OTHER (SHIFT+MEMORY), 1/3 (F6), and then COMPEN (F2) to configure the compensation functions.

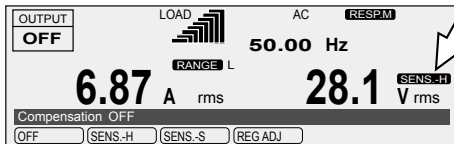
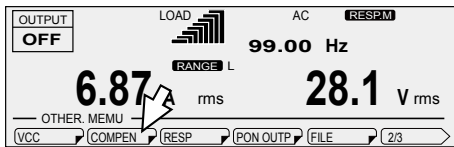

Press ENT to display this.

Item	Title	Description	Conditions in which the function key cannot be used	Valid modes
OFF	Compensation	The compensation (voltage compensation) functions are not used.	None	All
SENS.-H		The hard sensing function is used.	Output: on Output impedance: setting Response: MEDIUM	
SENS.-S		The soft sensing function is used.	Output: on	AC and DC
REG ADJ <sup>*1</sup>		The regulation adjustment function is used. Allow a current to flow through the load. Then, check the voltmeter that is attached across the load, and use the rotary knob to adjust the PCR-LE2 Series voltage to the same value that is displayed.	Output impedance: setting Action to perform when the current limit is exceeded: DISABLE Waveform bank: specified Soft start: on Power supply line error simulation: being performed Sequence: being performed	AC

\*1. Not valid in single-phase three-wire output and three-phase output

If the frequency is less than 40 Hz, soft sensing is disabled. If the output is on and soft sensing is disabled, "SENS" appears on the screen.

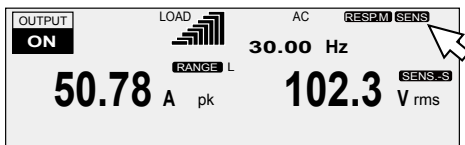

### ■ Adjusting the regulation adjustment function

Press OTHER (SHIFT+MEMORY), 1/3 (F6), and then COMPEN (F2) to select REG ADJ (F4). After you have selected the regulation adjustment function, you have to adjust it.

Allow a current to flow through the load. Then, check the voltmeter that is attached across the load, and use the rotary knob to adjust the PCR-LE2 Series voltage to the same value that is displayed.

After you have finished adjusting the function, press ESC to return to the home position.

## Using the Voltage compensation Function (Cont.)

### Checking the sensing functions (excluding the regulation adjustment function)

When you are using the hard sensing function or soft sensing function, after you finish wiring the sensing cables, check that there are no wiring errors. Turn the load's power switch off before you perform this check.

- 1 Turn the POWER switch on.**
- 2 Set the output undervoltage protection (UVP) to 5 V.**
- 3 Set the output overvoltage protection (OVP) to 20 V.**
- 4 Set the output voltage range to the H range.**
- 5 Set the output voltage to 10 V, and then turn the output on.**
- 6 Check whether a voltage of several tens of volts is being generated.**

An output being generated in this situation indicates that there are connection errors. Check whether the sensing cables are connected and whether the polarities are correct. If the sensing cables are disconnected or the polarities are incorrect, a voltage will be applied across the load (at the sensing point) for approximately one second until the protection function is activated.

If the sensing cables are not firmly connected, an alarm (ALM-07: UVP or ALM-22: SENSING FAILURE) may be generated. If the polarities of the sensing cables are not correct, an alarm (ALM-00: OVP) may be generated. Connect the cables correctly.

If you are installing a dedicated terminal block for sensing, check the sensing function before you connect the load to the terminal block.

# Using Power Line Abnormality Simulations

In AC mode, you can simulate power supply line errors by stopping the PCR-LE2 Series output (to simulate power failures) and decreasing and increasing the voltage (to simulate voltage dips and pops).

You can use this to test switching power supplies and other electronic devices.

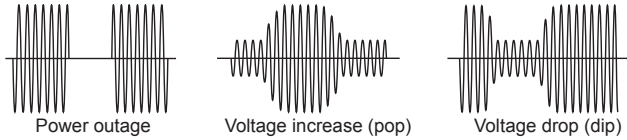

A sine wave is generated during the power line abnormality simulations. Even if you have set a special waveform, a sine wave will be generated as soon as you execute the power line abnormality simulation.

You can set these values while output is on or off.

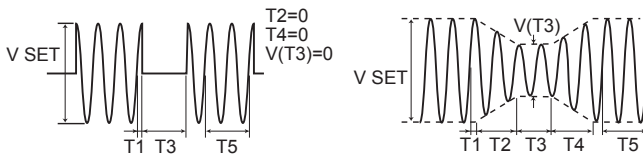

Parameter	Description
T1	This is the voltage regulation start time or the voltage regulation start phase. This is the time or the phase from the waveform's positive zero crossing (the point where the signal crosses the zero axis) to the point where voltage regulations - such as increases or decreases - start to occur.
T2	This is slope time 1. For pops, this indicates how much time is required to raise the voltage to the pop voltage. For dips, this indicates how much time is required to lower the voltage to the dip voltage.
T3	This is the voltage regulation time. For pops, this indicates the length of time that the voltage will be kept at the voltage that it has been raised to (the pop voltage). For dips, this indicates the length of time that the voltage will be kept at the voltage that it has been lowered to (the dip voltage).
T4	This is slope time 2. For pops, this indicates how much time is required to lower the voltage from the pop voltage to the voltage that is in use during the period indicated by T5. For dips, this indicates how much time is required to raise the voltage from the dip voltage to the voltage that is in use during the period indicated by T5.
T5	This is the return time or the number of return cycles. This indicates how long (either as a length of time or as a number of cycles of the present frequency) the voltage will be kept at the level that it returns to after a pop or dip is completed.
T3VOLT	This is regulated voltage. For pops, this is the voltage level that the voltage will be raised to (the pop voltage). For dips, this is the voltage level that the voltage will be lowered to (the dip voltage).
LOOP	This is the number of repetitions. This indicates the number of times that the sequence of steps defined by T1 to T5 will be repeated.

- Memo -

## Voltage regulation start polarity

You can set the zero crossing (the time at which the voltage becomes zero) that will be the reference for T1 to positive zero crossing or negative zero crossing by switching the voltage regulation start polarity (POL). You can use this function to change the phase by 180°. The PCR-LE Series displays the output voltage (waveform) of L of the OUTPUT terminal block, with N as its reference.

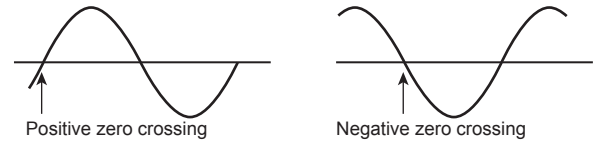

# Using Power Line Abnormality Simulations (Cont.)

## Power line abnormality simulation setup procedure

These settings cannot be made if you are using the synchronization function.

### 1 Set the steady-state voltage and frequency.

### 2 Press SIM and then COND (F4) to set the conditions. After you have finished configuring the settings, press ESC.

A border is displayed around the item that you are setting. Press ▲ (to select the upper item) and ▼ (to select the lower item) to switch between items.

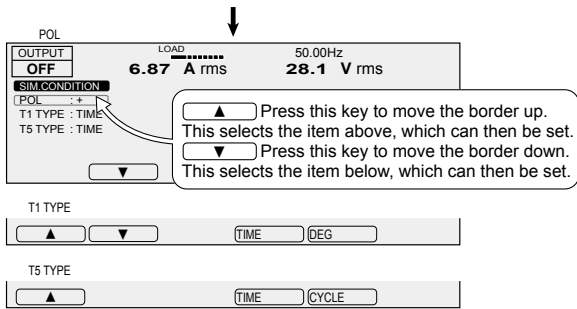
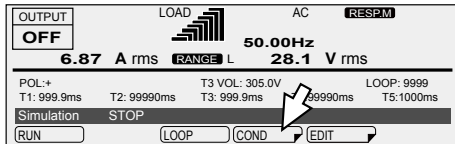

Item	Description	Valid mode
POL	-	AC
	+	
T1 TYPE	TIME	AC
	DEG	
T5 TYPE	TIME	AC
	CYCLE	

### 3 Press EDIT (F5) to set the parameters (T1 to T5 and T3 VOLT). After you have finished configuring the settings, press ESC.

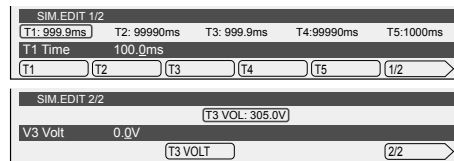
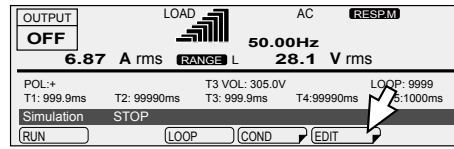

Item	Title	Description	Valid mode
T1	T1 Time	Sets the voltage regulation start time (0.0 ms to 999.9 ms)	AC
	T1 Degree	Sets the voltage regulation start phase (0 deg to 359 deg)	
T2	T2 Time	Sets slope time 1 (0 ms to 99 990 ms)	
T3	T3 Time	Sets the voltage regulation time (0.1 ms to 9 999.0 ms)	
T4	T4 Time	Sets slope time 2 (0 ms to 99 990 ms)	
	T5 <sup>*1</sup>	Sets the return time (0 ms to 99 990 ms)	
	T5 Cycle	Sets the number of return cycles (0 to 999 900)	
T3 VOLT	T3 Volt	Sets the regulated voltage (L range: 0 V to 152.5 V; H range: 0 V to 305.0 V)	

\*1. Depending on how T1 to T4 are set, this may lead or lag by one cycle.  
If you set this to a value that is not an integer multiple of one cycle, the return time will last longer than the time you have specified because the PCR-LE2 Series will wait for a zero crossing during the T1 execution time.

### 4 Select LOOP (F3) to set the number of repetitions.

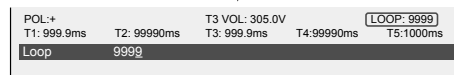
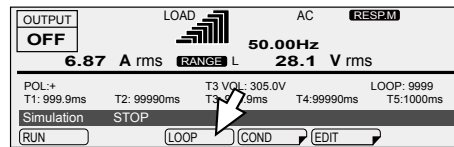

Item	Title	Description	Valid modes
LOOP	Loop	Sets the number of repetitions (1 to 9 999; 9 999 indicates unlimited repetitions)	AC



## Executing and stopping power line abnormality simulations

You cannot execute power line abnormality simulations in the following situations.

- In DC mode or AC+DC mode.
- When you have configured the PCR-LE2 Series so that it does not turn output off when the current limit is exceeded (DISABLE).
- When the regulation adjustment or soft sensing compensation function is in use.
- When the L range is selected and T3 VOLT is set to a value outside of its range.
- When T3 VOLT is set to a value outside the voltage limits.

### 1 Press OUTPUT to turn output on.

### 2 Press SIM and then RUN (F1) to execute a power line abnormality simulation.

During execution, press STOP (F1) to stop the simulation.

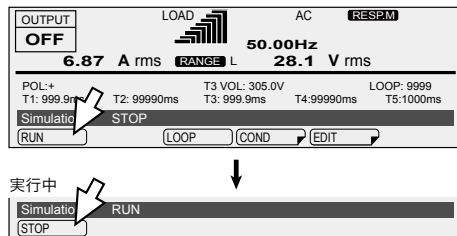

### ■ Status signals

Status signals are only generated during the periods defined by T2, T3, and T4 (period T3 when T2 and T4 both equal zero).

Signals are generated from the SEQ STAT OUT terminal (a BNC connector) on the rear panel of the PCR-LE2 Series. Use the configuration settings to set the signal polarity. "H" is approximately 5 V. "L" is approximately 0 V.

The BNC connector is isolated from the PCR-LE2 Series' INPUT and OUTPUT terminal blocks. However, the common line of the TRIG and STAT signals is shared internally, so it is not isolated from the BNC connector. Also, the BNC connector is not isolated from the SLOT internal circuits. There is a slight time difference (approximately 100 ms) between the status signal output and changes to the actual output.

Status signals may be output when you change the settings of the various parameters.

Press CONFIG (SHIFT+OPR MODE) and then SIG.I/O (F3) to set the status output polarity. The status signal polarity setting is shared with the sequence function.

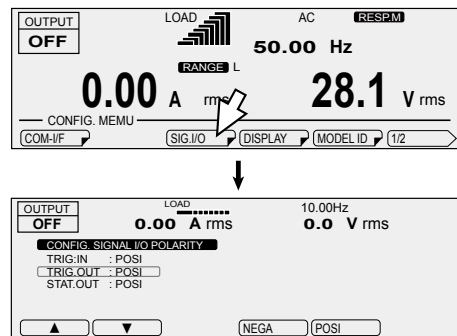

Item	Description	
STAT.OUT	NEGA	Sets the status output to low level
	POSI	Sets the status output to high level

# Using the Sequence Function

## Sequence overview

A sequence is a series of settings—values such as the output voltage, frequency, and time—that are saved in advance and are then recalled and automatically carried out in order at a later time.

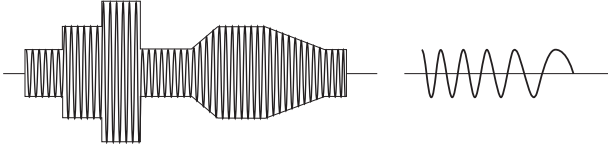

Sequences are groups of executable units called steps. When a sequence is executed (run), its steps are executed in order, starting with the specified starting step. A single execution of a sequence is completed after the sequence's specified last step has been executed.

You can use the jump function to skip steps and repeatedly execute all the steps in the sequence except for those that have been skipped.

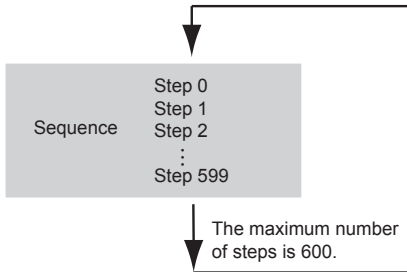

First, set the starting step, and then set the sequence conditions.

If the last step of a sequence does not turn the output off, the output will remain on when the sequence is complete.

### Step's signal change (ramp)

To change the frequency or voltage linearly over the specified time, select "RAMP ON." To change the value as a step, select "RAMP OFF."

If you specify "RAMP ON" in step 0, the signal will change linearly from the current voltage or frequency.

When the ramp is off

When the ramp is on

STEP	FREQ	AC VOL
000	50.00Hz	100.0V
001	60.00Hz	132.0V
002	100.0Hz	85.0V
003	200.0Hz	30.0V

Freq: 50.00Hz

RAMP OFF RAMP ON

#### Signal change of voltage

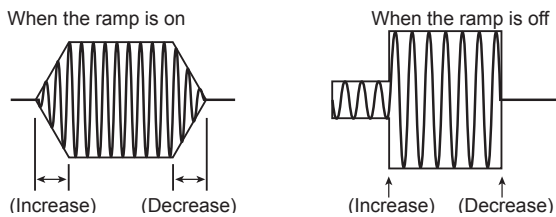

#### Signal change of frequency

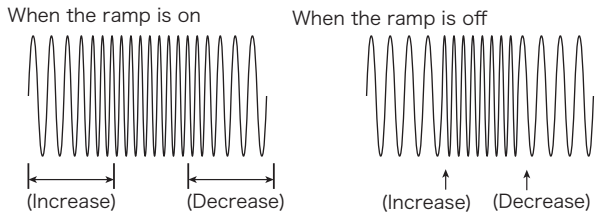

#### Signal change of phase

During three-phase output (optional), you can set the phase ramp (leading or lagging). This is effective for varying the line voltage.

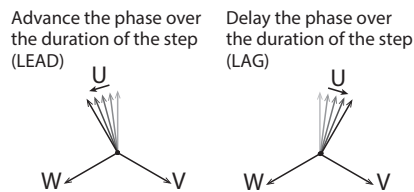

### Signal output and Resuming

If the status signal is enabled, a status signal will be output while a step is being executed.

If the trigger signal output is enabled, a signal is output for several tens of microseconds when a step is executed.

You can apply a trigger signal to resume a paused sequence.

## Starting phase angle and the ending phase angle

Steps are managed in terms of time.

If you set the starting phase angle, steps will start from the specified phase angle.

Phase wait time is the duration from the point when the step time of the last step has elapsed to the point where the phase angle reaches the starting phase angle. The phase wait time is dependent on frequency.

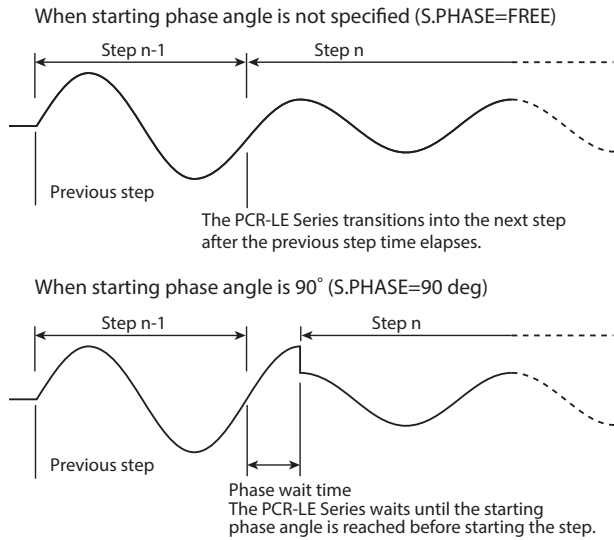

If you set the ending phase angle, the PCR-LE2 Series will end the step when the specified phase is reached.

Phase wait time is the duration from the point when the step time has elapsed to the point where the phase angle reaches the ending phase angle. The phase wait time is dependent on frequency.

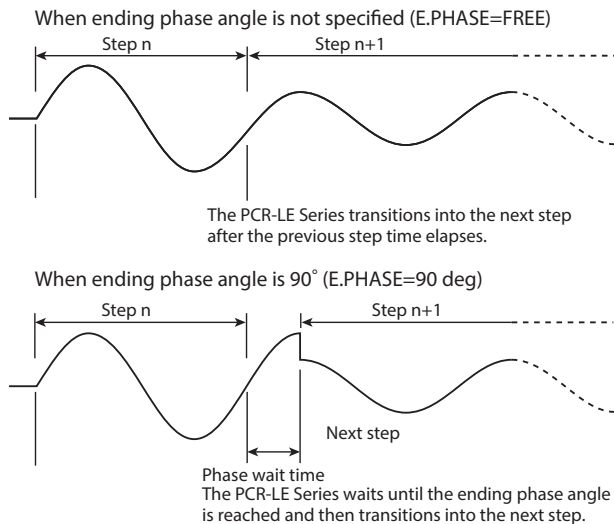

You can output the same waveform regardless of whether you set the starting phase angle or the ending phase angle.

When a waveform is to be output continuously (the phase does not change suddenly) and you set both the starting and ending phase angles, the waveform may be offset by one period. To avoid confusion, we recommend that you set the starting phase angle and not the ending phase angle (FREE).

## Display and signal output during the phase wait time

During the phase wait time, the screen shows the next step number. The elapsed time remains at zero until the next step starts.

The status signal is output while the waveform of the step that is enabled is being output.

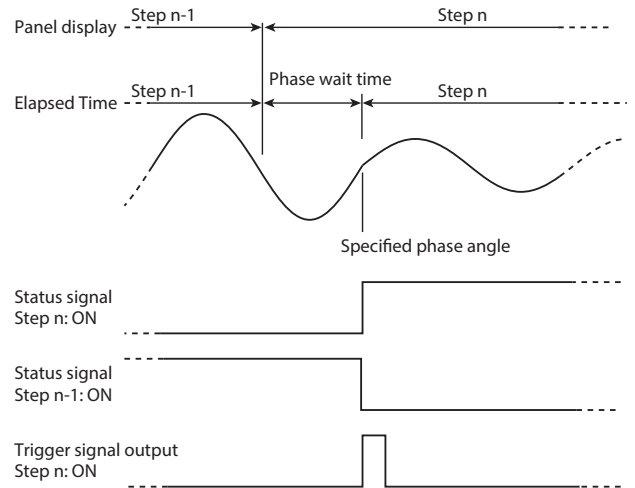

## Sudden phase change

If you set both the starting and ending phase angles and specify phase change, the phase will change suddenly.

If you set sudden phase change to ON, you can switch between two steps according to the set phase angles. For example, if you set the step n-1's ending phase angle to 90°, the step n's starting phase angle to 270°, and set sudden phase change to ON, when the step time of step n-1 elapses and 90° is reached, a transition is made to step n (270° phase angle).

## Jump function

The steps in a sequence are normally executed in order starting with the starting step. However, you can use the jump feature to skip over steps and repeat sets of steps by repeatedly executing jumps.

## Sequence tutorial

Appendix A in the supplied CD-R operation manual contains sequence tutorials that explain sequence creation basics, phase angle settings, sudden phase changes, and multi-phase operation.

# Using the Sequence Function (Cont.)

## Editing steps

These settings cannot be made if you are using the synchronization function.

There are six types of step editing screens (seven types for single-phase, three-wire output and three-phase output).

Press SEQ (SHIFT+SIM) and then EDIT (F5) to display the step editing screen.

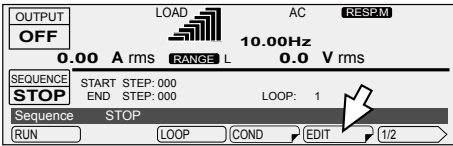

### Items that are common between screens 1/5 to 5/5

A border is displayed around the step or item that you are setting. First use the rotary knob to specify the step that you want to configure, and then configure its settings.

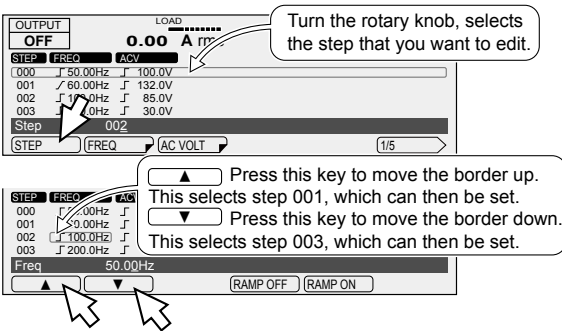

Item	Title	Description
STEP	STEP	Sets the step (0 to 599) that you want to configure
▼	--	Sets the next step as the one that you want to configure
▲	--	Sets the previous step as the one that you want to configure

### 1: Frequency and AC voltage

Use this screen to set the frequency and the AC voltage. The step signal change can also be set for the frequency and the AC voltage.

In AC+DC mode, the step's AC voltage and output voltage can each be set within their own setting range. If the peak AC+DC output voltage exceeds the PCR-LE2 Series' rated output voltage, the output voltage waveform (the peak section) may be distorted (clipped).

During single-phase, three wire output and three-phase output (optional), if you are setting the phases separately, press AC VOLT (F2) to first set all the phases at the same time, and then press ACV V (F4) and ACV W (F5) to set the V phase and W phase, respectively. The AC voltage signal change is shared between all phases.

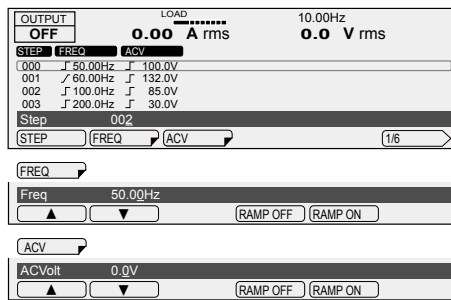

Item	Title	Description	Valid modes
FREQ	Freq	Sets the step's frequency (1.00 Hz to 999.9 Hz)	AC and AC+DC
	RAMP OFF	Disables the ramped frequency signal change	
	RAMP ON	Enables the ramped frequency signal change	
ACVOLT <sup>1</sup>	ACVolt AC PhaseVolt <sup>1</sup>	Sets the step's AC voltage (0.0 V to 305.0 V)	
	RAMP OFF	Disables the ramped AC voltage signal change	
	RAMP ON	Enables the ramped AC voltage signal change	
ACV V <sup>3</sup>	AC V PhaseVolt	Sets the step's AC voltage (0.0 V to 305.0 V) (V phase)	AC and AC+DC
	RAMP OFF <sup>4</sup>	Disables the ramped AC voltage signal change	
	RAMP ON <sup>4</sup>	Enables the ramped AC voltage signal change	
ACV W <sup>5</sup>	AC W PhaseVolt	Sets the step's AC voltage (0.0 V to 305.0 V) (W phase)	
	RAMP OFF <sup>4</sup>	Disables the ramped AC voltage signal change	
	RAMP ON <sup>4</sup>	Enables the ramped AC voltage signal change	

\*1. During single-phase, three-wire output and three-phase output, all phases are set at the same time. Set the voltage using phase voltage.

\*2. The display during single-phase, three-wire output and three-phase output

\*3. Single-phase three-wire output or three-phase output only

\*4. This is shared between all phases. You cannot set it for each phase.

\*5. Three-phase output (optional) only

## ■ 2: Execution time, waveform bank, and output

Use this screen to set the step execution time, the waveform bank, and the output.

STEP	TIME	WB NO.	OUTPUT
000	0:00:03.0000	0	ON
001	0:00:03.0000	0	ON
002	0:00:03.0000	0	ON
003	0:00:03.0000	0	ON

Step: 002

TIME: Time(SEC) 3

WB NO.: WB No. 0

OUTPUT: Output ON

Item	Title	Description	Valid modes
TIME	HOUR	Time(HOUR)	All
	MIN	Time(MIN)	
	SEC	Time(SEC)	
	100US	Time(100us)	
WB NO	WB No.	Sets the waveform bank and number that you want to use (0 to 63)	AC and AC+DC
OUTPUT	OFF	Output	All
	ON	Turns the output on	

## ■ 3: DC voltage

Use this screen to set the DC voltage. The step signal change can also be set for the DC voltage.

In AC+DC mode, the step's AC voltage and output voltage can each be set within their own setting range. If the peak AC+DC output voltage exceeds the PCR-LE2 Series' rated output voltage, the output voltage waveform (the peak section) may be distorted (clipped).

If you are setting the voltage of each phase separately for three-phase output, press DCV (F2) to first set all the phases at the same time, and then press DCV V (F4) and DCV W (F5) to set the V phase and W phase, respectively. The DC voltage signal change is the same for all phases.

STEP	DCV	RAMP
000	100.0V	OFF
001	-100.0V	OFF
002	431.0V	OFF
003	-431.0V	OFF

Step: 000

DCV: DC Volt 0.0V

RAMP: RAMP OFF, RAMP ON

Item	Title	Description	Valid modes
DCV <sup>*1</sup>	DC Volt	Sets the step's DC voltage (0.0 V to ±431.0 V)	DC and AC+DC
	DC Phase-Volt <sup>*2</sup>	Disables the ramped DC voltage signal change	
	RAMP OFF	Enables the ramped DC voltage signal change	
DCV V <sup>*3</sup>	DC V Phase-Volt	Sets the step's DC voltage (0.0 V to ±431.0 V) (V phase)	AC+DC
	RAMP OFF*4	Disables the ramped DC voltage signal change	
	RAMP ON*4	Enables the ramped DC voltage signal change	
DCV W <sup>*5</sup>	DC W Phase-Volt	Sets the step's DC voltage (0.0 V to ±431.0 V) (W phase)	AC+DC
	RAMP OFF*4	Disables the ramped DC voltage signal change	
	RAMP ON*4	Enables the ramped DC voltage signal change	

\*1. For single-phase, three-wire output, set the U phase voltage (the V phase is automatically set to the same amplitude as the U phase but with opposite polarity).

For three-phase output, set the phase voltage of all phases at once.

\*2. The display during single-phase, three-wire output and three-phase output

\*3. Three-phase output only.

\*4. This is shared between all phases. You cannot set it for each phase.

\*5. Three-phase output only.

# Using the Sequence Function (Cont.)

## Editing steps (Cont.)

### ■ 4: Status output, trigger output, and waiting trigger (pause)

#### ⚠ WARNING

**Risk of electric shock. Use the BNC connector with an isolation voltage of 63 V<sub>peak</sub> or less.**

Use this screen to set the Status output, trigger output, and waiting trigger.

Use the configuration settings to set the signal polarity. -> p57

During single-phase, three-wire output or three-phase output, apply signals to and output signals from the U-phase unit.

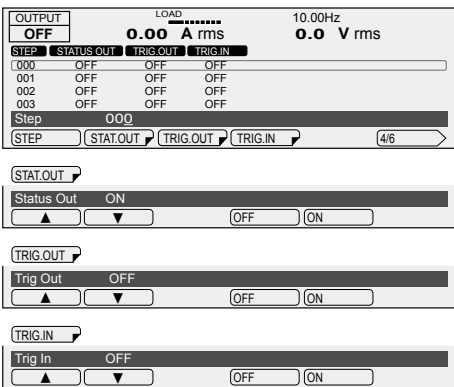

Item		Title	Description
STAT.OUT	OFF	Status Out	Turns status output off
	ON		Turns status output on
TRIG.OUT	OFF	Trig Out	Turns trigger output off
	ON		Turns trigger output on
TRIG.IN*1	OFF	Trig In	Makes the PCR-LE2 Series not wait for triggers
	ON		Makes the PCR-LE2 Series wait for triggers (pause)

\*1. In the same step, do not turn on both the trigger wait setting and the sudden phase change setting (PHAS.CHG). If you do, the sequence cannot be executed.

The BNC connector is isolated from the PCR-LE2 Series' INPUT and OUTPUT terminal blocks. The common line of the TRIG and STAT signals is shared internally, so it is not isolated from the BNC connector.

The remote control function (excluding LAN remote control) also shares this common line. If you are using a desktop PC to control the PCR-LE2 Series remotely, the communication signal line of the PC is grounded, so the BNC connector will also be set to ground potential. If the signal line that is connected to the BNC connector has an electrical potential compared to ground, the connected device or the PCR-LE2 Series may be damaged when a current flows through the signal line.

There is a slight time difference (approximately 100 μs) between the trigger signal output and changes to the actual output.

Trigger signals may also be output when you change the contents of a sequence.

For signal I/O, high level signals are approximately 5 V, and low level signals are approximately 0 V. For signal input, opening the terminal is equivalent to applying a high level signal, and shorting the input is equivalent to applying a low level signal.

During single-phase, three-wire output or three-phase output

(optional), apply signals to and output signals from the U-phase unit.

#### • Status signal output (STAT.OUT)

Status signals are only output during the time when the step's waveform is being output.

If you set STAT.OUT to "ON," signals are generated from the SEQ STAT OUT terminal (a BNC connector) on the rear panel of the PCR-LE2 Series.

#### • Trigger signal output (TRIG.OUT)

Trigger signals are output during the step's execution time.

If you set TRIG.OUT to "ON," signals are generated from the SEQ TRIG OUT terminal on the rear panel of the PCR-LE2 Series for several tens of microseconds.

#### • Waiting trigger (TRIG.IN)

If set to "ON," the sequence will be paused after the previous step is finished, and the PCR-LE2 Series will wait for a trigger. If a trigger signal (pulse width of at least 10 μs) is received through the SEQ TRIG IN terminal, the paused is released, and the step is executed.

While waiting for the trigger, the screen shows the next step number. The elapsed time remains at zero until the next step starts.

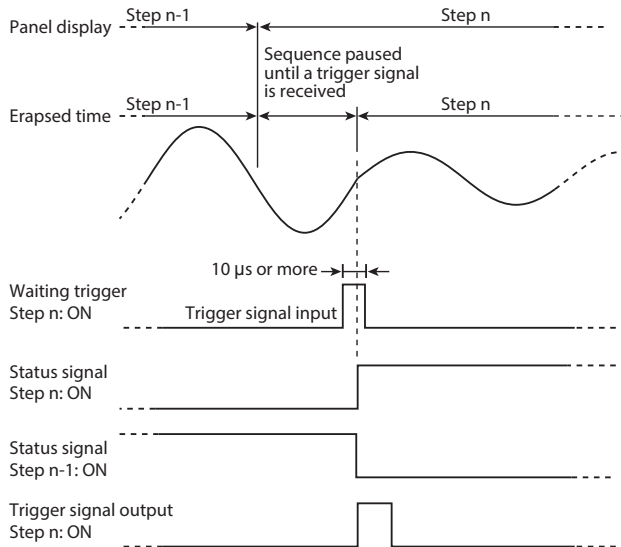

## ■ 5: Jump function

Use this screen to set the step type, jump destination step, and number of times to jump.

OUTPUT	LOAD	10.00Hz	
OFF	0.00 A rms	0.0 V rms	
STEP	TYPE	JUMP STEP	JUMP COUNT
000	NORM	0	1
001	NORM	0	1
002	NORM	0	1
003	NORM	0	1
Step	000		
STEP	TYPE	JUMP STEP	JUMP CNT
			5/6
TYPE			
Step Type NORM			
▲ ▼ (NORM) (JUMP)			
JUMP STEP			
Jump Step 000			
▲ ▼			
JUMP CNT			
Jump Count 1			
▲ ▼			

Item		Title	Description
TYPE	NORM	Step Type	After this step is completed, the subsequent step will be executed.
	JUMP		After this step is completed, the specified step will be executed.
JUMP STEP		Jump Step	Sets the jump destination step (0 to 599)
JUMP CNT		Jump Count	Sets the number of jump repetitions (1 to 99 999; 99 999 indicates unlimited repetitions)

## Jump function

The steps in a sequence are normally executed in order starting with the starting step. However, you can use the jump feature to skip over steps and repeat sets of steps by repeatedly executing jumps.

If the step execution time of the jump origin or jump destination step is less than 500 ms, the peaks of the output voltage waveform of the step that will be executed next may be clipped.

The PCR-LE2 Series automatically adjusts the power supply voltage (Vcc) of the linear amplifier. If you set the execution time of the jump origin step to a value less than 500 ms, the PCR-LE2 Series cannot perform this automatic adjustment. If the peaks of the output voltage waveform are clipped, set the execution time of the previous step to 500 ms or greater, or fix the internal Vcc.

### • Example of not using the jump function

If you set TYPE to "NORM," both JUMP and JUMP CNT will be disabled.

Step	TYPE	JUMP	JUMP CNT
1 to 8	NORM	0	1

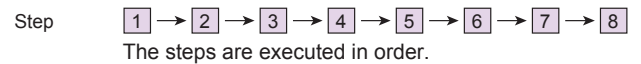

### • Example of using the jump function (with no repetitions)

Step	TYPE	JUMP	JUMP CNT
1, 2, and 4 to 8	NORM	0	1
3	JUMP	6	1

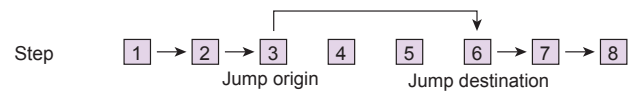

The execution jumps over steps 4 and 5.  
The step execution order is 1→2→3→6→7→8.

### • Example of using the jump function (with repetitions)

Step	TYPE	JUMP	JUMP CNT
1 to 5, 7, and 8	NORM	0	1
6	JUMP	3	3

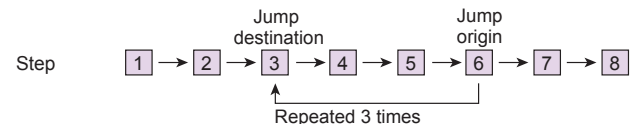

The execution jumps from step 6 to step 3.  
The step execution order is  
1→2→3→4→5→6→3→4→5→6→3→4→5→6→3→4→5→6→7→8

# Using the Sequence Function (Cont.)

## Editing steps (Cont.)

### ■ 6: Starting phase angle, ending phase angle, sudden phase change, and output impedance

Use this screen to set the starting phase angle, ending phase angle, sudden phase change, and output impedance.

OUTPUT	LOAD	10.00Hz		
OFF	0.00 A rms	0.0 V rms		
STEP	START PHASE	END PHASE	PHASE CHANGE	OUTPUT IMPEDANCE
000	FREE	FREE	OFF	OFF
001	FREE	FREE	OFF	OFF
002	FREE	FREE	OFF	OFF
003	FREE	FREE	OFF	OFF
Step	000			
(STEP)	(S.PHASE)	(E.PHASE)	(PHAS. CHG)	(OUT IMP.)
<b>S.PHASE</b>				
Start Phase	FREE		(FREE)	(FIXED)
<b>E.PHASE</b>				
End Phase	FREE		(FREE)	(FIXED)
<b>PHAS. CHG</b>				
Phase Change	OFF		(OFF)	(ON)
<b>OUT IMP.</b>				
Out Z	OFF		(OFF)	(ON)

Item		Title	Description
S.PHASE	FREE	Start Phase	Does not set the starting phase angle
	FIXED		Sets the starting phase angle (0 deg to 359 deg)
E.PHASE	FREE	End Phase	Does not set the ending phase angle
	FIXED		Sets the ending phase angle (0 deg to 359 deg)
PHAS. CHG*1	OFF	Phase Change	Does not set the sudden phase change
	ON		Sets the sudden phase change
OUT IMP.	OFF	Out Z	Does not set the output impedance
	ON		Sets the output impedance (output resistance as a percentage: 1 % to 100 %)

\*1. In the same step, do not turn on both the trigger wait setting (TRIG.IN) and the sudden phase change setting. If you do, the sequence cannot be executed.

- Memo -

Setup example for making sudden phase changes

Appendix A in the supplied CD-R operation manual contains sequence tutorials that explain sequence creation basics, phase angle settings, sudden phase changes, and multi-phase operation.

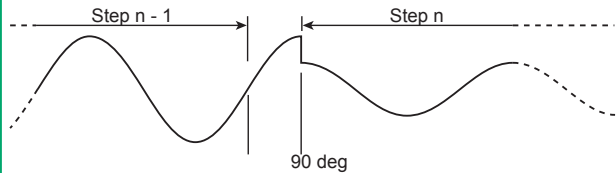

First, set the ending phase angle of the step immediately before the sudden phase change to 90 deg. If the sudden phase change is set to off, the sequence moves to the next step when the phase angle reaches 90 deg after the step time of the previous step elapses, as shown below.

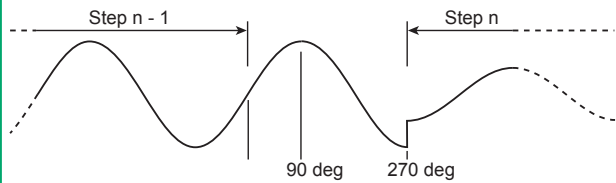

Lastly, set the sudden phase change to on. When the phase angle of the previous step reaches 90 deg, the sequence changes to the next step. The next step begins at 270 deg.

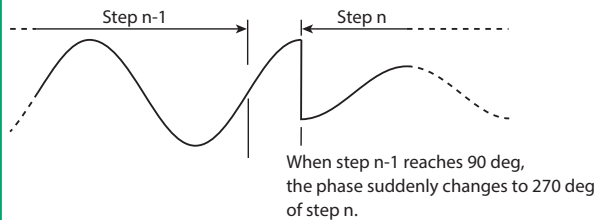



## 7 Setting the phase difference during single-phase, three-wire output and three-phase output

Set the phase difference from the U phase that is used when the PCR-LE2 Series switches to the next step.

Set this when only one or two phases are to change suddenly or when performing a phase sweep.

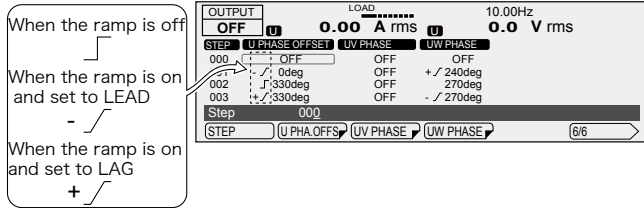
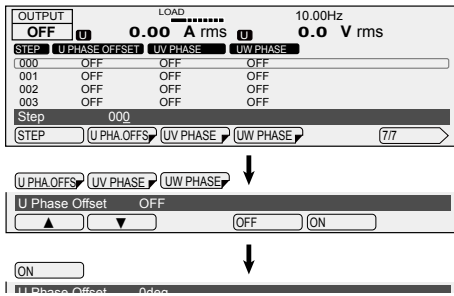

When the ramp is off  
 When the ramp is on and set to LEAD  
 - /  
 When the ramp is on and set to LAG  
 + /

Item	Setting	Title	Description
U PHA. OFFS	OFF	U Phase Offset	The U phase offset is not set.
	ON		Sets the U phase offset (0 deg to 359 deg).
	RAMP LEAD		Sets the U phase change to leading.
	RAMP LAG		Sets the U phase change to lagging.
UV PHASE	OFF	UV Phase	The phase difference between U and V is not set. There is no change from the previous step.
	ON		Sets the phase difference between U and V (0 deg to 359 deg).
	RAMP LEAD		Sets the V phase change to leading.
	RAMP LAG		Sets the V phase change to lagging.
UW PHASE	OFF	UW Phase	The phase difference between U and W is not set. There is no change from the previous step.
	ON		Sets the phase difference between U and W (0 deg to 359 deg).
	RAMP LEAD		Sets the W phase change to leading.
	RAMP LAG		Sets the W phase change to lagging.
	RAMP OFF		Disables the ramped U phase change.
	RAMP OFF		Disables the ramped V phase change.
	RAMP OFF		Disables the ramped W phase change.

\*1. Three-phase output only

### U phase offset setting.

If you set the U phase offset, the U phase will be offset from the reference phase. As a result, the U-V/U-W phase difference settings will be offset from the actual phase difference.

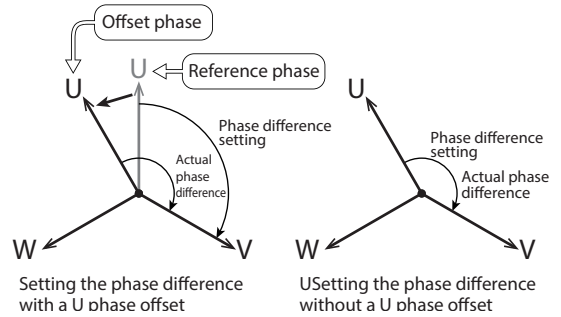

To avoid confusion, we recommend that you turn off the U phase offset when you use the phase sweep feature. For details, see "Phase setting for multi-phase output" in the sequence tutorial of the appendix.

### Ramp setting

Phase ramp can be set to leading (LEAD) or lagging (LAG). This is effective for varying the line voltage.

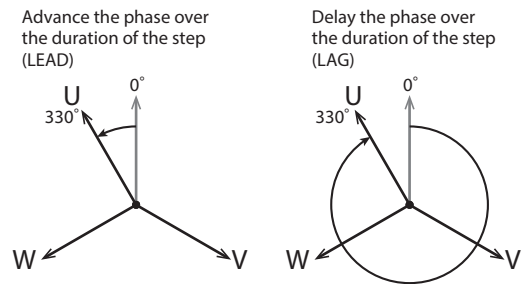

Set an absolute angle for the phase angle.

For details, see "Phase sweep" in the sequence tutorial of the appendix.

# Using the Sequence Function (Cont.)

## Setting sequence conditions

The items that you set here are shared between all steps.

### Setting the starting step number and the ending step number

On the sequence screen, press COND (F4) to set the starting step number and the ending step number.

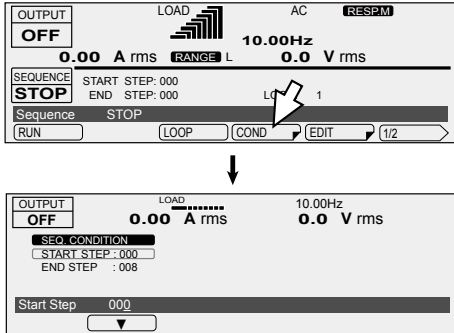

Item	Title	Description
START STEP	Start Step	Sets the starting step number (0 to 599)
END STEP	End Step	Sets the ending step number (0 to 599)

### Setting the number of repetitions

On the sequence screen, press LOOP (F3) to set the number of times that the sequence will be repeated.

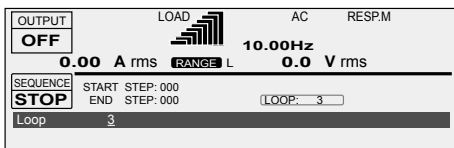

Item	Title	Description
LOOP	Loop	Sets the number of repetitions (1 to 99 999; 99 999 indicates unlimited repetitions)

### Setting the polarity of trigger and status output

Press CONFIG (SHIFT+OPR MODE) and then SIG.I/O (F3) to set the trigger input polarity, the trigger output polarity, and the status output polarity. The status signal polarity setting is shared with that of the power line abnormality simulation function.

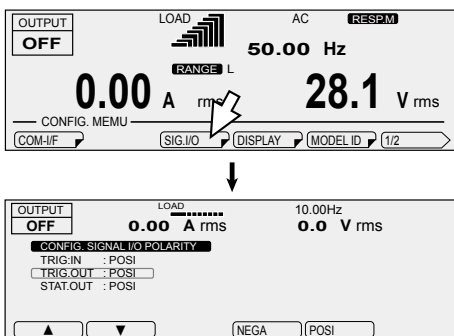

Item	Description	
TRIG.IN	NEGA	Sets the trigger input to falling edge
	POSI	Sets the trigger input to rising edge
TRIG.OUT	NEGA	Sets the trigger output to falling edge
	POSI	Sets the trigger output to rising edge
STAT.OUT	NEGA	Sets the status output to low level
	POSI	Sets the status output to high level

## Executing, pausing, and stopping sequences

After you have finished setting the steps and the sequence conditions, you can execute the sequence.

On the sequence screen, press "RUN" (F1) to execute the sequence.

You cannot execute the sequence in the following situations.

- When the voltage range is set to the L range and there is a step whose voltage exceeds the output voltage setting range (Switch the range to the H range, or set the output voltage so that it is within the L range).
- When you have configured the PCR-LE2 Series so that it does not turn output off when the current limit is exceeded (DISABLE).
- When the regulation adjustment or soft sensing compensation function is in use.
- When the L range is selected and a step's ACVolt or DCVolt setting is outside of the L range.
- When the voltage or frequency is set to a value outside the corresponding limits.
- If there is a step where the trigger wait setting (TRIG.IN) and the sudden phase change setting (PHAS.CHG) are both turned on.

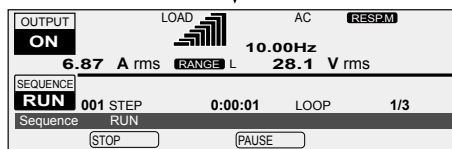
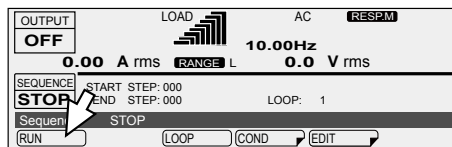

While a sequence has been paused

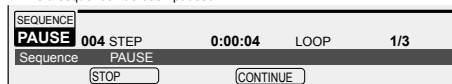

Item	Title	Description
STOP	Sequence	Stops a sequence that is being executed
PAUSE		Pauses a sequence that is being executed
CONTINUE		Resumes a sequence that has been paused

You can also resume the execution of a sequence that has been paused by applying a trigger signal to the SEQ TRIG IN terminal.

## Using the Harmonic Current Analysis Function

A sequence is complete when all steps are complete. The output state when the sequence is complete is the state specified in the last step.

If you want the output to turn off when the sequence is complete, you need to add a last step that turns the output off.

If the U phase is offset in the last step of the sequence (option), the offset (the U PH OFS icon) will remain even when the sequence is complete. Be sure to press 1/2 and then U PHASE on the sequence screen to clear the offset. The icon will disappear when you clear the offset.

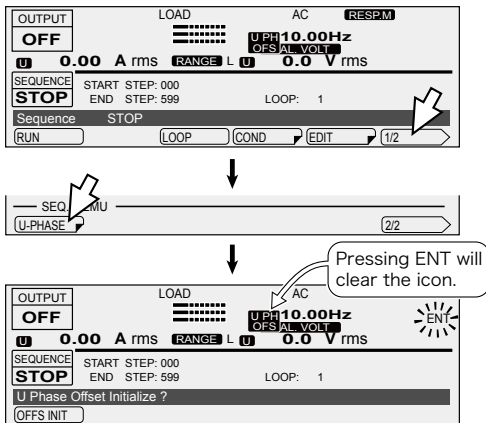

You can perform harmonic analysis of the output current. A simplified measurement method is used, so this method does not conform to standards such as IEC. For measurements that conform to the standards, use the Harmonic/Flicker Analyzer KHA3000.

If the period is set greater than the aperture time, correct measurements cannot be made.

The harmonic current analysis function is valid in AC mode.

Press OTHERS (SHIFT+MEMORY) and then FFT (F5) to set the order and the unit.

During single-phase, three-wire output or three-phase output (optional), press OTHERS (SHIFT + MEMORY), FFT (F5), and then 1/2 (F6), and then press the key that corresponds to the phase that you want to set.

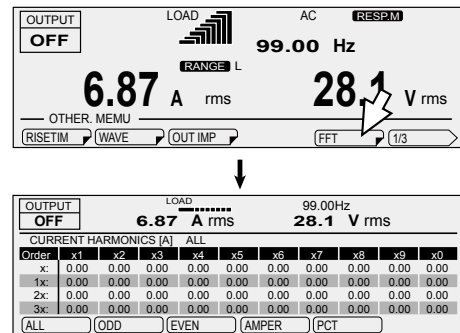

Item	Description	Valid mode
ALL	Selects all the orders	AC
ODD	Selects all the odd-numbered orders	
EVEN	Selects all the even-numbered orders	
AMPER	Sets the unit that is used to display the harmonic components when the harmonic component of each order is being displayed as a current	
PCT	Sets the unit that is used to display the harmonic components when the harmonic current is being displayed as a percentage with 100 % representing a current that has no harmonic current components	
U <sup>1</sup>	Selects the U phase	
V <sup>1</sup>	Selects the V phase	
W <sup>2</sup>	Selects the W phase	

\*1. Single-phase three-wire output and three-phase output only

\*2. Three-phase output only

# Generating Special Waveforms (Waveform bank)

You can generate peak-clipped sine waveforms. This is valid in AC mode and AC+DC mode.

You can use remote control to configure user-defined waveforms. For details, see the Communication Interface Manual on the included CD-R.

The PCR-LE2 Series creates reference waveforms for output voltage by performing D/A conversion on the data that is stored in its internal memory. One cycle (phase angle of 360°) consists of 10 horizontal bits and 14 vertical bits.

The reference voltage waveform of the PCR-LE2 Series is a sine wave. A sine wave whose positive peak is 8191 and negative peak is -8191 is assigned.

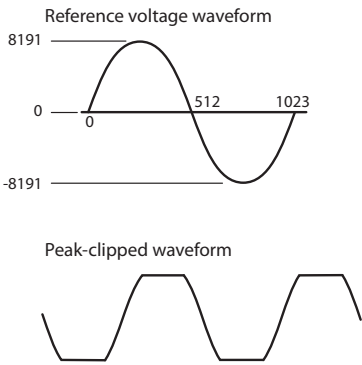

### • Waveform bank

The stored waveform data in memory that corresponds to one waveform is referred to as a waveform bank. The PCR-LE2 Series has 64 waveform banks. Each bank is assigned a number from 0 to 63, which is used to select the waveform. Waveform bank 0 contains a sine wave that is used as the PCR-LE2 Series' reference voltage waveform. This waveform bank cannot be overwritten. In the factory default settings, all waveform banks have the same waveform (sine wave) as the one that is stored in waveform bank 0.

### • Crest factor

The crest factor is the ratio of the AC waveform's peak value to its rms value.

$$\text{Crest factor} = \text{peak value} / \text{rms value.}$$

For a sine wave, the crest factor is 1.41. In the voltage waveforms of commercial power lines, the peaks are clipped, so the crest factor is between 1.2 and 1.4.

These settings cannot be made if you are using the synchronization function.

When you turn the power off, the waveform banks from number 24 to number 63 are set to the factory default setting (a sine wave). Save these waveform banks to a USB memory device as necessary before you turn the power off.

During single-phase, three-wire output and three-phase output (optional), the same waveform is assigned to all phases.

Press OTHERS (SHIFT+MEMORY), WAVE (F2), and then EDIT (F5) to select the waveform (sine wave or peak clipped).

Item	Title	Description	Valid modes
EDIT	WB No.	Edit WB No.	AC and AC+DC
	SIN	Edit WB No.	
	P.C	Edit WB No.	

## ■ Generating special waveforms

You can generate special waveforms while output is on or off.

When you have selected the regulation adjustment or soft sensing compensation function, you cannot change the number of the waveform bank that you want to execute.

Press OTHERS (SHIFT+MEMORY), WAVE (F2), and then WB No. (F1) to select the number of the waveform bank that you want to execute.

Item	Title	Description	Valid modes
WB No.	WB No.	Specifies the number of the waveform bank that you want to execute	AC and AC+DC

If the output is on, the selected waveform will be generated. If the output is off, press OUTPUT to turn the output on and generate the selected waveform.

## Setting the Output Impedance

The PCR-LE2 Series' output impedance (output resistance) is approximately  $0\ \Omega$ . Commercial power supplies have an impedance (resistance) of several milliohms to several ohms. You can set the PCR-LE2 Series' output impedance. This enables you to simulate the same environment as that which is provided by commercial power supplies.

The impedance that is required for IEC standard tests has a prescribed inductance component, but the output impedance of the PCR-LE2 Series consists entirely of resistance. You can use the PCR-LE2 Series to perform rough harmonic current analyses. If you require accurate data, use the Line Impedance Network (LIN Series).

Press OTHERS (SHIFT+MEMORY) and then OUT IMP (F3) to set the output impedance.

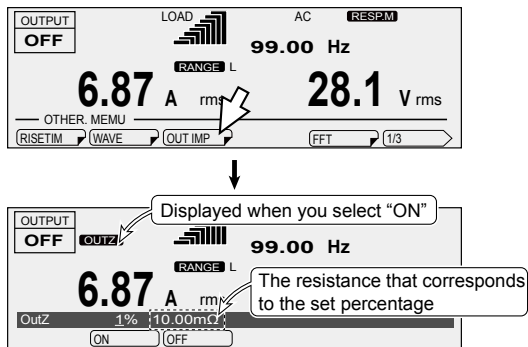

Item	Title	Description	Condition in which the function key cannot be used
ON	OutZ	Sets the output impedance as a percentage (1 % to 100 %). The output impedance will be set.	Compensation function: any setting but "OFF"
OFF		The output impedance will not be set.	None

The values in the following table are assigned to the output resistance percentages (1% to 100%).

	Single-phase output		Single-phase three-wire output Three-phase output	
	L range	H range	L range	H range
PCR600LE2	0 $\Omega$ to 0.333 $\Omega$	0 $\Omega$ to 1.333 $\Omega$	0 $\Omega$ to 1 $\Omega$	0 $\Omega$ to 4 $\Omega$
PCR900LE2	0 $\Omega$ to 0.222 $\Omega$	0 $\Omega$ to 0.889 $\Omega$	0 $\Omega$ to 0.667 $\Omega$	0 $\Omega$ to 2.667 $\Omega$
PCR1200LE2	0 $\Omega$ to 0.167 $\Omega$	0 $\Omega$ to 0.667 $\Omega$	0 $\Omega$ to 0.5 $\Omega$	0 $\Omega$ to 2.0 $\Omega$
PCR1800LE2	0 $\Omega$ to 0.111 $\Omega$	0 $\Omega$ to 0.444 $\Omega$	0 $\Omega$ to 0.333 $\Omega$	0 $\Omega$ to 1.333 $\Omega$
PCR2700LE2	0 $\Omega$ to 0.0741 $\Omega$	0 $\Omega$ to 0.0296 $\Omega$	0 $\Omega$ to 0.222 $\Omega$	0 $\Omega$ to 0.889 $\Omega$

## Setting Soft Starts (The voltage rise time)

To prevent the output from being turned off (the alarm from being activated) and the voltage from dropping due to the load device's inrush current that exceeds the rated capacity of the PCR-LE2 Series, you can control the inrush current by having the output voltage rise gradually when the output is turned on.

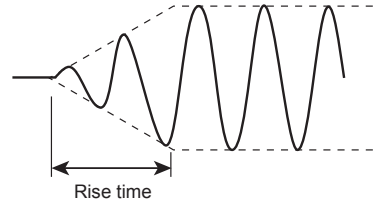

Press OTHERS (SHIFT+MEMORY) and then RISE TIM (F1) to set the soft start.

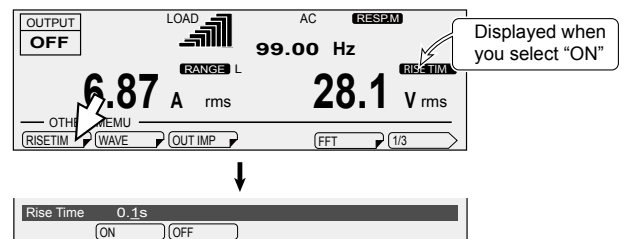

Item	Title	Description	Condition in which the function key cannot be used
ON	Rise Time	Sets the rise time (0.1 s to 3.0 s). The soft start function is turned on.	Action to perform when the current limit is exceeded: DISABLE Compensation function: soft sensing or regulation adjustment
OFF		The soft start function is turned off.	None

## Fixing the Internal Vcc

To minimize loss in the linear amplifier section, the PCR-LE2 Series automatically adjusts the linear amplifier supply voltage (Vcc) to a level that is suitable for the output voltage. Because the response speed of the preregulator (DC power supply) that generates Vcc is slower than that of the linear amplifier, the Vcc voltage is set internally (only when the output voltage is being raised) several hundreds of milliseconds before the voltage output is changed. There will be a time lag before the output voltage is actually changed even when you frequently change the output voltage externally.

You can fix the Vcc voltage of the PCR-LE2 Series. This is useful when you want to prioritize the output voltage response over the product's efficiency.

Fix the PCR-LE2 Series' Vcc voltage according to the peak voltage in the output voltage change tests.

When you fix the Vcc, the internal (power) loss increases, so the protection functions may be activated depending on the output voltage (the duration that the voltage is generated for), load conditions, and ambient temperature. Be sure to carry out tests (simulations) in advance, and check how the PCR-LE2 Series operates.

If the Vcc is fixed and the maximum used output voltage is set lower than the peak output voltage, the maximum used output voltage setting is changed to follow the peak output voltage to prevent a malfunction.

Press OTHERS (SHIFT+MEMORY), 1/3 (F6), and then VCC (F1) to set the internal Vcc.

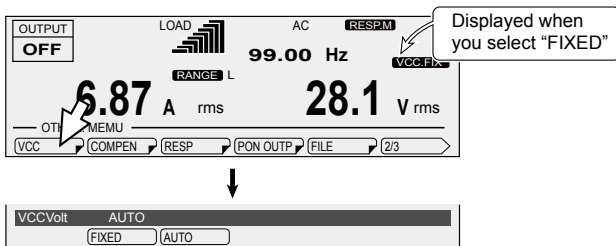

Item	Title	Description
FIXED	VCCVolt	Sets the maximum output voltage that is used (0 Vpk to 431.0 Vpk). The Vcc voltage is fixed.
AUTO	VCCVolt	The Vcc voltage is set automatically (it is not fixed).

## Selecting the Response

The PCR-LE2 Series uses a high-speed amplifier. Depending on the load circuits (especially in the case of capacitive loads) and the wiring conditions, the output may become unstable or may oscillate.

You can set the response speed of the internal amplifier (to one of the following two levels) according to the load conditions and how you will use the PCR-LE2 Series.

- **Normal speed response (MEDIUM)**

This is used in power-supply-environment testing - including tests such as low-frequency immunity tests - to cover a range of frequencies from commercial power line frequencies to the frequencies used by ship and aircraft power supplies.

- **High stable response (SLOW)**

This is used to provide stable power to a variety of loads. For example, this setting would be used on the power supplies at an EMC test sight. Even if a capacitor that has a large capacity (such as a large noise filter) is connected to the output of the PCR-LE2 Series, this setting can be used to provide stable operations. This setting provides a sufficient response speed to generate commercial power line frequencies, so it can also be used in typical evaluation tests.

Press OTHERS (SHIFT+MEMORY), 1/3 (F6), and then RESP (F3) to set the response.

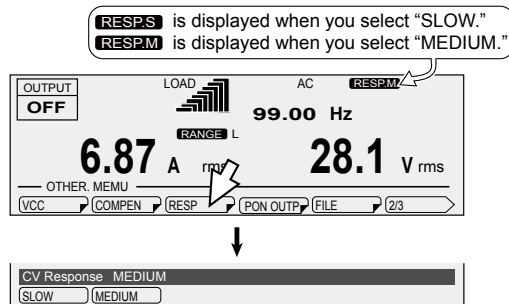

\*1. Invalid in single-phase three-wire output and three-phase output (optional)

Item	Title	Description	Condition in which the function key cannot be used
SLOW	CV Response	Selects the highly stable response	None
MEDIUM		Selects the normal speed response	Compensation function: hard sensing

# Using the Power Management Functions

The PCR-LE2 Series has the following two power management functions: a sleep function and a power-saving function

## Sleep function

You can set the PCR-LE2 Series so that it enters sleep mode after a certain amount of time passes with its power on but no output being generated (the output is off).

When sleep mode is enabled and the specified time elapses, the internal power units turn off, which reduces power consumption.

“zzz...zzz...Please push ESC key” is displayed faintly on the screen (it scrolls across the screen).

Press ESC to exit sleep mode. You cannot turn the output on for the few seconds between when sleep mode is exited and the internal power units turn on (the “Busy” state).

Press SLEEP (SHIFT+1) to set the sleep function.

Busy status display

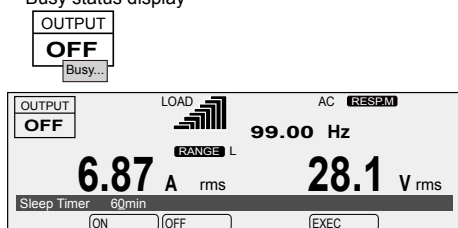

Item	Title	Description
ON	Sleep Timer	The sleep function turns on. Sets the time that elapses before the PCR-LE2 Series enters sleep mode (1 min to 60 min).
OFF		The sleep function turns off.
EXEC	--	The PCR-LE2 Series enters sleep mode instantly.

## Power-saving function

The PCR-LE2 Series is made of units. Each model contains power units that correspond to the rated output capacity.

If you are using the PCR-LE2 Series at less than the rated output capacity, the PCR-LE2 Series can operate using only the necessary power units. Even if you are not supplying power to a load, the power units suffer power loss. Operating the PCR-LE2 Series with the minimum number of power units reduces power consumption.

Set the maximum power that you will use. If the specified power capacity is exceeded, the protection functions will be activated.

Press OPR MODE and the POW SAV (F4).

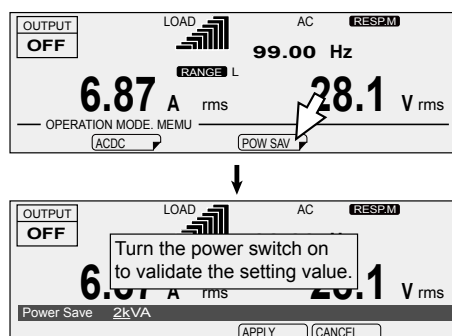

Item	Title	Description
POW SAV	Power Save	Sets the anticipated maximum power <sup>*1</sup> (3 kVA to the rated output capacity; resolution: 3 kVA). Example: If the anticipated maximum power on a PCR9000LE2 is 4.5 kVA, set this to 6 kVA.
U <sup>*2</sup>	U Power Save	Sets the anticipated maximum power of U phase (1 kVA to the rated output capacity; resolution: 1 kVA)
V <sup>*2</sup>	V Power Save	Sets the anticipated maximum power of V phase (1 kVA to the rated output capacity; resolution: 1 kVA)
W <sup>*3</sup>	W Power Save	Sets the anticipated maximum power of W phase (1 kVA to the rated output capacity; resolution: 1 kVA)

\*1. During single-phase output

\*2. During single-phase three-wire output or three-phase output

\*3. During three-phase output

Turn the POWER switch off and on to enable the setting.

To clear the power-saving function, set the MAX setting to the rated output capacity.

# Controlling the Output Using External Analog Signals

The output can be controlled using external analog signals by installing the analog signal interface board (EX05-PCR-LE/EX06-PCR-LE) to the slot3.

For details of installing the board on the PCR-LE, see the setup guide of EX05-PCR-LE/EX06-PCR-LE.

- Amplifying the input waveform (EX05-PCR-LE only)

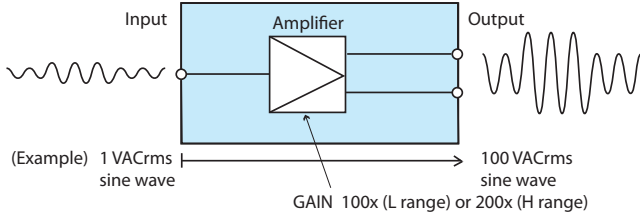

- Note -

Only single-phase output is valid on the PCR600LE2 and PCR900LE2.

- Varying the voltage of the output AC waveform using DC signals (EX06-PCR-LE only)

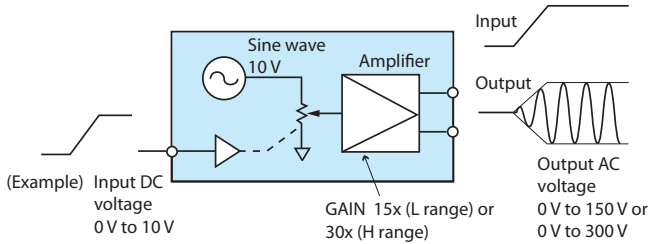

- SIGNAL I/O Connector
- Controlling the PCR-LE2 through external contacts  
You can turn the output on and off, execute and stop sequences, clear alarms, and shut down the output.
- Monitoring the operation status  
You can monitor the output status, alarm status, busy status, current peak limit status, and overload status.

## CAUTION

You cannot set the voltage limit when the PCR-LE2 is being controlled using external analog signals. Accidentally applying an excessive external voltage may damage the load.

## Names and functions of the parts of the analog signal interface board

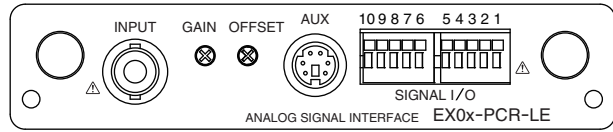

Name	Description
INPUT	BNC terminal for applying the external signal Input terminals is electrically isolated from the output terminals of the PCR-LE2.
GAIN	Variable resistor for fine adjusting the gain (voltage amplification ratio)
OFFSET	Variable resistor for fine adjusting the offset
AUX	This is a connector for options.
SIGNAL I/O	Connector for controlling the PCR-LE2 through external contacts



## Amplifying the input waveform (EX05-PCR-LE only)

You can use the PCR-LE2 with EX05-PCR-LE as a power amplifier that simply amplifies the input waveform or use it to add an external signal to the PCR-LE2 Series signal source.

### Selecting the signal source

Select which signal source to use to control the PCR-LE2 Series.

- Internal signal source (INT)  
Output the PCR-LE2 Series signal source. External signal sources are not used.

- Internal signal source and external signal source (INT+EXT)  
Output the sum of the PCR-LE2 Series signal source and an external signal source.

If you select INT+EXT, the PCR-LE2 Series settings will be changed as follows:

Action to perform when the current limit is exceeded: Turn the output off

Internal Vcc: FIXED: (previously set value)

Compensation function: OFF (when soft sensing or regulation adjustment is selected)

Displays the phase voltage (Single-phase three-wire output or three-phase output only)

- External signal source (EXT)

The EX05-PCR-LE amplifies the external signal (0 Vrms to 1.5 Vrms) 100 times when L range is selected and 200 times when H range is selected and outputs the resultant voltage.

If you select EXT, the PCR-LE2 Series settings will be changed as follows:

Action to perform when the current limit is exceeded: Turn the output off

Synchronization function: OFF

Output on/off phase control: FREE

Internal Vcc: FIXED: (previously set value)

Compensation function: OFF (when soft sensing or regulation adjustment is selected)

Soft starts: OFF

Displays the phase voltage (Single-phase three-wire output or three-phase output only)

Press OTHERS (SHIFT+MEMORY), EXT SIG(F4) and then SOURCE(F1) to set the signal source.

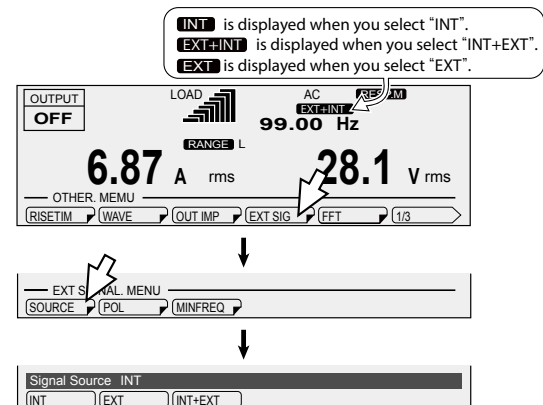

Item	Title	Description	Condition in which the function key cannot be used
INT	Signal	Use the internal signal.	Output on
EXT	Source	Use the external signal.	
INT+EXT		Use the internal signal and external signal.	

**CAUTION**

Risk of malfunction. If you output DC voltage in AC mode, the protection features will not function properly. If you want to output DC voltage, use the PCR-LE2 Series within 70 % of the rated current, or change the output voltage mode to AC+DC.

### Selecting the polarity

Select whether to output a signal whose polarity is the same as or opposite to that of the input signal.

Press OTHERS (SHIFT+MEMORY), EXT SIG(F4) and then POL(F2) to set the polarity.

During single-phase, three-wire output and three-phase output, press OTHERS (SHIFT+MEMORY), EXT SIG(F4), and then press the key that corresponds to the phase that you want to set, and then POL(F2) to set the polarity.

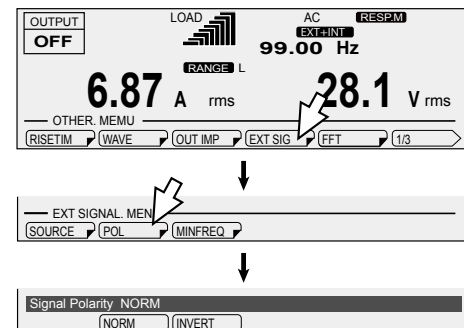

Item	Title	Description
NORM	Signal Polarity U Signal Polarity <sup>*1</sup>	Output a signal whose polarity is the same as the input signal.
INVERT	V Signal Polarity <sup>*1</sup> W Signal Polarity <sup>*2</sup>	Output a signal whose polarity is opposite to that of the input signal.

\*1. Single-phase three-wire output and three-phase output only

\*2. Three-phase output only

## Controlling the Output Using External Analog Signals (Cont.)

### Amplifying the input waveform (EX05-PCR-LE only)

#### ■ Setting the aperture time (only when using EXT)

To use an external signal source (EXT), set the aperture time. -> p32

If the aperture time is not set, the voltage and current that are being output may be different from what are displayed on the panel.

The aperture time setting was added in firmware version 5.00. As a result, the function for setting the estimated minimum frequency that was available in firmware version 4.99 and earlier is no longer available.

#### ■ Setting the internal Vcc

If you set the signal source to EXT or EXT+INT, the internal Vcc is changed to a fixed value. Set the Internal Vcc value to the voltage that you want to output (peak value) + 10 V.-> p70

If the internal Vcc is set to a value greater than the actual output voltage, the protection function may be activated. If the internal Vcc is set to a value less than the actual output voltage, a few hundred milliseconds of response delay will occur.

#### ■ Outputting the signal

After you set the signal source, polarity, and the estimated minimum frequency (EXT only), apply an external signal to the INPUT terminal.

- 1 Check that the POWER switch is turned off.**
- 2 Connect an external signal (generator) to the INPUT terminal.**
- 3 Turn the POWER switch on.**
- 4 Press the RANGE (SHIFT+8) key to set the voltage range (L/H)**
- 5 Apply an external signal to the INPUT terminal.**
- 6 Turn the OUTPUT on.**

#### ■ Fine adjusting the offset

You can fine adjust the offset by turning the OFFSET variable resistor using the adjustment screwdriver. Adjust the offset so that the output voltage is as close to 0 Vdc as possible with the input terminal shorted.

#### ■ Fine adjusting the gain

You can fine adjust the gain by turning the GAIN variable resistor using the adjustment screwdriver. Adjust the gain so that the output voltage is 150 Vac (L range) when 1.5 Vac is applied to the input terminal.

#### ■ Functional limitations

If you use an external signal, you will not be able to use the following functions, in addition to the settings that were changed when you selected the signal source.

- When the internal signal source plus the external signal source are used
  - Harmonic current analysis function
- When the external signal source is used
  - Setting the output voltage, voltage limit
  - Setting the frequency, frequency limit
  - Using memory
  - Special waveforms
  - Harmonic current analysis function
  - Power line abnormality simulations
  - Sequence function
  - Phase difference (Single-phase three-wire output or three-phase output only)

## Varying the voltage of the output AC waveform using DC signals (EX06-PCR-LE only)

When AC mode or AC+DC mode is selected, the PCR-LE2 with EX06-PCR-LE outputs AC voltage ranging from 0 V to 150 V (when L range is selected) or 0 V to 300 V (when H range is selected) with respect to a DC signal input ranging from 0 V to 10 V.

### ■ Selecting the signal source

Select whether to control the output AC voltage using an external signal.

Press OTHERS (SHIFT+MEMORY) and then, VPROG(F4) to set the signal source.

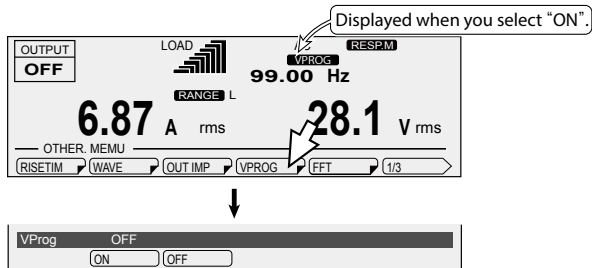

Item	Title	Description	Condition in which the function key cannot be used
ON	VProg	Control the AC voltage using an external signal	OUTPUT on Soft start: ON
OFF		Do not control the AC voltage using an external signal	

### ■ Outputting the signal

After you set the signal source, apply an external signal to the INPUT terminal.

- 1 Check that the POWER switch is turned off.
- 2 Connect an external signal (generator) to the INPUT terminal.
- 3 Turn the POWER switch on.
- 4 Press the OPR MODE > ACDC(F2) to set the output mode (AC/ AC+DC).
- 5 Press the RANGE (SHIFT+8) key to set the voltage range (L/H).
- 6 Press F > FREQ(F1) to set the frequency (1.0 Hz to 999.9 Hz).
- 7 Apply an external signal to the INPUT terminal.
- 8 Turn the OUTPUT on.

## Controlling the Output Using External Analog Signals (Cont.)

### Varying the voltage of the output AC waveform using DC signals (EX06-PCR-LE only)

#### ■ Fine adjusting the offset and the gain

You can fine adjust the offset by turning the OFFSET variable resistor using the adjustment screwdriver. You can fine adjust the gain by turning the GAIN variable resistor using the adjustment screwdriver.

- 1** Apply 1 Vdc to the INPUT terminal.
- 2** Turn the OUTPUT on.
- 3** Using an adjustment screwdriver, adjust the OFFSET variable resistor so that the output voltage is at 15 Vdc (L range).
- 4** Apply 10 Vdc to the INPUT terminal.
- 5** Using an adjustment screwdriver, adjust the GAIN variable resistor so that the output voltage is at 150 Vdc (L range).
- 6** Apply 1 Vdc to the INPUT terminal, and check that the output voltage is 15 Vdc (L range). If it is not, repeat steps 1 to 5 until the output voltage is 15 Vdc (L range).  
When you adjust either the offset or the gain, the other value that you adjusted before may shift. Be sure to double-check both values.
- 7** Turn the OUTPUT off.

#### ■ Functional limitations

If an external signal is used, you will not be able to use the following functions.

- Setting the output AC voltage
- Soft starts
- Power line abnormality simulations
- Sequence function

## SIGNAL I/O Connector

### ⚠ WARNING

**Risk of electric shock. Never attempt to connect wires to the SIGNAL I/O connector while the POWER switch turned on.**

### ■ Pin arrangement and connection

To control the PCR-LE2 Series through external contacts, use pins 6 to 10 of the SIGNAL I/O connector.

To monitor the operation status of the PCR-LE2 Series, use pins 1 to 5 of the SIGNAL I/O connector.

Remove the covering from each wire over a distance of 9 mm to 10 mm (10 mm is recommended).

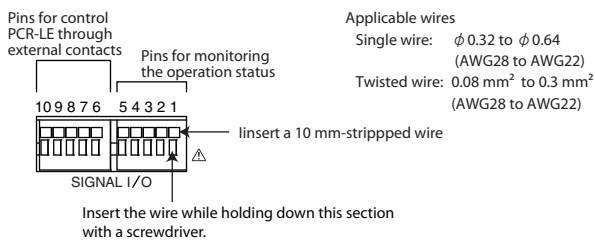
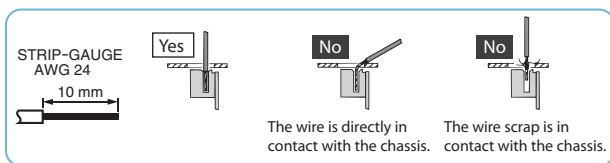

Pin	Signal Name	Description
1	OUTPUT ON STATUS	Output on status monitor
2	ALARM STATUS	Alarm status monitor
3	OOB STATUS	Current peak limit status and Overload status monitor
4	BUSY STATUS	Busy status monitor
5	STATUS COM	Output signal common
6	OUTPUT CONTROL	Output on/ off control
7	SEQ RUN	Sequence execute/ stop
8	ALARM CLR	Alarm clear
9	SHUT DOWN	Shut down the output
10	COM	Input signal common

## Controlling the PCR-LE2 through external contacts

### ■ Wiring

To minimize the influence of noise on the output, use a two-core shielded wire or a twisted-pair wire to connect the control terminals and the external contact. Make the wires as short as possible. Susceptibility to the effects of noise increases as the wires get longer. When wires are long, proper operation may be hindered even if a cable with anti-noise measures is used.

The release voltage across pins is approx. 12 V maximum, and the short circuit current is approx. 8.5 mA maximum. (The internal circuit is pulled up to 12 V through 1.3 k $\Omega$ .)

Use parts with a contact rating of 12 Vdc and 8.5 mA for the external contact.

High level input voltage (HIGH): 11 V to 12 V, or open circuit

Low level input voltage (LOW): 0 V to 1 V

When using a shielded cable, connect the shield to the chassis.

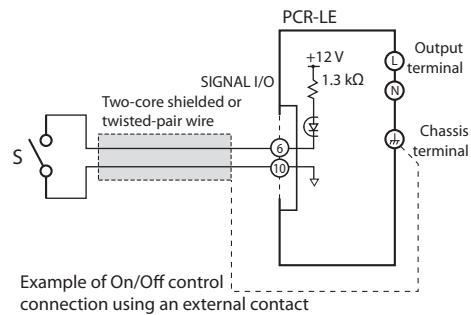

### For long-distance wiring

When wiring over a great distance, use a small relay and extend the coil side of the relay.

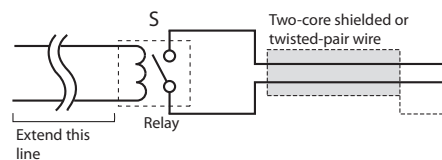

# Controlling the Output Using External Analog Signals (Cont.)

## Controlling the PCR-LE2 through external contacts (Cont.)

### Controlling the Output On/ Off

Use pins 6 to 10 of the SIGNAL I/O connector to turn the output on and off through external contacts.

If multiple units are used under floating conditions and a single external contact is used to turn on/off the output, isolate the signal to each unit such as by using a relay on the external contact signal.

Press CONFIG (SHIFT+OPR MODE), EXT.OPT(F2), CONTROL(F1) and then, OUTP ON(F1) to set the external control logic of output on/off.

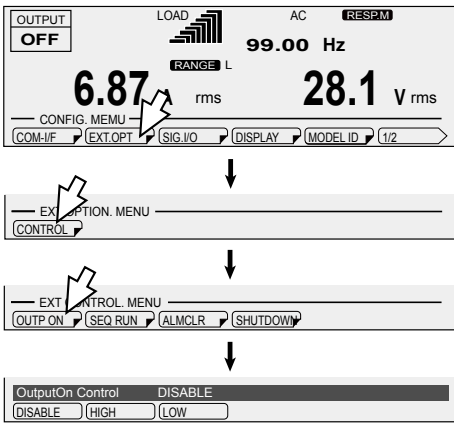

Item	Title	Description
DISABLE	OutputOn Control	Do not turn the output on and off through external contacts.
HIGH		Turn the output on with a high signal.
LOW		Turn the output on with a low signal.

If the output is set to off using an external contact, the OUTPUT key on the front panel is invalid. If you do not want to control the output through external contacts, set the output control logic to DISABLE.

The figure below shows an example of output on/off control when a high level signal turns the output on.

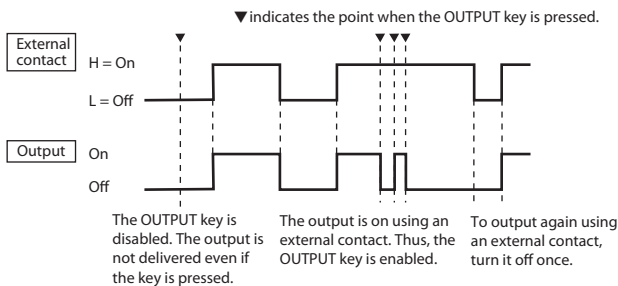

When a sequence is running, the output on/off control through external contacts is invalid.

### Controlling the Sequence Execute/Stop

Use pins 7 to 10 of the SIGNAL I/O connector to turn the sequence execute and stop through external contacts.

Press CONFIG (SHIFT+OPR MODE), EXT.OPT(F2), CONTROL(F1) and then, SEQ RUN(F2) to set the external control logic of sequence run/stop.

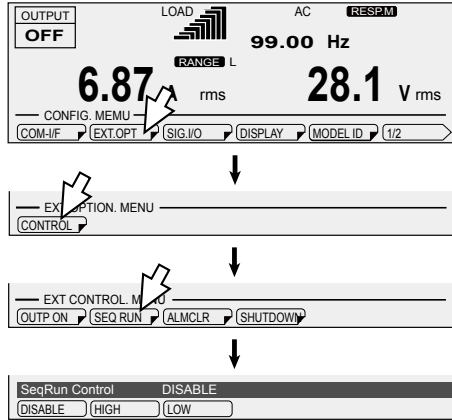

Item	Title	Description
DISABLE	SeqRun Control	Do not execute/stop the sequence through external contacts.
HIGH		Execute the sequence with a high signal.
LOW		Run the sequence with a low signal.

When a sequence is stopped through external contacts, RUN (F1) on the front panel is invalid. If you do not want to control the sequence through external contacts, set the output control logic to DISABLE.

The figure below shows an example of sequence execute/stop control when a high level signal execute the sequence.

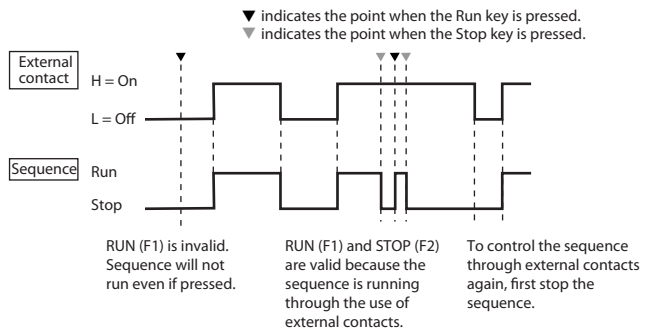

## ■ Clear alarms

Use pins 8 and 10 of the SIGNAL I/O connector to clear alarms through external contacts.

Press CONFIG (SHIFT+OPR MODE), EXT.OPT(F2), CONTROL(F1) and then, ALMCLR(F3) to set the external control logic of alarm clear.

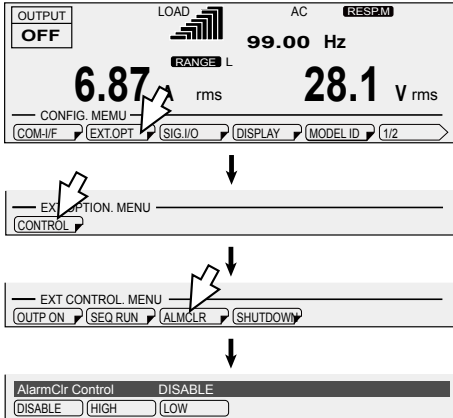

Item	Title	Description
DISABLE	AlarmClr Control	Do not clear alarms through external contacts
HIGH		Alarm clear with a high signal.
LOW		Alarm clear with a low signal.

## ■ Shut down the output

Use pins 9 and 10 of the SIGNAL I/O connector to shut down the output through external contacts. This takes precedence over the feature that turns the output on and off through external contacts.

When the output is shut down, "TRBL-19 EXT.SHUTDOWN" appears on the panel.

Press CONFIG (SHIFT+OPR MODE), EXT.OPT(F2), CONTROL(F1) and then, SHUTDOWN(F4) to set the external control logic of shutdown.

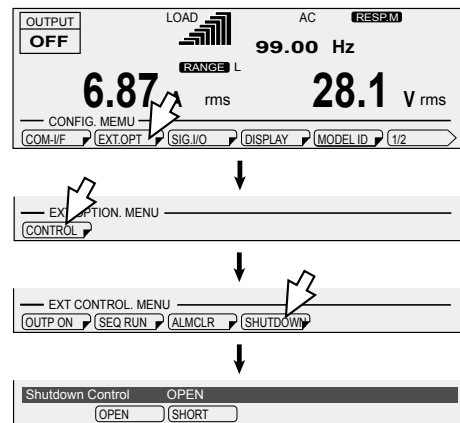

Item	Title	Description
OPEN	Shutdown Control	Turn output off with open circuit (input voltage: 11 V to 12V).
SHORT		Turn output off with short circuit (input voltage: 0 V to 1 V).

## Recovery

Turn the POWER switch off.

If the external control logic is OPEN, short pins 9 and 10, and turn the POWER switch on.

If the external control logic is SHORT, open pins 9 and 10, and turn the POWER switch on.

# Controlling the Output Using External Analog Signals (Cont.)

## Monitoring the operation status

You can externally monitor the following operation status of the PCR-LE2.

- Output (OUTPUT ON STATUS)  
Use pins 1 and 5 of the SIGNAL I/O connector.  
The signal turns on when the output is on.
- Alarm occurrence (ALARM STATUS)  
Use pins 2 and 5 of the SIGNAL I/O connector.  
The signal turns on when an alarm or trouble occurs.
- Current peak limit and overload (OOR STATUS)  
Use pins 3 and 5 of the SIGNAL I/O connector.  
The signal turns on when the current limit is exceeded (OVERLOAD indication) and when current peak is being limited (IPKLIM indication).
- Busy (BUSY STATUS)  
Use pins 4 and 5 of the SIGNAL I/O connector.  
The signal turns on when the output cannot be turned on (busy status).  
For a few seconds when the sleep function is disabled  
For approx. 0.6 seconds when the output voltage range is switched  
For approx. 120 seconds when the current limit is exceeded  
For approx. 120 seconds when the internal semiconductor protection is activated  
For a few seconds when the output phase is switched  
For a few seconds when the output method for single-phase three-wire output is switched

The output signals are open collector outputs of photocouplers (30 Vdc, 8 mA); they are insulated from the internal circuits of the PCR-LE2.

Maximum voltage: 30 V

Maximum current (Sink): 8 mA

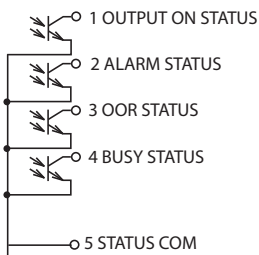

### ■ Selecting the phase to monitor (PCR2700LE2 only)

If you want apply current peak limit and overload monitoring (OOR STATUS) during single-phase three-wire output or three-phase output, you can select whether to monitor the entire system or each phase. To monitor each phase, an analog signal interface board must be installed for the phase that you want to monitor.

Press CONFIG (SHIFT+OPR MODE), EXT.OPT (F2), STAT.OUT (F2) and then, LMT STAT (F1) to select the phase that you want to monitor.

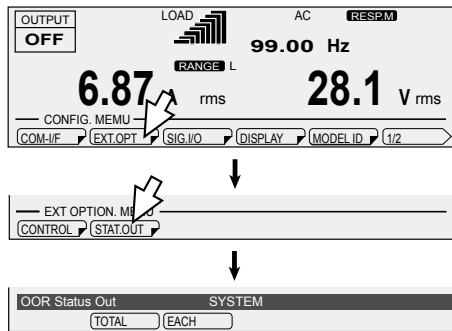
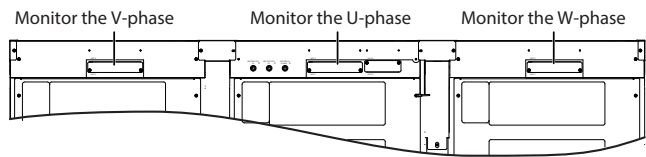

Item	Title	Description
TOTAL	OOR Status Out	Monitor the entire system and output the status.
EACH		Monitor the phase for which the board is installed and output the status.



## Main Unit Specifications

Unless specified otherwise, the specifications are for the following settings and conditions.

The warm-up time is 30 minutes (with current flowing).

TYP: These are typical values that are representative of situations where the PCR-LE2 Series operates in an environment with an ambient temperature of 23 °C (73.4 °F). These values do not guarantee the performance of the PCR-LE2 Series.

set: Indicates a setting.

reading: Indicates the readout value.

### Input (AC rms)

		PCR6000LE2	PCR9000LE2	PCR12000LE2	PCR18000LE2	PCR27000LE2
Nominal input voltage	Single-phase two-wire input	200 Vac to 240 Vac	---	---	---	---
	Three-phase three-wire input	200 Vac to 240 Vac				
	Three-phase Four-wire input	220 Vac to 240 Vac (Phase voltage)				
Input voltage range	Single-phase two-wire input	170 Vac to 250 Vac	---	---	---	---
	Three-phase three-wire input	170 Vac to 250 Vac				
	Three-phase four-wire input	187 Vac to 254 Vac (Phase voltage)				
Nominal input Frequency		50 Hz to 60 Hz				
Input frequency range		47 Hz to 63 Hz				
Apparent power*1		Approx. 10.6 kVA	Approx. 15.7 kVA	Approx. 23 kVA	Approx. 33 kVA	Approx. 48 kVA
Power factor **1		0.97 (TYP)				
Maximum current*2	Single-phase two-wire input	64 A	---	---	---	---
	Three-phase three-wire input	38 A	55.0 A	75 A	111 A	165 A
	Three-phase four-wire input	21 A	30 A	39 A	59 A	91 A

\*1. When the output phase voltage is 100 V or 200 V, the output current is the rated value, the load power factor is 1, and the output frequency is between 40 Hz and 999.9 Hz.

\*2. When the input voltage is 170 V (Single phase two-wire input and Three-phase-three-wire input), 187 V (Three-phase Four-wire input).

## Main Unit Specifications (Cont.)

### AC mode output (AC rms)

		PCR6000LE2	PCR9000LE2	PCR12000LE2	PCR18000LE2	PCR27000LE2
Phase voltage (output L range, output H range)	Rating	1 V to 150 V, 2 V to 300 V				
	Setting range	0 V to 152.5 V, 0 V to 305.0 V				
	Resolution	0.1 V				
	Accuracy*1	±(0.3 % of set + 0.6 V)				
Maximum current (output L range, output H range)*2	Single-phase output	60 A, 30 A	90 A, 45 A	120 A, 60 A	180 A, 90 A	270 A, 135 A
	Single-phase three-wire output	20 A, 10 A	30 A, 15 A	40 A, 20 A	60 A, 30 A	90 A, 45 A
	Three-phase output					
Phase		Single-phase Two-wire, Single-phase Three-wire, and Three-phase Four-wire				
Power capacity	Single-phase output, Three-phase output	6 kVA	9 kVA	12 kVA	18 kVA	27 kVA
	Single-phase three-wire output	4 kVA	6 kVA	8 kVA	12 kVA	18 kVA
Maximum peak current		Maximum current (rms) × 4 (TYP) *3				
Maximum reverse current *4		30 % of the maximum current (rms)				
Load power factor		0 to 1 (leading or lagging) *2				
Frequency *2	Setting range	1 Hz to 999.9 Hz*5				
	Resolution	0.01 Hz (1.00 Hz to 100.0 Hz), 0.1 Hz (100.0 Hz to 999.9 Hz)				
	Accuracy	±1×10 <sup>-4</sup>				

\*1. When the output frequency is between 45 Hz and 65 Hz, with no load, and at 23°C±5°C.

\*2. When the output phase voltage is between 1 V and 100 V (L range) or 2 V and 200 V (H range) and the load power factor is between 0.8 and 1. When the output phase voltage is between 100 V and 150 V (L range) or 200 V and 300 V (H range), the output current is reduced by the output phase voltage. When the load power factor is between 0 and 0.8, the output current is reduced by the load power factor. When the output frequency is between 1 Hz and 40 Hz, the output current is reduced by the output frequency.

\*3. For capacitor-input rectifier loads, (at near the peak of the voltage waveform, excluding three-phase three-wire output). The peak current that can be output decreases in accordance with the reduction in the absolute value of the instantaneous output voltage. "Instantaneous output voltage versus instantaneous peak current ratio" (figs 5 and 6) for the representative voltage settings of each range is indicated in "Rated output current characteristics (Derating)"(-> p87).

\*4. When the output phase voltage is 100 V or 200 V and the output frequency is between 40 Hz and 999.9 Hz (current is -90 deg to -180 deg/ 90 deg to 180 deg out of phase with the output voltage).

\*5. The frequency is limited to the range from 1 Hz to 500.0 Hz while three-phase output in the PCR-LE 500Hz LMT models.

### DC mode output

		PCR6000LE2	PCR9000LE2	PCR12000LE2	PCR18000LE2	PCR27000LE2
Phase voltage (output L range, output H range)	Rating	-1.4 V to -212 V and +1.4 V to +212 V, -2.8 V to -424 V and +2.8 V to +424 V				
	Setting range	-215.5 V to +215.5 V, -431.0 V to +431.0 V				
	Resolution	0.1 V				
	Setting accuracy	±(0.05 % of set + 0.05 V / 0.1 V)				
Maximum current (output L range, output H range) *2	Single-phase output	42 A, 21 A	63 A, 31.5 A	84 A, 42 A	126 A, 63 A	189 A, 94.5 A
	Single-phase three-wire output	14 A, 7 A	21 A, 10.5 A	28 A, 14 A	42 A, 21 A	63 A, 31.5 A
	Three-phase output					
Maximum instantaneous current*3		Maximum current (rms) × 3.6				
Power capacity	Single-phase output	4.2 kW	6.3 kW	8.4 kW	12.6 kW	18.9 kW
	Single-phase three-wire output	2.8 kW	4.2 kW	5.6 kW	8.4 kW	12.6 kW
	Three-phase output					

\*1. With no load at 23°C±5°C.

\*2. When the output phase voltage is between 100 V and 212 V (L range) or 200 V and 424 V (H range), the output current is reduced by the output phase voltage.

\*3. Limited by the rated output current's rms value.

### AC + DC mode output

	Setting range	Resolution	Setting accuracy
Voltage setting	The AC voltage setting range is the same as the range in AC mode. The DC voltage setting range is the same as the range in DC mode. However, the peak AC+DC voltage must be within the DC voltage setting range.		AC voltage setting + DC voltage setting
Maximum current	The same as the setting in DC mode		
Maximum instantaneous current	The same as the setting in DC mode		
Power capacity	The same as the setting in DC mode		
Frequency	The same as the setting in AC mode		

## Output voltage stability

	PCR6000LE2	PCR9000LE2	PCR12000LE2	PCR18000LE2	PCR27000LE2
Line regulation* <sup>1</sup>	Within $\pm 0.1\%$				
Load regulation* <sup>2</sup>	Within $\pm 0.3\text{ V}$		Within $\pm 0.5\text{ V}$		
Output frequency variation* <sup>3</sup>	Within $\pm 0.5\%$		Within $\pm 1\%$		
Ripple noise in DC mode (5 Hz to 1 MHz components)	0.25 Vrms or less		0.5 Vrms or less		
Ambient temperature variation * <sup>4</sup>	$\pm 100\text{ ppm/ }^\circ\text{C}$ (TYP)				

\*1. With respect to changes in the rated range of input voltage

\*2. With respect to 0 % to 100 % changes in the rating of output current

When the output phase voltage is between 80 V and 150 V (L range) or 160 V and 300 V (H range) and the load power factor is 1. At the output terminal block. When the response mode is set to MEDIUM.

\*3. Between 40 Hz and 999.9 Hz.

When the output phase voltage is between 80 V and 150 V (L range) or 160 V and 300 V (H range) and the load power factor is 1. This is the output line regulation with 200 Hz as the reference. When the response mode is set to MEDIUM.

\*4. With respect to changes in the operating temperature range.

When the output phase voltage is 100 V or 200 V and the output current is 0 A.

## Output frequency stability, output voltage waveform distortion ratio, output voltage response speed, efficiency, Phase difference of the output phase voltage

	PCR6000LE2	PCR9000LE2	PCR12000LE2	PCR18000LE2	PCR27000LE2
Output frequency stability* <sup>1</sup>	Within $\pm 5 \times 10^{-5}$				
Output voltage waveform distortion ratio * <sup>2</sup>	0.3 % or less		0.5 % or less		
Output voltage response speed * <sup>3</sup>	30 $\mu\text{s}$ (TYP)		50 $\mu\text{s}$ (TYP)		
Efficiency * <sup>4</sup>	58 % or more				
Phase difference of the output phase voltage * <sup>5</sup>	Resolution	1°			
	Accuracy	Within $\pm(0.4^\circ + 5\ \mu\text{s})$ Within $\pm(0.4^\circ + f_o \times 1.8 \times 10^{-3^\circ})$ , where the output frequency is $f_o$ . <sup>6</sup>			
	Range	0° to 359°			

\*1. For changes within the rated ranges of all specifications

\*2. When the output phase voltage is between 80 V and 150 V (L range) or 160 V and 300 V (H range) and the load power factor is 1. When the response mode is set to MEDIUM.

\*3. When the output phase voltage is 100 V or 200 V, the load power factor is 1, and the output current changes from 0 A to the rated value and from the rated value to 0 A. When the response mode is set to MEDIUM.

\*4. When the output phase voltage is 100 V or 200 V, the output current is the rated value, the load power factor is 1, and the output frequency is between 40 Hz and 999.9 Hz.

\*5. Phase difference between output voltages (phase voltages) when each phase is considered along with the neutral point.

\*6. The following show the angles obtained by calculating the expression with the specified frequency.

Within  $\pm 0.5^\circ$  (when generating 60 Hz output)

Within  $\pm 1.2^\circ$  (when generating 400 Hz output)

## Meters (fluorescent display)

	PCR6000LE2	PCR9000LE2	PCR12000LE2	PCR18000LE2	PCR27000LE2	
Voltmeter * <sup>1</sup>	Resolution	0.1 V				
	Accuracy * <sup>2</sup>	$\pm(1\%$ of reading +2 digits)				
Ammeter * <sup>1</sup>	Resolution	Single-phase output	0.1 A		0.1 A, 1 A	
		Single-phase three-wire output	0.01 A	0.1 A		
		Three-phase output				
	Accuracy * <sup>3</sup>	$\pm(1\%$ of reading +2 digits)				
Wattmeter * <sup>4</sup>	Resolution	Single-phase output	1 W		1 W, 0.01 kW	
		Single-phase three-wire output	0.1 W, 1 W	1 W	1 W, 0.01 kW	
		Three-phase output				
		Accuracy * <sup>5</sup>	$\pm(1\%$ of reading +3 digits)			
Frequency meter * <sup>6</sup>	Resolution	0.01 Hz (1.00 Hz to 99.99 Hz) , 0.1 Hz (100.0 Hz to 999.9 Hz)				

\*1. With the true rms display, a waveform with a crest factor of 3 or less, DC, output frequency between 45 Hz and 65 Hz, RMS, and AVE.

\*2. 10 V to 848 V, and at  $23^\circ\text{C} \pm 5^\circ\text{C}$ .

\*3. 5 % of the maximum rated current to maximum rated current, and at  $23^\circ\text{C} \pm 5^\circ\text{C}$ .

\*4. When the output frequency is between 45 Hz and 65 Hz.

\*5. 10 % to 100 % of the rated output capacity, when the load power factor is 1, and at room temperature.

\*6. Displays the output frequency setting (frequency of the internal reference voltage)

## Main Unit Specifications (Cont.)

### Limit Values and Protection Functions

		PCR6000LE2	PCR9000LE2	PCR12000LE2	PCR18000LE2	PCR27000LE2	
Voltage	AC voltage upper limit	0.0 V to 305.0 V					
	AC voltage lower limit						
	DC voltage upper limit	-431.0 V to 431.0 V					
	DC voltage lower limit						
	Output overvoltage protection AC/AC+DC mode	0.0 V to 474.1 V					
	Output overvoltage protection DC mode	-474.1 V to 474.1 V					
	Output undervoltage protection AC/AC+DC mode	0.0 V to 474.1 V					
	Output undervoltage protection DC mode	-474.1 V to 474.1 V					
Resolution		0.1 V					
Frequency	Upper limit	1 Hz to 999.9 Hz, 500Hz LMT model: 1 Hz to 500 Hz (Three-phase output)					
	Lower limit						
	Resolution	0.01 Hz (1.00 Hz to 100.0 Hz), 0.1 Hz (100.0 Hz to 999.9 Hz)					
Current	Current limit*1 AC mode	Single-phase output	6.00 A to 66.00 A	9.00 A to 99.00 A	12.00 A to 132.0 A	18.00 A to 198.0 A	27.00 A to 297.0 A
		Single-phase three-wire output Three-phase output	2.00 A to 22.00 A	3.00 A to 33.00 A	4.00 A to 44.00 A	6.00 A to 66.00 A	9.00 A to 99.00 A
	Current limit*1 DC/AC+DC mode	Single-phase output	4.20 A to 46.20 A	6.30 A to 69.30 A	8.40 A to 92.40 A	12.60 A to 138.6 A	18.90 A to 207.9 A
		Single-phase three-wire output Three-phase output	1.40 A to 15.40 A	2.10 A to 23.10 A	2.80 A to 30.80 A	4.20 A to 46.20 A	6.30 A to 69.30 A
	Positive peak current limit*2	Single-phase output	6.00 A to 264.0 A	9.00 A to 396.0 A	12.00 A to 528.0 A	18.00 A to 792.0 A	27.00 A to 1188 A
		Single-phase three-wire output Three-phase output	2.00 A to 88.00 A	3.00 A to 132.0 A	4.00 A to 176.0 A	6.00 A to 264.0 A	9.00 A to 396.0 A
	Negative peak current limit*2	Single-phase output	-6.00 A to -264.0 A	-9.00 A to -396.0 A	-12.00 A to -528.0 A	-18.00 A to -792.0 A	-27.00 A to -1188 A
		Single-phase three-wire output Three-phase output	-2.00 A to -88.00 A	-3.00 A to -132.0 A	-4.00 A to -176.0 A	-6.00 A to -264.0 A	-9.00 A to -396.0 A
	Resolution*3		0.01 A (0.35 A to 100.0 A), 0.1 A (100.0 A to 1000 A), 1 A (1000 A to 1188 A)				

\*1. The current that can actually be supplied is 1.1 times the rated current or the current limit, whichever is less.

\*2. The current that can actually be supplied is the maximum peak current or the current limit, whichever is less.

\*3. You can set the current in 0.01 A/ 0.1 A/ 1 A steps, but it may not change at this resolution depending on the relationship with the internal D/A resolution.

### Power line abnormality simulations

		Setting range	Resolution	Setting accuracy
T1	DEG	0 deg to 359 deg	1 deg	±1 deg
	TIME	0.0 ms to 999.9 ms	0.1 ms	±(1×10 <sup>-3</sup> +0.1 ms)
T2		0.0 ms to 99990 ms	0.1 ms	±(1×10 <sup>-3</sup> +0.1 ms)
T3		0.1 ms to 9999.0 ms	0.1 ms	±(1×10 <sup>-3</sup> +0.1 ms)
T4		0.0 ms to 99990 ms	0.1 ms	±(1×10 <sup>-3</sup> +0.1 ms)
T5		0.0 ms to 99990 ms	0.1 ms	±(1×10 <sup>-3</sup> +0.1 ms)
N		0 cycles to 999900 cycles	1 cycle	±1 cycle
T3 VOLT		The same as the output voltage setting range		
LOOP		0 to 9998 repetitions or infinite repetitions	1 repetition	±1 repetition

### Sequence operations

	Setting range	Resolution	Setting accuracy
STEP	0 to 599	1	---
FREQ	The same as the output frequency setting range		
ACV	The same as the output voltage setting range		
TIME	0.1 ms to 1000 hour	0.1 ms	±(1×10 <sup>-3</sup> +0.1 ms)
W.B. No.	The same as the special waveform output setting range		
IMPEDANCE	The same as the output impedance setting range		
DCV	The same as the output voltage setting range		
S.PHASE	0 deg to 359 deg	1 deg	±1 deg
E.PHASE	0 deg to 359 deg	1 deg	±1 deg

## Special waveform output

	Setting range	Resolution	Setting accuracy
Waveform bank	0 to 63 (the waveform bank in 0 is read-only)	1	---
Crest factor	1.10 to 1.40	0.01	±0.01

## Output impedance setting

		Setting range		Resolution		Setting accuracy	
		Single-phase output	Single-phase three-wire output, Three-phase output	Single-phase output	Single-phase three-wire output, Three-phase output	Single-phase output	Single-phase three-wire output, Three-phase output
PCR6000LE2	L range	0 Ω to 0.333 Ω	0 Ω to 1.0 Ω	3.33 mΩ	10 mΩ	±(10 % of set+6.67 mΩ)	±(10 % of set+20 mΩ)
	H range	0 Ω to 1.333 Ω	0 Ω to 4.0 Ω	13.33 mΩ	40 mΩ	±(10 % of set+26.67 mΩ)	±(10 % of set+80 mΩ)
PCR9000LE2	L range	0 Ω to 0.222 Ω	0 Ω to 0.667 Ω	2.22 mΩ	6.67 mΩ	±(10 % of set+4.44 mΩ)	±(10 % of set+13.33 mΩ)
	H range	0 Ω to 0.889 Ω	0 Ω to 2.667 Ω	8.89 mΩ	26.67 mΩ	±(10 % of set+17.78 mΩ)	±(10 % of set+53.32 mΩ)
PCR12000LE2	L range	0 Ω to 0.167 Ω	0 Ω to 0.5 Ω	1.67 mΩ	5 mΩ	±(10 % of set+3.33 mΩ)	±(10 % of set+10 mΩ)
	H range	0 Ω to 0.667 Ω	0 Ω to 2.0 Ω	6.67 mΩ	20 mΩ	±(10 % of set+13.33 mΩ)	±(10 % of set+40 mΩ)
PCR18000LE2	L range	0 Ω to 0.111 Ω	0 Ω to 0.333 Ω	1.11 mΩ	3.33 mΩ	±(10 % of set+2.22 mΩ)	±(10 % of set+6.67 mΩ)
	H range	0 Ω to 0.444 Ω	0 Ω to 1.333 Ω	4.44 mΩ	13.32 mΩ	±(10 % of set+8.89 mΩ)	±(10 % of set+26.67 mΩ)
PCR27000LE2	L range	0 Ω to 0.0741 Ω	0 Ω to 0.222 Ω	0.741 mΩ	2.22 mΩ	±(10 % of set+1.48 mΩ)	±(10 % of set+4.44 mΩ)
	H range	0 Ω to 0.296 Ω	0 Ω to 0.889 Ω	2.96 mΩ	8.89 mΩ	±(10 % of set+5.93 mΩ)	±(10 % of set+17.78 mΩ)

## Output on/off phase setting

	Setting range	Resolution	Setting accuracy
Phase setting	0 deg to 359 deg	1 deg	±1 deg

## Communication interface (RS232C)

Software protocol	IEEE Std 488.2-1992
Command language	Complies with SCPI Specification 1999.0
RS232C	Complies with the EIA232D specifications D-SUB 9-pin connector (male, Use a cross cable (null modem cable)),
Baud rate	9600 bps/ 19200 bps/ 38400 bps
Data length	8 bit / 7 bit
Stop bit	1 bit / 2 bit
Parity bit	Fixed to none
Flow control	OFF/ RTS•CTS
Message terminator	LF

## Signal input/output

Trigger input	Pulse input for resuming the sequence function, BNC connector Photocoupler input, drive voltage: 5 V, DC resistance: approx. 470 Ω, active with 7 mA source, pulse width: 10 μs
Trigger output	Pulse output at the start of sequence step execution, BNC connector Open collector output, pulled up to +5 V with approx. 10 kΩ, DC resistance: 220 Ω, maximum sink current: 10 mA, pulse width: 10 μs
Status output	Output during periods T2, T3, and T4 in power line abnormality simulations and during a step output of the sequence function, BNC connector Open collector output, pulled up to +5 V with approx. 10 kΩ, DC resistance: 220 Ω, maximum sink current: 10 mA

# Main Unit Specifications (Cont.)

## General

		PCR6000LE2	PCR9000LE2	PCR12000LE2	PCR18000LE2	PCR27000LE2
Insulation resistance	Between input and chassis, output and chassis, input and output	500 Vdc, 10 MΩ or more				
Withstand voltage	Between input and chassis, output and chassis, input and output	1.5 kVac for 1 minute				
Circuit method		Linear amplifier system				
Environmental conditions	Operating environment	Indoor use, overvoltage category II				
	Operating temperature range	0 °C to +50 °C (32 °F to +122 °F)				
	Storage temperature range	-10 °C to +60 °C (14 °F to 140 °F)				
	Operating humidity range	20 %rh to 80 %rh (no condensation)				
	Storage humidity range	90 %rh or less (no condensation)				
	Altitude	Up to 2000 m				
Dimensions (chassis)		See the outline drawing.				
Weight		Approx. 140 kg (308.65 lb)	Approx. 190 kg (418.88 lb)	Approx. 350 kg (771.62 lb)	Approx. 480 kg (1058.22 lb)	Approx. 630 kg (1388.91 lb)
Input terminal	Single-phase two-wire input	M8	---	---	---	---
	Three-phase three/four-wire input	M5		M8		
Output terminal	Single-phase output	M8				
	Single-phase three-wire output, Three-phase output	M5		M8		
Accessories	Setup Guide	1 copy				
	Quick Reference	English: 1 copy, Japanese: 1 copy				
	Safety information	1 copy				
	CD-ROM	1 disc				
Electromagnetic compatibility (EMC) <sup>*1, *2</sup>		Complies with the requirements of the following directive and standards. EMC Directive 2014/30/EU EN 61326-1 (Class A <sup>*3</sup> ) EN 55011 (Class A <sup>*3</sup> , Group 1 <sup>*4</sup> ) The maximum length of all cables and wires connected to the PCR-LE2 Series must be less than 3 m.		---	---	---
Safety <sup>*1</sup>		Complies with the requirements of the following directive and standards. Low Voltage Directive 2014/35/EU <sup>*2</sup> EN 61010-1 (Class I <sup>*5</sup> , Pollution Degree <sup>2*6</sup> )		Complies with the requirements of the following standard. IEC 61010-1 (Class I <sup>*5</sup> , Pollution Degree <sup>2*6</sup> )		

\*1. Does not apply to specially ordered or modified PCR-LE2s.

\*2. Only on models that have the CE marking on the panel.

\*3. This is a Class A equipment. This product is intended for use in an industrial environment. This product may cause interference if used in residential areas. Such use must be avoided unless the user takes special measures to reduce electromagnetic emissions to prevent interference to the reception of radio and television broadcasts.

\*4. This is a Group 1 equipment. This product does not generate and/or use intentionally radio-frequency energy, in the form of electromagnetic radiation, inductive and/or capacitive coupling, for the treatment of material or inspection/analysis purpose.

\*5. This is a Class I equipment. Be sure to ground this product's protective conductor terminal. The safety of this product is only guaranteed when the product is properly grounded.

\*6. Pollution is addition of foreign matter (solid, liquid or gaseous) that may produce a reduction of dielectric strength or surface resistivity. Pollution Degree 2 assumes that only non-conductive pollution will occur except for an occasional temporary conductivity caused by condensation.

## Rated output current characteristics (Derating)

The output voltage ratio is a percentage where 100 % represents an output voltage of 100 V (output L range) or 200 V (output H range) in AC mode or DC mode. The output current ratio is a percentage where 100 % represents the maximum rated output current in AC mode or DC mode.

The instantaneous peak current ratio is the instantaneous peak current expressed as a percentage of the rated maximum output current.

The rated output current in AC mode depends on the output conditions (output voltage, load power factor, output frequency). The rated output current under given output conditions is the value obtained by converting the smaller of the two values: the product of the output current ratios derived from fig. 1 (output voltage) and fig. 3 (load power factor) and the output current ratio derived from fig. 4 (output frequency).

■ Fig.1 Output voltage ratio versus output current ratio (AC mode)

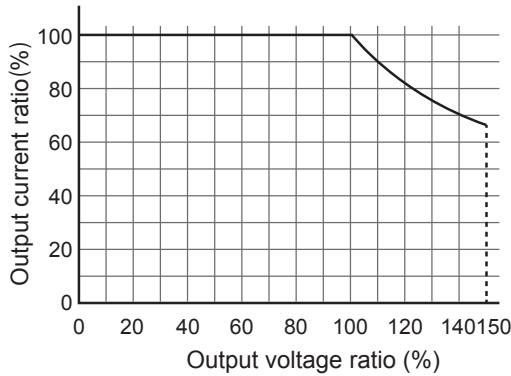

■ Fig.2 Output voltage ratio versus rated output current ratio (DC mode)

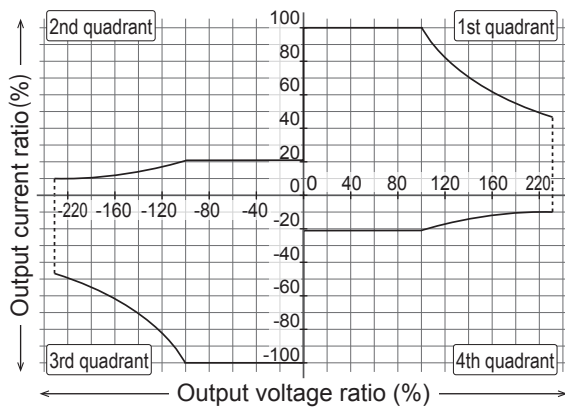

■ Fig.3 Load power factor versus output current ratio

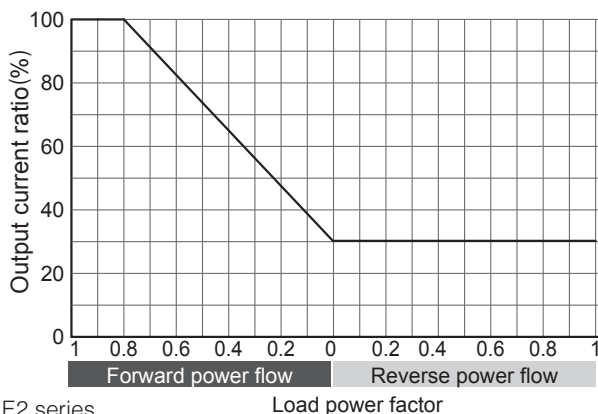

■ Fig.4 Output frequency versus output current ratio

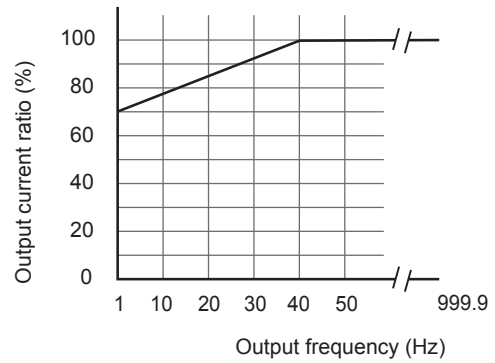

■ Fig.5 Instantaneous output voltage versus instantaneous peak current ratio (AC mode L range, excluding three-phase three-wire output)

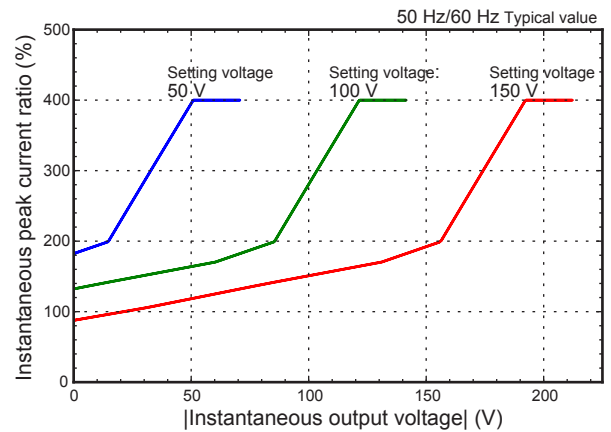

■ Fig.6 Instantaneous output voltage versus instantaneous peak current ratio (AC mode H range, excluding three-phase three-wire output)

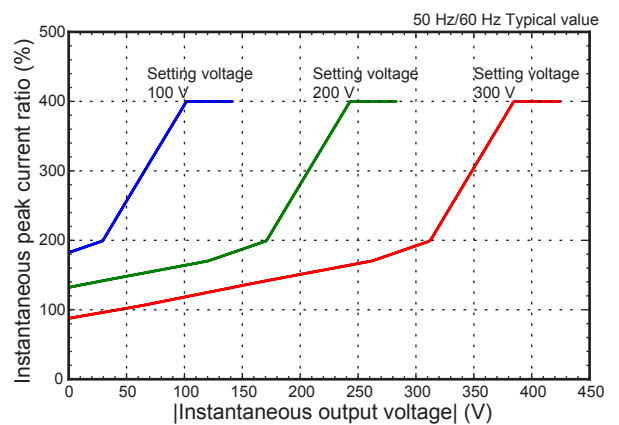

## Option Specifications

TYP: These are typical values. These values do not guarantee the performance of the PCR-LE2 Series.

### Communication interface (GPIB/ USB/ LAN)

The specifications of the IB05-PCR-LE (GPIB), US05-PCR-LE (USB), and LN05-PCR-LE (LAN) interface boards are provided below.

GPIB		Complies with IEEE Std 488.1-1987 SH1, AH1, T6, L4, SR1, RL1, PP0, DC1, DT1, C0, and E1 24-pin connector (receptacle)
	Message terminator	LF or EOI during reception, LF + EOI during transmission
	Primary address	1 to 30
USB		Complies with the USB 2.0 specifications. Data rate: 12 Mbps (full speed), Socket B type
	Message terminator	LF or EOM during reception, LF + EOM during transmission
	Device class	Complies with the USBTMC-USB488 device class specifications
LAN		IEEE 802.3 100Base-TX/10Base-T Ethernet Complies with the LXI Specification Ver.1.3 Class C, Data rate: 100 Mbps (Auto negotiation, full speed) AUTO MDIX function IPv4, RJ-45 connector (Category 5; use a straight cable.)
	Communication protocol	VXI-11/HiSLIP/SCPI-RAW
	Message terminator	VXI-11, HiSLIP: LF or END during reception, LF + END during transmission SCPI-RAW: LF

### Controlling the Output Using External Analog Signals

The following specifications specify the comprehensive performance achieved when the Analog Interface is installed in the PCR-LE2 AC power supply. Other specifications not given here comply with those for the PCR-LE2 AC power supply.

		EX05-PCR-LE	EX06-PCR-LE
Input terminal	Maximum allowable input voltage	±15 V	
	Type	BNC	
	Input impedance	10 kΩ ±10 %	
	Isolation voltage	±63 V <sub>peak</sub>	
Input voltage range	0 V to 1.5 V <sub>rms</sub> sine wave	0 Vdc to +10 Vdc	
Input frequency range <sup>*1</sup>	1 Hz to 2k Hz (Sine wave) 1 Hz to 200 Hz (Rectangular wave) DC	---	
Frequency characteristics	DC to 5k Hz: -3dB or less with respect to 200 Hz (On input of sine wave of 0.5 V <sub>rms</sub> )	---	
Voltage amplification ratio (L, H range)	100x, 200x (Outputs a 0 Vac to 150 Vac/0 Vac to 300 Vac with respect to an input of 0 Vac to 1.5 Vac)	15x, 30x (Outputs a 0 Vac to 150 Vac/0 Vac to 300 Vac with respect to an input of 0 Vdc to 10 Vdc)	
Frequency setting range	---	1 Hz to 999.9 Hz	
Output voltage distortion ratio <sup>*2</sup>	PCR-LE specifications + 0.5 % or less		
Output voltage temperature coefficient	PCR-LE specifications + 200 ppm/°C(TYP)		
Insulation resistance	Between input (BNC) and chassi, input(BNC) and input, input (BNC) and output	500 Vdc, 30 MΩ or more	
Withstand voltage	Between input (BNC) and output, input (BNC) and output	500 Vac for 1 minute	
Status signal output <sup>*3</sup>	OUTPUT ON STATUS	Turns on when the output is on.	
	ALARM STATUS	Turns on when an alarm/trouble is detected.	
	BUSY STATUS	Turns on when the busy status.	
	OOR STATUS	Turns on when the current limit is exceeded and when overload occurs.	
External control <sup>*4</sup>	OUTPUT CONTROL <sup>*5</sup>	Output on with a low level signal/Output on with a high level signal.	
	SEQ RUN <sup>*5</sup>	Run the sequence with a low level signal/Run the sequence with a high level signal.	
	ALARM CLR <sup>*5</sup>	Alarm clear with a low level signal/Alarm clearwith a high level signal.	
	SHUT DOWN <sup>*6</sup>	Output off with an open circuit/Output off with a short circuit	

\*1. The measurable range of voltage, current, and power is DC and 1 Hz to 999.9 Hz  
Set the frequency according to the input waveform period.

\*2. When DC current is applied for EX06-PCR-LE or when a sine wave with distortion ratio of 0.1 % or less is applied for EX05-PCR-LE.

\*3. Open collector outputs of photocouplers (30 Vdc, 8 mAmax.)

\*4. Set the logic using CONFIG settings. The internal circuit is pulled up to 12 V through 1.3 kΩ.

\*5. HIGH: Input terminal voltage of 11 V to 12 V or open; LOW: Input terminal voltage of 0 V to 1 V

\*6. Open: Open or input terminal voltage of 11 V to 12 V; Short: Input terminal voltage of 0 V to 1 V



# Outline Drawings

## ■ PCR6000LE2

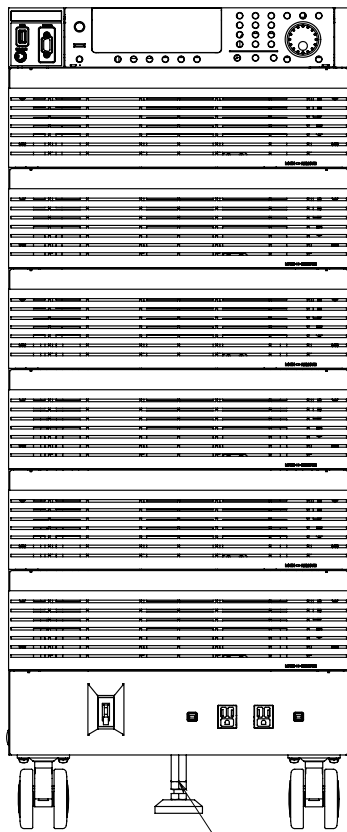
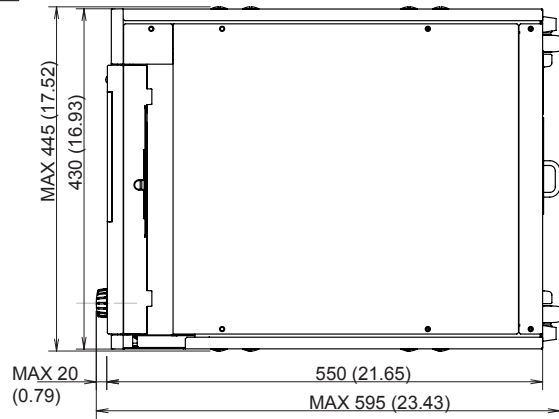
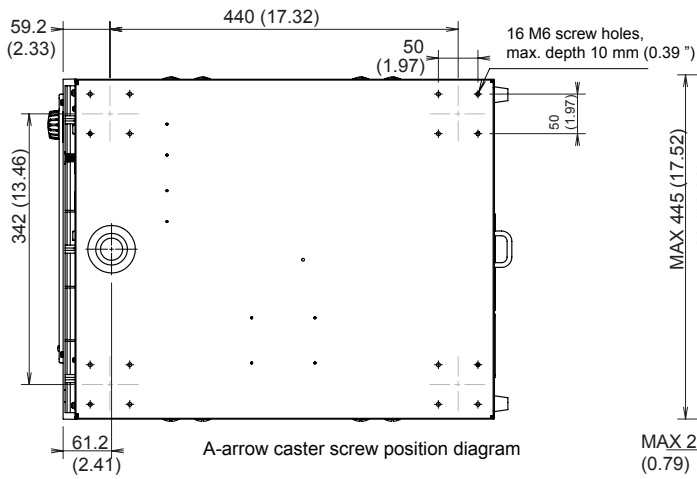

M12 screw hole, max. depth 35 mm (1.38 ")

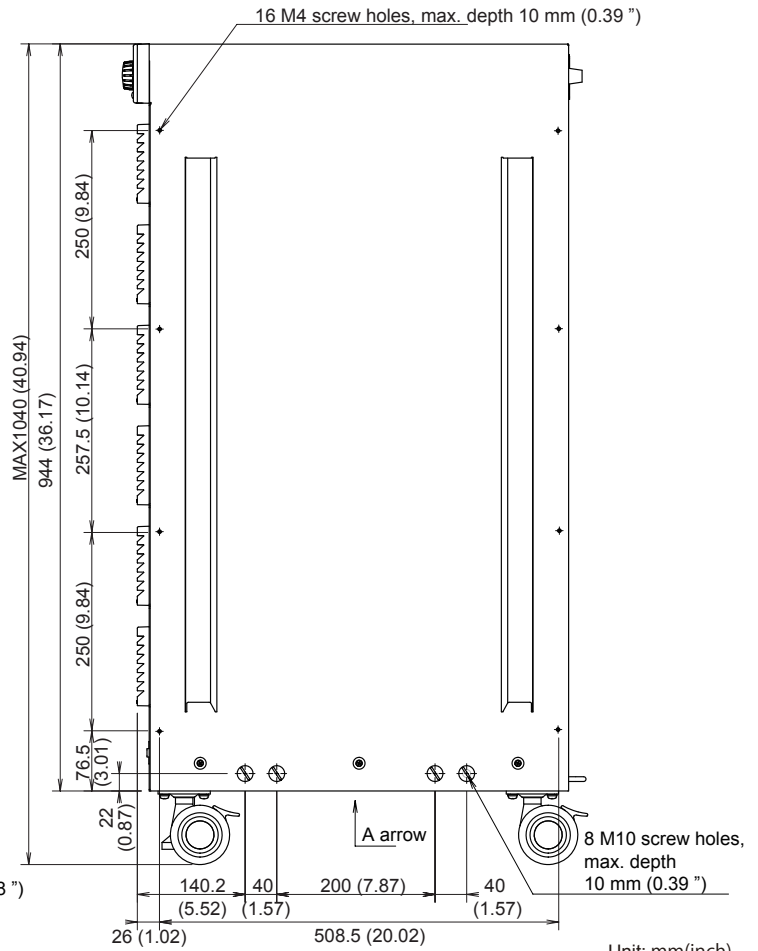

# Outline Drawings (Cont.)

## ■ PCR9000LE2

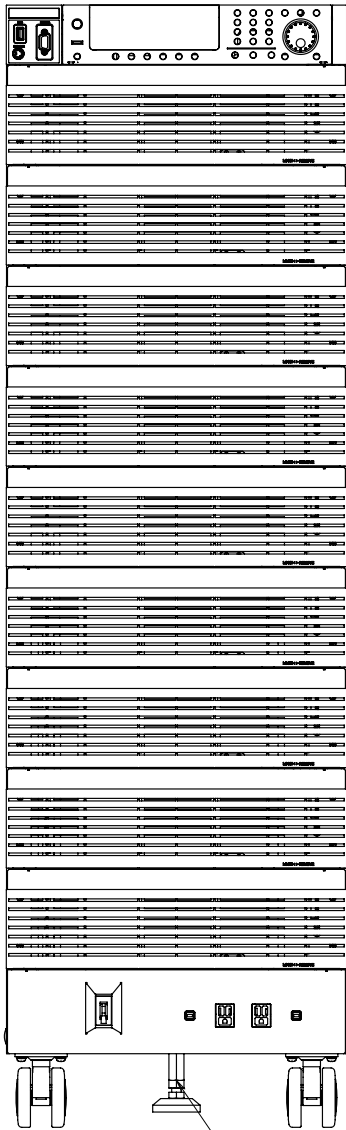
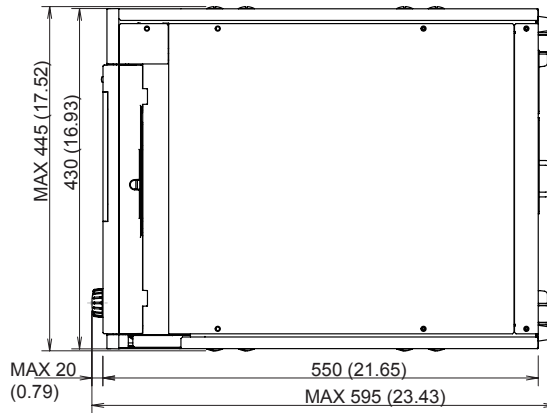
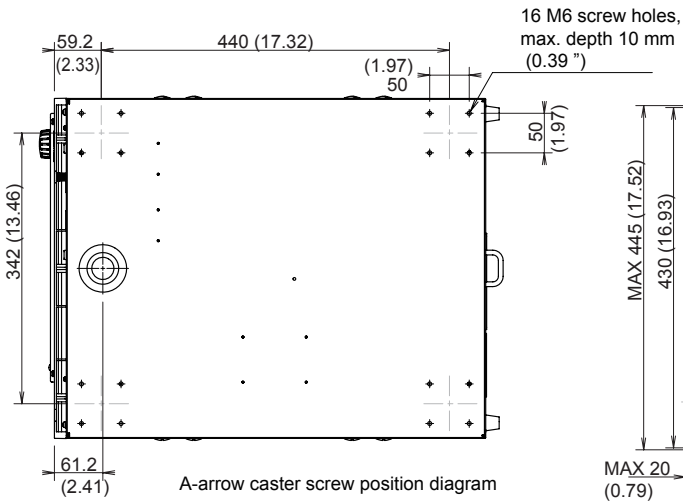

M12 screw hole, max. depth 35 mm (1.38")

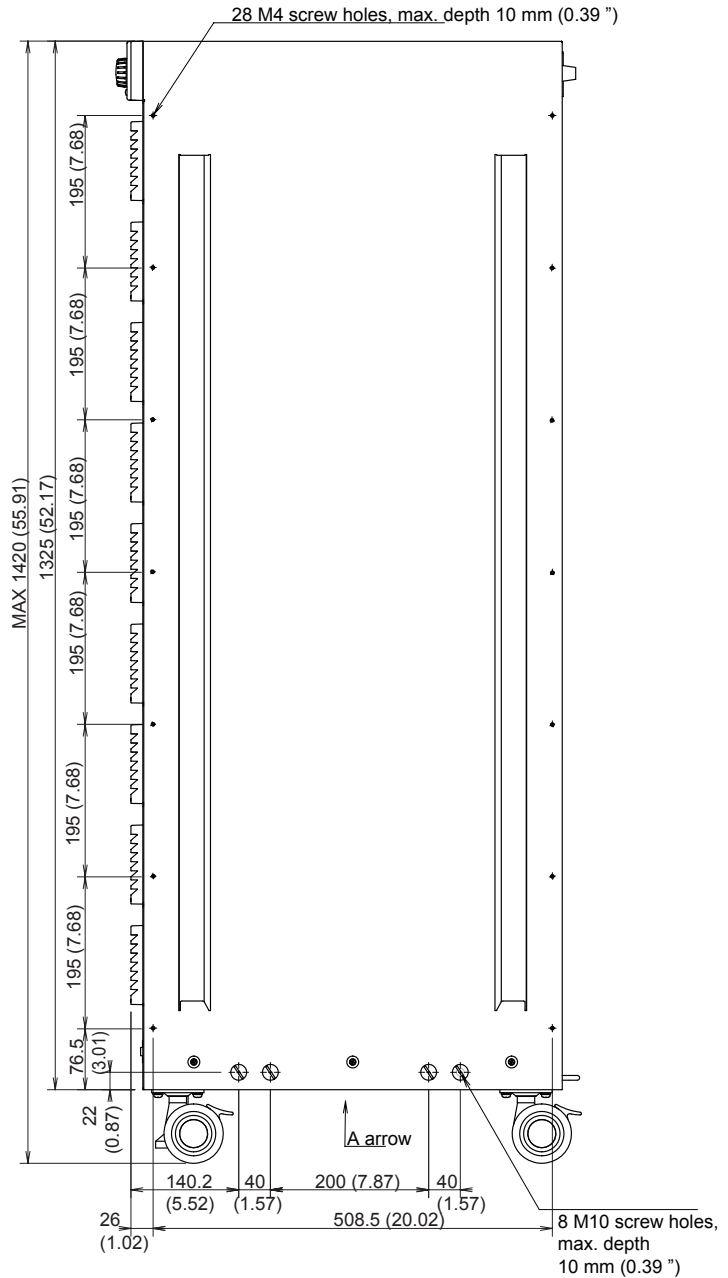

Unit: mm(inch)

■ PCR1200LE2

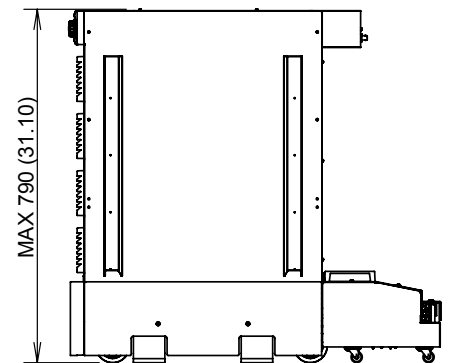
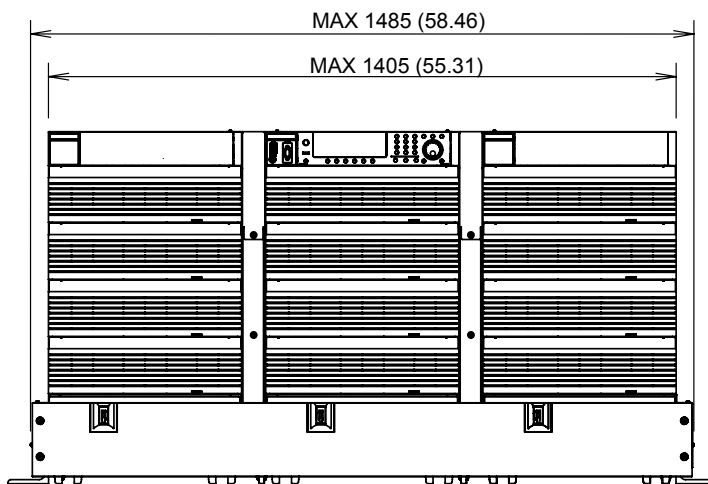
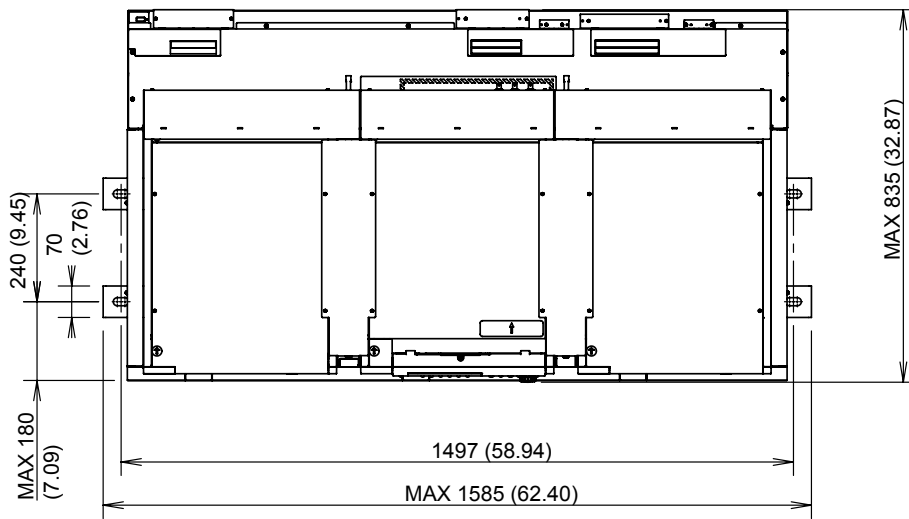

Unit: mm(inch)

# Outline Drawings (Cont.)

## ■ PCR18000LE2

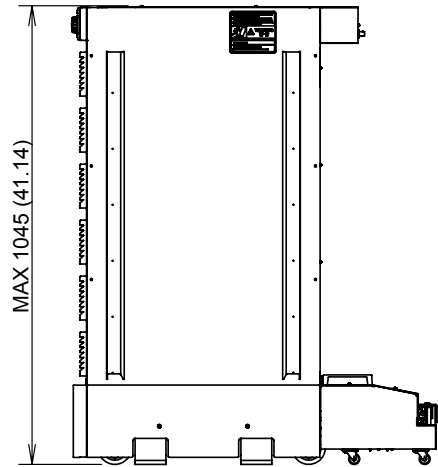
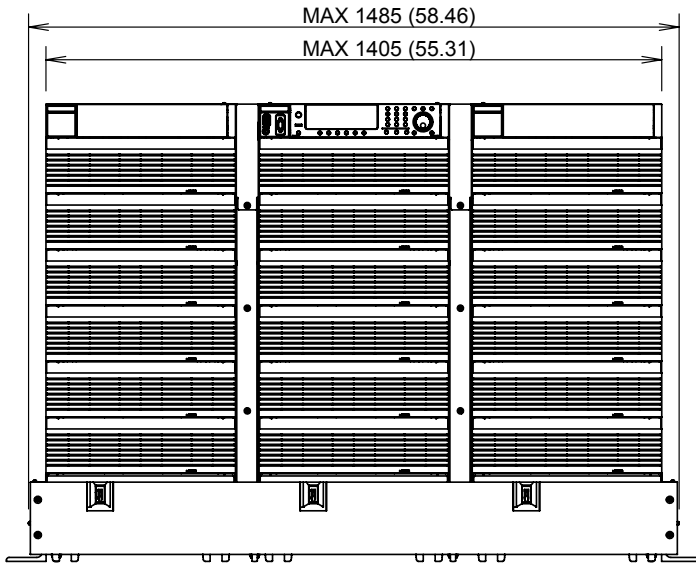
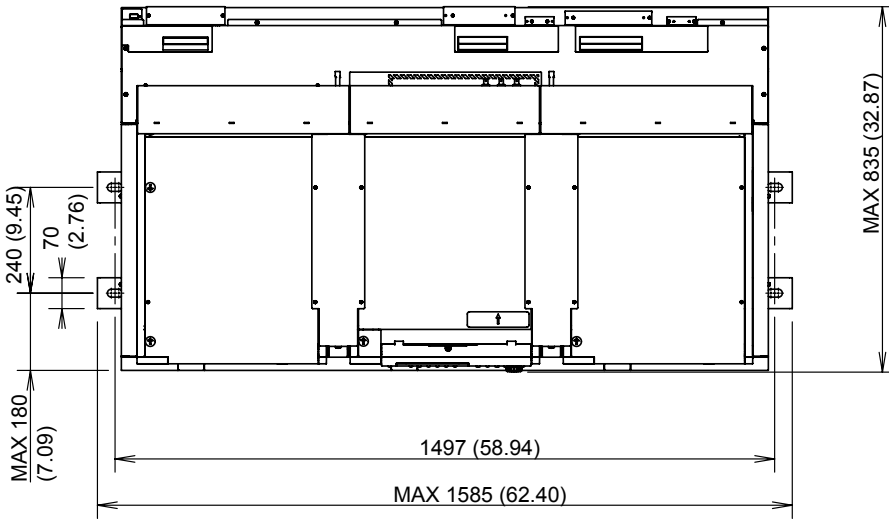

Unit: mm(inch)

■ PCR27000LE2

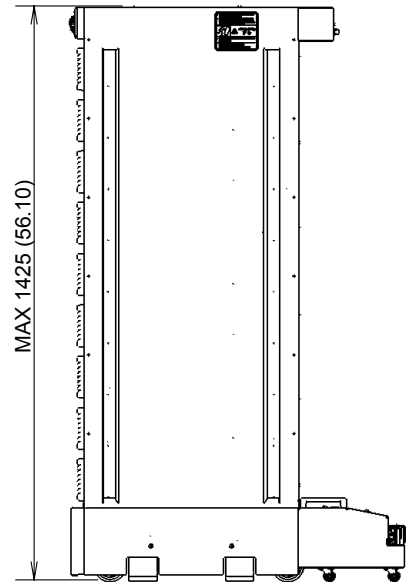
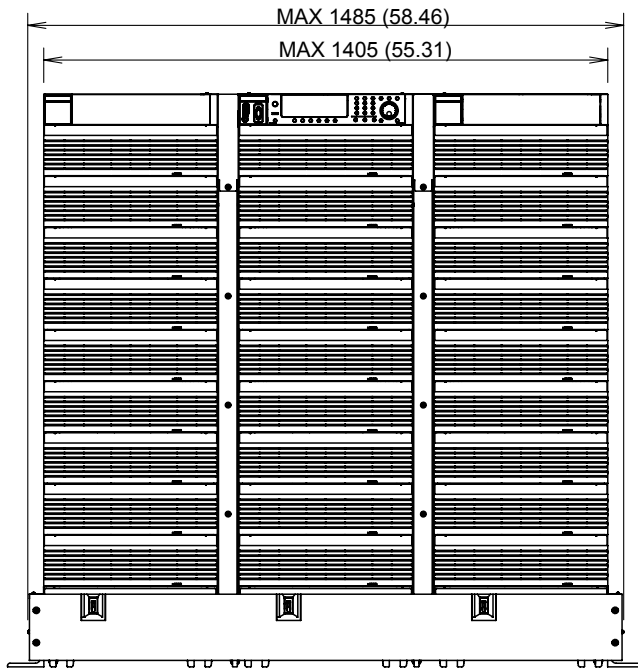
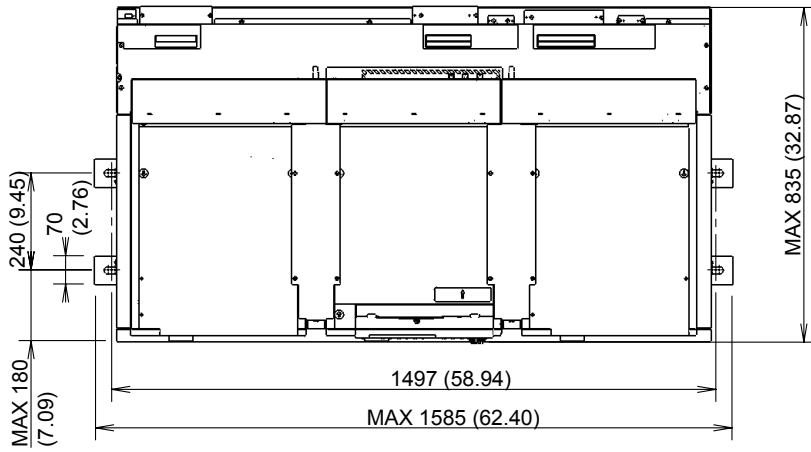

Unit: mm(inch)



## Glossary

### ■ Rated output capacity

This is the maximum output power capacity (in VA) that can be supplied continuously in the following ranges. For example, this is 6 kVA on the PCR6000LE2.

In DC mode, this value is 70 % of the value in AC mode.

		AC mode	DC mode
Output voltage	Output L range	100 V to 150 V	100 V to 212 V
	Output H range	200 V to 300 V	200 V to 424 V
Load power factor		0.8 to 1.0	NA
Output frequency		0 Hz to 999.9 Hz	NA

### ■ Rated output current

This is the maximum continuous output current (rms value). (Unit: A.)

The rated output current requires derating (reduction), which is performed according to the output conditions (output voltage, frequency, and load power factor).

### ■ Rated maximum output current

This is the maximum rms output current (in A) that can be supplied continuously in the following ranges. For example, this is 6 kVA on the PCR6000LE2.

In DC mode, this value is 70 % of the value in AC mode.

		AC mode	DC mode
Output voltage	Output L range	100 V	100 V
	Output H range	200 V	200 V
Load power factor		0.8 to 1.0	NA
Output frequency		40 Hz to 999.9 Hz	NA

$$\text{Rated maximum output current} = \frac{\text{Rated output capacity [VA]}}{\text{Voltage at 100 \% of the output voltage ratio [V]}^*}$$

\*: See p. 95, Output L range is 100 V, and output H range 200 V.

### ■ Maximum peak current (AC mode)

This is the maximum continuous output current (peak value in A<sub>peak</sub>) that the PCR-LE Series can supply when using a capacitor-input rectifier load.

Maximum peak current = rated maximum output current (rms) × 4

$$\text{Only when crest factor} = \frac{\text{Peak value}}{\text{Rms value}} \leq 4$$

Output voltage: 100 V to 150 V (for output L range)

200 V to 300 V (for output H range)

Output frequency: 40 Hz to 999.9 Hz

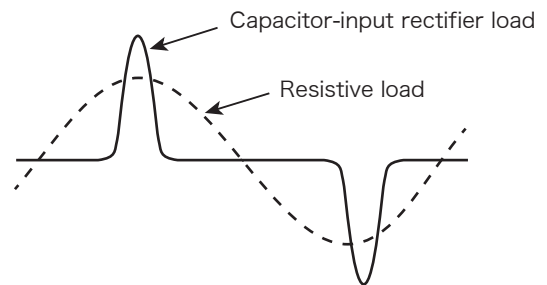

### ■ Maximum instantaneous current (DC mode/ AC+DC mode)

This is the maximum instantaneous output current (peak current in A<sub>peak</sub>) that can be supplied to the load in DC mode or AC+DC mode.

Maximum instantaneous current = Rated maximum output current × 3.6

### ■ Instantaneous peak current (AC mode)

This is the maximum instantaneous output current (peak current in A<sub>peak</sub>) that can be supplied to the load in AC mode.

This depends on the output range, voltage setting, and instantaneous output voltage.

The instantaneous peak current near the peak value of the instantaneous output voltage is four times the rated maximum output current (maximum peak current), but it decreases in accordance with the reduction in the absolute value of the instantaneous output voltage.

Figs. 10 and 11 (p. 99) show “Instantaneous output voltage versus instantaneous peak current ratio” for the representative voltage settings of each range.

### ■ Instantaneous peak current ratio

This is the instantaneous peak current as a percentage where the rated maximum output current is 100 %.

### ■ Output current ratio

This is the output current as a percentage where the rated maximum output current is 100 %.

## Glossary (Cont.)

### ■ Output voltage ratio

This is the output voltage as a percentage where 100 V for the output L range or 200 V for the output H range is 100 %.

### ■ Output voltage waveform distortion ratio

This is the total harmonic distortion (in %) of the output voltage waveform when the output voltage is between 80 V and 150 V (for output L range) or between 160 V and 300 V (for output H range) and the load power factor is 1.

### ■ Output voltage response speed

This is the time duration defined by the output voltage change exceeding 10 % of the total change and then returning back to 10 % or less of the total change when the output current ratio has changed from 0 % to 100 % under the following conditions: the output voltage is 100 V (for output L range) or 200 V (for output H range) and the load power factor is 1 (in AC mode). (The unit is  $\mu\text{s}$ .)

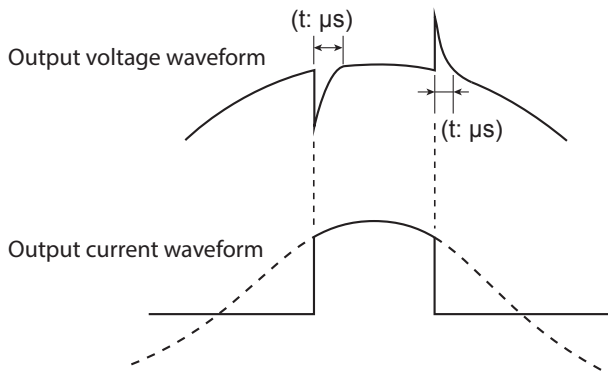

### ■ Capacitor-input rectifier load (circuit)

This is a load whose rectifier circuit part is constructed as shown below. The rectifier circuit is used to convert the input AC voltage into the DC voltage that the device needs to operate.

The peak input current is normally approximately two to four times the rms value. The conduction angle (the period that the current is flowing for) centered on the peak output voltage (phase angle of 90 deg or 270 deg) is approximately 20 deg to 90 deg.

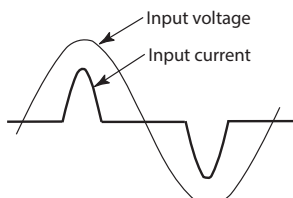
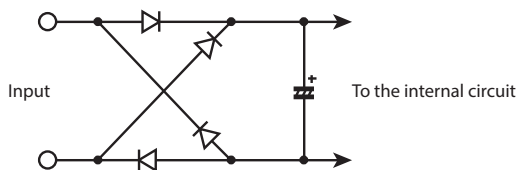
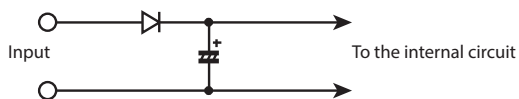

### ■ Derating

"Derating" means "reducing." In general, this refers to using a device at reduced maximum rated values (such as the voltage and the current) depending on the ambient conditions (such as the temperature and load).

### ■ Voltage dip

This refers to situations in which the voltage in a commercial power line drops momentarily due to the effects of lightning and other similar phenomena.

Generally, these voltage drops last for several tens of milliseconds to several hundreds of milliseconds, and the voltage drops by 20 % to 80 %.



# Operating Characteristics

## Output current versus input current and efficiency characteristics (typical values in AC mode)

The output current ratio is a percentage where 100 % represents the maximum rated output current.

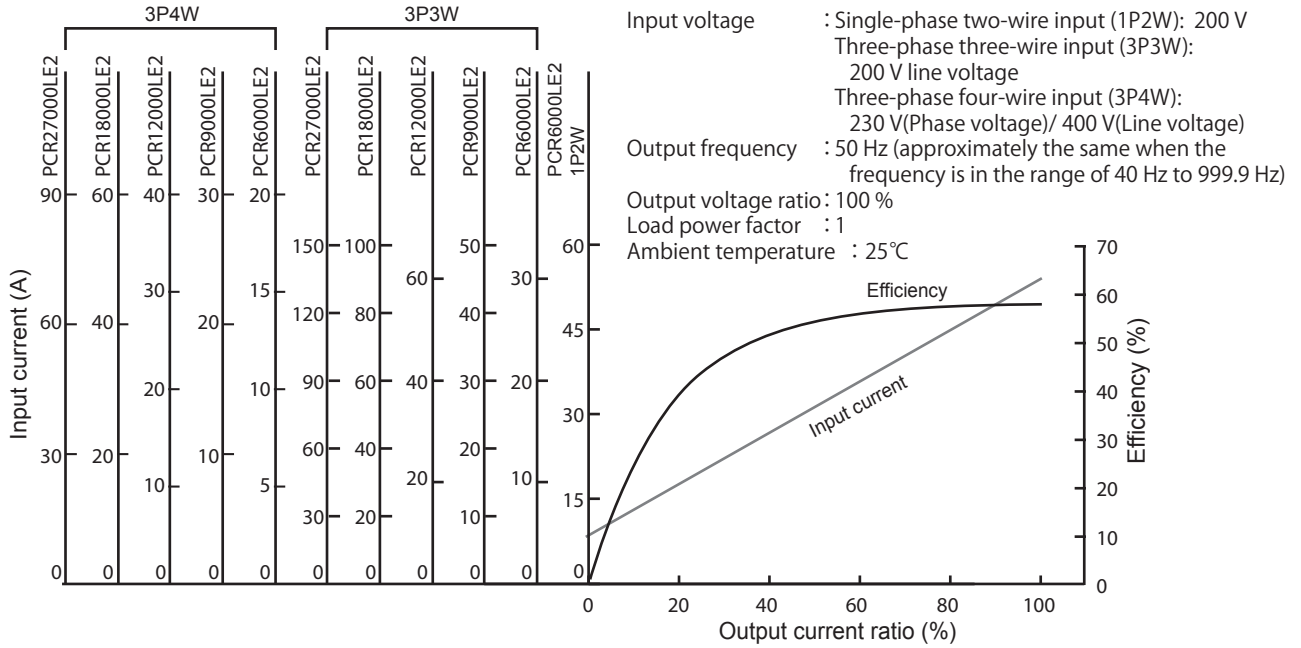

## Output voltage versus input current and efficiency characteristics (typical values in AC mode)

The output voltage ratio is a percentage where 100 % represents an output voltage of 100 V (output L range) or 200 V (output H range).

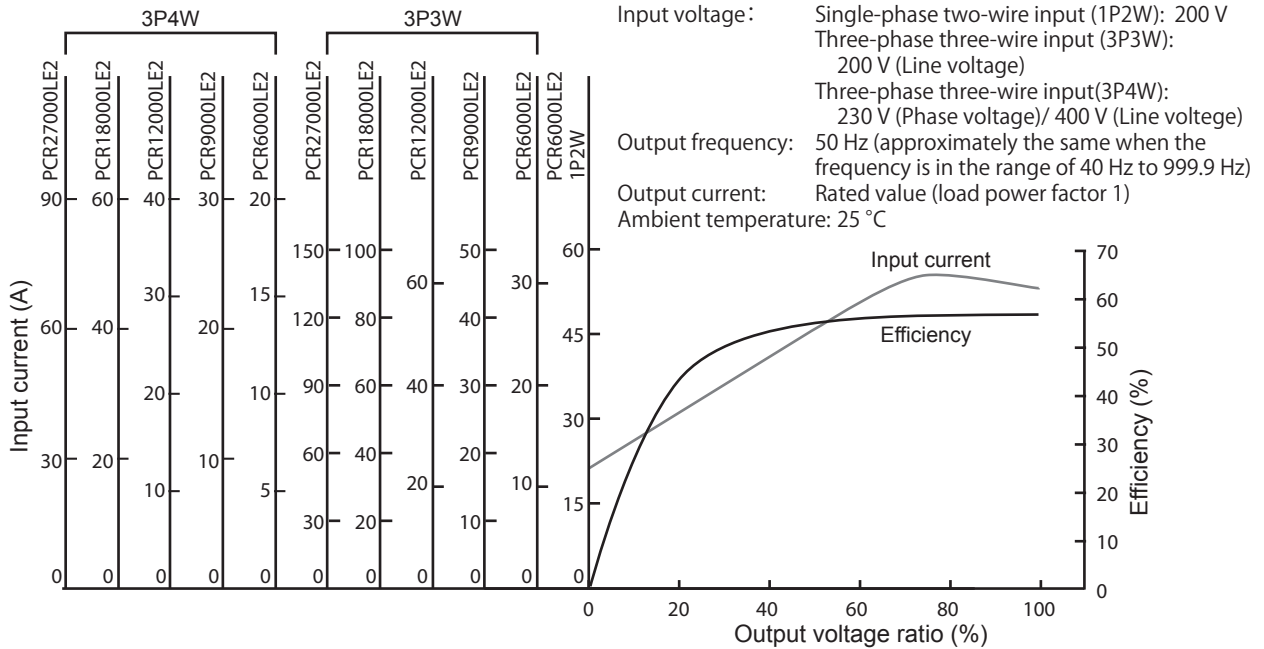

# About the output and the load

## Rated output current in AC mod

The rated current is automatically derated (reduced) depending on the output conditions (output voltage, frequency, and load power factor).

Output voltage ratio:

A percentage where 100 % represents an output voltage of 100 V (output L range) or 200 V (output H range).

Output current ratio:

A percentage where 100 % represents the rated maximum output current.

Instantaneous peak current ratio:

A percentage where 100 % represents the rated maximum output current.

Rated maximum output current:

Single-phase output

	PCR 6000LE2	PCR 9000LE2	PCR 12000LE2	PCR 18000LE2	PCR 27000LE2
L range	60 A	90 A	120 A	180 A,	270 A
H range	30 A	45 A	60 A	90 A	135 A

Single-phase three-wire output/ Three-phase output

	PCR 6000LE2	PCR 9000LE2	PCR 12000LE2	PCR 18000LE2	PCR 27000LE2
L range	20 A	30 A	40 A	60 A,	90 A
H range	10 A	15 A	20 A	30 A	45 A

- Fig.7 Output voltage ratio versus output current ratio (AC mode)

Output current ratio [%] when the output voltage setting (AC-volt) is between 0 V and 100 V (L range) or between 0 V and 200 V (H range): 100

Output current ratio [%] when the output voltage setting (AC-volt) is 100 V or higher (L range) or 200 V or higher (H range):  $100 / \text{Output voltage ratio} \times 100$

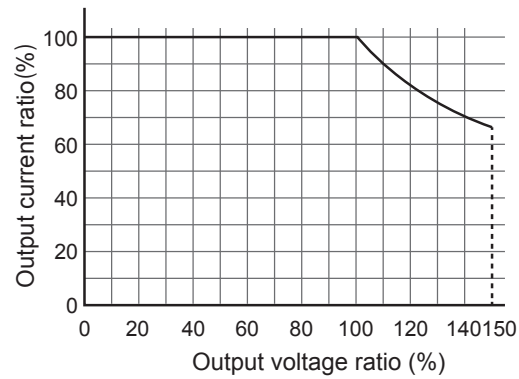

- Fig.8 Load power factor versus output current ratio

Output current ratio [%] when the load power factor is greater than 0.8: 100

Output current ratio [%] for forward power flow when the load power factor is less than or equal to 0.8:

$$30 + \text{load power factor} \times 70 / 0.8$$

Output current ratio [%] for reverse power flow: 30

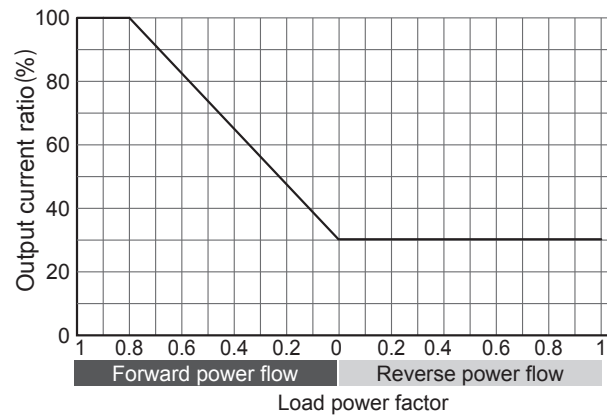

- Fig.9 Output frequency versus output current ratio  
 Output current ratio [%] when the output frequency (Freq) is less than 40 Hz:  $70 + \text{output frequency} \times 30 / 40$   
 Output current ratio [%] when the output frequency (Freq) is greater than or equal to 40 Hz: 100

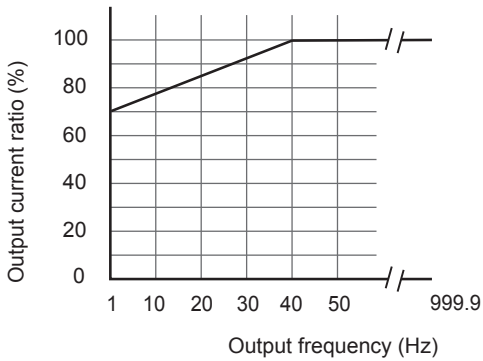

- Fig.10 Instantaneous output voltage ratio versus instantaneous peak current ratio (AC mode L range, excluding three-phase three-wire output)

The instantaneous output voltage is the instantaneous value of the output voltage waveform.

This shows the instantaneous peak current ratio in relation to the instantaneous output voltage when the output voltage is set to 50 V, 100 V, and 150 V.

For example, the instantaneous peak current that can be supplied when the setting voltage is 100 V is 160 % of the rated current (rms) when the instantaneous output voltage is 50 V and 280 % of the rated current (rms) when the instantaneous output voltage is 100 V.

During three-phase three-wire output, the instantaneous peak current ratio is limited also by the instantaneous output voltage of other phases.

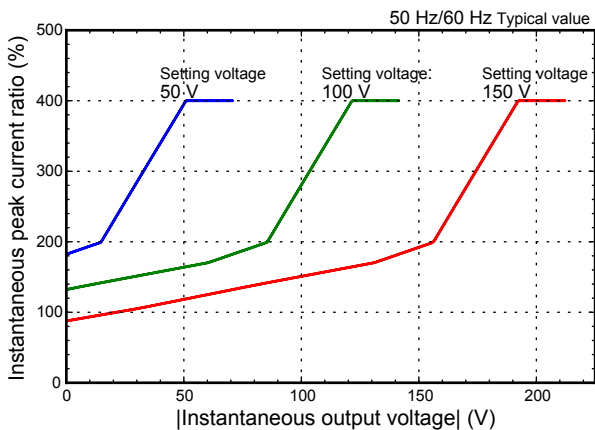

- Fig.11 Instantaneous output voltage ratio versus instantaneous peak current ratio (AC mode H range, excluding three-phase three-wire output)

The instantaneous output voltage is the instantaneous value of the output voltage waveform.

This shows the instantaneous peak current ratio in relation to the instantaneous output voltage when the output voltage is set to 100 V, 200 V, and 300 V.

For example, the instantaneous peak current that can be supplied when the setting voltage is 200 V is 160 % of the rated current (rms) when the instantaneous output voltage is 100 V and 280 % of the rated current (rms) when the instantaneous output voltage is 200 V.

During three-phase three-wire output, the instantaneous peak current ratio is limited also by the instantaneous output voltage of other phases.

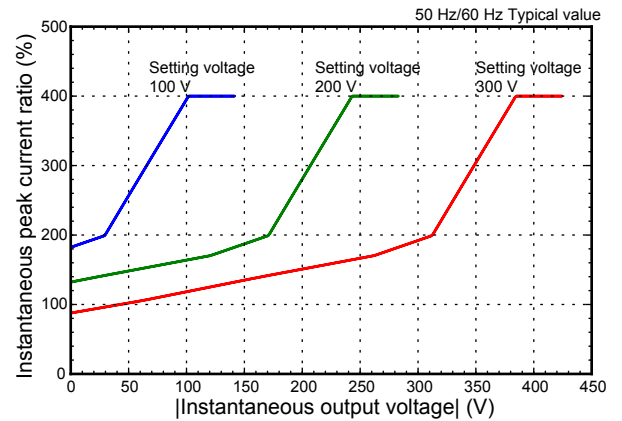

## About the output and the load (Cont.)

### Rated output current in AC mod (Cont.)

#### ■ How the rated output current is determined on the PCR6000LE2

The rated output current in AC mode depends on the output conditions (output voltage, load power factor, output frequency). The rated output current under given output conditions is the value obtained by converting the smaller of the two values: the product of the output current ratios derived from fig. 7 (output voltage) and fig. 8 (load power factor) and the output current ratio derived from fig. 9 (output frequency).

The full scale of the load level meter of control panel is set to 1.1 times the calculated rated current or the current limit, whichever is less.

#### Example

If you use the PCR-LE2 Series under conditions that exceed those that produce the rated output currents described below, the protection functions may be activated, which may cause the output voltage to drop, or turn off the output.

#### Example 1: The output voltage is 80 V (L range), the load power factor is 0.6, and the output frequency is 50 Hz.

From the fig.7, the output current ratio at an output voltage of 80 V is 100 %. -- (a)

From the fig.8, the output current ratio at a load power factor of 0.6 is 82.5 %. --- (b)

From the fig.9, the output current ratio at an output frequency of 50 Hz is 100 %. --- (c)

From (a) and (b), the output current ratio at an output voltage of 80 V and a load power factor of 0.6 is

$$(a) \times (b) = 82.5 \% \text{ ----- (d)}$$

Because (d) is smaller than (c), the output current ratio is limited by (d), which was calculated as (d). Therefore, the maximum output current ratio is 82.5 %.

On the PCR6000LE2, the rated maximum output current for the output L range is 60 A (Single-phase output), so the rated output current under the above conditions is

$$60 \times 0.825 = 49.5 \text{ A}$$

#### Example 2: The output voltage is 250 V (H range), the load power factor is 0.4, and the output frequency is 60 Hz.

From the fig.7, the output current ratio at an output voltage of 250 V is 80 %. -- (a)

From the fig.8, the output current ratio at a load power factor of 0.4 is 65 %. --- (b)

From the fig.9 the output current ratio at an output frequency of 60 Hz is 100 %. --- (c)

From (a) and (b), the output current ratio at an output voltage of 250 V and a load power factor of 0.4 is

$$(a) \times (b) = 52 \% \text{ ----- (d)}$$

Because (d) is smaller than (c), the output current ratio is limited by (d). Therefore, the maximum output current ratio is 52 %.

On the PCR6000LE2, the rated maximum output current for the output H range is 30 A (Single-phase output), so the rated output current under the above conditions is

$$30 \times 0.52 = 15.6 \text{ A}$$

**Example 3: The output voltage is 80 V (L range), the load power factor is 0.6, and the output frequency is 10 Hz.**

From the fig.7, the output current ratio at an output voltage of 80 V is 100 %. -- (a)

From the fig.8, the output current ratio at a load power factor of 0.6 is 82.5 %. --- (b)

From the fig.9 the output current ratio at an output frequency of 10 Hz is 77.5 %. --- (c)

From (a) and (b), the output current ratio at an output voltage of 80 V and a load power factor of 0.6 is

$$(a) \times (b) = 82.5 \% \text{ ----- (d)}$$

Because (c) is smaller than (d), the output current ratio is limited by (c). Therefore, the maximum output current ratio is (c) = 77.5 %.

On the PCR6000LE2, the rated maximum output current for the output H range is 30 A (Single-phase output), so the rated output current under the above conditions is

$$30 \times 0.775 = 46.5 \text{ A}$$

## About the output and the load (Cont.)

### Rated output current in AC mod (Cont.)

#### How peak current that can be supplied is determined (for single-phase output)

As shown in figs. 10 and 11, "Instantaneous output voltage versus instantaneous peak current ratio," the peak current supply performance depends on the output range, voltage setting, and instantaneous output voltage.

Figs. 12 and 13 show the range in which peak current can be supplied (range between two solid lines) for the voltage waveforms (broken lines) at the representative voltage settings of each range.

The instantaneous peak current near the peak value of the instantaneous output voltage is four times the rated maximum output current (maximum peak current), but it decreases in accordance with the reduction in the absolute value of the instantaneous output voltage. If this range is exceeded, the protection functions of this product may be activated, which may distort the output voltage waveform or turn off the output.

For loads through which inrush current flows, such as transformers, motors, lamps, and capacitor-input rectifier circuits, check the current waveform, and provide adequate margin so that the peak current supply range is not exceeded. In addition, keep the rms value of the output current from exceeding the rated output current or in the case of reverse power flow, 30 % of the rated output current.

- Fig.12 Voltage waveform versus peak current supply range (AC mode L range)

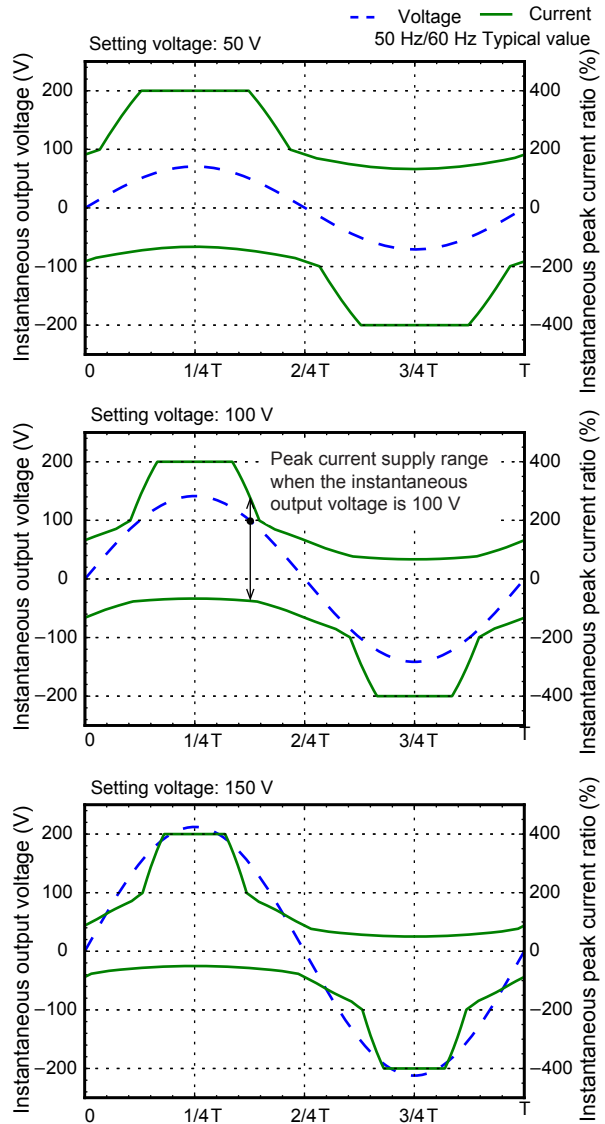

- Fig.13 Voltage waveform versus peak current supply range (AC mode H range)

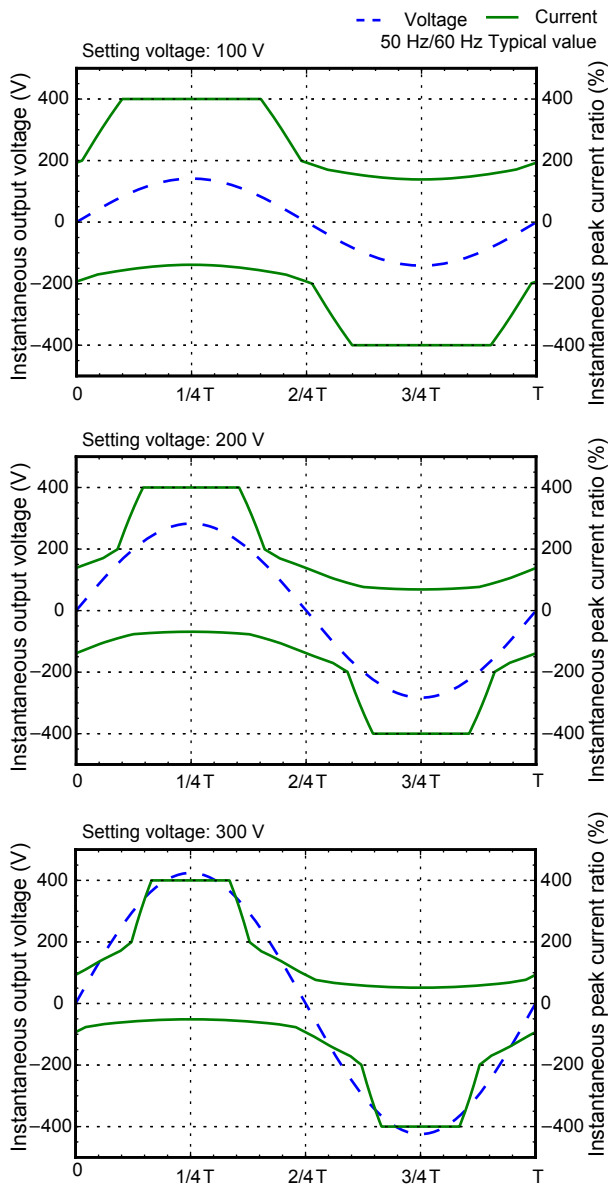

### How peak current that can be supplied is determined (for three-phase output)

Also for three-phase output, the peak current supply performance depends on the output range, voltage setting, and instantaneous output voltage as shown in fig. 10 and fig. 11, "Instantaneous output voltage versus instantaneous peak current ratio."

If you are using three-phase four-wire output, read "setting voltage" as "setting phase voltage" and "instantaneous output voltage" as "instantaneous value of phase voltage" in fig. 10 and fig. 11.

If you are using three-phase three-wire output, because the phase voltages of the two phases are connected in series as shown in the following figure, the instantaneous peak current ratio is limited also by the instantaneous output voltage of the other phase. As such, the instantaneous peak current ratio when the instantaneous output voltage of the other phase is near 0 V may be lower than the rating.

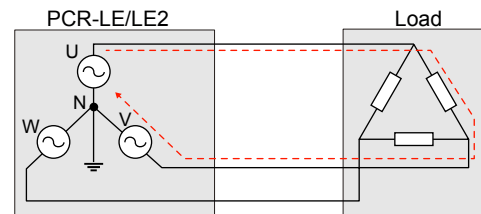

## About the output and the load (Cont.)

### Rated output current in AC mod (Cont.)

#### ■ Capacitor-input rectifier loads

For electronic devices that have capacitor-input rectifier circuits in their input, when the output voltage approaches the peak output voltage, a peak current several times greater than the output current rms value flows as the output current.

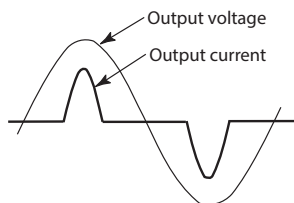

As shown in figs. 10 to 13, keep the maximum peak current near the peak value of the instantaneous output voltage from exceeding four times the rated maximum output current.

$$\text{Rated maximum output current} = \frac{\text{Rated output capacity [VA]}}{\text{Voltage at 100 \% of the output voltage ratio [V]*}}$$

\*: Output L range is 100 V, and output H range 200 V.

The output current rms should not exceed the rated output current value calculated with the load power factor set to 1, as explained in "Linear load".

If you use the PCR-LE2 Series with an output current that exceeds the rated output current (peak or rms value) specified above, the protection functions may be activated, which may distort the output voltage waveform or turn off the output.

You can only supply the maximum peak current described above without any distortions when the output voltage (the setting) is fixed. If the output voltage setting is changed suddenly (increased), the voltage and current waveforms may be distorted. Even if you are executing power line abnormality simulations or sequences, distortions may occur in the same manner if the output voltage is changed suddenly. To supply the maximum peak current without distortions, fix the output voltage setting and then turn the output on.

#### ■ Loads that generate surges

Some loads (for example, fluorescent lights) generate surges when the voltage is applied to the load or when the voltage is changed suddenly. When a surge occurs, the PCR-LE2 Series may malfunction. For this type of load, connect a noise filter to the output cable.

#### ■ Special loads

If you connect a capacitor directly to the OUTPUT terminal block or the OUTPUT outlets, the output waveform may be distorted. In this situation, connect the capacitor to the load side of the output wiring.

#### ■ Loads that draw an inrush current

For loads such as those listed below, when the voltage is applied to the load or when the voltage changes suddenly, an inrush current (several times to several tens of times the normal current) flows for several cycles to several tens of cycles of the output frequency.

##### • Transformer and slide transformer (SLIDAC) loads

When a voltage is applied to a transformer or a slide transformer, an inrush current of up to several hundreds of times the normal current will flow for several cycles depending on the timing that the voltage is applied or the residual magnetization in the transformer.

##### • Motor and lamp loads

When a voltage is applied to a motor or a lamp, an inrush current of several times to several tens of times the normal current flows for several tens of cycles to several hundreds of cycles.

##### • Capacitor-input rectifier loads

For electronic devices that have capacitor-input rectifier circuits in their input, if the device does not have an inrush current protection (limitation) circuit, an inrush current of several tens to several hundreds of times the normal current flows for several cycles.

As shown in figs. 10 to 13, for capacitor-input rectifier loads, this product can supply maximum peak current up to four times the rated maximum output current near the peak value of the instantaneous output voltage.

For other loads, this product can supply maximum peak current up to 200 % of the instantaneous peak current ratio for the specified trip time (TRIP TIM) even if the rms value of the output current exceeds the rated output current (varies depending on the current waveform, output voltage, output frequency, and the like).

Examples of the instantaneous peak currents that can be supplied when TRIP is set to ENABLE, the output voltage is set to 100 V, and the output frequency is set to 50 Hz are shown in the following table.

Load power factor	Instantaneous peak current ratio (%) <sup>*1</sup> [%]
1.0	200
0.9	160
0.8	150
0.6	140
0.4	120
0.2	110

<sup>\*1</sup>. The output current ratio as a percentage where 100 % represents the maximum output current of the PCR-LE2 Series

If an inrush current that exceeds the peak currents listed above flows, the protection circuits of the PCR-LE2 Series will be activated, which may distort the output voltage waveform or turn off the output.

Particularly for inductive loads such as transformers and motors, if the protection circuit is activated and the output is turned off, a reverse voltage exceeding the voltage setting may be generated and appear at the output terminals.



## Rated output current in DC/AC+DC mode

The rated DC output current that the PCR-LE2 Series can generate is limited by the output voltage.

Output voltage ratio:

A percentage where 100 % represents an output voltage of 100 V (output L range) or 200 V (output H range).

Output current ratio:

A percentage where 100 % represents the maximum rated current.

Maximum rated current:

Single-phase output

	PCR 6000LE2	PCR 9000LE2	PCR 12000LE2	PCR 18000LE2	PCR 27000LE2
L range	42 A	63 A	84 A	126 A	189 A
H range	21 A	31.5 A	42 A	63 A	94.5 A

Single-phase three-wire output/ Three-phase output

	PCR 6000LE2	PCR 9000LE2	PCR 12000LE2	PCR 18000LE2	PCR 27000LE2
L range	14 A	21 A	28 A	42 A	63 A
H range	7 A	10.5 A	14 A	21 A	31.5 A

- Output voltage ratio versus rated output current in DC mode

Unlike with resistive loads, when a power supply that alternates voltage polarity based on time is applied to an inductive or capacitive load, the current phase becomes lagging or leading to the voltage phase.

If this occurs, there are four possible combinations of the voltage and current polarities. This operation is shown on a graph of voltage (vertical axis) versus current (horizontal axis). The PCR-LE2 Series operates in all four quadrants (and thus the name four-quadrant operation). Power supplies that can operate in this manner are called bipolar power supplies.

Output current ratio [%] of the first quadrant and third quadrant

Output current ratio [%] when the output voltage setting (DCvolt) is between 0 V and 100 V (L range) or between 0 V and 200 V (H range): 100

Output current ratio [%] when the output voltage setting (DCvolt) is 100 V or higher (L range) or 200 V or higher (H range):  $100 / \text{Output voltage ratio} \times 100$

Output current ratio [%] of the second quadrant and fourth quadrant

Output current ratio [%] when the output voltage setting (DCvolt) is between 0 V and 100 V (L range) or between 0 V and 200 V (H range): 21

Output current ratio [%] when the output voltage setting (DCvolt) is 100 V or higher (L range) or 200 V or higher (H range):  $100 / \text{Output voltage ratio} \times 21$

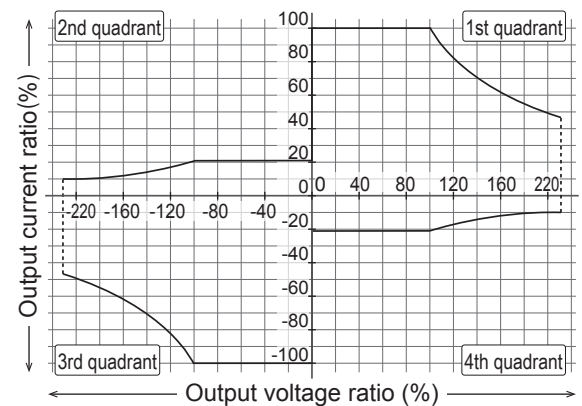

If you use the PCR-LE2 Series with a current that exceeds the rated DC output current, the protection functions will be activated, which may cause the output voltage to drop or turn off the output.

## Peak hold current measurement

The differences between the peak measurement and the peak hold measurement are shown below.

### ■ Peak measurement

The peak measurement is cleared once per measurement cycle.

The PCR-LE2 Series makes peak measurements by measuring the current peaks and then taking the maximum absolute value of the measured data. The peak current display shows an absolute value with no positive or negative sign. The peak value can be measured in AC, DC, and AC+DC modes.

### ■ Peak hold measurement

The peak hold measurement is held until the maximum peak value is cleared. The peak hold current measurement is useful when you are measuring the inrush current when the power is turned on and in similar situations.

The PCR-LE2 Series makes peak hold measurements by measuring the current peaks and then taking the maximum absolute value of the measured data. The peak current display shows an absolute value with no positive or negative sign. The peak hold value can be measured in AC, DC, and AC+DC modes.

You can capture peaks that continue for at least a specified length of time (t).

In AC mode,  $t = \frac{1}{256 \times f_0}$  s     $f_0$  is the output frequency.

In DC mode,  $t = 20 \mu\text{s}$

The peak current depends greatly on the PCR-LE's current supply capabilities. Ensure that the output capacity of the PCR-LE Series is sufficient for the load.

# Sequence tutorial

Below are tutorials for creating sequences.v

- Sequence creation basics

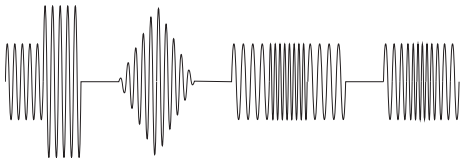

Describes basic sequence settings (voltage, frequency, and ramp).

- Voltage sweep and frequency sweep



Describes how to sweep a waveform using the ramp function.

- Switching steps at specific phase angles



Describes how to start subsequent steps from specified angles after previous steps are completed. The phase is continuous.

- Suddenly changing the phase



Describes how to suddenly change the phase between steps.

- Single-phase, three-wire output and three-phase output basics

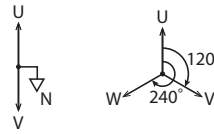

Describes the waveforms that are produced for single-phase, three-wire output and three-phase output.

- Phase setting for multi-phase output



Describes how to set a sequence so that the phase suddenly changes for multi-phase output.

- Phase sweep

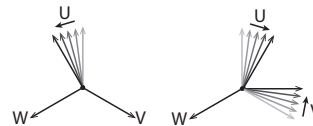

Describes how to set a sequence so that the phase is swept for multi-phase output.

- Line voltage dip

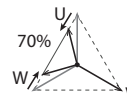

Describes how to set a line voltage dip.

# Sequence tutorial (Cont.)

## Sequence creation basics

This page explains how to use a sequence to output the following waveform.

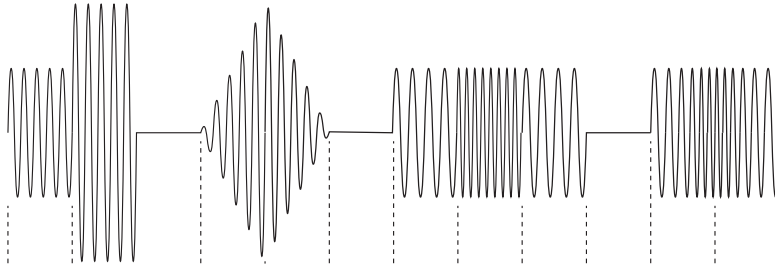

STEP	0	1	2	3	4	5	6	7	8	9	10	11	Step
ACVOLT [V]	5.0	10.0	0.0	10.0	0	0	5.0	5.0	5.0	0.0	5.0	5.0	AC voltage
RAMP (ACVOLT)	OFF	OFF	OFF	ON	ON	OFF	OFF	OFF	OFF	OFF	OFF	OFF	Voltage ramp
FREQ [Hz]	50.0	50.0	50.0	50.0	50.0	50.0	40.0	80.0	40.0	40.0	80.0	40.0	Frequency
RAMP (FREQ)	OFF	OFF	OFF	OFF	OFF	OFF	OFF	OFF	OFF	OFF	ON	ON	Frequency ramp
TIME [ms]	100	100	100	100	100	100	100	100	100	100	100	100	Step time
OUTPUT	ON	ON	ON	ON	ON	ON	ON	ON	ON	ON	ON	ON	Output

In this example, use default values for items that are not specified.

### Setting Procedure

In the supplied CD-R contains a table for recording sequence operation settings (xls,xlsx, and PDF). You can prevent input errors by entering the settings in this table first and then creating the sequence.

Use the rotary knob or the numeric keypad enter values for items that you want to set. When using the numeric keypad, press ENT after you enter values.

Press SEQ (SHIFT+SIM) to display the sequence screen. Press EDIT (F5) to display the step editing screen.

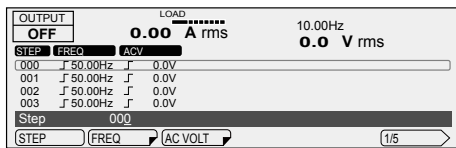
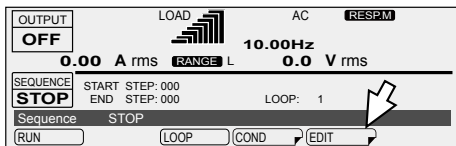

You can edit the step that has a border around its item or value. 000 is selected. If 000 is not selected, use the rotary knob to select it. You can also select steps by pressing STEP (F1) and then using the rotary knob.

Set the AC voltage. Press AC VOLT (F3).

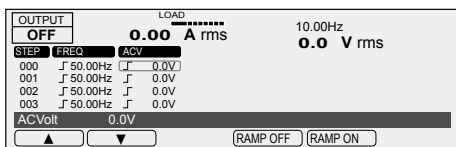

A border is displayed around the ACV item of step 000. Use the rotary knob to specify 5.0 V.

Press ▼ to move the border to the voltage of step 001. Then,

use the rotary knob to specify 10.0 V.

The default AC voltage is 0.0 V. The voltage of step 002 is 0.0 V (if it is not, set it to 0.0 V), so press ▼ twice to move the border to the voltage of step 003. In step 3, the voltage changes from 0.0 V to 10.0 V over 100 ms. This is because the voltage ramp setting is on. Use the rotary knob to set the voltage to 10.0 V, and then press RAMP ON (F5). The voltage ramp indication changes to  $\int$ .

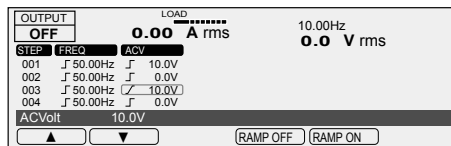

In step 4, the voltage changes from 10.0 V to 0.0 V over 100 ms. Set the voltage of step 4 to 0 V, and set the ramp setting to ON.

Set the voltages of steps 6 to 8 and steps 10 and 11 to 5.0 V. This completes the voltage settings.

Press ESC to return to the previous screen. Press FREQ (F2) to set the frequency.

The default frequency is 50.0 Hz. Press ▲ repeatedly until you reach the frequency of 006. (If steps 1 to 5 are not set to 50.0 Hz, start by setting the frequencies from step 1.) Then, use the rotary knob to specify 40.0 Hz.

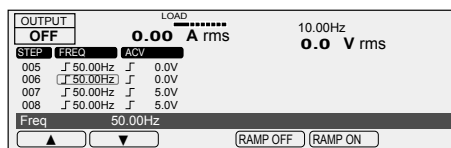

Press ▼ to move the border to the frequency of step 007. Then, use the rotary knob to specify 80.0 Hz. Likewise, set steps 8 and 9 to 40 Hz. Then, press ▼ to move the frequency of step 010.

In step 010, the frequency changes from 40 Hz to 80 Hz over

100 ms. This is because the frequency ramp setting is on. Use the rotary knob to set the frequency to 40 Hz, and then press RAMP ON (F5). The frequency ramp indication changes to  $\surd$ .

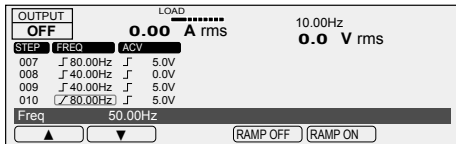

In step 11, the frequency changes from 80 Hz to 40 Hz over 100 ms. Set the frequency of step 11 to 40 Hz, and set the ramp setting to on. This completes the frequency settings.

Press ESC to return to the previous screen. Press 1/5(F6) to move to the next step editing screen.

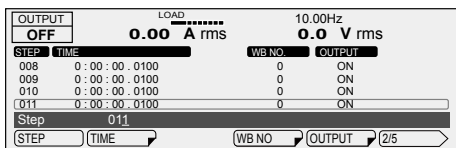

Press TIME (F2) to set the step execution time. Press  $\blacktriangle$  repeatedly until you reach the time setting of step 000. Press 100US (F6), use the numeric keys to enter 100 (0:00:00.1000), and press ENT. The microsecond resolution is 100  $\mu$ s.

The minimum time resolution for the step execution time is 100  $\mu$ s. Do not set the step execution time to 0 s.

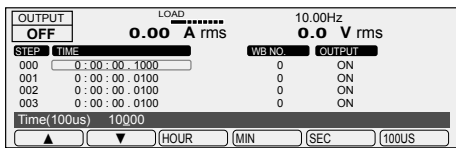

For steps 1 to 11, set the step execution time to 100 ms.

Press ESC to return to the previous screen. The default output setting is on, so there is no need to change it. If it is not on, press OUTPUT (F5). The default settings will be used for the rest of the items. This completes the step settings. If steps 0 to 11 are not set to their default values, set them to default values.

### Default values of other items

Item	PCR-LE2	Sequence setup screen
DCV (DC voltage)	0.0 V, RAMP OFF	3/6
TYPE (jump type)	NORM	4/6
JUNP STEP (jump destination step)	0	4/6
JUMP CNT (number of jump repetitions)	1	4/6
OUT IMP. (output impedance)	OFF	5/6
WB NO (waveform bank number)	0	2/6
STAT.OUT (status output)	ON	3/6
TRIG.OUT (trigger output)	OFF	3/6
TRIG.IN (trigger input)	OFF	3/6
S.PHASE (starting phase)	FREE	5/6
E.PHASE (ending phase)	FREE	5/6
PHAS.CHG (sudden phase change)	OFF	5/6

Next, set the sequence conditions.

Press ESC repeatedly until the sequence screen appears. Press COND (F4) to set the starting step number and the ending step number.

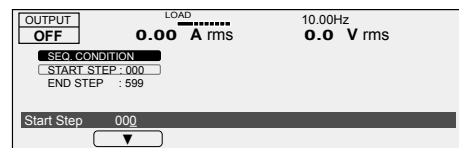
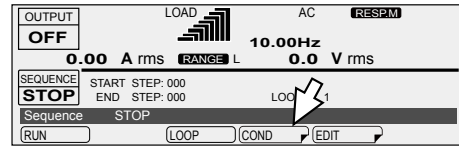

The default starting step number is 0. If START STEP is not 000, use the rotary knob to set it to 000.

Press  $\blacktriangledown$  to move the border to END STEP. The ending step is 011, so use the rotary knob to specify 011.

This completes the sequence settings. Let's run the sequence.

Press ESC to display the sequence screen.

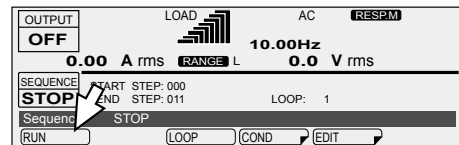

Press RUN (F1) to execute the sequence. You cannot execute the sequence in the following conditions.

If the voltage range is set to the L range and there is a step whose voltage exceeds the output voltage setting range (switch the range to the H range, or set the output voltage so that it is within the L range).

If you have configured the PCR-LE Series so that it does not turn output off when the current limit is exceeded (DISABLE)

If the regulation adjustment or soft sensing compensation function is in use.

If the L range is selected and a step's ACVolt or DCVolt setting is outside of the L range.

If the voltage or frequency is set to a value outside the corresponding limits.

## Sequence tutorial (Cont.)

The minimum unit for displaying step execution times is seconds. Steps whose execution time is less than 1 second are displayed as "0:00:00."

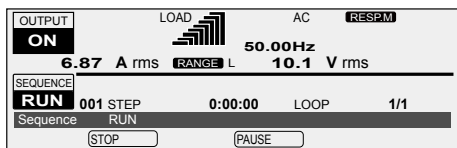

A sequence is complete when all steps are complete. The condition that the PCR-LE Series is in when a sequence is completed is the condition specified in the last step of the sequence.

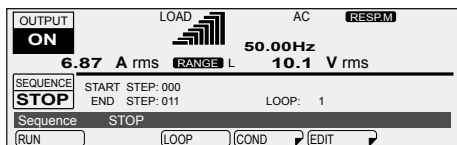

If you want the output to turn off when the sequence is complete, you need to add a last step that turns the output off.

When you have finished setting the sequence, we recommend that you save the settings to a USB memory device.

Connect a USB memory device to the USB port on the front panel. Press OTHERS (SHIFT+MEMORY), 1/2(F6), FILE(F5), SAVE(F3), and SEQ. The name of the file that the sequence will be saved to is displayed in the entry area.

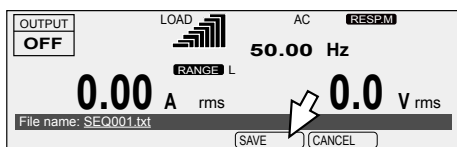

Press SAVE (F4) to save the settings. Do not remove the USB memory device until "File was saved" disappears.

Remove the USB memory device from the USB port.

## Voltage sweep and frequency sweep

This page describes a sequence for outputting a continuous waveform that linearly changes from 0 V to 10 V.

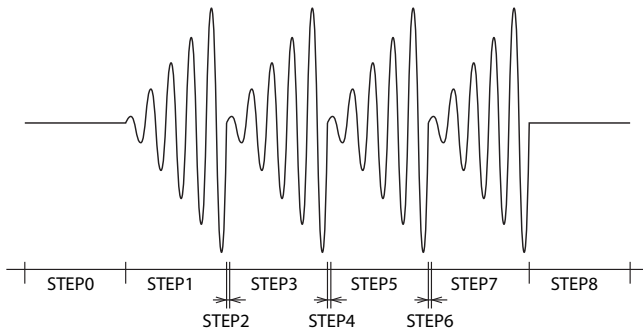

STEP	0	1	2	3	4	5	6	7	8
ACVOLT [V] AC voltage	0.0	10.0	0.0	10.0	0.0	10.0	0.0	10.0	0.0
RAMP (ACVOLT) Voltage ramp	OFF	ON	OFF	ON	OFF	ON	OFF	ON	OFF
FREQ [Hz] Frequency	50.0	50.0	50.0	50.0	50.0	50.0	50.0	50.0	50.0
RAMP (FREQ) Frequency ramp	OFF	OFF	OFF	OFF	OFF	OFF	OFF	OFF	OFF
TIME [ms] Step time	100	100	1	100	1	100	1	100	100
OUTPUT	ON	ON	ON	ON	ON	ON	ON	ON	ON

In a step whose ramp is set to on, the voltage changes linearly from the voltage setting of the previous step to the specified voltage.

Because we want to change the voltage from 0 V to 10 V, the step before the step that will be set to 10 V must be set to 0 V. For this purpose, we will set short starting voltage steps before steps that will be set to 10 V. In this example, steps 2, 4, and 6 are the starting voltage steps. The minimum time resolution for the step execution time is 100  $\mu$ s. Do not set the step execution time to 0 s.

If you create a sequence without starting voltage steps, the waveform shown below will be output. Note that even if the ramp is turned on in steps 2, because the previous step is set to 10 V, a ramp waveform will not be produced.

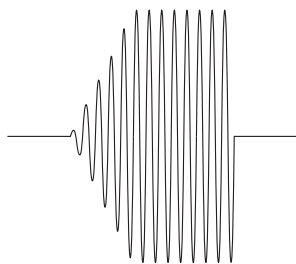

STEP	0	1	2	3
ACVOLT [V] AC voltage	0.0	10.0	10.0	10.0
RAMP (ACVOLT) voltage ramp	OFF	ON	ON	OFF

For the procedure to set steps on the PCR-LE Series, see “Sequence creation basics”.

Likewise, frequency sweeps also need starting frequency steps.

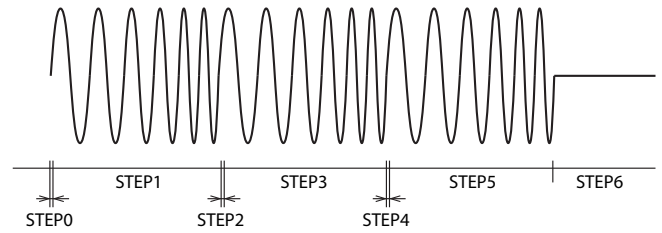

STEP	0	1	2	3	4	5	6
ACVOLT [V] AC voltage	0.0	10.0	10.0	10.0	10.0	10.0	0.0
RAMP (ACVOLT) Voltage ramp	OFF	OFF	OFF	OFF	OFF	OFF	OFF
FREQ [Hz] Frequency	40.0	80.0	40.0	80.0	40.0	80.0	40.0
RAMP (FREQ) Frequency ramp	OFF	ON	OFF	ON	OFF	ON	OFF
TIME [ms] Step time	1	100	1	100	1	100	100
OUTPUT	ON	ON	ON	ON	ON	ON	ON

Here, steps 0, 2, and 4 are the starting frequency steps.

# Sequence tutorial (Cont.)

## Switching steps at specific phase angles

This page explains how to switch steps at specific phase angles to produce a continuous waveform.

Steps are managed in terms of time. If the starting phase angle and ending phase angle are set to FREE (default setting), the next step will start when the step time elapses. The phase is continuous.

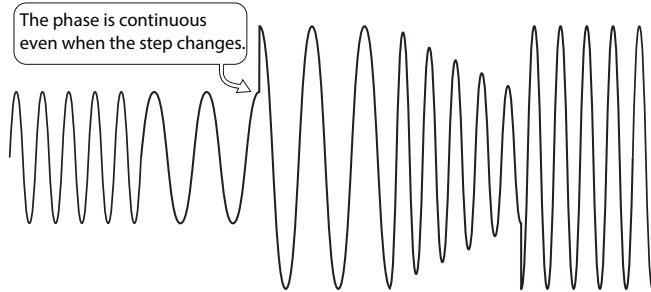

STEP	0	1	2	3	4
ACVOLT [V] AC voltage	5.0	5.0	10.0	5.0	10.0
RAMP (ACVOLT) Voltage ramp	OFF	OFF	OFF	ON	OFF
FREQ [Hz] Frequency	50.0	25.0	25.0	50.0	50.0
TIME [ms] Step time	100	90	100	100	100
OUTPUT S.PHASE [deg] Starting phase angle	ON 0	ON FREE	ON FREE	ON FREE	ON FREE

In this example, step 1 ends at 90°, so step 2 begins at 90°. Now, we change the starting phase angle so that steps 2 and 3 begin at 0°, and step 4 begins at 270°.

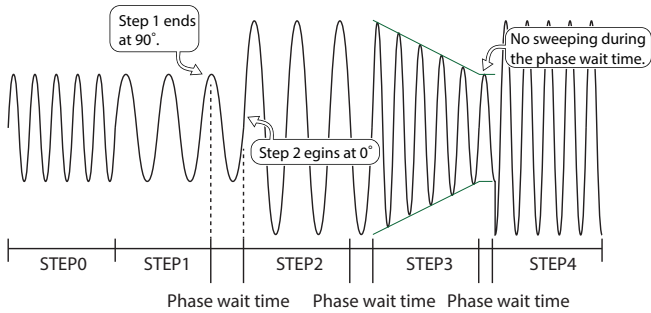

STEP	0	1	2	3	4
ACVOLT [V] AC voltage	5.0	5.0	10.0	5.0	10.0
RAMP (ACVOLT) Voltage ramp	OFF	OFF	OFF	ON	OFF
FREQ [Hz] Frequency	50.0	25.0	25.0	50.0	50.0
TIME [ms] Step time	100	90	100	100	100
OUTPUT S.PHASE [deg] Starting phase angle	ON 0	ON FREE	ON 0	ON 0	ON 270

The phase angle of step 1 when its step time elapses is 90°. Because the starting phase angle of step 2 is 0°, the PCR-LE waits until the phase angle of step 1 becomes 0° before executing step 2. This duration is the phase wait time. When the phase angle of step 1 reaches 0°, step 2 begins. The PCR-LE does not sweep during the phase wait time.

If you set starting phase angles, the total sequence time will be longer than the specified time by the amount of phase wait time. The phase wait time depends on the specified frequency.

During the phase wait time, the panel shows the next step number.

The status signal is output while the waveform of the step whose STAT.OUT is set to ON is being output.

The trigger signal is produced when the step actually begins.

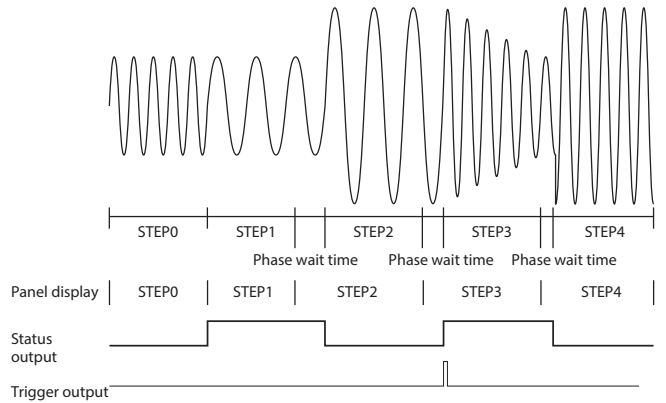

STEP	0	1	2	3	4
FREQ [Hz] Frequency	50.0	25.0	25.0	50.0	50.0
S.PHASE [deg] Starting phase angle	0	0	0	0	270
STAT.OUT Status output	OFF	ON	OFF	ON	OFF
TRIG.OUT Trigger output	OFF	OFF	OFF	ON	OFF

You can also set the starting phase angle to FREE and the ending phase angle to a specific angle to produce the same effect, but to avoid confusion, we recommend that you set the starting phase angle to a specific angle and the ending angle to FREE.

To output a waveform with continuous phase, be sure to set either the starting or ending phase angle to FREE. If you set both the starting and ending phase angles, the waveform may be offset by one period.

In this example, the starting phase angle of step 1 is FREE, so there is no phase wait time. Theoretically, there should not be any phase wait time if the starting phase angle is set to 0°, but depending on the conditions, the waveform may be offset by one period. If the time and phase angle are matched, we recommend that you use FREE. However, if you want to output a waveform accurately according to calculations, you need to shorten the previous step a little (1 ms in this example).

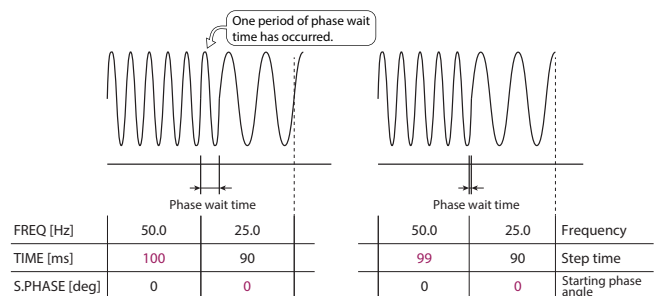



## Suddenly changing the phase

To suddenly change the phase, specify a sudden phase change after setting the starting and ending phase angles.

We will explain using an example whose phase changes suddenly from 90° to 270° between steps 2 and 3.

Because step 2 is set to 100 ms and 25 Hz, the phase angle will end at 180° if the ending phase angle is not specified (FREE). Because we want the phase to suddenly change from 90° to 270° between steps 2 and 3, we set the ending phase angle of step 2 to 90°. Step 3 will not begin until the phase angle changes from 180° to 90°, so there will be a phase wait time.

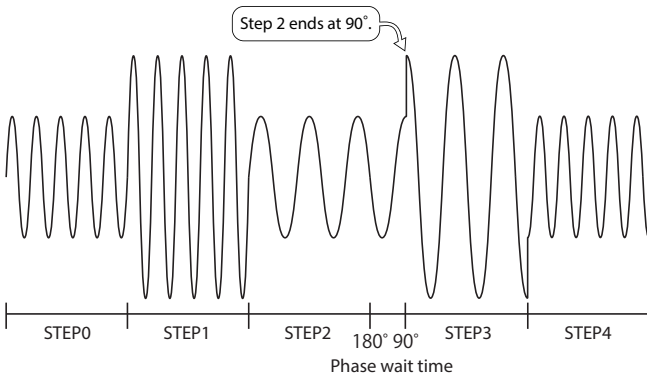

STEP	0	1	2	3	4
ACVOLT [V] AC voltage	5.0	10.0	5.0	10.0	5.0
FREQ [Hz] Frequency	50.0	50.0	25.0	25.0	50.0
TIME [ms] Step time	100	100	100	100	100
OUTPUT	ON	ON	ON	ON	ON
S.PHASE [deg] Starting phase angle	0	FREE	FREE	FREE	FREE
E.PHASE [deg] Ending phase angle	FREE	FREE	90	FREE	FREE
PHAS.CHG Sudden phase change	OFF	OFF	OFF	OFF	OFF

We want the phase to suddenly change to 270° in step 3, so we set the starting phase angle of step 3 to 270° and set the sudden phase change function to on. Step 2 will end at 90°, and step 3 will begin immediately from 270°.

To use sudden phase change, be sure to set the ending phase angle of the previous step and the starting phase angle of the step in which you want the phase to suddenly change. If either phase angle is set to FREE and sudden phase change is set to on, the waveform will not change at the correct phase angles.

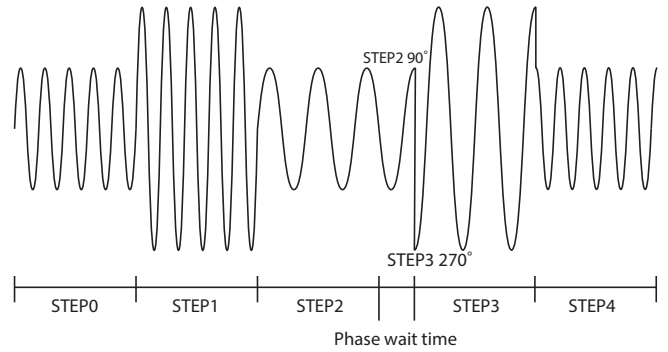

STEP	0	1	2	3	4
ACVOLT [V] AC voltage	5.0	10.0	5.0	10.0	5.0
FREQ [Hz] Frequency	50.0	50.0	25.0	25.0	50.0
TIME [ms] Step time	100	100	100	100	100
OUTPUT	ON	ON	ON	ON	ON
S.PHASE [deg] Starting phase angle	0	FREE	FREE	270	FREE
E.PHASE [deg] Ending phase angle	FREE	FREE	90	FREE	FREE
PHAS.CHG Sudden phase change	OFF	OFF	OFF	ON	OFF

Note that even if you set both the starting and ending phase angles, if you do not set the sudden phase change function to on, the phase will not change suddenly.

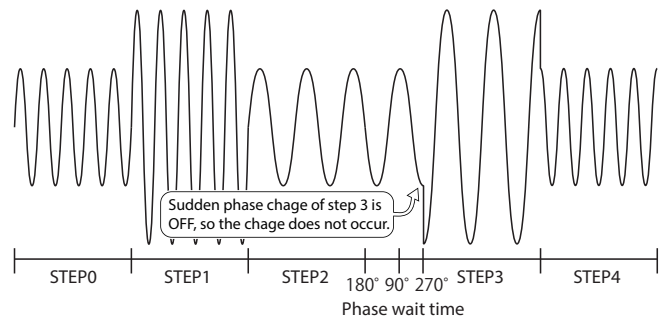

STEP	0	1	2	3	4
S.PHASE [deg] Starting phase angle	0	FREE	FREE	270	FREE
E.PHASE [deg] Ending phase angle	FREE	FREE	90	FREE	FREE
PHAS.CHG Sudden phase change	OFF	OFF	OFF	OFF	OFF

## Single-phase, three-wire output and three-phase output basics

### Single-phase, three-wire output

The figure below shows the output of a user-defined waveform whose U-V phase difference is 180° (factory default setting).

The phase setting is 180°, but the V phase is not 180° out of phase with the U phase. The V phase is an inverted waveform of the U phase.

## Sequence tutorial (Cont.)

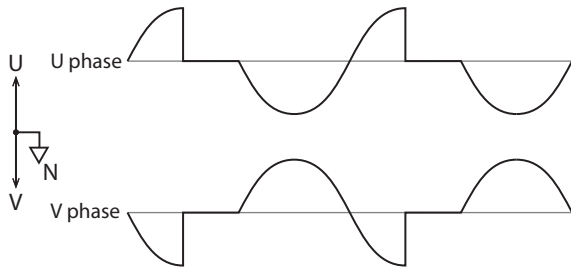

### ■ Three-phase output

The figure below shows the output of a three-step sequence where the U-V phase difference is  $120^\circ$  and the U-W phase difference is  $240^\circ$  (factory default setting).

The V phase is  $120^\circ$  behind the U phase. The W phase is  $240^\circ$  behind the U phase. You can set the U-V phase difference and the U-W phase difference in the sequence step settings.

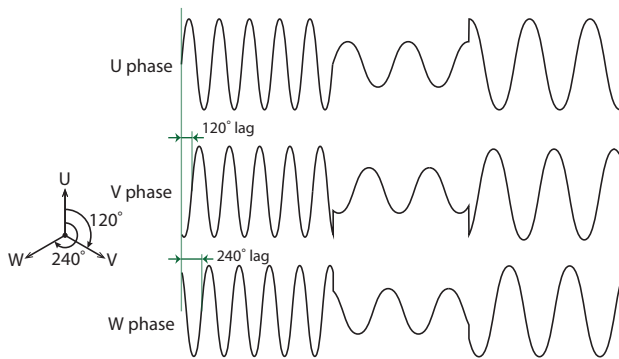

## Phase setting for multi-phase output

This page explains how to set phase angles for multi-phase output. For details on the operation of starting and ending phase angles, see "Switching steps at specific phase angles". For details on the operation of sudden phase changes, see "Suddenly changing the phase".

### - Note -

For the U phase sudden-phase-change settings, specify the starting phase angle, ending phase angle, and sudden phase change. For the V phase sudden-phase-change settings, set the U-V phase difference. For the W phase sudden-phase-change settings, set the U-W phase difference.

In the example below, the U phase suddenly changes from  $0^\circ$  to  $180^\circ$  when step 1 begins.

Because the U-V and U-W phase differences in step 1 are set to OFF, the U-V phase difference remains at  $120^\circ$  and the U-W phase difference remains at  $240^\circ$ . When the U phase is  $0^\circ$ , the V phase is  $240^\circ$ , because it is behind by  $120^\circ$ . The W phase is  $120^\circ$ , because it is behind by  $240^\circ$ . The V phase suddenly changes from  $240^\circ$  to  $60^\circ$  when step 1 begins. The W phase suddenly changes from  $120^\circ$  to  $300^\circ$ .

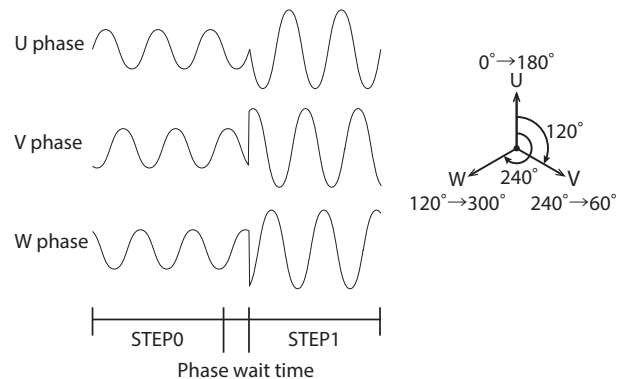

STEP	0	1
S.PHASE [deg] Starting phase angle	FREE	180
E.PHASE [deg] Ending phase angle	0	FREE
PHAS. CNG Sudden phase change	OFF	ON
U-V PHAS [deg] U-V phase difference	OFF	OFF
U-W PHAS [deg] U-W phase difference	OFF	OFF

Next, we will explain how to set the steps so that only the U phase suddenly changes.

In the example below, the U phase suddenly changes from 0° to 30° when step 1 begins. The waveforms of the V and W phases are continuous.

When step 1 begins, the U phase changes from 0° to 30°. If the U-V and U-W phase differences are set to OFF, the V phase will suddenly change from 240° to 270°, and the W phase will suddenly change from 120° to 150°. Because we want only the U phase to change suddenly, we add 30° to the phase differences (150° for the V phase and 270° for the W phase) so that the V and W phases will be continuous. When these settings are made, the waveforms of the V and W phases will be continuous.

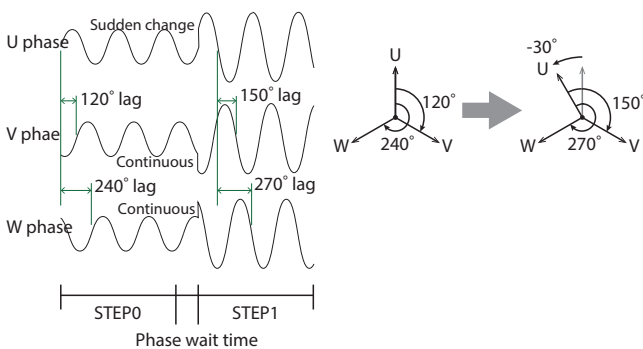

STEP	0	1
S.PHASE [deg]	FREE	30
Starting phase angle		
E.PHASE [deg]	0	FREE
Ending phase angle		
PHAS. CNG	OFF	ON
Sudden phase change		
U-V PHAS [deg]	OFF	150
U-V phase difference		
U-W PHAS [deg]	OFF	270
U-W phase difference		

You can also set the U phase offset to cause the U phase to suddenly change, but in this case, the U-V/U-W phase difference settings will be offset from the actual phase difference. To avoid confusion, we recommend that you turn off the U phase offset.

For details, see the next section, "Phase sweep"

Lastly, we will explain how to set the steps so that the V and W phases suddenly change. To suddenly change the V phase, set the U-V phase difference. To suddenly change the W phase, set the U-W phase difference.

In the example below, the U-V phase difference is suddenly changed from 120° to 90° when step 1 begins. The waveforms of the U and W phases are continuous.

Step 0 ends when the U phase is 180°. When the U phase is 180° in step 0, the V-phase is 60°, because the U-V phase difference is 120°. Because the U-V phase difference is changed to 90° in step 1, the V-phase starts at 180°-90° = 90°. This means that only the V phase suddenly changes from 60° to 90° when step 1 begins.

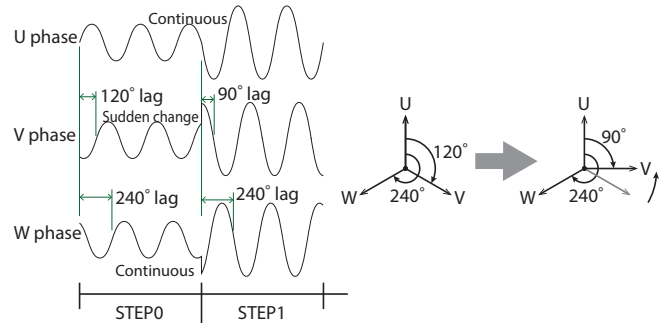

STEP	0	1
S.PHASE [deg]	FREE	FREE
Starting phase angle		
E.PHASE [deg]	FREE	FREE
Ending phase angle		
PHAS. CNG	OFF	OFF
Sudden phase change		
U-V PHAS [deg]	OFF	90
U-V phase difference		
U-W PHAS [deg]	OFF	OFF
U-W phase difference		

The example below shows a sudden phase change in which step 1 begins at 0° when step 0 ends with the V phase at 90°. The waveforms of the U and W phases are continuous.

Because the U-V phase difference is 120°, the V phase is 90° when the U phase is 210°. We want the V phase to change at 90°, so we set the starting phase angle of step 1 to 210°. The U phase angle is 210° when step 1 begins. To make the V phase suddenly change to 0°, we set the U-V phase angle to 210°. The W phase is continuous, so we leave the U-W phase difference at OFF.

When the U phase angle of step 0 reaches 210°, step 1 begins. The V phase suddenly changes from 90° to 0°.

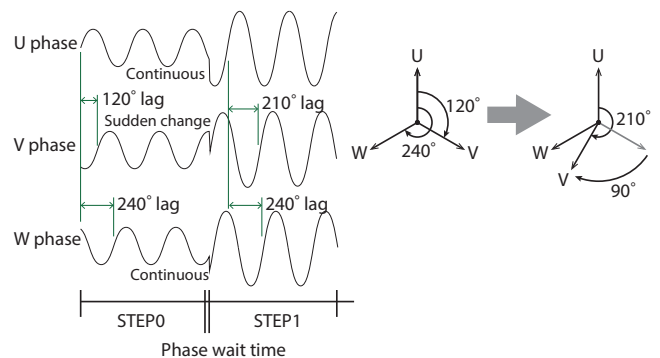

STEP	0	1
S.PHASE [deg]	FREE	210
Starting phase angle		
E.PHASE [deg]	FREE	FREE
Ending phase angle		
PHAS. CNG	OFF	OFF
Sudden phase change		
U-V PHAS [deg]	OFF	210
U-V phase difference		
U-W PHAS [deg]	OFF	OFF
U-W phase difference		

# Sequence tutorial (Cont.)

## Phase sweep

First, we will explain the phase sweeping of the U phase.

To sweep the U phase, you have to set the U phase offset.

When a U phase offset is specified, the U-V phase difference, U-W phase difference, starting phase angle, and ending phase angle settings are relative to the U phase reference phase.

Setting a U phase offset causes the U-V/U-W phase difference settings to be offset from the actual phase difference.

In the following example, U phase is swept from 0° to 330° (leading) from step 1 to step 2. V and W phases will not be changed.

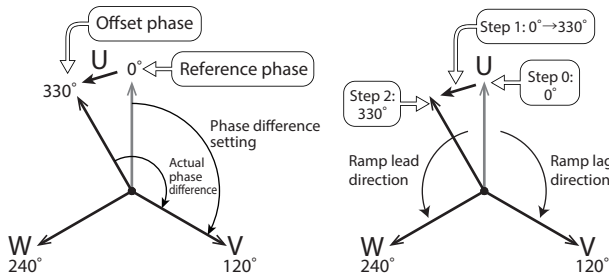

Specify the phase to sweep the U phase with the U phase offset.

STEP	0	1	2
S.PHASE [deg] Starting phase angle	FREE	FREE	FREE
E.PHASE [deg] Ending phase angle	FREE	FREE	FREE
U PHA.OFFS [deg] U phase offset	0	330	330
RAMP (U PHA.OFFS) U phase ramp	OFF	LEAD	OFF
U-V PHAS [deg] U-V phase difference	OFF	OFF	OFF
RAMP (U-V PHAS) V phase ramp	--	--	--
U-W PHAS [deg] U-W phase difference	OFF	OFF	OFF
RAMP (U-W PHAS) W phase ramp	--	--	--
PHAS. CNG sudden phase change	OFF	OFF	OFF

Because we want to advance the phase from 0° to 330° in step 1, we set the U phase offset of step 1 to 330°.

Phase sweep ramp can be set to leading (LEAD) or lagging (LAG).

Set the ramp of step 1 to LEAD. "- /" is displayed for U PHASE OFFSET.

When the ramp is off

When the ramp is on and set to LEAD

When the ramp is on and set to LAG

The U-V phase difference and U-W phase difference are the phase difference from the U phase reference phase.

Because we are not changing the V phase and W phase, we leave their settings at off (U-V phase difference: 120°, U-W phase difference: 240°).

The U-V phase difference and U-W phase difference are phase differences from the U phase reference phase, so if we set an offset for the U phase in step 1, even if the U-V phase difference setting is 120°, the actual phase difference will be 150° (120° + 30°), which means that the phase difference setting will be offset from the actual phase difference. Likewise, the U-W phase difference setting will be offset from the actual phase difference.

The output state when the sequence is complete is the state specified in the last step. If the sequence ends with a U phase offset, as in this example, the U PH OFS icon will appear.

If the icon is displayed, be sure to press 1/2 and then U PHASE on the sequence screen to clear the offset.

Next, we will explain the phase sweeping of the V and W phases.

Specify the phase to sweep the V phase with the U-V phase difference.

Specify the phase to sweep the W phase with the U-W phase difference.

Below is an example of sweeping the V phase and an example of sweeping the U and V phases.

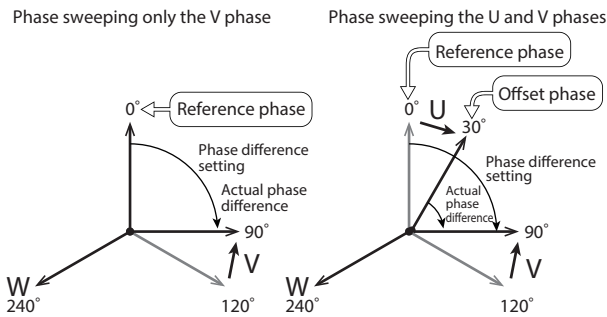

Phase sweeping only the V phase

STEP	0	1	2
S.PHASE [deg] Starting phase angle	FREE	FREE	FREE
E.PHASE [deg] Ending phase angle	FREE	FREE	FREE
U PHA.OFFS [deg] U phase offset	OFF	OFF	OFF
RAMP (U PHA.OFFS) U phase ramp	OFF	OFF	OFF
U-V PHAS [deg] U-V phase difference	120	90	OFF
RAMP (U-V PHAS) V phase ramp	OFF	LEAD	OFF
U-W PHAS [deg] U-W phase difference	OFF	OFF	OFF
RAMP (U-W PHAS) W phase ramp	--	--	--
PHAS. CNG sudden phase change	OFF	OFF	OFF

Phase sweeping the U and V phases

To sweep the U and V phases, you have to set the U phase offset. In step 1, to sweep the U phase from 0° to 30° and the V phase from 120° to 90°, even though the actual U-V phase difference is 60°, we set the U-V phase difference to 90° because this value must be set relative to the U phase reference phase when a U phase offset is set. The U-V phase difference setting is offset from the actual phase difference.

STEP	0	1	2
S.PHASE [deg] Starting phase angle	FREE	FREE	FREE
E.PHASE [deg] Ending phase angle	FREE	FREE	FREE
U PHA.OFFS [deg] U phase offset	0	30	30
RAMP (U PHA.OFFS) U phase ramp	OFF	LAG	OFF
U-V PHAS [deg] U-V phase difference	120	90	90
RAMP (U-V PHAS) V phase ramp	OFF	LEAD	OFF
U-W PHAS [deg] U-W phase difference	OFF	OFF	OFF
RAMP (U-W PHAS) W phase ramp	--	--	--
PHAS. CNG sudden phase change	OFF	OFF	OFF

# Sequence tutorial (Cont.)

## Line voltage dip

The following example shows how to set line voltage dips (short two phases: 70% residual voltage).

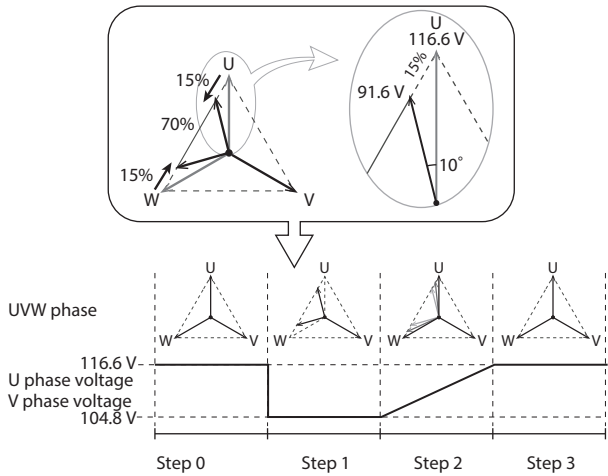

STEP	0	1	2	3
ACVOLT [V] U phase AC voltage	116.6	91.6	116.6	116.6
RAMP (ACVOLT) U phase voltage ramp	OFF	OFF	ON	OFF
ACV [V] V phase AC voltage	116.6	116.6	116.6	116.6
RAMP (ACV V) V phase voltage ramp	OFF	OFF	ON	OFF
ACV W [V] W phase AC voltage	116.6	91.6	116.6	116.6
RAMP (ACV W) W phase voltage ramp	OFF	OFF	ON	OFF
TIME [ms] Step time	100	100	100	100
S.PHASE [deg] Starting phase angle	FREE	FREE	FREE	FREE
E.PHASE [deg] Ending phase angle	FREE	FREE	FREE	FREE
U PHA.OFFS [deg] U phase offset	0	350	0	OFF
RAMP (U PHA.OFFS) U phase ramp	OFF	OFF	LAG	OFF
U-V PHAS [deg] U-V phase difference	120	OFF	OFF	OFF
RAMP (U-V PHAS) V phase ramp	OFF	--	--	---
U-W PHAS [deg] U-W phase difference	240	250	240	OFF
RAMP (U-W PHAS) W phase ramp	OFF	OFF	LEAD	---
PHAS. CNG sudden phase change	OFF	OFF	OFF	OFF

In step 1, we will suddenly change phases, and in step 2, we will sweep phases. For sudden phase changes, we normally do not use the U phase offset, but because we will use both sudden phase change and phase sweep in this example, we will set the sudden phase change using the U phase offset.

In step 1, we set the U-W line voltage to 70%.

We set the U and W phase voltages to 91.6 V (ramp off), the U phase (U phase offset) to 350° (360° - 10°), and the W phase (U-W phase difference) to 250° (240° + 10°). Because these will be sudden changes, the U and W phase ramp settings are set to off.

In step 2, the U-W line voltage is varied from 70% to 100% over the duration of the step (1 second).

We set the U and W phase voltages to 116.6 V and the voltage ramp to on.

To sweep the U phase clockwise to 0°, we set the U phase (U phase offset) to 0° and set the ramp to LAG.

To sweep the W phase counterclockwise to 240°, we set the W phase (U-W phase difference) to 240° and set the ramp to LEAD.

# Option

## Input power cord

These are power cords for the PCR-LE Series. The switchboard ends of the power cords have not been prepared for connection. The power cords do not conform to IEC standard.

For detail of the AC code of PCR12000LE2/ PCR18000LE2/ PCR27000LE2, contact your Kikusui agent or distributor.



For the PCR6000LE2  
Single-phase,  
two-wire input



For the PCR6000LE2,  
PCR9000LE2  
Three-phase,  
three-wire input



For the PCR6000LE  
PCR9000LE  
Three-phase,  
four-wire input

	Model	Cable	Length	Nominal cross sectional area	Input terminal
PCR6000LE2 Single-phase, two-wire input	AC14-1P3M-M8C-3S	Three single-core cables	3 m	14 mm <sup>2</sup>	M8
PCR6000LE2 PCR9000LE2 Three-phase, three-wire input	AC14-1P3M-M5C-4S	Four single-core cables	3 m	14 mm <sup>2</sup>	M5
PCR6000LE2 PCR9000LE2 Three-phase, four-wire input	AC5.5-1P3M-M5C-5S	Five single-core cables	3 m	5.5 mm <sup>2</sup>	M5

## Option (Cont.)

### GPIB/USB/LAN Interface Boards

By using one of the interface boards listed below, you can use an interface other than RS232C to control the PCR-LE Series.

US05-PCR-LE: This board enables you to control the PCR-LE Series over USB.

IB05-PCR-LE: This board enables you to control the PCR-LE Series over GPIB.

LN05-PCR-LE: This board enables you to control the PCR-LE Series over a LAN.

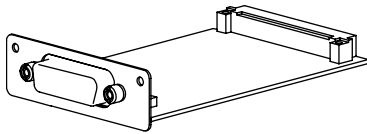

(The figure here is an example of the IB05-PCR-LE.)

Insert the interface board in SLOT 4 on the rear panel.

#### ■ Installing

Do not handle the interface board in environments where static electricity is easily produced.

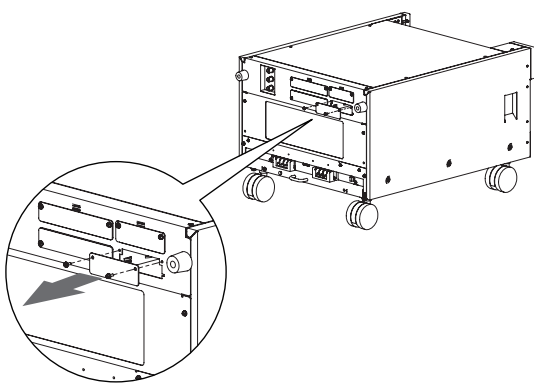
- 1 Check that the **POWER** switch is off.
- 2 Touch a grounded metal object (for example, the metal parts of the rear panel) to discharge any static electricity from your body.
- 3 Remove the screws that are holding the **SLOT 4** cover in place on the rear panel, and remove the cover from the panel.  

- 4 Hold the panel parts of the board so that the printed circuit board side is facing up.

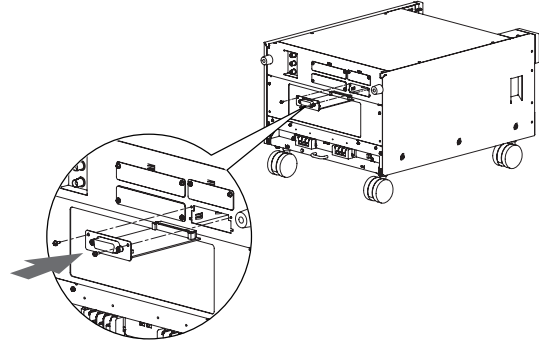
- 5 Insert the board into the slot so that the printed circuit board's connector is inserted into the connector at the back of the slot.

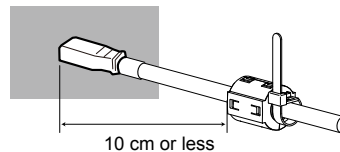

- 6 Insert the board all the way into the slot.
- 7 Use the screws that you removed in step 3 to fix the board in place in the panel.
- 8 If you installed the LAN interface board (LN05-PCR-LE), to change the host name, use the Web interface.  
The factory default host name is "PCR-LE." To access several PCR-LEs using host names, you need to change the host name.  
For details on the Web interface, see "Interface Setup" in the Communication Interface Manual.
- 9 If you have installed the USB interface board (US05-PCR-LE), attach the ferrite core and the cable tie.  
A ferrite core (96-01-0210) and cable tie (P4-000-551) are included with the USB interface US05-PCR-LE.  
Attach the ferrite core at a position 10 cm or less from the USB port. Check that the ferrite core is locked securely in place.  
Attach the cable tie to fix the position of the ferrite core.





## Analog signal Interface boards (EX05-PCR-LE, EX06-PCR-LE)

By using one of the analog signal interface boards listed below, you can control PCR-LE2 Series AC power supply output with analog signals.

- EX05-PCR-LE simply amplifies the waveforms that it receives and outputs the result.
- EX06-PCR-LE varies the voltage of the output AC waveform (sine wave) on the basis of DC signals that it receives.

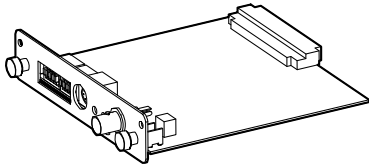

Insert the board in SLOT 3 on the rear panel.

For connections, see the EX05-PCR-LE/ EX06-PCR-LE Setup Guides.

## Base Hold Angles (OP03-KRC)

These are used when you want to fix the PCR6000LE2, or PCR9000LE2 to a rack or the floor.

For details, see the OP03-KRC section in the OP03-KRC Manual.

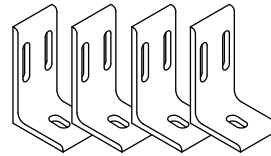

When you are using these with the PCR6000LE2, or PCR9000LE2, you can use a coin or similar object to detach the caps that are included with the PCR-LE Series, then attach the base hold angles. Nuts that are included with the OP03-KRC will not be used.

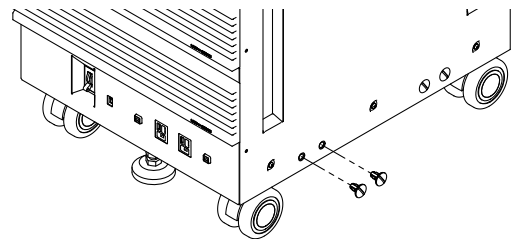

The dimensions of the product when the base hold angles are attached to it are shown in the following figure.

Unit: mm

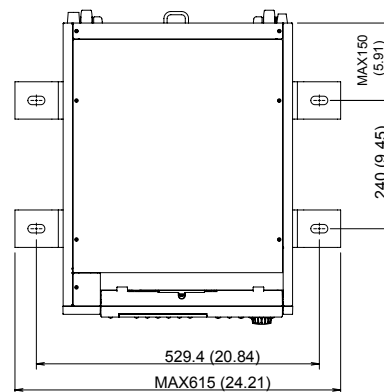

## Option (Cont.)

### Control Panel Extension Cable (EC05-PCR)

This is an extension cable (2 m in length) that enables you to use the control panel while it is detached from the PCR-LE2 Series.

**1** Check that the **POWER** switch is off.

**2** Remove the screw on the back of the control panel that is fixing the connector cover in place.

Slide the connector cover up to detach it from the control panel.

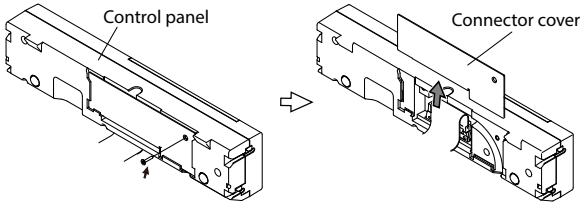

**3** Remove the cable that is connected to the control panel.

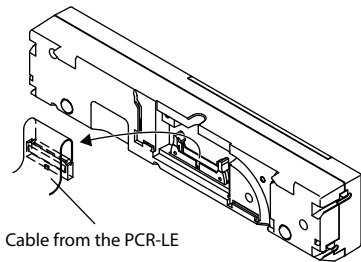

**4** Connect the cable from the PCR-LE2 Series to the control panel extension cable. Use the band and the bracket to fix the control panel extension cable to the PCR-LE2 Series.

Cable from the PCR-LE2

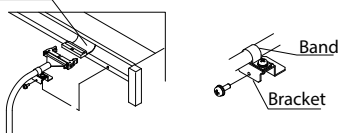

**5** Connect the control panel extension cable to the control panel.

Store the cable in the upper or lower groove.

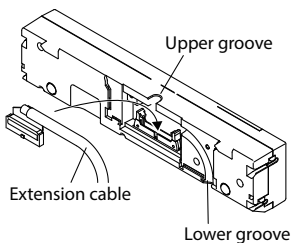

**6** Slide the connector cover back onto the control panel.

Use the screws that you detached in step 2 to fix the cover in place.

The following figures show an example in which the cable is stored in the lower groove.

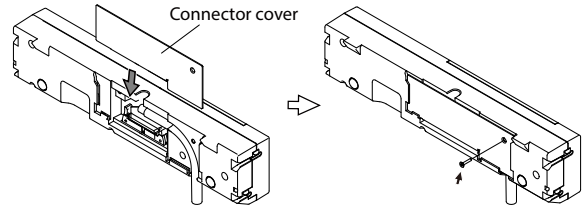

## Line Impedance Network (LIN3060J, LIN-1020JF, LIN3020JF)

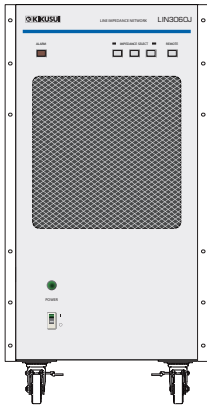

Connecting a standardized line impedance network between the PCR-LE2 Series and the load enables you to simulate a commercial power supply.

Insert the supplied board in SLOT 3 on the rear panel.

- **LIN3060J**

This product contains impedances required for testing grid-connected power conditioners as defined in the applicable JIS/JET standards. It is a reference impedance unit necessary for constructing a JETGR0002-1-2.0 grid-interconnection test system.

For details, see the LIN3060J Operation Manual.

- **LIN1020JF/ LIN3020JF**

This product contains JIS- and IEC-compliant impedances required for harmonic and flicker testing of devices connected to power distribution systems. A test system can be configured easily by combining this product with AC power supplies.

The LIN1020JF can be used to test single-phase devices. When used in combination with the OP01-LIN1020JF, it can be used to test single-phase three-wire devices and three-phase devices.

The LIN3020JF can be used to test single-phase three-wire devices and three-phase devices.

For details, see the LIN1020JF/ LIN3020JF Operation Manual.

## Sequence creation and control software (SD011-PCR-LE)

Sequence creation and control software SD011-PCR-LE Wavy for PCR-LE is used to create and execute sequences for PCR-LE series.

For details, see the SD011-PCR-LE Operation Manuals (Setup Guide, Operation Guide).

## RMT CONT SOFTWARE FOR PCR-LE (SD021-PCR-LE)

SD021-PCR-LE is a software application for controlling a Kikusui PCR-LE/PCR-LE2 series AC power supply from a Windows OS tablet PC.

For details, see the SD021-PCR-LE Operation Manual.

## Option (Cont.)

### Immunity Tester (DSI1020, DSI3020, SD009-PCR-LE)

---

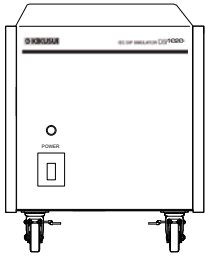

By using the control software (SD009-PCR-LE), the dip simulator (DSI1020/ DSI3020), and the PCR-LE2 Series, you can perform voltage dip, short interruptions, and voltage variation immunity tests in accordance with IEC61000-4-11 (2004).

The DSI1020 supports single-phase two-wire tests. The DSI3020 supports single-phase two-wire, single-phase three-wire, three-phase three-wire, and three-phase four-wire tests.

Insert the supplied board in SLOT 3 on the rear panel.

For details, see the DSI1020/DSI3020 Operation Manual, and SD009-PCR-LE Setup guide and Operation manual.

This is page left blank intentionally.

# Factory Default Settings (Initialization)

## Restoring to factory default settings

You can return all the settings to their factory defaults or return just a portion of the settings to their factory defaults.

### ■ Returning all settings to their factory defaults

While holding down MEMORY, turn the POWER switch on. The PCR-LE Series starts with the factory default settings.

### ■ Returning a portion of the settings to their factory defaults (reset)

For the settings that return to their factory defaults, see the tables of factory default settings.

## Factory default settings

All items that have "Yes" in their "Reset" column are returned to their factory default values when you press RESET (SHIFT+6).

### ■ Basic settings

Item	Factory Default	Reset
Output mode	AC	Yes
Output range	L	Yes
Output method	Single-phase output	--
Key lock	Off	Yes
Screen brightness	3	--
Output condition when the POWER switch is turned on	SAFE	Yes
AC voltage	0.0 V	Yes
DC voltage	0.0 V	Yes
Frequency	50.00 Hz	Yes

### ■ Output

Item	Factory Default	Reset
Output	Off	Yes
Output on phase	FREE	Yes
Output on phase angle	0 deg	Yes
Output off phase	FREE	Yes
Output off phase angle	0 deg	Yes
Voltage surge suppression	On	--

### ■ Display

Item	Factory Default	Reset
Measured value display	RMS	Yes
Aperture time	0.4 s	Yes
Current peak hold time	0 s	Yes

## ■ Limit and protection function settings

Item	Factory Default						Reset
	PCR6000LE2	PCR9000LE2	PCR12000LE2	PCR18000LE2	PCR27000LE2		
AC voltage upper limit	305.0 V						Yes
AC voltage lower limit	0.0 V						Yes
AC current limit	Single-phase output	66.00 A	99.00 A	132.00 A	198.00 A	297.0 A	Yes
	Single-phase three-wire output	22.00 A	33.00 A	44.00 A	66.00 A	99.00 A	Yes
	Three-phase output						
Frequency upper limit	999.9 Hz						Yes
Frequency lower limit	1.00 Hz						Yes
DC voltage upper limit	431.0 V						Yes
DC voltage lower limit	-431.0 V						Yes
DC current limit	46.20 A	69.30 A	92.40 A	138.60 A	207.9 A		Yes
Positive current peak limit	Single-phase output	264.0 A	396.0 A	528.0 A	792.0 A	1188 A	Yes
	Single-phase three-wire output	88.00 A	132.0 A	176.0 A	264.0 A	396.0 A	Yes
	Three-phase output						
Negative current peak limit	Single-phase output	-264.0 A	-396.0 A	-528.0 A	-792.0 A	-1188 A	Yes
	Single-phase three-wire output	-88.00 A	-132.0 A	-176.0 A	-264.0 A	-396.0 A	Yes
	Three-phase output						
Current limit operation	TRIP						Yes
Current limit trip time	10 s						Yes
OCV reference time	3 s						Yes
Output undervoltage protection (UVP)	AC mode: 0 V, DC/AC+DC mode: -474.1 V						Yes
Output overvoltage protection (OVP)	AC mode: 335.5 V, DC/AC+DC mode: 474.1 V						Yes

## ■ Advanced function

Item	Factory Default					Reset
	PCR6000LE2	PCR9000LE 2	PCR12000LE2	PCR18000LE2	PCR27000LE2	
Synchronization function	OFF, 0 deg					Yes
Harmonic analysis	Off, all orders					Yes
Harmonic analysis display	Current RMS value					Yes
Internal Vcc	AUTO, 431.0 V					Yes
Sleep function	Off, 60 min					Yes
Compensation function	Off					Yes
Output impedance	Off, 1 %					Yes
Soft start	Off, 0.1 s					Yes
Response	MEDIUM					Yes
Anticipated maximum power	6 000 VA	9 000 VA	12 000 VA	18 000 VA	27 000 VA	--
Trigger input	POSI					--
Trigger output	POSI					--
Status output	POSI					--

## ■ Memory

Item (for all memory entry numbers, 0 to 99)	Factory Default	Reset
AC voltage value	0.0 V	--
DC voltage value	0.0 V	--
Frequency (ones-digit of the memory number: 0 to 3)	50.00 Hz	--
Frequency (ones-digit of the memory number: 4 to 6)	60.00 Hz	--
Frequency (ones-digit of the memory number: 7 to 9)	400.0 Hz	--
Waveform bank number	0	--
Recall number	0	Yes
Storage number	1	Yes

## ■ Power line abnormality simulations

Item	Factory Default	Reset
T1 setting unit	TIME	Yes
Voltage regulation polarity	Positive	Yes
T5 setting unit	TIME	Yes
Regulated voltage T3	0.0 V	Yes
Number of repetitions	Infinite	Yes
T1 time	100 ms	Yes
T1 angle	0 deg	Yes
T2 time	0 ms	Yes
T3 time	100 ms	Yes
T4 time	0 ms	Yes
T5 time	100 ms	Yes
T5 return cycles	0	Yes

## Factory Default Settings (Initialization) (Cont.)

### Factory default settings(Cont.)

#### ■ Sequence function: Sequence condition settings

Item	Factory Default	Reset
Starting step number	0	--
Ending step number	599	--
Number of repetitions	1	--

#### ■ Sequence function: Step settings (all steps)

Item	Factory Default	Reset
AC voltage value	0.0V	--
AC voltage signal change	Ramp OFF	--
Frequency	50.00 Hz	--
Frequency signal change	Ramp OFF	--
DC voltage value	0.0 V	--
DC voltage signal change	Ramp OFF	--
Jump type	NORM	--
Jump destination step	0	--
Number of jump repetitions	1	--
Output impedance	Off, 1 %	--
Execution time	10 ms	--
Waveform bank number	0	--
Output	ON	--
Status output	ON	--
Trigger output	OFF	--
Trigger input	OFF	--
Starting phase	FREE	--
Starting phase angle	0	--
Ending phase	FREE	--
Ending phase angle	0	--
Phase change	OFF	--
U phase offset	Off, 0°	--
U phase signal change	Ramp OFF	--
UV phase	OFF Single-phase three-wire: 180°, Three-phase: 120°	--
V phase signal change	Ramp OFF	--
UW phase	OFF, 240°	--
W phase signal change	Ramp OFF	--

#### ■ Remote control

Item	Factory Default	Reset
Interface	RS232C	--
RS232C baud rate	19200 bps	--
RS232C data length	8 bit	--
RS232C stop bits	1 bit	--
RS232C flow control	OFF	--
GPIB address	5	--
LAN DHCP	ON	--
LAN AUTO I/P	ON	--
LAN manual I/P	ON	--
Error trace	ON	--

#### ■ Waveform bank

Item	Factory Default	Reset
Number of the waveform bank to execute	0	Yes
Number of the waveform bank to edit	1	Yes
User-defined waveform (You have to use remote control to set this.)	Sine wave	--
Waveform type	Sine wave	--
Crest factor	1.40	--

#### ■ Single-phase three-wire output, Three-phase output

Item	Factory Default	Reset
AC voltage (U-phase, V-phase, W-phase)	0.0 V	Yes
U-V phase	Single-phase three-wire: 180° Three-phase: 120°	Yes
U-W phase	240°	Yes

#### ■ Analog signal control (optional)

Item	Factory Default	Reset
Signal source	INT	Yes
Polarity	NORM	Yes
Control the output AC voltage using an external DC signal	OFF	Yes
Phase to monitor	TOTAL	--
Output on/off through external control	DISABLE	--
Sequence execute/stop through external control	DISABLE	--
Clear alarms through external control	DISABLE	--
Shut down the output through external control	SHORT	--



# Maintenance

## Cleaning the dust filter

A dust filter is installed on the inside of the louver on the front panel.

Periodically clean the filter to prevent clogging.

### ⚠ CAUTION

- If the dust filter is clogged, the product's internal cooling capabilities will be reduced. This may lead to malfunction or the reduction of the product's service life.
- When the PCR-LE2 Series is in operation, air is sucked through the dust filter to cool the inside of the device. If moisture is present in the dust filter, the temperature or humidity inside the PCR-LE2 Series increases and may cause malfunctions.

### 1 Detach all the louvers from the panel.

While using your fingers to push the lock lever under the detachment mark up, slide the entire louver to the right, and then pull the louver towards you to detach it.

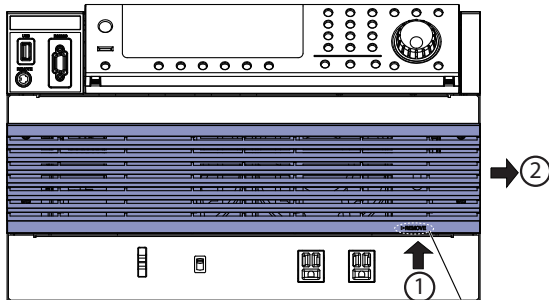

Detachment mark

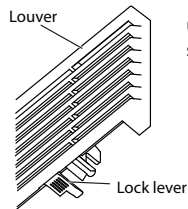

With your fingers, push up on the lock lever under the detachment mark (1), and slide the louver to the right (2).

### 2 Remove the dust filter from the inside of the louver.

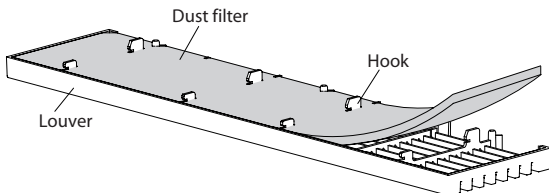

### 3 Clean the dust filter.

Use a vacuum cleaner to dispose of the dust and foreign particles that are attached to the dust filter. If the filter is extremely dirty, clean it using a water-diluted neutral detergent and dry it completely.

### 4 Attach the dust filter to the louver.

The dust filter has a top side and a bottom side. The side that has sections cut out of it is the bottom side. Firmly attach the dust filter so that the louver's tabs protrude out of the top of the dust filter.

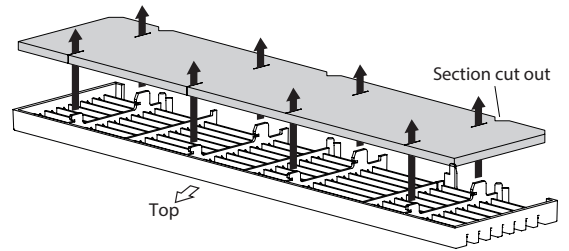

### 5 Check the top and bottom parts of the louvers, and then attach all of them to the product.

Align the lock lever with the lock lever insertion hole. Align the hooks on the inside of the louver with the corresponding holes on the panel, and then slide the louver to the left to attach it.

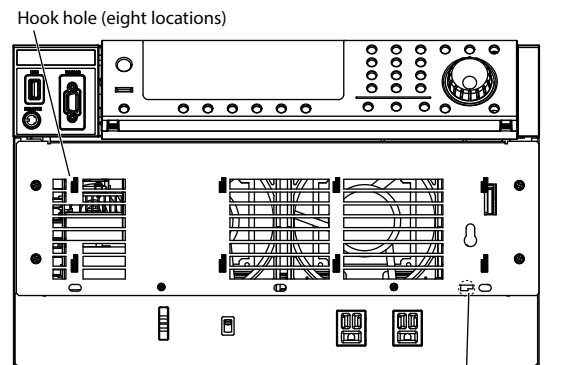

Hook hole (eight locations)

Lock lever insertion hole

## Calibration

The PCR-LE2 is shipped after carrying out appropriate calibrations. We recommend periodic calibration to maintain the performance.

For calibration, contact your Kikusui agent or distributor.

# Troubleshooting

## Symptom and Remedy

This section introduces troubleshooting measures that you can use if you notice problems during operation of the PCR-LE2 Series. This section lists representative symptoms and the corresponding items that you can check, so find the item that matches your situation. In some cases, the problem can be solved quite easily.

If you find an item that corresponds to your case, follow the remedies for the item. If you do not, we recommend that you initialize the PCR-LE2. If the remedy does not correct the problem, contact your Kikusui agent or distributor.

### ■ The control panel display does not light when the POWER switch is turned on.

Item to check	Possible cause	Remedy
Is the rated voltage being applied to the INPUT terminal block? / Is the terminal block tray installed all the way in its storage compartment? (PCR6000LE2 or PCR9000LE2 only)	<ul style="list-style-type: none"> <li>•The input power cable is not connected correctly.</li> <li>•The input power cable is broken.</li> </ul>	Check whether the input power cable is damaged, and check whether the wires are securely connected to the terminals.
Is the input voltage within the rated range?	There is an input voltage error.	Check the input voltage.

### ■ The control panel is not responding. Some operations cannot be performed.

Item to check	Possible cause	Remedy
Are the keys locked?	The key lock is enabled.	Release the key lock.
Is "RMT" displayed?	The product is being controlled remotely.	Press LOCAL to switch the product to local mode (panel operation).
Is "ALARM" displayed?	There is an internal or external error.	Check the alarm type.
Is there a device nearby that is generating a lot of noise?	The product is malfunctioning because of noise.	Remove the product from the source of the noise.
Are the voltage and frequency limits set to values within the settable ranges?	The limit settings are inappropriate.	Set the limits to correct values.

### ■ The control panel display is abnormal.

Item to check	Possible cause	Remedy
Is there a device nearby that is generating a lot of noise?	The product is malfunctioning because of noise.	Remove the product from the source of the noise.

### ■ The output voltage is not generated or is different from the specified voltage.

Item to check	Possible cause	Remedy
The output method (single-phase output, single-phase three-wire output, or three-phase output) is set correctly.	The cables are connected to the incorrect terminal block.	Connect the output cables to the correct terminal block.
The cables are connected to the correct terminal block.	The output mode is not set correctly.	Specify the correct output method.

### ■ The output voltage waveform is distorted.

Item to check	Possible cause	Remedy
Is "OVER LOAD" displayed?	The internal semiconductor protection has been activated.	The product may be overloaded. Inspect the load.

### ■ "ALM-02: OHP" is displayed.

Item to check	Possible cause	Remedy
Has the fan stopped?	The overheat protection (ALM-02) has been activated because the fan is malfunctioning.	Immediately stop using the PCR-LE2 Series, and have it repaired.
Are the vent or inlet holes blocked?	<ul style="list-style-type: none"> <li>•The overheat protection (ALM-02) has been activated.</li> <li>•The dust filter is clogged.</li> </ul>	Move the product so that there is at least 20 cm of space between the vents and the surrounding walls. Do not place objects within 20 cm of the vents. Clean the dust filter to remove any clogs.
Has the ambient temperature exceeded 40 °C?	The overheat protection (ALM-02) has been activated.	Use the product in an environment in which the ambient temperature is 40 °C or less. Keep loads that generate a high temperature away from the product.

■ **An output current can not be generated ("ALM-06: OVER LOAD" is displayed).**

Item to check	Possible cause	Remedy
Is the output voltage range set correctly?	The range is set to the H range.	Set the output voltage range correctly.
Does the load have a low power factor?	<ul style="list-style-type: none"> <li>The rated current (which is a power factor reduction characteristic) is being exceeded.</li> <li>A capacitor-input rectifier load, non-linear load, or similar type of load may be connected.</li> </ul>	Correct the load power factor.
Are the current limits set correctly?	The current limit settings are inappropriate.	Set the current limits to correct values.
Is the PCR-LE2 Series in DC mode?	In DC mode and AC+DC mode, the rated output current is 70 % of the value in AC mode.	The product may be overloaded. Inspect the load.

■ **Even though the action to perform when the current limit is exceeded has been set to TRIP DISABLE, the PCR-LE2 Series has tripped.**

Item to check	Possible cause	Remedy
Is "ALM-03: OCP" displayed?	The internal semiconductor protection has been activated.	If the load has shorted or is the PCR-LE2 is overloaded, the internal semiconductor protection may be activated, and an alarm may be generated.

■ **A sine waveform is not generated even though waveform bank number 0 has been selected.**

Item to check	Possible cause	Remedy
Is "S.WAVE" displayed?	The SD009-PCR-LE2 has shut down abnormally.	Turn the PCR-LE2 Series power switch off and on.

■ **Power line abnormality simulations or sequences cannot be executed.**

Item to check	Possible cause	Remedy
Is the PCR-LE2 in a condition in which simulations and sequences cannot be executed?	Voltage range, limit, compensation, and other settings are set to conditions in which simulations and sequences cannot be executed.	Change the present conditions or change the power line abnormality simulation or sequence settings.

■ **Phase settings are not correct (U PH OFS or UNBAL icons).**

Item to check	Possible cause	Remedy
If the U PH OFS icon displayed?	The U phase is offset.	The U phase is left offset in a sequence. Press SEQ (SHIFT+SIM), 1/2, and U PHASE to clear the offset.
If the UNBAL icon displayed?	Unbalanced phase difference or phase voltage is being used.	Change to a correct value. -> p. 22

■ **The output operation is unstable.**

Item to check	Possible cause	Remedy
Are the load wires run alongside each other?	The wiring conductance is large.	You run the load wires alongside each other.

■ **The output turns off earlier than the trip time setting.**

Item to check	Possible cause
The voltage is set at or lower than 10 V (L range) or 20 V (H range).	If the voltage is set at or lower than 10 V (L range) or 20 V (H range), the output will turn off after 3 s even if you set the trip time to 4 s or longer.
The full scale bar of the load level meter continues to be lit.	Increase in the internal temperature of the PCR-LE If an overload occurs repeatedly, the time until the output is turned off may be shortened.

■ **The maximum used output voltage setting of the internal Vcc was changed.**

Item to check	Possible cause
The maximum used output voltage setting is lower than the peak output voltage.	If the maximum used output voltage is set lower than the peak output voltage, the maximum used output voltage setting is changed to follow the peak output voltage.

## Troubleshooting (Cont.)

### Symptom and Remedy (Cont.)

#### ■ The output cannot be turned on.

Item to check	Possible cause
"Busy" is shown on the display.	After the ALM-03 OCP or ALM-06 OVERLOAD is activated, the PCR-LE remains in a "Busy" state for approximately 120 seconds during which the output cannot be turned on.

#### ■ The full scale bar of the load level meter is dimly lit.

Item to check	Possible cause
The PCR-LE is being used on the verge of an overload.	If the internal temperature increases, even if the load is reduced, the full scale bar may continue to light dimly in red. When cooling is complete, the full scale bar turns off.

## Alarms and Trouble

### Overview

The PCR-LE2 Series has the following protection functions. When a protection function is activated, an alarm (ALM-xx) or a trouble indication (TRBL-xx) is generated, and the output is turned off.

- Alarm

An alarm is generated by the PCR-LE2 Series to indicate that a protection function has been activated. Press ALM CLR (SHIFT+CLR) to clear the alarm, and then fix the problem that caused the alarm.

- Trouble

A trouble indication is generated by the PCR-LE2 Series when it is used improperly, when it suspects a malfunction, or when there is a possibility that it will be damaged. Turn the POWER switch off, wait at least 5 seconds, and turn it back on. If the same trouble indication occurs again, contact your Kikusui agent or distributor to request repairs.

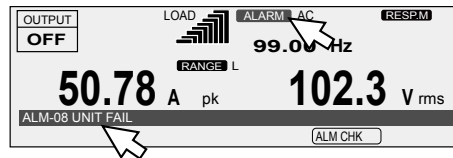

If multiple alarms occur, only the first alarm will be displayed. To display the other alarms that are occurring, press ALM CHK (F5), and then turn the rotary knob.

## Corrective action

### ■ Alarm code and corrective action

Alarm code	Description and corrective action
ALM-00	OVP The output overvoltage protection has been activated. This occurs when the measured voltage exceeds the OVP setting for approximately 1 second.
ALM-01	VccOVP The internal Vcc overvoltage protection has been activated. A voltage greater than or equal to the set voltage has been regenerated from the output side of the PCR-LE2 Series, or two phases may have shorted during single-phase three-wire output or three-phase output. Alternatively, the PCR-LE2 Series may be malfunctioning. If the alarm occurs even after you fix the problem that caused the alarm, stop using the PCR-LE2 Series immediately, and contact your Kikusui agent or distributor to request repairs.
ALM-02	OHP ALM-02-1 PFC OHP ALM-02-2 DCDC OHP ALM-02-3 THER_1 OHP ALM-02-4 THERE_2 OHP The overheat protection has been activated. The internal temperature may have risen to an abnormal level. Leave the PCR-LE2 Series on, and wait for approximately 10 minutes. If the alarm is still occurring after 10 minutes, check that the power cord is connected correctly. If the alarm has stopped occurring after 10 minutes, the PCR-LE2 Series may have been installed incorrectly, or the dust filter may be clogged. If there are no problems with the installation or the dust filter, stop using the PCR-LE2 Series immediately, and contact your Kikusui agent or distributor to request repairs.
ALM-03	OCP The PCR-LE2 Series' internal semiconductor protection function has been activated. After the protection function is activated, there is a period of approximately 120 seconds (the "Busy" state) during which the output cannot be turned on. Fix the problem that caused the OCP to occur, and then press OUTPUT again. The OCP should be cleared, and the output should turn on.
ALM-06	OVERLOAD The overload protection function has been activated. The output current has exceeded the rated value or the current limit. After the protection function is activated, there is a period of approximately 120 seconds (the "Busy" state) during which the output cannot be turned on. Fix the problem that caused the overload to occur, and then press OUTPUT again. The overload should be cleared, and the output should turn on.
ALM-07	UVP The output undervoltage protection has been activated. This occurs when the measured voltage is lower than the UVP setting for approximately 1 second.
ALM-08	UNIT MISSING ALM-08-1 UNIT MISSING There are not enough power units. Power units may have been removed. If this alarm occurs for some power units, you can clear the alarm and use the PCR-LE2 Series temporarily. UNIT FAIL ALM-08-2 UNIT FAIL ALM-08-3 DC P.S TRBL ALM-08-4 AMP FUSE TRIP ALM-08-5 DCDC FUSE TRIP ALM-08-6 SUB P.S FAIL ALM-08-7 FAN ERROR This indicates a power unit malfunction. At least one power unit is malfunctioning.
ALM-15	CAL.ALM Calibration value error.
ALM-20	MEAS.FAILURE Measurement function error. This error may occur if you change the aperture time consecutively.
ALM-22	SENSING FAILURE There is an error in the sensing wiring. Turn the power off, fix the wiring, and then turn the power back on.
AC INPUT LOW	The input voltage has become lower than the rated value. Wiring errors or short interruption may have occurred. Turn the POWER switch off and check if the wiring is correct, then turn it back on.
Other alarms indicators	Contact your Kikusui agent or distributor to request repairs.

# Alarms and Trouble (Cont.)

## Corrective action(Cont.)

### Trouble code and corrective action

Trouble code		Description and corrective action
TRBL-01	DC P.S TRBL	Stop using the PCR-LE2 Series immediately, and contact your Kikusui agent or distributor to request repairs.
TRBL-02	FUSE TRIP TRBL-02-1 FUSE TRIP TRBL-02-2 DCDC FUSE TRIP TRBL-02-3 SENSING FUSE TRIP	Stop using the PCR-LE2 Series immediately, and contact your Kikusui agent or distributor to request repairs.
TRBL-03	SUB P.S FAIL	The internal circuit protection has been activated. Contact your Kikusui agent or distributor to request repairs.
TRBL-19	EXT.SHUT-DOWN	Output stopped as a result of an output shutdown signal received through external contacts.
TRBL-23	OPTION ERROR	Option board installation error. Install the board correctly. If the board is installed correctly, contact your Kikusui agent or distributor to request repairs.
AC INPUT LOW		The input voltage has become lower than the rated value. Wiring errors or short interruption may have occurred. Turn the POWER switch off and check if the wiring is correct, then turn it back on.
Other trouble indicators		Contact your Kikusui agent or distributor to request repairs.

### If ALM-08 (UNIT FAIL) occurs when you restart the PCR-LE Series after a trouble indication occurs

If you turn the POWER switch on while power units in which trouble has occurred and power units in which trouble has not occurred are installed in the PCR-LE2 Series, the ALM-08 (UNIT FAIL) alarm will occur. If you clear the alarm, you can temporarily use the power units in which trouble has not occurred. The output will be limited.

#### - Note -

After a trouble indication occurs, if ALM-08 (UNIT FAIL) is displayed, at least one power unit is malfunctioning. You can use the PCR-LE Series temporarily, but contact your Kikusui agent or distributor to request repairs.

### Confirming the power units in which trouble is occurring

While ALM-08 (UNIT FAIL) is displayed, press ALM CHK (F5).

The power unit of the PCR-LE2 Series is divided into three groups. The group names vary depending on the output method.

Groups during single-phase output: M, S1, and S2

Groups during single-phase three-wire output or three-phase output:

U, V, and W (the W group is not used during single-phase three-wire output).

The alarm code and the power unit in which trouble is occurring will be displayed. If trouble is occurring in two or more power units, turn the rotary knob to check the information.

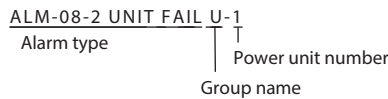

Power unit No.	Total number of power units per group	Total number of power units	Applicable model
0	--	--	Main unit, all models
1 to 2	2	6	PCR6000LE2
1 to 3	3	9	PCR9000LE2
1 to 4	4	12	PCR12000LE2
1 to 6	6	18	PCR18000LE2
1 to 9	9	27	PCR27000LE2

The power-saving function cannot be used if alarms are occurring on all units in any one of the groups.

### Equations for determining the available power and current

Single-phase output

"Na" is the number of power units in which trouble is not occurring. "Nb" is the total number of power units.

Single-phase three-wire output, Three-phase output

"Na" is the number of power units in a group in which problems are not occurring. "Nb" is the total number of power units.

$$\text{Power that can be used} = \text{rated power of the applicable model} \times \frac{N_a}{N_b}$$

$$\text{Current that can be used} = \text{rated current of the applicable model} \times \frac{N_a}{N_b}$$

## Error Message

If you attempt to set a value that is not possible, the PCR-LE2 will generate a beep and an error message.

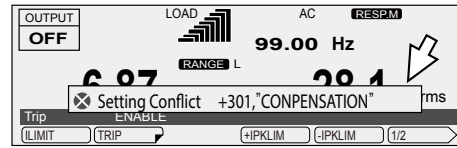

- Example 1: On the PCR6000LE2, when a problem is occurring in one unit in the M/U group and one unit in the S1/V group

Single-phase output:

Power that can be used =  $6000 \times 2/6 = 2000$  W

Current that can be used =  $60 \times 2/6 = 20$  A

Single-phase three-wire output, Three-phase output:

Available power of phase U =  $6000 \times 1/6 = 1000$  [W]

Available current of phase U =  $60 \times 1/6 = 10$  [A]

Available power of phase V =  $6000 \times 1/6 = 1000$  [W]

Available current of phase V =  $60 \times 1/6 = 10$  [A]

Available power of phase W =  $6000 \times 2/6 = 2000$  [W]

Available current of phase W =  $60 \times 2/6 = 20$  [A]

- Example 2: On the PCR6000LE2, when problems are occurring in two units in the M/U group

The power-saving function cannot be used because problems are occurring in all power units in the M/U group. The power-saving function cannot be used on the PCRLE2 Series if alarms are occurring on all units in any one of the groups.

### Error messages and remedies

Error Message	Error Message
+102 "Operation denied (OUTPUT ON)"	Operation is denied because the OUTPUT is on.
+103 "Operation denied (PROTECTION)"	Operation is denied because a protection function is activated.
+104 "Operation denied (OUTPUT COUPLING)"	Operation is denied because the output mode is invalid.
+105 "Operation denied (OUTPUT OFF)"	Operation is denied because the OUTPUT is off.
+106 "Operation denied (TRIP DISABLE)"	Operation is denied because the action to perform when the current limit is exceeded is set to "not to turn the output off (DISABLE)."
+107 "Operation denied (RISE TIME/SIM/SEQ)"	Operation is denied because soft start, power line abnormality simulation, or sequence is in progress.
+108 "Operation denied (WIRING METHOD)"	Operation is denied because the wiring method (single-phase, three-wire; or three-phase) is invalid.
+109 "Operation denied (EXT.OUTPUT OFF)"	Operation is denied because the output has been turned off through external control.
+110 "Operation denied (EXT.SEQ.STOP)"	Operation is denied because a sequence is being executed or stopped through external control.
+111 "Operation denied (V-PROG)"	Operation is denied because the AC voltage output is being controlled with an external signal.
+112 "Operation denied (SOURCE)"	Operation is denied because the action is in conflict with the signal source setting.
+198 "Operation denied (ENTRY)"	Operation denied because the PCR-LE2 is waiting for an ENT key input.
+199 "Operation denied (BUSY)"	The operation is denied because the PCR-LE2 is busy.
+201 "Operation denied (FREQ)"	The sequence cannot be executed because there is a step whose frequency is outside its limits.
+202 "Operation denied (VOLT)"	The sequence cannot be executed because there is a step whose voltage is outside the voltage range or limits.
+203 "Operation denied (PHASE CHANGE)"	The sequence cannot be executed because there is a step whose trigger wait setting and sudden phase change setting are both turned on.
+301 "Setting Conflict (CONPENSATION)"	Cannot be set because the action is in conflict with the compensation setting.
+302 "Setting Conflict (CV RESPONSE)"	Cannot be set because the action is in conflict with the response setting.
+303 "Setting Conflict (RISE TIME)"	Cannot be set because the soft start output is in progress or the action is in conflict with the soft start setting.
+304 "Setting Conflict (SYNCRO)"	Cannot be set because the synchronization function is in use.
+305 "Setting Conflict (TRIP)"	Cannot be set because the action is in conflict with the action that is performed when any of the current limits is exceeded.
+306 "Setting Conflict (UNBALANCE PHASE)"	Cannot be set because the phase difference is unbalanced.
+308 "Setting Conflict (OUTPUT IMPEDANCE)"	Cannot be set because an output impedance is set.
+309 "Setting Conflict (WAVE BANK)"	Cannot be set because a waveform other than waveform bank No. 0 is in use.

# Index

## A

Alarms 132  
aperture time 32

## B

Breaker trip 42

## C

Calibration 129  
Canceling settings 21  
cleaning 129  
Compensation Function 50  
Control Panel 18  
    Detaching or Attaching 20  
Current limit 36  
    Action to perform when the it is exceeded 38

## D

date setting 44  
Displaying  
    Current, power, and power factor 33  
    Load level meter 33  
    Single-phase, three-wire output and three-phase output 22

## E

Ending phase angle (sequence function) 59  
ENT wait 21  
Error Message 135  
External Analog Signals 72  
    Amplifying the input waveform 73  
    Varying the voltage of the output AC using DC signals 75, 76  
External contact  
    Clear alarms 79  
    Output On/ Off 78  
    Sequence Execute/Stop 78  
    Shut down the output 79

## F

Factory Default Settings 126  
Firmware version 23  
Frequency 30  
Frequency upper and lower limits 35  
Front Panel 17  
full scale bar 33

## H

Hard sensing 50  
Harmonic Current Analysis Function 67  
Home position 21

## I

Initialization 126  
Input voltage drop protection 40  
Internal memory 43  
Internal semiconductor protection 41  
    time that elapses before an alarm is generated 41  
Internal Vcc 70

## K

Key lock 23

## M

measurement time 32  
MEDIUM 70  
Memory 42  
Monitoring the operation status 80

## N

Numeric keypad 22

## O

OCP 41  
    time that elapses before an alarm is generated 41  
Operating Characteristics 97  
Output  
    On and Off 30  
    Phase control 31  
    Voltage surge suppression 31  
Output Impedance 69  
Output voltage 26  
    Single-phase, three-wire output 28  
    Three-phase output 29  
Output voltage mode 25  
Output voltage range 26  
Overheat protection 40  
Overload protection 40  
Overvoltage protection 40

## P

Panel Operation Basics 20  
Peak current

Clearing 33

Holding 33

Phase difference  
    setting (single-phase three-wire) 28  
    setting (three-phase) 29  
phase wait time 59  
Power Line Abnormality Simulations 55  
Power Management Function 71  
Power-saving function 71  
Protection Function 40

## R

Ramp (Sequence function) 58  
Rear Panel 19  
Regulation adjustment 50  
reset 126  
Response 70  
Rise time 69  
Rotary knob 23

## S

Screen brightness 23  
Sequence Function 58  
SIGNAL I/O 77  
SLOW 70  
Soft sensing 50  
Soft Start 69  
Special Waveform 68  
Starting phase angle (sequence function) 59  
Sudden phase change (sequence function) 59  
Switching from remote to local 22  
Synchronization Function 49

## T

time setting 44  
Trip time 39  
Trouble 132  
Troubleshooting 130

## U

Undervoltage protection 40  
USB memory 44

## V

Voltage compensation Function 50  
Voltage surge suppression 31



## W

Waveform bank 68

### **The accompanying CD-ROM describes the following information.**

---

Communication Interface Manual

Quick Reference

Safety Information

Table for Power Line Abnormality Simulation

Table for Sequence Operation

If you find any misplaced or missing pages in the manuals, they will be replaced. If the manual gets lost or soiled, a new copy can be provided for a fee. In either case, please contact your Kikusui agent or distributor. At that time, inform your agent or distributor of the "Part No." written on the front cover of this manual.

Every effort has been made to ensure the accuracy of this manual. However, if you have any questions or find any errors or omissions, please contact your Kikusui agent or distributor.

After you have finished reading this manual, store it so that you can use it for reference at any time.

## KIKUSUI ELECTRONICS CORP.

---

1-1-3 Higashiyamata, Tsuzuki-ku, Yokohama,  
224-0023, Japan  
Tel: +81-45-482-6353 Fax: +81-45-482-6261



Website

<http://www.kikusui.co.jp/en>