

New Flagship

New



## **Ultra-Compact AC/DC Programmable Power Supply PCR-WE/WE2 Series**

Compact size: 6 kVA in 6U size (PCR6000WE2)

Up to 36 kVA in one single unit

100% Regenerative Capability

Mix-and-match parallel operation up to 144 kVA

Flexible Digital Interface: LAN (LXI), USB, RS232C, GPIB (factory option)

Power Line Disturbance Simulation

Power-saving function

DC output (100% of rated power)

Output Frequency up to 5 kHz

Output Rating: AC 0 to 310 Vrms, DC 0 to  $\pm 438$  V

# HIGH POWER, DOWNSIZED

6 kVA in a 6U frame and up to 36 kVA in a single unit with regenerative capabilities\*1. The next generation of high-power programmable AC power supplies.

## Ultra-Compact AC/DC Programmable Power Supply PCR-WE/WE2 Series NEW

The PCR-WE/WE2 is a series of multifunctional switching AC power supplies that combines accurate, high power output and ultra-compact design. The 15 model line-up ranges from 1 kVA to 36 kVA AC/DC with single & 3 phase variable output from 6 kVA and up. The PCR-WE/WE2 also features a regenerative mode\*1 that can drastically reduce power consumption and cut the costs of operation. The PCR-WE/WE2 also supports mix-and-match parallel operation\*2 up to 144 kVA for large scale test systems. Output frequency up to 5 kHz is also available with all models for critical AC applications in the avionic industries.

- **Compact Size: 6 kVA in 6U frame (PCR6000WE2)**
- **Up to 36 kVA in a single unit (PCR36000WE2)**
- **100% Regenerative power capability\*1**
- **Mix-and-match parallel operation up to 144 kVA**
- **Flexible Digital Interface:**  
LAN (LXI), USB, RS232C, GPIB (option)
- **Power line disturbance simulation features**
- **Sequence function for advanced simulation**
- **External analog, digital control function (standard)**
- **Power-saving function**
- **DC output (100% of rated power)**
- **Output Frequency up to 5 kHz**
- **Output Rating: AC 0 to 310 Vrms, DC 0 to ±438 V**

\*1: Only "R" models (PCR-WE2R) with 3-phase 200 V input. For regeneration within the installation site only.

\*2: Parallel operation is available for 6 kVA models and up with a maximum of 4 units. Same model combination is not required. Up to 48 kVA per phase.



Refer to P14 for full scale.



## ● Lineup

Specifications		Input rating (AC rms)			AC mode output rating					DC mode output rating		
Model	Phase	Voltage (allowable variation range)	Apparent power	Current	Phase	Phase voltage	Max. current *1 (L/H range)	Power capacity	Frequency	Voltage	Max. current *2 (L/H range)	Power capacity
		V	kVA or less	A or less		V	A	VA		Hz	V	A
PCR1000WE	Single-phase	85 to 132/170 to 250	1.4	17/8.5	Single-phase	1 to 155/ 2 to 310 (L/H output range)  (Voltage setting range) 0 to 157.5/ 0 to 315.0	10/5	1 k	1 to 5000	±1.4 to ±219/ ±2.8 to ±438 (L/H output range)  (Voltage setting range) -222.5 to +222.5/ -445.0 to +445.0	10/5	1 k
PCR2000WE	Single-phase	85 to 132/170 to 250	2.7	32/16	Single-phase		20/10	2 k			20/10	2 k
PCR3000WE2	Single-phase	85 to 132/170 to 250	4	48/24	Single-phase		30/15	3 k			30/15	3 k
					Three-phase		10/5					
PCR6000WE2R	Three-phase Three-wire	Line voltage 170 to 250	7.8	27	Single-phase		60/30	6 k			60/30	6 k
PCR6000WE2	Three-phase Four-wire	Line voltage 323 to 519		14	Three-phase		20/10	4 k				
PCR12000WE2R	Three-phase Three-wire	Line voltage 170 to 250	15.6	53	Single-phase		120/60	12 k			120/60	12 k
PCR12000WE2	Three-phase Four-wire	Line voltage 323 to 519		28	Three-phase		40/20	8 k				
PCR18000WE2R	Three-phase Three-wire	Line voltage 170 to 250	23.4	80	Single-phase		180/90	18 k			180/90	18 k
PCR18000WE2	Three-phase Four-wire	Line voltage 323 to 519		42	Three-phase		60/30	12 k				
PCR24000WE2R	Three-phase Three-wire	Line voltage 170 to 250	31.2	106	Single-phase		240/120	24 k			240/120	24 k
PCR24000WE2	Three-phase Four-wire	Line voltage 323 to 519		56	Three-phase		80/40	16 k				
PCR30000WE2R	Three-phase Three-wire	Line voltage 170 to 250	39	133	Single-phase		300/150	30 k			300/150	30 k
PCR30000WE2	Three-phase Four-wire	Line voltage 323 to 519		70	Three-phase		100/50	20 k				
PCR36000WE2R	Three-phase Three-wire	Line voltage 170 to 250	46.8	159	Single-phase		360/180	36 k			360/180	36 k
PCR36000WE2	Three-phase Four-wire	Line voltage 323 to 519		84	Three-phase		120/60	24 k				

\*1 When the output phase voltage is between 100 Vac and 155 Vac or 200 Vac and 310 Vac, the output current is reduced by the output voltage. When the output frequency is between 1 Hz and 40 Hz, the output current is reduced by the output frequency.

\*2 When the output voltage is between 100 Vac and 219 Vac or 200 Vac and 438 Vac, the output current is reduced by the output voltage.

★ 500 Hz Limit Model is available. The PCR-WE2 Series offers a limited frequency type with a maximum output frequency of 500 Hz.

## ● Dimensions/Weight

Model	Dimensions(mm(inch))(Maximum size)	Weight
PCR1000WE	430(16.9")W×129.2(5.1")H×655(25.8")Dmm	16 kg(35.3 lb)
PCR2000WE	430(16.9")W×129.2(5.1")H×655(25.8")Dmm	20 kg(44.1 lb)
PCR3000WE2	430(16.9")W×129.2(5.1")H×655(25.8")Dmm	23 kg(50.7 lb)
PCR6000WE2R	430(16.9")W×262(10.3")H×550(21.7")Dmm	42 kg(92.6 lb)
PCR6000WE2	430(16.9")W×262(10.3")H×550(21.7")Dmm	43 kg(94.8 lb)
PCR12000WE2R	430(16.9")W×389(15.3")H×550(21.7")Dmm	66 kg(145.5 lb)
PCR12000WE2	430(16.9")W×389(15.3")H×550(21.7")Dmm	65 kg(143.3 lb)
PCR18000WE2R	430(16.9")W×690(27.2")H×550(21.7")Dmm	120 kg(264.6 lb)
PCR18000WE2	430(16.9")W×690(27.2")H×550(21.7")Dmm	120 kg(264.6 lb)

Model	Dimensions(mm(inch))(Maximum size)	Weight
PCR24000WE2R	430(16.9")W×445(17.5")H×690(27.2")Dmm	130 kg(286.6 lb)
PCR24000WE2	430(16.9")W×445(17.5")H×690(27.2")Dmm	130 kg(286.6 lb)
PCR30000WE2R	430(16.9")W×445(17.5")H×944(37.2")Dmm	160 kg(352.7 lb)
PCR30000WE2	430(16.9")W×445(17.5")H×944(37.2")Dmm	160 kg(352.7 lb)
PCR36000WE2R	430(16.9")W×445(17.5")H×944(37.2")Dmm	180 kg(396.8 lb)
PCR36000WE2	430(16.9")W×445(17.5")H×944(37.2")Dmm	170 kg(374.8 lb)

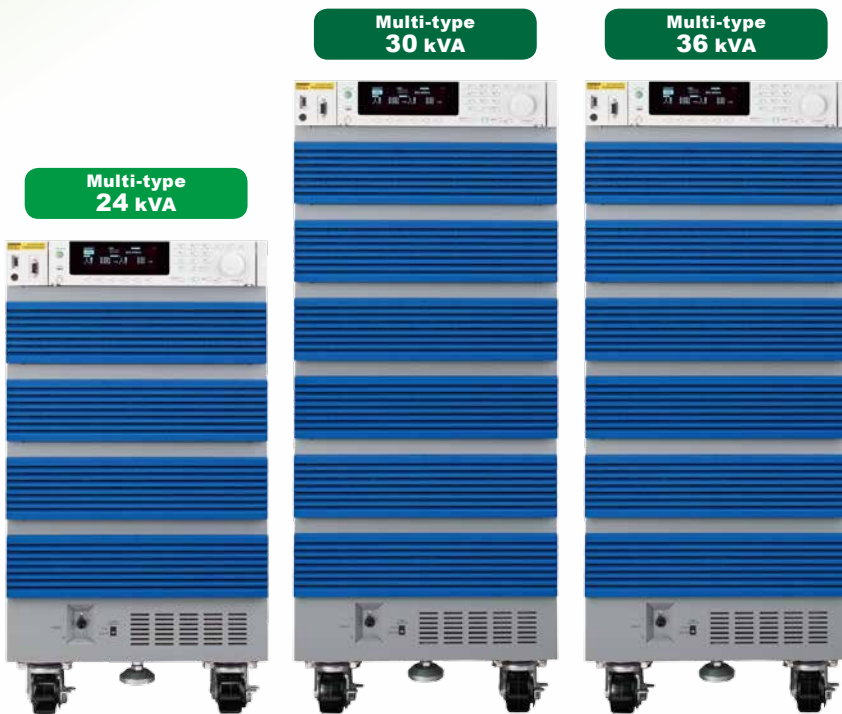

PCR24000WE2  
PCR24000WE2R

PCR30000WE2  
PCR30000WE2R

PCR36000WE2  
PCR36000WE2R

### Features

P4-P5

### Performance

P6

### Applications

P7

### Exterior Design

P8-P9

### Specifications

P10-P13

### Option/Cable

P13



# PWM Inverter Type - Programmable AC Power Supply

The PCR-WE/WE2 series brings new innovations to the power electronics industry.

## Compact Size!

Compared to our previous PWM models, the size of the PCR-WE has been drastically reduced up to 60%. Efficiency has also been increased by approximately 7%, for an overall high efficiency of approximately 85%.

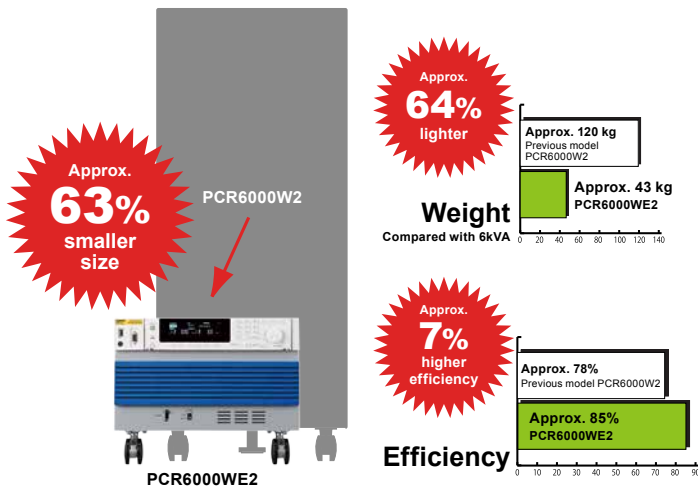

## Up to 144 kVA with Parallel Operation

Parallel operation is available on all models by simply connecting an optional parallel operation cable. This feature is available even among different models for a wide range of high power.

\*Same input voltage required for 6 kVA models and higher.



- Mix-and-match parallel operation (example)

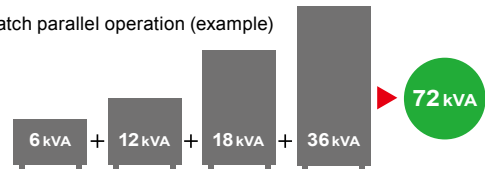

- Connection diagram

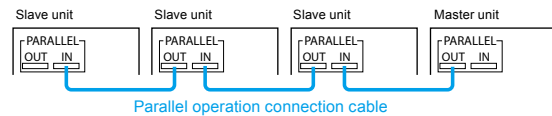

## Extremely Power Dense 36 kVA Chassis

The PCR-WE/WE2 form factor has been significantly improved, occupying the absolute minimum amount of precious space in your testing facility.

Form factor is even further optimized in high power models.

- Installation area comparison (36 kVA)  
The PCR-WE/WE2 is only 1/6th the size of the PCR-LE!

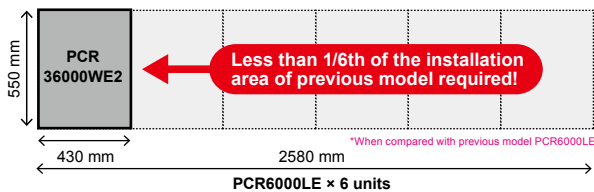

- Weight Comparison (36 kVA)  
The PCR-WE/WE2 is approximately 80% lighter than the PCR-LE!



## Low Ripple Noise

Extremely low switching noise for a PWM inverter type AC power supply, with ripple noise as low as 0.25 rms achieved with 1 kVA - 6 kVA models. The PCR-WE series even boasts similar noise performance to the PCR-LE/LE2 linear amplifier power supply series. The compact, high power design of the PCR-WE/WE2 has been achieved with absolutely no compromises to ripple noise performance.

## 100% Regeneration Capability, No Time Limit

The PCR-WE2R models are capable of 100% power regeneration. The power regeneration feature is available with absolutely no reverse load flow time limit. (30% for PCR-LE/LE2)

\*Regeneration is limited within installation site. Only available in "R" models (PCR-WE2R) with 3-phase 200 V input.

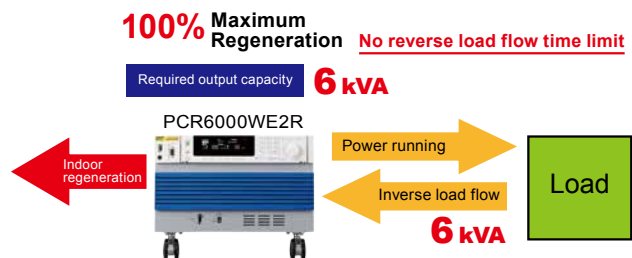

## Output Frequency up to 5 kHz

Maximum output frequency up to 5 kHz for critical applications in the defense and avionics industries. The frequency performance of the PCR-WE allows for simulation of sharp voltage fluctuations required airborne electronic equipment testing. Furthermore, the compact 6kVA/6U form factor allows for the easy preparation of an automated, one rack testing system without requiring a costly, specialized power source installation space.



## DC Output 100% of Rated Power

The PCR-WE/WE2 series enables DC output up to 100% of the AC rated power output.

### DC output: 100% of AC output rating

Required output capacity **6 kVA**



## LAN, USB, RS232C Standard Digital Interface

The PCR-WE/WE2 series includes a flexible digital interface for users utilizing LAN, USB, and RS232C communication interfaces (GPIB factory option available). LAN connection is LXI compliant, allowing you to monitor and control your device wherever you are via computer, smartphone, or tablet web browser. This feature is particularly important when conducting critical AC tests in anechoic chambers/shield rooms. Additionally, the PCR-WE can be controlled directly with easy remote control software (coming soon) for customers with limitations in external communication.

### ● Wired LAN connection (optical cable)

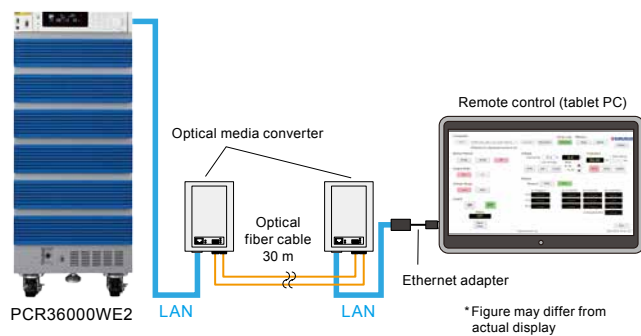

### ● Wireless LAN connection

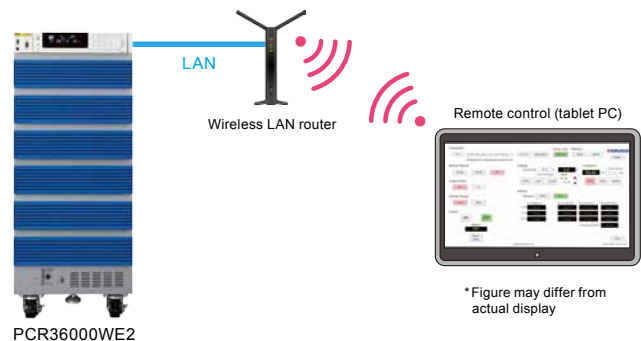

## Power Saving Mode \*6 kVA models and higher

### ● Sleep mode

If the PCR-WE/WE2 does not detect output for a certain amount of time, the power unit will go into "sleep mode" and cut power consumption.

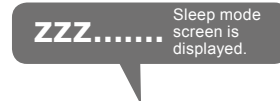

### ● Power-saving mode

The power saving feature allows the PCR-WE to cut the costs of operation by drawing power from only the necessary power modules required to reach the output setting.

[Example]  
Only 6 kVA drawn from the 36 kVA model

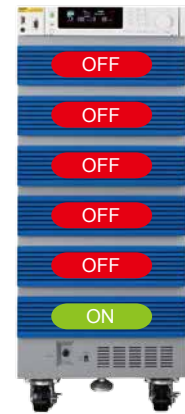

### Modular design allows for simple maintenance

Each separate power module can be removed and replaced for maintenance and calibration. \*For models 6 kVA and higher

## Power Line Error Simulation

The PCR-WE/WE2 series can simulate various power line abnormalities such as power outages, voltage drops (dips) and voltage increases (pops). This feature is useful for the testing of power source switches and various electronic devices.

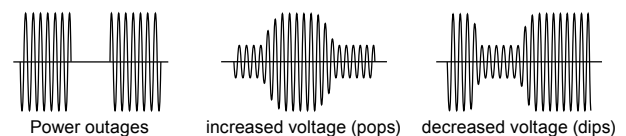

## Built-in parallel operation driver software! Easy parallel operation with a single connection cable.

The PCR-WE/WE2 series can be easily configured in a parallel connection with a single cable\* per connection for all models 6kVA and above. This cable can be used in synchronization with a power interlock cable\* to control the ON/OFF status of master/slave units. \*Optional

### Performance

#### ●Example of the combined system using same models

Capacity	Model	Qty	Parallel operation cable	Qty	Power-sync cable	Qty
12 kVA	PCR6000WE2	2	PC01-PCR-WE	1	LC01-PCR-LE	1
48 kVA	PCR24000WE2R	2	PC01-PCR-WE	1	LC01-PCR-LE	1
90 kVA	PCR30000WE2R	3	PC01-PCR-WE	2	LC01-PCR-LE	2
144 kVA	PCR36000WE2R	4	PC01-PCR-WE	3	LC01-PCR-LE	3

[PCR36000WE2R 4 units, example of 144 kVA]

The figure below is a conceptual diagram. Power wiring etc. are also required for system build up. Please consult your local Kikusui distributor.

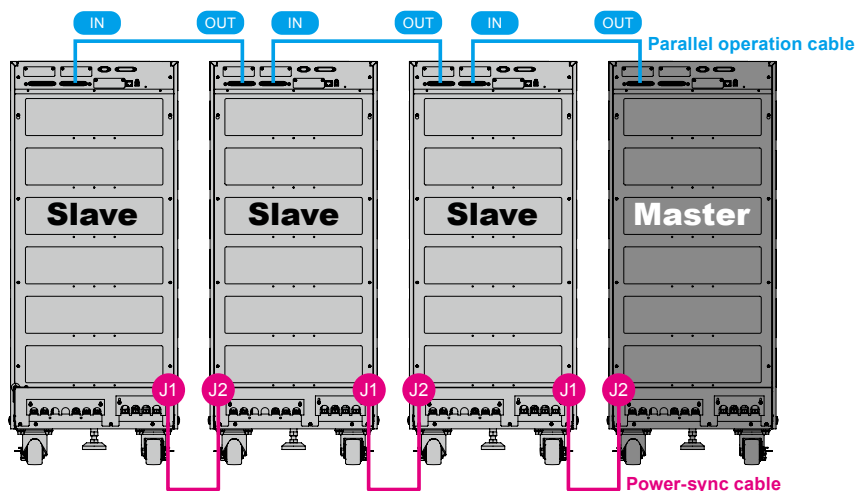

#### ●Example of the combined system using different models

Capacity	Model	Part	Qty
72 kVA Parallel operation system	PCR6000WE2R	AC/DC Power supplies (6 kVA)	1
	PCR12000WE2R	AC/DC Power supplies (12 kVA)	1
	PCR18000WE2R	AC/DC Power supplies (18 kVA)	1
	PCR24000WE2R	AC/DC Power supplies (24 kVA)	1
	PC01-PCR-WE	Parallel operation cable	3
	LC01-PCR-LE	Power-sync cable	3

The figure below is a conceptual diagram. Power wiring etc. are also required for system build up. Please consult your local Kikusui distributor.

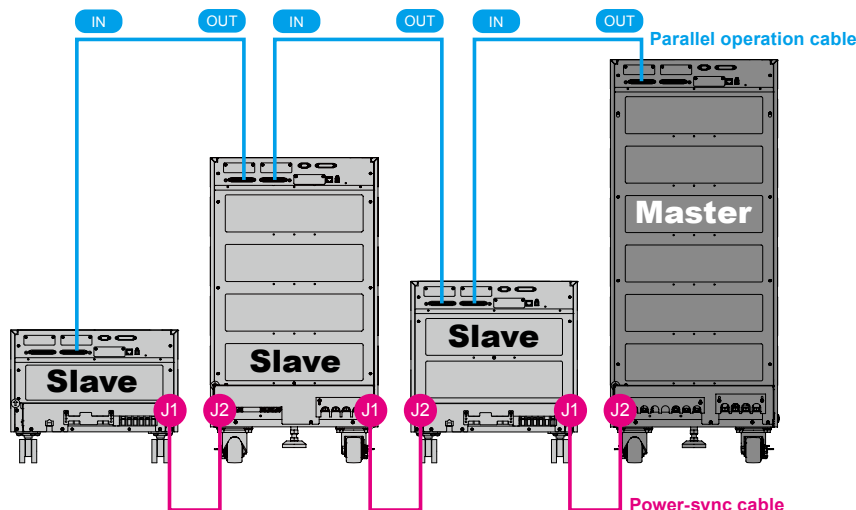

# Applications

## For Standard Compliance Testing

### ● Single phase system

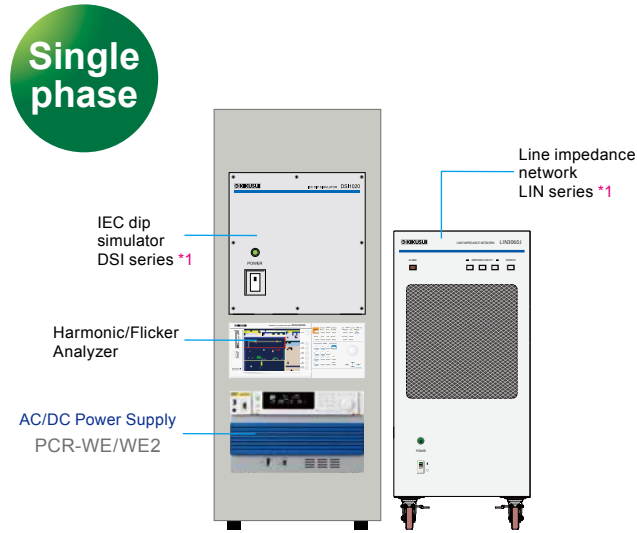

### ● Three phase system

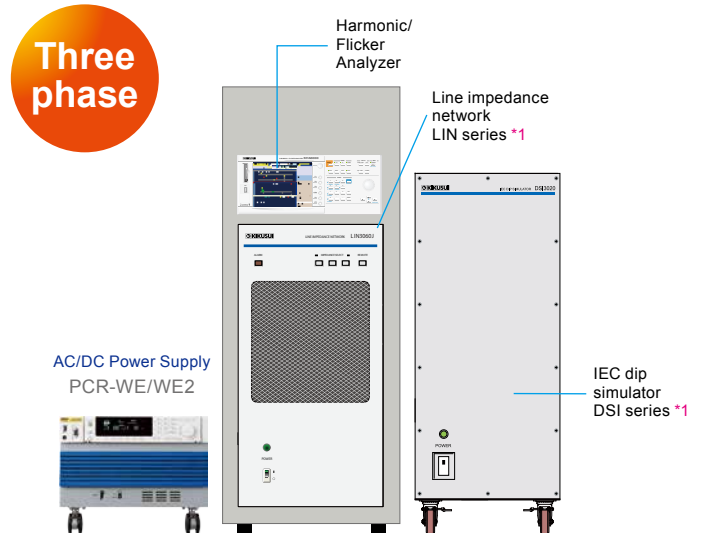

This system can simulate various conditions of phenomena occurring in AC power environments. It can be used for immunity tests of electrical and electronic devices which are connected to a low-voltage distribution system, or which have DC power input ports, under the standard conditions as specified on the right. The test conditions can be set outside the standard range, allowing the system to be used for preliminary tests prior to standard tests, immunity margin tests, and stress tests. The KHA3000 harmonic/flicker analyzer combines a PCR-WE/WE2 Series AC power supply, LIN Series line impedance network\*1, DSI series IEC dip simulator\*2 and application software(Coming soon), allowing tests which conform to IEC standards and JIS standards.

\*1 Manufactured by special order.

IEC61000-4-11	Voltage dipping, instantaneous power failure and voltage variation
IEC61000-4-13	Higher harmonics wave/interharmonic wave
IEC61000-4-14	Voltage swing
IEC61000-4-27	Unbalance in units
IEC61000-4-28	Variation in power supply frequency for units with 16 A/phase
IEC61000-4-34	Voltage drop(dip), instantaneous power failure and voltage variation for units with input current exceeding 16 A/phase
IEC61000-4-17	Ripple at the DC input power terminal
IEC61000-4-29	Voltage drop(dip), instantaneous power failure and voltage variation in DC *2
IEC61000-3-2,12	Harmonic electric current limit level
IEC61000-3-3,11	Voltage fluctuation, Flicker limit level

\*2 Designed for preliminary test purposes.

## For Testing of the EV Charging System

### ● EV charging system (Item under test)

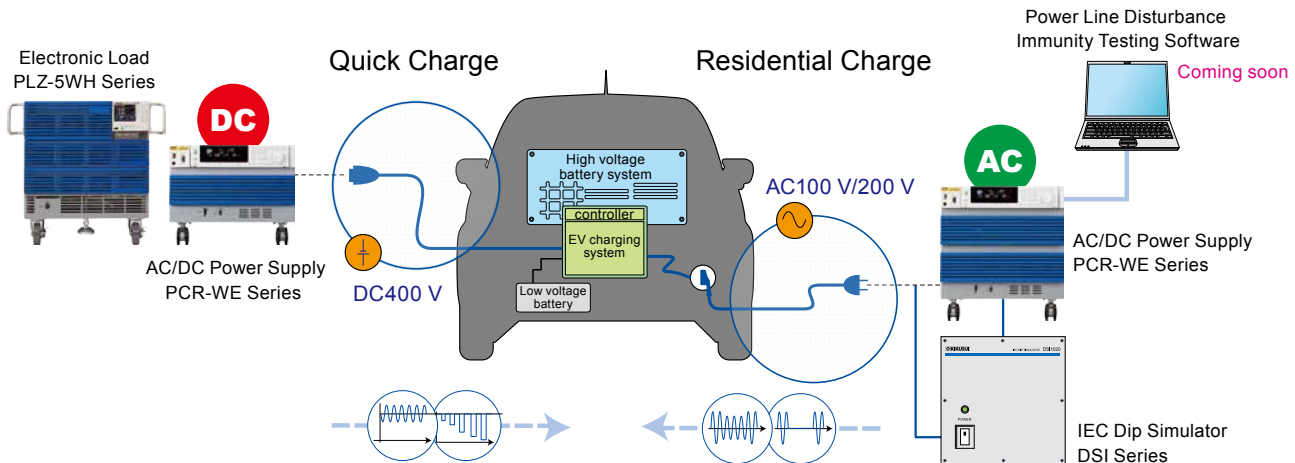

# Exterior Design

## Front Panel

### PCR1000WE/2000WE/3000WE2

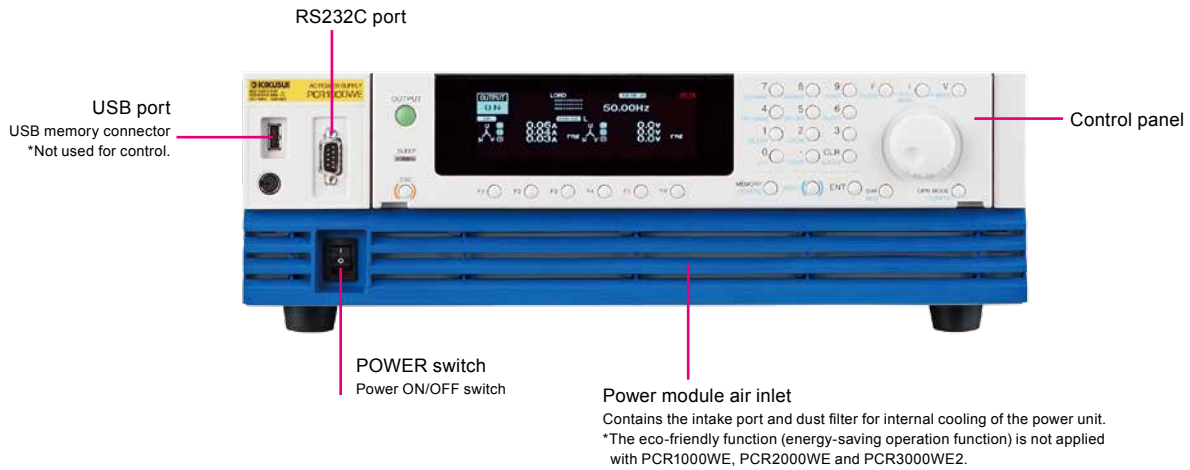

### PCR12000WE2

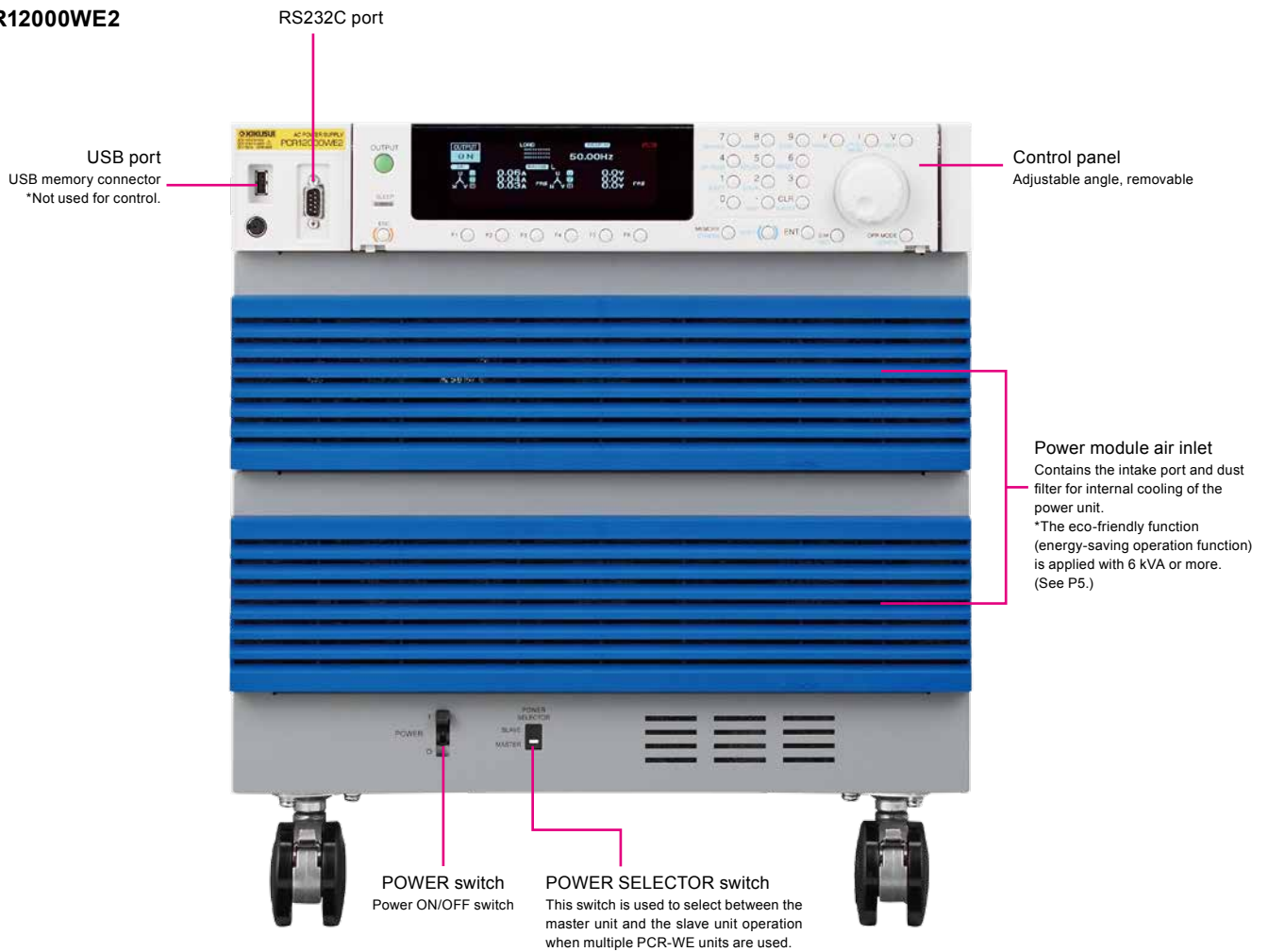



## Rear Panel

**PCR1000WE/2000WE/3000WE2** \*The image is PCR3000WE2.

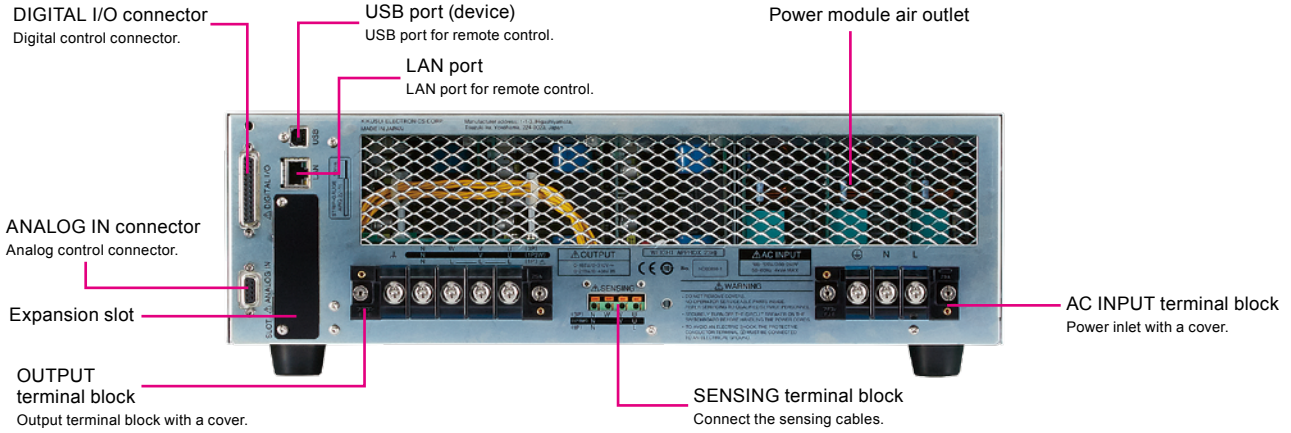

**PCR6000WE2**

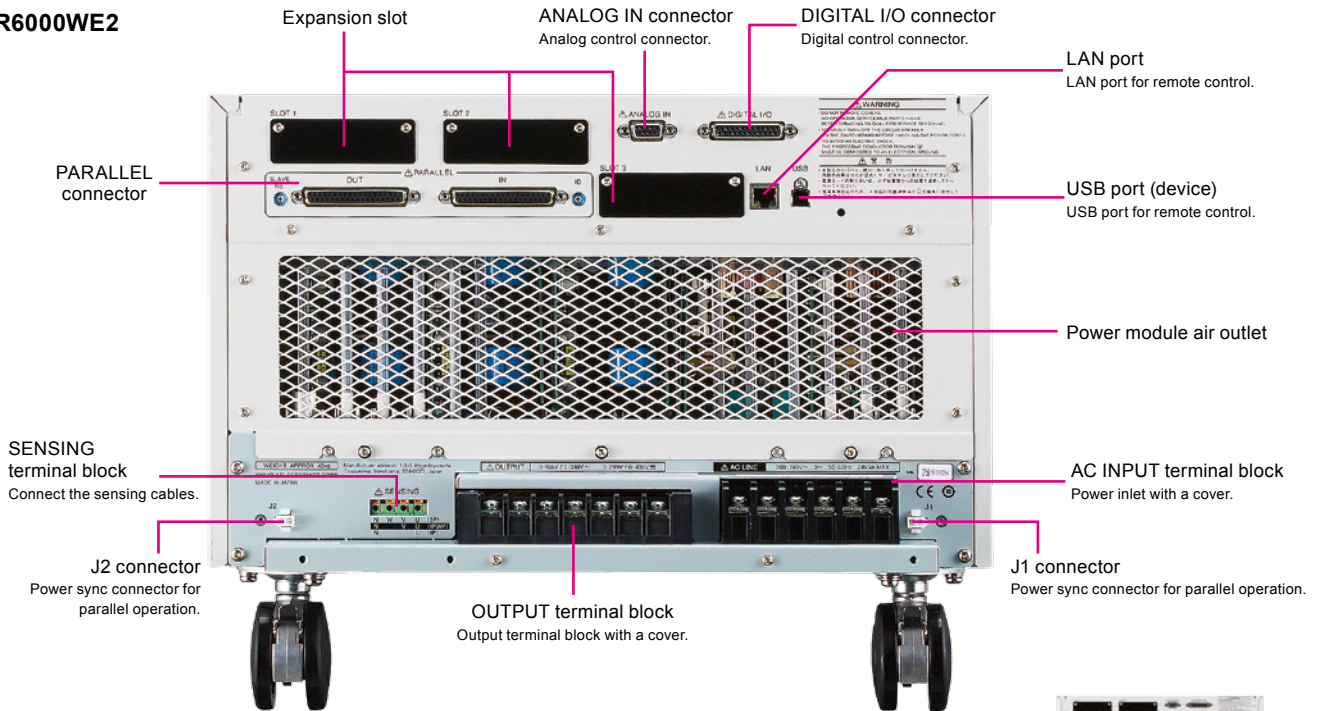

PCR1000WE  
PCR2000WE  
PCR3000WE2



PCR6000WE2  
PCR6000WE2R



PCR12000WE2  
PCR12000WE2R



PCR18000WE2  
PCR18000WE2R  
PCR24000WE2  
PCR24000WE2R

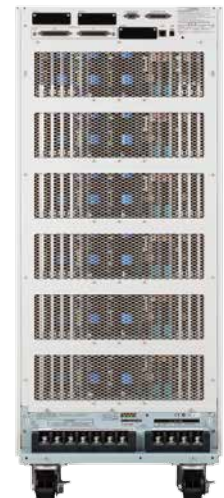

PCR30000WE2  
PCR30000WE2R  
PCR36000WE2  
PCR36000WE2R

## Specifications

Unless specified otherwise, the specifications are for the following settings and conditions.

- The warm-up time is 30 minutes (with current flowing). • TYP: These are typical values that are representative of situations where the product operates in an environment with an ambient temperature of 23°C. These values do not guarantee the performance of the <series name>.
- setting: Indicates a setting. • reading: Indicates the readout value. • f.s: Indicates full scale.

### Input (AC rms)

Model		Single-phase output			Single-phase/three-phase switchable model					
		PCR 1000WE	PCR 2000WE	PCR 3000WE2	PCR 6000WE2	PCR 12000WE2	PCR 18000WE2	PCR 24000WE2	PCR 30000WE2	PCR 36000WE2
Nominal input voltage	1P2W input model	100 Vac to 120 Vac / 200 Vac to 240 Vac *1			—					
	3P3W input model	—			200 Vac to 240 Vac (3 phase line voltage) *2					
	3P4W input model	—			380 Vac to 480 Vac (3 phase line voltage) *3					
Phase		Single-phase			Three-phase					
Nominal input Frequency		50 Hz to 60 Hz								
Input frequency range		45 Hz to 65 Hz								
Apparent power		1.4 kVA and less	2.7 kVA and less	4 kVA and less	7.8 kVA and less	15.6 kVA and less	23.4 kVA and less	31.2 kVA and less	39 kVA and less	46.8 kVA and less
Power factor *5		0.95(TYP)			0.97(TYP) 3P3W input model *2 / 0.95(TYP) 3P4W input model *3					
Maximum current *4	1P2W input model	17 A / 8.5 A	32 A / 16 A	48 A / 24 A	—					
	3P3W input model *2	—			27 A	53 A	80 A	106 A	133 A	159 A
	3P4W input model *3	—			14 A	28 A	42 A	56 A	70 A	84 A
Holdup time for power interruption *5		10 ms								

\*1 100 V/200 V input system (auto select) \*2 PCR-WE2R models \*3 PCR-WE2 models \*4 Current at the minimum voltage (within the allowable variation range)

\*5 At output voltage 100 V/200 V, rated output current, sine wave, load power factor 1, output frequency 40 Hz to 1 kHz.

### Output

Model		Single-phase output			Single-phase/three-phase switchable model					
		PCR 1000WE	PCR 2000WE	PCR 3000WE2	PCR 6000WE2	PCR 12000WE2	PCR 18000WE2	PCR 24000WE2	PCR 30000WE2	PCR 36000WE2
AC voltage *1	Rating	155 V / 310 V *2								
	Setting range	0 V to 157.5 V / 0 V to 315.0 V								
	Setting resolution	0.1 V								
	Setting accuracy (phase voltage) *3 *4	±(0.3 % of setting + 0.3 V), ±(0.3 % of setting + 0.6 V)								
	Setting accuracy (Line voltage) *3 *4	±(0.3 % of setting + 0.3 V), ±(0.3 % of setting + 0.6 V) *5								
Maximum current *1 *6	Single-phase output	10 A / 5 A	20 A / 10 A	30 A / 15 A	60 A / 30 A	120 A / 60 A	180 A / 90 A	240 A / 120 A	300 A / 150 A	360 A / 180 A
	Single-phase three-wire output, Three-phase output	—		10 A / 5 A	20 A / 10 A	40 A / 20 A	60 A / 30 A	80 A / 40 A	100 A / 50 A	120 A / 60 A
Phase		1P			1P2W, 1P3W, 3P4W switchable					
Power capacity	Single-phase output	1 kVA	2 kVA	3 kVA	6 kVA	12 kVA	18 kVA	24 kVA	30 kVA	36 kVA
	Three-phase output	—			2 kVA	4 kVA	8 kVA	12 kVA	16 kVA	24 kVA
	Single-phase three-wire output	—			2 kVA	4 kVA	8 kVA	12 kVA	16 kVA	24 kVA
Maximum peak current *11		4 times the maximum output current								
Inrush current capacity *3		3 times the rated current (0.07 s)			1.4 times the rated current (0.5 s)					
Load power factor		0 to 1 (leading or lagging)								
Frequency	Setting range	1 Hz to 5 kHz *7 (5 kHz -3dB, <40 Hz derating required)								
	Resolution	0.01 Hz(1.00 Hz to 100.0 Hz), 0.1 Hz(100.0 Hz to 1000 Hz), 1 Hz(1000 Hz to 5000 Hz)								
	Accuracy	±0.01 % *3, Temperature coefficient : ±0.005 %/°C								
Phase	Resolution	—			0.1°(1 Hz to 500 Hz), 1°(500 Hz to 4 kHz), 2°(4 kHz or more)					
	Accuracy *3	—			Within 120°±(0.4°+2.5 μs) *8 Within (120°±(0.4°+fo×0.9×10 <sup>-3o</sup> )) fo : frequency [kHz]					
DC voltage	Rating *1	-219 V to +219 V / -438 V to +438 V *2								
	Setting range *1	-222.5 V to +222.5 V / -445.0 V to +445.0 V								
	Resolution	0.1 V								
	Accuracy *9	±(0.05 % of setting +0.1 V)								
	Maximum current *6	10 A / 5 A	20 A / 10 A	30 A / 15 A	60 A / 30 A	120 A / 60 A	180 A / 90 A	240 A / 120 A	300 A / 150 A	360 A / 180 A
Power capacity		1 kW	2 kW	3 kW	6 kW	12 kW	18 kW	24 kW	30 kW	36 kW
Efficiency *10		82 % (TYP)			85 % (TYP)					

\*1 output L range, output H range

\*2 Specification guaranteed voltage range is 1 V to 155 V/2 V to 310 V (AC) and 1.4 V to 219 V/2.8 V to 438 V (DC)

\*3 At ambient temperature of 23 °C±5 °C.

\*4 No load, output frequency 45 Hz to 65 Hz

\*5 When the phase angle of 120° of each phase.

\*6 For output phase voltage of 100 Vac to 155 Vac/200 Vac to 310 Vac and output voltage of 100 Vdc to 219 Vdc/200 Vdc to 438 Vdc, output current is reduced with output voltage. When the output frequency is between 1 Hz and 40 Hz, the output current is reduced by the output frequency. The output current is 70 % at 1 Hz.

\*7 On the 500 Hz limit model, the frequency is limited to 1 Hz to 500.0 Hz for three-phase output.

\*8 The following show the angles obtained by calculating the expression with the specified frequency.

Within 120°±0.5° (when generating 60 Hz output)

Within 120°±0.8° (when generating 400 Hz output)

\*9 With no load at 23°C±5°C.

\*10 When the output voltage is 100 V or 200 V, the output current is the rated value, the load power factor is 1, and the output frequency is between 40 Hz and 1 kHz.

\*11 Depends on the load input impedance.

## Regeneration Function

Only for three-phase three-wire input models with R at the end of the model name. Single phase output models and three-phase four-wire input models do not have regeneration function. For regeneration within the installation site only.

Model	Single-phase/three-phase switchable model						
	PCR 6000WE2R	PCR 12000WE2R	PCR 18000WE2R	PCR 24000WE2R	PCR 30000WE2R	PCR 36000WE2R	
Maximum regenerated power *1	6 kVA	12 kVA	18 kVA	24 kVA	30 kVA	36 kVA	
Maximum reverse power flow current *1 *2	1P2W	60 A / 30 A	120 A / 60 A	180 A / 90 A	240 A / 120 A	300 A / 150 A	360 A / 180 A
	1P3W 3P	20 A / 10 A	40 A / 20 A	60 A / 30 A	80 A / 40 A	100 A / 50 A	120 A / 60 A
Regeneration efficiency *3	85 % (TYP)						
Output current harmonic distortion	THD: 5 % and less, each harmonic: 3 % and less (2nd to 40th)						

\*1 When the output phase voltage is between 100 Vac and 155 Vac or 200 Vac and 310 Vac, the output current is reduced by the output voltage.

When the output frequency is between 1 Hz and 40 Hz, the output current is reduced by the output frequency. The output current is 70 % at 1 Hz.

\*2 When the output voltage is 100 V or 200 V and the output frequency is between 40 Hz and 1 kHz (when the current phase is -90 deg to -180 deg or 90 deg to 180 deg relative to the output voltage)

\*3 When the output voltage is 100 V or 200 V, the output current is the rated value, sine wave, the load power factor is 1, and the output frequency is between 45 Hz to 65 Hz.

## Output Voltage Stability (Phase Voltage)

Model	Single-phase output			Single-phase/three-phase switchable model					
	PCR 1000WE	PCR 2000WE	PCR 3000WE2	PCR 6000WE2	PCR 12000WE2	PCR 18000WE2	PCR 24000WE2	PCR 30000WE2	PCR 36000WE2
				PCR 6000WE2R	PCR 12000WE2R	PCR 18000WE2R	PCR 24000WE2R	PCR 30000WE2R	PCR 36000WE2R
Line regulation *1	Within $\pm 0.1$ %								
Load regulation *2	Within $\pm 0.1$ V / $\pm 0.2$ V (1 Hz to 100 Hz) Within $\pm 0.3$ V / $\pm 0.6$ V (100.1 Hz to 500 Hz) Within $\pm 1$ V / $\pm 2$ V (500.1 Hz to 1 kHz)			Within $\pm 0.2$ V / $\pm 0.4$ V (1 Hz to 100 Hz) Within $\pm 0.3$ V / $\pm 0.6$ V (100.1 Hz to 500 Hz) Within $\pm 1$ V / $\pm 2$ V (500.1 Hz to 1 kHz)					
Output frequency variation *3	When the output voltage correction function is enabled : Within $\pm 0.3$ % (1 Hz to 1 kHz), Within $\pm 10$ % (100.1 Hz to 5 kHz) When the output voltage correction function is disabled : Within -3 dB (5 kHz)								
Ripple noise *4	$\leq 0.25$ Vrms			$\leq 0.3$ Vrms	$\leq 0.4$ Vrms	$\leq 0.5$ Vrms	$\leq 0.6$ Vrms	$\leq 0.7$ Vrms	$\leq 0.7$ Vrms
Ambient temperature variation *5	$\pm 100$ ppm/ °C (TYP)								
Total harmonic distortion *6	0.3 % and less (1 Hz to 100 Hz), 0.5 % and less (100.1 Hz to 330 Hz), 1.5 %/kHz and less (330.1 Hz to 5 kHz)								
Transient response *7	Response FAST : 55 $\mu$ s (TYP)								
Response speed Tr/Tf *8	Response FAST : 55 $\mu$ s (TYP) Response MEDIUM : 100 $\mu$ s (TYP) Response SLOW : 300 $\mu$ s (TYP)								

\*1 With respect to changes in the rated range of input voltage.

\*2 With respect to 0 % to 100 % changes in the rating of output current.

When the output phase voltage is between 80 V and 155 V (L range) or 160 V and 310 V (H range) and the load power factor is 1, and the response is FAST.

At the output terminal block. When the compensation function is not used.

\*3 Voltage variation over 40 Hz to 5 kHz in AC mode with 55 Hz as the reference.

When the output phase voltage is between 80 V and 155 V or 160 V and 310 V and the load power factor is 1, and the response is FAST. At the output terminal block.

\*4 5 Hz to 1 MHz components in DC mode.

\*5 With respect to changes in the operating temperature range. When the output phase voltage is 100 V or 200 V, with no load.

\*6 When the output phase voltage is between 80 V and 155 V or 160 V and 310 V and the load power factor is 1, and the response is FAST. At the output terminal block.

\*7 When the output voltage is 100 V or 200 V, the load power factor is 1, and the output current changes from 0 A to the rated value and from the rated value to 0 A.

\*8 At 10 % to 90 % of the output voltage.

## Measurement

Model	Single-phase output			Single-phase/three-phase switchable model						
	PCR 1000WE	PCR 2000WE	PCR 3000WE2	PCR 6000WE2	PCR 12000WE2	PCR 18000WE2	PCR 24000WE2	PCR 30000WE2	PCR 36000WE2	
				PCR 6000WE2R	PCR 12000WE2R	PCR 18000WE2R	PCR 24000WE2R	PCR 30000WE2R	PCR 36000WE2R	
Voltage Rms value	Resolution	0.1 V								
	Accuracy *1	DC, 40 Hz to 999.9 Hz : $\pm 0.3$ % of reading +1 V) 1 kHz to 5 kHz : $\pm 0.5$ % of reading +1 V)								
Current Rms value	Resolution	0.01 A			0.1 A					
	Accuracy *1 *2	45 Hz to 65 Hz : $\pm 0.3$ % of reading +0.3 % of f.s) DC, 40 Hz to 999.9 Hz : $\pm 0.6$ % of reading +0.6 % of f.s) 1 kHz to 5 kHz : $\pm 1.2$ % of reading +1.2 % of f.s)								
Current peak value	Resolution	0.01 A			0.1 A			1 A		
	Accuracy *1 *3	4 % of f.s								
Active power	Resolution	1 W			10 W					
	Accuracy *1 *2 *4	45 Hz to 65 Hz : $\pm 0.3$ % of reading +0.3 % of f.s)								
Apparent power	Resolution	1 VA			10 VA					
Power factor	Resolution	0.01								
Phase difference	Resolution	0.1°								
Harmonic measurement	Frequency range (fundamental wave)	10 Hz to 1 kHz								
	Upper limit of harmonic analysis	5th to 50th								
	FFT data length	4096								
	Measurement items	Rms voltage and current, phase angle, THD								
Recommended calibration period	1 year									

\*1 At ambient temperature of 23 °C  $\pm 5$  °C.

\*2 At 10 % to 100 % of maximum rated current, sine wave.

\*3 Pulse height of sine wave

\*4 At a power factor of 1.

# Specifications

## General

Model		Single-phase output			Single-phase/three-phase switchable model					
		PCR 1000WE	PCR 2000WE	PCR 3000WE2	PCR 6000WE2	PCR 12000WE2	PCR 18000WE2	PCR 24000WE2	PCR 30000WE2	PCR 36000WE2
					PCR 6000WE2R	PCR 12000WE2R	PCR 18000WE2R	PCR 24000WE2R	PCR 30000WE2R	PCR 36000WE2R
Insulation resistance	Between input and chassis, output and chassis, input and output	500 Vdc, 10 MΩ or more								
Withstand voltage	Between input and chassis, output and chassis,	1500 Vac / 2150 Vdc, 1 minute								
	input and output	1500 Vac / 2150 Vdc, 1 minute								
Electromagnetic compatibility (EMC) *1 *2		Complies with the requirements of the following directive and standards. EMC Directive 2014/30/EU EN 61326-1 (Class A*3), EN 55011 (Class A*3, Group 1*4), EN 61000-3-2, EN 61000-3-3 Applicable under the following conditions The maximum length of all cabling and wiring connected to the product must be less than 3 m.								
Safety *1		Complies with the requirements of the following directive and standards. Low Voltage Directive 2014/35/EU*2 EN 61010-1 (Class I*5, Pollution Degree2*6)								
Environmental conditions	Operating environment	Indoor use, overvoltage category II								
	Operating temperature range	0 °C to +50 °C (32 °F to +122 °F)								
	Storage temperature range	-10 °C to +60 °C (14 °F to +140 °F)								
	Operating humidity range	20 %rh to 80 %rh (no condensation)								
	Storage humidity range	90 %rh and less (no condensation)								
Altitude		Up to 2000 m								
Dimensions		See page 11								
Weight		16 kg (35.3 lb)	20 kg (44.1 lb)	23 kg (50.7 lb)	43 kg(94.8 lb) 42 kg(92.6 lb)	65 kg(143.3 lb) 66 kg(145.5 lb)	120 kg (264.6 lb)	130 kg (286.6 lb)	160 kg (352.7 lb)	170 kg(374.8 lb) 180 kg(396.8 lb)
Input terminal		M6			M5		200 V input model : M8 400 V input model : M5			
Output terminal		M6			M5		M6		M8	
Accessories		Cable tie (4 pcs.), External control(DIGITAL I/O) connector (1 pc.), Heavy object warning label (1 pc.)*Excludes PCR1000WE, Read This First!(1 copy), Quick Reference(1 sheet), CD-ROM (1 disc), Safety Information (1 copy)								

\*1 Does not apply to specially ordered or modified products.

\*2 Only on models that have the CE marking on the panel.

\*3 This is a Class A equipment. This product is intended for use in an industrial environment. This product may cause interference if used in residential areas. Such use must be avoided unless the user takes special measures to reduce electromagnetic emissions to prevent interference to the reception of radio and television broadcasts.

\*4 This is a Group 1 equipment. This product does not generate and/or use intentionally radio-frequency energy, in the form of electromagnetic radiation, inductive and/or capacitive coupling, for the treatment of material or inspection/analysis purpose.

\*5 This is a Class I equipment. Be sure to ground this product's protective conductor terminal. The safety of this product is only guaranteed when the product is properly grounded.

\*6 Pollution is addition of foreign matter (solid, liquid or gaseous) that may produce a reduction of dielectric strength or surface resistivity. Pollution Degree 2 assumes that only non-conductive pollution will occur except for an occasional temporary conductivity caused by condensation.

## Output Impedance Setting

Model			Single-phase output			Single-phase/three-phase switchable model					
			PCR 1000WE	PCR 2000WE	PCR 3000WE2	PCR 6000WE2	PCR 12000WE2	PCR 18000WE2	PCR 24000WE2	PCR 30000WE2	PCR 36000WE2
						PCR 6000WE2R	PCR 12000WE2R	PCR 18000WE2R	PCR 24000WE2R	PCR 30000WE2R	PCR 36000WE2R
L range	Resistance component	1P	0 Ω to 2000 mΩ	0 Ω to 1000 mΩ	0 Ω to 667 mΩ	0 Ω to 333 mΩ	0 Ω to 167 mΩ	0 Ω to 111 mΩ	0 Ω to 83 mΩ	0 Ω to 67 mΩ	0 Ω to 56 mΩ
		1P3W 3P	—	—	0 Ω to 2000 mΩ	0 Ω to 1000 mΩ	0 Ω to 500 mΩ	0 Ω to 333 mΩ	0 Ω to 250 mΩ	0 Ω to 200 mΩ	0 Ω to 167 mΩ
	Reactance component	1P	80 μH to 2000 μH	40 μH to 1000 μH	27 μH to 667 μH	13 μH to 333 μH	7 μH to 167 μH	4 μH to 111 μH	3 μH to 83 μH	3 μH to 67 μH	2 μH to 56 μH
		1P3W 3P	—	—	80 μH to 2000 μH	40 μH to 1000 μH	20 μH to 500 μH	13 μH to 333 μH	10 μH to 250 μH	8 μH to 200 μH	7 μH to 167 μH
H range	Resistance component	1P	0 Ω to 8000 mΩ	0 Ω to 4000 mΩ	0 Ω to 2667 mΩ	0 Ω to 1333 mΩ	0 Ω to 667 mΩ	0 Ω to 444 mΩ	0 Ω to 333 mΩ	0 Ω to 267 mΩ	0 Ω to 222 mΩ
		1P3W 3P	—	—	0 Ω to 8000 mΩ	0 Ω to 4000 mΩ	0 Ω to 2000 mΩ	0 Ω to 1333 mΩ	0 Ω to 1000 mΩ	0 Ω to 800 mΩ	0 Ω to 667 mΩ
	Reactance component	1P	320 μH to 8000 μH	160 μH to 4000 μH	107 μH to 2667 μH	53 μH to 1333 μH	27 μH to 667 μH	18 μH to 444 μH	13 μH to 333 μH	11 μH to 267 μH	9 μH to 222 μH
		1P3W 3P	—	—	320 μH to 8000 μH	160 μH to 4000 μH	80 μH to 2000 μH	53 μH to 1333 μH	40 μH to 1000 μH	32 μH to 800 μH	27 μH to 667 μH



## Limit Values and Protection Functions (Common Specification)

		Setting range	Setting resolution	
Voltage protection	AC voltage upper limit AC voltage lower limit	0.0 V to 315.0 V	0.1 V	
	DC voltage upper limit DC voltage lower limit	-445.5 V to 445.5 V	0.1 V	
	Output overvoltage protection(OVP)	Rms value	14.0 V to 489.5 V	0.1 V
		Positive peak value Negative peak value	14.0 V to 489.5 V -489.5 V to -14.0 V	0.1 V
	Power module overvoltage protection	Fixed	—	
	Output undervoltage protection (UVP)	0.0 V to 489.5 V	0.1 V	
Frequency protection	Frequency upper limit Frequency lower limit	1 Hz to 5000 Hz 500 Hz LMT model: 1 Hz to 500 Hz (Three-phase output)	0.01 Hz (1.00 Hz to 100.0 Hz) 0.1 Hz (100.0 Hz to 1000 Hz), 1 Hz (1000 Hz to 5000 Hz)	
	Current protection	Current limit *1	Maximum output current × 0.1 to maximum output current × 1.1	0.01 A (0.35 A to 100.0 A), 0.1 A (100.0 A to 1000 A)
Positive peak current limit Negative peak current limit *2		Maximum output current × 0.1 to maximum output current × 4.2		
Overheat protection	Power module overheat protection	Fixed	—	
	Fan error	Fixed	—	
Overload protection		Rated current or current limit	Current limit resolution	
Independent operation detection		Fixed	—	
Sensing error detection		±(10 % +10 V) with respect to the output terminal voltage	—	

\*1 The current that can actually be supplied is 1.1 times the rated current or the current limit, whichever is less.

\*2 The current that can actually be supplied is the maximum peak current or the current limit, whichever is less.

## Communication Interface (Common Specification)

USB	Complies with the USB 2.0 specifications; data rate: 480 Mbps (high speed), socket B type, self-powered, Complies with the USBTMC-USB488 device class specifications.
LAN	IEEE802.3, 100Base-TX Ethernet LXI Rev.1.5 2016 (Extended Functions: VXI-11, HiSLIP, IPv6), data rate: 100 Mbps (auto negotiation, Full Speed) AUTO MDIX function IPv4, RJ45 connector, category 5, straight cable Complies with SCPI Specification 1999.0
RS232C	Complies with the EIA232D specifications, asynchronous full duplex, D-SUB 9-pin connector (male), crossover cable (null modem), 9600bps/19200bps/38400bps/57600bps/115200bps
GPIB (option)	Complies with IEEE Std 488.1-1987 SH1, AH1, T8, L4, SR0, RL0, PP0, DC0, DT0, C0, E1 24-pin connector (receptacle)

## Options



GPIB interface board  
**IB07-PCR-WE**



Parallel operation cable (1 m)  
**PC01-PCR-WE**



Power-sync cable(1 m)  
**LC01-PCR-LE**

### Input Power Cable

Appropriate model	Input	Model	Cable	Length	Nominal cross sectional area	Input terminal
PCR1000WE/2000WE	1P2W input	<b>AC5.5-1P3M-M6C-3S</b>	Single core, 3 pcs.	3 m	5.5 mm <sup>2</sup>	M6
PCR3000WE2	1P2W input	<b>AC14-1P3M-M6C-3S</b>	Single core, 3 pcs.	3 m	14 mm <sup>2</sup>	M6
PCR6000WE2R	3P3W input	<b>AC5.5-1P3M-M5C-4S</b>	Single core, 4 pcs.	3 m	5.5 mm <sup>2</sup>	M5
PCR6000WE2	3P4W input	<b>AC5.5-1P3M-M5C-5S</b>	Single core, 5 pcs.	3 m	5.5 mm <sup>2</sup>	M5
PCR12000WE2R	3P3W input	<b>AC14-1P3M-M5C-4S</b>	Single core, 4 pcs.	3 m	14 mm <sup>2</sup>	M5
PCR12000WE2	3P4W input	<b>AC5.5-1P3M-M5C-5S</b>	Single core, 5 pcs.	3 m	5.5 mm <sup>2</sup>	M5
PCR18000WE2R	3P3W input	<b>AC22-1P3M-M8C-4S</b>	Single core, 4 pcs.	3 m	22 mm <sup>2</sup>	M8
PCR18000WE2	3P4W input	<b>AC8-1P3M-M5C-5S</b>	Single core, 5 pcs.	3 m	8 mm <sup>2</sup>	M5
PCR24000WE2R	3P3W input	<b>AC38-1P3M-M8C-4S</b>	Single core, 4 pcs.	3 m	38 mm <sup>2</sup>	M8
PCR24000WE2	3P4W input	<b>AC14-1P3M-M5C-5S</b>	Single core, 5 pcs.	3 m	14 mm <sup>2</sup>	M5
PCR30000WE2R	3P3W input	<b>AC60-1P3M-M8C-4S</b>	Single core, 4 pcs.	3 m	60 mm <sup>2</sup>	M8
PCR30000WE2	3P4W input	<b>AC22-1P3M-M5C-5S</b>	Single core, 5 pcs.	3 m	22 mm <sup>2</sup>	M5
PCR36000WE2R	3P3W input	<b>AC60-1P3M-M8C-4S</b>	Single core, 4 pcs.	3 m	60 mm <sup>2</sup>	M8
PCR36000WE2	3P4W input	<b>AC22-1P3M-M5C-5S</b>	Single core, 5 pcs.	3 m	22 mm <sup>2</sup>	M5

### Rack Mount Brackets

Appropriate model	Bracket model	Remarks
PCR1000WE/2000WE/3000WE2	<b>KRB3-TOS</b>	EIA inch rack
	<b>KRB150-TOS</b>	JIS millimeter rack
PCR6000WE2(R)	<b>KRB6</b>	EIA inch rack
	<b>KRB300</b>	JIS millimeter rack
PCR12000WE2(R)	<b>KRB9</b>	EIA inch rack
	<b>KRB400-PCR-LE</b>	JIS millimeter rack

Base hold angles  
**OP03-KRC**



## Sequence Creation Software "Wavy" **SD032-PCR-WE(Wavy for PCR-WE)** Coming soon

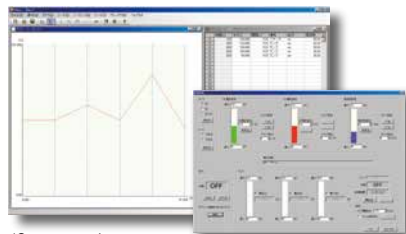

\*Screen sample

The software that further enhances the waveform generation and sequence functions of the PCR-WE/WE2 series.

Easy sequence control without programming knowledge!

Wavy is an application software that supports sequence creation and the operation for Kikusui power supplies and electronic loads. Wavy allows you to create and edit sequences visually with a mouse without programming knowledge. Real-time graph monitor function is equipped enables monitoring and logging values of voltage and current, and, it is possible to operate the power supply with the feeling of remote control by Direct control function.

**KIKUSUI** AC POWER SUPPLY  
PCR6000WE2

AC0-155V/0-310V  
DC0-219V/0-428V  
DC·1.5KHz 6kVAMAX

OUTPUT



SLEEP

ESC

OUTPUT  
ON  
3P  
U  
V  
W

F1

F2

**6U**

approx. **262 mm**  
(10.32 inch)

**6kVA**

**3 times**  
**the power**

\*of previous PCR-W series

**Actual  
size**

POWER



Dimensions (Unit:mm(inches))

■ PCR1000WE/ PCR2000WE/ PCR3000WE2

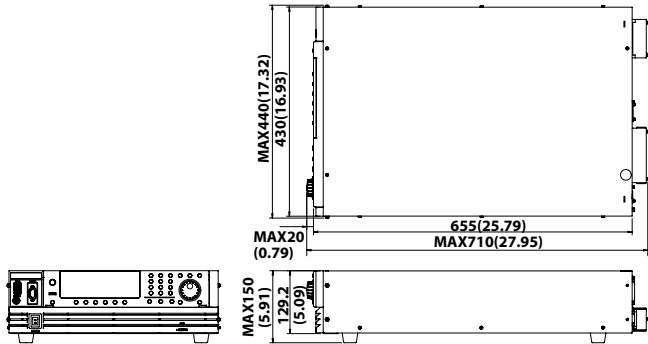

■ PCR1800WE2/ PCR1800WE2R  
PCR2400WE2/PCR2400WE2R

- This figure shows 200 V model.
- The 400 V model includes a terminal block cover.

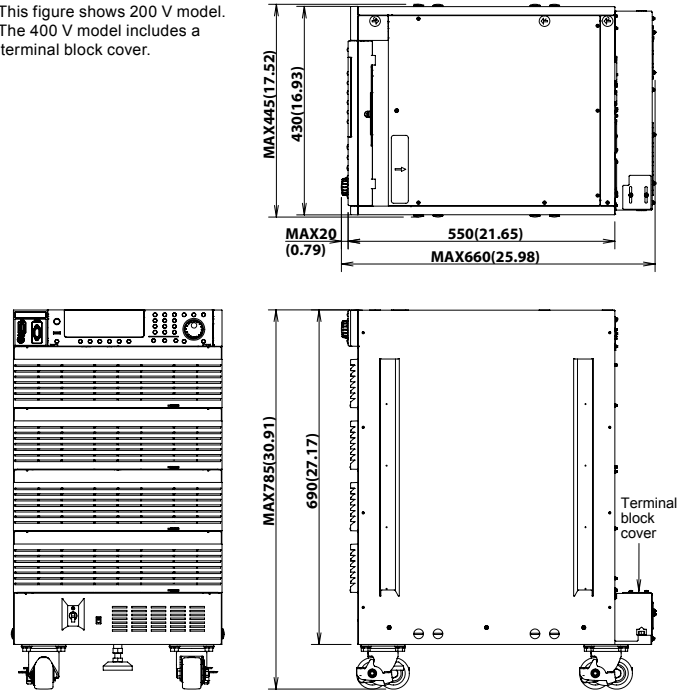

■ PCR6000WE2  
PCR6000WE2R

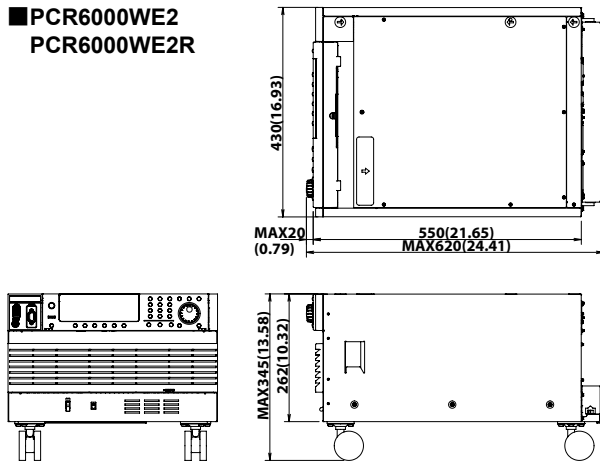

■ PCR3000WE2/ PCR3000WE2R  
PCR3600WE2/PCR3600WE2R

- This figure shows 200 V model.
- The 400 V model includes a terminal block cover.

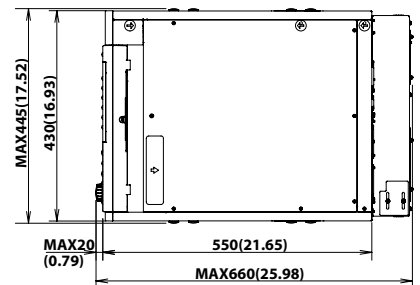

■ PCR12000WE2  
PCR12000WE2R

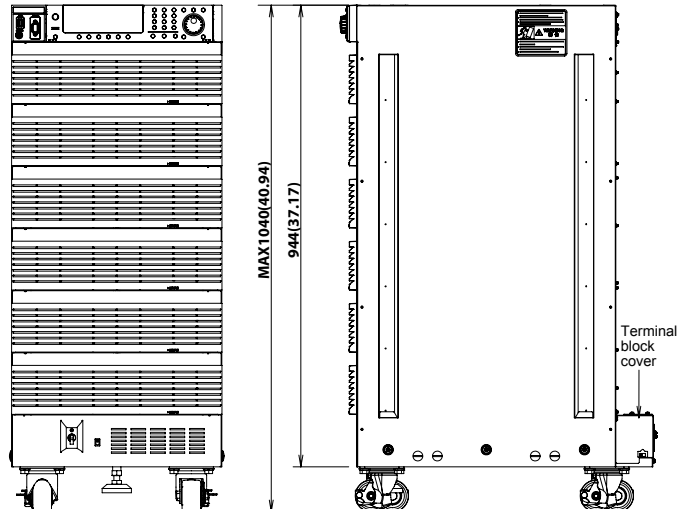
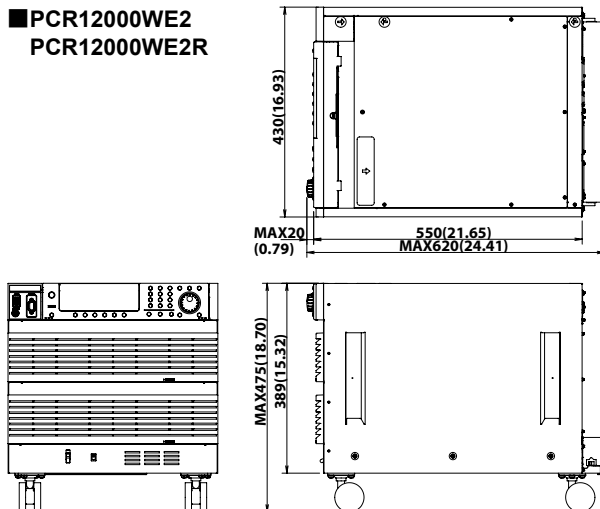

## Ordering Information

### ■ Ultra-Compact AC/DC Programmable Power Supply

Model	Remarks
<b>PCR1000WE</b>	Single-phase, 1 kVA
<b>PCR2000WE</b>	Single-phase, 2 kVA
<b>PCR3000WE2</b>	Single-phase/Three-phase 3 kVA, Single-phase three-wire 2 kVA
<b>PCR6000WE2R</b>	Single-phase/Three-phase 6 kVA, Single-phase three-wire 4 kVA
<b>PCR6000WE2</b>	Single-phase/Three-phase 6 kVA, Single-phase three-wire 4 kVA
<b>PCR12000WE2R</b>	Single-phase/Three-phase 12 kVA, Single-phase three-wire 8 kVA
<b>PCR12000WE2</b>	Single-phase/Three-phase 12 kVA, Single-phase three-wire 8 kVA
<b>PCR18000WE2R</b>	Single-phase/Three-phase 18 kVA, Single-phase three-wire 12 kVA
<b>PCR18000WE2</b>	Single-phase/Three-phase 18 kVA, Single-phase three-wire 12 kVA

Model	Remarks
<b>PCR24000WE2R</b>	Single-phase/Three-phase 24 kVA, Single-phase three-wire 16 kVA
<b>PCR24000WE2</b>	Single-phase/Three-phase 24 kVA, Single-phase three-wire 16 kVA
<b>PCR30000WE2R</b>	Single-phase/Three-phase 30 kVA, Single-phase three-wire 20 kVA
<b>PCR30000WE2</b>	Single-phase/Three-phase 30 kVA, Single-phase three-wire 20 kVA
<b>PCR36000WE2R</b>	Single-phase/Three-phase 36 kVA, Single-phase three-wire 24 kVA
<b>PCR36000WE2</b>	Single-phase/Three-phase 36 kVA, Single-phase three-wire 24 kVA

★ 500 Hz Limit Model is available. The PCR-WE2 Series offers a limited frequency type with a maximum output frequency of 500 Hz.

### ■ Input Power Cable

Appropriate Model		Model	Cable	Length	Nominal cross sectional area	Input terminal
PCR1000WE/2000WE	Single-phase two-wire input	<b>AC5.5-1P3M-M6C-3S</b>	Three single-core cables	3 m	5.5 mm <sup>2</sup>	M6
PCR3000WE2	Single-phase two-wire input	<b>AC14-1P3M-M6C-3S</b>	Three single-core cables	3 m	14 mm <sup>2</sup>	M6
PCR6000WE2R	Three-phase three-wire input	<b>AC5.5-1P3M-M5C-4S</b>	Four single-core cables	3 m	5.5 mm <sup>2</sup>	M5
PCR6000WE2	Three-phase four-wire input	<b>AC5.5-1P3M-M5C-5S</b>	Five single-core cables	3 m	5.5 mm <sup>2</sup>	M5
PCR12000WE2R	Three-phase three-wire input	<b>AC14-1P3M-M5C-4S</b>	Four single-core cables	3 m	14 mm <sup>2</sup>	M5
PCR12000WE2	Three-phase four-wire input	<b>AC5.5-1P3M-M5C-5S</b>	Five single-core cables	3 m	5.5 mm <sup>2</sup>	M5
PCR18000WE2R	Three-phase three-wire input	<b>AC22-1P3M-M8C-4S</b>	Four single-core cables	3 m	22 mm <sup>2</sup>	M8
PCR18000WE2	Three-phase four-wire input	<b>AC8-1P3M-M5C-5S</b>	Five single-core cables	3 m	8 mm <sup>2</sup>	M5
PCR24000WE2R	Three-phase three-wire input	<b>AC38-1P3M-M8C-4S</b>	Four single-core cables	3 m	38 mm <sup>2</sup>	M8
PCR24000WE2	Three-phase four-wire input	<b>AC14-1P3M-M5C-5S</b>	Five single-core cables	3 m	14 mm <sup>2</sup>	M5
PCR30000WE2R	Three-phase three-wire input	<b>AC60-1P3M-M8C-4S</b>	Four single-core cables	3 m	60 mm <sup>2</sup>	M8
PCR30000WE2	Three-phase four-wire input	<b>AC22-1P3M-M5C-5S</b>	Five single-core cables	3 m	22 mm <sup>2</sup>	M5
PCR36000WE2R	Three-phase three-wire input	<b>AC60-1P3M-M8C-4S</b>	Four single-core cables	3 m	60 mm <sup>2</sup>	M8
PCR36000WE2	Three-phase four-wire input	<b>AC22-1P3M-M5C-5S</b>	Five single-core cables	3 m	22 mm <sup>2</sup>	M5

### ■ Parallel Operation Cable PC01-PCR-WE (1 m in length)

### ■ Power-sync Cable LC01-PCR-LE (1 m in length)

### ■ GPIB Interface Boards

#### IB07-PCR-WE

This board enables you to control the PCR-WE/WE2 Series over GPIB.

\*Factory option

### ■ Base Hold Angles

#### OP03-KRC

### ■ External Control Connector

#### OP01-PCR-WE (for DIGITAL I/O)

#### OP02-PCR-WE (for ANALOG OUT)

### ■ Rack Mount Brackets

for PCR1000WE/2000WE/3000WE2

#### KRB3-TOS (EIA inch rack)

#### KRB150-TOS (JIS millimeter rack)

for PCR6000WE2(R)

#### KRB6 (EIA inch rack)

#### KRB300 (JIS millimeter rack)

for PCR12000WE2(R)

#### KRB9 (EIA inch rack)

#### KRB400-PCR-LE (JIS millimeter rack)



## KIKUSUI ELECTRONICS CORPORATION

Southwood 4F,6-1 Chigasaki-chuo,Tsuzuki-ku,Yokohama,224-0032,Japan

Phone: (+81)45-482-6353, Facsimile: (+81)45-482-6261, www.kikusui.co.jp

**KIKUSUI AMERICA, INC.** 1-310-214-0000 | [www.kikusuiamerica.com](http://www.kikusuiamerica.com)



3625 Del Amo Blvd, Suite 160, Torrance, CA 90503  
Phone : 310-214-0000 Facsimile : 310-214-0014

**KIKUSUI TRADING (SHANGHAI) Co., Ltd.** | [www.kikusui.cn](http://www.kikusui.cn)



Room 305, Shenggao Building, No.137, Xianxia Road, Shanghai City, China  
Phone : 021-5887-9067 Facsimile : 021-5887-9069

For our local sales distributors and representatives, please refer to "sales network" of our website.

### ●Distributor:

■ All products contained in this catalogue are equipment and devices that are premised on use under the supervision of qualified personnel, and are not designed or produced for home-use or use by general consumers. ■ Specifications, design and so forth are subject to change without prior notice to improve the quality. ■ Product names and prices are subject to change and production may be discontinued when necessary. ■ Product names, company names and brand names contained in this catalogue represent the respective registered trade name or trade mark. ■ Colors, textures and so forth of photographs shown in this catalogue may differ from actual products due to a limited fidelity in printing. ■ Although every effort has been made to provide the information as accurate as possible for this catalogue, certain details have unavoidably been omitted due to limitations in space. ■ If you find any misprints or errors in this catalogue, it would be appreciated if you would inform us. ■ Please contact our distributors to confirm specifications, price, accessories or anything that may be unclear when placing an order or concluding a purchasing agreement.