



PCR - MA SERIES



Compact AC Power Supply PCR-MA Series

Compact, switching AC power supply (PWM inverter method)
Output Capacity: 500 VA, 1,000 VA, 2,000 VA & 4,000 VA (single phase)
AC output: 0 V to 155 V/0 V to 310 V at 40 Hz to 500 Hz
DC output: ± 0 V to 219 V/ ± 0 V to 438 V
Peak currents three times the rated current supported (RMS value)
LAN and USB standard digital interface (GPIB factory option)
Sensing function

AC Output Made Easy

Wide-range, programable output voltage up to 310 Vrms with a user friendly interface designed for maximum practicality and convenience.

The PCR-MA AC power supply series is a PWM inverter type (switching) power supply that builds on the success of our conventional model, the PCR-M. Maximum output voltage has been increased to 310 Vrms AC while maintaining a compact, portable design. The digital interface now includes LAN (LXI) and USB as standard, with GPIB as a factory option for easy integration into any test system. The LXI compliant LAN interface allows the operator to easily monitor and control the instrument via virtual interface wherever they are. Various features including a remote sensing function have been introduced to ensure precise voltage and current measurements. Other features including DC mode, memory functions, and various protections make the PCR-MA the most accessible AC power supply on the market.

**Compact/
Light weight
6.5 kg!
(PCR500MA)**

Selectable output modes

In addition to "AC mode" and "DC mode", an AC+DC external analog interface board option (EX08-PCR-MA) allows for output control via "EXT-AC mode" and "EXT-DC mode" through external analog signals.

Output Mode	Description
AC mode	AC output
DC mode	DC output
AC+DC mode	Superimpose DC voltage on the AC voltage and output *1
EXT-AC mode	Output sine waves using external DC signals *2
EXT-DC mode	Simply amplify and output the waveform applied externally *2

*1 Only communication commands

*2 Only when the analog interface board (EX08-PCR-MA) is installed.

[AC mode]

The PCR-MA output voltage range can be set in two ranges (0-155 V, 0-310 V) with a programmable frequency up to 500 Hz in order to comply with nominal, single phase voltage anywhere in the world. This is especially useful for power supply systems found in aircraft, boats, and actuators.

Settable Voltage Range		Frequency Setting Range
155 V range	310 V range	
0.0 V to 157.5 V	0.0 V to 315.0 V	40 Hz to 500 Hz

[DC mode]

The output voltage can be varied from ± 0 V to 219 V or ± 0 V to 438 V

Output Voltage Setting	
155 V range	310 V range
-222.5 V to +222.5 V	-445 V to +445 V

[AC+DC mode]

The output voltage can be varied from ± 0 V to 219 V or ± 0 V to 438 V

Output Voltage Setting	
155 V range	310 V range
-222.5 V to +222.5 V	-445 V to +445 V

AC + DC mode is a function used to superimpose DC voltage on AC voltage or AC voltage on DC voltage. It can only be used with the communication commands.

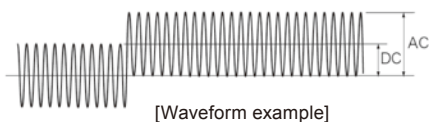

Outlet covers provided for optimal safety

Protection features

The following protection features are available:

- Protection against non-rated input voltage
- Protection against overheating (OHP)
- Protection against overloading: Current limit (OCP)/monitoring for exceeded power (OPP)/Monitoring for exceeded peak current (OCPP)
- Detection of voltage abnormalities: Increased voltage (OVP)/decreased voltage (LVP)
- Abnormal sensing cable connection detection (SF)

Communication interface

LAN and USB digital interface included (GPIB optional)

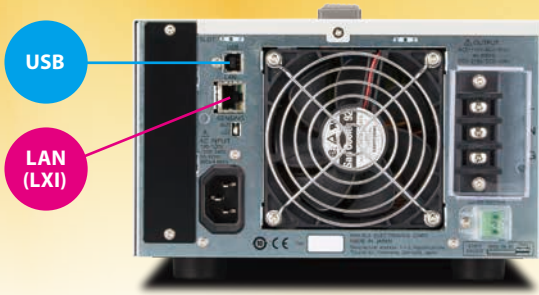

Versatile measurement capability

THE PCR-MA is capable of measuring the voltage, current and power of AC and DC output. It can also display the true RMS and average (DC) values of the output voltage as well as the true RMS, peak, and average (DC) values for the output current. When used with digital interface, the PCR-MA can also measure apparent power (VA), reactive power (VAR), power factor (PF), and peak hold current.

Sensing function (ON/OFF)

The new remote sensing feature compensates for voltage drops along long load wires to ensure maximum accuracy.

Output-on phase angle

The output-on phase angle can be set in AC mode. The output-off phase angle is turned off at the zero-crossing phase.

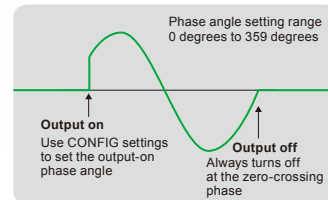

Memory function

The PCR-MA can store up to three sets of output voltage, frequency, and limit value setting via front panel. Additionally, when using communication commands, the internal memory can store up to 11 settings.

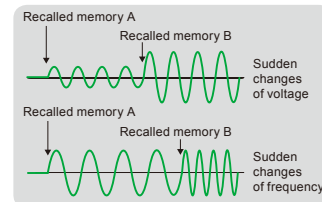

Maximum peak current

Maximum peak current of up to three times the rated maximum current (rms value) can be output to a capacitor-input rectifier load. Maximum peak current = rated maximum current (rms) × 3.

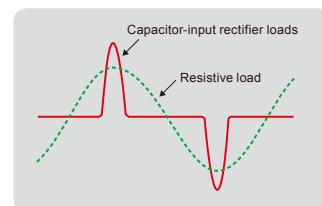

Actual size

COMPACT AC POWER SUPPLY **PCR-MA Series** 4 Models

Model	Voltage	Max current	Power capacity
PCR500MA	0 V to 155 V 0 V to 310 V (2 range)	5 A / 2.5 A	500 VA
PCR1000MA		10 A / 5 A	1 kVA
PCR2000MA		20 A / 10 A	2 kVA
PCR4000MA		40 A / 20 A	4 kVA



Easy access with the built-in web server

Easy remote control and monitoring from your Web browser!

Use a browser from a PC, smartphone, or tablet to access the web server built into the PCR-MA series for convenient control and monitoring.

[Recommended browser]

- Requires for the Microsoft Edge 10
- Requires for the Internet Explorer version 9.0 or later
- Requires for the Firefox 8.0 or later
- Requires for the safari / mobile Safari 5.1 or later
- Requires for the Chrome 15.0 or later
- Requires for the Opera 11.0 or later

*Connecting with a smartphone, tablet, etc. requires a Wi-Fi environment (wireless LAN router etc.).



Application examples

AC power supply for standby power measurement.

The PCR-MA can be used alongside the KPM1000 Digital Power Meter to conduct measurements compliant with IEC62301, 1st edition. You can also measure the "standby and off mode power" of household and office electronic equipment as required by standards such as Erp Directive Lot 6.

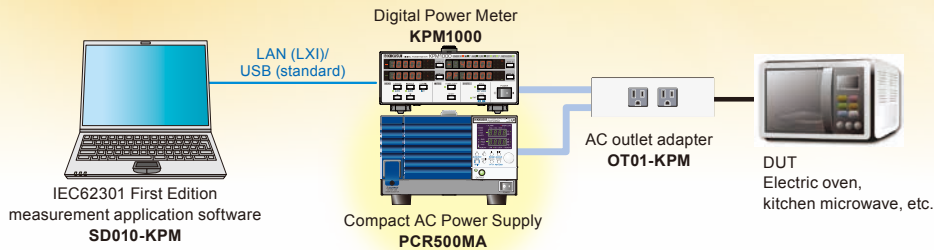

AC power supply for harmonic current measurement.

When used with the KHA1000 Harmonic/Flicker Analyzer, the PCR-MA can be used to conduct harmonic measurements of power supplies compliant with IEC61000-3-2.

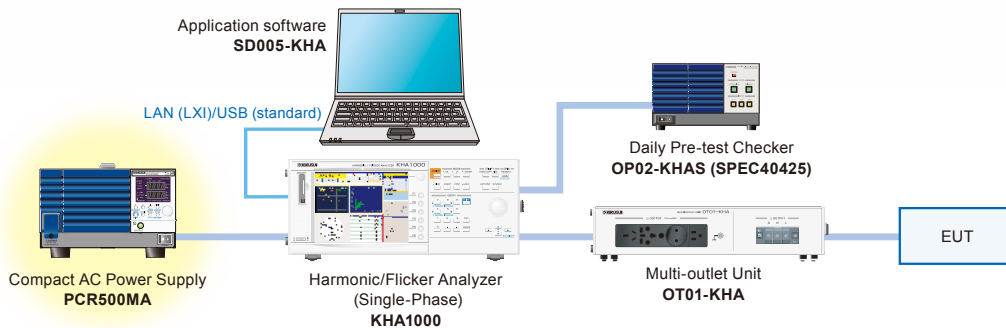

AC power supply for capacitor testing.

Combined with the Contact Checker, the PCR-MA can allow you to detect current flowing through the capacitor, and verify whether it has been connected or not.

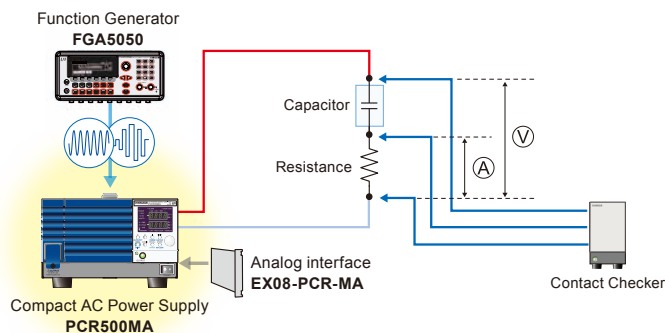

DC power supply for simple power supply variation tests.

When used alongside our PBZ40-10 Bipolar Power Supply and PLZ164WH electronic load, the PCR-MA can help conduct simplified power variation tests for high voltage DC components found in automotive equipment.

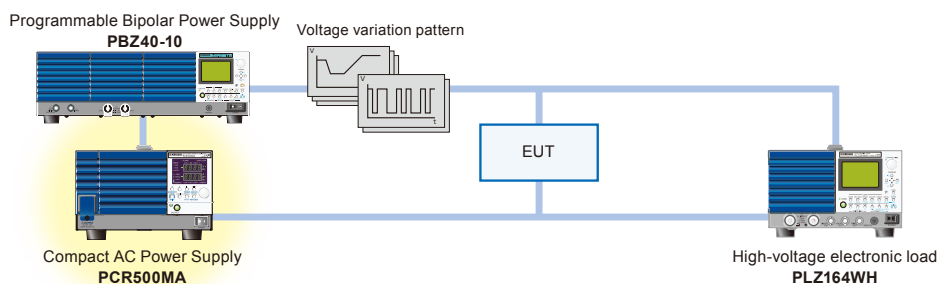

Specifications

TYP: These are typical values. These values do not guarantee the performance. Reading: Indicates a readout value. Set: Indicates a setting.

Model	PCR500MA	PCR1000MA	PCR2000MA	PCR4000MA	
Output rating AC mode					
Rated voltage range (output 155 V/310 V range)	0 V to 155 V/0 V to 310 V				
Settable voltage range (output 155 V/310 V range)	0 V to 157.5 V/0 V to 315.0 V				
Voltage setting resolution	0.1 V				
Voltage setting accuracy *1	±(1 % of set + 0.6 V/1.2 V)				
Number of output phases	Single phase				
Maximum current *2	5 A/2.5 A	10 A/5 A	20 A/10 A	40 A/20 A	
Maximum peak current *3	15 A/7.5 A	30 A/15 A	60 A/30 A	120 A/60 A	
Load power factor	0 to 1 (leading or lagging)				
Power capacity	500 VA	1 kVA	2 kVA	4 kVA	
Frequency setting range	40.0 Hz to 500.0 Hz				
Frequency setting resolution	0.1 Hz				
Frequency setting accuracy	≤ ±2 × 10 ⁻⁴				
Output rating DC mode					
Rated voltage range (output 155 V/310 V range)	-219 V to +219 V/-438 V to +438 V				
Settable voltage range (output 155 V/310 V range)	-222.5 V to +222.5V/-445.0 V to +445.0 V				
Voltage setting resolution	0.1 V				
Voltage setting accuracy *4	±(1 % of set + 0.6 V/1.2 V)				
Maximum current (output 155 V/310 V range) *5	4 A/2 A	8 A/4 A	16 A/8 A	32 A/16 A	
Maximum instantaneous current (output 155 V/310 V range) *6	12 A/6 A	24 A/12 A	48 A/24 A	96 A/48 A	
Power capacity	400 W	800 W	1600 W	3200 W	
Output voltage stability					
Line regulation *7	≤ ±0.15 %				
Load variation (output 155 V/310 V range) *8	40 Hz to 100 Hz, DC : ≤ ±0.15V/±0.3V Other than above : ≤ ±0.5 V/±1 V				
Output frequency variation *9	≤ ±1 %				
Ripple noise *10	0.8 Vrms/1.6 Vrms (TYP)				
Ambient temperature variation *11	100 ppm/°C (TYP)				
Output voltage waveform distortion ratio *12	≤ 0.5 %				
Output voltage response speed *13	150 μs (TYP)				
Efficiency *14	≥ 70 %				
Indicators *15					
Voltmeter	Resolution	0.1 V			
	Accuracy (output 155 V/310 V range)	RMS, AVE *16	45 Hz to 65 Hz, DC : ±(0.5 % of reading +0.3 V/0.6 V) Other than above : ±(0.7 % of reading +0.9 V/1.8 V)		
Ammeter	Resolution	0.01 A		0 A to 99.99 A (RMS, AVE): 0.01 A 100 A to (RMS, AVE), IPK: 0.1A	
	Accuracy (output 155 V/310 V range)	RMS, AVE *17	45 Hz to 65 Hz, DC: ±(0.5 % of reading +0.02 A/0.01 A) Other than above: ±(0.7 % of reading +0.04 A/0.02 A)	45 Hz to 65 Hz, DC: ±(0.5 % of reading +0.04 A/0.02 A) Other than above: ±(0.7 % of reading +0.08 A/0.04 A)	45 Hz to 65 Hz, DC: ±(0.5 % of reading +0.08 A/0.04 A) Other than above: ±(0.7 % of reading +0.16 A/0.08 A)
Wattmeter	Resolution	0.1 W	0.1W (<1 000 W), 1 W (1000 Ws)		
	Accuracy *18	±(2 % of reading +0.5 W)	±(2 % of reading +1 W)	±(2 % of reading +2 W)	±(2 % of reading +4 W)
Input rating					
Nominal input rating	100 Vac to 120 Vac/200 Vac to 240 Vac, 50 Hz/60 Hz, single phase				
Voltage range	90Vac to 132Vac/180Vac to 264Vac (auto detection at power-on)				
Number of phases, frequency	Single phase, 47 Hz to 63 Hz				
Displays the apparent power.	Approx. 800 VA	Approx. 1600 VA	Approx. 3200 VA	Approx. 6400 VA	
Power factor *19	0.9 (standard value)				
Current	Input 90 V to 115 V	8 A/6.3 A or less	16 A/12.5 A or less	32 A/25 A or less	64 A/50 A or less
	Input 180 V to 230 V	4 A/3.2 A or less	8 A/6.3 A or less	16 A/12.5 A or less	32 A/25 A or less

*1. For an output voltage of 13.5 V to 155 V/27 V to 310 V, an output frequency of 45 Hz to 65 Hz, no load, and 23°C ± 5°C.
 *2. For an output voltage of 1 V to 100 V/2 V to 200 V. Limited by the power capacity when the output voltage is 100 V to 155 V/200 V to 310 V.
 *3. For the capacitor-input rectifying load. Limited by the maximum current.
 *4. For an output voltage of 19 V to 219 V/38 V to 438 V, no load, and 23°C ± 5°C.
 *5. For an output voltage of 1.4 V to 100 V/2.8 V to 200 V. Limited by the power capacity when the output voltage is 100 V to 219 V/200 V to 438 V.
 *6. Limited by the maximum current.
 *7. For changes in the rated range.
 *8. For an output voltage of 80 V to 155 V/160 V to 310 V, a load power factor of 1, output voltage variation between 0 A and maximum current, using the output terminal on the rear panel.
 *9. For an output voltage of 100 V/200 V and a load power factor of 1. Output voltage variation with 60 Hz as a reference.
 *10. For 5 Hz to 1 MHz components in DC mode using the output terminal on the rear panel.
 *11. For an output voltage of 100 V/200 V, an output current 0 A, within the operating temperature range.
 *12. For an output voltage of 50 V to 155 V/100 V to 310 V, a load power factor of 1, in AC mode.
 *13. For an output voltage of 100 V/200 V, a load power factor of 1, and an output current variation between 0 A and maximum current.
 *14. For AC mode, at an output voltage of 100 V/200 V, maximum current, a load power factor of 1, and an output frequency of 40 Hz to 500 Hz.

*15. RMS, average (AVE), and power (W) are derived using the following equations.
 RMS (true rms computation) = (Σ (square of the instantaneous voltage or instantaneous current)/the number of samples)
 AVE = (instantaneous voltage or instantaneous current)/the number of samples
 WAC = Σ (instantaneous voltage x instantaneous current)/the number of samples
 WDC = VAvg x Iavg
 •Sample period: 100 ms to 125 ms for AC output (an integer multiple of the output waveform period). 125 ms for DC output.
 •Update interval: Approx. 3 times/s, averaging over 2s when averaging is turned on.
 •Peak current value holds the maximum value of the absolute value of the peak current for 0.3s or approximately 5s.
 •The voltage display is set to RMS in AC mode and AVE in DC mode.
 *16. AC mode: For an output voltage of 13.5 V to 155 V/27 V to 310 V and 23°C ± 5°C. DC mode: For an output voltage of 19 V to 219 V/38 V to 438 V and 23°C ± 5°C.
 *17. For waveforms with a crest factor of 3 or less. At 5 % to 100 % of the maximum rated current, 23°C ± 5°C.
 *18. For an output voltage of 50 V or greater, an output current in the range of 10 % to 100 % of the maximum rated current, a load power factor of 1, an output frequency of 45 Hz to 65 Hz or DC, and 23°C ± 5°C.
 *19. For an output voltage of 100 V/200 V (155 V/310 V range), maximum current, and a load power factor of 1.

Specifications

TYP: These are typical values. These values do not guarantee the performance. Reading: Indicates a readout value.

Model		PCR500MA	PCR1000MA	PCR2000MA	PCR4000MA
Insulation resistance	Between input and case, between output and case, between input and output	500 Vdc, 30 MΩ or more			
Withstanding voltage	Between input and case, between output and case, between input and output	1.5 kVac for 1 minute			
Earth continuity		25 Aac/0.1 Ω or less			
Electromagnetic compatibility *1 *2		Complies with the requirements of the following directive and standards. EMC Directive 2014/30/EU EN 61326-1 (Class A), EN 55011 (Class A, Group 1), EN 61000-3-2, EN 61000-3-3 Applicable under the following conditions: Load cables are less than 30 m. Other cables connected to the product are all less than 3 m.			
Safety *1		Complies with the requirements of the following directive and standards. Low Voltage Directive 2014/35/EU EN 61010-1 (Class I, Pollution Degree 2)			
Circuit method		PWM inverter system			
Environment	Operating environment	Indoor use, overvoltage category II			
	Operating temperature and humidity range	0°C to 40°C, 20 % to 80 %rh (no condensation)			
	Storage temperature and humidity range	-10°C to 60°C, 0 % to 90 %rh (no condensation)			
	Altitude	Up to 2000 m			
Dimensions	214(8.43)W×124(4.88)H×350(13.78)D mm(inches)	429(16.89)W×128(5.04)H×350(13.78)D mm(inches)	429(16.89)W×128(5.04)H×450(17.72)D mm(inches)	429(16.89)W×262(10.31)H×520(20.47) Dmm (inches)	
Weight	Approx. 6.5 kg	Approx. 11 kg	Approx. 16 kg	Approx. 32 kg	
Input terminal block	(Inlet)	M4	M6	M6	
Output terminal block		M4		M6	
Accessories	Power cord	1 pc. with plug Length: Approx. 2.5 m	1 pc. without plug 3-core flexible cable Nominal cross-sectional area : 3.5 mm ² Length: Approx. 3 m	1 set with ferrite core without plug 1-core cable : 3pcs. Nominal cross-sectional area : 5.5 mm ² Length: Approx. 3 m	1 set without plug, 1-core cable : 3pcs. Nominal cross-sectional area : 14 mm ² Length: Approx. 3 m
	Core	1 pc.	1 pc.	1 pc.	1 pc.
	Cable tie	1 pc.	1 pc.	1 pc.	1 pc.
	CD-ROM *3	1 disc			
Packing List(1 pc.), Quick Reference(Japanese 1 sheet, English 1 sheet), Safety Information(1 copy)					

*1 Not applicable to custom order models.

*2 Only on models that have the CE marking on the panel.

*3 Included in the user's manual, and communication interface manual.

● Analog interface specifications (EX08-PCR-MA: optional)

Input terminal	Maximum allowable input voltage	±15 V	
	Type	BNC	
	Input impedance	10 kΩ ±5 % (unbalanced)	
	Isolation voltage	42 Vpk	
EXT-AC mode *1	Input voltage range	0 V to ±10 V (DC)	
	Voltage amplification rate (155 V/310 V range)	15.5 times or 31 times	
	Frequency setting range	40 Hz to 500 Hz	
EXT-DC mode	Input voltage range *2	ATT OFF	0 V to ±2.19 Vpeak (0 to 155 Vrms sine wave)
		ATT ON	0 V to ±10 V (DC)
	Input frequency range	ATT OFF	40 Hz to 500 Hz (sine wave) / 40 Hz to 100 Hz (square wave) /DC
	Frequency characteristics	ATT OFF	-0.3 dB at 500 Hz (typical value) with 55 Hz as a reference
	Voltage amplification rate (155 V/310 V range)	ATT OFF	100 times or 200 times
ATT ON		21.9 times or 43.8 times	
Output voltage distortion ratio *3		Main unit specifications + 0.5 % or less	

*1 ATT is always set to on.

*2 Measurable range for voltage, current and power is DC and from 40 Hz to 500 Hz. The frequency is set based on the input waveform cycle.

*3 In the EXT-AC mode, when direct current is input. In the EXT-DC mode, when a sine wave with 0.1 % or less distortion rate is input.

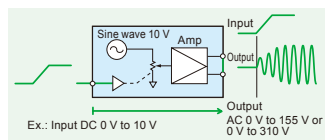

EXT-AC mode

The output AC voltage value can be varied according to the input DC signal.

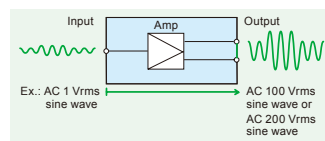

EXT-DC mode

Amplifies the waveforms that it receives and outputs the result.

● Specifications of the communication interface

LAN	Complies with IEEE 802.3 100base-TX/10Base-T Ethernet 1.5 LXI Device Specification 2016, RJ-45 connector
USB	Complies with the USB 2.0 specifications. Communication speed: 480 Mbps (High-speed) Complies with the USBTMC-USB488 device class specifications.
GPIB (IB22: optional)	Complies with IEEE STD. 488.1-1978 specifications. SH1, AH1, T6, L4, SR1, RL1, PP0, DC1, DT1, C0, E1
Common	Software protocol: IEEE 488.2 STD 1992 Command language: SCPI Specification 1999.0

Options

■ Interface boards *Only one interface board can be installed.



GPIB interface board
[IB22]



Analog interface board
[EX08-PCR-MA]

■ LAN-RS232C Converter Introduction *The following interface can be used.

LANTRONIX, Inc. xDirect WEB : <http://www.lantronix.jp/products/xdirect.html>

XDT2321002-01-S xDirect232 Ver.

RS232C (AC Adapter Included)/(LAN-RS232C Converter)

[Notes]

*Please refer to the LANTRONIX Corporation instruction manual for details on RS232C control using the LAN-RS232C converter.

*We can not guarantee compatibility with your computer, etc.

■ Rack-mount frames and brackets

For the PCR500MA

KRA3 (EIA inch rack), KRA150 (JIS millimeter rack)

KBP3-2 (Blank panel)

For the PCR1000MA and PCR2000MA

KRB3-TOS (EIA inch rack), KRB150-TOS (JIS millimeter rack)

For the PCR4000MA

KRB6 (EIA inch rack), KRB300 (JIS millimeter rack)

Rear Panel/External dimensions (Unit: mm (inches))

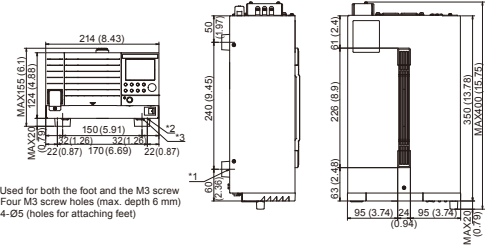

- *1: Used for both the foot and the M3 screw
- *2: Four M3 screw holes (max. depth 6 mm)
- *3: 4-Ø5 (holes for attaching feet)

PCR500MA 214(8.43)W×124(4.88)H×350(13.78)Dmm(inches)

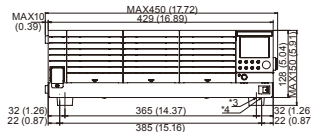

- *1: Used for both the foot and the M3 screw
- *2: Four M4 screw holes (max. depth 8 mm)
- *3: 4-Ø5 (holes for attaching feet)
- *4: Four M3 screw holes (max. depth 6 mm)

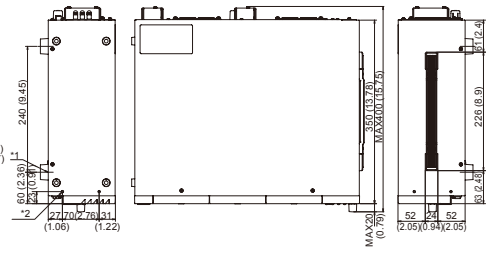

PCR1000MA 429(16.89)W×128(5.04)H×350(13.78)Dmm(inches)

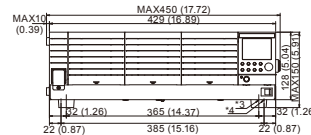

- *1: Used for both the foot and the M4 screw
- *2: Four M4 screw holes (max. depth 8 mm)
- *3: 4-Ø5 (holes for attaching feet)
- *4: Four M4 screw holes (max. depth 8 mm)

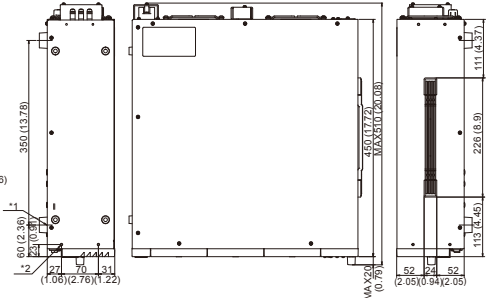

PCR2000MA 429(16.89)W×128(5.04)H×450(17.72)Dmm(inches)

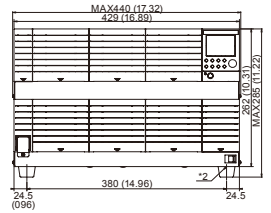

- *1: Eight M4 screw holes (max. depth 8 mm)
- *2: Four M4 screw holes (max. depth 8 mm)

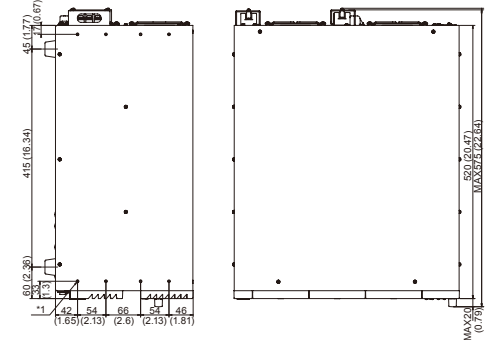

PCR4000MA 429(16.89)W×262(10.31)H×520(20.47)Dmm(inches)



KIKUSUI ELECTRONICS CORPORATION

Southwood 4F,6-1 Chigasaki-chuo,Tsuzuki-ku,Yokohama,224-0032,Japan
Phone: (+81)45-482-6353,Facsimile: (+81)45-482-6261,www.kikusui.co.jp

KIKUSUI AMERICA, INC. 1-310-214-0000 www.kikusuiamerica.com



3625 Del Amo Blvd, Suite 160, Torrance, CA 90503
Phone : 310-214-0000 Facsimile : 310-214-0014

KIKUSUI TRADING (SHANGHAI) Co., Ltd. www.kikusui.cn



Room 305,Shenggao Building , No.137,Xianxia Road, Shanghai City, China
Phone : 021-5887-9067 Facsimile : 021-5887-9069

For our local sales distributors and representatives, please refer to "sales network" of our website.

Printed in Japan

● Distributor:

■ All products contained in this catalogue are equipment and devices that are premised on use under the supervision of qualified personnel, and are not designed or produced for home-use or use by general consumers. ■ Specifications, design and so forth are subject to change without prior notice to improve the quality. ■ Product names and prices are subject to change and production may be discontinued when necessary. ■ Product names, company names and brand names contained in this catalogue represent the respective registered trade name or trade mark. ■ Colors, textures and so forth of photographs shown in this catalogue may differ from actual products due to a limited fidelity in printing. ■ Although every effort has been made to provide the information as accurate as possible for this catalogue, certain details have unavoidably been omitted due to limitations in space. ■ If you find any misprints or errors in this catalogue, it would be appreciated if you would inform us. ■ Please contact our distributors to confirm specifications, price, accessories or anything that may be unclear when placing an order or concluding a purchasing agreement.