

USERS MANUAL

ELECTRONIC LOAD PLZ-4W Series

PLZ 164W

PLZ 164WA

PLZ 334W

PLZ 664WA

PLZ1004W

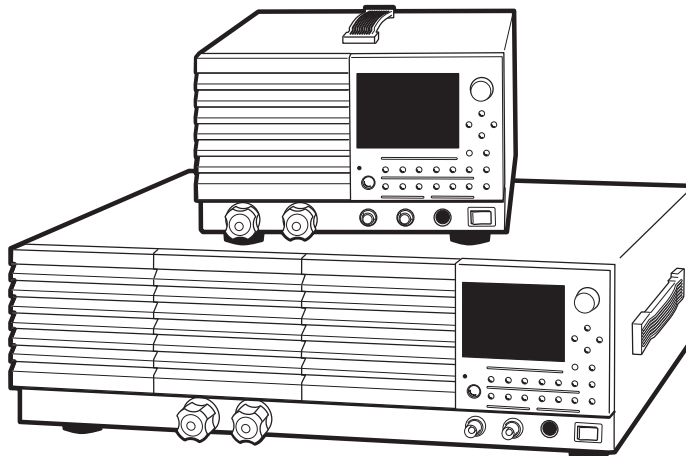

About the PLZ-4W series Manuals

Manual construction

Setup Guide

The setup guide is intended for first-time users of the PLZ-4W series. It gives an overview of the PLZ-4W series, connecting procedures, safety precautions, etc. Please read through and understand this guide before operating the product.

Quick Reference

The quick reference briefly explains the panel description and the basic operation of the PLZ-4W.

User's Manual (This manual, PDF)

User's manual is intended for first-time users of the PLZ-4W series. It gives an overview of the PLZ-4W series and describes various settings, measurement procedures, maintenance, safety precautions, etc.

Communication Interface Manual (HTML, partially PDF)

The Communication Interface Manual explains the settings and commands for remotely controlling the PLZ-4W series, using the communication interface and gives sample programs.

The interface manual is written for readers with sufficient basic knowledge of how to control instruments using a personal computer.

PDF and HTML files are included in the accompanying CD-ROM.

Adobe Reader is required to view the PDF files.

Microsoft Internet Explorer or Google Chrome are required to view the HTML files.

Please read through and understand the Operation Manual before operating the product. After reading, always keep the manuals nearby so that you may refer to it as needed. When moving the product to another location, be sure to bring the manuals as well.

If you find any incorrectly arranged or missing pages in the manual, they will be replaced. If the manual gets lost or soiled, a new copy can be provided for a fee. In either case, please contact Kikusui distributor/agent, and provide the "Kikusui Part No." given on the cover.

The Operation Manual has been prepared with the utmost care; however, if you have any questions, or note any errors or omissions, please contact Kikusui distributor/agent.

Firmware versions that this manual covers

This manual covers firmware versions 1.4X.

When contacting us about the product, please provide us with:

The model (marked in the top section of the front panel)

The firmware version (see page 2-9)

The serial number (marked on the rear panel)

Trademarks

Microsoft and Windows are either registered trademarks or trademarks of Microsoft Corporation in the United States and/ or other countries.

Other company names and product names used in this manual are generally trademarks or registered trademarks of the respective companies.

Copyrights

Reproduction and reprinting of operation manual, whole or partially, without our permission is prohibited. Both unit specifications and manual contents are subject to change without notice.

Contents

Chapter 1 General Information	1-1
1.1 About This Manual	1-2
1.2 Product Overview	1-2
1.3 PLZ-4W Series Lineup	1-3
1.4 Features	1-4
1.5 Overview of Controls	1-6
1.6 Options	1-8
Chapter 2 Installation and Preparation	2-1
2.1 Checking the Package Contents	2-2
2.2 Precautions Concerning Installation Location	2-3
2.3 Precautions When Moving the Unit	2-4
2.4 Connecting the Power Cord	2-5
2.5 Grounding (Earth)	2-6
2.6 Turning on The Power	2-7
2.7 Checking the ROM Version	2-9
2.8 Load Wiring	2-10
2.8.1 Precautions Concerning Wiring	2-10
2.8.2 Connection to the Load Input Terminal on the Rear Panel	2-14
2.8.3 Connection to the Load Input Terminal on the Front Panel	2-17
Chapter 3 For First Time Users	3-1
3.1 What Is an Electronic Load	3-2
3.2 Basic Flow of Operation	3-3
3.3 Operating area of the PLZ-4W	3-6
3.4 Basic Operation Modes	3-7
3.4.1 Operation of the CC Mode	3-7
3.4.2 Let's Use CC Mode	3-9
Chapter 4 Names and Functions of Parts	4-1
4.1 Front Panel	4-2
4.2 Rear Panel	4-4
4.3 Operation Panel	4-6
4.4 Display	4-12
Chapter 5 Basic Operation	5-1
5.1 Panel Control Basics	5-2
5.2 Turning On or Off the Load	5-3
5.3 Types of Protection Functions	5-6
5.4 Setting the Protection Function	5-8
5.5 Operation Modes	5-9

5.6	CC Mode	5-10
5.7	CR Mode	5-13
5.8	CV Mode	5-16
5.9	CP Mode	5-18
5.10	Soft start	5-20
	5.10.1 Response Time until Current Starts Flowing	5-22
5.11	Lock Function	5-23
5.12	Short Function	5-25
5.13	Menu Setup	5-26
5.14	Initialization	5-29
5.15	Response Speed	5-30

Chapter 6 Applied Operation 6-1

6.1	ABC preset memories	6-2
	6.1.1 Saving to ABC preset memories	6-3
	6.1.2 Recalling ABC preset memories	6-3
6.2	Setup Memory	6-6
	6.2.1 Saving to the Setup Memory	6-7
	6.2.2 Recalling the Setup Memory	6-8
6.3	Switching Function	6-10
6.4	Setting the Slew Rate	6-12
6.5	Using the Elapsed Time Display and the Auto Load Off Timer	6-13
6.6	Sequence Function	6-14
	6.6.1 Overview of the Normal Sequence	6-15
	6.6.2 Sequence Editing	6-18
	6.6.3 Sequence Example (Normal Sequence)	6-21
	6.6.4 Overview of the Fast Sequence	6-27
	6.6.5 Fast Sequence Editing	6-29
	6.6.6 Sequence Example (Fast Sequence)	6-31
	6.6.7 Executing, Pausing, Stopping the Sequence	6-36
6.7	Remote Sensing Function	6-38
6.8	External Control	6-39
	6.8.1 Overview and Precaution of External Control	6-39
	6.8.2 J1/J2 connector	6-40
	6.8.3 External Control of CC Mode	6-44
	6.8.4 External Control of CR Mode	6-50
	6.8.5 External Control of CP Mode	6-52
	6.8.6 External Control of CV Mode	6-54
	6.8.7 External Control of Load On and Load Off	6-56
	6.8.8 Trigger Signal Control	6-57
	6.8.9 External Control of the Current Range	6-58
	6.8.10 Alarm Signal Control	6-59
6.9	Monitor Signal Output	6-60
6.10	Parallel operation	6-62
	6.10.1 Parallel Operation Using the Same Model	6-62
	6.10.2 Parallel Operation Using Load Boosters	6-65

6.10.3	Alarms during Parallel Operation	6-66
6.10.4	Response Speed during Parallel Operation	6-66
6.10.5	Slew Rate during Parallel Operation	6-66
6.10.6	Canceling the Parallel Operation	6-66

Chapter 7 Remote Control **7-1**

7.1	Overview	7-2
7.2	Interface Setup	7-3
7.2.1	GPIB Control	7-3
7.2.2	RS232C Control	7-4
7.2.3	USB Control	7-6
7.3	Contents of the accompanying CD-ROM	7-7
7.3.1	Installing the VISA Library	7-8
7.3.2	Installing the Software Application	7-10
7.4	Command Details	7-10

Chapter 8 Maintenance and Calibration **8-1**

8.1	Maintenance	8-2
8.1.1	Cleaning the Panels	8-2
8.1.2	Cleaning the Dust Filter	8-2
8.1.3	Inspecting the Power Cord	8-3
8.1.4	Internal Inspection	8-3
8.2	Confirming status of the fuse	8-4
8.3	Calibration	8-5
8.3.1	Calibration Overview	8-5
8.3.2	Preparation	8-6
8.3.3	Calibration Procedure	8-7
8.4	Malfunctions and Causes	8-14

Chapter 9 Specifications **9-1**

9.1	Electrical Specifications	9-2
9.2	General Specifications	9-8
9.3	Dimensions	9-10

Appendix **A-1**

A.1	Operating Area of the PLZ-4W	A-1
A.2	Basic Operation Modes	A-2
A.2.1	Operation of the CC Mode	A-2
A.2.2	Operation of the CR Mode	A-4
A.2.3	Operation of the CP Mode	A-6
A.2.4	Operation of the CV Mode	A-8
A.2.5	Operation of the CC+CV Mode	A-10
A.2.6	Operation of the CR+CV Mode	A-12
A.3	Operating Area of Each Model	A-15

A.3.1	Operating Area of the PLZ164W	-----	A-15
A.3.2	Operating Area of the PLZ334W	-----	A-16
A.3.3	Operating Area of the PLZ1004W	-----	A-17
A.3.4	Operating Area of the PLZ164WA	-----	A-18
A.3.5	Operating Area of the PLZ664WA	-----	A-19
A.4	Sequence Program Creation Table	-----	A-20

Index

I- 1

1

Chapter 1 General Information

This chapter gives an overview and introduces the features of the PLZ-4W Series Electronic Loads.

1.1 About This Manual

This operation manual covers the following PLZ-4W Series Electronic Loads.

- PLZ164W
- PLZ164WA
- PLZ334W
- PLZ664WA
- PLZ1004W

Product version covered

This operation manual covers electronic loads with ROM version **1.3x**.

When contacting us about the product, please provide us the following information.

- Model
- ROM version
- Manufacturing number (indicated at the lower section on the rear panel)

For the procedure of confirming the ROM version, see section 2.7, "Checking the ROM Version."

1.2 Product Overview

The PLZ-4W Series Electronic Load is a multifunctional system designed to offer the highest levels of reliability and safety. The electronic load contains a stable and high-performance current control circuit that enables high-speed load simulations. In addition, its CPU control feature works to improve operability and multifunctional capability.

The high-precision current settings provide you with sufficient resolution.

Because the electronic load comes standard with GPIB, RS232C, and USB communication functions, it can easily be incorporated into wide-ranging test and inspection systems.

1.3 PLZ-4W Series Lineup

The PLZ-4W Series consists of the electronic load and the load booster.

1. Electronic load (PLZ-4W or PLZ-4WA)
2. Load booster (PLZ-4WB)

Two types of the PLZ-4W Series are available depending on the input operating voltage.

1. Operating range of 1.5 V to 150 V. (PLZ-4W and PLZ-4WB)
2. Operating range of 0 V to 150 V. (PLZ-4WA)

■ Electronic load

Model	Maximum Operating Current (A)	Operating Voltage (V)	Wattage (W)
PLZ164W	33	1.5 to 150	165
PLZ334W	66		330
PLZ1004W	200		1 000
PLZ164WA	33	0 to 150	165
PLZ664WA	132		660

■ Load booster

Model	Maximum Operating Current (A)	Operating Voltage (V)	Wattage (W)
PLZ2004WB ^{*1}	400	1.5 to 150	2 000

*1. PLZ2004WB is a dedicated option for PLZ1004W.

1.4 Features

In addition to the high-performance constant current, constant resistance, and constant power modes, the PLZ-4W Series Electronic Load offers wide variety of other features.

■ High-speed slew rate of 16 A/ μ s (PLZ1004W)

The rise and fall slew rate of the current when switching at 2 % to 100 % (20 % to 100 % in M range) of the rated current in constant current mode is 16 A/ μ s (PLZ1004W), which converts to rise and fall times of 10 μ s (all types).

This allows you to conduct more accurate DC power transient response tests and to generate simulated waveforms for use as dummy loads.

■ Variable slew rate

Unlike the conventional electronic loads that were configured using rise and fall times, the PLZ-4W allows configuration using slew rates (A/ μ s) in constant current and constant resistance modes.

This allows you to optimize the voltage drop caused by the wire inductance that occurs when a load is switched or the transient control of the equipment under test (such as a constant voltage power supply).

■ Higher precision

Higher precision is offered for current settings.

Resolution at low current settings is provided using a 3-range configuration. (A 0.01 mA resolution is possible at the L range of the PLZ164W.)

■ Operability

The PLZ-4W employs a large LCD.

Measured values of voltage, current, and power at the load input terminal are indicated at all times. The values are indicated using larger characters than other sections to improve the visibility.

Coarse and fine adjustments using the rotary knob are useful for setting values over a wide range.

The easy-to-use memory function enables repetitive tests.

■ 0 V input type

A 0 V input operating voltage type is available.

This feature is a must for single cell tests of fuel cells. Moreover, the operating voltage of semiconductor devices is decreasing more and more due to the reduction of the power consumption and miniaturization of the semiconductor process. The 0 V input type can be used to evaluate the power supplies for these types of applications.

■ Sequence function

Sequence patterns set arbitrarily can be saved to built-in memory.

Up to 10 normal sequence programs and 1 fast sequence program can be saved. Up to 256 steps and 1024 steps can be saved for each normal sequence program and fast sequence program, respectively.

The sequence pattern can be edited easily using the large LCD.

■ Useful function for battery discharge tests

The PLZ-4W can measure the time from load on to load off.

When combined with the under voltage protection (UVP) function, the time from when the battery discharge is started until the battery voltage falls to the cutoff voltage can be measured (time measurement).

In voltage measurement, the voltage immediately before the load turns off is measured. If you set a timer to turn off the load after a specified time elapses, you can measure the closed circuit voltage after a specified time elapses from the start of battery discharge (voltage measurement).

■ Load booster

To achieve large capacity at low cost, the PLZ1004W comes with a load booster (PLZ2004WB).

Using a single PLZ1004W as a master unit, up to four load boosters can be connected in parallel (9 kW, 1800 A maximum).

■ Standard GPIB, RS232C, and USB communication functions

Because the electronic load comes standard with GPIB, RS232C, and USB communication functions, it can easily be incorporated into wide-ranging test and inspection systems.

Wide variety of systems can be configured when combined with the sequence function.

1.5 Overview of Controls

This section describes the controls on the electronic load and combined systems.

Operation using the control panel

The PLZ-4W employs a large LCD. Measured values of voltage, current, and power at the load input terminal are indicated at all times. The values are indicated using larger characters than other sections to improve the visibility.

Coarse and fine adjustments using the rotary knob are useful for setting values over a wide range.



Fig.1-1 Panel control

External communication interface

The PLZ-4W can be controlled from a PC.

GPIB, RS232C, and USB communication functions come standard.

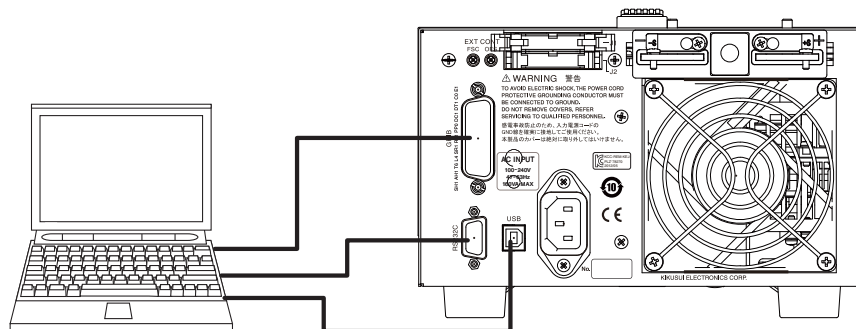

Fig. 1-2 PLZ-4W and PC connection diagram

Support for large capacity

To achieve large capacity at low cost, the PLZ1004W comes with a load booster (PLZ2004WB).

Using a single PLZ1004W as a master unit, up to four load boosters can be connected in parallel (9 kW, 1800 A maximum).

In parallel operation without using load boosters, up to five electronic loads of the same type including the master unit can be connected in parallel (5 kW, 1000 A maximum).

PLZ1004W

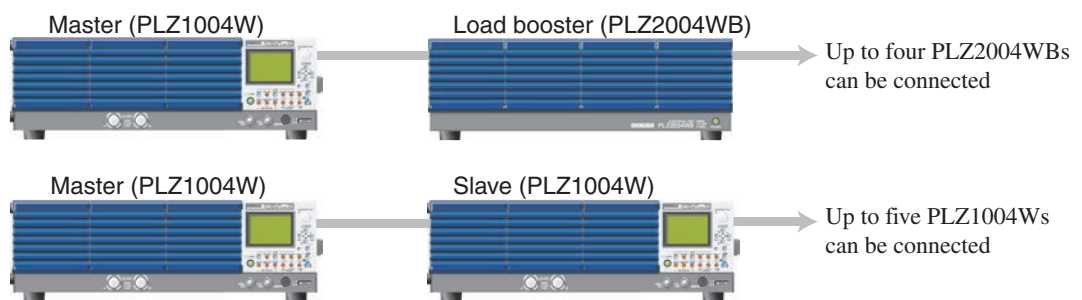

PLZ-4W other than PLZ1004W

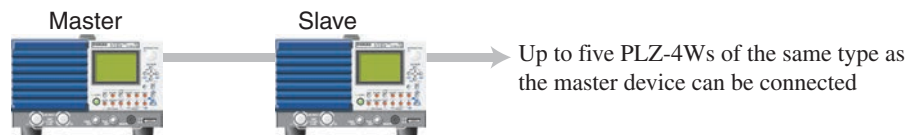

Fig. 1-3 Parallel connection

1.6 Options

Control flat cables

Control cable used to connect between the master unit and the slave unit (load booster) and between slave units. The following two types of cables are available.

Model	Code	Length	Application
PC01-PLZ-4W	84540	300 mm	Connect between the master unit and the slave unit (load booster) and between slave units
PC02-PLZ-4W	84550	450 mm	Connect between the master unit and load booster

The two types of cables only differ in their length. The 550-mm PC02-PLZ-4W is required to connect the master unit and the load booster.

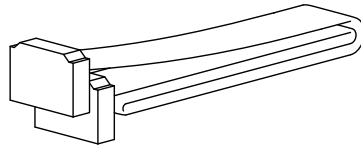

Analog remote control connector kit (OP01-PLZ-4W)

A kit for connecting to the J1/J2 connector.

Pins	20 pcs.
Socket	1 pc.
Protection cover	1 set

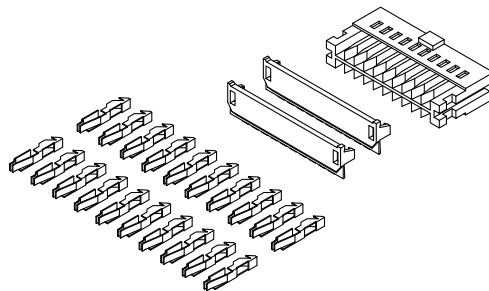

Rack Mounting Option

The following rack mounting options are available.

Item	Model	Applicable Model	Note
Rack adapter (Fig. 1-4)	KRA3	PLZ164W PLZ334W PLZ164WA	Inch rack EIA standard
	KRA150		Milli rack JIS standard
Rack mount bracket (Fig. 1-5)	KRB3-TOS	PLZ664WA PLZ1004W	Inch rack EIA standard
	KRB150-TOS		Milli rack JIS standard

For details, contact your Kikusui agent or distributor.

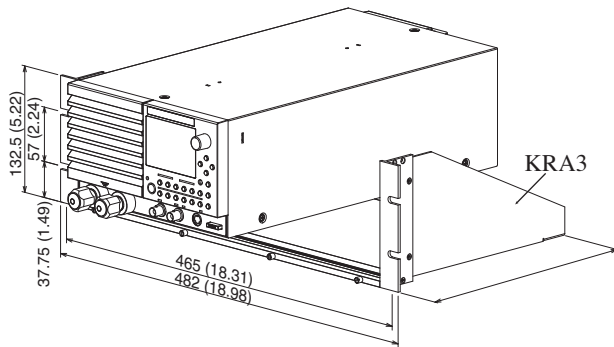
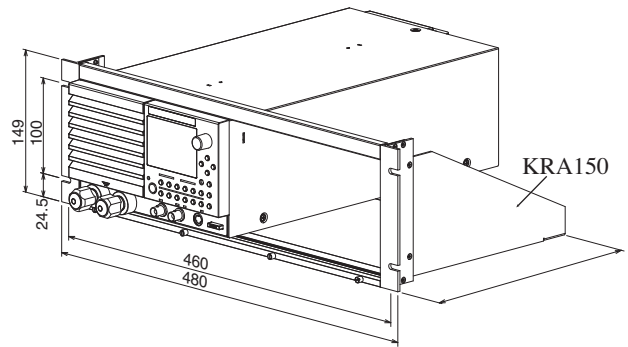

Fig. 1-4 Rack adapter



Unit: mm (inch)

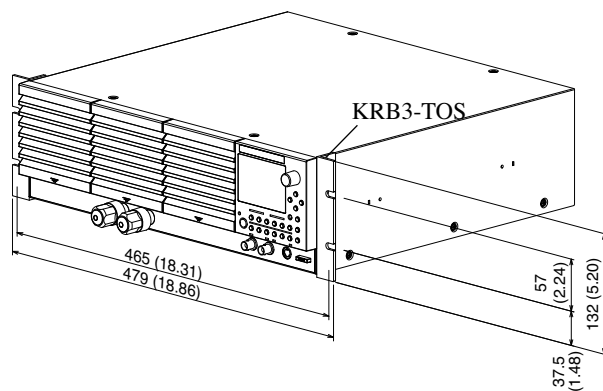
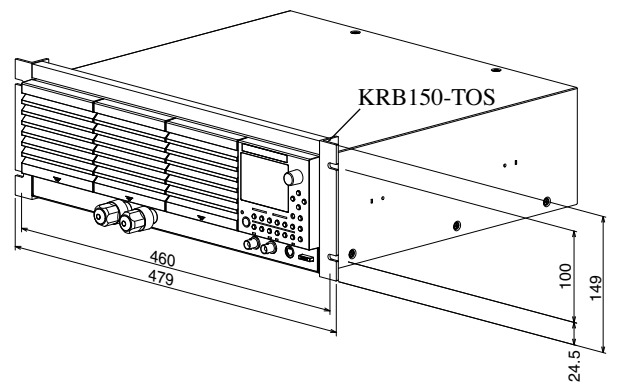

Fig. 1-5 Rack mount bracket



Unit: mm (inch)



2

Chapter 2 Installation and Preparation

This chapter describes the procedures of unpacking and preparation before using the PLZ-4W.

2.1 Checking the Package Contents

When you receive the product, check that all accessories are included and that the product and accessories have not been damaged during transportation.

If any of the accessories are damaged or missing, contact your Kikusui agent or distributor.

NOTE

- It is recommended that all packing materials be saved, in case the product needs to be transported at a later date.

The power cord that is provided varies depending on the destination for the product at the factory-shipment.

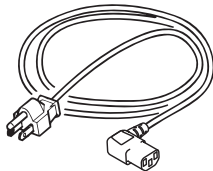

Plug: NEMA5-15
Rating: 125 Vac/10 A
[85-AA-0003]

or

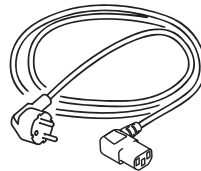

Plug: CEE7/7
Rating: 250 Vac/10 A
[85-AA-0005]

or

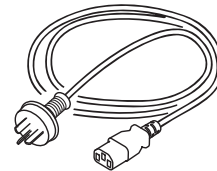

Plug: GB1002
Rating: 250 Vac/10 A
[85-10-0790]

- Power cord
(1 pc.)

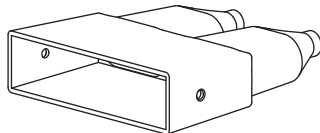

[Q1-500-085]

- Load input terminal cover (1 pc.)
Lock plate (2 pcs.)



[P2-000-228]

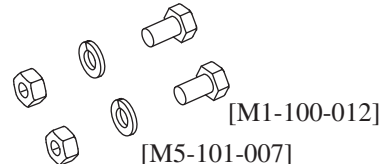

[M4-100-007]

- Set of screws for the load input
terminal (2 sets)

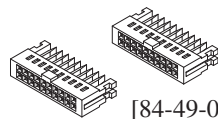

[84-49-0071]

- J1/J2 protection dummy plug (2 pcs.)
[Attached to the product.]

- CD-ROM (1 pc.)

- Setup Guide (1 pc.)

- Quick Reference
(Japanese 1sheet, English 1sheet)

Fig.2-1 Accessories

2.2 Precautions Concerning Installation Location

This section describes the precautions to be taken when installing the unit. Make sure to observe them.

■ Do not use the unit in a flammable atmosphere.

To prevent the possibility of explosion or fire, do not use the unit near alcohol, thinner or other combustible materials, or in an atmosphere containing such vapors.

■ Avoid locations where the unit is exposed to high temperature or direct sunlight.

Do not place the unit near a heater or in areas subject to drastic temperature changes.

Operating temperature range: 0 °C to +40 °C (+32 °F to +104 °F)

Storage temperature range: -25 °C to +70 °C (-13 °F to +158 °F)

■ Avoid humid environments.

Do not place the unit in high-humidity locations--near a boiler, humidifier, or water supply.

Operating humidity range: 20 % to 85 % RH (no condensation)

Storage humidity range: 0 % to 90 % RH (no condensation)

Condensation may occur even within the operating humidity range. In such case, do not use the unit until the condensation dries up completely.

■ Do not place the unit in a corrosive atmosphere.

Do not install the unit in a corrosive atmosphere or in environments containing sulfuric acid mist, etc. This may cause corrosion of various conductors and bad contacts of connectors inside the unit leading to malfunction and failure, or in the worst case, a fire.

However, operation in such environments may be possible through alteration. If you wish to use the unit in such environments, consult your Kikusui agent or distributor.

■ Do not place the unit in a dusty location.

Accumulation of dust can lead to electric shock or fire.

■ Do not use the unit where ventilation is poor.

The unit employs a forced air cooling system. Air is taken in from air inlet located on panels other than the rear panel and exhausted from the air outlet on the rear panel. Secure adequate space around the unit to prevent the possibility of fire caused by accumulation of heat.

Allow at least 20 cm of space between the air inlet/outlet and the wall (or obstacles).

Hot air (approximately 20 °C higher than the ambient temperature) is exhausted from the air outlet. Do not place objects that are affected by heat near the air outlet.

■ **Do not place objects on top of the unit.**

Placing objects on top of the unit can cause failures (especially heavy objects).

■ **Do not place the unit on an inclined surface or location subject to vibrations.**

The unit may fall or tip over causing damages and injuries.

■ **Do not use the unit in a location where strong magnetic or electric fields are nearby or a location where large amount of distortion and noise is present on the input power line waveform.**

The unit may malfunction.

■ **Do not use the unit near highly sensitive measuring instruments or transceivers.**

The noise generated by the unit may affect them

■ **Secure adequate space around the power plug.**

Do not insert the power plug to an outlet where accessibility to the plug is poor. And, do not place objects near the outlet that would result in poor accessibility to the plug.

2.3 Precautions When Moving the Unit

When moving the unit to the installation location or when transporting the unit, note the following points.

■ **Turn off the POWER switch.**

Moving the unit while the power is turned on can cause electric shock or damage to the unit.

■ **Remove all wiring.**

Moving the unit with the cables connected can cause wires to break or injuries due to the unit falling over.

■ **Hold the handle.**

When lifting the unit, hold the handle on the side or top panel.

■ **When transporting the unit, be sure to use the original packing materials.**

Otherwise, damage may result from vibrations or from the unit falling during transportation.

2.4 Connecting the Power Cord

The power cord that is provided varies depending on the destination for the product at the factory-shipment.

⚠ WARNING

- This product is designed to be connected to a power supply classified as Overvoltage Category II. Do not connect to a power supply classified as Overvoltage Category III or IV.
- The power cord for 100-V system has a rated voltage of 125 VAC. If this power cord is used at the line voltage of a 200-V system, replace the power cord with that satisfying that line voltage.
Have a qualified engineer select the appropriate power cord. If obtaining the right power cord is difficult, contact Kikusui distributor/agent.

NOTE

- The power cord with a plug can be used to disconnect the PLZ-4W series from the AC power line in an emergency. Connect the plug to an easily accessible power outlet so that the plug can be removed from the outlet at any time. Be sure to provide adequate clearance around the power outlet.
- Do not use the power cord that comes with the product as a power cord for other equipment.

-
1. Check that the AC power supply is within the input power supply range of the product.

Input voltage range: 100 VAC to 240 VAC

(100 V to 120 V and 200 V to 240 V for the PLZ164WA and PLZ664WA)

Frequency range: 47 Hz to 63 Hz

2. Check that the POWER switch is turned off.
3. Connect the power cord to the AC INPUT connector on the rear panel.
Use a power cord specified by Kikusui or one that has been selected by a qualified engineer.
4. Insert the power plug to the outlet.

2.5 Grounding (Earth)

-
- ⚠ WARNING**
- Electric shock may occur, if proper grounding is not furnished.
 - This product is designed as a Class I equipment (equipment furnished with electric shock protection through protective grounding in addition to the basic insulation). Be sure to connect the protective ground terminal to an appropriate earth ground.
- ⚠ CAUTION**
- If you do not ground the product, malfunction may occur due to external noise, or the noise generated by the product may become large.
-

Make sure to ground the unit for your safety.

Connect the power cord to a three-pin power outlet with proper grounding.

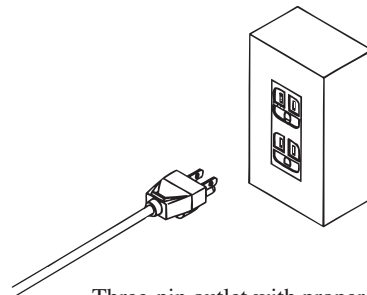

Three-pin outlet with proper grounding

Fig. 2-2 Grounding

2.6 Turning on The Power

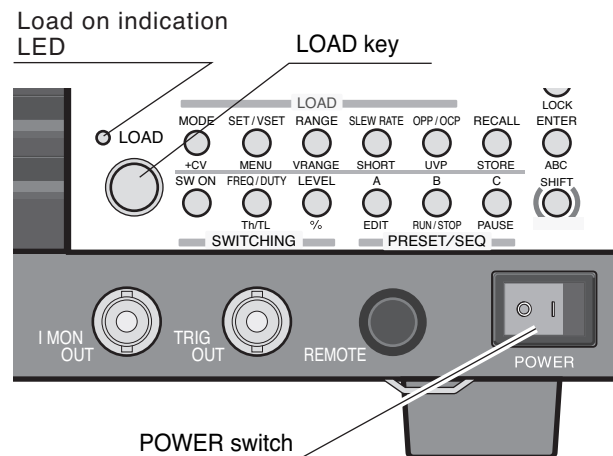
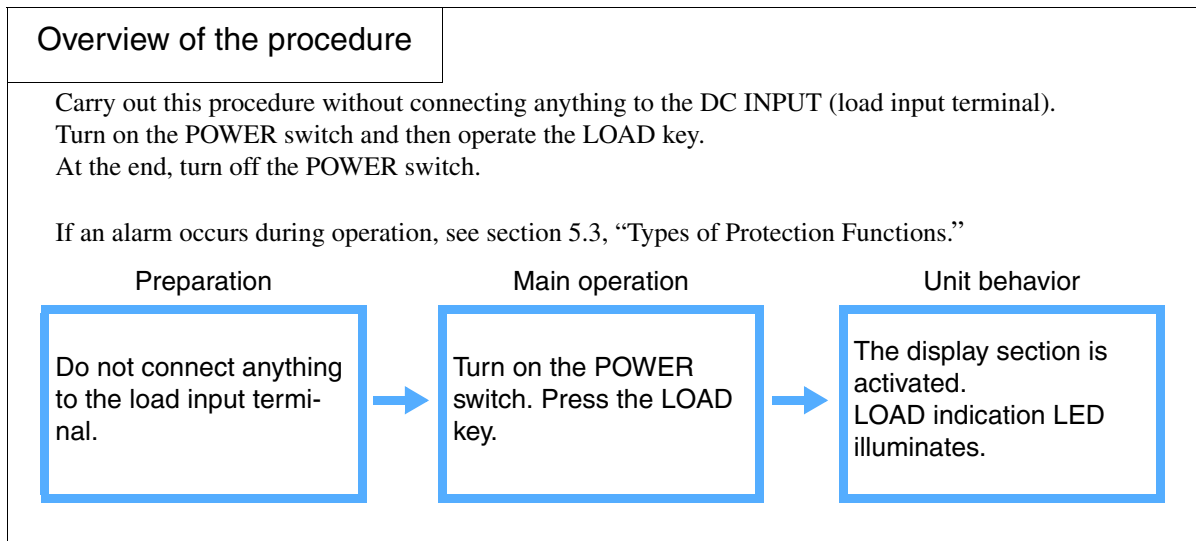

Fig. 2-3

1. Check that the POWER switch is turned off(○).
2. Check that the power cord is correctly connected.
See section 2.4, “Connecting the Power Cord” and 2.5, “Grounding (Earth).”
3. Check that nothing is connected to the DC INPUT (load input terminal) on the front and rear panels.
4. Turn the POWER switch on.
Push the (I) side of the POWER switch to turn the PLZ-4W on.
A self-test is executed. A special screen appears during the test at startup. A normal display appears when the self-test is complete.
5. Check whether the display appears as shown in Fig. 2-4.
The measured value displayed using large numbers (section with mA, V, and W unit) indicates coarse zero.

The characters “SET” shown under the measured value is highlighted with an underline.

This indicates that basic settings can be entered in the selected operation mode.

This condition in which characters “SET” is highlighted is called the basic setting entry condition.

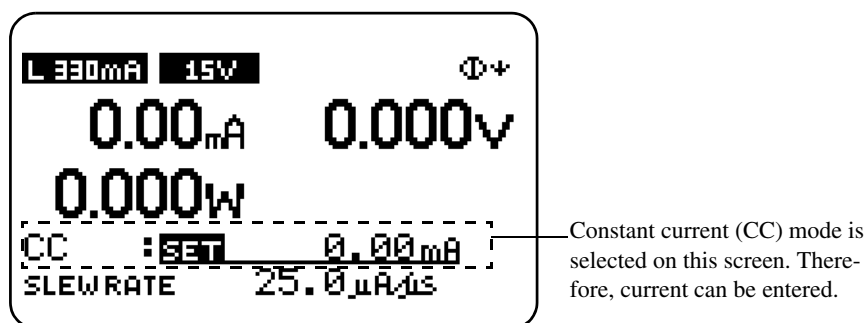

Fig. 2-4 Basic setting entry condition

6. Press the LOAD key and check that the LED above the key illuminates.
7. Press the LOAD key again and check that the LED above the key turns off.
8. Turn off the POWER switch to finish the operation check procedure.

The PLZ-4W saves the last setup conditions through the backup function even when the power is turned off. When the power is turned on the next time, the PLZ-4W returns to the conditions that were backed up.

CAUTION • To prevent malfunction, allow at least 5 s between power cycles.

If the PLZ-4W does not operate as described in the procedure

If one of the following conditions applies to your case, carry out the corresponding procedure. If the condition does not change even after taking the countermeasure indicated below, contact Kikusui distributor/agent.

Nothing is displayed.

Check the power cord connection and power cycle the unit.

Adjust the display contrast. For the adjustment procedure, see the next page.

Indicates an abnormal current or voltage.

Power cycle the unit.

An alarm occurs.

See section 5.3, “Types of Protection Functions.”

Adjusting the display contrast

1. While pressing the SHIFT key, use the rotary knob to adjust the contrast.

The result is saved.

2.7 Checking the ROM Version

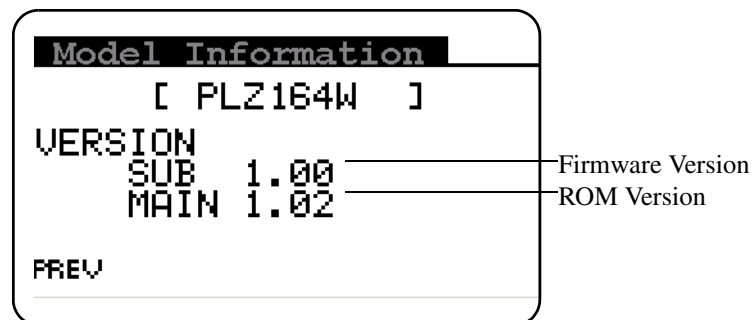

Fig. 2-5 Model Information screen (PLZ164W)

1. Press the MENU (SHIFT+SET/VSET) key.
The menu screen is displayed.
2. Use the CURSOR ▼ key to select 4. Model Info.
The selected section is highlighted.
3. Press the ENTER key.
The Model Information screen of Fig. 2-5 is displayed.
4. Press the MENU (SHIFT+SET/VSET) key to close the menu.

2.8 Load Wiring

To ensure that the functions of the PLZ-4W work accurately and reliably, all wires must be connected correctly to their loads.

-
- NOTE** • This operation manual refers to the terminal on the rear panel to which the equipment under test is connected and current is supplied as load input terminal.
-

2.8.1 Precautions Concerning Wiring

Electric wire used

-
- CAUTION** • Use a load wire with sufficient diameter for the current as well as non-flammable or flame-resistant cover.
-

If the resistance of the load wire is large, a large voltage drop may occur when a current is supplied and the voltage at the load input terminal may fall below the minimum operating voltage. Refer to Table 2-1 and select thick wires as much as possible.

Table2-1 Nominal cross-sectional area of wires and allowable currents

Nominal Cross-Sectional Area [mm ²]	AWG	(Reference Cross-Sectional Area) [mm ²]	Allowable Current(*) [A] (Ta = 30 °C)	Kikusui-Recommended Current [A]
2	14	(2.08)	27	10
3.5	12	(3.31)	37	-
5.5	10	(5.26)	49	20
8	8	(8.37)	61	30
14	6	(13.3)	88	50
22	4	(21.15)	115	80
30	2	(33.62)	139	-
38	1	(42.41)	162	100
50	1/0	(53.49)	190	-
60	2/0	(67.43)	217	-
80	3/0	(85.01)	257	200
100	4/0	(107.2)	298	-
125	-	-	344	-
150	-	-	395	300
200	-	-	469	-
250	-	-	556	-
325	-	-	650	-

*Excerpts from Japanese laws related to electrical equipment.

Load wire inductance

The load wiring has an inductance (L). When the current (I) varies in short time period, it generates a large voltage at both ends of the wiring cable. This voltage applies to all of the load input terminals of the PLZ-4W when the impedance of the EUT is relatively small. The voltage generated by the load wire inductance (L) and the current variation (I) is expressed using the following equation.

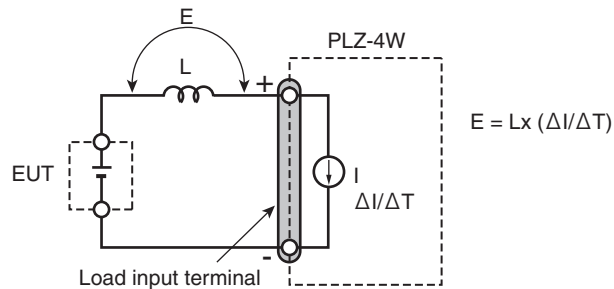

Fig. 2-6 Load wire and inductance

In general, the wire inductance can be measured approximately 1 μH per 1 meter. If the 10 meters of load cables is wired between the EUT and the PLZ-4W with the current variation of 10 $\text{A}/\mu\text{s}$, the voltage generated by the wire inductance will be 100 V.

The negative polarity of the load input terminal is the reference potential of the external control signal, therefore, the device connected to the external control terminal may get malfunctioned.

When operating under the constant voltage (CV) mode or constant resistance (CR) mode or constant power (CP) mode, the load current is varied by the voltage at the load input terminal, so the operation can be affected easily by the generated voltage.

The wiring to the EUT should be twisted and the shortest as possible.

If the load wire is long or has a large loop, the wire inductance is increased. Consequently, the current variation at the time of switching operation will cause a large voltage drop.

When the value of instantaneous voltage drops under the minimum operating voltage depends on the generated voltage at the load input terminal, the response of recovery will be extensively delayed. In such event, the PLZ-4W may generate unstable oscillation or becomes into the hunting operation. In such condition, the input voltage may exceed the maximum input voltage and cause damage to the PLZ-4W.

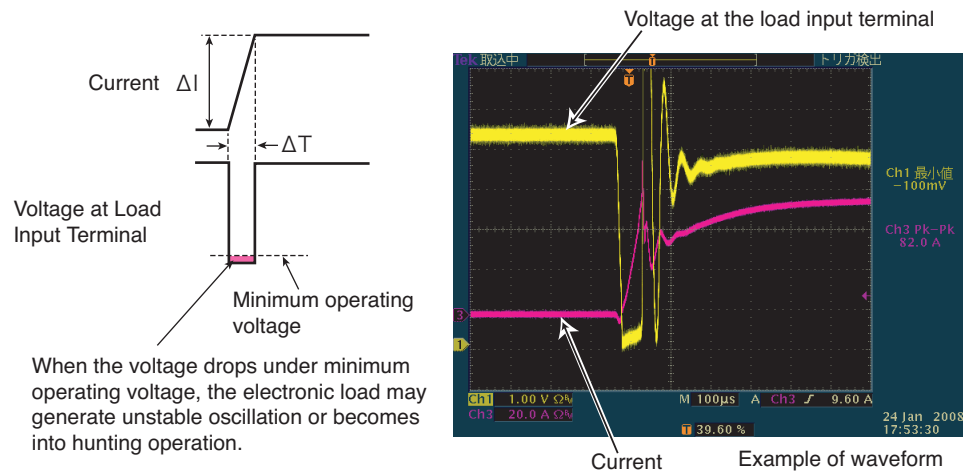

Fig. 2-7 Waveform example: Generate unstable oscillation or hunting operation

You must be careful especially when the slew rate setting is high or switching is performed using large currents through parallel operation.

To prevent problems, connect the PLZ-4W and the equipment under test using the shortest twisted wire possible to keep the voltage caused by inductance within the minimum operating voltage and maximum input voltage range or set a low slew rate. If the high-speed response operation is not required, set the lower response speed and decrease the slew rate setting.

In the case of DC operation also, the phase lag of the current may cause instability in the PLZ-4W control inducing oscillation. In this case also, connect the PLZ-4W and the equipment under test using the shortest twisted wire possible. If only DC operation is required, a capacitor and a resistor may be connected to the load input terminal as shown in Fig. 2-8 to alleviate oscillation. In this case, use the capacitor within its allowable ripple current.

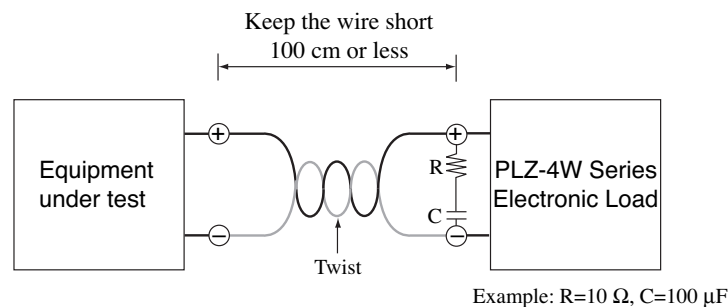

Fig. 2-8 Length of wiring

■ Operation when the response speed is changed

You can change the response speed in CC mode (CC+CV mode) and CR mode (CR+CV mode).

In some cases, the wire inductance increases and the phase lag of the current may cause instability in the PLZ-4W control inducing oscillation.

In such case, you can decrease the response speed to assure stable operation.

- For a description of response speed, see section 5.15, “Response Speed.”

Overvoltage

-
- ⚠ CAUTION** • Do not apply voltage exceeding the maximum voltage of 150 VDC to the load input terminal, as it may cause damage.
-

The maximum voltage that can be applied to the load input terminal is 150 VDC. Voltage exceeding the maximum cannot be used.

If overvoltage is applied, an alarm message appears along with a beeping alarm, and the load is turned off. In this case, immediately lower the voltage of the equipment under test.

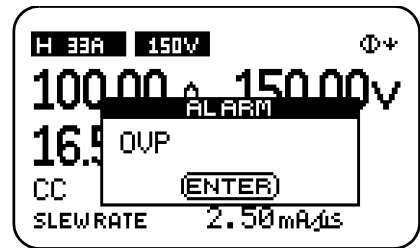

Fig. 2-9 Overvoltage alarm

Polarity

-
- ⚠ CAUTION** • If the polarity is reversed, overcurrent may damage the EUT and PLZ-4W.
-

Be sure to match the polarities between the load input terminal and the equipment under test.

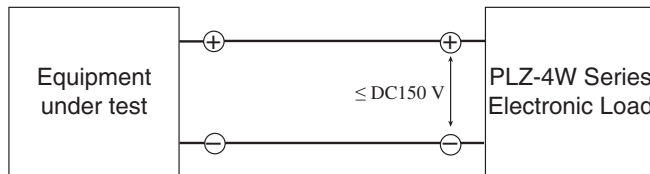

Fig. 2-10 Connection by paying attention to the polarity

If the polarity is reversed, an alarm message appears along with a beeping alarm. In this case, turn off the power of the equipment under test within 30 seconds after the alarm is activated. (the beeping alarm sounds when a reverse voltage of 0.6 V or greater is applied).



Fig. 2-11 Reverse connection alarm

2.8.2 Connection to the Load Input Terminal on the Rear Panel

Using the terminal cover

The load input terminal cover that comes with the package is used by passing through the load wire.

If the wire that you are using is thick and cannot be passed through the cover sleeve (where the wire is passed through), cut and adjust the size of the sleeve to match the thickness of the wire.

Use trial and error so that you don't cut too much of the sleeve.

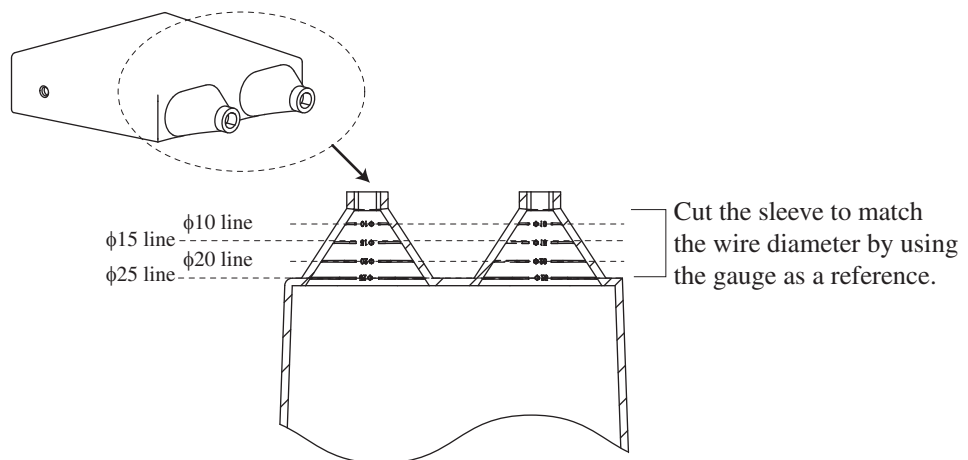

Fig. 2-12 Load input terminal cover

Attaching the lock plate

The lock plate is used to fix the load input terminal cover to the rear panel.

Once attached, you do not have to remove it. When using the load input terminal cover for the first time, attach the lock plate in advance.

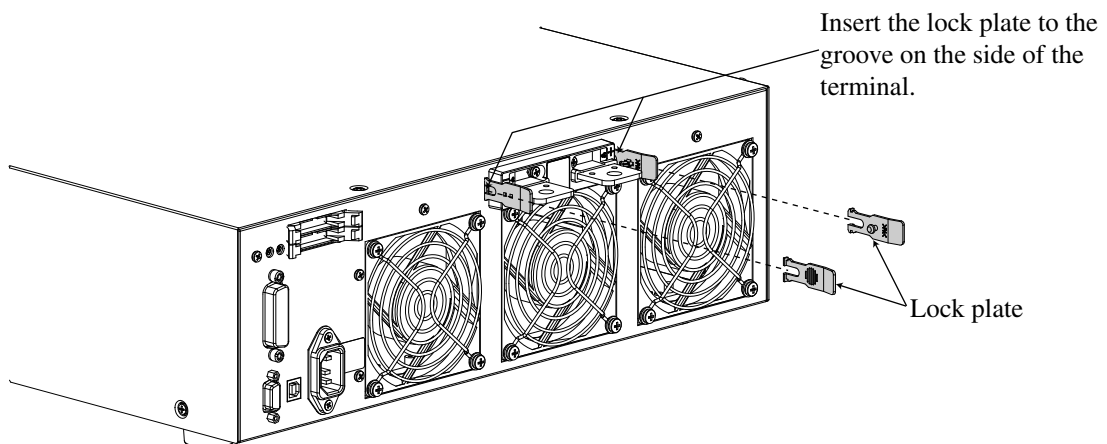

Fig. 2-13 Attachment of the lock plate

Connection procedure of the load input terminal on the rear panel

- ⚠ WARNING**
- Do not touch the load input terminal while the PLZ-4W is turned ON, as it may lead to electric shock.

In addition, be sure to use the load input terminal cover.

- The load input terminals on the front and rear panels are coupled inside the PLZ-4W. A voltage applied to one end will appear on the other end.

- ⚠ CAUTION**
- Do not connect equipment to the load input terminals on the front and rear panels simultaneously, as it can cause damage.
 - There is a danger of breakdown. Do not connect the equipment under test to the load input terminal when the load is turned on.
 - There is a danger of overheat. Attach crimping terminal to the wire and use the set of screws that came with the package for connection.

1. Turn off the POWER switch.
2. Check that the output of the equipment under test is off.
3. Connect the load wire to the load input terminal on the rear panel.
Use the load input terminal cover. See Fig. 2-12 on how to use the cover.
For the connection procedure of the load wire, see Fig. 2-14.
4. Fix the load input terminal cover to the rear panel using the lock plate.
Pass the inner pin of the lock plate through the hole on the side of the cover.
For details, see Fig. 2-15.
5. Connect the load wire to the output terminal of the equipment under test.
6. Check the polarity of the connection.

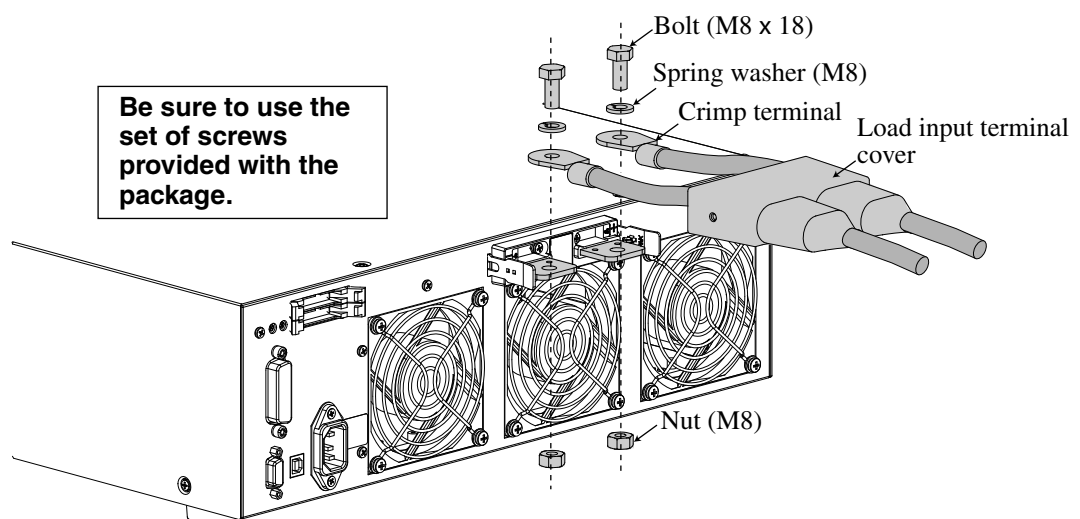

Fig. 2-14 Connection to the load input terminal on the rear panel

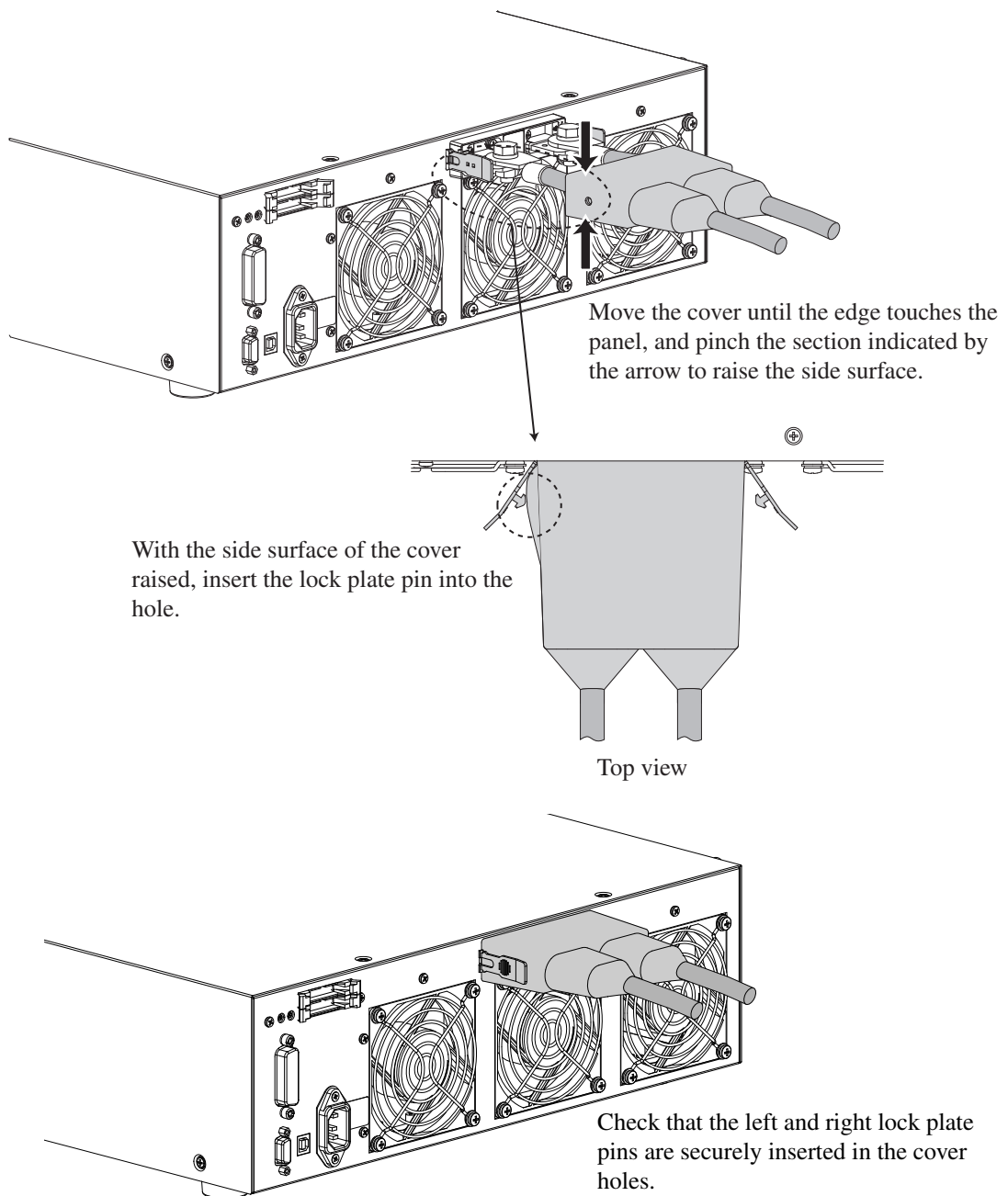

Fig. 2-15 Attachment of the load input terminal cover

Removing the load input terminal cover.

Open the lock plate left and right, and remove the pin from the hole of the cover.

2.8.3 Connection to the Load Input Terminal on the Front Panel

The load input terminal on the front panel can be used to easily connect the equipment under test and the PLZ-4W.

-
- ⚠ WARNING**
- Do not touch the load input terminal while the PLZ-4W is turned ON, as it may lead to electric shock.
 - The load input terminals on the front and rear panels are coupled inside the PLZ-4W. A voltage applied to one end will appear on the other end.
- ⚠ CAUTION**
- Do not connect equipment to the load input terminals on the front and rear panels simultaneously, as it cause damage.
 - There is a danger of breakdown. Do not connect the equipment under test to the load input terminal when the load is turned on.
 - There is a danger of breakdown. During parallel operation, do not use the input terminals on the front panel.
 - There is a danger of overheat. Attach crimping terminal to the wire and use the set of screws that came with the package for connection.
-

- NOTE**
- The specifications of the PLZ-4W are for the load input terminal on the rear panel.
 - The maximum input current to the load input terminal on the front panel is 66 A. It is automatically limited to 66 A.
-

1. Turn off the POWER switch.
2. Check that the output of the equipment under test is off.
3. Connect the load wire to the load input terminal on the front panel.
For the connection procedure of the load wire, see Fig. 2-16.
4. Connect the load wire to the output terminal of the equipment under test.
5. Check the polarity of the connection.

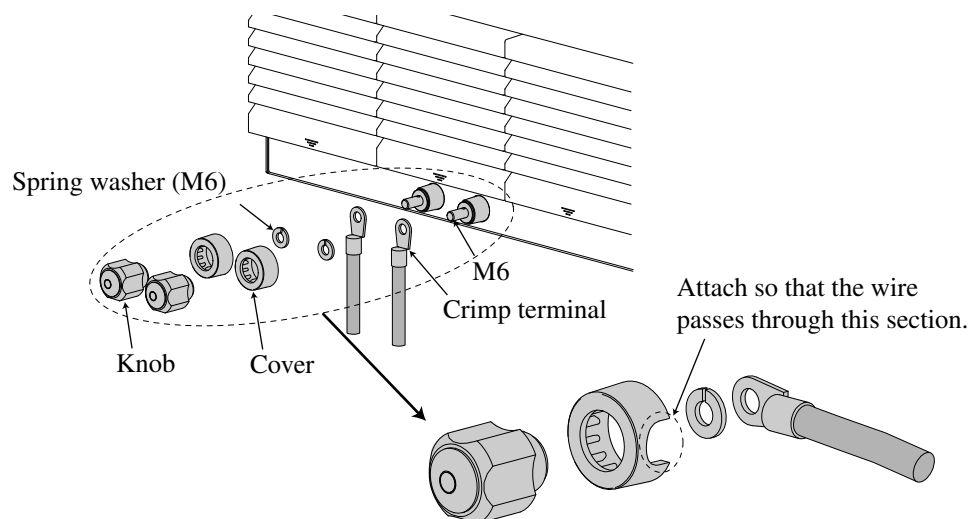

Fig. 2-16 Connection to the load input terminal on the front panel



3

Chapter 3 For First Time Users

This chapter describes for first time users, the operation modes of the PLZ-4W and matters that users should be familiar with in operating the PLZ-4W.

3.1 What Is an Electronic Load

When measuring the characteristics of the power supply in designing a power supply, a load that is applied to the power supply is required. An electronic load refers to a device that uses semiconductors (transistors) in place of a variable resistor to act as a load. Because voltage and current can be controlled freely on a semiconductor, the load can be controlled arbitrarily by embedding a control circuit.

The electronic load is used as (1) a load for various electronic circuits, (2) a load for characteristics tests and life tests of various DC power supplies such as a switching power supply and primary and secondary batteries, and (3) a load for aging. The sequence function can be used to simulate the load tests of power supplies with large load fluctuation (such as a power supply for a printer) in a condition that is close to the actual load.

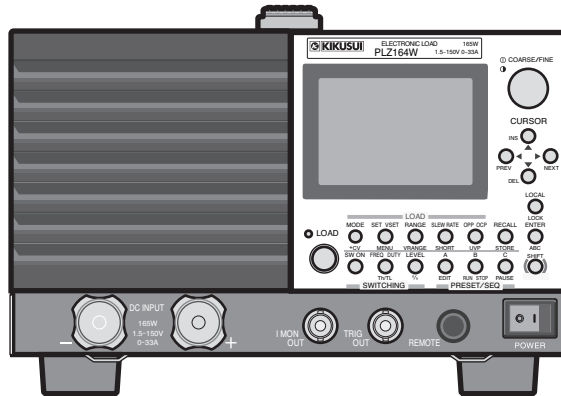

Fig.3-1 PLZ164W (1.5 V input type), PLZ164WA (0 V input type), and PLZ334W (1.5 V input type)

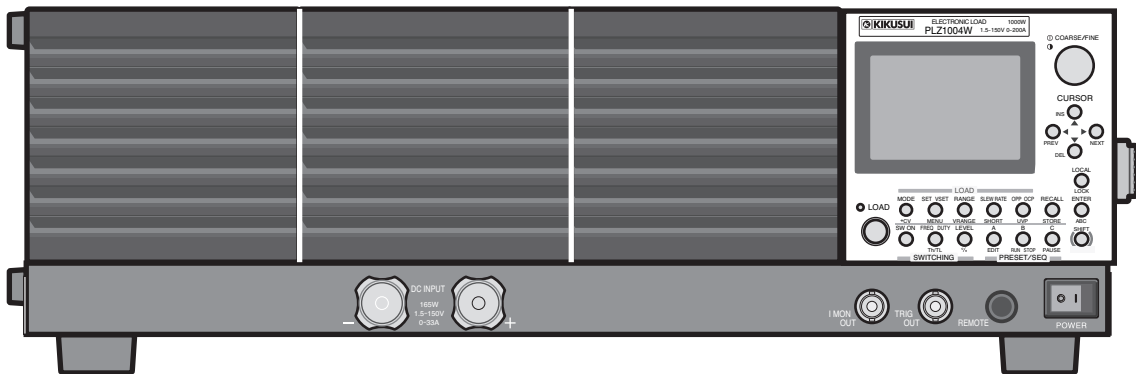

Fig. 3-2 PLZ664WA (0 V input type) and PLZ1004W (1.5 V input type)

3.2 Basic Flow of Operation

This section runs through the precautions concerning installation and preparation, the use of the operation panel, and functions that are convenient for performing experiments and tests.

- For details on the precautions concerning installation and preparation, see chapter 2, "Installation and Preparation."

Preparations before using the PLZ-4W

Precautions to be taken when installing or moving the PLZ-4W

Be sure to read section 2.2, "Precautions Concerning Installation Location" when installing the PLZ-4W.

When moving the PLZ-4W, be sure to turn off the power and remove the power cord. When lifting the PLZ-4W, hold the handle on the side or top panel.

- **Avoid using the PLZ-4W in a dusty environment, an environment with poor ventilation, on an inclined surface, a location subject to vibrations, or a location subject to strong magnetic or electric fields.**
- **Do not obstruct the air inlet on the front panel and the air outlet on the rear panel.**

Always ground the PLZ-4W

Be sure to earth ground the PLZ-4W before turning on the power to prevent electric shock.

Precautions to be taken when connecting the equipment under test

- **Be sure to turn off the power when touching the load input terminal (front and rear panels) or when connecting the load. Be especially careful of the polarity of the connection between the load input terminal and the equipment under test.**
- **Use a load wire with sufficient diameter for the current as well as non-flammable or flame-resistant cover.**
- **Do not connect equipment under test to the load input terminals on the front and rear panels simultaneously.**

On using the PLZ-4W

Precaution to be taken when turning on the power

Check that there are no irregularities in the input power supply or power cord before turning on the power. After connecting the power cord, turn on the POWER switch to turn on the PLZ-4W.

- **Allow at least 5 seconds between power cycles.**
- **If you feel something is wrong with the PLZ-4W, turn off the power switch. Then, remove the power plug from the outlet or remove the power cord from the PLZ-4W.**

Warming up the PLZ-4W

To perform stable measurements, allow the PLZ-4W to warm up for at least 30 minutes before starting tests. While the PLZ-4W is warming up, check the operation of the PLZ-4W and the connection of the equipment under test.

Voltage drop in the load wire

If the load wire is long, a voltage drop occurs due to the resistance of the cable. If the amount of voltage drop caused by the wire cannot be ignored or if you wish to set the resistance, voltage, and current accurately, execute remote sensing before making measurements. For the setup procedure of the remote sensing function, see section 6.7, "Remote Sensing Function."

How to use the operation panel

The PLZ-4W is controlled from the operation panel on the front panel. If you make an invalid selection or perform an invalid key operation, a beep is sounded to notify the error. In particular, please familiarize yourself with the use of the SHIFT key that changes the key function.

- For a description of the functions of each key, see chapter 4, "Names and Functions of Parts."
- **To prevent the possibility of electric shock, never touch the load input terminal while the equipment under test is connected and the power is turned on. When touching the load input terminal, be sure to turn off the equipment under test.**

■ Function of the LOAD key

If you press the LOAD key when the load is turned off, the LOAD LED illuminates, and the load turns on. If you press the LOAD key when the load is turned on, the LOAD LED turns off, and the load turns off.

-
- ⚠ CAUTION** • There is a danger of breakdown. Turn off the load when applying the output of the equipment under test to the PLZ-4W. Then, turn the load on. If you are making the connection with the load turned on, be sure to turn off the output of the equipment under test.

If a relay or electromagnetic switch is inserted between the load input terminal and the output terminal of the equipment under test, turn on the relay or electromagnetic switch when the load is turned off. Then, turn the load on.

■ How to use the rotary knob

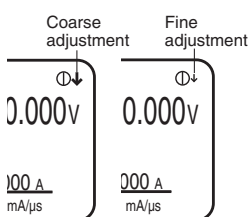

The rotary knob is used when setting values such as the current and resistance. Turning the rotary knob to the right increases the value and turning it to the left decreases the value. In addition, you can press the rotary knob to switch between coarse adjustment and fine adjustment. When the "↓" shown at the upper right corner of the screen is large, coarse adjustment is active; when it is small, fine adjustment is active. When setting a value, use coarse adjustment to set the value roughly, and then switch to fine adjustment to set value precisely.

-
- NOTE** • You can traverse the full scale of values by turning the rotary knob ten and a few turns. Fine adjustment changes values at 1/10 of the rate of coarse adjustment.
-

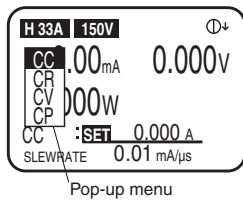

■ Pop-up menu operation

Some keys show a pop-up menu when you press the key. If you press the key again while the menu is shown, the selected item switches. Each time you press the key, the selected item switches one by one to the next item. When you finish the key operation, the item at that point is selected, and the pop-up menu automatically clears.

■ How to use the SHIFT key

The SHIFT key is used to switch the function of each key. If you press a key without holding down the SHIFT key, the function indicated above the key is enabled; if you press a key while holding down the SHIFT key, the function indicated below the key is enabled.

For example, if you press the SET/VSET key without holding down the SHIFT key, the SET/VSET (indicated in black) function is enabled. If you press the SET/VSET key while holding down the SHIFT key, the MENU (indicated in blue) is enabled.

This manual denotes the operation of holding down a key while holding down the SHIFT key as SHIFT+(notation above the key). For example, when selecting the MENU key, this manual denotes it as MENU (SHIFT+SET/VSET). In this case, press the SET/VSET key while holding down the SHIFT key.

Saving the setup conditions

You can use the memory function to save the settings that you are using. The ABC preset memories can save three separate sets of settings of each range of each operation mode. The setup memory can save 100 sets of the current setup condition and the contents of the ABC preset memories in that condition. The information saved to the memory is backed up even when the power is turned off (the information is saved until the PLZ-4W is initialized).

- For a description of the ABC preset memories, see section 6.1, "ABC preset memories." For a description of the setup memory, see section 6.2, "Setup Memory."
- For a description of initialization, see section 5.14, "Initialization."

Performing waveform simulation

The sequence function is used to perform waveform simulation. The sequence function automatically executes the time change of the waveform specified arbitrarily one operation at a time. The program information that you create is backed up even when the power is turned off.

- For a description of the sequence function, see section 6.6, "Sequence Function."

Maintenance and transportation after use

Before performing maintenance work, be sure to turn off the power and remove the power plug from the outlet or the power cord from the PLZ-4W.

- For details on maintenance, see chapter 8, "Maintenance and Calibration."
- **If the PLZ-4W requires repairs or readjustment, do not open the outer cover by yourself. Contact your Kikusui agent.**
- **When transporting the PLZ-4W, remove the power cord and cables, and use the original packing materials.**

3.3 Operating area of the PLZ-4W

As shown in Fig. 3-3, the PLZ-4W can be used within the area enclosed by the constant voltage line according to the rated voltage (L1), the constant power line according to the rated power (L2), the constant current line according to the rated current (L3), and the constant voltage line according to the minimum operating voltage (L4) (operating area where specifications are guaranteed). For PLZ-4Ws with the minimum operating voltage of 0 V, the specifications are guaranteed at input voltages at 0 V and greater. For 1.5 V input types, the specifications are guaranteed at input voltages of 1.5 V and greater. If the current is decreased, these types can be used even at voltages lower than 1.5 V. However, the specifications are not guaranteed. (Actual operating area)

Minimum voltage at which the current starts flowing to the PLZ-4W is approximately 0.3 V.

The PLZ-4W detects no signal at an input voltage less than or equal to approximately 0.3 V and an input current less than or equal to approximately 1 % of the range rating. If the input voltage is gradually increased from 0 V, no current will flow until 0.3 V is exceeded. Once a current greater than or equal to 1 % of the range rating (When PLZ-4W is set by the M range: greater than or equal to 1 % of H range) starts flowing, the current can flow at voltages less than equal to 0.3 V.

If the minimum operating voltage (L5) in the actual operating area is reached, the operating status on the display indicates C.R using outline characters (see section 4.4, "Display").

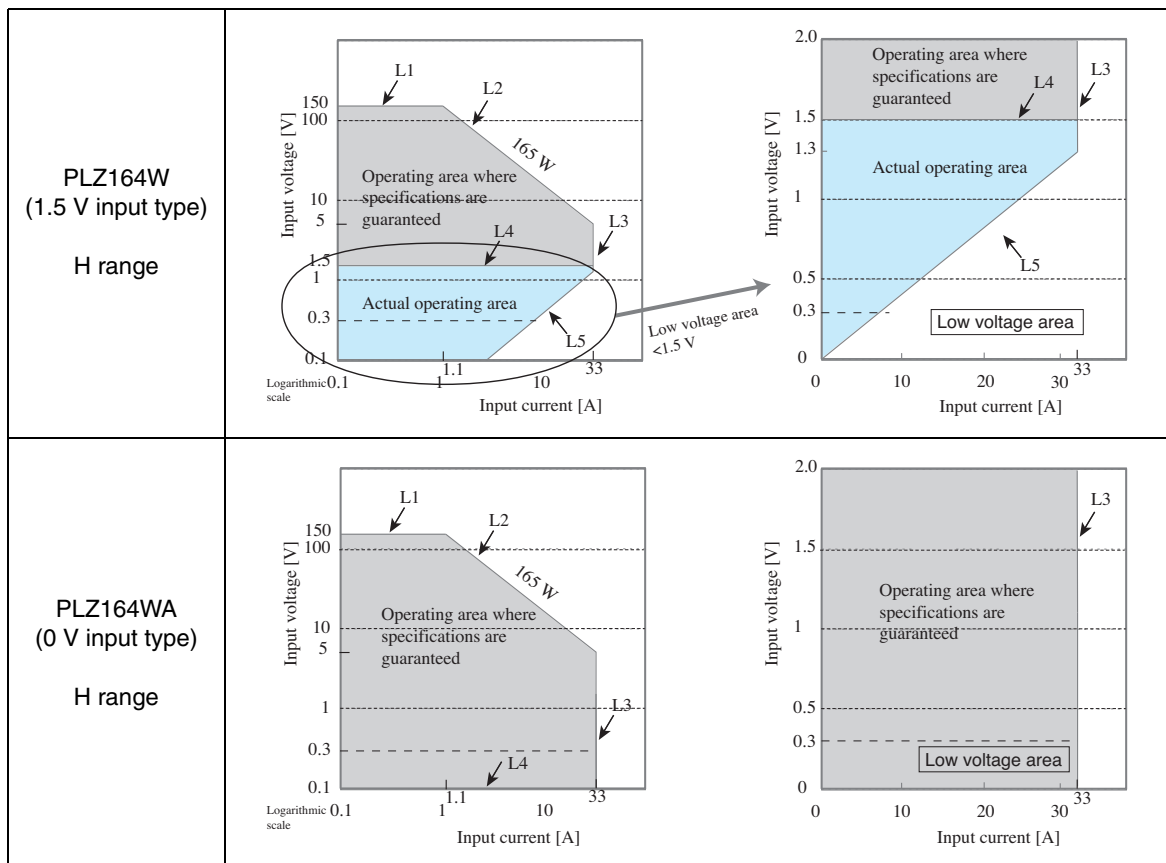

Fig. 3-3 Operating area

3.4 Basic Operation Modes

The following six operation modes are available on the PLZ-4W.

1. Constant current mode (CC mode)
2. Constant resistance mode (CR mode)
3. Constant power mode (CP mode)
4. Constant voltage mode (CV mode)
5. Constant current and constant voltage mode (CC+CV mode)
6. Constant resistance and constant voltage mode (CR+CV mode)

Below is a description of the most basic CC mode. For a detailed description, see appendix A.2, "Basic Operation Modes."

3.4.1 Operation of the CC Mode

In CC mode, the current is kept constant even when the voltage changes.

■ CC mode operation

When the PLZ-4W is used in CC mode, the PLZ-4W operates as a constant current load as shown in Fig. 3-4. The PLZ-4W sinks the specified current (I) independent of the output voltage of the constant-voltage power supply (V_1).

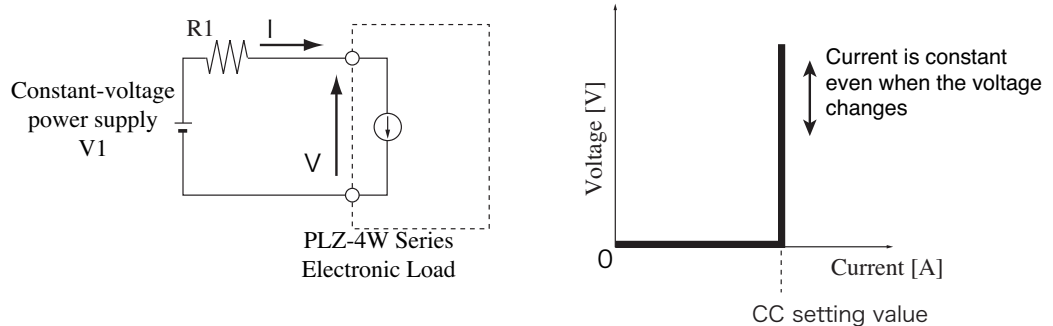

Fig. 3-4 Equivalent circuit of the constant current load and operation

■ Transition of the operating point

We will consider the case when checking the load characteristics of the constant-voltage power supply of Fig. 3-4 using CC mode.

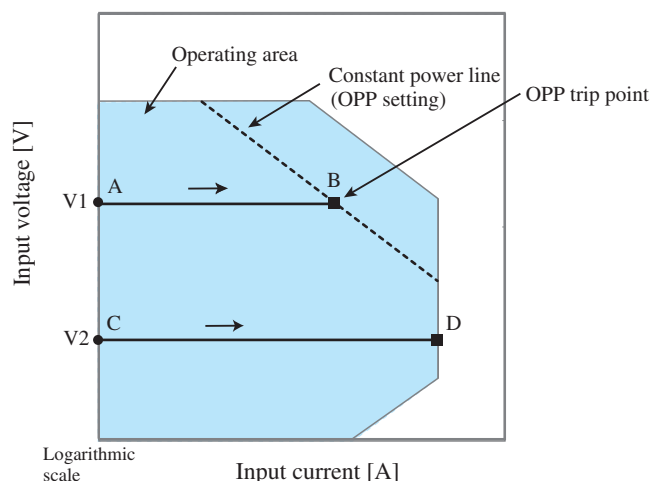

Fig. 3-5 Transition of the operating point in CC mode (OPP trip point)

Fig. 3-5: Operation on segment AB

If the voltage of the constant-voltage power supply is set to V1 and the input current (load current) of the PLZ-4W is increased, the operating point moves along segment AB.

When point B is reached, overpower protection (OPP) trips. At this point, two types of operation are available on the PLZ-4W depending on the protection action setting of the OPP.

If the protection action is set to LOAD OFF, an alarm screen indicating OPP appears, and the load turns off.

If protection action is set to LIMIT, the operating status indicates OPP, and the PLZ-4W sinks current as a constant power load at point B. Even if you attempt to increase the input current, the current is limited at point B. If you decrease the input current, the OPP is cleared, and the operating status indicates C.C. The PLZ-4W returns to CC mode, and the operating point moves along segment AB.

Table3-1 OPP action (protect action)

Point B	LOAD OFF	Turns off the load (stops the current flow). The PLZ-4W no longer operates as a load.
	LIMIT	CC mode ends. OPP continues, and the PLZ-4W sinks current as a constant power load.

Fig. 3-5: Operation on segment CD

If the voltage of the constant-voltage power supply is set to V2 and the input current (load current) of the PLZ-4W is increased, the operating point moves along segment CD. Point D is the maximum current at the range being used.

NOTE

- The OPP action (protection action) and the OPP value are set in advance. For a description of the action setting, see section 5.13, "Menu Setup." For a description of the OPP value setting, see section 5.4, "Setting the Protection Function." For a description of the operating status indication, see section 4.4, "Display."

3.4.2 Let's Use CC Mode

This section describes the procedure of setting the operation mode to CC and turning on the load. Below is the flow of the operating procedure. Please familiarize yourself with the keys used in this procedure.

■ Operating procedure and operation panel

- 1) Turn on the power and check that the load is turned off.
- 2) Set the operation mode, range, current value, and the OPP value.
- 3) Turn on the load.
- 4) Change the current value.
- 5) Turn the load off.

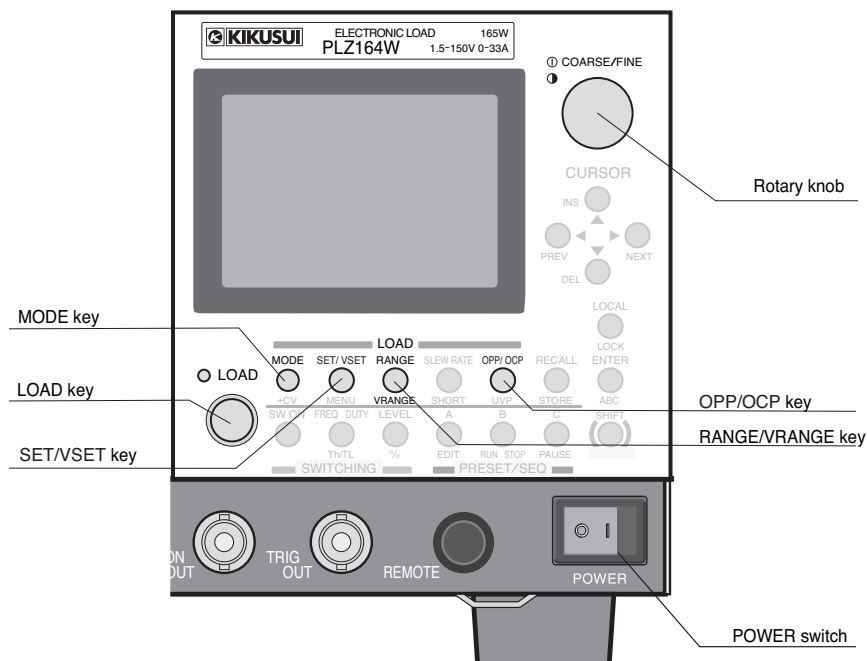

Fig. 3-6 Keys used in CC mode

■ Explanation of the operation

1. Turn on the power.

Push the (I) side of the POWER switch to turn on the power to the PLZ-4W. Check that the LOAD LED is turned off. If the LED is illuminated, press the LOAD key to turn off the load.

NOTE

- When the load is turned ON, you cannot switch the operation mode and range.

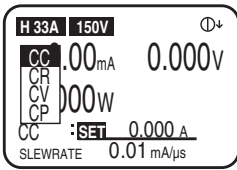

2. Select CC mode.

Press the MODE key to show the operation mode pop-up menu.

If CC is not highlighted, press the MODE key repetitively until CC is highlighted.

When the pop-up menu closes, check that CC appears on the display.

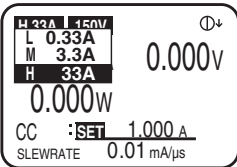

3. Select the current range.

Press the RANGE key to show the current range pop-up menu.

Each time you press the RANGE key while the menu is displayed, the current range switches in the order L (LOW), M (MIDDLE), and H (HIGH). When the desired range is highlighted, stop pressing the key.

Along with L, M, or H, the full scale value of the respective range is displayed. This value varies depending on the model.

4. Select the voltage range.

Press the VRANGE (SHIFT+RANGE) key to show the voltage range pop-up menu.

Each time you press the VRANGE key while the menu is displayed, the voltage range switches between 15 V and 150 V. When the desired range is highlighted, stop pressing the key.

5. Set the current value.

Press the SET/VSET key to illuminate the SET/VSET key.

While viewing the display, turn the rotary knob.

You can press the rotary knob to switch between coarse adjustment and fine adjustment. First, use coarse adjustment to roughly set the value, and then switch to fine adjustment to adjust the value precisely.

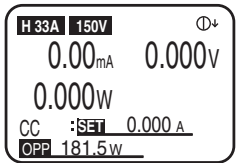

6. Set the OPP value.

Press the OPP/OCP key to illuminate the OPP/OCP key and show the OPP value on the display.

While viewing the display, turn the rotary knob.

You can press the rotary knob to switch between coarse adjustment and fine adjustment. First, use coarse adjustment to roughly set the value, and then switch to fine adjustment to adjust the value precisely.

7. Turn on the load.

Press the LOAD key to illuminate the LOAD LED and allow the current to flow.

At this point, the display shows the measured values (current, voltage, and power) at the load input terminal.

8. Change the current setting.

Turn the rotary knob while the load is turned on to change the current setting.

However, the current value cannot be set greater than the maximum value of the selected range.

9. Turn off the load.

Press the LOAD key to turn off the LOAD LED.

4



Chapter 4 Names and Functions of Parts

This chapter describes the names and functions of switches, connectors, and displays on the front panel and rear panel.

4.1 Front Panel

- ⚠ WARNING**
- Do not touch the load input terminal while the PLZ-4W is turned ON, as it may lead to electric shock.
In addition, be sure to use the load input terminal cover.
 - The load input terminals on the front and rear panels are coupled inside the PLZ-4W. A voltage applied to one end will appear on the other end.
- ⚠ CAUTION**
- Do not connect equipment to the load input terminals on the front and rear panels simultaneously, as it cause damage.
 - Avoid using the PLZ-4W in a dusty environment or an environment with poor ventilation.
 - Do not obstruct the air intake on the front panel and the air outlet on the rear panel.

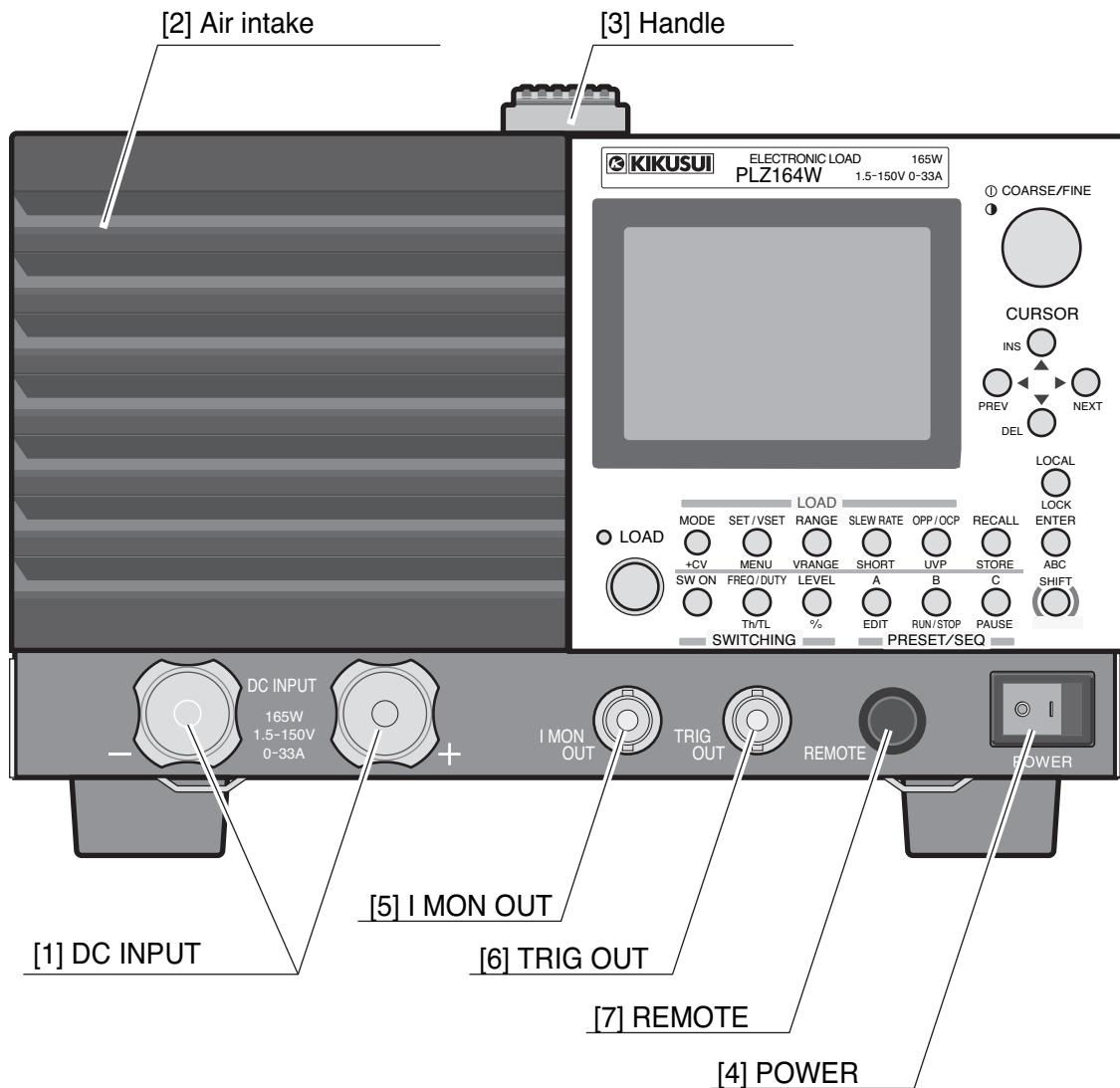

Fig.4-1 Front panel (PLZ164W)

[1] DC INPUT (load input terminal on the front panel)

The terminal on the front panel that can be used to easily connect the equipment under test and the PLZ-4W. The load input terminal is also available on the rear panel, and is connected in parallel with the load input terminal on the front panel.

- For the connection procedure, see section 2.8.3, “Connection to the Load Input Terminal on the Front Panel.”

NOTE

- The specifications of the PLZ-4W are for the load input terminal on the rear panel. The load input terminal on the front panel may not satisfy the specifications.
 - The maximum input current to the load input terminal on the front panel is 66 A. It is automatically limited to 66 A.
-

[2] Air intake (louver)

Takes in air to cool the inside of the PLZ-4W.

A dust filter is furnished on the inside. Clean the dust filter periodically.

- For details, see section 8.1.2, “Cleaning the Dust Filter.”

[3] Handle

Used to lift the PLZ-4W. The handle is provided on the side panel on the PLZ1004W and the PLZ664WA. It is provided on the top panel on other models.

[4] POWER switch

Power switch of the PLZ-4W. Push (I) to turn on, push (O) to turn off.

Turn the POWER switch on while holding down the ENTER key initializes the panel settings to factory default.

- For a description of turning on the power, see section 2.6, “Turning on The Power.”
- For a description of initial settings, see section 5.14, “Initialization.”

[5] I MON OUT connector

Output connector used to monitor the current. Connect a voltmeter or oscilloscope to monitor the current.

- For details, see section 6.9, “Monitor Signal Output.”

[6] TRIG OUT connector

Outputs pulse signals during sequence operation or switching operation.

- For details, see section 6.9, “Monitor Signal Output.”

[7] REMOTE connector

Connector for future functional expansion.

4.2 Rear Panel

- ⚠ WARNING**
- Do not touch the load input terminal while the PLZ-4W is turned ON, as it may lead to electric shock.
In addition, be sure to use the load input terminal cover.
 - The load input terminals on the front and rear panels are coupled inside the PLZ-4W. A voltage applied to one end will appear on the other end.
- ⚠ CAUTION**
- Do not connect equipment to the load input terminals on the front and rear panels simultaneously, as it cause damage.
 - Avoid using the PLZ-4W in a dusty environment or an environment with poor ventilation.
 - Do not obstruct the air intake on the front panel and air exhaust on the rear panel with objects. In particular, allow at least 20 cm of space behind the PLZ-4W.

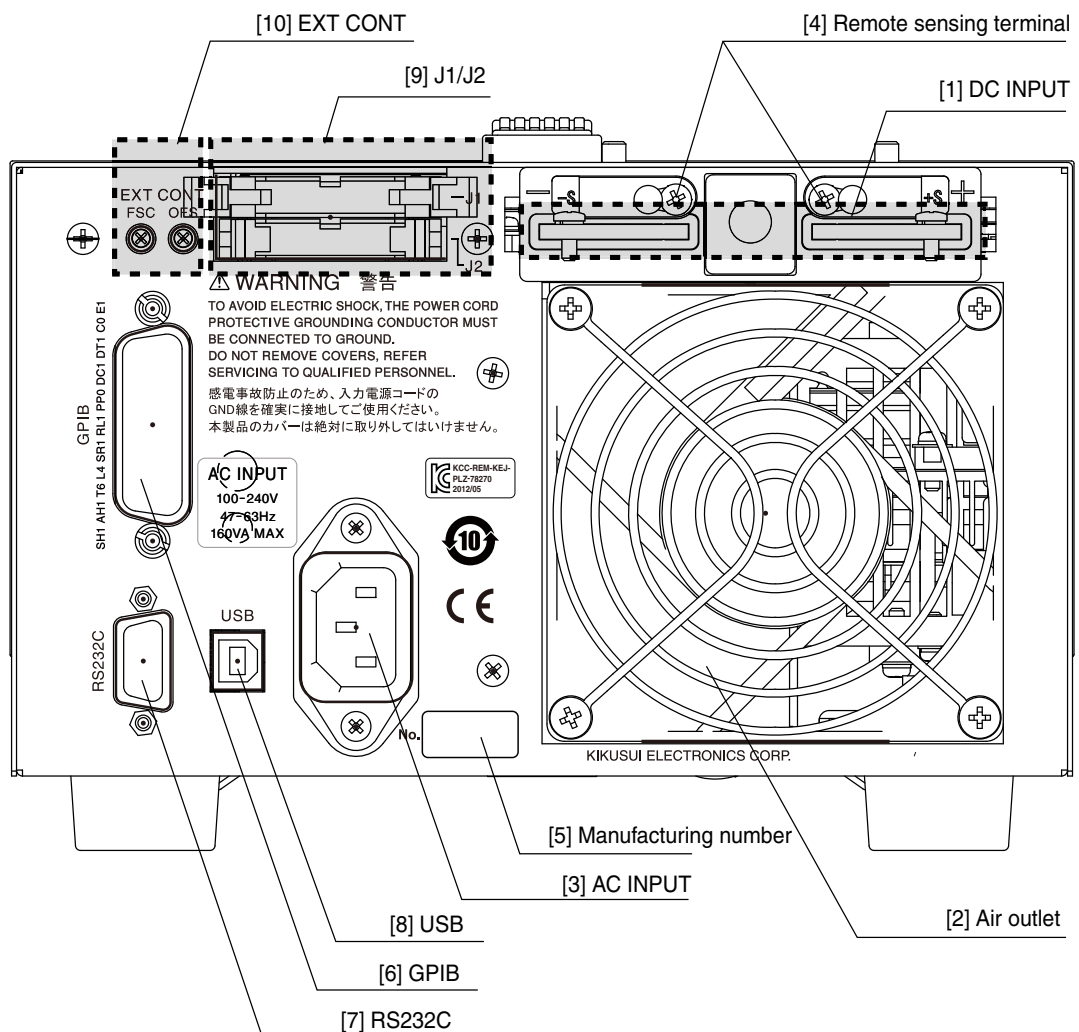

Fig. 4-2 Rear panel (PLZ164W)

[1] DC INPUT (load input terminal on the rear panel)

Terminal used to connect the equipment under test to the PLZ-4W. It is connected in parallel with the load input terminal on the front panel.

- For the connection procedure, see section 2.8.2, “Connection to the Load Input Terminal on the Rear Panel.”

[2] Air outlet

Exhausts the internal air using the cooling fan to cool the inside of the PLZ-4W.

[3] AC INPUT connector

Connector used to connect the power cord.

- For a description of the connection, see section 2.4, “Connecting the Power Cord.”

[4] Remote sensing terminal

Terminal used to connect the sensing wires when correcting the voltage drop caused by the resistance of the load wire.

- For details, see section 6.7, “Remote Sensing Function.”

[5] Manufacturing number (serial No.)

Manufacturing number of the PLZ-4W.

[6] GPIB connector

Connector used to connect the GPIB cable when controlling the PLZ-4W externally.

- For a description of the interface setup, see section 7.2.1, “GPIB Control.”

[7] RS232C connector

Connector used to connect the RS232C cable when controlling the PLZ-4W externally.

- For a description of the interface setup, see section 7.2.2, “RS232C Control.”

[8] USB connector

Connector used to connect the USB cable when controlling the PLZ-4W externally.

- For a description of the interface setup, see section 7.2.3, “USB Control.”

[9] J1/J2 connector

Input/Output connector used to control the PLZ-4W externally using external voltage, resistance, relay contact, etc.

J1 is assigned to external control; J2 is assigned to parallel operation.

- For details on external control and the connector, see section 6.8.1, “Overview and Precaution of External Control.”

[10] EXT CONT

Variable resistor used to adjust the full scale and offset settings of the PLZ-4W with respect to the input value of the external control source (voltage or resistance).

4.3 Operation Panel

If you press a key while holding down the SHIFT key, the function indicated below the key is enabled.

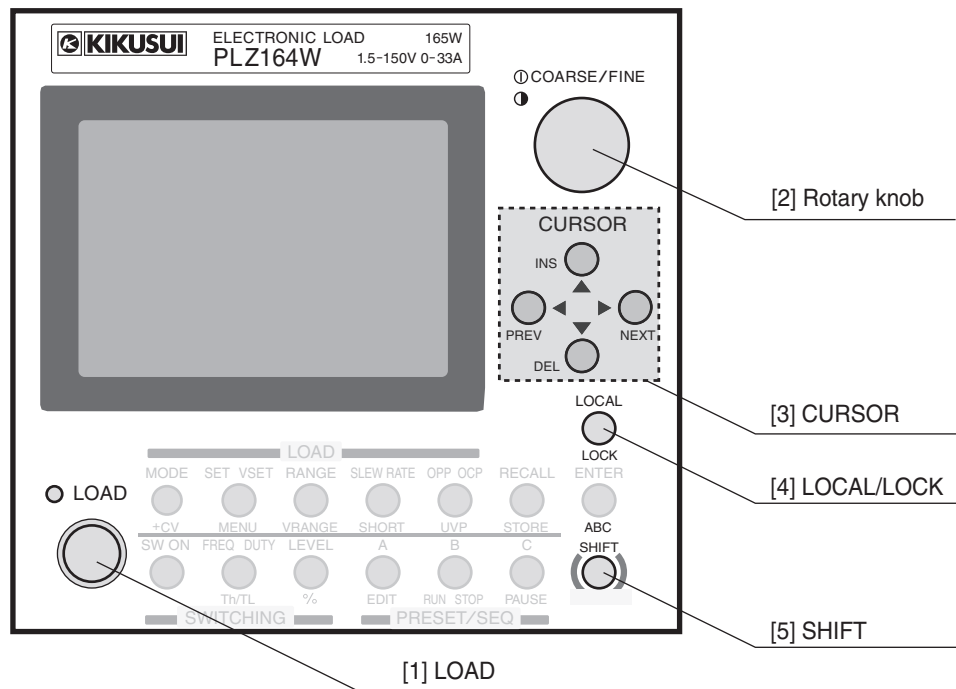

Fig. 4-3 Operation Panel

[1] LOAD key

The current that flows through the PLZ-4W is turned on and off each time you press the key. When the load is turned on, the LED illuminates (green).

[2] Rotary knob

The rotary knob is used to set various types of values on the PLZ-4W. By pressing the rotary knob you can switch between coarse adjustment and fine adjustment.

① COARSE/FINE

When set to coarse adjustment, “↓” appears on the screen. You can traverse the full scale of values by turning the rotary knob ten and a few turns. When set to fine adjustment, “↴” appears. The value changes at 1/10 of the rate of coarse adjustment.

● Contrast

You can change the display contrast by turning the rotary knob while holding down the SHIFT key.

[3] CURSOR key



Moves the cursor up and down or right and left when selecting an item on the menu screen.

INS/DEL/PREV/NEXT

Operate the keys while holding down the SHIFT key to turn pages (PREV/NEXT) on the menu screen or insert (INS) or delete (DEL) steps of the sequence function.

[4] LOCAL/LOCK key

LOCAL

Switches to panel control (local control) when the PLZ-4W is being controlled remotely.

LOCK

Pressing this key while holding down the SHIFT key (SHIFT+LOCAL) locks the PLZ-4W. Pressing the LOCK (SHIFT+LOCAL) key while the PLZ-4W is locked releases the lock. When releasing the lock, keep holding the key until a beep is heard.

- For details, see section 5.11, “Lock Function.”

[5] SHIFT key

Switches the function of each key. If you press a key without holding down the SHIFT key, the function indicated above the key is enabled; if you press a key while holding down the SHIFT key, the function indicated below the key is enabled.

[LOAD]

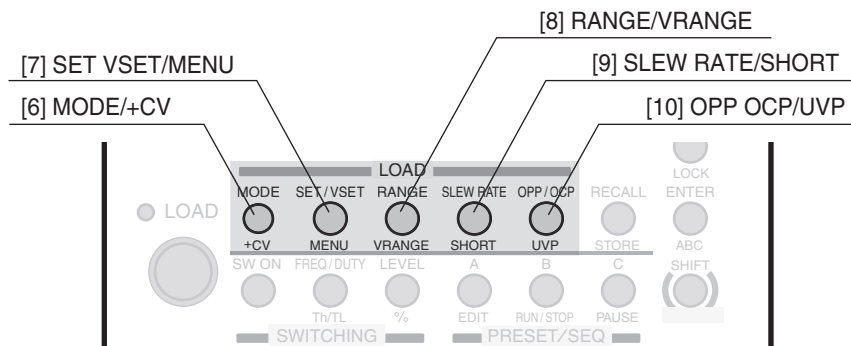

Fig. 4-4 Operation panel (LOAD)

[6] MODE/+CV key

MODE

Pressing this key when the load is turned off switches the operation mode.

Press the MODE key to show the operation mode pop-up menu. Each time you press the MODE key while the menu is displayed, the operation mode switches in the order CC, CR, CV, and CP.

When in switching mode (SW ON key is illuminated) or CC+CV or CR+CV mode, you cannot select the CV and CP operation modes on the pop-up menu. You cannot select the operation mode when the short function is enabled.

+CV

Pressing this key while holding down the SHIFT key (SHIFT+MODE) adds constant voltage mode (+CV) to CC mode or CR mode.

When in CC mode, this operation switches the mode to CC+CV; when in CR mode, this operation switches the mode to CR+CV. The current mode is indicated on the display.

[7] SET/VSET/MENU key

SET/VSET

Enters the basic setting (current, conductance, voltage, or power). This key illuminates when you can change the basic setting.

In CC+CV mode, current and voltage are selected alternately each time you press the key. In CR+CV mode, conductance and voltage are selected alternately each time you press the key.

MENU

Pressing this key while holding down the SHIFT key (SHIFT+SET VSET) shows the menu setup screen for setting the functions of the PLZ-4W and changing the settings.

- For details, see section 5.13, “Menu Setup.”

[8] RANGE/VRANGE key

RANGE

Switches the current, conductance, or voltage range according to the operation mode.

Pressing the RANGE key when the load is turned off shows the range pop-up menu. Each time you press the RANGE key while the menu is displayed, the range switches in the order L, M, and H. You cannot select the range when the load is turned on or when the short function is enabled.

VRANGE

Pressing this key while holding down the SHIFT key (SHIFT+RANGE) switches the voltage range.

Pressing the VRANGE (SHIFT+RANGE) key when the load is turned off shows the range pop-up menu. Each time you press the VRANGE (SHIFT+RANGE) key while the menu is displayed, the range switches in the order 15 V and 150 V. You cannot select the range when the load is turned on or when the short function is enabled.

[9] SLEW RATE/SHORT key

SLEW RATE

Sets the slew rate value. This key illuminates when you can change the slew rate. You cannot select the slew rate in CV or CP mode.

- For details, see section 6.4, “Setting the Slew Rate.”

SHORT

Pressing this key while holding down the SHIFT key (SHIFT+SLEW RATE) sets or clears the short function. A short icon is displayed while the short function is enabled. You cannot select the short function in switching, CV, or CP mode.

- For details, see section 5.12, “Short Function.”

[10] OPP/OCP/UVP key

OPP/OCP

Sets the voltage for tripping the overpower protection (OPP) or the current for tripping the overcurrent protection (OCP). This key illuminates when you can set the OPP or OCP.

- For details, see section 5.4, “Setting the Protection Function.”

UVP

Pressing this key while holding down the SHIFT key (SHIFT+OPP/OCP) enables you to set the voltage for tripping the undervoltage protection (UVP).

- For details, see section 5.4, “Setting the Protection Function.”

[SWITCHING]

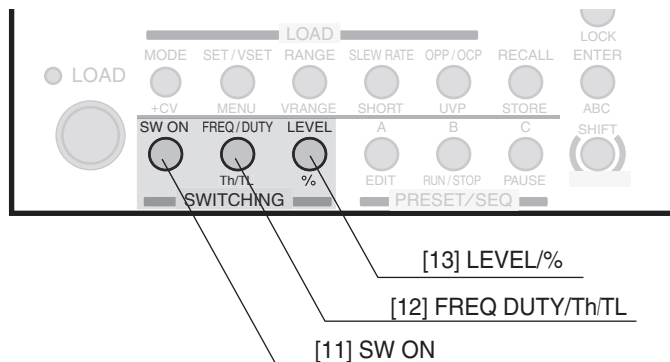

Fig. 4-5 Operation panel (SWITCHING)

[11] SW ON key

Turns on or off the switching mode. The switching mode is valid in CC mode or CR mode. The SW ON key illuminates in switching mode. You cannot select switching mode when the short function is enabled.

- For details, see section 6.3, “Switching Function.”

[12] FREQ/DUTY/Th/TL key

FREQ/DUTY

Sets the switching frequency and duty cycle in switching operation. This key illuminates when you can set the switching frequency or duty cycle. FREQ and DUTY settings switch each time you press the key.

Th/TL

Pressing this key while holding down the SHIFT key (SHIFT+FREQ DUTY) enables you to set the switching time (Th: High side, TL: Low side) in switching operation. This key illuminates when you can change the switching time. Th and TL settings switch each time you press the key. You cannot select the switching time in CV or CP mode.

[13] LEVEL/% key

LEVEL

Sets the switching level in switching operation. This key illuminates when you can change the switching level.

%

Pressing this key while holding down the SHIFT key (SHIFT+LEVEL) enables you to set the switching level in terms of a percentage (0.0 % to 100.0 %) of the current setting. This key illuminates when you can change the switching level. You cannot select the switching level in CV or CP mode.

[PRESET/SEQ]

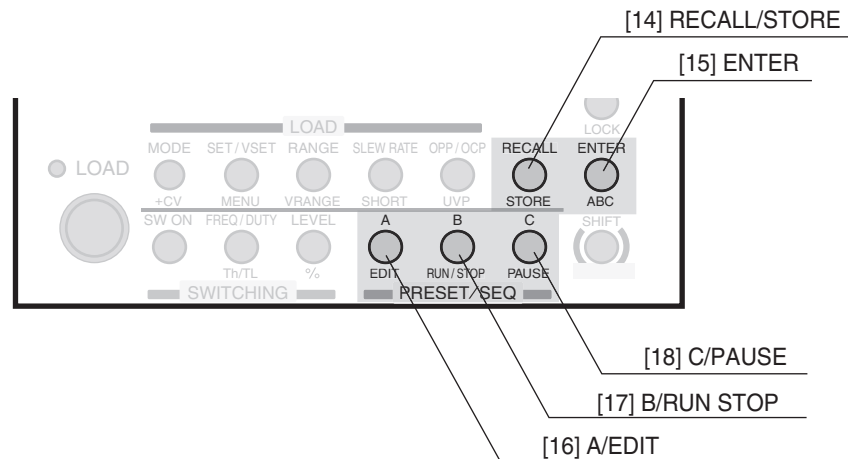

Fig. 4-6 Operation panel (PRESET/SEQ)

[14] RECALL/STORE key

RECALL

Recalls the panel settings saved to the setup memory. You cannot select this key when the load is turned on.

- For details, see section 6.2, "Setup Memory."

STORE

Pressing this key while holding down the SHIFT key (SHIFT+RECALL) saves the current panel settings to the setup memory.

[15] ENTER/ABC key

ENTER

Confirms various types of values during menu setup.

- Pressing the ENTER key when an alarm is activated resets the alarm. However, the alarm will be activated again if you do not correct the cause of the alarm.

ABC

Pressing this key while holding down the SHIFT key (SHIFT+ENTER) saves the current settings to the ABC preset memories.

- For details, see section 6.1, “ABC preset memories.”

[16] A/EDIT key

A

Use this key to recall the settings stored in memory A or save the current settings to memory A.

EDIT

Pressing this key while holding down the SHIFT key (SHIFT+A) shows the sequence edit screen.

- For details, see section 6.6, “Sequence Function.”

[17] B/RUN/STOP key

B

Use this key to recall the settings stored in memory B or save the current settings to memory B.

RUN/STOP

Pressing this key while holding down the SHIFT key (SHIFT+B) shows the sequence execution screen. Pressing RUN/STOP (SHIFT+B) when sequence operation is being executed aborts the operation.

[18] C/PAUSE key

C

Use this key to recall the settings stored in memory C or save the current settings to memory C.

PAUSE

Pressing this key while holding down the SHIFT key (SHIFT+C) pauses the sequence being executed. Pressing the PAUSE (SHIFT+C) key when the operation is paused resumes the sequence.

4.4 Display

You can change the display contract by turning the rotary knob while holding down the SHIFT key. The contrast setting is backed up even when the power is turned off.

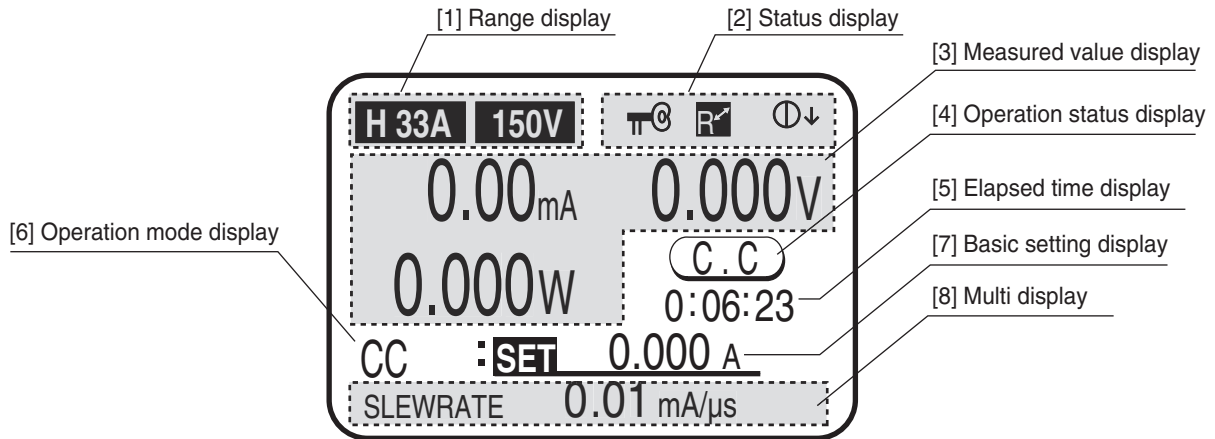

Fig. 4-7 Display

[1] Range display

Displays the current and voltage range.

[2] Status display

Displays (from the left) the lock, remote, and rotary knob coarse/fine adjustment status.

[3] Measured value display

Displays the measured values of current (A), voltage (V), and wattage (W).

[4] Operation status display

Displays the current operation mode when the load is turned on.

[5] Elapsed time display

Displays the elapsed time since the load was turned on.

By factory default, the elapsed time display (Count Time) is turned off (not shown). To show the elapsed time, turn it on from the menu settings. You can also automatically turn off the load after a specified time elapses after the load is turned on (Cut Off).

- For details of menu setup, see section 5.13, "Menu Setup."

[6] Operation mode display

Displays the specified operation mode.

[7] Setup display

Displays the basic setting in the specified operation mode.

[8] Multi display

Displays various settings and current status according to the condition.

5

Chapter 5 Basic Operation

This chapter describes the operating procedure of each operation mode and other basic functions.

5.1 Panel Control Basics

The PLZ-4W is controlled from the operation panel on the front panel. If you make an invalid selection or perform an invalid key operation, a beep is sounded to notify the error. In particular, please familiarize yourself with the use of the SHIFT key that changes the key function.

- For a description of the functions of each key, see chapter 4, “Names and Functions of Parts.”

■ Function of the LOAD key

If you press the LOAD key when the load is turned off, the LOAD LED illuminates, and the load turns on. If you press the LOAD key when the load is turned on, the LOAD LED turns off, and the load turns off.

■ How to use the rotary knob

The rotary knob is used when setting values such as the current and resistance. Turning the rotary knob to the right increases the value and turning it to the left decreases the value. In addition, you can press the rotary knob to switch between coarse adjustment and fine adjustment. When the ↓ shown at the upper right corner of the screen is large, coarse adjustment is active; when it is small, fine adjustment is active. When setting a value, use coarse adjustment to set the value roughly, and then switch to fine adjustment to set value precisely.

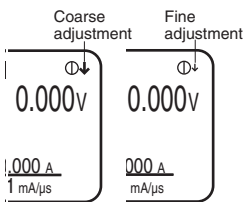

NOTE

- Fine adjustment changes values at 1/10 of the rate of coarse adjustment. When you turn the rotary knob while pressing the LOCAL key in the coarse adjustment, you can set the value more roughly.

■ Pop-up menu operation

Some keys show a pop-up menu when you press the keys. If you press the key again while the menu is shown, the selected item switches. Each time you press the key, the selected item switches one by one to the next item. When you finish the key operation, the item at that point is selected, and the pop-up menu automatically clears.

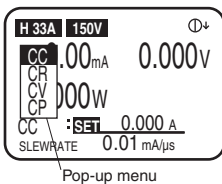

■ How to use the SHIFT key

The SHIFT key is used to switch the function of each key. If you press a key without holding down the SHIFT key, the function indicated above the key is enabled; if you press a key while holding down the SHIFT key, the function indicated below the key is enabled.

For example, if you press the SET/VSET key without holding down the SHIFT key, the SET/VSET (indicated in black) function is enabled. If you press the SET/VSET key while holding down the SHIFT key, the MENU (indicated in blue) is enabled.

This manual denotes the operation of pressing a key while holding down the SHIFT key as SHIFT + (notation above the key). For example, when selecting the MENU key, this manual denotes it as MENU (SHIFT + SET/VSET). In this case, press the SET/VSET key while holding down the SHIFT key.

5.2 Turning On or Off the Load

“Turning on the load” refers to the operation of supplying current to the PLZ-4W. “Turning off the load” refers to the operation of cutting off the current to the PLZ-4W. The LOAD key is used to turn on or off the load. Please remember the expression “turning on the load” and “turning off the load”, as they are used frequently in this manual.

⚠ CAUTION • When the step-by-step procedure to turning on/off the load was incorrectly performed, it may cause the damage to the PLZ-U. Be sure to follow the procedure as instructed to turning on/off the load.

Load On

1. Check that load is turned off.
2. Apply the output of the DUT to the input of the PLZ-U. In case the relay or the electromagnetic switch is used for the connection between the load input terminal and the output terminal of the DUT, turn on the relay or the electromagnetic switch.
3. Press the LOAD key to turn on the load.

Load Off

1. Press the LOAD key to turn off the load.
2. Turn off the output of the DUT. In case the relay or the electromagnetic switch is used for the connection between the load input terminal and the output terminal of the DUT, turn on the relay or the electromagnetic switch.

Functions related to turning on or off of the load

The PLZ-4W provides the following functions related to the turning on or off of the load.

■ Starting with the load turned on

By factory default, the load is not turned on unless you press the LOAD key after turning on the POWER switch.

If you select “2. Configuration” | “2. Power On” from the menu and set the Load On setting to on, the load is turned on when you turn on the POWER switch.

- For a description of changing the menu setup, see section 5.13, “Menu Setup.”

■ Displaying the elapsed time after the load is turned on

By default, the elapsed time after the load is turned on is not displayed.

If you select “1. Setup” | “1. Function” from the menu and set the Count Time setting to on, the time from load on to load off can be displayed.

This function is useful when used in conjunction with the UVP in the discharge test of batteries and capacitors.

- For a description of changing the menu setup, see section 5.13, “Menu Setup.”

■ Turning off the load after a specified time elapses

By default, the load on timer is off.

If you select “1. Setup” | “4. Cut Off” from the menu and set the time in “Time,” the load automatically turns off after a specified time elapses after the load is turned on.

When the load turns off, a pop-up window appears indicating the input voltage at the time the load was turned off. This function is useful in discharge tests of batteries and capacitors.

- For a description of changing the menu setup, see section 5.13, “Menu Setup.”

■ Turning on or off the load externally

You can also turn on or off the load using an external signal through a relay or other similar methods.

- For a description of external control, see section 6.8.7, “External Control of Load On and Load Off.”

■ Starting up the input current of the PLZ-4W responds to follow the rise time of the output voltage

In the constant current (CC) mode and the constant resistance (CR) mode, you can set to start up slowly of the input current of the load (soft start).

- For a description of soft-start, see section 5.10, “Soft start.”

When the DC power supply and the DUT are connected in series, and turning on/off of the DUT. (PLZ164WA/PLZ664WA only)

The following describes for testing the DUT (in CC mode) when the DUT (an open-close device such as a switch) is connected between the load input terminal of the PLZ-4W and the output of the DC power supply.

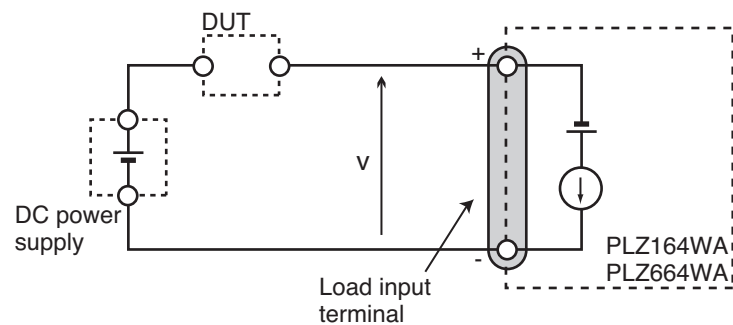

Fig.5-1 Connecting the DC power supply and the DUT in series

As for the type of 0 V input model PLZ164WA/PLZ664WA, when the connection between the DC power supply and the PLZ164WA/PLZ664WA is opened circuit, a reverse voltage is applied to the load input terminal, and the alarm is occurred to turn off the load by the reverse-connection detection (REV). For the REV, see section 5.3, "Types of Protection Functions."

■ To avoid the occurrence of alarm by the reverse-connection detection (REV)

To avoid the occurrence of alarm by the REV, set the operation mode to the "CC+CV" mode, then it is necessary to set the voltage value of the CV at lower than the voltage "V" specified in the Fig. 5-1 when the current flows. The alarm can not be avoided in the CC mode. For the operation mode, see section 5.5, "Operation Modes."

1. Turn off the DUT.
2. Set the operation mode of the PLZ-4W to the "CC+CV" mode.
3. Set the voltage of the CV for approximately 1 V lower than the output voltage of the DC power supply.
For the setting of voltage, see "Operating procedure of CC+CV mode" in section 5.6, "CC Mode."
4. Set the current of the CC complied to the condition of the DC power supply.
5. Press the LOAD key to turn on the load.
6. Turn on the output of the DC power supply.
7. Turn on the DUT.
8. Turn off the DUT when the test is finished.

Even when you follow the procedure specified above, the alarm may occurs, in such case, it may be required to change the voltage setting of CV to prevent the alarm occurrence. For details, contact your Kikusui agent or distributor.

5.3 Types of Protection Functions

The protection function automatically turns off or limits the load when an input that can damage the internal circuit of the PLZ-4W appears and to protect the equipment under test.

When a protection function trips, an alarm is activated. When an alarm is activated, the load is turned off (or limited), and the ALARM STATUS of the J1 connector on the rear panel (pin 16) turns on (open collector output by a photocoupler).

There are two types of protection functions: those that allow you to set the trip point and those with a fixed trip point. In addition, for the OCP and the OPP, you can specify whether to turn off or limit the load when the protection trips.

- For the operation of the protection function in each operation mode, see appendix A.2, “Basic Operation Modes.”

Overcurrent protection (OCP)

The protection trips when a current that is equal to or exceeds the specified overcurrent value or 110 % of the maximum current of each range flows. At this point, the load is turned off (LOAD OFF) or the current is limited (LIMIT).

To change the protect action, select “1. Setup” | “2. Protect Action” | “OCP” and specify LIMIT or LOAD OFF.

When LIMIT is specified, the alarm is cleared when the alarm condition is corrected.

- For a description of setting the overcurrent value, see section 5.4, “Setting the Protection Function.”
- For a description of changing the menu setup, see section 5.13, “Menu Setup.”

Overvoltage protection (OVP)

The protection trips when a voltage that is equal to or exceeds 110 % of the maximum input voltage is applied. At this point, the load is turned off.

Overpower protection (OPP)

The protection trips when a power that is equal to or exceeds the specified overpower value or 110 % of the maximum power of each range is applied. At this point, the load is turned off (LOAD OFF) or the current is limited (LIMIT).

To change the protect action, select “1. Setup” | “2. Protect Action” | “OPP” and specify LIMIT or LOAD OFF.

When LIMIT is specified, the limit is cleared when the alarm condition is corrected.

- For a description of setting the overpower value, see section 5.4, “Setting the Protection Function.”
- For a description of changing the menu setup, see section 5.13, “Menu Setup.”

Undervoltage protection (UVP)

The protection trips when the voltage that is equal to or falls below the specified voltage. At this point, the load is turned off. The undervoltage protection can be disabled (OFF).

- For a description of setting the undervoltage value, see section 5.4, “Setting the Protection Function.”

Reverse-connection detection (REV)

The protection trips when a reverse voltage is applied to the load input terminal. At this point, the load turns off.

In this case, turn off the power of the equipment under test within 30 seconds after the protection detects a reverse voltage.

For the PLZ164WA or the PLZ664WA, when the REV activates while the test connecting with the DC power supply and the DUT in series, see “When the DC power supply and the DUT are connected in series, and turning on/off of the DUT. (PLZ164WA/PLZ664WA only)” in section 5.2, “Turning On or Off the Load.”

Overheat protection (OHP)

The protection trips when the temperature inside the power unit exceeds 95 °C. At this point, the load is turned off.

Check whether the air intake on the front panel and the air outlet on the rear panel are being obstructed.

Alarm input protection

The protection trips when a low level (TTL) signal is applied to the ALARM INPUT (pin 10) of the J1 connector on the rear panel.

Reset the alarm on the equipment connected to external control, and then reset the alarm on the PLZ-4W.

■ Clearing alarms

You can press the ENTER key when an alarm is activated to reset the alarm. However, note that the alarm will be activated again, if the cause of the alarm is not corrected.

5.4 Setting the Protection Function

You can set trip points for the OCP, OPP, and UVP.

■ Setting the OPP and OCP

The OPP and the OCP activate an alarm and turn off the load or limit the power or current when overpower or overcurrent occurs. When LOAD OFF is specified, a pop-up window appears when an alarm is activated.

By default, the PLZ-4W is set up to limit the power or current. The protect action is specified from the menu.

- For a description of changing the menu setup, see section 5.13, “Menu Setup.”

1. With the load turned off, check the operation mode.

OCP is not indicated in CC mode.

OPP is not indicated in CP mode.

2. Select OPP or OCP.

Press the OPP/OCP key.

The OPP/OCP key illuminates.

3. Select the one you wish to set.

Select OPP or OCP.

OPP or OCP is highlighted each time you press the OPP/OCP key. Highlight the one you wish to set.

4. Set the overpower or overcurrent value.

While viewing the display, turn the rotary knob to set the value.

■ Setting the UVP

When the input voltage that is equal to or falls below the specified value, an alarm is activated, the load is turned off, and a pop-up window appears. If the Count Time setting is on, the time from load on to load off is displayed in the pop-up window.

1. Select UVP.

Press the UVP (SHIFT+OPP/OCP) key.

The UVP key illuminates.

2. Set the undervoltage value.

While viewing the display, turn the rotary knob to set the value.

If you are not using the undervoltage protection, select OFF.

5.5 Operation Modes

The following four operation modes are available on the PLZ-4W. Furthermore, constant voltage mode (+CV) can be added to CC and CR modes.

- Constant current mode (CC mode and CC+CV mode)
- Constant resistance mode (CR mode and CR+CV mode)
- Constant voltage mode (CV mode)
- Constant power mode (CP mode)

■ Switching operation modes

You can switch the operation mode by pressing the MODE key when the load is turned off. Press the MODE key to show the operation mode pop-up menu. Each time you press the MODE key while the menu is displayed, the selected item switches one by one to the next item.

When you finish the key operation, the operation mode at that point is selected, and the pop-up menu automatically clears. The operation mode is indicated on the display.

By pressing +CV (SHIFT+MODE) in CC mode or CR mode, you can add CV mode.

The figure below shows the transition of operation modes.

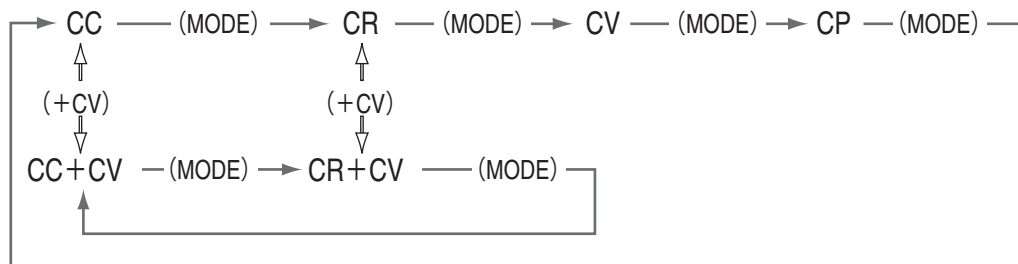

Fig. 5-2 Transition of operation modes

NOTE

- You can add +CV mode even when the load is turned on.
-

5.6 CC Mode

In CC mode, you set the current [A]. You can also add +CV mode to CC mode.

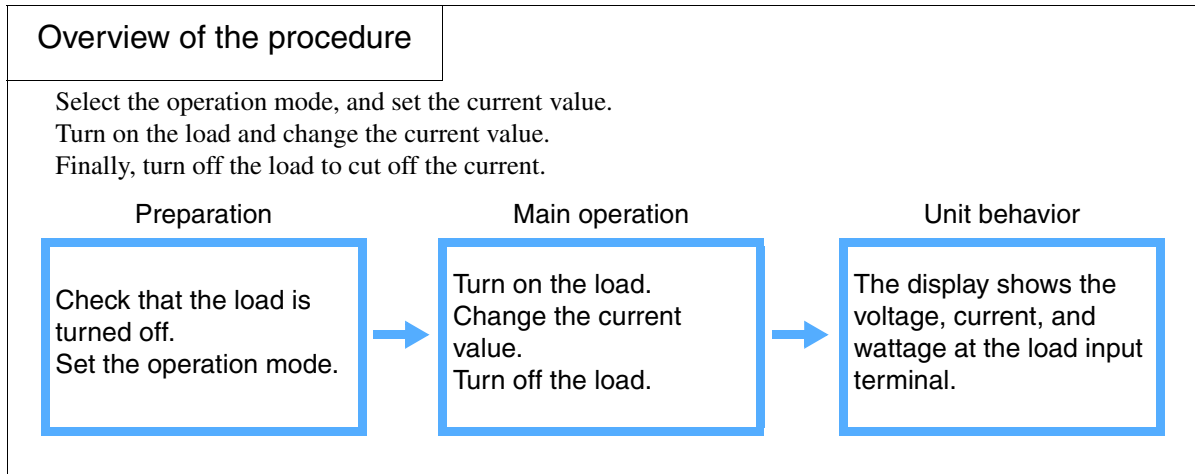

■ Operating procedure of CC mode

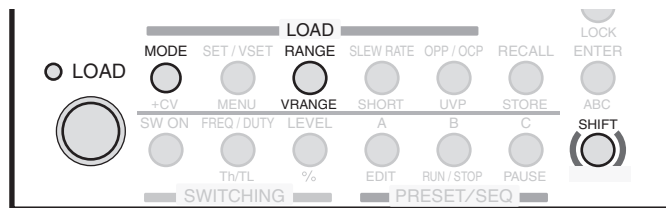

Fig. 5-3 Keys used in CC mode

1. Check that the load is turned off.
Check that the LOAD LED is turned off. If it is on, press the LOAD key to turn it off.
2. Select the operation mode.
Press the MODE key.
An operation mode pop-up menu appears.
Press the MODE key repetitively until CC is highlighted on the menu.
After selecting the operation mode, check that CC is indicated on the display.
3. Select the current range.
Press the RANGE key.
A current range pop-up menu appears.
Each time you press the RANGE key while the menu is displayed, the range switches in the order L, M, and H.
When the desired range is highlighted, stop pressing the key.
Along with L, M, or H, the full scale value of the respective range is displayed. This value varies depending on the model.

4. Select the voltage range.

Press the VRANGE (SHIFT+RANGE) key.

A voltage range pop-up menu appears.

Each time you press the VRANGE key, the voltage range switches between 15 V and 150 V.

When the desired range is highlighted, stop pressing the key.

5. Set the current value.

Check that the display is in the basic setting entry condition (the characters “SET” is highlighted).

While viewing the display, turn the rotary knob.

First, use coarse adjustment to roughly set the value, and then switch to fine adjustment to adjust the value precisely.

6. Turn on the load.

Press the LOAD key.

The LOAD LED illuminates, and the current flows.

The display shows the measured values (voltage, current, and wattage) at the load input terminal.

7. Change the current setting.

Turn the rotary knob to change the current setting.

The current value cannot be set greater than the maximum value of the selected range.

8. Turn off the load.

Press the LOAD key.

The LOAD LED turns off, and the current is cut off.

■ Operating procedure of CC+CV mode

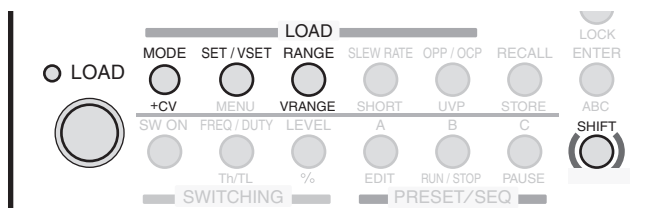

Fig. 5-4 Keys used in CC+CV mode

1. Check the operation mode.

Check that CC is indicated on the display.

2. Select the operation mode.

Press the +CV (SHIFT+MODE) key.

The mode switches to CC+CV.

Check that CC+CV is indicated on the display.

3. Select the current range and voltage range.

Press the RANGE key to select the current range.

Press the VRANGE (SHIFT+RANGE) key to select the voltage range.

4. Set the current and voltage values.

Check that the display is in the basic setting entry condition (the characters "SET" is highlighted).

While viewing the display, turn the rotary knob.

To switch between current and voltage settings, press the SET/VSET key.

5. Turn on the load.

Press the LOAD key.

The LOAD LED illuminates, and the current flows.

The display shows the measured values (voltage, current, and wattage) at the load input terminal.

6. Change the current or voltage setting.

Turn the rotary knob to change the setting.

To switch between current and voltage settings, press the SET/VSET key.

7. Turn off the load.

Press the LOAD key.

The LOAD LED turns off, and the current is cut off.

5.7 CR Mode

In CR mode, you set the conductance [S], an inverse of the resistance. The resistance calculated from the conductance is also displayed.

- Conductance [S] = 1/resistance [Ω]

You can also add +CV mode to CR mode. In CR+CV mode, only the conductance is displayed.

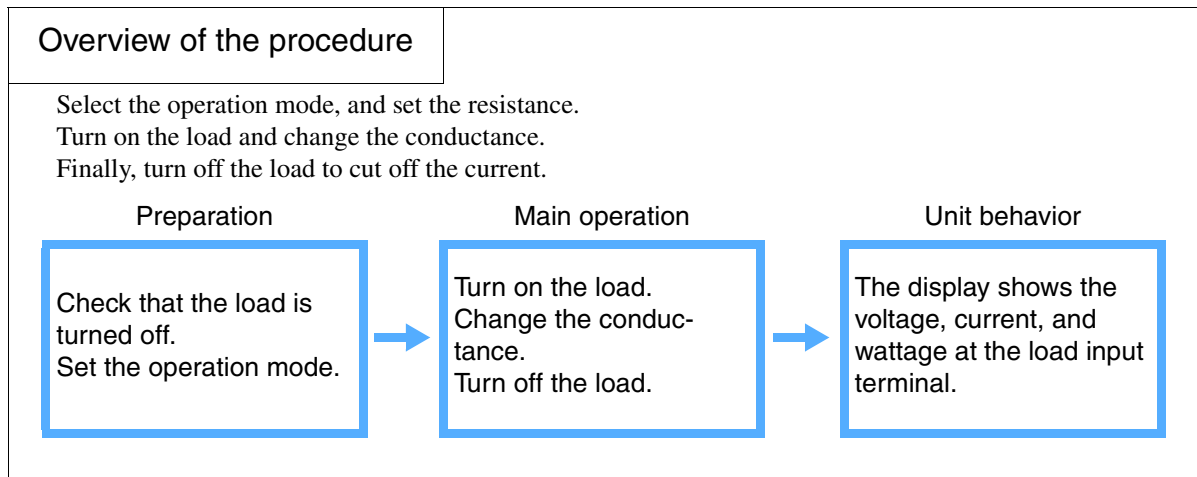

■ Operating procedure of CR mode

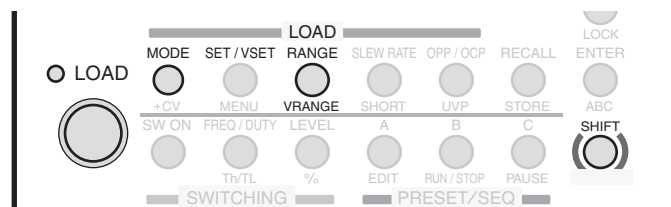

Fig. 5-5 Keys used in CR mode

1. Check that the load is turned off.
Check that the LOAD LED is turned off. If it is on, press the LOAD key to turn it off.
2. Select the operation mode.
Press the MODE key.
An operation mode pop-up menu appears.
Press the MODE key repetitively until CR is highlighted on the menu.
After selecting the operation mode, check that CR is indicated on the display.

3. Select the current and conductance range.

Press the RANGE key.

A current range pop-up menu appears.

Each time you press the RANGE key while the menu is displayed, the range switches in the order L, M, and H.

When the desired range is highlighted, stop pressing the key.

Along with L, M, or H, the full scale value of the respective range is displayed. This value varies depending on the model.

You cannot select separately the range for current and conductance.

4. Select the voltage range.

Press the VRANGE (SHIFT+RANGE) key.

A voltage range pop-up menu appears.

Each time you press the VRANGE key, the voltage range switches between 15 V and 150 V.

When the desired range is highlighted, stop pressing the key.

5. Set the conductance [S].

Check that the display is in the basic setting entry condition (the characters "SET" is highlighted).

While viewing the display, turn the rotary knob.

First, use coarse adjustment to roughly set the value, and then switch to fine adjustment to adjust the value precisely.

When you press the SET/VSET key, the resistance calculated from the conductance is indicated at the multi display.

6. Turn on the load.

Press the LOAD key.

The LOAD LED illuminates, and the current flows.

The display shows the measured values (voltage, current, and wattage) at the load input terminal.

7. Change the conductance setting.

Turn the rotary knob to change the conductance setting.

The conductance cannot be set greater than the maximum value of the selected range.

8. Turn off the load.

Press the LOAD key.

The LOAD LED turns off, and the current is cut off.

■ Operating procedure of CR+CV mode

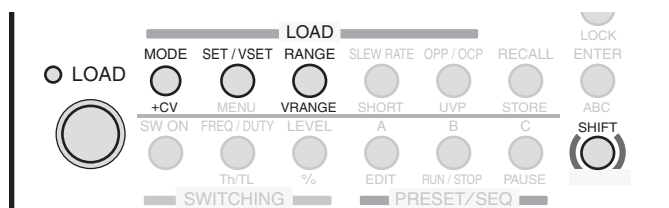
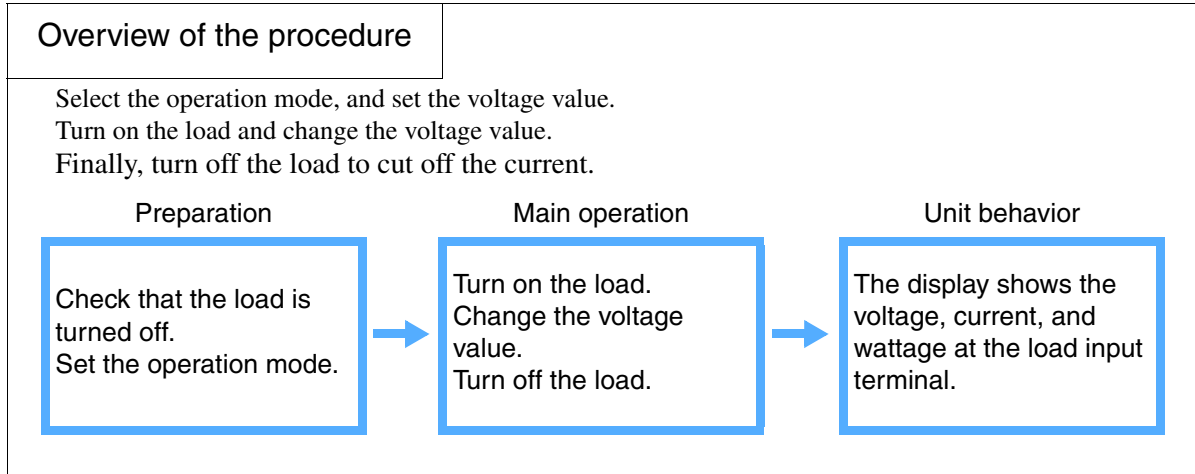

Fig. 5-6 Keys used in CR+CV mode

1. Check the operation mode.
Check that CR is indicated on the display.
2. Select the operation mode.
Press the +CV (SHIFT+MODE) key.
The mode switches to CR+CV.
Check that CR+CV is indicated on the display.
3. Select the current range and voltage range.
Press the RANGE key to select the current range.
Press the VRANGE (SHIFT+RANGE) key to select the voltage range.
4. Set the conductance and voltage.
Check that the display is in the basic setting entry condition (the characters "SET" is highlighted).
While viewing the display, turn the rotary knob.
To switch between conductance and voltage settings, press the SET/VSET key.
5. Turn on the load.
Press the LOAD key.
The LOAD LED illuminates, and the current flows.
The display shows the measured values (voltage, current, and wattage) at the load input terminal.
6. Change the conductance setting.
Turn the rotary knob to change the conductance setting.
The conductance cannot be set greater than the maximum value of the selected range.
7. Turn off the load.
Press the LOAD key.
The LOAD LED turns off, and the current is cut off.

5.8 CV Mode

In CV mode, you set the Voltage [V].



■ Operating procedure of CV mode

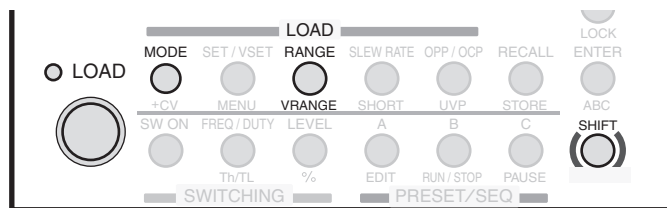

Fig. 5-7 Keys used in CV mode

1. Check that the load is turned off.
Check that the LOAD LED is turned off. If it is on, press the LOAD key to turn it off.
2. Select the operation mode.
Press the MODE key.
An operation mode pop-up menu appears.
Press the MODE key repetitively until CV is highlighted on the menu.
Check that CV is indicated on the display.
3. Select the current range.
Press the RANGE key.
A current range pop-up menu appears.
Each time you press the RANGE key while the menu is displayed, the range switches in the order L, M, and H.
When the desired range is highlighted, stop pressing the key.
Along with L, M, or H, the full scale value of the respective range is displayed. This value varies depending on the model.

4. Select the voltage range.

Press the VRANGE (SHIFT+RANGE) key.

A voltage range pop-up menu appears.

Each time you press the VRANGE key, the voltage range switches between 15 V and 150 V.

When the desired range is highlighted, stop pressing the key.

5. Set the voltage value.

Check that the display is in the basic setting entry condition (the characters “SET” is highlighted).

While viewing the display, turn the rotary knob.

First, use coarse adjustment to roughly set the value, and then switch to fine adjustment to adjust the value precisely.

6. Turn on the load.

Press the LOAD key.

The LOAD LED illuminates, and the current flows.

The display shows the measured values (voltage, current, and wattage) at the load input terminal.

7. Change the voltage setting.

Turn the rotary knob to change the voltage setting.

The voltage value cannot be set greater than the maximum value of the selected range.

8. Turn off the load.

Press the LOAD key.

The LOAD LED turns off, and the current is cut off.

5.9 CP Mode

In CP mode, you set the wattage (W).

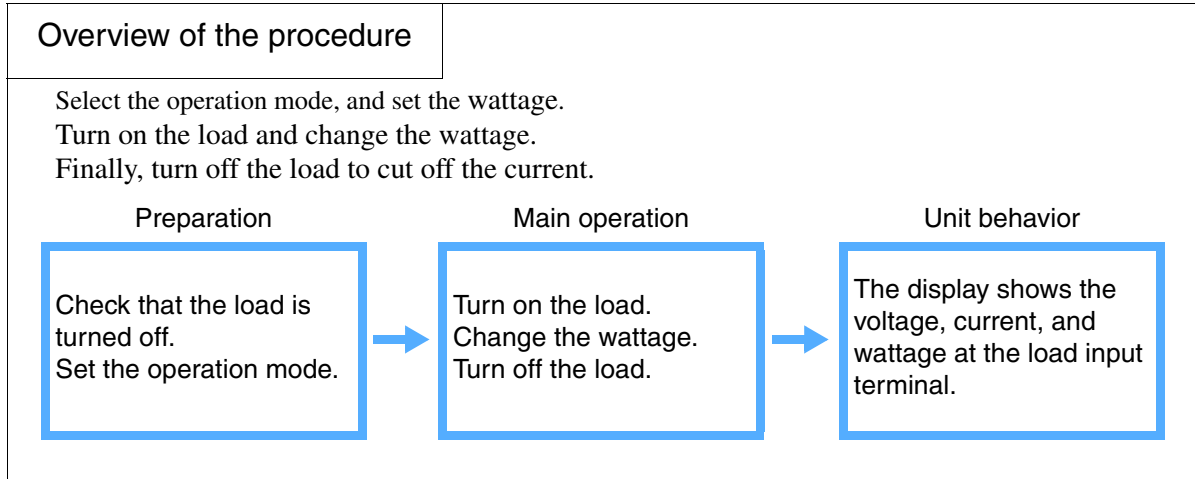

■ Operating procedure of CP mode

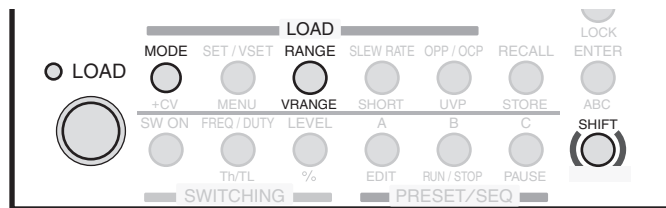

Fig. 5-8 Keys used in CP mode

1. Check that the load is turned off.
 Check that the LOAD LED is turned off. If it is on, press the LOAD key to turn it off.
2. Select the operation mode.
 Press the MODE key.
An operation mode pop-up menu appears.
 Press the MODE key repetitively until CP is highlighted on the menu.
 After selecting the operation mode, check that CP is indicated on the display.
3. Select the current range.
 Press the RANGE key.
A current range pop-up menu appears.
Each time you press the RANGE key while the menu is displayed, the range switches in the order L, M, and H.
 When the desired range is highlighted, stop pressing the key.
 Along with L, M, or H, the full scale value of the respective range is displayed. This value varies depending on the model.

4. Select the voltage range.

Press the VRANGE (SHIFT+RANGE) key.

A voltage range pop-up menu appears.

Each time you press the VRANGE key, the voltage range switches between 15 V and 150 V.

When the desired range is highlighted, stop pressing the key.

5. Set the wattage value.

Check that the display is in the basic setting entry condition (the characters “SET” is highlighted).

While viewing the display, turn the rotary knob.

First, use coarse adjustment to roughly set the value, and then switch to fine adjustment to adjust the value precisely.

6. Turn on the load.

Press the LOAD key.

The LOAD LED illuminates, and the current flows.

The display shows the measured values (voltage, current, and wattage) at the load input terminal.

7. Change the wattage setting.

Turn the rotary knob to change the wattage setting.

The wattage value cannot be set greater than the maximum value of the selected range.

8. Turn off the load.

Press the LOAD key.

The LOAD LED turns off, and the current is cut off.

5.10 Soft start

The PLZ-4W can be set to start up slowly of the input current of the PLZ-4W (soft start) in the constant current (CC) mode and the constant resistance (CR) mode when the applying voltage and the turning on the load at the same time, or when the voltage applied with 0 V input of the load input while the load is turned on.

When the soft start time is appropriately set, the distortion of output voltage from the DUT can be suppressed. Set the soft-start in accordance with the rise time of the DUT.

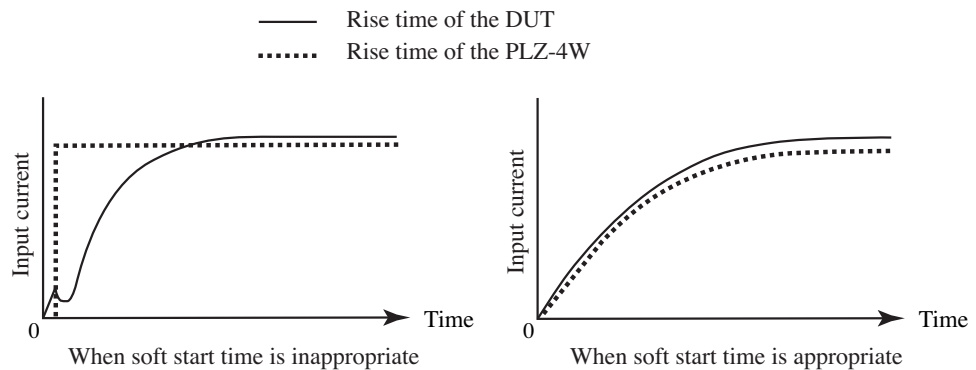

Fig. 5-9 Difference in operation by the setting of soft start time

■ Procedure

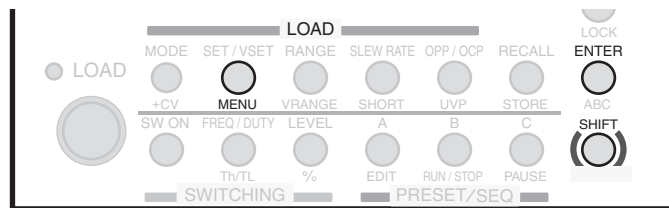
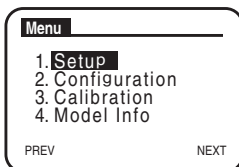
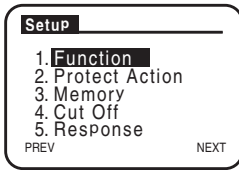

Fig. 5-10 Keys used in soft start

1. Check that the load is turned off.
Check that the LOAD LED is turned off. If it is on, press the LOAD key to turn it off.
2. Select the menu setup.
Press the MENU (SHIFT + SET/VSET) key.
The menu appears.
3. Select Setup.
Press the ▼ or ▲ CURSOR key several times until Setup is highlighted on the menu.
When highlighted, press the ENTER key.





4. Select Function.

Press the ▼ or ▲ CURSOR key several times until Function is highlighted on the menu.

When highlighted, press the ENTER key.

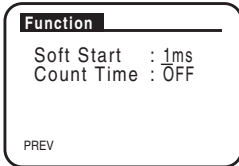

5. Select soft start time.

Check that the cursor is blinking by Soft Start on the menu, and turn the rotary knob to select the soft start time.

6. Exit from the menu.

Press the MENU (SHIFT + SET/VSET) key.

The display returns to the basic setting entry condition (the characters "SET" is highlighted).

The soft start time is set.

5.10.1 Response Time until Current Starts Flowing

When the load is turned on with no load input (0 V), the response time from when a voltage is applied to when current starts flowing varies depending on the basic setting.

Figures 5-11 and 5-12 show the relationship between the response time and basic setting when soft start is set to 1 ms on a PLZ-4W series with firmware (SUB) version 3.0X or later. For firmware versions earlier than 3.0X, the response time is slower by 1 ms to 2 ms than that shown on the graph.

For information on how to check the firmware version, see Page 2-9 "Checking the ROM Version".

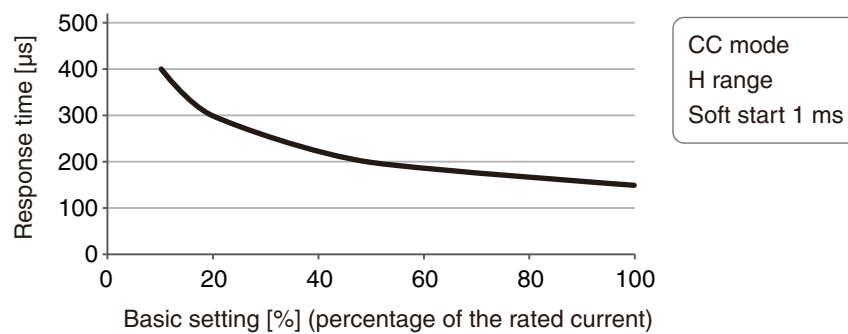

Fig. 5-11 Response time and basic setting (CC mode)

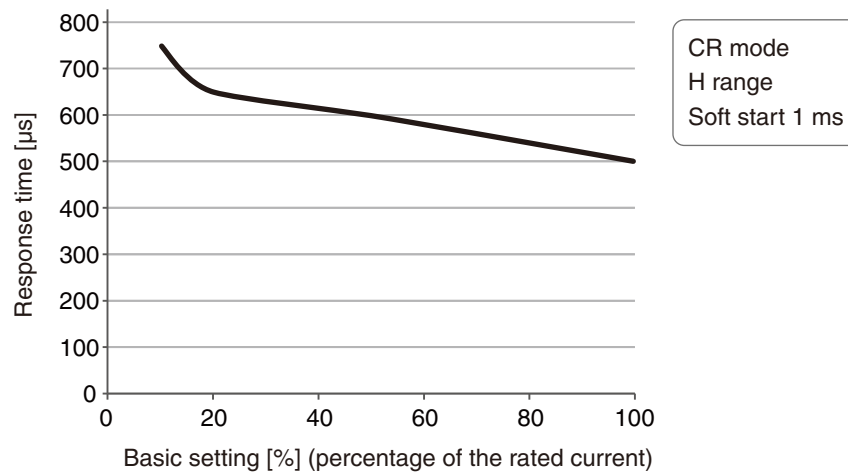

Fig. 5-12 Response time and basic setting (CR mode)

5.11 Lock Function

The PLZ-4W can be locked to prevent erroneous operation such as inadvertently changing the settings or overwriting the memory or sequence. The functions that can be used and those that cannot be used when the lock function is enabled are indicated below.

Table5-1 Lock function

Functions that can be used	Functions that cannot be used
Load on/off	Setting change
Sequence execution	Sequence construction
Lock set/clear	Memory store (save)
ABC preset memory recall	
Setup memory recall	

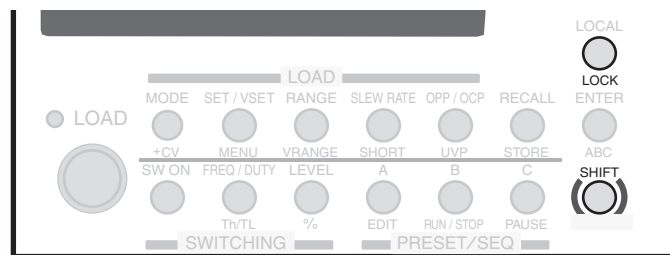

Fig. 5-13 Keys used in the lock function

■ Setting the lock

1. Set the lock.

Press the LOCK (SHIFT+LOCAL) key.

A key icon is indicated on the display, and the PLZ-4W is locked.

When locked, you can only carry out the following key operations: turn on or off the load, execute sequences, recall ABC preset memories, recall setup memories, and release the lock.

■ Releasing the lock

1. Release the lock.

Hold down LOCK (SHIFT+LOCAL) for a few seconds until a beep is heard.

The key icon clears, and the lock is released.

■ Locking the PLZ-4W at power on

By default, the PLZ-4W is not locked at power on. You can change the setting from the menu so that the PLZ-4W is locked at power on.

1. Check that the load is turned off.

Check that the LOAD LED is turned off. If the LED is illuminated, press the LOAD key to cut off the current.

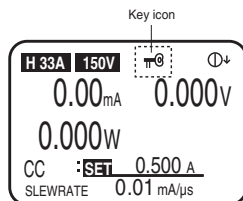

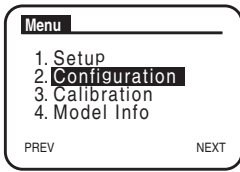

2. Select the menu setup.

Press the MENU (SHIFT + SET/VSET) key.

The menu appears.

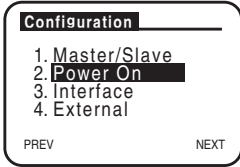

3. Select Configuration

Press the ▼ or ▲ CURSOR key several times until Configuration is highlighted on the menu. When highlighted, press the ENTER key.

4. Select Power On.

Press the ▼ or ▲ CURSOR key several times until Power On is highlighted on the menu. When highlighted, press the ENTER key.

5. Select key lock.

Press the ▼ CURSOR key to move the blinking cursor by Key Lock on the menu.

Turn the rotary knob to the right to display ON and left to display OFF. To lock the PLZ-4W at power on, select ON.

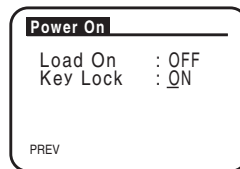

6. Exit from the menu.

Press the MENU (SHIFT + SET/VSET) key.

The display returns to the basic setting entry condition (the characters "SET" is highlighted).

When you turn on the PLZ-4W the next time, it will be locked.

To perform panel operation, hold down LOCK (SHIFT+LOCAL) for a few seconds until a beep is heard to release the lock.

5.12 Short Function

The short function is used to immediately set the maximum current (CC mode) or minimum resistance (CR mode).

When the short function is enabled, the short signal output of the J1 connector is turned on. The short signal output terminal is connected to a relay contact (30 VDC/ 1 A) and can be used to drive an external relay for high current to short the load input terminal.

For a description of the J1 connector, see “J1 and J2 Connectors” in section 6.8, “External Control.”

⚠ CAUTION • Be sure to use a dedicated driver circuit to drive the relay for high current.

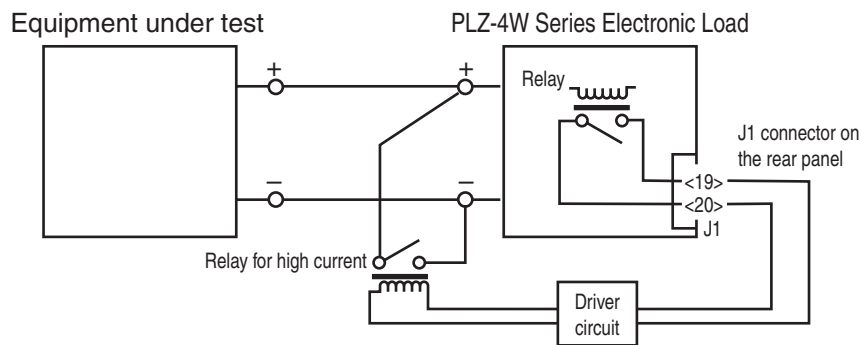

Fig. 5-14 Connection example of a relay for high current

■ Procedure

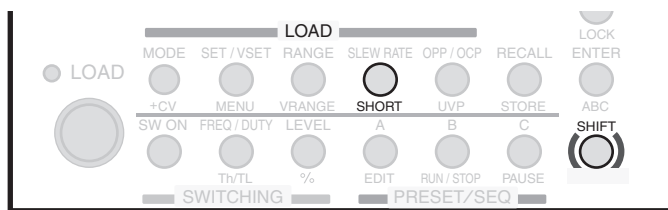
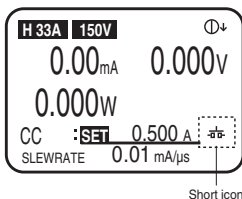

Fig. 5-15 Keys used in the short function



1. Execute the short function.

With the load turned on, press the SHORT (SHIFT+SLEW RATE) key.

A short icon appears. When in CC mode, the value is set to the maximum current; when in CR mode, the value is set to the minimum resistance.

- The short function setting cannot be saved to the setup memory.

2. Clear the short function.

Press the SHORT (SHIFT+SLEW RATE) key again.

The short icon clears, and the PLZ-4W returns to the original condition before the short function was executed.

5.13 Menu Setup

The menu is used to change the operating conditions of the PLZ-4W and the default settings of functions.

This section describes the operations on the menu and a list of menu items.

The hierarchical structure of the menu is shown below.

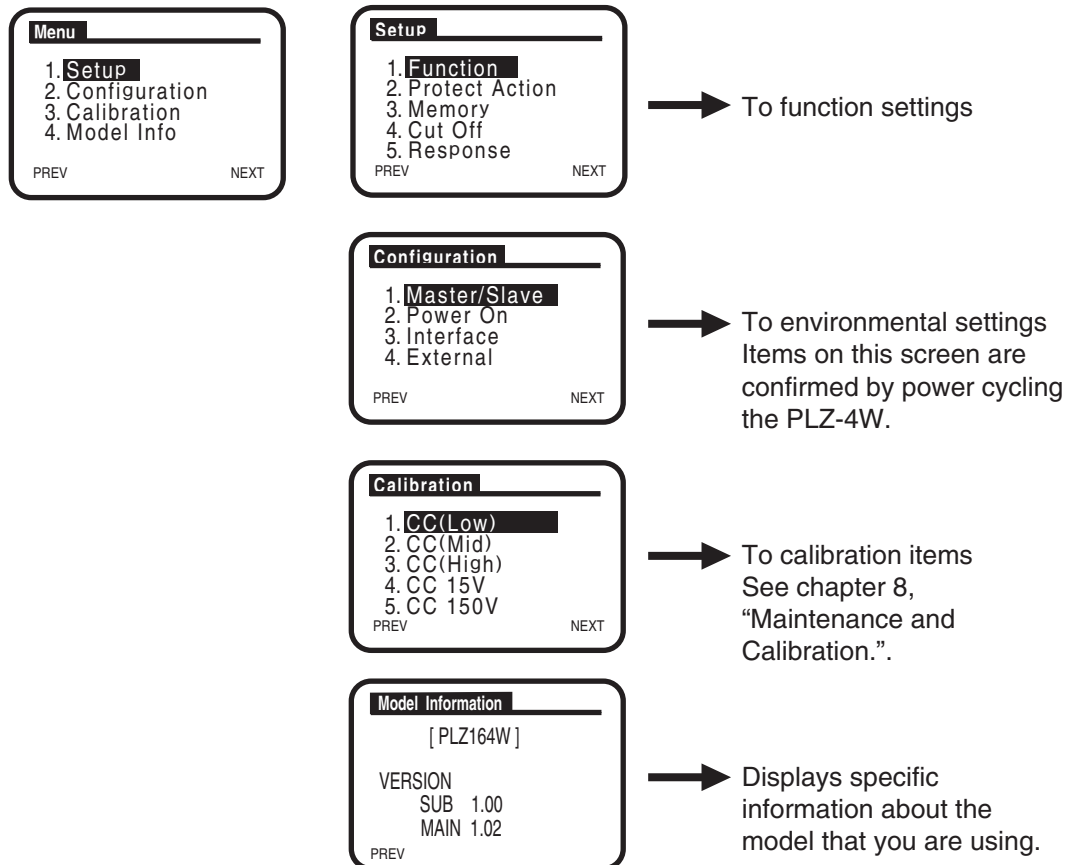

Fig. 5-16 Menu hierarchy

■ Procedure

1. Check that the load is turned off.

Check that the LOAD LED is turned off. If it is on, press the LOAD key to turn it off.

2. Select the menu setup.

Press the MENU (SHIFT + SET/VSET) key.

The menu appears.

3. Select the menu.

Press the ▼ or ▲ CURSOR key several times until the desired menu item is highlighted on the menu. When highlighted, press the ENTER key.

- To exit from the menu, press the MENU (SHIFT + SET/VSET) key.

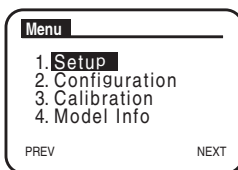

- **Operation of selecting menu items**

You can also select the menu item by turning the rotary knob. Turning the rotary knob to the right moves the highlight downward; turning it to the left moves the highlight upward.

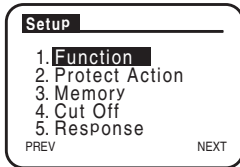

4. Then, select the next menu.

Press the ▼ or ▲ CURSOR key several times until the desired menu item is highlighted on the menu. When highlighted, press the ENTER key.

A setup item screen of the function is displayed.

- **Next page and previous page**

To return to the previous screen, press the PREV (SHIFT+ ◀) key. To move to the next screen (or select a menu item and move to the next screen), press the NEXT (SHIFT+ ▶) key.

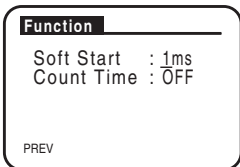

5. Select the setup item.

Press the ▼ or ▲ CURSOR key several times until the cursor moves next to the desired setup item.

6. Select the value.

Turn the rotary knob to the right or left to select the value of the item.

To move to another item, press the ▼ or ▲ CURSOR key several times to move the cursor.

7. Exit from the menu.

Press the MENU (SHIFT + SET/VSET) key.

The display returns to the basic setting entry condition (the characters "SET" is highlighted).

NOTE

- In Configuration setting, power cycle the PLZ-4W after finishing the menu setup. The new setting is confirmed by power cycling the PLZ-4W.
-

Table5-2 Menu items

Menu name 1	Menu name 2	Item name	Values <*1>	
1. Setup	1. Function	Soft Start	<u>1</u> ms, 2 ms, 5 ms, 10 ms, 20 ms, 50 ms, 100 ms, 200 ms	
		Count Time (elapsed time display)	<u>OFF</u> , ON	
	2. Protect Action	OCP	<u>LIMIT</u> , LOAD OFF	
		OPP	<u>LIMIT</u> , LOAD OFF	
	3. Memory	ABC Preset Memory Recall	<u>SAFETY</u> , DIRECT	
	4. Cut Off	Time (auto load off timer)	<u>OFF</u> , 000:00:01 to 999:59:59	
5. Response	–	<u>1/1</u> , 1/2, 1/5, 1/10		
2. Configuration	1. Master/Slave	Operation	<u>MASTER</u> , SLAVE	
		Parallel (MASTER only)	–, 2, 3, 4, 5	
		Load booster (MASTER: PLZ1004W only)	–, 1, 2, 3, 4	
	2. Power On	Load On	<u>OFF</u> , ON	
		Key Lock	<u>OFF</u> , ON	
	3. Interface	Control	<u>GPIB</u> , RS232C, USB	
		GPIB	Address	<u>1</u> to 30
			RS232C	Baudrate
		Data		8 (fixed)
		Stop		1, <u>2</u>
		Parity		NONE
		Ack (acknowledge)	<u>OFF</u> , ON	
		USB	VID	0x0B3E (display only)
	PID		xxxx (display only)	
	S/N		xxxx (display only)	
4. External	Control	<u>OFF</u> , V, R, Rinv (Inverse)		
	LoadOn IN	LOW, <u>HIGH</u>		
3. Calibration	1. CC (Low)	To the calibration screen (see chapter 8, “Maintenance and Calibration.”)		
	2. CC (Mid)			
	3. CC (High)			
	4. CV 15V			
	5. CV 150V			
4. Model info	MODEL	(Model)	PLZxxxW	
	VERSION SUB	(Firmware version)	x.xx	
	VERSION MAIN	(ROM version)	x.xx	

*1:Underlined values are factory default values.

5.14 Initialization

The backup function of the PLZ-4W retains the current settings, menu settings, and memory contents (ABC preset memories and setup memory) even when the POWER switch is turned off. You can initialize the PLZ-4W settings to factory default by carrying out the following operation.

- For a description of the ABC preset memories, see section 6.1, “ABC preset memories.” For a description of the setup memory, see section 6.2, “Setup Memory.”
- For a description of the default menu settings, see Table 5-3.

⚠ CAUTION • Use caution because the contents of ABC preset memories and the setup memory are also cleared when the PLZ-4W is initialized.

■ Initializing the PLZ-4W

1. While holding down the ENTER key, turn on the POWER switch.

SET CLR appears when the display turns on.

Release the ENTER key when the next information appears.

The PLZ-4W settings are initialized.

Table 5-3 Factory default settings

Item	Panel settings	Setup memory settings (all 100 sets)
OCP value	Maximum value	Minimum value
OPP value	Maximum value	Minimum value
UVP value	OFF	OFF
Current	0 A	Full scale of H range
Conductance	0 S	Full scale of H range
Voltage	Minimum value	Full scale of H range
Wattage	0 W	Full scale of H range
Current range	H	H
Voltage range	150 V	150 V
Load on/off	Load off	Load off
Operation mode	CC	CC
Slew rate	Minimum value of H range	Maximum value of H range
ABC preset memories	Settings above in each mode	Settings above in each mode
Menu setup	See Table 5-2.	See Table 5-2.

5.15 Response Speed

The PLZ-4W operates by detecting the input current or voltage and feeding back those values. You can set the response speed of the negative feedback control. The response speed can be specified in CC mode (CC+CV mode) and CR mode (CR+CV mode). You can decrease the response speed to assure stable operation.

If the load wire is long or has a large loop, the wire inductance is increased. Consequently, the current variation at the time of switching operation will cause a large voltage drop.

In such condition, the input voltage may fall below the minimum operating voltage of the PLZ-4W causing the current waveform to be distorted. In some cases, the input voltage may exceed the maximum input voltage and cause damage to the PLZ-4W. You must be careful especially when the slew rate setting is high or switching is performed using large currents through parallel operation.

In such case, it is important that you use the shortest twisted wire possible for the connection. Then, decrease the slew rate setting or lower the response speed so that the voltage induced by the inductance is within the minimum operating voltage and the maximum input voltage range of the PLZ-4W.

In the case of DC operation also, the phase lag of the current may cause instability in the PLZ-4W control inducing oscillation. In this case also, use the shortest twisted wire possible for the connection, and achieve stable operation by lowering the response speed.

■ Response speed type and performance

The following four levels are available. Select one of the levels.

1/1: Normal response speed

1/2: 1/2 the normal response speed (Slows down by a factor of 2.)

1/5: 1/5 the normal response speed (Slows down by a factor of 5.)

1/10: 1/10 the normal response speed (Slows down by a factor of 10.)

The default setting is 1/1.

Settings other than 1/1 slow down the speed and affect the performance of soft start and slew rate as well as the rise and fall times of load on/off.

The slew rate in turn affects the switching operation.

■ Setting the response speed

You can set the response speed of the PLZ-4W using “1. Setup” | “2. Response” from the menu.

For a description of changing the menu setup, see section 5.13, “Menu Setup.”

When using parallel operation or high speed load simulations (such as switching function), refer to the “Technical Note for the electronic load (PLZ-4W), When operating under parallel operation or high-speed load simulations” as provided as separate sheet and set the response speed properly.

6

Chapter 6 Applied Operation

This chapter describes functions such as ABC preset memories, switching function, and sequence function that are used in actual applications.

6.1 ABC preset memories

Three separate sets of settings for each range of each operation mode can be saved to memories A, B, and C. Settings are saved or recalled after determining the operation mode and range. Settings (A, B, and C) saved in the current operation mode at the current range can be recalled.

Table6-1 Memory Overview

Operation mode	Range		A	B	C		
CC CR CP	Current		H	●	●	●	
			M	●	●	●	
			L	●	●	●	
CV	Voltage		H	○	○	○	
			L	○	○	○	
CC+CV CR+CV	Voltage	H	Current	H	● ○	● ○	● ○
				M	● ○	● ○	● ○
				L	● ○	● ○	● ○
		L	Current	H	● ○	● ○	● ○
				M	● ○	● ○	● ○
				L	● ○	● ○	● ○

● current, resistance, and wattage ○ voltage

In CC+CV and CR+CV modes, the settings are saved to the memories of CC, CR, and CV modes.

In CC, CR, and CP modes, the settings according to the current range are saved to the memories A, B, and C. In CV mode, the settings according to the voltage range are saved. In CC+CV and CR+CV modes, the voltage and current values are saved. ABC preset memories can be recalled even when the load is turned on.

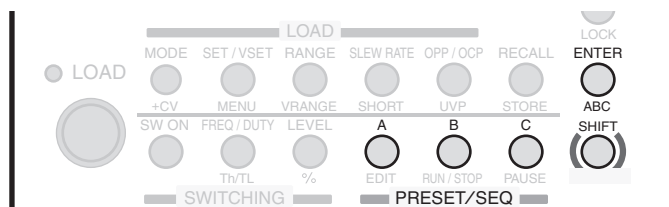

Fig.6-1 Keys for ABC preset memories

6.1.1 Saving to ABC preset memories

Three separate sets of settings for each range of each operation mode can be saved to memories A, B, and C. The settings can be saved even when the load is turned on.

1. **Select the ABC preset memories.**

First, switch to the desired operation mode and set the range and value.

Next, press the ABC (SHIFT+ENTER) key.

Three keys A, B, and C illuminate.

2. **Save to the memory.**

Press the A, B, or C memory key.

The pressed key illuminates.

[The settings are saved to the selected memory. The key that is illuminated turns off when the setting is changed.]

6.1.2 Recalling ABC preset memories

There are two methods for recalling memories: SAFETY and DIRECT. By default, the SAFETY method is selected.

SAFETY

In this method, you check the memory contents on the display before actually recalling the settings.

DIRECT

In this method, the settings saved to memory A, B, or C are recalled directly. The recalled settings are immediately applied as current settings.

■ Changing to the DIRECT method

By default, the SAFETY method (in which the memory contents are checked on the display before actually applying them) is selected. If set to the DIRECT method, the settings of the recalled memory are applied immediately. The recall method is switched from the menu.

1. **Check that the load is turned off.**

Check that the LOAD LED is turned off. If it is on, press the LOAD key to turn it off.

2. **Select the menu setup.**

Press the MENU (SHIFT+SET/VSET) key.

The menu appears.

3. Select Setup.

Press the ▼ or ▲ CURSOR key several times until Setup is highlighted on the menu. When highlighted, press the ENTER key.

4. Select Memory.

Press the ▼ or ▲ CURSOR key several times until Memory is highlighted on the menu. When highlighted, press the ENTER key.

5. Select the recall method of ABC preset memories.

Turn the rotary knob to the right to display SAFETY and left to display DIRECT. To switch to the direct method, select DIRECT.

6. Exit from the menu.

Press the MENU (SHIFT+SET/VSET) key.

The recall method of ABC preset memories are set.

■ Recalling ABC preset memories (SAFETY)

1. Select the memory.

Set the operation mode and range according to the memory to be recalled. Next, press the key (A, B, or C) to be recalled.

The pressed key illuminates, and the settings stored to the memory are shown on the display.

2. Recall the memory.

To recall the memory, press the ENTER key.

To change to another memory, press the desired key (A, B, or C), check the settings, and press the ENTER key.

The settings are applied when you press the ENTER key.

■ Recalling ABC preset memories (DIRECT)

1. Recall the memory.

Set the operation mode and range according to the memory to be recalled.

2. Press the key (A, B, or C) to be recalled.

The pressed key illuminates, and the current settings are changed to the settings that were stored.

- In CC, CR, CV, or CP mode (saves one setting)

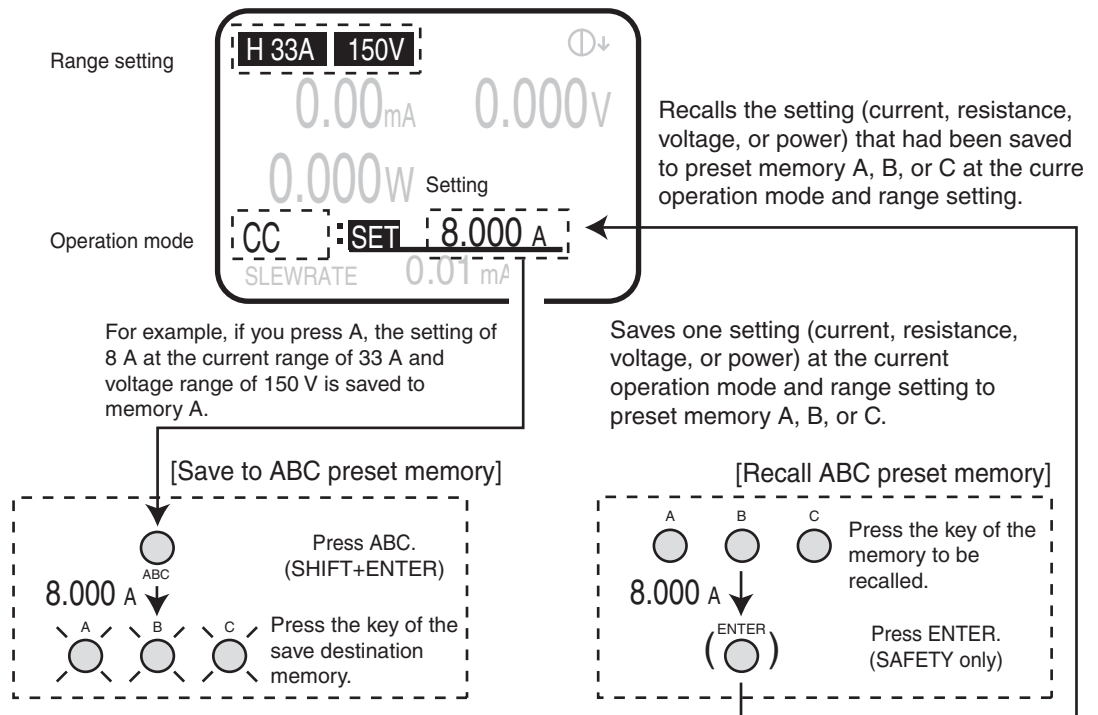

- In CC+CV or CR+CV mode (saves two settings)

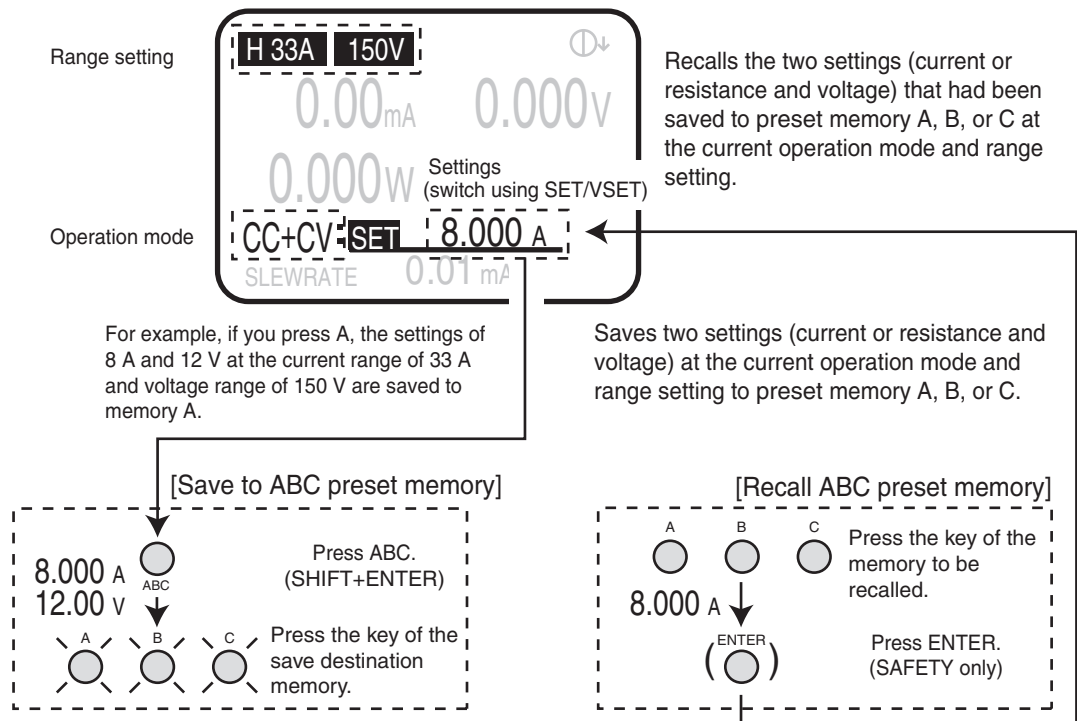

Fig. 6-2 Contents stored to the ABC preset memories

6.2 Setup Memory

The setup memory can store up to 100 sets (0 to 99) of the current conditions of the items shown below. You can attach a memo using up to 15 characters to each memory set. The stored settings can be recalled as necessary.

■ Settings that are saved

- Operation mode (CC, CR, CV, or CP, and enabled/disabled condition of +CV)
- Basic settings (current, resistance, voltage, and power)
- Range setting (RANGE/VRANGE)
- Slew rate value (SLEW RATE)
- Switching frequency and duty cycle (FREQ/DUTY)
- Switching time (Th/TL)
- Switching level and ratio (LEVEL/%)
- Protection setting (OCP/OPP/UVP)
- Contents of ABC preset memories (A/B/C)

Table 6-2 Contents saved to a single memory set

Operation mode	Range		A	B	C	Other settings		
CC CR CP	Current		H	●	●	●	◇	
			M	●	●	●	◇	
			L	●	●	●	◇	
CV	Voltage		H	○	○	○	◇	
			L	○	○	○	◇	
CC+CV CR+CV	Voltage	H	Current	H	●○	●○	●○	◇
				M	●○	●○	●○	◇
				L	●○	●○	●○	◇
		L	Current	H	●○	●○	●○	◇
				M	●○	●○	●○	◇
				L	●○	●○	●○	◇

● current, resistance, wattage ○ voltage ◇ other values (slew rate, switching, and protection)

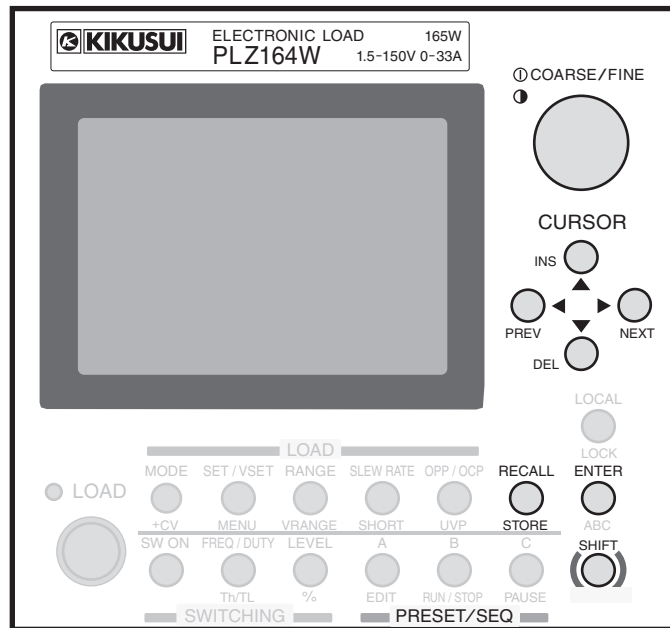
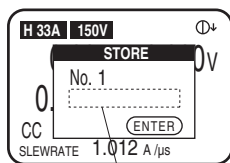

Fig. 6-3 Keys for the setup memory

6.2.1 Saving to the Setup Memory



No. 1:Program1

1. Select the setup memory.

First, set the operation mode, range, and settings as desired.

Next, press the STORE (SHIFT+RECALL) key.

The STORE key blinks.

The setup memory store screen appears. The store screen shows the last number of the memory to which settings were saved previously (0 by default).

2. Select the memory number.

Turn the rotary knob to show the number of the memory to which settings are to be saved.

3. Enter a memo.

Press the ▼ CURSOR key. The cursor blinks below the number. Turn the rotary knob in this condition to select a character.

After selecting a character, press the ► key to move the cursor to the right, and continue entering characters. To move to the left, press the ◀ key. You can register up to 15 characters.

NOTE

- You can return to the memory number selection by pressing the ▲ CURSOR key when entering characters.
- If you press the PREV (SHIFT+◀) key or STORE (SHIFT+RECALL) key, the settings are not saved to the setup memory, and the display returns to the basic setting entry condition (the characters “SET” is highlighted).

4. Save the settings to the setup memory.

Press the ENTER key.

The STORE key illuminates.

The settings described above are saved to the memory. If settings are already stored at the selected memory number, the settings are overwritten.

The STORE key remains illuminated while the saved settings are used.

6.2.2 Recalling the Setup Memory

1. Check that the load is turned off.

2. Select the setup memory.

Press the RECALL key.

The RECALL key blinks.

The setup memory recall screen appears. The recall screen shows the number of the memory to which settings were saved previously (0 by default).

3. Select the number of the memory to be recalled.

Turn the rotary knob to show the number of the memory to be recalled.

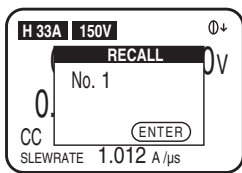

NOTE

- When a memo is attached, it is displayed under the memory number.
- If you press the PREV (SHIFT+◀) key or RECALL key, the settings are not recalled from the setup memory, and the display returns to the basic setting entry condition (the characters “SET” is highlighted).

4. Recall the setup memory.

Press the ENTER key.

The RECALL key illuminates.

The settings in the memory are recalled.

The RECALL key remains illuminated while the recalled settings are used. If you change the settings, the RECALL key turns off.

NOTE

- The setup memory cannot be recalled when the load is turned on.
 - The setup memory can store most of the settings including the operation mode and range setting. Note that if the stored settings differ from the current operation mode or range setting, they will be switched.
-

- In CC, CR, CV, or CP mode

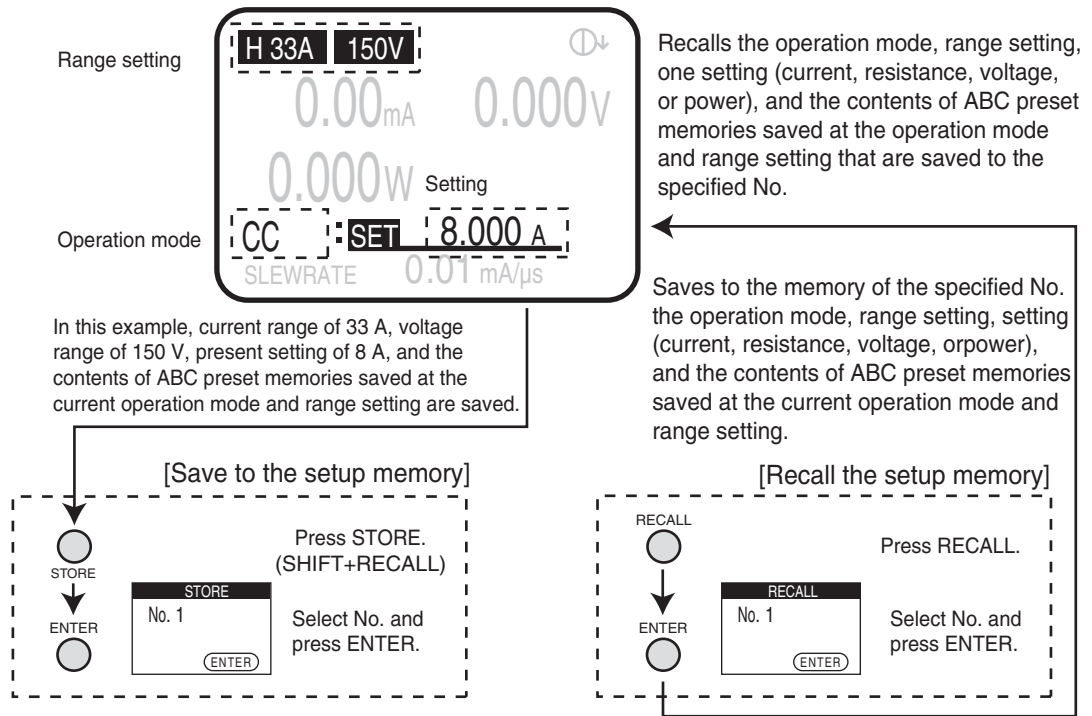

- In CC+CV or CR+CV mode

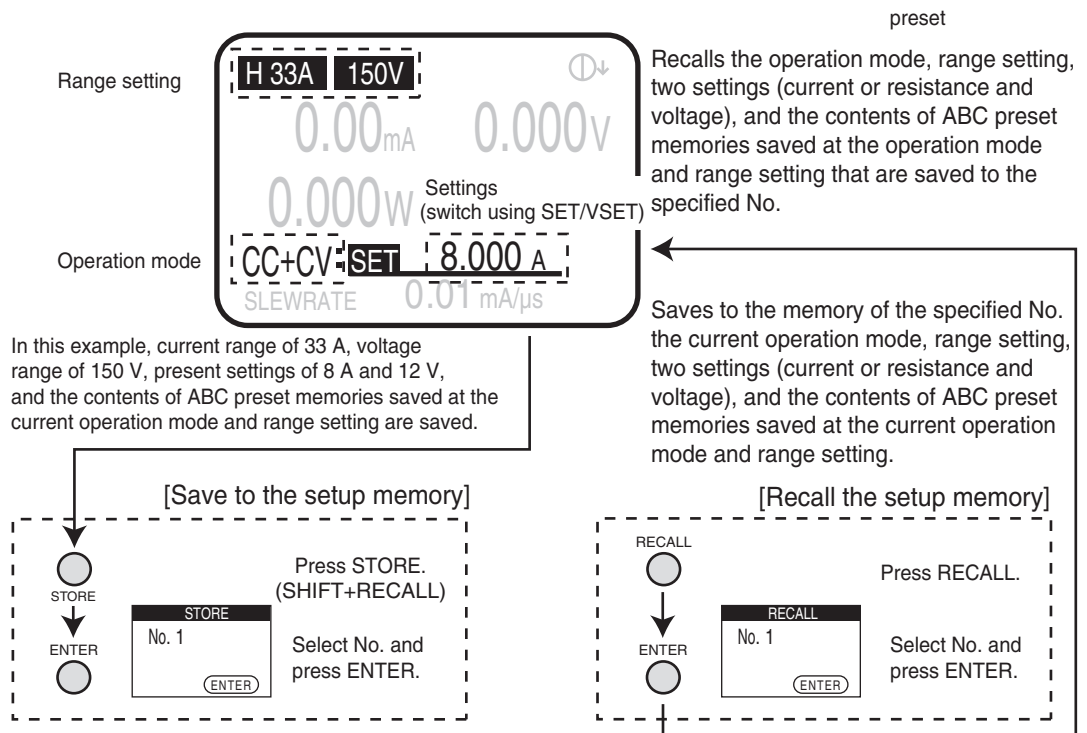

Fig. 6-4 Contents stored to the setup memory

6.3 Switching Function

Switching refers to the operation of executing two load current settings repetitively. The switching function operates in CC and CR modes. The switching function is suited to transient response characteristics test of regulated DC power supplies.

You can perform various tests by setting the switching frequency, ON/OFF ratio of the switch (duty cycle), switching level, and switching time. You can also set the slew rate of the current change. (See section 6.4, “Setting the Slew Rate.”)

When the switching operation is in progress, a trigger signal is output from the TRIG OUT connector on the front panel. A pulse is output at the edges indicated by the circles in Fig. 6-5.

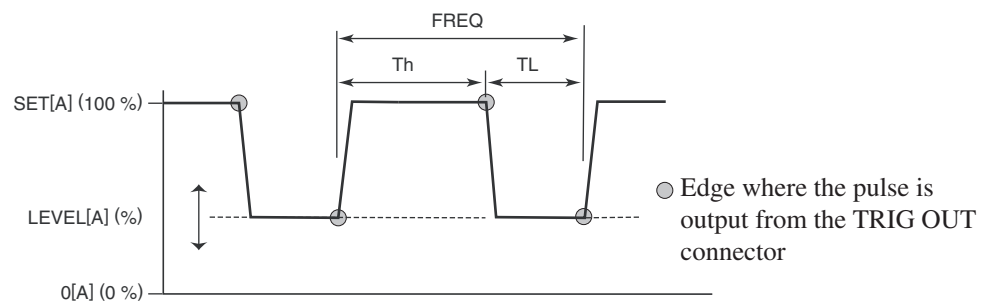

Fig. 6-5 Characteristics diagram of a switching waveform

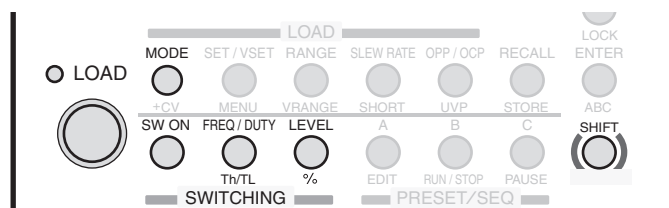

Fig. 6-6 Keys used in the switching function

■ Operating Procedure

1. Select the switching level.

Press the LEVEL key.

The LEVEL key illuminates.

The maximum value that can be specified is the value specified in the current operation mode, and the minimum value is 0 A or 0 mS. If you press the % (SHIFT+LEVEL) key, you can enter the level in terms of a percentage of the current setting (0.0 % to 100.0 %).

To reenter the level using a value, press the LEVEL key again.

2. Set the switching level.

While viewing the display, turn the rotary knob to set the value.

You can press the rotary knob to switch between coarse adjustment and fine adjustment.

3. Turn on the switching mode.

Press the SW ON key.

The SW ON key illuminates, and the switching mode is enabled.

• **Setting the switching function using frequency and duty cycle**

4. Select switching frequency and duty cycle.

Press the FREQ/DUTY key.

The FREQ/DUTY key illuminates.

Switching frequency (FREQ) or duty cycle (DUTY) is highlighted alternately each time you press FREQ/DUTY.

Highlight the one you wish to set.

5. Set the switching frequency and duty cycle.

While viewing the display, turn the rotary knob to set the value.

You can press the rotary knob to switch between coarse adjustment and fine adjustment.

NOTE

- You can set the switching frequency in the range of 1 Hz to 20 kHz, but if the frequency is set high, limitation is placed on the upper limit of the duty cycle. The resolution (Hz and kHz) switches automatically.
-

• **Setting the switching function using time**

4. Select the switching time.

Press the Th/TL (SHIFT+FREQ/DUTY) key.

The Th/TL key illuminates.

The high side (Th) and the low side (TL) of the switching time is highlighted alternately each time you press Th/TL (SHIFT+FREQ/DUTY).

Highlight the one you wish to set.

5. Set the switching time.

While viewing the display, turn the rotary knob to set the switching time on the high side and low side.

NOTE

- The settings for the switching operation can be changed even when the load is turned on.
-

■ **Operation when the response speed is changed**

You can change the response speed in CC mode (CC+CV mode) and CR mode (CR+CV mode).

In some cases, the wire inductance increases and a large voltage drop occurs due to changes in the current or the phase lag of the current may cause instability in the PLZ-4W control inducing oscillation.

In such case, you can decrease the response speed to assure stable operation.

- For details, see section 5.15, "Response Speed."

6.4 Setting the Slew Rate

The slew rate defines the slope for changing the current when the current is changed rapidly such as by using the switching function in CC and CR modes. On the PLZ-4W, you set the amount of change in the current per unit time according to the current range.

The slew rate is activated when the setting value is changed such as by switching during turning the load to on.

In CR mode, the values that can be specified (maximum slew rate at each range) are 1/10th the values of CC mode. For the detailed values, see section 9.1, “Electrical Specifications.”

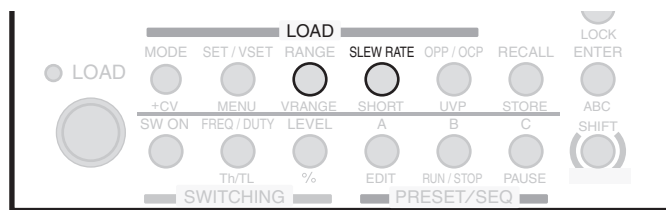

Fig. 6-7 Keys for the slew rate

■ Procedure

1. Selects the slew rate.

Press the SLEW RATE key.

The SLEW RATE key illuminates.

2. Sets the slew rate value.

While viewing the display, turn the rotary knob to set the slew rate value.

You can press the rotary knob to switch between coarse adjustment and fine adjustment.

6.5 Using the Elapsed Time Display and the Auto Load Off Timer

Two convenient functions are available for the discharge tests of batteries.

- Measure the time from discharge start until the cutoff voltage is reached (time measurement).
- Measure the closed circuit voltage after a specified time elapses from discharge start (voltage measurement).

■ Elapsed time display (Count Time)

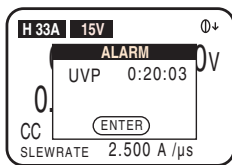

In time measurement, the PLZ-4W can measure the time from load on to load off. As a load off condition, the cutoff voltage is set to the voltage specified for the UVP function. When the load turns off, a pop-up window appears indicating the time from load on to load off.

By default, the elapsed time after the load is turned on is not displayed. To turn on this function, select “1. Setup” | “1. Function” from the menu and set the Count Time setting to on.

- For a description of changing the menu setup, see section 5.13, “Menu Setup.”
- For a description of the UVP function, see section 5.3, “Types of Protection Functions.” and section 5.4, “Setting the Protection Function.”

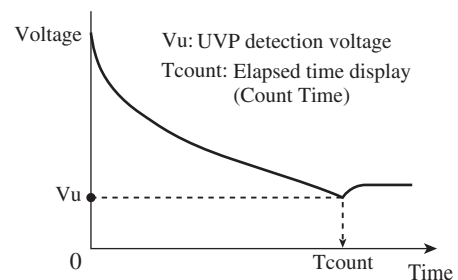
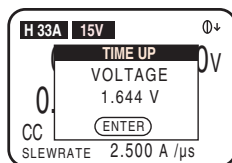

Fig. 6-8 Count Time

■ Auto load off timer (Cut Off Time)



In voltage measurement, the voltage immediately before the load turns off is measured. As a load off condition, a timer is set to turn off the load after a specified time elapses. When the load turns off, a pop-up window appears indicating the input voltage immediately before the load was turned off.

By default, the load on timer is off. To turn on the timer, select “1. Setup” | “4. Cut Off” from the menu and set the time in Time.

The setting range is 000 hour 00 minute 01 second to 999 hours 59 minutes 59 seconds (000:00:01 to 999:59:59).

- For a description of changing the menu setup, see section 5.13, “Menu Setup.”

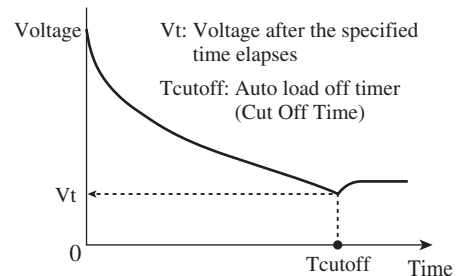

Fig. 6-9 Cut Off Time

6.6 Sequence Function

Sequence is a function that automatically executes instructions specified in advance one operation at a time. By specifying a sequence of operations (steps), various waveform simulations can be executed. The sequence that you create is saved by the backup function even when the power is turned off.

■ Normal sequence and fast sequence

There are two execution modes in the sequence function of the PLZ-4W: normal speed and fast speed.

• Normal sequence

A normal sequence can be set and executed from the PLZ-4W operation panel. In addition, the communication function can be used to set and execute the sequence from an external controller. The execution time can be assigned to each step. You can pause a sequence using PAUSE and resume a sequence using an external trigger input.

• Fast sequence

A fast sequence can be set and executed from the PLZ-4W operation panel. In addition, the communication function can be used to set and execute the sequence from an external controller. Each step is executed at high speeds. The high time resolution allows high-speed simulations. Each step is spaced evenly, and up to 1024 steps can be executed.

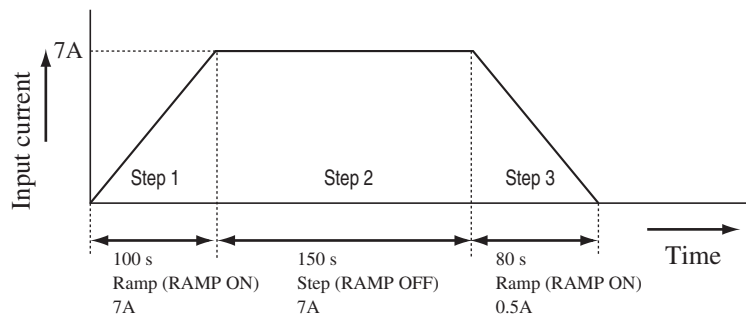

Fig. 6-10 Normal sequence execution example

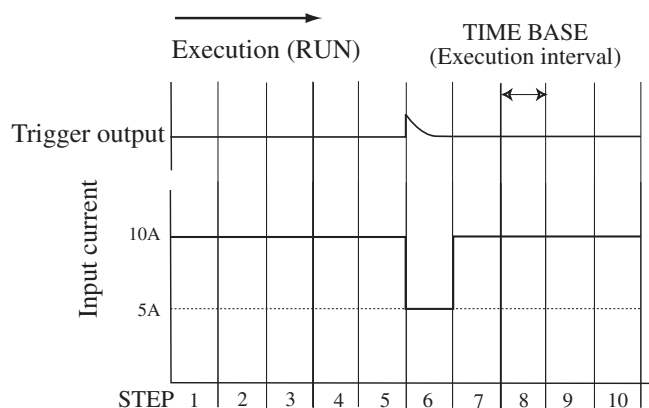

Fig. 6-11 Fast sequence execution example

6.6.1 Overview of the Normal Sequence

To create a sequence, you must understand the concept of “program” and “step.”

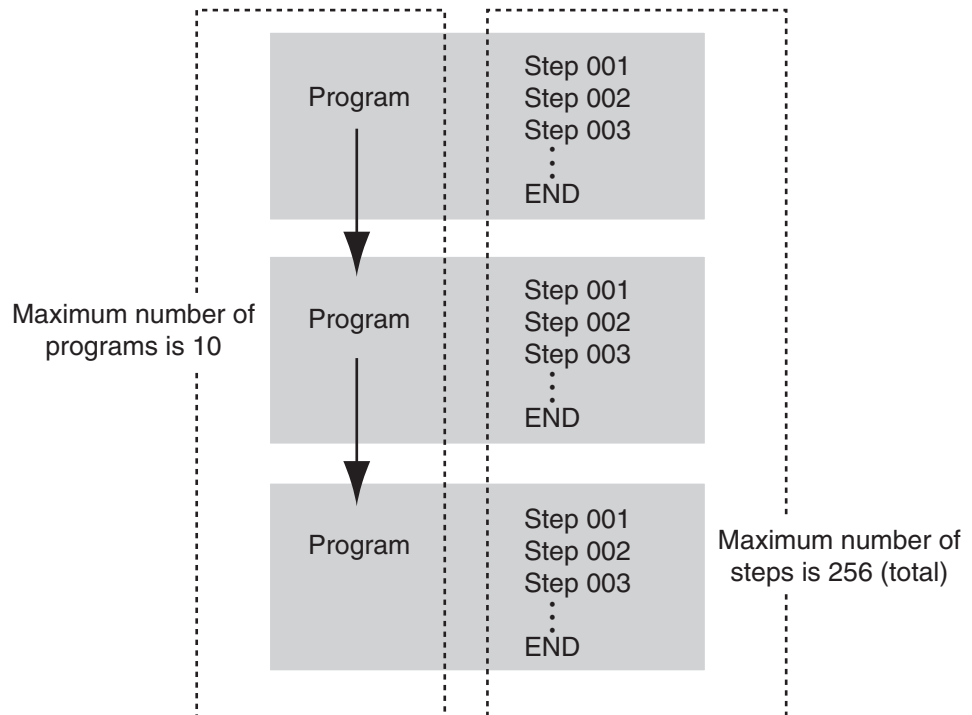

Fig. 6-12 Conceptual diagram of program and step

- **Program**

In a single program one of the four operation modes (CC, CR, CV, and CP) is selected and configured. You can also repeat the same program a specified number of times or connect another program after the program (chain). However, in a chain, the mode and range of the program to be chained must be the same.

The number of programs that can be saved is 1 for the fast sequence mode (No. 11) and 10 for the normal sequence mode (No. 1 to 10).

Below are the settings of a program.

- No. Program number (normal: 1 to 10, fast: 11)
- Memo Memo (up to 11 characters can be specified)
- Mode Operation mode of the program (CC, CR, CV, or CP)
- Range Range of the program (Current range-Voltage range)
- Loop Number of program loops (1 to 9999 where 9999 is infinite loop)
- Last Load Load condition (off/on) when chain is off
- Last Set Current value when chain is off (0 to 100 % of the range setting)
- Chain Number of the program to be executed next (OFF, 1 to 10). Can be executed only when the operation mode and range match.

A program is a collection of steps (execution unit). A program is created by setting steps in ascending order from step number 001. When a specified program is executed (RUN), steps are executed one by one in ascending order from step number 001. The completion of the last step signifies the end of one program execution.

- **Step**

In a single step, one execution condition can be specified. In other words, one operation of the executed waveform corresponds to one step. In normal sequence mode, up to 256 steps can be shared among all programs (10 programs).

Below are the settings of a step.

- Step number
- __SET Setting at the operation mode (A, mS, V, or W)
- h:min:s.ms Step execution time (0:00:00.001 to 999:59)
- LOAD Load or not load (OFF/ON)
- RAMP Current change type (ON: slope, OFF: step)
- TRIG Output or not output the trigger signal during step execution (ON/OFF)
- PAUSE Pause or not pause during step execution (ON/OFF)

■ **Step execution pattern**

Of the settings of a step, the execution pattern when RAMP (current change type), TRIG (trigger output), or PAUSE is specified are indicated below.

- **RAMP (current transition)**

RAMP sets the current transition. When turned on, the current takes on a slope form; when turned off, the current takes on a step form.

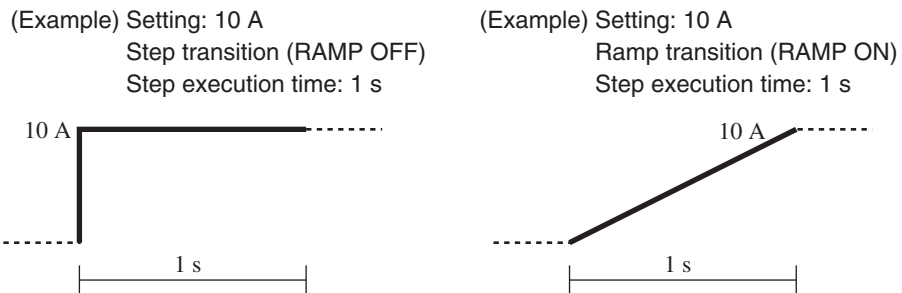

Fig. 6-13 RAMP sequence example

- **TRIG (trigger output)**

TRIG sets the presence or absence of trigger output. When turned on, a trigger signal is output from the TRIG OUT connector on the front panel at the same time as the step is executed.

(Example) Set trigger output at step number n (TRIG ON)

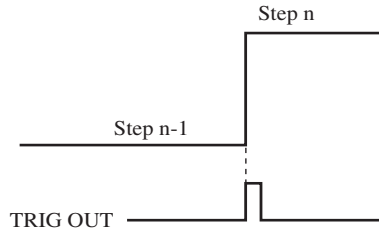

Fig. 6-14 TRIG sequence example

- **PAUSE**

PAUSE sets a pause in the program. When turned on, the sequence operation is paused after executing the step. To resume the operation, you press the PAUSE (SHIFT+C) key on the operation panel or apply a trigger signal to TRIG INPUT (pin 11) of the J1 connector.

For a description of the trigger signal input, see section 6.8.8, “Trigger Signal Control.”

(Example) Pause and resume using the PAUSE (SHIFT+C) key

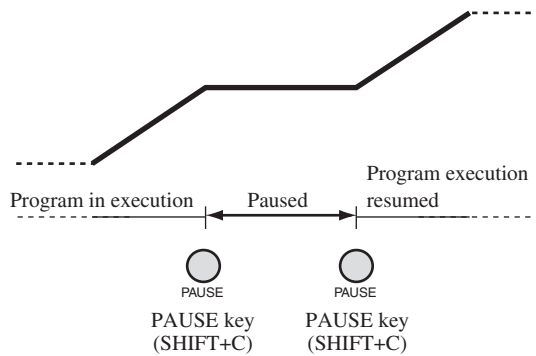

(Example) Pause by executing PAUSE in a program and resume using trigger input (TRIG IN)

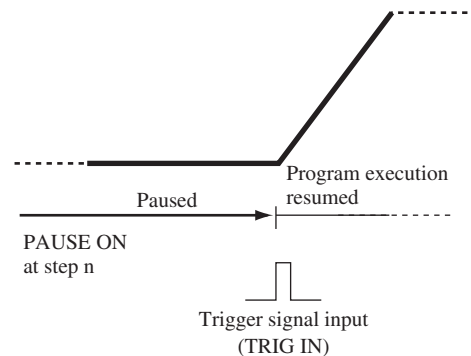

Fig. 6-15 PAUSE sequence example

6.6.2 Sequence Editing

The sequence edit screen is divided into the following four edit screens. When creating a sequence, items are set on each edit screen. This section describes the setup items on each edit screen and the setup procedure.

```

SEQ
No. : 1
Memo : Program1
Mode : NCC
Range : 33A, 150V
Loop : 0001
PREV NEXT
  
```

(1) Program operation

Set the program number, memo, operation mode, range, and the number of loops. (Top screen of the screen divided into top and bottom halves)

```

SEQ
Last Load : ON
Last Set : 0.000A
Chain : 2
PREV NEXT
  
```

(2) Operation after end of program

Set load on/off condition, basic setting, and the chain to another program after the end of the program. (Bottom screen of the screen divided into top and bottom halves)

```

SEQ EDIT
CC SET [A]
001 0.005A
002 0.010A
--- END
PREV TOTAL 002 NEXT
  
```

(3) Step setting

Set the value (current, resistance, voltage, or wattage) of the step to be executed one operation at a time according to the operation mode specified in (1).

```

SEQ EDIT
[h:min:s.ms]
001 100:00:--:---
002 000:00:00:001
--- END
PREV TOTAL 002 NEXT
  
```

(4) Step execution time

Set the execution time of the step.

```

SEQ EDIT
LOAD RAMP TRIG PAUSE
001 ON OFF OFF OFF
002 OFF OFF OFF OFF
--- END
PREV TOTAL 002
  
```

(5) Step execution pattern

■ Common operations on the edit screens

This section describes the common operations carried out on the edit screens such as moving the cursor within the edit screen, selecting items, entering values and characters, and turning pages. Please familiarize yourself with the functions of each key as they are basic operations carried out in sequence editing.

• Moving the cursor

On the edit screen, you can change the value of the item at the position of the blinking cursor. The CURSOR keys are used to move the cursor on the edit screen.

Pressing the ▼ key moves the cursor to the item below and pressing the ▲ key moves the cursor to the item above. When specifying the digit when entering values or specifying the position when entering characters, you can press the ◀ and ▶ keys to move the cursor left and right.

NOTE

- The program operation screen is divided into top and bottom halves. Pressing the ▼ key at the bottom line (Loop) of the top half of the screen moves the cursor to the bottom half of the screen. Pressing the ▲ key at the first line (Last Load) of the bottom half of the screen moves the cursor to the top half of the screen.
-

- **Selecting items**

When an item is selected from several choices, turn the rotary knob to display the desired setting. For example, for ON/OFF items, turning the rotary knob to the right selects ON and turning the rotary knob to the left selects OFF.

- **Entering values**

For numerical settings, you can increase or decrease the value by turning the rotary knob. If the value consists of many digits, you can press the ◀ or ▶ CURSOR key to move the cursor directly to the desired digit and increase or decrease only that digit. For example, if you wish to set a value of 100 (100 times), you can simply move the cursor to the hundreds digit and enter 1 using the rotary knob.

- **Entering characters (memo)**

A memo consisting of up to 11 characters can be added to each program.

NOTE

- Memos are used to identify programs. You do not have to enter a memo. However, it is recommended that a descriptive memo be added for future reference. A memo can be the date/time of measurement, test description, program name, or differences in the setup conditions.
-

You can select the character to be entered (alphanumeric character) by turning the rotary knob. When the desired character is displayed, press the ▶ key to move the cursor to the right, and continue entering the next character. To move the cursor to the left, press the ◀ key.

- **Turning pages**

Press the CURSOR key to switch edit screens. To move to the next screen, press the NEXT (SHIFT+▶) key. To return to the previous screen, press the PREV (SHIFT+◀) key.

Table6-3 Setup items on each setup screen

Edit screen	Setup item	Description
Program operation	No.	Program number (1 to 10)
	Memo	Memo (11 characters)
	Mode	Operation mode (CC, CR, CV, or CP)
	Range	Range setting (Current range - Voltage range)
	Loop	Number of program loops (1 to 9999) 9999 is infinite loop
	Last Load	Load condition after the end of the sequence (ON/OFF)
	Last Set	Current value after the end of the sequence (0.000 to 100 % of the range setting)
	Chain	The number of the next program to be executed after the end of the this program (OFF, 1 to 10)
Step setting	CC SET	Setting executed in the step (A, mS, V, or W)
	CR SET	
	CV SET	
	CP SET	
Step execution time	h:min:s.ms	Hours:minutes:seconds (0.00:00.001 to 999.59:--.---)
Step execution pattern	LOAD	Load on/off
	RAMP	Current transition (ON/OFF)
	TRIG	Trigger output (ON/OFF)
	PAUSE	Pause condition (ON/OFF)

6.6.3 Sequence Example (Normal Sequence)

Programs are created using the PLZ-4W operation panel. This section describes the procedure of entering the following example sequence from the operation panel.

- Flow of the example sequence**

In this example, we will assume a sequence that executes 2 programs (program numbers 1 and 2) to simulate the waveform of Fig. 6-16.

As shown in Fig. 6-16, program 1 can be divided into 3 steps. After the execution of the third step of program 1, the sequence continues to program 2. Program 2 executes the 3 steps of Fig. 6-16 and ends the first loop. Here, we will set program 2 to be executed twice. When program 2 is executed 2 times, this sequence operation is finished.

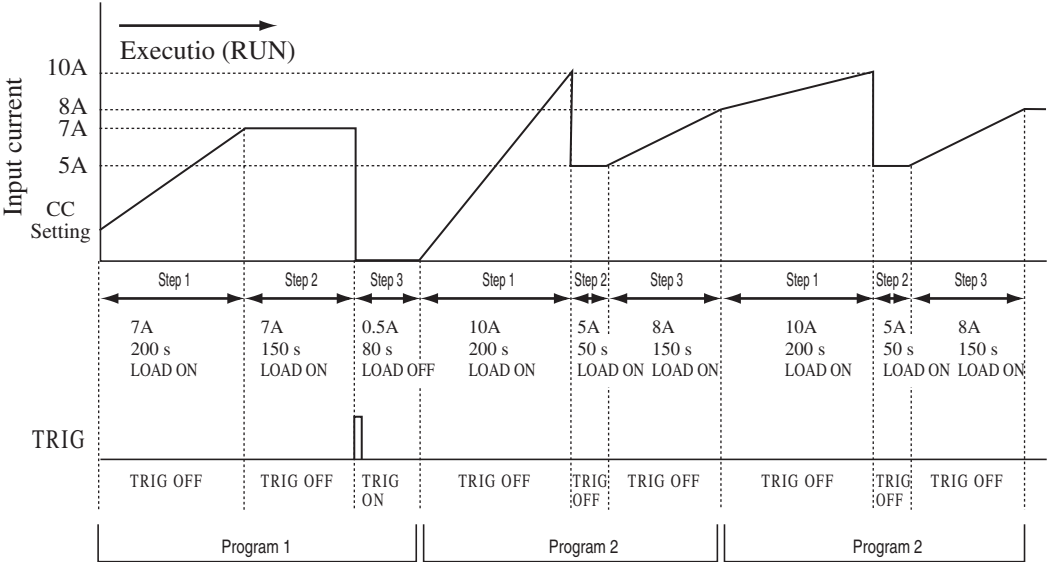

Fig. 6-16 Sequence execution example

Program 1 CC mode (executed once)
 1) 7 A 200 s LOAD ON
 2) 7 A 150 s LOAD ON
 3) 0.5 A 80 s LOAD OFF

Program 2 CC mode (executed twice)
 1) 10 A 200 s LOAD ON
 2) 5 A 50 s LOAD ON
 3) 8 A 150 s LOAD ON

Creating the program

Here, we will create program 1 and then program 2.

Programs can be created in any order. Therefore, you can create program 2 first and then program 1.

1. Select sequence edit.

Press the EDIT (SHIFT+A) key to display the program edit (SEQ) screen.

■ Setting the operation of program 1

2. Set the program number. (No. :)

Turn the rotary knob to set the program number.

In a normal sequence, you can select a number between 1 and 10. In sequence 1, set program number 1.

After setting the program number, press the ▼ CURSOR key to move to the next item.

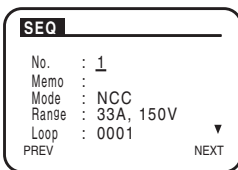

3. Enter a memo. (Memo :)

When adding a memo, turn the rotary knob to enter the characters.

In program 1, enter “Program1”.

After entering the memo, move the ▼ CURSOR key to move to the next item.

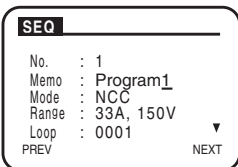

4. Select the operation mode. (Mode :)

Turn the rotary knob to show the operation mode to be executed.

In program 1, select NCC (CC mode).

After setting the operation mode, move the ▼ CURSOR key to move to the next item.

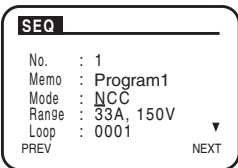

5. Sets the range. (Range :)

Turn the rotary knob to select the current range and voltage range.

In program 1, set 33 A, 150 V (PLZ164W).

After setting the range, move the ▼ CURSOR key to move to the next item.

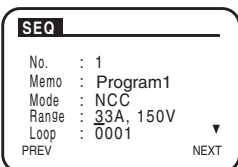

6. Set the number of program loops. (Loop :)

Turn the rotary knob to show the number of program loops.

Since program 1 is executed once, set 0001.

At the last line, move the ▼ CURSOR key to move to the next item.

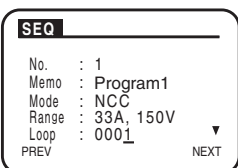

7. Set the load condition after the end of the program. (Last Load :)

Turn the rotary knob to select the load condition.

Since the load is turned off at the end of program 1, select OFF. However, because the sequence continues to program 2 in this example (step 9), this setting is ignored.

After setting the load condition, move the ▼ CURSOR key to move to the next item.

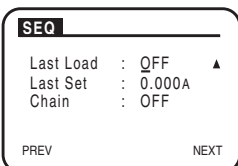

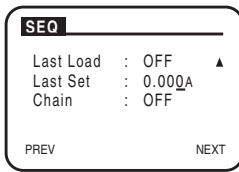

8. Set the current setting after the end of the program. (Last Set :)

Turn the rotary knob to set the current value.

Since the load is turned off at the end of program 1, select 0 A. However, because the sequence continues to program 2 in this example (step 9), this setting is ignored.

After selecting the current setting, move the ▼ CURSOR key to move to the next item.

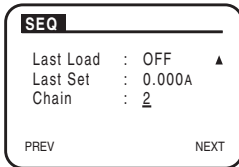

9. Set the number of the next program to be executed after the end of program 1. (Chain :)

Turn the rotary knob to set the number of the program to be executed next.

Since the sequence executes program 2 after the end of program 1, set 2.

Press the NEXT (SHIFT+ ►) key or ENTER key to move to the next edit screen (SEQ EDIT).

■ Setting the steps of program 1

We will set the current setting, execution time, and execution pattern of each step of program 1.

Each item is set on separate screens. Here, we will set the current setting first followed by the execution time followed by the execution pattern.

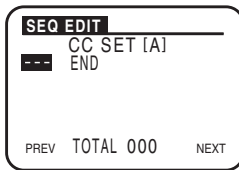

10. Insert a step line.

On the initial screen, nothing is set for the step, and END of the last line is highlighted.

Press the INS (SHIFT+ ▲) key with END highlighted to insert the step line 001.

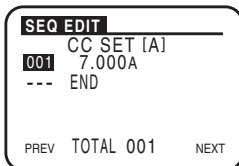

11. Set the current value of step 1.

On the initial screen, the current is set to 0.000.

Turn the rotary knob to set the current value of step 1 to 7 A.

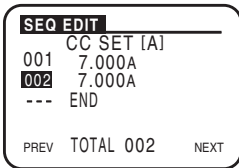

12. Set the current value of step 2.

Move the cursor to END and press the INS (SHIFT+ ▲) key.

Step line 002 is inserted. Like step 1, turn the rotary knob to set the current value of step 2 to 7 A.

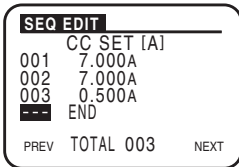

13. Set the current value of step 3.

Move the cursor to END and press the INS (SHIFT+ ▲) key.

Step line 003 is inserted. Like step 1, turn the rotary knob to set the current value of step 3 to 0.5 A.

After setting the current values, press the NEXT (SHIFT+ ►) key or the ENTER key to move to the next edit screen.

```

SEQ EDIT
[h:min:s.ms]
001 0:00:00.001
002 0:00:00.001
003 0:00:00.001
--- END
PREV TOTAL 003 NEXT

```

14. Set the execution time of step 1.

On the initial screen, the time is 0:00:00.001. Press the ▲ key to move the cursor to step 001. Since we are setting step 1 to 200 s (03 min:20 s), press the ◀ or ▶ CURSOR key to move the cursor to the digit you wish to change and turn the rotary knob.

When 60 s is exceeded, the digit is carried over to minutes (min). Therefore, keep turning the rotary knob until 03 (min):20 (s) is reached.

```

SEQ EDIT
[h:min:s.ms]
001 0:03:20.0--
002 0:02:30.0--
003 0:00:00.001
--- END
PREV TOTAL 003 NEXT

```

15. Set the execution time of step 2.

Press the ▼ key to move the cursor to step 002. Like step 1, turn the rotary knob to set the execution time of step 2 to 150 s (02 min:30 s).

16. Set the execution time of step 3.

Press the ▼ key to move the cursor to step 003. Like step 1, turn the rotary knob to set the execution time of step 3 to 80 s (01 min:20 s).

After setting the execution times, press the NEXT (SHIFT+ ▶) key or the ENTER key to move to the next edit screen.

```

SEQ EDIT
[h:min:s.ms]
001 0:03:20.0--
002 0:02:30.0--
003 0:01:20.0--
--- END
PREV TOTAL 003 NEXT

```

17. Set the execution pattern of step 1.

Since we are setting step 1 to load on and slope pattern, move the cursor to each item and set LOAD and RAMP to ON.

Leave TRIG and PAUSE at OFF.

18. Set the execution pattern of step 2 and 3.

Like step 1, move the cursor and set the execution pattern of step 2 (LOAD ON, RAMP OFF, TRIG OFF, and PAUSE OFF), and the execution pattern of step 3 (LOAD OFF, RAMP OFF, TRIG ON, PAUSE OFF).

We are done entering all the settings of program 1.

```

SEQ EDIT
LOAD RAMP TRIG PAUSE
001 ON ON OFF OFF
002 ON OFF OFF OFF
003 OFF OFF ON OFF
--- END
PREV TOTAL 003

```

■ Setting program 2

19. Move to the settings of program 2.

Press the PREV (SHIFT+ ◀) key three times to return to the program edit (SEQ) screen.

After returning to the program operation screen, check whether the cursor is blinking at the program number line.

20. Set the program number.

In program 2, set the program number to 2.

Move the ▼ CURSOR key to move to the next item.

21. Enter a memo.

Enter characters in the same fashion as step 3.

In program 2, enter “Program2”. After entering the memo, move the ▼ CURSOR key to move to the next item.

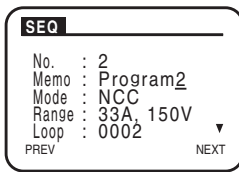

22. Select the operation mode, range, and the number of program loops.

Set the operation mode, range, and the number of program loops of program 2 in the same fashion as steps 4 to 6.

In program 2, set the operation mode to CC, the range to 33 A, 150 V (PLZ164W), and the number of program loops to 2.

At the last line, move the ▼ CURSOR key to move to the next item.

23. Set the load condition after the end of the program and the current value.

Select the load condition and the current value after the end of program 2 (executed twice) in the same fashion as steps 7 and 8.

Since the load is turned off and the current is set to 0 A after executing program 2 twice, set OFF and 0 A, respectively.

After setting the load condition and the current value, move the ▼ CURSOR key to move to the next item.

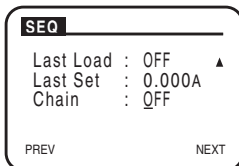

24. Set the number of the program to be executed next.

Since the sequence operation is ended after executing program 2 twice, select OFF.

Press the NEXT (SHIFT+ ►) key or ENTER key to move to the next edit screen.

■ Setting the steps of program 2

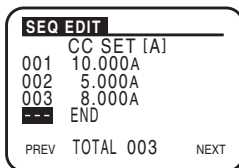

25. Set the current values of step 1 to 3.

Repeat steps 10 to 13 to set the current value of step 1 (10 A), the current value of step 2 (5 A), and the current value of step 3 (8 A).

After setting the current values, press the NEXT (SHIFT+ ►) key or the ENTER key to move to the next edit screen.

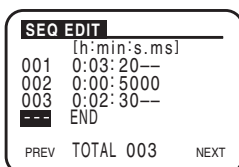

26. Set the execution times of step 1 to 3.

Repeat steps 14 to 16 to set the execution time of step 1 (200 s (03 min:20 s)), the execution time of step 2 (50 s), and the execution time of step 3 (150 s (02 min:30 s)).

After setting the execution times, press the NEXT (SHIFT+ ►) key or the ENTER key to move to the next edit screen.

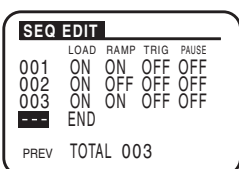

27. Set the execution patterns of step 1 to 3.

Repeat steps 17 and 18 to set the execution pattern of step 1 (LOAD ON, RAMP ON, TRIG OFF, and PAUSE OFF), the execution pattern of step 2 (LOAD ON, RAMP OFF, TRIG OFF, and PAUSE OFF), and the execution pattern of step 3 (LOAD ON, RAMP ON, TRIG OFF, and PAUSE OFF).

We are done entering all the settings of program 2.

28. Finish editing.

Pressing the PREV (SHIFT+ ◀) returns to the previous page.

Since we wish to return to the screen before entering the sequence edit screen, press the PREV (SHIFT+ ◀) key when the program edit (SEQ) screen is displayed.

■ Reediting and confirming the sequence

The program that you create is saved by the backup function even when the power is turned off. To confirm or reedit programs you have created, select sequence edit again.

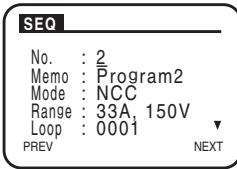

1. Select sequence edit.

Press the EDIT (SHIFT+A) key.

The program edit (SEQ) screen appears.

2. Select the number of the program you wish to confirm or edit.

Turn the rotary knob to display the number of the program you wish to confirm or edit.

When you select a program number, the corresponding program operation is displayed.

Press the NEXT (SHIFT+ ►) key or ENTER key to move to the next edit screen.

Press the PREV (SHIFT+ ◀) to return to the previous screen.

Switch the screen as you like and confirm or edit the settings.

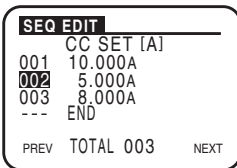

• Inserting steps

Press the ▼ or ▲ CURSOR key so that the step line below the line you wish to insert is highlighted. When the step line is highlighted, press the INS (SHIFT+ ▲) key. A new step line is inserted above the line where the cursor was.

• Deleting steps

Press the ▼ or ▲ CURSOR key so that the line you wish to delete is highlighted. When the step line is highlighted, press the DEL (SHIFT+ ▼) key. The step line at the cursor position is deleted.

3. Finish editing.

Pressing the PREV (SHIFT+ ◀) returns to the previous page.

Press the PREV (SHIFT+ ◀) key when the program edit (SEQ) screen is displayed to return to the screen before entering the sequence edit screen.

6.6.4 Overview of the Fast Sequence

To create a sequence, you must understand the concept of “program” and “step.”

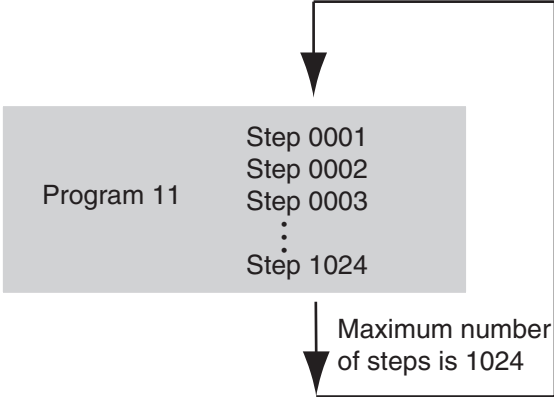

Fig. 6-17 Conceptual diagram of program and step

NOTE

- The operation modes that can be used in a fast sequence are CC and CR modes. In the explanation below, CC mode is used. When using CR mode, read the current values as resistance values.

• **Program**

The fast sequence can be saved only to program 11. Set the operation mode to CC or CR. The only method of executing the program is looping. Programs cannot be chained as in the normal sequence. The number of programs that can be saved is 1 (Program 11).

Below are the settings of a program.

- No. Program number (11)
- Memo Memo (up to 11 characters can be specified)
- Mode Operation mode of the program (CC or CR)
- Range Range of the program (Current range - Voltage range)
- Loop Number of program loops (1 to 9999 where 9999 is infinite loop)
- Last Load Load condition (OFF/ON) at program end
- Last Set Current value at program end (0 to 100 % of the range setting)
- RPTSTEP Last step number (3 to 1024) per loop
- TIME BASE Step execution time (25 μ s to 100 ms)

Resolution	25 μ s to 0.1 ms	25 μ s
	0.1 ms to 100 ms	100 μ s

A program is a collection of steps (execution unit). When program 11 is executed (RUN), steps are executed one by one in ascending order from step number 0001. The completion of the last step signifies the end of one program execution.

- **Step**

- Current Current for the step
- STEP Step number
- T Specify the step when you wish to output a trigger signal using T.

- **TRIG (trigger output)**

TRIG sets the presence or absence of trigger output. When turned on, a trigger signal is output from the TRIG OUT connector on the front panel at the same time as the step is executed.

(Example) Set trigger output at step number n (TRIG ON)

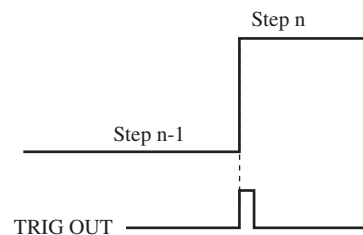

Fig. 6-18 TRIG sequence example

- **FILL function**

This function automatically sets the current values of steps in between two separated steps for which you specify the current values.

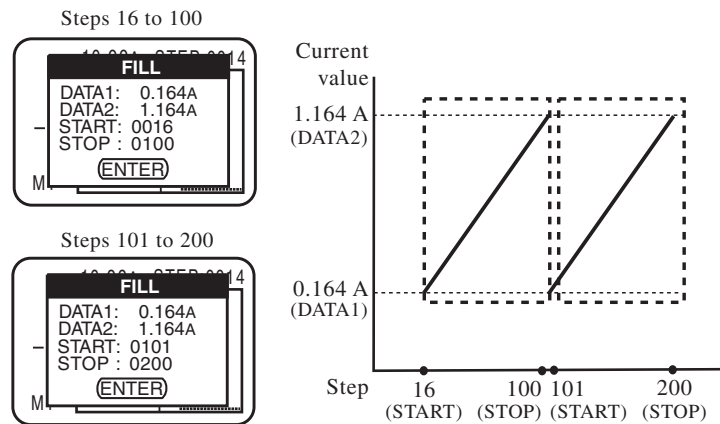

Fig. 6-19 Setup example using the FILL function

- DATA1 Current value at the start step (0.000 to 100 % of the range setting)
- DATA2 Current value at the end step (0.000 to 100 % of the range setting)
- START Start step number
- STOP End step number

In Fig. 6-19, the same waveform is repeated twice. DATA1 and DATA2 of the two waveforms are set to the same values, respectively, for each two-point interval. The values between two points are automatically assigned.

6.6.5 Fast Sequence Editing

The sequence edit screen is divided into the following four edit screens. When creating a sequence, items are set on each edit screen. This section describes the setup items on each edit screen and the setup procedure.

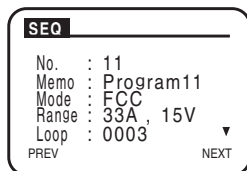

(1) Program operation

Set the program number (always set to 11), memo, operation mode, range, and the number of loops. (Top screen of the screen divided into top and bottom halves)

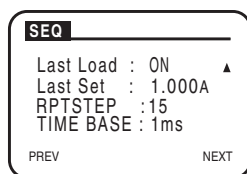

(2) Program end condition and step execution time

Set the program end condition, last step per loop, and step execution time. (Bottom screen of the screen divided into top and bottom halves)

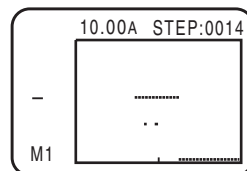

(3) Step setting and monitoring of the specified steps

Set the value (current or resistance) of the step to be executed one step at a time. You can set the presence or absence of trigger output.

To monitor the current of each step, set the magnification and move the steps.

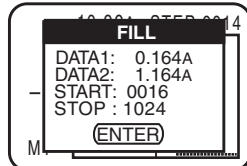

(4) FILL function

This function automatically sets the current values of steps in between two separated steps for which you specify the current values.

Common operations on the edit screens

The common operations carried out on the edit screens such as moving the cursor within the edit screen, selecting items, entering values and characters, and turning pages are the same as those for the normal sequence. For a description of the following items, see the respective sections for normal sequence.

- Moving the cursor
- Selecting items
- Entering values
- Entering characters (memo)
- Turning pages

Table6-4 Setup items on each setup screen

Edit screen	Setup item	Description
Program operation	No.	Program number (11)
	Memo	Memo (11 characters)
	Mode	Operation mode (CC or CR)
	Range	Range setting (Current range - Voltage range)
	Loop	Number of program loops (1 to 9999) 9999 is infinite loop
	Last Load	Load condition after the end of the sequence (ON/OFF)
	Last Set	Current value after the end of the sequence (0.000 to 100 % of the range setting)
	RPTSTEP	Last step number (3 to 1024) per loop
	TIME BASE	Step execution time (25 μ s to 100 ms)
FILL	DATA1	Current for the start step (0.000 to 100 % of the range setting)
	DATA2	Current for the end step (0.000 to 100 % of the range setting)
	START	Start step number
	STOP	End step number
Trigger signal	TRIG	Trigger output (ON/OFF)
Magnification	M1,2,3,4,5,6,7,8	The value indicates the number of skipped steps.

6.6.6 Sequence Example (Fast Sequence)

Programs are created using the PLZ-4W operation panel. This section describes the procedure of entering the following example sequence from the operation panel.

- **Flow of the example sequence**

In this example, we will assume a sequence that executes a program to simulate the waveform of Fig. 6-20.

The program execution repeats program 11 three times (point A to point B, point B to point C, and point C to point D). After executing three times, the sequence ends with the current value of 1 A (point E).

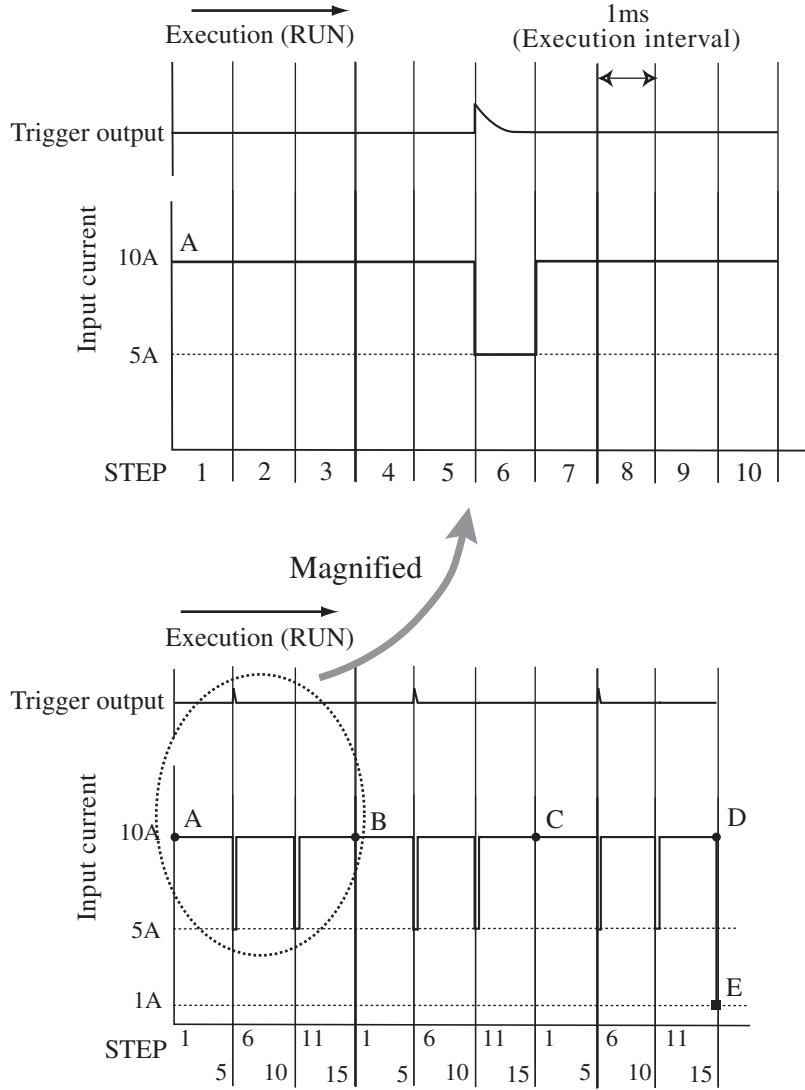
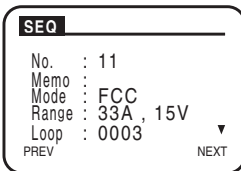

Fig. 6-20 Sequence execution example

- No. Program number (11)
- Memo Memo (PLZ164W)
- Range Current range-voltage range (33A-15V)
- Loop Number of program loops (3)
- Last Load Load condition at the end (ON)
- Last Set Current value at the end (1 A)
- RPTSTEP Last step per loop (15)
- TIME BASE Step execution time (1 ms)
- Current setting Steps 1 to 5: 10 A
Step 5: 5 A
Steps 7 to 10: 10 A
Step 11: 5 A
Steps 12 to 15: 10 A
- Trigger output Step 6

Creating the program



1. Select sequence edit.

Press the EDIT (SHIFT+A) key to display the program edit screen.

■ Setting the operation of program 11

2. Select the program number.

Turn the rotary knob to set the program number.

Select 11, because you can only select 11 for a fast sequence. After setting the program number, press the ▼ CURSOR key to move to the next item.

3. Enter a memo.

When adding a memo, turn the rotary knob to enter the characters.

In program 11, enter “Program11”. After entering the memo, move the ▼ CURSOR key to move to the next item.

4. Select the operation mode.

Turn the rotary knob to show the operation mode to be executed.

Select constant current mode “FCC.” After setting the operation mode, move the ▼ CURSOR key to move to the next item.

5. Sets the range.

Turn the rotary knob to select the current range and voltage range.

Set 33 A - 15 V. After setting the range, move the ▼ CURSOR key to move to the next item.

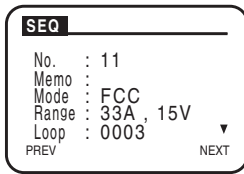

- 6.** Set the number of program loops.
 Turn the rotary knob to show the number of program loops.
 Set 0003 to specify 3 loops.
 At the last line, move the ▼ CURSOR key to move to the next item.

- 7.** Set the load condition after the end of the program.
 Turn the rotary knob to select the load condition.
 Since the load is turned on at the end of program 11, select ON.
 After setting the load condition, move the ▼ CURSOR key to move to the next item.

- 8.** Set the current setting after the end of the program.
 Turn the rotary knob to set the current value.
 Since the load is turned on at the end of program 11, select 1 A.
 After selecting the current setting, move the ▼ CURSOR key to move to the next item.

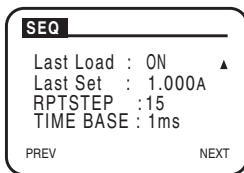

- 9.** Set the last step per loop for program 11.
 Turn the rotary knob to set the step number.
 Set 15.
 After setting the step number, move the ▼ CURSOR key to move to the next item.

- 10.** Set the step execution time.
 Turn the rotary knob to set the step execution time.
 Set 1 ms.
 After setting the step execution time, press the ENTER key to move to the next edit screen.

Setting the current value and trigger output of each step

We will set the current value and trigger output of each step of program 11.
 Here, we will set the current value first followed by the trigger output.

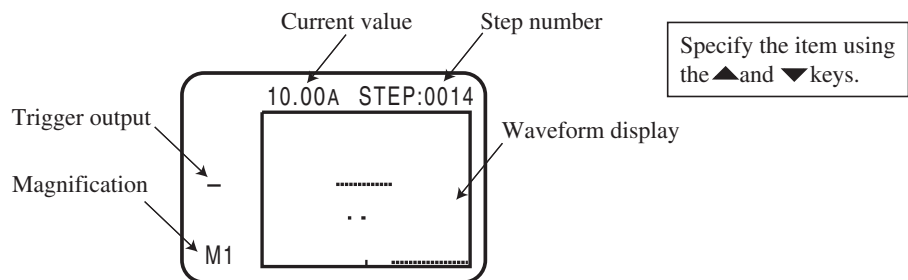

Fig. 6-21 Step setup screen

The following three items are specified.

- Step number
- Current value
- Presence or absence of trigger output

Press the ▲ or ▼ key to select the item, and turn the rotary knob to set the value or symbol.

11. Set step 1.

Press the ▲ or ▼ key to select the step number.

Turn the rotary knob to set the step to 0001.

Press the ▼ key to move the cursor to the current value, and turn the rotary knob to set the current value of step 1 to 10 A.

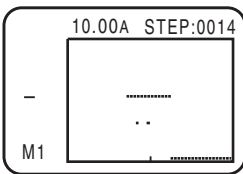

12. Set step 2.

Press the ▲ key to select the step number.

Turn the rotary knob to set the step to 0002.

Press the ▼ key to move the cursor to the current value, and turn the rotary knob to set the current value of step 2 to 10 A.

13. Set step 3 to 5.

Select the step number in the same fashion as step 12, and set the current value to 10 A.

14. Set step 6.

Select the step number in the same fashion as step 12, and set the current value to 5 A. Next, press the ▼ key to move the cursor to the trigger setting position, and turn the rotary knob to select T.

15. Set steps 7 to 10.

Select the step number in the same fashion as step 12, and set the current value to 10 A.

16. Set step 11.

Select the step number in the same fashion as step 14, and set the current value to 5 A.

But, for this step, the trigger is not set.

17. Set steps 12 to 15.

Select the step number in the same fashion as step 12, and set the current value to 10 A.

18. Finish editing.

The settings are shown within a rectangular frame on the screen. For a description of the monitor operation, see below.

Pressing the PREV (SHIFT+ ◀) returns to the previous page.

■ Monitoring the settings

1. Select sequence edit.
Press the EDIT (SHIFT+A) key to display the program edit screen.

2. Press the ENTER key to move to the monitor screen.

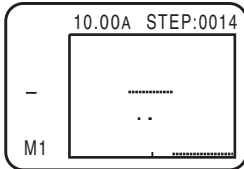

3. Set the magnification.

Press the ▼ key to move the cursor to magnification, and turn the rotary knob to set the magnification. Eight magnification types, M1, 2, 3, ..., 8 are available. Magnification M1 is the largest.

4. Select the step number.

Press the ▲ key to move the cursor to the step number. Turn the rotary knob to change the step. The waveform moves with the specified step centered in the rectangular frame.

The range that can be monitored is up to the last step per loop you specified.

At magnification M1, the waveform moves one step at a time when you turn the rotary knob. Thus, you can monitor the details. Likewise, the waveform moves 2 steps and 3 steps at a time for magnification M2 and M3, respectively. At magnification M8, the waveform moves 8 steps at a time.

5. Finish editing.

Pressing the PREV (SHIFT+ ◀) returns to the previous page.

■ FILL function operation

1. Select sequence edit.

Press the EDIT (SHIFT+A) key to display the program edit screen.

2. Press the ENTER key to move to the monitor screen.

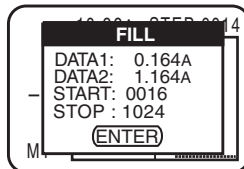

3. Press the INS (SHIFT+ ▲) key to move to the FILL screen.

4. Set the value.

Press the ▼ or ▲ key to move the cursor to the DATA1 value. Turn the rotary knob to set the current value of the start step. Likewise, set the current value of the end step at DATA2, the start step number at START, and the end step number at STOP.

NOTE

- The end step number can be set up to 1024, but the range that can be monitored is the last step per loop specified by RPTSTEP.
-

5. Finish editing.

Press the ENTER key to move to the monitor screen.

6.6.7 Executing, Pausing, Stopping the Sequence

■ Executing the Sequence

1. Check that the switching function and short function are turned off.
Check that the SW ON key is turned off and that the short icon is not displayed. Even if turned on, the switching function and short function are forcibly turned off when the sequence execution screen is entered.

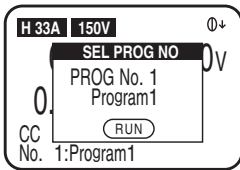

2. Enter the sequence execution screen.
Press the RUN/STOP (SHIFT+B) or PAUSE (SHIFT+C) key.

The sequence execution screen appears.

3. Select the program number to be executed.
Turn the rotary knob to show the program number to be executed.
Select 1 to 10 for normal sequence or 11 for fast sequence.

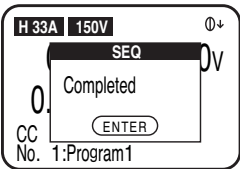

4. Execute the sequence.
Press the RUN/STOP (SHIFT+B) key to execute the selected program.
The measured values during execution are shown on the display.
When the sequence operation is completed., a pop-up window appears.
5. Press the ENTER key to exit from the sequence execution screen.

NOTE

- If you press the RUN/STOP (SHIFT+B) key again after stopping the sequence, the selected program is executed from the beginning.

■ Pausing the sequence.

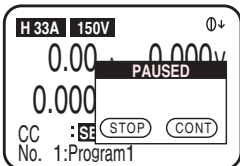

While the sequence is executing, press the PAUSE (SHIFT+C) key.

The PAUSE screen appears, and the sequence operation pauses.

To resume the operation, press the PAUSE (SHIFT+C) key again. If you press the RUN/STOP (SHIFT+B) key when the sequence is paused, the sequence operation stops.

NOTE

- If a pause is specified in a step (PAUSE ON), the sequence operation automatically stops after executing the step. In this case also, press the PAUSE (SHIFT+C) key to resume the operation.

■ Stopping the sequence.

Press the RUN/STOP (SHIFT+B) key.

The selected program stops.

When sequences cannot be executed

Sequences cannot be executed across different modes and ranges.

1. You cannot execute a sequence if the mode or range of the chained program is different. Check the settings.
2. If the load is turned on and the current mode and range settings do not match the settings of the sequence that you are trying to execute, you cannot execute the sequence. Turn off the load, and set the sequence settings to match the current settings.
3. If the load is turned off and the current mode and range settings do not match the settings of the sequence that you are trying to execute, the settings of the sequence that you are trying to execute are forcibly changed to the current settings, and the sequence is executed.

Table 6-5

Before sequence execution		Sequence execution	
Load on/off condition	Mode and range settings that you are trying to execute	Execution	Mode and range settings that are executed
Load on	Matches the current settings	Possible	Same as the current settings
	Do not match the current settings	Not possible	
Load off	Matches the current settings	Possible	Same as the current settings
	Do not match the current settings	Possible	Forcibly changed to the current settings

6.7 Remote Sensing Function

Remote sensing is a function used to correct the voltage drop caused by the resistance of the load wire when it cannot be discarded. Execute remote sensing to accurately set the resistance, voltage, and power.

Remote sensing improves the transient characteristics in the CR, CV, and CP modes and thereby achieves stable operation.

■ Remote sensing wiring

Connect the remote sensing on the rear panel (+S) and the positive terminal of the equipment under test. Likewise, connect the remote sensing (-S) to the negative terminal.

The remote sensing should be wired at the nearest to the EUT.

■ Electric wire used

You do not have to take into account the allowable current as in the load wire. However, for mechanical strength, use a wire with a nominal cross-sectional area of 0.5 mm^2 or more.

Use crimp terminals for M3 screws for the connection on the PLZ-4W end.

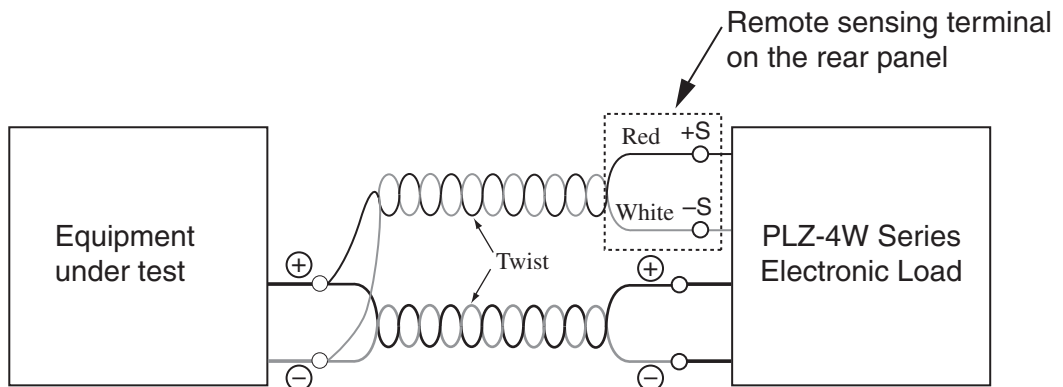

Fig. 6-22 Remote sensing wiring

6.8 External Control

6.8.1 Overview and Precaution of External Control

The settings in each operation mode normally use the internal reference signal. In external control, this reference signal is supplied externally. The external signal is either voltage (voltage control) or resistance (resistance control).

External control can control the settings from 0 % to 100 % of the selected range in the CC, CR, CP, or CV mode.

Table 6-6 External control using voltage or resistance

Control method	Operation mode	Description
Voltage	CC, CP, CV	Change of 0 V to 10 V produces a change of 0 % to 100 % of the rated value of the range
	CR	Change of 0 V to 10 V produces a change of maximum value to minimum value of the range
Resistance (proportional)	CC, CP, CV	Change of 0 Ω to 10 k Ω produces a change of 0 % to 100 % of the rated value of the range
	CR	Change of 0 Ω to 10 k Ω produces a change of maximum value to minimum value of the range
Resistance (inverse proportional)	CC, CP, CV	Change of 10 k Ω to 0 Ω produces a change of 0 % to 100 % of the rated value of the range
	CR	Change of 10 k Ω to 0 Ω produces a change of maximum value to minimum value of the range

There are other external controls as indicated below.

Table 6-7 Other external controls

Function	Description
Load on/off	Turns on/off the load and monitor the load
Current range switching	Controls the range of each operation mode or monitor the range
Trigger input	Clear the pause in sequence operation
Alarm input	Forcibly activates an alarm
Current monitor	Monitors the input current
Short signal	Relay contact output

Precaution when operating under high-speed load simulations

When operating under high-speed load simulations, do not connect the common terminal of the external device and the terminal of the EUT which connects to the negative polarity of load input terminal of the PLZ-4W. Attach the ferrite core on the connecting wire between the external device and the PLZ-4W.

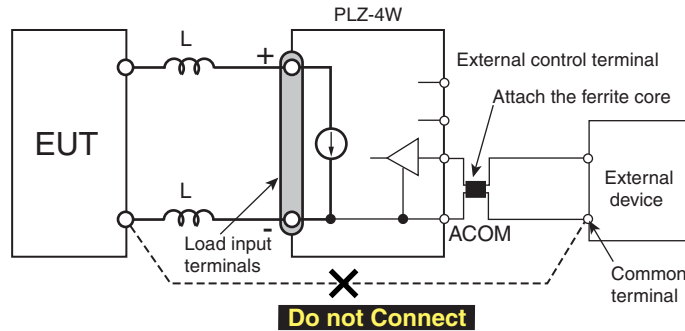

Fig. 6-23 When operation under high-speed load simulations

6.8.2 J1/J2 connector

The J1 and J2 connectors on the rear panel are of the same shape and the same number of pins. However, J1 is assigned to external control while J2 is assigned to parallel operation. For details on the pin arrangement, see Table 6-9 or Table 6-10.

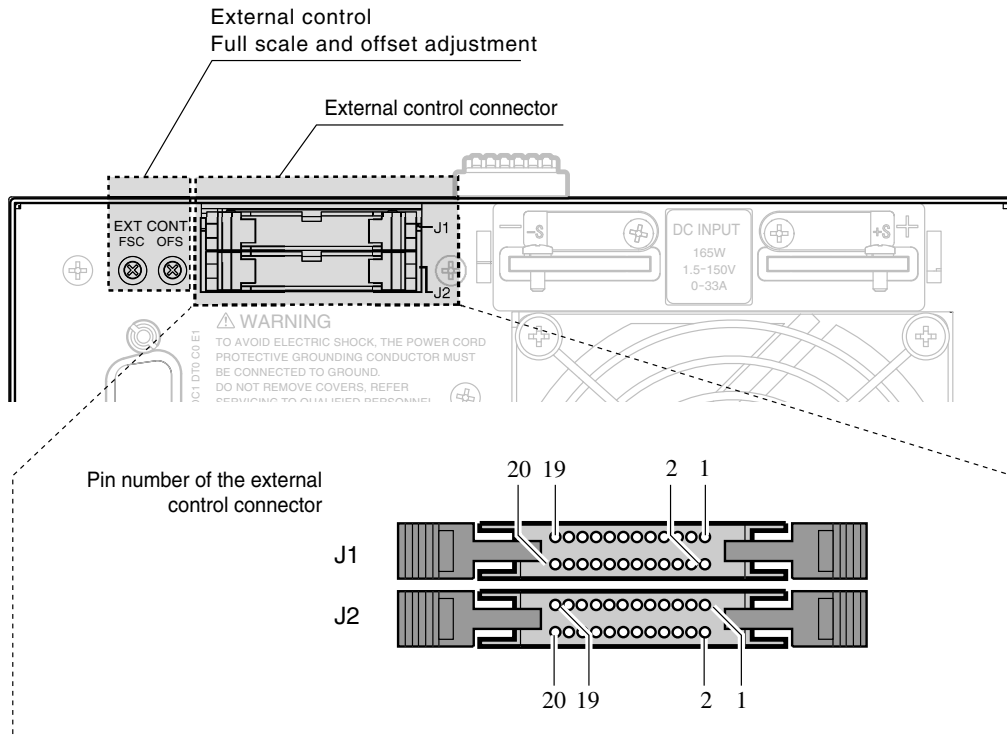

Fig. 6-24 Rear panel

-
- ⚠ WARNING**
- When the PLZ-4W is shipped from the factory, protection dummy plugs are attached to the J1 and J2 connectors. To prevent the possibility of electric shock, leave the dummy plug attached to the connectors when you are not using them.
- ⚠ CAUTION**
- To disconnect the connector, remove the lock levers located on either side and pull the connector itself.
 - Be sure to turn off the PLZ-4W when attaching or removing the connector.
 - J1 and J2 connectors are physically the same. Use caution not to use the wrong connector to prevent a malfunction.
-

Connecting to the connector

The connector parts needed to connect the J1/J2 connector (standard MIL connector 20-pin) are not provided. Table 6-8 shows the recommended connector.

-
- NOTE**
- When using a flat cable, be sure to use a connector with a strain relief.
 - To press-fit discrete wires or flat cables, be sure to use a special tool. For a description of applicable cables and tools, see the relevant catalogs of connector manufacturers.
-

Table 6-8 Connectors supported by manufacturers

Manufacturer	Product	Notes
Omron	XG5M-2032 or XG5M-2035 XG5S-1001 (2 pcs.)	For discrete wires
Omron	XG4M-2030 XG4T-2004	For flat cables
KEL	6200-020-601	For flat cables

An optional connector kit is available for making the connection. For details, see page 1-8 “Analog remote control connector kit (OP01-PLZ-4W)”.

Table6-9 J1 connector pin arrangement

Pin No.	Signal name	Description
1	EXT R/V CONT	Can be used in CC, CR, CV, and CP modes
		0 V to 10 V correspond to 0 % to 100 % of the rated current (CC mode), rated voltage (CV mode), or rated power (CP mode). 0 V to 10 V correspond to maximum resistance to minimum resistance (CR mode)
		0 Ω to 10 k Ω correspond to 0 % to 100 % or 100 % to 0 % of the rated current (CC mode), rated voltage (CV mode), or rated power (CP mode). 0 Ω to 10 k Ω correspond to maximum resistance to minimum resistance or minimum resistance to maximum resistance (CR mode)
2	IMON	Current monitor output 10 V f.s (H/L range) and 1 V f.s (M range)
3	A COM	Connected to the negative load input terminal on the rear panel.
4	SUM I MON	Used during master/slave operation. Connected to SUM I MON of the J2 connector.
5	PRL IN+	Used during master/slave operation. Connected to PRL OUT+ of the J2 connector.
6	PRL IN-	Used during master/slave operation. Connected to PRL OUT- of the J2 connector.
7	LOAD ON/OFF CONT	Turns on the load with low (or high) TTL level signal Pulled up the internal circuit to 5 V using 10 k Ω
8	RANGE CONT 1	External range switch input ^{*1 *2}
9	RANGE CONT 0	Pulled up the internal circuit to 5 V using 10 k Ω
10	ALARM INPUT	Activates alarm with low TTL level signal input. Pulled up the internal circuit to 5 V using 10 k Ω
11	TRIG INPUT	When paused, clears the pause when a high level TTL signal is applied for 10 μ s or longer. Pulled down the internal circuit to A COM using 100 k Ω
12	A COM	Connected to the negative load input terminal on the rear panel.
13	LOAD ON STATUS	Turns on when load is on. Open collector output by a photocoupler. ^{*4}
14	RANGE STATUS 1	Range status output. Open collector output by a photocoupler. ^{*4}
15	RANGE STATUS 0	
16	ALARM STATUS	Turns on when an alarm (OVP, OCP, OPP, OHP, REV, or UVP) is activated or when an external alarm is applied. Open collector output by a photocoupler. ^{*4}
17	STATUS COM	STATUS signal common for pins 13 to 16.
18	N.C.	
19	SHORT SIGNAL OUT	Relay contact output (30 VDC/1 A)
20	SHORT SIGNAL OUT	

*1. Valid only when the front panel settings is H range.

*2.

	RANGE CONT 0	RANGE CONT 1
H range	1	1
M range	1	0
L range	0	1

*3.

	RANGE STATUS 0	RANGE STATUS 1
H range	OFF	OFF
M range	OFF	ON
L range	ON	OFF

*4. The maximum applied voltage of the photocoupler is 30 V; the maximum current is 8 mA.

Table 6-10 J2 connector pin arrangement

Pin No.	Signal name	Description
1	N.C.	
2	N.C.	
3	N.C.	
4	SUM I MON	Connect to SUM I MON of the J1 connector.
5	PRL OUT+	Used during master/slave operation. Connected to PRL IN+ of the J1 connector.
6	PRL OUT-	Used during master/slave operation. Connected to PRL IN- of the J1 connector.
7	N.C.	
8	N.C.	
9	SLAVE RANGE CONT	Used during master/slave operation. Connected to RANGE CONT 0 of the J1 connector.
10	N.C.	
11	N.C.	
12	A COM	Connected to the negative load input terminal on the rear panel.
13	N.C.	
14	N.C.	
15	N.C.	
16	ALARM INPUT	Activates an alarm with high (or low) TTL level signal input. Pulled up the internal circuit to 5 V.
17	A COM	Connected to the negative load input terminal.
18	N.C.	
19	N.C.	
20	+15V	Controls the on/off of the load booster power (cannot be used for multiple purposes).

6.8.3 External Control of CC Mode

The external control of CC mode can be carried out using external voltage or external resistance. The input current varies proportionally to the external voltage or external resistance.

(1) External voltage control

Applying an external voltage in the range of 0 V to 10 V to the PLZ-4W produces an input current that is proportional to the change.

The input current corresponding to the external voltage of 0 V is 0 A; the input current corresponding to the external voltage of 10 V is 100 % of the specified range.

Connected pins: J1-1 (signal), J1-3 (common)

- CAUTION**
- The maximum voltage that can be applied across pins 1 and 3 of the J1 connector is ± 11 V. Applying a voltage exceeding this value can damage the PLZ-4W.
 - Accuracy is not guaranteed for voltages below 0 V and above 10 V.
 - Pin 3 of the J1 connector is connected the negative load input terminal. To prevent damaging the PLZ-4W, be sure not to let the wire of pin 3 touch any other pins.

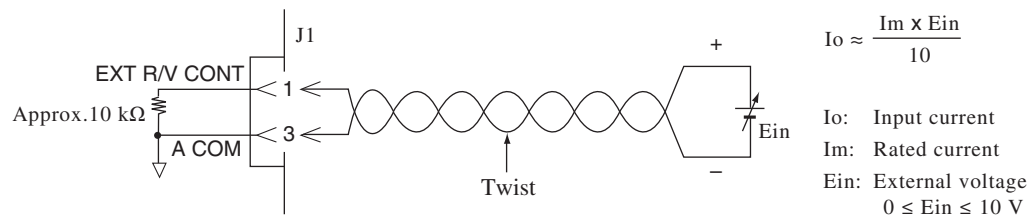

Fig. 6-25 Equivalent circuit

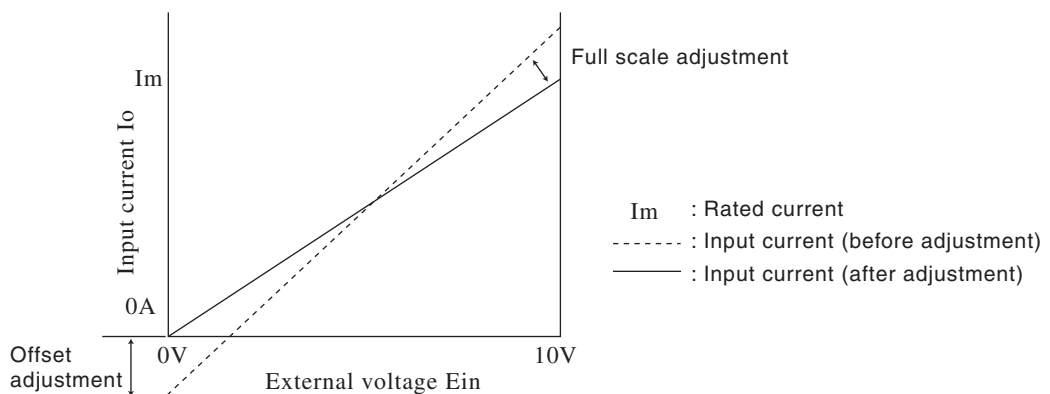

Fig. 6-26 Control the current using external voltage

■ Setup procedure for external voltage control

This procedure is common to CC, CR, CP, and CV modes. Follow this procedure for modes other than CC mode.

NOTE

- Use external voltage of low noise and high stability.
 - Use twisted wires for the signal wires. This can prevent disturbance from noise.
-

1. Check that the power is turned off.
2. Connect the external voltage.
Connect the external voltage across pins 1 and 3 of the J1 connector.
3. Turn on the power.
4. Check that the load is turned off.
Check that the LOAD LED is turned off. If the LED is illuminated, press the LOAD key to cut off the current.
5. Set the operation mode and current range.
Press the MODE key to select the operation mode.
Press the RANGE key to set the current range. When also controlling the current range externally, be sure to select H range on the panel.
6. Select the menu setup.
Press the MENU (SHIFT+SET/VSET) key.
The the menu appears.
7. Select Configuration
Press the ▼ or ▲ CURSOR key several times until Configuration is highlighted on the menu. When highlighted, press the ENTER key.
8. Select External.
Press the ▼ or ▲ CURSOR key several times until External is highlighted on the menu. When highlighted, press the ENTER key.
9. Select voltage control.
Press the ▲ CURSOR key to move the cursor (blinking) to the Control line.
Turn the rotary knob to select V.
10. Exit from the menu.
Press the MENU (SHIFT+SET/VSET) key.
The original screen displayed before entering menu setup appears.
11. Power cycle the PLZ-4W.
The menu settings are confirmed.

NOTE

- You can prevent the settings from being changed inadvertently during measurement by pressing the LOCK (SHIFT+LOCAL) key to enable the lock.
-

■ Accurately proportionating the external voltage variation and input current variation

You can use the pre-set resistors OFS and FSC on the PLZ-4W rear panel to adjust the current offset value and maximum current value, respectively. The adjustment enables control that is accurately proportional to the external voltage. The adjustment is valid for the specified range. If you change the range, make a readjustment.

NOTE

- Adjustment is made by actually supplying the load current. Prepare the power supply to be tested.
-

1. Turn on the load.
2. Set the external voltage to 0 V.
3. Turn OFS to set the current reading of the display measurement section to 0 A.
4. Set the external voltage to 10 V.
5. Turn FSC to set the current reading of the display measurement section to 100 % of the selected range.
6. Turn off the load to finish the adjustment.

(2) External resistance control

Connecting an external resistance in the range of 0 Ω to 10 kΩ to the PLZ-4W produces an input current that is proportional or inversely proportional to the change.

Proportional control

The input current corresponding to the external resistance of 0 Ω is 0 A; the input current corresponding to the external resistance of 10 kΩ is 100 % of the specified range.

Inverse proportional control

The input current corresponding to the external resistance of 10 kΩ is 0 A; the input current corresponding to the external resistance of 0 Ω is 100 % of the specified range.

Connected pins: J1-1 (signal), J1-3 (common)

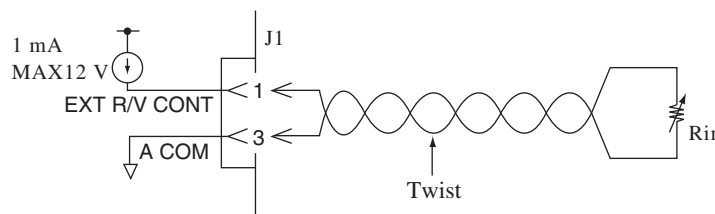

Proportional control

$$I_o \approx I_m \left(\frac{R_{in}(k\Omega)}{10} \right)$$

Inverse proportional control

$$I_o \approx I_m \left(1 - \frac{R_{in}(k\Omega)}{10} \right)$$

I_o : Input current

I_m : Rated current

R_{in} : External variable resistor

$0 \leq R_{in} \leq \text{Approx. } 10 \text{ k}\Omega$

Fig. 6-27 Equivalent circuit

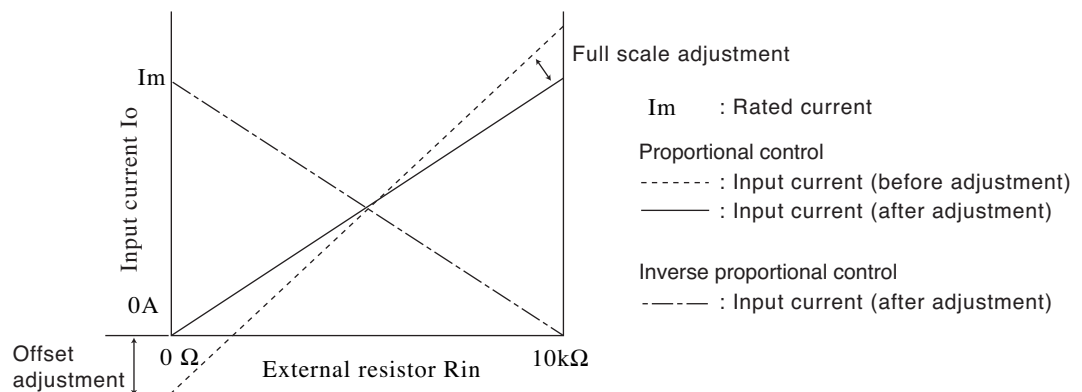

Fig. 6-28 Control the current using external resistance

■ Setup procedure for external resistance control

This procedure is common to CC, CR, CP, and CV modes. Follow this procedure for modes other than CC mode.

NOTE

- It is recommended that the external variable resistor connected to the PLZ-4W be a wire wound resistor, metal film resistor, or multirotational potentiometer that is resistant to temperature and aging. The residual resistance must be less than 50 Ω when set to the minimum resistance.
 - Set the resistance to the minimum when using proportional control; set the resistance to the maximum when using inverse proportional control.
 - Use twisted wires for the signal wires. This can prevent disturbance from noise.
-

- 1.** Check that the power is turned off.
- 2.** Connect the external resistance.
Connect the external variable resistor across pins 1 and 3 of the J1 connector.
- 3.** Turn on the power.
- 4.** Check that the load is turned off.
Check that the LOAD LED is turned off. If the LED is illuminated, press the LOAD key to cut off the current.
- 5.** Set the operation mode and current value.
Press the MODE key to select the operation mode.
Press the RANGE key to set the current range. When also controlling the current range externally, be sure to select H range on the panel.
- 6.** Select the menu setup.
Press the MENU (SHIFT+SET/VSET) key.
The menu appears.
- 7.** Select Configuration
Press the ▼ or ▲ CURSOR key several times until Configuration is highlighted on the menu. When highlighted, press the ENTER key.
- 8.** Select External.
Press the ▼ or ▲ CURSOR key several times until External is highlighted on the menu. When highlighted, press the ENTER key.
- 9.** Select resistance control.
Press the ▲ CURSOR key to move the cursor (blinking) to the Control line.
To use proportional control, turn the rotary knob to select R.
To use inverse proportional control, turn the rotary knob to select Rinv.
- 10.** Exit from the menu.
Press the MENU (SHIFT+SET/VSET) key.
The original screen displayed before entering menu setup appears.
- 11.** Power cycle the PLZ-4W.
The menu settings are confirmed.

NOTE

- You can prevent the settings from being changed inadvertently during measurement by pressing the LOCK (SHIFT+LOCAL) key to enable the lock.
-

■ Accurately proportionating the external resistance variation and input current variation

You can use the pre-set resistors OFS and FSC on the PLZ-4W rear panel to adjust the current offset value and maximum current value, respectively. The adjustment enables control that is accurately proportional to the external resistance. The adjustment is valid for the specified range. If you change the range, make a readjustment.

NOTE

- Adjustment is made by actually supplying the load current. Prepare the power supply to be tested.
-

For proportional control

1. Turn on the load.
2. Set the external resistance to 0 Ω .
3. Turn OFS to set the current reading of the display measurement section to 0 A.
4. Set the external resistance to 10 k Ω .
5. Turn FSC to set the current reading of the display measurement section to 100 % of the selected range.
6. Turn off the load to finish the adjustment.

For inverse proportional control

Set the external resistance to 10 k Ω at step 2. Set the external resistance to 0 Ω at step 4.

6.8.4 External Control of CR Mode

The external control of CR mode can be carried out using external voltage or external resistance. The resistance varies proportionally to the external voltage or external resistance.

(1) External voltage control

Applying an external voltage in the range of 0 V to 10 V to the PLZ-4W produces a resistance proportional to the change.

The external voltage of 0 V and 10 V correspond to the maximum and minimum resistances of the range, respectively.

Connected pins: J1-1 (signal), J1-3 (common)

-
- CAUTION**
- The maximum voltage that can be applied across pins 1 and 3 of the J1 connector is ± 11 V. Applying a voltage exceeding this value can damage the PLZ-4W.
 - Pin 3 of the J1 connector is connected the negative load input terminal. To prevent damaging the PLZ-4W, be sure not to let the wire of pin 3 touch any other pins.
-

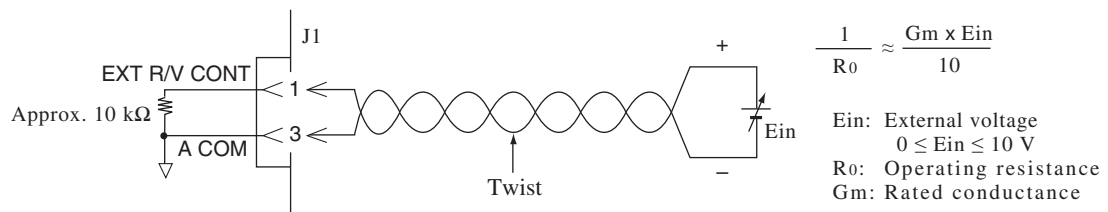

Fig. 6-29 Equivalent circuit

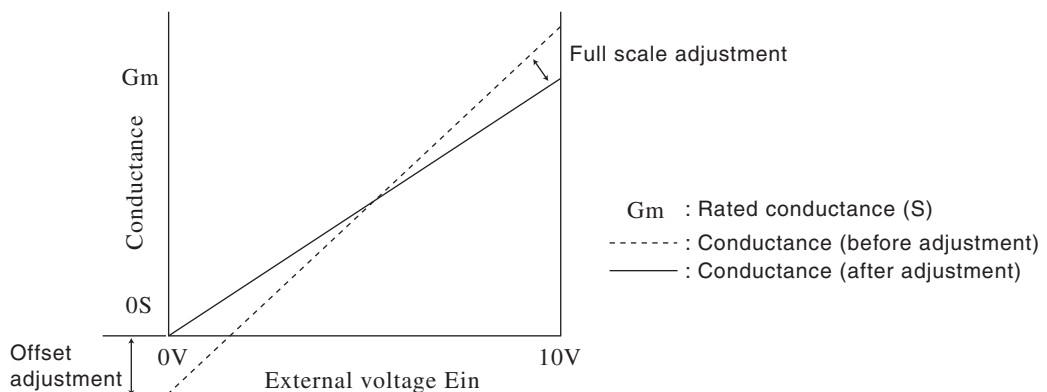

Fig. 6-30 Control the resistance using external voltage

■ The setup procedure is the same as with CC mode.

See page 6-45 “Setup procedure for external voltage control”.

(2) External resistance control

Connecting an external resistance in the range of 0 Ω to 10 kΩ to the PLZ-4W produces a resistance that is proportional or inversely proportional to the change.

Proportional control

The external voltage of 0 Ω and 10 kΩ correspond to the maximum and minimum resistances of the range, respectively.

Inverse proportional control

The external voltage of 10 kΩ and 0 Ω correspond to the maximum and minimum resistances of the range, respectively.

Connected pins: J1-1 (signal), J1-3 (common)

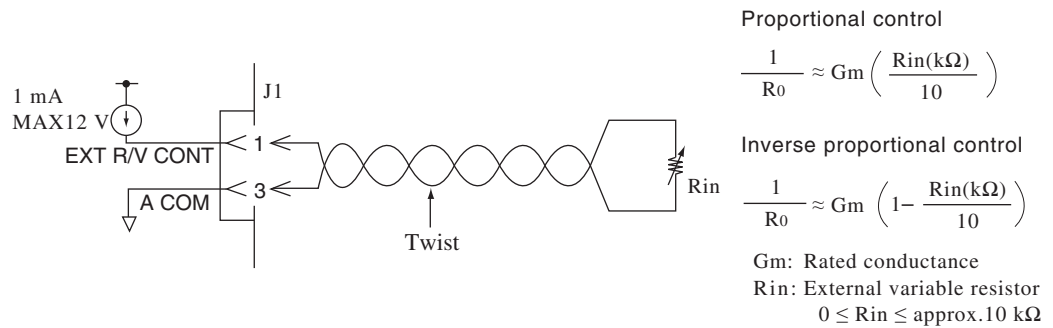

Fig. 6-31 Equivalent circuit

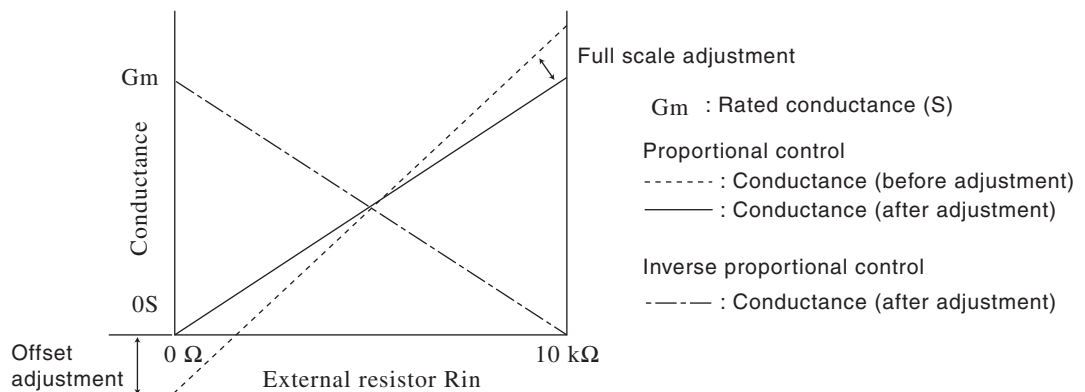

Fig. 6-32 Control the resistance using external resistance

■ The setup procedure is the same as with CC mode.

See page 6-45 “Setup procedure for external voltage control”.

6.8.5 External Control of CP Mode

The external control of CP mode can be carried out using external voltage or external resistance. The wattage varies in proportion to the external voltage or external resistance.

(1) External voltage control

Applying an external voltage in the range of 0 V to 10 V to the PLZ-4W produces a wattage proportional to the change.

The wattage corresponding to the external voltage of 0 V is 0 W; the wattage corresponding to the external voltage of 10 V is 100 % of the specified range.

Connected pins: J1-1 (signal), J1-3 (common)

- CAUTION**
- The maximum voltage that can be applied across pins 1 and 3 of the J1 connector is ± 11 V. Applying a voltage exceeding this value can damage the PLZ-4W.
 - Pin 3 of the J1 connector is connected the negative load input terminal. To prevent damaging the PLZ-4W, be sure not to let the wire of pin 3 touch any other pins.

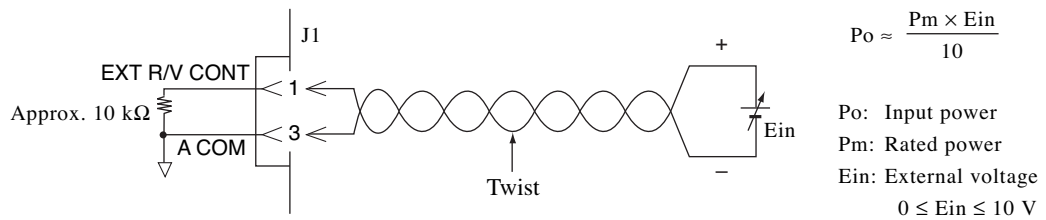

Fig. 6-33 Equivalent circuit

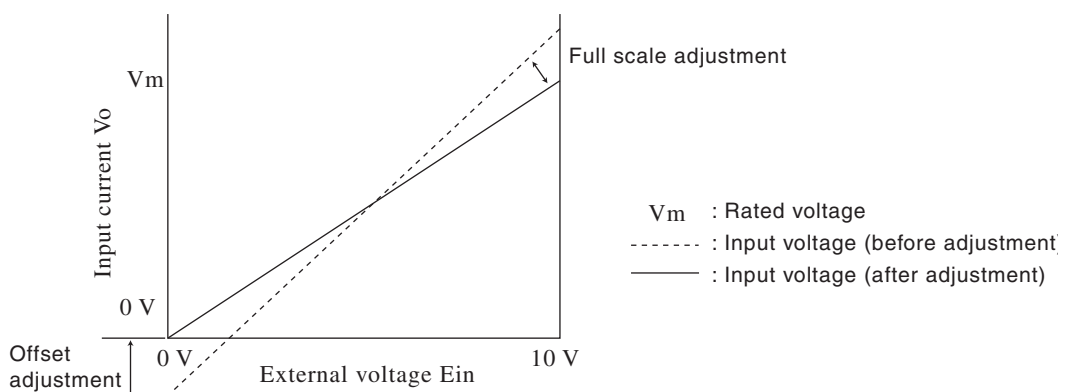

Fig. 6-34 Control the resistance using external voltage

■ The setup procedure is the same as with CC mode.

See page 6-45 “Setup procedure for external voltage control”.

(2) External resistance control

Connecting an external resistance in the range of 0 Ω to 10 kΩ to the PLZ-4W produces a wattage that is proportional or inversely proportional to the change.

Proportional control

The wattage corresponding to the external resistance of 0 Ω is 0 W; the wattage corresponding to the external resistance of 10 kΩ is 100 % of the specified range.

Inverse proportional control

The wattage corresponding to the external resistance of 10 kΩ is 0 W; the wattage corresponding to the external resistance of 0 Ω is 100 % of the specified range.

Connected pins: J1-1 (signal), J1-3 (common)

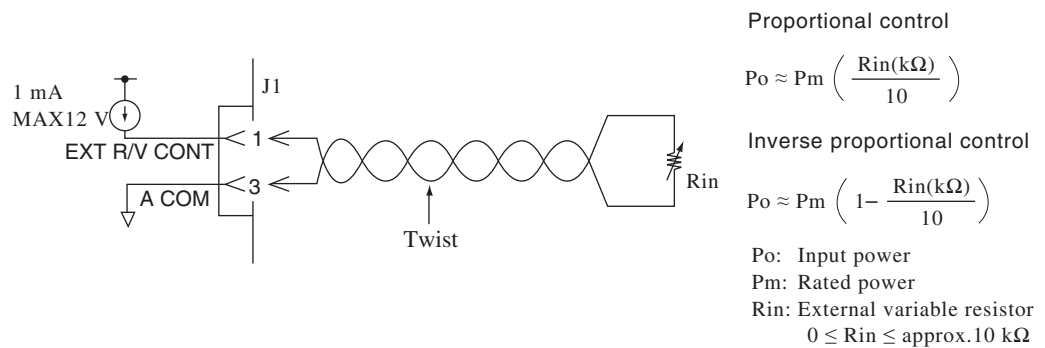

Fig. 6-35 Equivalent circuit

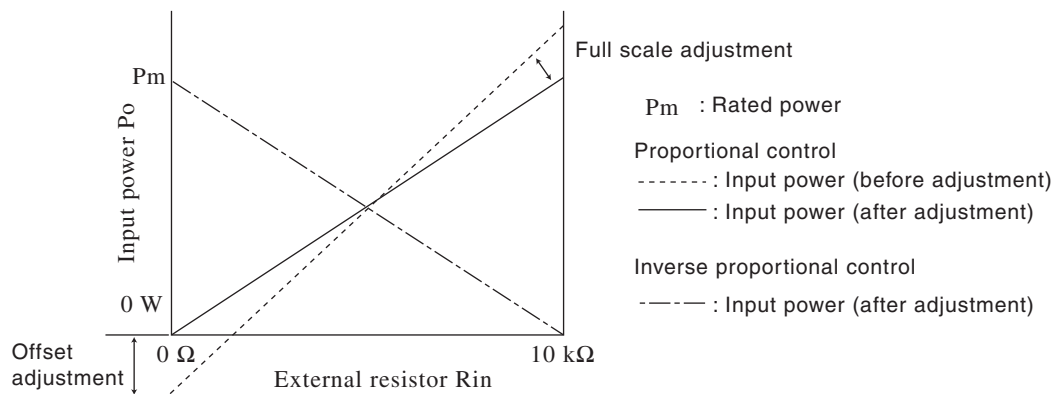

Fig. 6-36 Control the wattage using external resistance

■ The setup procedure is the same as with CC mode.

See page 6-45 “Setup procedure for external voltage control”.

6.8.6 External Control of CV Mode

The external control of CV mode can be carried out using external voltage or external resistance. The voltage varies in proportion to the external voltage or external resistance.

(1) External voltage control

Applying an external voltage in the range of 0 V to 10 V to the PLZ-4W produces a voltage proportional to the change.

The voltage corresponding to the external voltage of 0 V is 0 V; the voltage corresponding to the external voltage of 10 V is 100 % of the specified range.

Connected pins: J1-1 (signal), J1-3 (common)

-
- CAUTION**
- The maximum voltage that can be applied across pins 1 and 3 of the J1 connector is ± 11 V. Applying a voltage exceeding this value can damage the PLZ-4W.
 - Pin 3 of the J1 connector is connected the negative load input terminal. To prevent damaging the PLZ-4W, be sure not to let the wire of pin 3 touch any other pins.
-

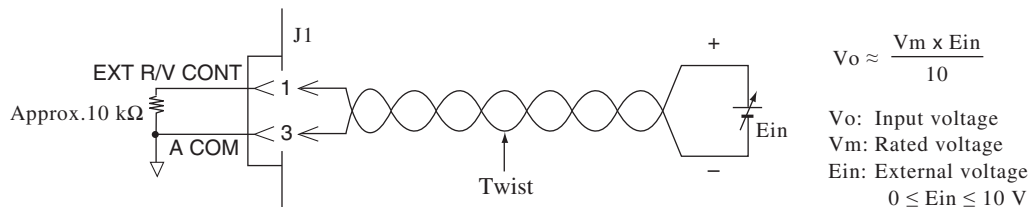

Fig. 6-37 Equivalent circuit

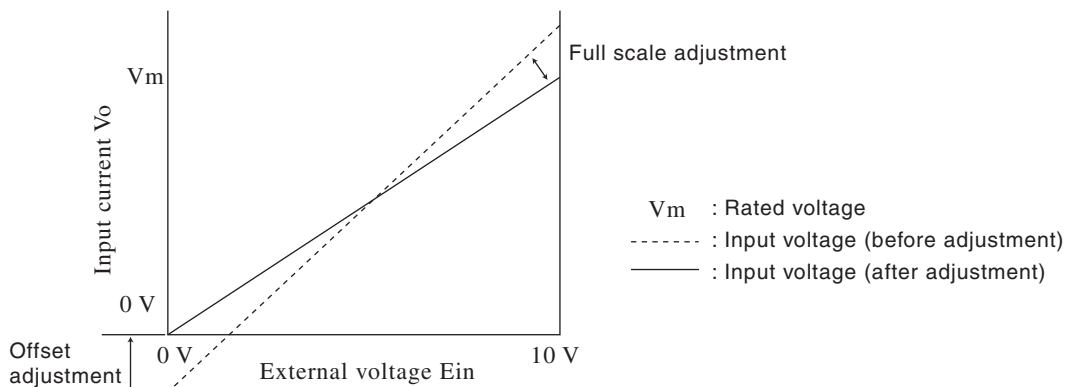

Fig. 6-38 Control the current using external voltage

■ The setup procedure is the same as with CC mode.

See page 6-45 “Setup procedure for external voltage control”.

(2) External resistance control

Connecting an external resistance in the range of 0 Ω to 10 kΩ to the PLZ-4W produces a voltage that is proportional or inversely proportional to the change.

Proportional control

The voltage corresponding to the external resistance of 0 Ω is 0 V; the voltage corresponding to the external resistance of 10 kΩ is 100 % of the specified range.

Inverse proportional control

The voltage corresponding to the external resistance of 10 kΩ is 0 V; the voltage corresponding to the external resistance of 0 Ω is 100 % of the specified range.

Connected pins: J1-1 (signal), J1-3 (common)

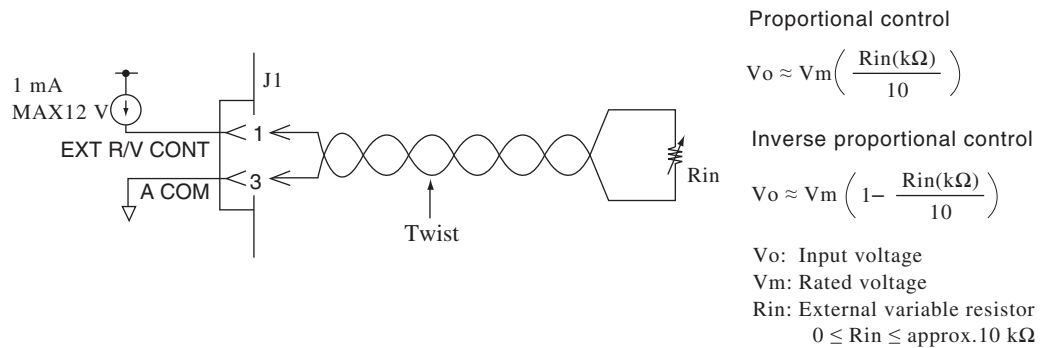

Fig. 6-39 Equivalent circuit

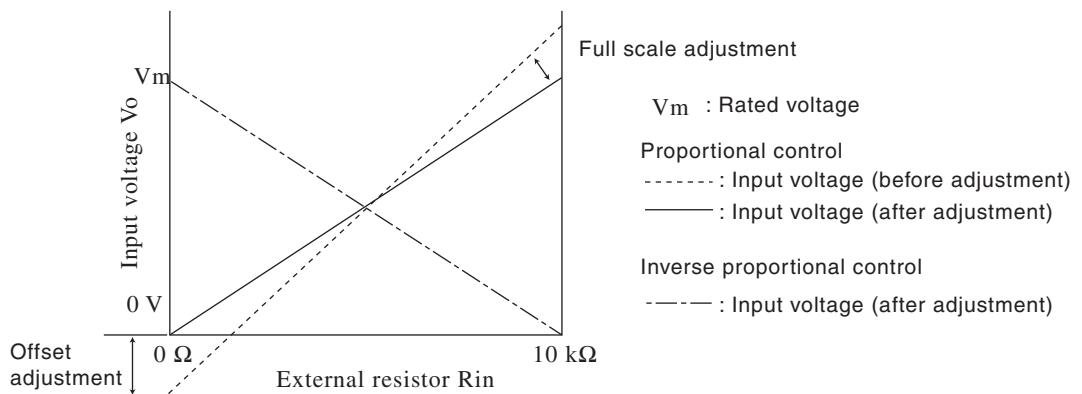

Fig. 6-40 Control the wattage using external resistance

■ The setup procedure is the same as with CC mode.

See page 6-45 “Setup procedure for external voltage control”.

6.8.7 External Control of Load On and Load Off

The external control connector can be used to control the on/off of the load and monitor the on/off condition.

External contact control

To control the load on/off using an external contact, an external signal is applied across pins 7 and 12 of the J1 connector.

Even when the load on/off is controlled through the external contact, the LOAD switch on the panel is effective when the load is turned on externally. However, when the load is turned off externally, the LOAD switch cannot be used to turn the load on.

You can select the logic used to externally control the load on/off using the menu setup. To change the logic, select “2. Configuration” | “4. External” | “Load On IN” from the menu and specify LOW or HIGH.

- For a description of changing the menu setup, see section 5.13, “Menu Setup.”

Table 6-11 Load on/off logic setting

Load On IN	External contact (SW)	
	ON (close)	OFF (open)
LOW	Load on	Load off
HIGH	Load off	Load on

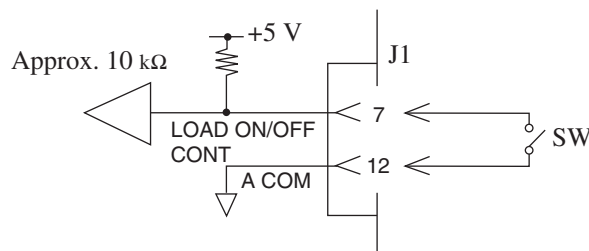

Fig. 6-41 Equivalent input circuit

NOTE

- The input terminal is connected to +5 V of the J1 connector through approximately 10 kΩ of resistance. The maximum allowable voltage is 5 V, and the operation threshold level is TTL.

Status signal output

To externally monitor the load on/off condition, the output signal across pins 13 and 17 of the J1 connector is monitored.

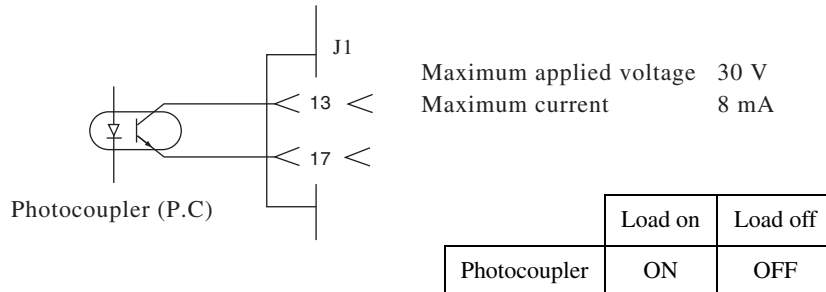

Fig. 6-42 Equivalent output circuit

6.8.8 Trigger Signal Control

The trigger signal input clears the pause during sequence execution. This is used to synchronize with external equipment.

Trigger signal input

Apply a signal across pins 11 and 12 of the J1 connector. The maximum allowable voltage is 5 V, and the minimum pulse width is 10 μ s.

NOTE

- The trigger signal output is generated at the rising edge of the pulse signal applied to the trigger input connector.
- The input terminal is connected to A COM of the J1 connector through approximately 100 k Ω of resistance. The maximum allowable voltage is 5 V, and the operation threshold level is TTL.

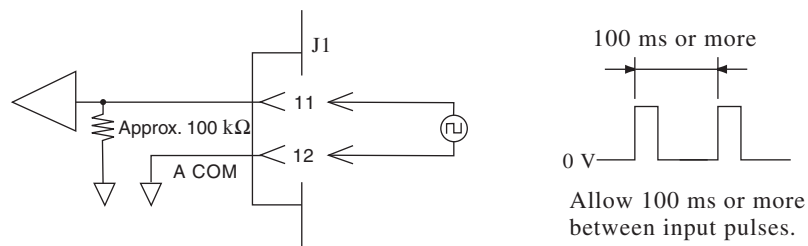

Fig. 6-43 Equivalent input circuit

6.8.9 External Control of the Current Range

The current range can be controlled using an external control signal. In addition, the status signal output can be used to monitor the selected range. The voltage range cannot be controlled.

Table 6-12 A list of control signals

Current range	Control input		Status output		PLZ 164W/164WA	PLZ 334W	PLZ 664WA	PLZ 1004W
	RANGE CONT 0 (J1-9)	RANGE CONT 1 (J1-8)	RANGE STATUS 0 (J1-15)	RANGE STATUS 1 (J1-14)				
H	HIGH	HIGH	OFF	OFF	33 A	66 A	132 A	200 A
M	HIGH	LOW	OFF	ON	3.3 A	6.6 A	13.2 A	20 A
L	LOW	HIGH	ON	OFF	0.33 A	0.66 A	1.32 A	2 A

HIGH: 5 V, LOW: 0 V, OFF: OPEN, ON: SHORT

NOTE

- Set the current range on the panel to the H range.
- The current range cannot be changed when the load is turned on. The control signal input received while the load is turned on is discarded.

Range signal input

Pins 8 and 9 of the J1 connector are used (pin 12 is common). 2-bit signal.

NOTE

- The control input terminal is connected to +5 V of the J1 connector through approximately 10 kΩ of resistance. The maximum allowable voltage is 5 V, and the operation threshold level is TTL.

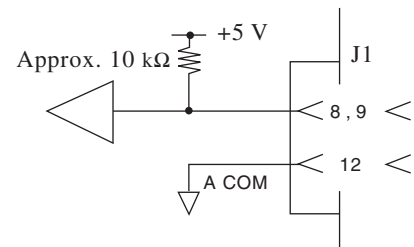
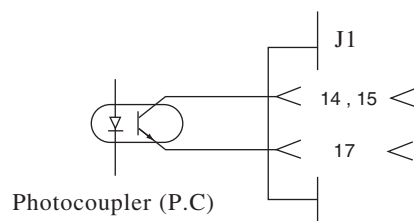

Fig. 6-44 Equivalent input circuit

Status signal output

Pins 14 and 15 of the J1 connector are used (pin 17 is common). 2-bit signal.



Maximum applied voltage 30 V
Maximum current 8 mA

Fig. 6-45 Equivalent output circuit

6.8.10 Alarm Signal Control

An alarm can be activated using an external control signal. In addition, the status signal output can be used to monitor the alarm condition.

Alarm signal input

Connect the external signal across pins 10 and 12 of the J1 connector. An alarm is activated on a low level signal.

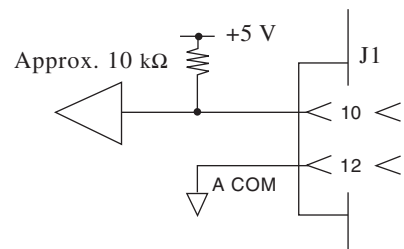

Fig. 6-46 Equivalent input circuit

NOTE

- The alarm input terminal is connected to +5 V of the J1 connector through approximately 10 kΩ of resistance. The maximum allowable voltage is 5 V, and the operation threshold level is TTL.

Status signal output

To externally monitor the alarm condition, the output signal across pins 16 and 17 of the J1 connector is used.

The output is turned on when OVP, OCP, OPP, OHP, REV or UVP trips or when an external alarm signal is applied.

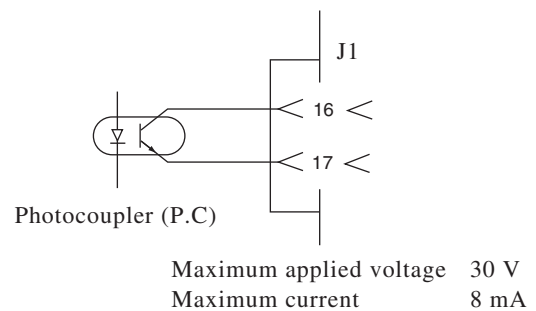

Fig. 6-47 Equivalent output circuit

6.9 Monitor Signal Output

Trigger signal output

The trigger signal is used as a synchronization signal when monitoring the waveform of the switching operation on an oscilloscope. It is also used to synchronize with the external equipment during sequence execution.

The trigger signal is output from the TRIG OUT connector on the PLZ-4W front panel.

-
- NOTE**
- The trigger signal output voltage is 4.5 V. The pulse width is 2 μ s or more, and the output impedance is approximately 500 Ω .
 - The TRIG OUT connector is connected to the chassis electric potential. It is isolated from A COM.
-

The trigger signal output is generated under the following conditions.

- During switching operation
- When a step that has trigger output specified is executed during sequence operation.

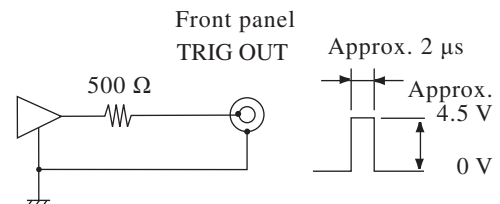

Fig. 6-48 Equivalent circuit

Current monitor output

The signal is output from the I MON OUT connector on the PLZ-4W front panel and across pins 2 and 3 (pin 3 is common) of the J1 connector.

-
- CAUTION**
- Pin 3 of the J1 connector is connected the negative load input terminal. To prevent damaging the PLZ-4W, be sure not to let the wire of pin 3 touch any other pins.
-

I MON OUT connector (BNC) on the PLZ-4W front panel

The common is connected to the chassis electric potential. It is isolated from A COM. For current ranges H and L, 1 V corresponds to the full scale current; for current range M, 0.1 V corresponds to the full scale current.

Across pins 2 and 3 of the J1 connector

The common is connected to A COM. For current ranges H and L, 10 V corresponds to the full scale current; for current range M, 1 V corresponds to the full scale current.

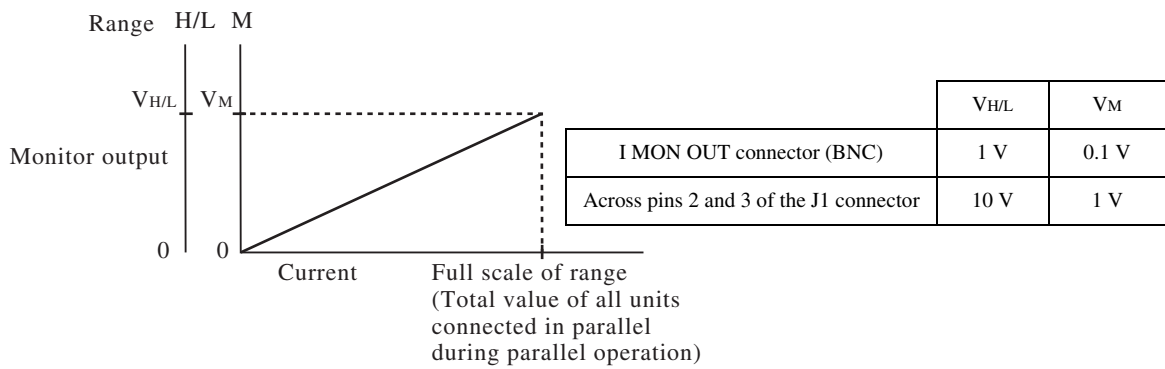

Fig. 6-49 Current monitor output

For parallel operation, the full scale of the current range is the total value of the units connected in parallel. The monitor output corresponds to this full scale current (the total of the full scale currents of each range).

6.10 Parallel operation

The PLZ-4W Series Electronic Load allows parallel operation in which multiple electronic loads can be connected in parallel to increase the current capacity or power capacity. In parallel operation, one unit becomes a master unit in charge of all controls in parallel operation. The master unit displays the total current and total wattage of the units connected in parallel.

The following two methods of parallel operation are available.

Parallel operation using the same model

In this method, multiple units configured to be slaves are connected in parallel with a unit configured to be the master. The slave units that can be connected in parallel are of the same model as the master unit. Up to four slave units can be connected (total of five units including the master unit).

Parallel operation using load boosters

In this method, load boosters (PLZ2004WB) are connected in parallel with a single master PLZ1004W. Up to four load boosters can be connected in parallel.

CAUTION • There is a danger of breakdown. During parallel operation, do not use the input terminals on the front panel.

NOTE

- Load boosters (PLZ2004WB) can only be connected to PLZ1004W.
- During parallel operation, the specifications may not be satisfied on the individual unit.
The accuracy of setting and measurement accuracy can be improved by carrying out calibration in parallel operation.
- The current ripple during parallel operation is approximately equal to the number of units connected in parallel times the current ripple of an individual unit.
- The resolution of setting during parallel operation varies depending on the number of units that are operating in parallel.

6.10.1 Parallel Operation Using the Same Model

To carry out parallel operation, signal wires for connecting between electronic loads and the load wire for connecting to the equipment under test are required.

Use the optional flat cable for the signal wire. For details, see “Control flat cables” in chapter 1, “General Information.”

Up to four slave units can be connected, but Fig. 6-50 shows an example in which two units are connected.

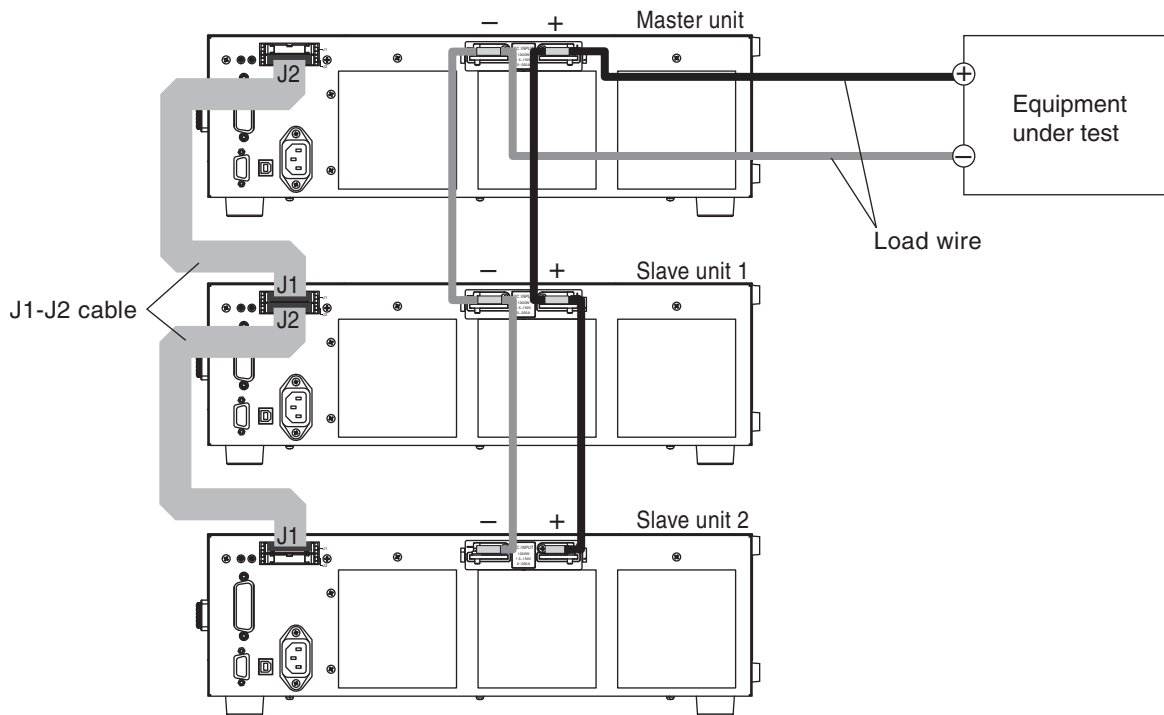

Fig. 6-50 Parallel connection of two slave units

Table 6-13 shows the relationship between the number of slave units and the capacity.

Table 6-13 The number of units connected in parallel and the capacity

Slave unit	Maximum current/Maximum power			
	PLZ164W /164WA	PLZ334W	PLZ664WA	PLZ1004W
1 unit	66 A / 330 W	132 A / 660 W	264 A / 1 320 W	400 A / 2 000 W
2 units	99 A / 495 W	198 A / 990 W	396 A / 1 980 W	600 A / 3 000 W
3 units	132 A / 660 W	264 A / 1 320 W	528 A / 2 640 W	800 A / 4 000 W
4 units	165 A / 825 W	330 A / 1 650 W	660 A / 3 300 W	1 000 A / 5 000 W

- CAUTION**
- When carrying out parallel operation, be sure to use the load input terminal on the rear panel. Do not connect other equipment to the load input terminal on the front panel.
 - Improper connection of the J1 and J2 connectors can damage the PLZ-4W.
 - Use the shortest load wire and flat cable possible for the connection. Use a load wire of sufficient thickness by taking into account the current being used. It is recommended to use the bus bar instead of wiring the cable.

- NOTE**
- Separate the load cable from the flat cable as much as possible to prevent unstable operation.

Parallel connection procedure

Connect the master unit and slave units using optional flat cables. Connect to the equipment under test using load wires. For a description of the wiring procedure and wire diameter, see section 2.8, "Load Wiring."

-
- ⚠ CAUTION** • Use a load wire with sufficient diameter for the current as well as non-flammable or flame-resistant cover.
-

1. Check that the power is turned off.
Check that the power of all units to be connected is turned off.
2. Connect the load input terminal of each unit.
Refer to the connection diagram of Fig. 6-50 and securely connect the load input terminals of the units of the same model in parallel.
3. Connect the external control connector of each unit.
Connect the J1 and J2 connectors of each unit in parallel using flat cables.
Carry out the work carefully as improper connection of the J1 and J2 connectors can damage the PLZ-4W.

Setup procedure of the master/slave units

1. Turn on the power of each unit.
Turn on the POWER switch of all units at once or turn on the POWER switch of slave units first to turn on the power to all units.
2. Select the menu setup.
Press the MENU (SHIFT+SET/VSET) key.
The the menu appears.
3. Select Configuration
Press the ▼ or ▲ CURSOR key several times until Configuration is highlighted. When highlighted, press the ENTER key.
4. Select Master/Slave
Press the ▼ or ▲ CURSOR key several times until Master/Slave is highlighted. When highlighted, press the ENTER key.
5. Set the master and slave units.
Check to see that the cursor (blinking) is at the Operation item. If the cursor is at some other item, press the ▲ CURSOR key several times to move the cursor to Operation.

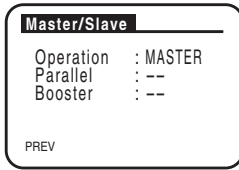

- **Master unit**

6. Set as a master unit.

First, turn the rotary knob to the right to select MASTER.

When slaves are connected, press the ▼ CURSOR key to move the cursor to the Parallel item.

Turn the rotary knob to set the total number of master and slave units.

- The Booster item appears only on the PLZ1004W.

- **Slave units**

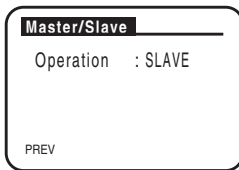

6. Set as a slave unit.

Turn the rotary knob to the left to select SLAVE.

When SLAVE is selected, the Parallel and Booster items disappear.

7. Exit from the menu.

Press the MENU (SHIFT+SET/VSET) key.

On the master unit, the original screen displayed before entering menu setup appears. On slave units, Slave Mode appears on the display.

8. Power cycle the PLZ-4W.

Turn on the POWER switch of all units at once or turn on the POWER switch of the master unit first to turn on the power to all units.

The menu settings are confirmed.

9. Set the operation mode and value, and turn on the load.

Operate the master unit to set the master mode and value. The range of the rated current and rated power on the master unit is expanded.

After entering the settings, turn off the load.

6.10.2 Parallel Operation Using Load Boosters

Load boosters are slave units dedicated to parallel operation. They operate as slave units simply by connecting them to the PLZ1004W. However, on the PLZ1004W that is to become the master unit, the master unit setting and the number of load boosters to be connected must be configured.

For the connection procedure, see section 2.6, “Parallel Connection” in the operation manual of the load booster.

For the setup procedure of the master unit, see section 2.7, “Setting the Master Unit” in the operation manual of the load booster.

NOTE

- Load boosters (PLZ2004WB) can only be connected to PLZ1004W.
-

6.10.3 Alarms during Parallel Operation

When an alarm occurs during parallel operation, an error message is displayed, and the load of all units is turned off.

If an alarm occurs on a slave unit, “ALARM EXTERNAL” is displayed on the master unit.

Clear the alarm on the master unit.

6.10.4 Response Speed during Parallel Operation

You can change the response speed in CC mode (CC+CV mode) and CR mode (CR+CV mode).

In some cases, the wire inductance increases and a large voltage drop occurs due to changes in the current or the phase lag of the current may cause instability in the PLZ-4W control inducing oscillation.

In such case, you can decrease the response speed to assure stable operation.

During parallel operation, the response speed of the master unit is used.

When the electronic load unit is assigned as a master unit in parallel operation with response speed is set at 1/1, the setting of response speed will change to be set at 1/2 in order to secure the stable operation. It is possible to be reset to 1/1 by the menu setting, please refer to the “Technical Note for the PLZ-4W, When operating under parallel operation or high-speed load simulations” as provided as separate sheet and wire the load cable followed by the instruction.

- For a description of response speed, see section 5.15, “Response Speed.”

6.10.5 Slew Rate during Parallel Operation

During parallel operation, the slew rate of the master unit is used.

6.10.6 Canceling the Parallel Operation

To switch from parallel operation back to standalone operation, turn off the power of each unit and remove the flat cables.

To set the slave units back to standalone operation, set the Operation item back to MASTER from the menu.

On the master unit to which load boosters were connected, set the number of load boosters in the menu to -, and power cycle the unit.

7



Chapter 7 Remote Control

This chapter gives an overview of remote control. For detail of the command, see the Communication Interface Manual. The communication Interface Manual is provided on the accompanying CD-ROM.

7.1 Overview

In addition to using the front panel controls, the PLZ-4W can be controlled remotely using the following interfaces.

- RS232C interface
- GPIB interface
- USB interface

The remote interface accepts two formats of commands: IEEE 488.2 common commands and SCPI commands.

The interface is selected from the front panel.

The PLZ-4W conforms to the following standards.

- IEEE Std 488.2-1992 IEEE Standard Codes, Formats, Protocols, and Common Commands For Use With IEEE Std 488.1-1987
- IEEE Std 488.1-1987 IEEE Standard Digital Interface for Programmable Instrumentation
- TIA/EIA-232F
- Standard Commands for Programmable Instruments (SCPI) version 1999.0
- Universal Serial Bus Specification Rev 2.0
- Universal Serial Bus Test and Measurement Class Specification (USBTMC) Rev 1.0
- Universal Serial Bus Test and Measurement Class, Subclass USB488 Specification (USBTMC-USB488) Rev 1.0

7.2 Interface Setup

The factory default remote control interface setting is GPIB.

7.2.1 GPIB Control

■ GPIB connection

Use a standard IEEE488 cable to connect the PLZ-4W to the PC.

■ GPIB configuration

1. Check that the load is turned off.
Check that the LOAD LED is turned off. If it is on, press the LOAD key to turn it off.
2. Select the menu setup.
Press the MENU (SHIFT+SET/VSET) key. The menu screen is displayed.
3. Select Configuration
Press the ▼ or ▲ CURSOR key several times until Configuration is highlighted on the menu. When highlighted, press the ENTER key.
4. Select interface.
Press the ▼ or ▲ CURSOR key several times until Interface is highlighted on the menu. When highlighted, press the ENTER key.
5. Select GPIB.
Check that the cursor is blinking by Control on the menu, and turn the rotary knob to select GPIB.
6. Select Address.
Press the ▼ CURSOR key and check that the cursor is blinking by Address on the menu. Then, turn the rotary knob to set the device address.
7. Exit from the menu.
Press the MENU (SHIFT+SET/VSET) key. The original screen displayed before entering menu setup appears.
8. Power cycle the PLZ-4W.
The settings are confirmed.

7.2.2 RS232C Control

■ RS232C connection

Use a standard cross cable (null modem cable) to connect the PLZ-4W to the PC. The RS232C port on the PLZ-4W is a standard DB9P male connector.

Table7-1 RS232C pins

Pin No.	Function
1	Not used
2	Receive (RX)
3	Transmit (TX)
4	Not used
5	Ground (FG)
6 to 9	Not used

■ RS232C configuration

Parity is fixed to NONE.

- 1. Check that the load is turned off.**
Check that the LOAD LED is turned off. If it is on, press the LOAD key to turn it off.
- 2. Select the menu setup.**
Press the MENU (SHIFT+SET/VSET) key. The menu screen is displayed.
- 3. Select Configuration**
Press the ▼ or ▲ CURSOR key several times until Configuration is highlighted on the menu. When highlighted, press the ENTER key.
- 4. Select interface.**
Press the ▼ or ▲ CURSOR key several times until Interface is highlighted on the menu. When highlighted, press the ENTER key.
- 5. Select RS232C.**
Check that the cursor is blinking by Control on the menu, and turn the rotary knob to select RS232C.
- 6. Select Baudrate.**
Press the ▼ CURSOR key and check that the cursor is blinking by Baudrate on the menu. Then, turn the rotary knob to set the baud rate.
- 7. Select Stop bit.**
Press the ▼ CURSOR key and check that the cursor is blinking by Data, Stop on the menu. Then, turn the rotary knob to set the stop bit.
The data length is fixed to 8 bits.
- 8. Select Ack.**
Press the ▼ CURSOR key and check that the cursor is blinking by Ack on the menu. Then, turn the rotary knob to set the acknowledge.

9. Exit from the menu.

Press the MENU (SHIFT+SET/VSET) key. The original screen displayed before entering menu setup appears.

10. Power cycle the PLZ-4W.

The settings are confirmed.

■ Transmission/Reception via the RS232C

Control the transmission/reception via the RS232C interface using flow control or by using acknowledge messages. Transmission/reception may not work correctly through unilateral transmission.

RS232C flow control

By using Xon/Xoff, the transmission/reception on the PLZ-4W can be controlled. DC (device control) codes are used to carry out control.

Table 7-2 DC codes

Code	Function	ASCII code
DC1	Transmission request	11H
DC3	Transmission stop request	13H

Transmission control from the RS-232C terminal to the PLZ-4W

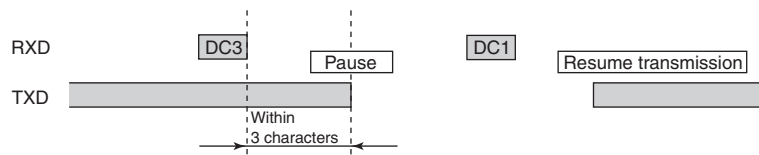

After receiving DC3, the PLZ-4W pauses transmission within 3 characters.

Transmission control from the PLZ-4W to the RS-232C terminal

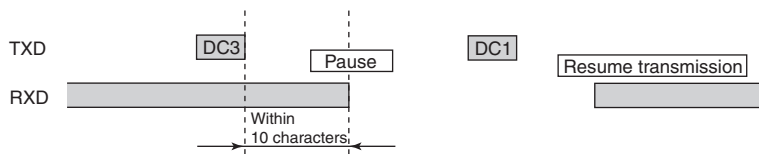

The RS-232C terminal must pause transmission within 10 characters after receiving DC3.

Fig.7-1 RS232C terminal and transmission control of the PLZ-4W

Acknowledge message

An acknowledge message is information sent from the PLZ-4W to the controller. It notifies that the processing of the program message has been completed.

The acknowledge message is an ASCII code string consisting of only the header. The following two types are available.

- OK: Normal completion
- ERROR: Syntax error or other errors

To use acknowledge messages, select “1. Configuration” | “3. Interface” | “RS232C” from the menu and turn Ack ON.

On the controller, the RS232C configuration must be set to full-duplex operation.

7.2.3 USB Control

To use the USB, download the KI-VISA software program from Kikusui website (<http://www.kikusui.co.jp>), and install the software in PC. The software program can only be used on a Windows environment.

■ USB connection

Use a standard USB cable to connect the PLZ-4W to the PC.

■ USB configuration

1. Check that the load is turned off.
Check that the LOAD LED is turned off. If it is on, press the LOAD key to turn it off.
2. Select the menu setup.
Press the MENU (SHIFT+SET/VSET) key. The menu screen is displayed.
3. Select Configuration
Press the ▼ or ▲ CURSOR key several times until Configuration is highlighted on the menu. When highlighted, press the ENTER key.
4. Select interface.
Press the ▼ or ▲ CURSOR key several times until Interface is highlighted on the menu. When highlighted, press the ENTER key.
5. Select USB.
Check that the cursor is blinking by Control on the menu, and turn the rotary knob to select USB.
6. Exit from the menu.
Press the MENU (SHIFT+SET/VSET) key. The original screen displayed before entering menu setup appears.
7. Power cycle the PLZ-4W.
The settings are confirmed.

7.3 Contents of the accompanying CD-ROM

Insert the accompanying CD-ROM in the drive. After a short time, the menu program window opens. If the menu program window does not open, browse the CD-ROM with Windows Explorer, and double-click index.html. The menu program will start.

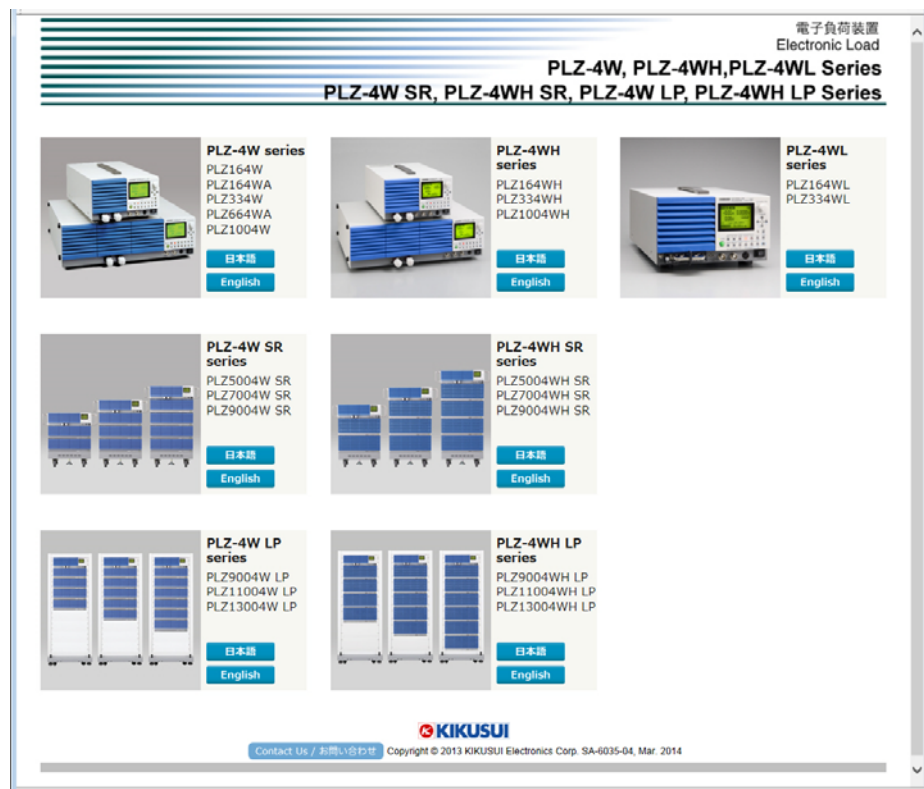

- Application software
 - PLZ Application & Samples (Requires to install the VISA library)
- Driver
 - KI-VISA
- Operation Manual
 - User's Manual (PDF)
 - The communication Interface Manual (HTML)
 - Quick Reference (PDF)
 - Setup Guide (PDF)

7.3.1 Installing the VISA Library

VISA (Virtual Instrument Software Architecture) is a specification for a standard software for connecting instruments that was defined by the VXIplug&play Systems Alliance.

One of the VISA libraries (driver software implemented in compliance with the VISA specifications) below is necessary.

Do not install the plural number of VISA library to the PC. It may cause possible malfunction.

Older version of VISA libraries does not support USB.

- NI-VISA by National Instruments (Ver. 3.0 or later, Ver. 3.2 or later for Windows 2000 and Windows XP)
- Agilent VISA by Agilent Technologies (Agilent IO Libraries M01.00 or later)
- KI-VISA Ver. 3.0.0 or later

Installing KI-VISA

KI-VISA is Kikusui's original VISA library that supports VXIplug&play VISA Specifications. The newest version can be downloaded from Download service of Kikusui website (<http://www.kikusui.co.jp/en/download/>).

KI-VISA is not required if NI-VISA or Agilent VISA is already installed.

1. Load the accompanying CD-ROM into the CD-ROM drive.
2. Move to the VISA folder using the menu program of the CD-ROM or Explorer.
3. Double-click Kivisa_x_x_x.exe.
The value for x varies depending on the revision of the VISA library stored on the CD-ROM.
4. Proceed with the installation according to the instructions on the screen.

When the installation is complete, the KI-VISA Instrument Explorer starts.

5. Click KI-VISA IO Config on the screen.

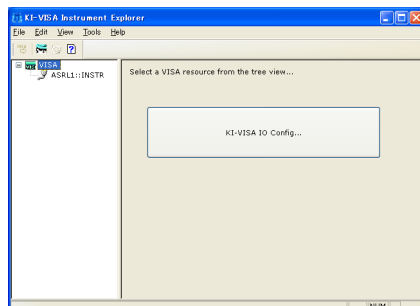

6. Click USB(USBTMC) tab, and click Run Driver Wizard(WINUSB.SYS).

7. Uncheck Protect my computer and data from unauthorized program activity, and click OK.

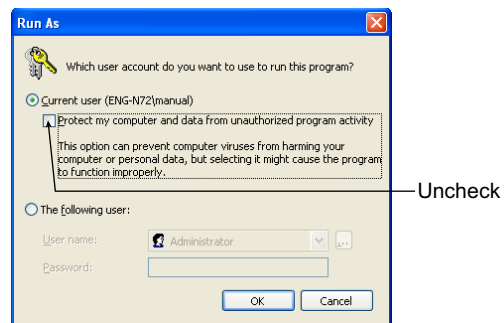

8. Proceed with the installation according to the instructions on the screen.

7.3.2 Installing the Software Application

Kikusui PLZ Application & Samples includes the following software.

Table 7-3 Software

VPanel	Simple virtual panel
Monitor And Log	Measures Curr/Volt/Pow, generates logs
Step Editor	A program/Step editor
Memory Copy	A memory backup tool for Setup Memories

1. Load the accompanying CD-ROM into the CD-ROM drive.
2. Move to the Application & Samples folder using the menu program of the CD-ROM or Explorer.
3. Double-click PlzAppsSetup_x_x_x.exe.
The value for x varies depending on the revision of the VISA library stored on the CD-ROM.
4. Proceed with the installation according to the instructions on the screen.

For detail, see Readme.html in Application folder of CD-ROM.

7.4 Command Details

For command details, see the Communication Interface Manual on the accompanying CD-ROM.

The communication interface manual is in HTML format that can be viewed with a WWW (World Wide Web) browser. The HTML manual can be viewed using the following browsers.

Operating environment: Windows 98 or later

Browser: Microsoft Internet Explorer 5.5 or later

The list of messages of interface manual is provided in a PDF file. Adobe Reader 6.0 or later is required to view the file.

8

Chapter 8 Maintenance and Calibration

This chapter describes how to maintain, inspect, and calibrate the PLZ-4W.

8.1 Maintenance

Periodic maintenance and inspection are essential to maintain the initial performance of the PLZ-4W over an extended period.

-
- ⚠ WARNING** • Possible electric shock. May lead to death or injury. Be sure to turn off the POWER switch and remove the power cord plug or turn off the switch-board.
-

8.1.1 Cleaning the Panels

If the panel needs cleaning, gently wipe using a soft cloth with water-diluted neutral detergent.

-
- ⚠ CAUTION** • Do not use volatile solvents such as thinner or benzine. They may discolor the surface, erase printed characters, or cloud the LCD.
-

8.1.2 Cleaning the Dust Filter

A dust filter is installed on the inside of the louver on the front panel. Periodically clean the filter to prevent clogging.

-
- ⚠ CAUTION** • Clogged filters hinder the cooling of the inside of the instrument and can cause a malfunction and shortening of the service life.
-

Cleaning procedure

1. Remove the louver from the panel by placing a finger on the 2nd level of the louver and pulling down the 1st level while pulling it toward you. If the louver does not come off easily, pressing down the top level of the louver will ease the work.

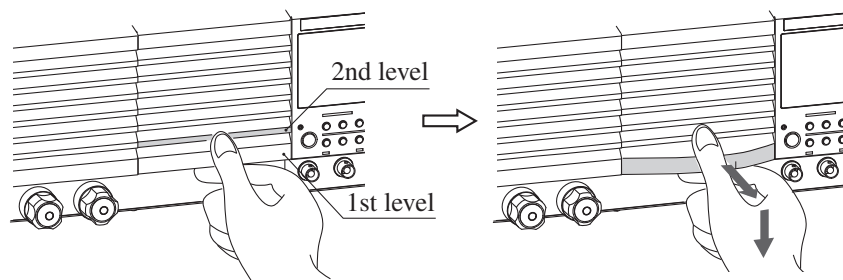

Fig.8-1 Removing the louver

2. Remove the dust filter from the inside of the louver and clean it.

Remove the dust on the dust filter such as by using a vacuum cleaner. If the filter is extremely dirty, clean it using a water-diluted neutral detergent and dry it completely.

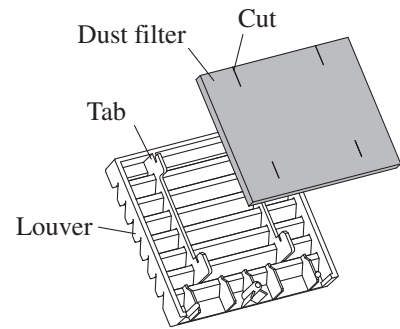

Fig. 8-2 Dust filter

⚠ CAUTION

- When the PLZ-4W is in operation, air is sucked through the dust filter to cool the PLZ-4W. If moisture is included in the dust filter, the temperature or humidity inside the PLZ-4W increases and may cause a malfunction.

3. Attach the dust filter to the louver.
Attach it so that the tab on the louver fits into the cut on the dust filter.
4. Attach the louver to the panel by pulling up on the louver while holding the 2nd level of the louver with your hand until the pin is fixed in place.

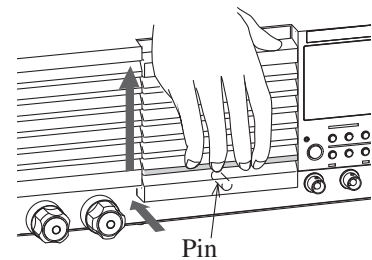

Fig. 8-3 Attaching the louver

8.1.3 Inspecting the Power Cord

Check the power cord for breaks in its protective cover, cracked plugs or rattling, and loosened screws.

8.1.4 Internal Inspection

The electrolytic capacitors, fan motor, and battery for memory backup inside the PLZ-4W are consumable parts.

It is recommended that the PLZ-4W be overhauled every 10000 operating hours along with internal inspection and cleaning. For overhauling your PLZ-4W, contact your Kikusui agent or distributor.

Backup battery

The PLZ-4W employs a lithium battery for memory backup.

The battery life depends on the operating conditions. Three years after purchase is a good estimation. If the panel settings are different at the time the power is turned off and at the time the power is turned on again, the battery is already dead.

To replace the battery, contact your Kikusui agent or distributor.

8.2 Confirming status of the fuse

To increase security of the product, the fuse are installed on each element of the load device. Those fuses protects from the effect to the connected device at minimum level causing by the failure or incorrect use of the product. If the setting current is not flowing properly, the fuse may have blown off. Please check the following procedure.

1. Apply the current flow while the loads are connected.
2. Remove the whole louvers on the front panel, and check if the LED lights in red.

If the LED lights, the fuse may have blown off. In this case, contact your Kikusui distributor/agent for request of service.

Check for the input voltage and the input current within the rated value. If the measured value is out of rated range, the LED may lights on even the fuse does not blow off.

8.3 Calibration

The PLZ-4W is shipped from the factory after carrying out a strict calibration. However, to maintain the performance, periodic calibration is recommended.

8.3.1 Calibration Overview

The calibrated items are current and voltage.

The current is calibrated with respect to the current ranges (3 ranges: L, M, and H).

The voltage is calibrated with respect to the voltage ranges (2 ranges: 15 V and 150 V).

For each range, the offset and gain are calibrated.

Offset: Value corresponding to 10 % of the range full scale

Gain: Value corresponding to 100 % of the range full scale

The relationship between the setting and output during operation is linear. Therefore, a line is defined by calibrating the offset and gain at 2 points. During operation, the relationship between the setting and output is achieved along the calibrated line.

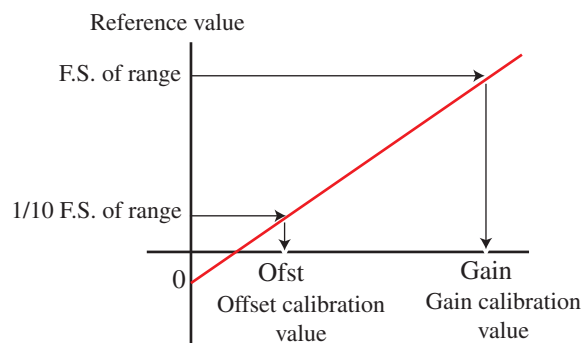

Fig. 8-4 Offset and gain calibration

■ Calibration items

The following six items are calibrated for three current ranges and two voltage ranges.

1. Offset of the internal reference voltage for output setting
2. Gain of the internal reference voltage for output setting
3. Offset of the measured value
4. Gain of the measured value
5. Offset of the internal reference voltage for protection function setting
6. Gain of the internal reference voltage for protection function setting

The offsets of the internal reference voltage for output setting and the measured value (number 1 and 3) are calibrated simultaneously. The same also holds true for the gain (numbers 2 and 4).

Therefore, the number of calibration points is 20 (4 points \times 5 ranges).

8.3.2 Preparation

Leave the PLZ-4W turned on for at least 30 minutes (warm-up) before carrying out a performance check. This is to reduce measurement errors due to initial drift. Keep the ambient temperature at 23 ± 5 °C.

Table8-1 Test equipment used

Name	Required accuracy	Required rating
DC voltmeter	Within 0.02 %	Measurement voltage range: 0 V to 155 V
Shunt resistor	0.1 %	For 0.5 A (*1) For 1 A (*1, *2) For 2 A (*3, *4) For 5 A (*1) For 10 A (*2) For 20 A (*3, *4) For 50 A (*1) For 100 A (*2) For 200 A (*3, *4)
Regulated DC power supply (constant voltage power supply)	–	Voltage: 5 V Current: 33 A (*1) 66 A (*2) 132 A (*3) 200 A (*4)
Regulated DC power supply (constant current power supply)	–	Voltage: 155 V Current: 0.3 A

*1:PLZ164W/PLZ164WA, *2:PLZ334W, *3:PLZ664W, *4:PLZ1004W

Connect the cables as shown in Fig. 8-5. Select the shunt resistor according to the calibration item.

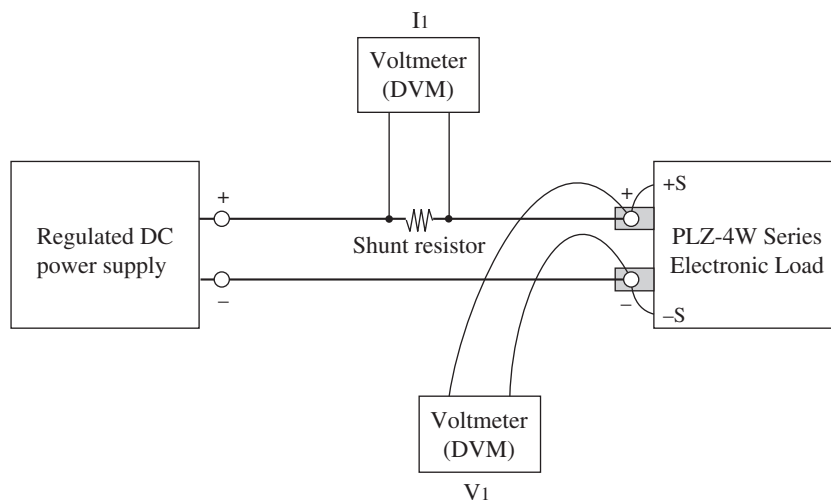

Fig. 8-5 Connection diagram

8.3.3 Calibration Procedure

Entering the calibration screen and selecting Calibration

1. Press the MENU (SHIFT+SET/VSET) key.
The menu screen is displayed.
2. Use the ▼ CURSOR key to select 3. Calibration.
3. Calibration is highlighted.
3. Press the ENTER key.
The Calibration screen appears.

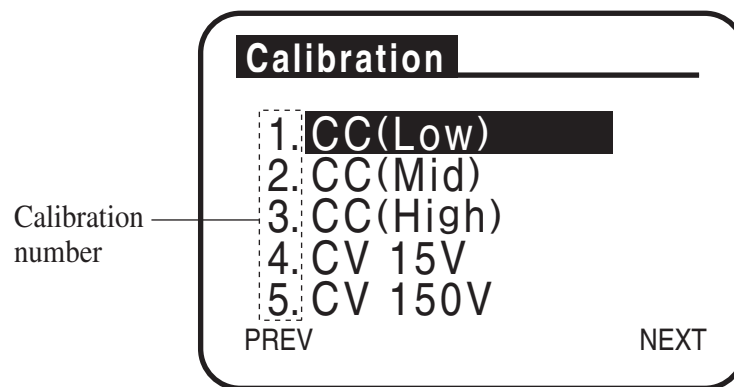

Fig. 8-6 Calibration screen

■ Alarm

If an alarm occurs while the calibration is in progress, the load turns off along with a beeping alarm. Press the ENTER key after clearing the problem which was caused to activate an alarm, then the Calibration screen appears on the display and a beeping alarm stops. In this case, go back to the step from the beginning of the alarm occurred calibration number.

CC mode calibration (calibration number 1, 2, and 3)

Carry out calibration on the low range items first according to steps A to D. Then, carry out calibrations for Mid range and High range.

Table 8-2 Overview of the procedure

Procedure	Current range	Percentage with respect to the full scale (%)	Calibration item					
			Internal reference voltage for output setting		Measured value		Internal reference voltage for protection function setting	
			Offset	Gain	Offset	Gain	Offset	Gain
A	Low	10	●	–	●	–	–	–
B			–	–	–	–	●	–
C		100	–	●	–	●	–	–
D			–	–	–	–	–	●
A	Mid	10	●	–	●	–	–	–
B			–	–	–	–	●	–
C		100	–	●	–	●	–	–
D			–	–	–	–	–	●
A	High	10	●	–	●	–	–	–
B			–	–	–	–	●	–
C		100	–	●	–	●	–	–
D			–	–	–	–	–	●

■ Low range calibration

Step A: Calibration of the offsets of internal reference voltage for output setting and measured value

1. Connect a shunt resistor that matches the value corresponding to 10 % of the low range full scale.
2. Press the ▼ or ▲ CURSOR key to select the calibration number “1. CC (Low)”.
3. Connect a CV power supply to the load input terminal and apply 5 V. Set the current of the power supply approximately in the range of 2 % to 5 % of the rated current of the load device.
4. Press the ENTER key.

The load automatically turns on, and the offset calibration (CC (Low) Offset Adjustment) screen appears.

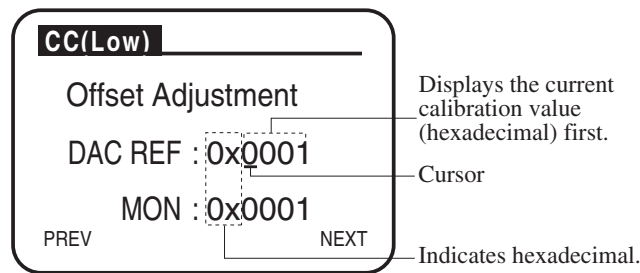

Fig. 8-7 CC (Low) Offset Adjustment screen

5. Press the ◀ or ▶ CURSOR key to select DAC REF, and turn the rotary knob. Set the current flowing through the shunt resistor within ± 0.1 % of the value corresponding to 10 % of the range full scale.

MON is automatically set as the offset of the measured value.

See Fig. 8-3 for the current settings of each model.

The calibration for this item is complete. Continue to step B.

Step B: Calibration of the offset of the internal reference voltage for protection function setting

6. Press the ENTER key.

The offset calibration (CC (Low) Limit Offs Adjust) screen appears.

7. Press the ◀ or ▶ CURSOR key to select DAC LIM, and turn the rotary knob. Set the current flowing through the shunt resistor within ± 0.1 % of the value corresponding to 10 % of the range full scale.

See Table 8-3 for the current settings of each model.

8. Press the ENTER key.

The load is automatically turned off.

The calibration for this item is complete. Continue to step C.

Step C: Calibration of the gains of internal reference voltage for output setting and measured value

9. Connect a shunt resistor that matches the value corresponding to 100 % of the low range full scale.

10. Press the ENTER key.

The load automatically turns on, and the gain calibration (CC (Low) Gain Adjustment) screen appears.

11. Press the ◀ or ▶ CURSOR key to select DAC REF, and turn the rotary knob. Set the current flowing through the shunt resistor within 0.1 % of the value corresponding to 100 % of the range full scale.

MON is automatically set as the gain of the measured value.

See Table 8-3 for the current settings of each model.

The calibration for this item is complete. Continue to step D.

Step D: Calibration of the gain of the internal reference voltage for protection function setting

12. Press the ENTER key.

The gain calibration (CC (Low) Limit Gain Adjust) screen appears.

13. Press the ◀ or ▶ CURSOR key to select DAC LIM, and turn the rotary knob. Set the current flowing through the shunt resistor within $\pm 0.1\%$ of the value corresponding to 100 % of the range full scale.

See Table 8-3 for the current settings of each model.

14. Press the ENTER key.

The load is automatically turned off.

The calibration of the low range current is complete.

■ Mid range calibration

15. Return to number 1 of step A and calibrate the mid range (calibration number “2. CC (Mid)”) by carrying out a similar procedure.

■ High range calibration

16. Return to number 1 of step A again and calibrate the High range (calibration number “3. CC (High)”) by carrying out a similar procedure.

Step 16 completes the CC mode calibration.

Table 8-3 CC mode settings

Calibration number and item			Output setting of the power supply	Current to be matched			
				PLZ164W PLZ164WA	PLZ334W	PLZ664WA	PLZ1004W
1	CC(Low)	Offset	Voltage: 5 V Current: Rated current of the load device	33 mA ± 0.033 mA	66 mA ± 0.066 mA	132 mA ± 0.13 mA	200 mA ± 0.20 mA
		Gain		330 mA ± 0.33 mA	660 mA ± 0.66 mA	1.32 A ± 0.013 A	2.00 A ± 0.020 A
2	CC(Mid)	Offset		330 mA ± 0.33 mA	660 mA ± 0.66 mA	1.32 A ± 0.013 A	2.00 A ± 0.020 A
		Gain		3.3 A ± 0.0033 A	6.6 A ± 0.0066 A	13.2 A ± 0.013 A	20.0 A ± 0.020 A
3	CC(High)	Offset		3.3 A ± 0.0033 A	6.6 A ± 0.0066 A	13.2 A ± 0.013 A	20.0 A ± 0.020 A
		Gain		33.0 A ± 0.033 A	66.0 A ± 0.066 A	132.0 A ± 0.132 A	200.0 A ± 0.200 A

CV mode calibration (calibration number 4 and 5)

Carry out calibration on the 15-V range items first according to steps E to H. Then, carry out calibration on the 150-V range items.

The shunt resistor is not used, but you can leave it connected.

Table 8-4 Overview of the procedure

Procedure	Voltage range	Percentage with respect to the full scale (%)	Calibration item					
			Internal reference voltage for output setting		Measured value		Internal reference voltage for protection function setting	
			Offset	Gain	Offset	Gain	Offset	Gain
E	15V	10	●	–	●	–	–	–
F			–	–	–	–	●	–
G		100	–	●	–	●	–	–
H			–	–	–	–	–	●
E	150V	10	●	–	●	–	–	–
F			–	–	–	–	●	–
G		100	–	●	–	●	–	–
H			–	–	–	–	–	●

■ Low range calibration

Step E: Calibration of the offsets of internal reference voltage for output setting and measured value

1. Press the ▼ or ▲ CURSOR key to select the calibration number “4. CV 15 V”.
2. Connect a CC power supply to the load input terminal and supply 0.3 A. Set the voltage of the power supply to 15.5 V or greater.
3. Press the ENTER key.

The load automatically turns on, and the offset calibration (CV 15 V Offset Adjustment) screen appears.

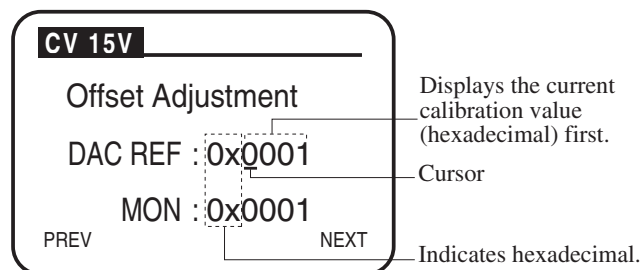

Fig. 8-8 CV 15 V Offset Adjustment screen

4. Press the ◀ or ▶ CURSOR key to select DAC REF, and turn the rotary knob. Monitor the input voltage on an external voltmeter, and set the input voltage within ± 0.05 % of the value corresponding to 10 % of the range full scale.

MON is automatically set as the offset of the measured value.

See Table 8-5 and set the input voltage.

The calibration for this item is complete. Continue to step F.

Step F: Calibration of the offset of the internal reference voltage for protection function setting

5. Press the ENTER key.

The offset calibration (CV 15 V Limit Offs Adjust) screen appears.

6. Press the ◀ or ▶ CURSOR key to select DAC LIM, and turn the rotary knob. Monitor the input voltage on an external voltmeter, and set the input voltage within ± 0.05 % of the value corresponding to 10 % of the range full scale.

See Table 8-5 and set the input voltage.

7. Press the ENTER key.

The load is automatically turned off.

The calibration for this item is complete. Continue to step G.

Step G: Calibration of the gains of internal reference voltage for output setting and measured value

8. Press the ENTER key.

The load automatically turns on, and the gain calibration (CV 15 V Gain Adjustment) screen appears.

9. Press the ◀ or ▶ CURSOR key to select DAC REF, and turn the rotary knob. Monitor the input voltage on an external voltmeter, and set the input voltage within 0.05 % of the value corresponding to 100 % of the range full scale.

MON is automatically set as the gain of the measured value.

See Table 8-5 and set the input voltage.

The calibration for this item is complete. Continue to step H.

Step H: Calibration of the gain of the internal reference voltage for protection function setting

10. Press the ENTER key.

The gain calibration (CV 15V Limit Gain Adjust) screen appears.

11. Press the ◀ or ▶ CURSOR key to select DAC REF, and turn the rotary knob. Monitor the input voltage on an external voltmeter, and set the input voltage within 0.05 % of the value corresponding to 100 % of the range full scale.

See Table 8-5 and set the input voltage.

12. Press the ENTER key.

The load is automatically turned off.

The calibration of the low range voltage is complete.

■ High range calibration

13. Return to number 1 of step E and calibrate the High range (calibration number “5. CV 150V”) by carrying out a similar procedure. Set the voltage of the power supply to 155 V or greater.

Step 12 completes the CV mode calibration.

Table 8-5 CV mode settings

Calibration number and item			Output setting of the power supply	Voltage to be matched
4	CV 15V	Offset	OffsetVoltage: 15.5 V Current: 0.3 A	1.50 V ±0.00075 V
		Gain		15.0 V ±0.0075 V
5	CV 150V	Offset	Voltage: 155 V Current: 0.3 A	15.0 V ±0.0075 V
		Gain		150 V ±0.075 V

Exiting from the calibration screen.

1. Press the PREV (SHIFT+ ◀) key.
The original screen displayed before entering calibration appears.
2. Press the MENU (SHIFT+SET/VSET) key.
The original screen displayed before entering menu setup appears.

NOTE

- If you press the NEXT (SHIFT+ ▶) key or ENTER key on the gain calibration screen, the calibration data is written to the internal memory. If you only wish to check the calibration data, be sure to exit from the gain calibration screen by pressing the PREV (SHIFT+ ◀) key or MENU (SHIFT+SET/VSET) key.

8.4 Malfunctions and Causes

This section describes remedies for malfunctions encountered during the use of the PLZ-4W. Representative symptoms and their possible check items are indicated. Look for the item that corresponds to your case. In some cases, the problem can be solved quite easily.

If you find an item that corresponds to your case, follow the remedy for the item. If the remedy does not solve the problem or if your case does not match any of the items, contact your Kikusui agent.

Symptom 1: Nothing appears on the display when the POWER switch is turned on.

Check Item		Possible Cause	Remedy
Location and Status of the Object	Check Result		
Is rated voltage applied for the input power supply (AC)?	No	Broken power cord Bad connection at the AC INPUT connector on the rear panel	Check that the power cord is not broken and that the connection at the AC INPUT connector is secure.
	Yes	Malfunction	Remove the power cord plug from the outlet. Immediately stop the use of the instrument and request repairs.

Symptom 2: The display is dark.

Check Item		Possible Cause	Remedy
Location and Status of the Object	Check Result		
Is rated voltage applied for the input power supply (AC)?	No	Low supply voltage	Use the PLZ-4W in the input supply voltage range.
	Yes	Bad contrast adjustment	Adjust the contrast. See section 2.6, "Turning on The Power."

Symptom 3: Keys do not work.

Check Item		Possible Cause	Remedy
Location and Status of the Object	Check Result		
Is key lock mode enabled?	Yes	Key lock is enabled.	Release the key lock. See section 5.11, "Lock Function."
	No	Malfunction	Immediately stop the use of the instrument and request repairs.
Set to slave.	Yes	→	Set to master using menu setup. See section 5.13, "Menu Setup."

Symptom 4: Input current is unstable or oscillates.

Check Item		Possible Cause	Remedy
Location and Status of the Object	Check Result		
Is rated voltage applied for the input power supply (AC)?	No	Low supply voltage	Use the PLZ-4W in the input supply voltage range.
	Yes	Malfunction	Immediately stop the use of the instrument and request repairs.
Is the ALARM illuminated?	Yes	An internal or external error occurred on the PLZ-4W.	Check the alarm type and carry out the appropriate remedy. See section 5.3, "Types of Protection Functions."
Is there a large loop in the load wire?	Yes	→	Twist the wires. See section 2.8, "Load Wiring."
The load wire is long.	Long	→	Change the response (transient response) using menu setup.

Symptom 5: ALARM is activated.

Check Item		Possible Cause	Remedy
Location and Status of the Object	Check Result		
Is the fan stopped?	Yes	Overheat protection tripped.	Immediately stop the use of the instrument and request repairs.
Is the air intake or outlet obstructed?	Yes	Overheat protection tripped. Clogged dust filter	Allow at least 20 cm between the air outlet and the wall. In addition, do not place objects within 20 cm. Clean the dust filter.
Is OCP tripped?	Yes	The OCP setting is small.	Set an appropriate OCP value on the setup screen. See section 5.4, "Setting the Protection Function."
Is OPP tripped?	Yes	The OPP setting is small.	Set an appropriate OPP value on the setup screen. See section 5.4, "Setting the Protection Function."

Symptom 6: The load cannot be turned on.

Check Item		Possible Cause	Remedy
Location and Status of the Object	Check Result		
A sequence is in operation	Yes	→	Wait for the sequence operation to finish. Abort the sequence using the STOP key.
	No	The load on/off logic (Load ON IN) is set to low.	Set Load ON IN to high using menu setup. See section 5.13, "Menu Setup."

Symptom 7: The transmission/reception does not work when you communicate using the program previously used.

Check Item		Remedy
Location and Status of the Object	Check Result	
Is the acknowledge message used?	Yes	<p>There is a case that your program targeted at PLZ-4W ROM version 1.17 or earlier may not work correctly with ROM version 1.18 or later. In that case, change the Ack setting to “ON + ^Q”.</p> <p>Precedure of changing</p> <ol style="list-style-type: none"> 1. Select “1. Configuration” “3. Interface” “RS232C” from the menu. 2. Press the ▼CURSOR key several times to select Ack. 3. Press the ENTER key. <p>“ON + ^Q” is selected. It is impossible to select “ON + ^Q” with the rotary knob. To select ON/OFF, press the ENTER key again.</p>

Symptom 8: The setting current is not flowing

Check Item		Possible Cause	Remedy
Location and Status of the Object	Check Result		
Is the LED located inside of the unit illuminated? See the 8.2, “Confirming status of the fuse.”	Yes	Fuse blow	Immediately stop the use of the instruments and request for repair service.

Symptom 9: When either PLZ164WA or PLZ664WA is used, the reverse-connection detection (REV) activates by turning on/off of the DUT.

Check Item		Possible Cause	Remedy
Location and Status of the Object	Check Result		
Do you connect the DC power supply and the DUT (an open-close device such as a switch) in series ?	Yes	The reverse voltage is applied to the load input terminal.	Set to avoid the occurrence of alarm. See “When the DC power supply and the DUT are connected in series, and turning on/off of the DUT. (PLZ164WA/PLZ664WA only)” in section 5.2, “Turning On or Off the Load.”

9

Chapter 9 Specifications

This chapter lists the electrical and mechanical specifications of the PLZ-4W.

9.1 Electrical Specifications

Unless specified otherwise, the specifications are for the following settings and conditions.

- The warm-up time is 30 minutes (with current flowing).
- After warm-up is complete, the PLZ-4W must be calibrated correctly according to the procedures given in the operation manual in a 23 °C±5 °C environment.
- ** % of set denotes ** % of the input voltage, input current, or input power setting.
- ** % of f.s denotes ** % of the rated input voltage, rated input current, or rated input power.
- ** % of rdg represents denotes ** % of the input voltage, input current, or input power reading.

Rating

Model	PLZ164W	PLZ334W	PLZ1004W	PLZ164WA	PLZ664WA
Operating voltage (DC) ^{*1}	1.5 V – 150 V ^{*2}			0 V – 150 V ^{*3}	
Current	33 A	66 A	200 A	33 A	132 A
Power	165 W	330 W	1 000 W	165 W	660 W

*1 Minimum voltage at which the current starts flowing to the PLZ-4W is approximately 0.3 V. For description of the minimum voltage, see "3.3 Operating area of the PLZ-4W".

*2 The minimum operating voltage (including the voltage drop due to the wire inductance component) in switching mode increases by 0.15 V per 1 A/μs at slew rate settings greater than 5 A/μs.

*3 The minimum operating voltage (including the voltage drop due to the wire inductance component) in switching mode increases by 0.3 V per 1 A/μs at slew rate settings greater than 5 A/μs.

CC mode

Model		PLZ164W	PLZ334W	PLZ1004W	PLZ164WA	PLZ664WA	
Operating range	Range	H	0 A – 33 A	0 A – 66 A	0 A – 200 A	0 A – 33 A	0 A – 132 A
		M	0 A – 3.3 A	0 A – 6.6 A	0 A – 20 A	0 A – 3.3 A	0 A – 13.2 A
		L	0 A – 330 mA	0 A – 660 mA	0 A – 2 A	0 A – 330 mA	0 A – 1.32 A
Setting range	Range	H	0 A – 34.65 A	0 A – 69.3 A	0 A – 210 A	0 A – 34.65 A	0 A – 138.6 A
		M	0 A – 3.465 A	0 A – 6.93 A	0 A – 21 A	0 A – 3.465 A	0 A – 13.86 A
		L	0 A – 346.5 mA	0 A – 693 mA	0 A – 2.1 A	0 A – 346.5 mA	0 A – 1.386 A
Resolution	Range	H	1 mA	2 mA	10 mA	1 mA	10 mA
		M	0.1 mA	0.2 mA	1 mA	0.1 mA	1 mA
		L	0.01 mA	0.02 mA	0.1 mA	0.01 mA	0.1 mA
Accuracy of setting	Range	H, M	$\pm(0.2\% \text{ of set} + 0.1\% \text{ of f.s}^{*1}) + V_{in}^{*2}/500 \text{ k}\Omega$				
		L	$\pm(0.2\% \text{ of set} + 0.1\% \text{ of f.s})$				
	Parallel operation	$\pm(1.2\% \text{ of set} + 1.1\% \text{ of f.s}^{*3})$					
Input voltage variation ^{*4}	Range	H	2 mA	4 mA	10 mA	2 mA	8 mA
		M	2 mA	4 mA	10 mA	2 mA	8 mA
		L	0.1 mA	0.2 mA	0.6 mA	0.1 mA	0.4 mA
Ripple	rms ^{*5}	3 mA	5 mA	20 mA ^{*7}	7.5 mA	30 mA ^{*7}	
	p-p ^{*6}	30 mA	50 mA	100 mA ^{*7}	50 mA	200 mA ^{*7}	

*1 Full scale of H range

*2 V_{in} : Input terminal voltage of Electronic Load

*3 M range applies to the full scale of H range.

*4 When the input voltage is varied from 1.5 V to 150 V at a current of rated power/150 V.

*5 Measurement frequency bandwidth: 10 Hz to 1 MHz

*6 Measurement frequency bandwidth: 10 Hz to 20 MHz

*7 At measurement current of 100 A

CR mode

Model		PLZ164W	PLZ334W	PLZ1004W	PLZ164WA	PLZ664WA	
Operating range *1	Range	H	22 S – 400 μ S (45.455 m Ω – 2.5 k Ω)	44 S – 800 μ S (22.727 m Ω – 1.25 k Ω)	133.332 S – 2.4 mS (7.5 m Ω – 416.666 Ω)	22 S – 400 μ S (45.455 m Ω – 2.5 k Ω)	88 S – 1.6 mS (11.363 m Ω – 625 Ω)
		M	2.2 S – 40 μ S (454.55 m Ω – 25 k Ω)	4.4 S – 80 μ S (227.27 m Ω – 12.5 k Ω)	13.3332 S – 2420 μ S (75 m Ω – 4.1666 k Ω)	2.2 S – 40 μ S (454.55 m Ω – 25 k Ω)	8.8 S – 160 μ S (113.63 m Ω – 6.25 k Ω)
		L	0.22 S – 4 μ S (4.545 5 Ω – 250 k Ω)	0.44 S – 8 μ S (2.272 7 Ω – 125 k Ω)	1.33332 S – 24 μ S (750 m Ω – 41.666 k Ω)	0.22 S – 4 μ S (4.545 5 Ω – 250 k Ω)	0.88 S – 16 μ S (1.136 3 m Ω – 62.5 k Ω)
Setting range	Range	H	23.1 S – 0 S (43.290 m Ω – OPEN)	46.2 S – 0 S (21.692 m Ω – OPEN)	139.9968 S – 0 S (7.1430 m Ω – OPEN)	23.1 S – 0 S (43.290 m Ω – OPEN)	92.4 S – 0 S (10.822 m Ω – OPEN)
		M	2.31 S – 0 S (432.9 m Ω – OPEN)	4.62 S – 0 S (216.92 m Ω – OPEN)	13.99968 S – 0 S (71.430 m Ω – OPEN)	2.31 S – 0 S (432.9 m Ω – OPEN)	9.24 S – 0 S (108.22 m Ω – OPEN)
		L	0.231 S – 0 S (4.329 Ω – OPEN)	0.462 S – 0 S (2.1692 Ω – OPEN)	1.399968 S – 0 S (714.30 m Ω – OPEN)	0.231 S – 0 S (4.329 Ω – OPEN)	0.924 S – 0 S (1.0822 Ω – OPEN)
Resolution	Range	H	400 μ S	800 μ S	2.424 mS	400 μ S	1.6 mS
		M	40 μ S	80 μ S	242.4 μ S	40 μ S	160 μ S
		L	4 μ S	8 μ S	24.24 μ S	4 μ S	16 μ S
Accuracy of setting *2	Range	H, M	$\pm(0.5 \% \text{ of set}^{*3} + 0.5 \% \text{ of f.s}^{*4}) + \text{Vin}^{*5}/500 \text{ k}\Omega$				
		L	$\pm(0.5 \% \text{ of set}^{*3} + 0.5 \% \text{ of f.s})$				

*1 Conductance [S] = Input current [A]/input voltage [V] = 1/resistance [Ω]

*2 Converted value at the input current. At the sensing point. It is not applied for the condition of the parrallel operation.

*3 set = Vin/Rset

*4 Full scale of H range

*5 Vin: Input terminal voltage of Electronic Load

CV mode

Model		PLZ164W	PLZ334W	PLZ1004W	PLZ164WA	PLZ664WA
Operating range	Range	H	1.5 V – 150 V			0 V – 150 V
		L	1.5 V – 15 V			0 V – 15 V
Setting range	Range	H	0 V – 157.5 V			
		L	0 V – 15.75 V			
Resolution	Range	H	10 mV			
		L	1 mV			
Accuracy of setting *1	Range	H, L	$\pm(0.1 \% \text{ of set} + 0.1 \% \text{ of f.s})$			
Input current variation *2			12 mV			

*1 At the sensing point during remote sensing under the operating range of the input voltage. It is also applied for the condition of the parrallel operation.

*2 With respect to a change in the current of 10 % to 100 % of the rating at an input voltage of 1.5 V (during remote sensing).

CP mode

Model		PLZ164W	PLZ334W	PLZ1004W	PLZ164WA	PLZ664WA	
Operating range	Range	H	16.5 W – 165 W	33 W – 330 W	100 W – 1 000 W	16.5 W – 165 W	66 W – 660 W
		M	1.65 W – 16.5 W	3.3 W – 33 W	10 W – 100 W	1.65 W – 16.5 W	6.6 W – 66 W
		L	0.165 W – 1.65 W	0.33 W – 3.3 W	1 W – 10 W	0.165 W – 1.65 W	0.66 W – 6.6 W
Setting range	Range	H	0 W – 173.25 W	0 W – 346.5 W	0 W – 1 050 W	0 W – 173.25 W	0 W – 693 W
		M	0 W – 17.325 W	0 W – 34.65 W	0 W – 105 W	0 W – 17.325 W	0 W – 69.3 W
		L	0 W – 1.7325 W	0 W – 3.465 W	0 W – 10.5 W	0 W – 1.732 5 W	0 W – 6.93 W
Resolution	Range	H	10 mW	10 mW	100 mW	10 mW	20 mW
		M	1 mW	1 mW	10 mW	1 mW	2 mW
		L	0.1 mW	0.1 mW	1 mW	0.1 mW	0.2 mW
Accuracy of setting ^{*1}		±(0.6 % of set + 1.4 % of f.s ^{*2})					

*1 It is not applied for the condition of the parrallel operation.

*2 M range applies to the full scale of H range.

Voltmeter

Model		PLZ164W	PLZ334W	PLZ1004W	PLZ164WA	PLZ664WA
Display	Range	H	0.00 V – 150.00 V			
		L	0.000 V – 15.000 V			
Accuracy		±(0.1 % of rdg + 0.1 % of f.s)				

Ammeter

Model		PLZ164W	PLZ334W	PLZ1004W	PLZ164WA	PLZ664WA	
Display	Range	H, M	0.000 A – 33.000 A	0.000 A – 66.000 A	0.00 A – 200.00 A	0.000 A – 33.000 A	0.00 A – 132.00 A
		L	0.00 A – 330.00 mA	0.00 A – 660.00 mA	0.0000 A – 2.0000 A	0.00 A – 330.00 mA	0.000 A – 1.3200 A
Accuracy		±(0.2 % of rdg + 0.3 % of f.s)					
Parallel operation		±(1.2 % of rdg + 1.1 % of f.s)					

Wattmeter

Model		PLZ164W	PLZ334W	PLZ1004W	PLZ164WA	PLZ664WA	
Display ^{*1}	Range	H, M	0.00 W – 165.00 W	0.00 W – 330.00 W	0.0 W – 1000.0 W	0.00 W – 165.00 W	0.00 W – 660.00 W
		L ^{*2}	0.000 W – 49.500 W	0.000 W – 99.000 W	0.00 W – 300.00 W	0.000 W – 49.500 W	0.000 W – 198.00 W
		L ^{*3}	0.0000 W – 1.6500 W	0.0000 W – 3.3000 W	0.000 W – 10.000 W	0.0000 W – 1.6500 W	0.0000 W – 6.6000 W

*1 Displays the product of the voltmeter reading and ammeter reading.

*2 In a mode other the CP mode

*3 In CP mode

Switching mode

Model		PLZ164W	PLZ334W	PLZ1004W	PLZ164WA	PLZ664WA
Operation mode		CC and CR				
Duty cycle setting		5 % – 95 %* ¹ , 0.1 % step				
Selectable frequency range		1 Hz – 20 kHz				
Frequency resolution	1 Hz – 10 Hz	0.1 Hz				
	10 Hz – 100 Hz	1 Hz				
	100 Hz – 1 kHz	10 Hz				
	1 kHz – 20 kHz	100 Hz				
Frequency accuracy of setting		±(0.5 % of set)				

*1 The minimum time width is 10 μs. Between 5 kHz and 20 kHz, the maximum duty cycle is limited by the minimum time width.

Slew rate

Model			PLZ164W	PLZ334W	PLZ1004W	PLZ164WA	PLZ664WA
Setting range* ¹	Range	H	2.5 mA/μs – 2.5 A/μs	5 mA/μs – 5 A/μs	16 mA/μs – 16 A/μs	2.5 mA/μs – 2.5 A/μs	10 mA/μs – 10 A/μs
		M	250 μA/μs – 250 mA/μs	500 μA/μs – 500 mA/μs	1.6 mA/μs – 1.6 A/μs	250 μA/μs – 250 mA/μs	1 mA/μs – 1 A/μs
		L	25 μA/μs – 25 mA/μs	50 μA/μs – 50 mA/μs	160 μA/μs – 160 mA/μs	25 μA/μs – 25 mA/μs	100 μA/μs – 100 mA/μs
Resolution			See below.				
Accuracy of setting* ²			±(10 % of set + 5 μs)				

*1 In CC mode. The maximum slew rate of each range is 1/10th the value in CR mode.

*2 Time to reach from 10 % to 90 % when the current is varied from 2 % to 100 % (20 % to 100 % in M range) of the rated current.

Slew rate resolution

PLZ164W PLZ164WA	Setting	25 μA/μs – 250 μA/μs	250 μA/μs – 2.5 mA/μs	2.5 mA/μs – 25 mA/μs	25 mA/μs – 250 mA/μs	250 mA/μs – 2.5 A/μs
	Resolution	100 nA	1 μA	10 μA	100 μA	1 mA
PLZ334W	Setting	50 μA/μs – 500 μA/μs	500 μA/μs – 5 mA/μs	5 mA/μs – 50 mA/μs	50 mA/μs – 500 mA/μs	500 mA/μs – 5 A/μs
	Resolution	200 nA	2 μA	20 μA	200 μA	2 mA
PLZ664WA	Setting	100 μA/μs – 1 mA/μs	1 mA/μs – 10 mA/μs	10 mA/μs – 100 mA/μs	100 mA/μs – 1 A/μs	1 A/μs – 10 A/μs
	Resolution	400 nA	4 μA	40 μA	400 μA	4 mA
PLZ1004W	Setting	160 mA/ms – 1.6 mA/ms	1.6 mA/ms – 16 mA/ms	16 mA/ms – 160 mA/ms	160 mA/μs – 1.6 A/μs	1.6 A/μs – 16 A/μs
	Resolution	600 nA	6 mA	60 mA	600 mA	

Soft start

Model		PLZ164W	PLZ334W	PLZ1004W	PLZ164WA	PLZ664WA
Operation mode		CC and CR				
Selectable time range		1, 2, 5, 10, 20, 50, 100, or 200 ms				
Time accuracy		±(30 % of set + 100 μs)				

Remote sensing

Model	PLZ164W	PLZ334W	PLZ1004W	PLZ164WA	PLZ664WA
Voltage that can be compensated	2 V for a single line				

Protection function

Model	PLZ164W	PLZ334W	PLZ1004W	PLZ164WA	PLZ664WA
Overvoltage protection (OVP)	Turns off the load at 110 % of the rated voltage				
Overcurrent protection (OCP)	0.03 A – 36.3 A	0.06 A – 72.6 A	0.2 A – 220 A	0.03 A – 36.3 A	0.13 A – 145.2 A
	Or 110 % of the maximum current of each range Load off or limit selectable				
Overpower protection (OPP)	0.1 W – 181.5 W	0.3 W – 363 W	1 W – 1 100 W	0.1 W – 181.5 W	0.6 W – 726 W
	Or 110 % of the maximum power of each range Load off or limit selectable				
Overheat protection (OHP)	Turns off the load when the heat sink temperature reaches 95 °C				
Undervoltage protection (UVP)	Turns off the load when detected.				
	Can be set in the range of 0 V to 150 V or Off.				
Reverse connection detection (REV)	By diode and fuse. Turns off the load when an alarm occurs.				

Sequence function

Model		PLZ164W	PLZ334W	PLZ1004W	PLZ164WA	PLZ664WA
Normal sequence	Operation mode	CC, CR, CV, or CP				
	Maximum number of steps	256				
	Step execution time	1 ms – 999 h 59 min				
	Time resolution	1 ms (1 ms – 1 min) 100 ms (1 min – 1 h) 1 s (1 h – 10 h) 10 s (10 h – 100 h) 1 min (100 h – 999 h 59 min)				
Fast sequence	Operation mode	CC or CR				
	Maximum number of steps	1024				
	Step execution time	25 µs – 100 ms				
	Time resolution	25 µs (25 µs – 100 µs) 100 µs (100 µs – 100 ms)				

Others

Model	PLZ164W	PLZ334W	PLZ1004W	PLZ164WA	PLZ664WA
Elapsed time display	Measures the time from load on to load off. On/Off selectable.				
	Measures from 1 s up to 999 h 59 min 59 s				
Auto load off timer	Automatically turns off the load after a specified time elapses.				
	Can be set in the range of 1 s to 999 h 59 min 59 s or off				

Common specifications

Analog external control (J1 connector)

Load on/off control input	Turn on the load with low (or high) TTL level signal
Load on status output	On when the load is on (open collector output by a photocoupler)
Range switch input	Switch ranges L, M, and H using a 2-bit signal
Range status output	Outputs range L, M, or H using 2-bit signal (open collector output by a photocoupler)
Trigger input	Clear the sequence operation pause with a high TTL level signal for 10 μ s or more.
Alarm input	Activate alarm with low TTL level signal input
Alarm status output	On when OVP, OCP, OPP, OHP, UVP, REV, or when an external alarm input is applied (open collector output by a photocoupler)
Short signal output	Relay contact output (30 VDC/1 A)
External voltage control	Operates in CC, CR, CP, or CV mode 0 V to 10 V correspond to 0 % to 100 % of the rated current (CC mode), rated voltage (CV mode), or rated power (CP mode). 0 V to 10 V correspond to maximum resistance to minimum resistance (CR mode)
External resistance control	Operates in CC, CR, CP, or CV mode 0 Ω to 10 k Ω correspond to 0 % to 100 % or 100 % to 0 % of the rated current (CC mode), rated voltage (CV mode), or rated power (CP mode). 0 Ω to 10 k Ω correspond to maximum resistance to minimum resistance or minimum resistance to maximum resistance (CR mode)
Current monitor output	10 V for f.s (H or L range) and 1 V for f.s (M range)
Parallel operation input	Signal input for one-control parallel operation
Parallel operation output	Signal output for one-control parallel operation
Load booster power supply control	Power on/off control signal for the load booster

Front panel BNC connector

TRIG OUT	Trigger output: Approx. 4.5 V, pulse width: Approx. 2 μ s, output impedance: Approx. 500 Ω Outputs a pulse during sequence operation and switching operation.
I MON OUT	Current monitor output 1 V for f.s (H or L range) and 0.1 V for f.s (M range)

Communication function

GPIB	IEEE std. 488.1-1987 SH1, AH1, T6, L4, SR1, RL1, PP0, DC1, DT1, C0, E1
	Supports the SCPI and IEEE std. 488.2-1992 command set Sets panel functions except the power switch and reads measured values
RS232C	D-SUB 9-pin connector (conforms to EIA-232-D)
	Sets panel functions except the power switch and reads measured values Supports the SCPI and IEEE std. 488.2-1992 command set
	Baud rate: 2400, 4800, 9600, 19200 bps Data length: 8-bit, Stop bit: 1, 2-bit, Parity bit: None, Flow control: Xon/Xoff
USB	Standard Type B socket Conforms to USB 2.0 Specifications and USBTMC-USB488 Device Class Specifications
	Sets panel functions except the power switch and reads measured values Communication speed 12 Mbps (Full speed)

9.2 General Specifications

Model		PLZ164W	PLZ334W	PLZ1004W	PLZ164WA	PLZ664WA
Input voltage range		100 VAC – 240 VAC (90 VAC – 250 VAC) Single phase, continuous			100 VAC – 120 VAC /200 VAC – 240 VAC (90 VAC – 132 VAC/180 VAC – 250 VAC) Single phase	
Input frequency range		47 Hz – 63 Hz				
Power consumption		80 VAmax	90 VAmax	160 VAmax	300 VAmax	1 500 VAmax ^{*1}
Inrush current		45 A			80 A	
Operating temperature range		0 °C to 40 °C (32 °F to 104 °F)				
Operating humidity range		20 % - 85 % RH (without condensation)				
Storage temperature range		-25 °C to 70 °C (-13 °F to 158 °F)				
Storage humidity range		90 % RH or less (without condensation)				
Isolation voltage		±500 V				
Insulation resistance	Primary - input terminal	500 VDC, 30 MΩ or more (ambient humidity of 70 % RH or less)				
	Primary - chassis	500 VDC, 30 MΩ or more (ambient humidity of 70 % RH or less)				
Withstand voltage	Primary - input terminal	No abnormalities at 1500 VAC for 1 minute.				
	Primary - chassis	No abnormalities at 1500 VAC for 1 minute.				
Dimensions (mm)		See outline drawing				
Weight		Approx. 7 kg (15.43 lb)	Approx. 8 kg (17.64 lb)	Approx. 15 kg (33.07 lb)	Approx. 7.5 kg (16.53 lb)	Approx. 16 kg (35.27 lb)
Battery backup		Backs up setup information				
Accessories	Power cord	1 pc. (with plug, Length: approx. 2.4 m)				
	Load input terminal cover	1 piece 2 lock plates provided				
	Set of screws for the load input terminal	2 sets (bolts, nuts, and spring washers)				
	Setup Guide	1 piece (Japanese, English)				
	Quick Reference	Japanese: 1 piece, English: 1 piece				
	CD-ROM ^{*2}	1 piece				
Safety ^{*3}		Complies with the requirements of the following directive and standard. Low Voltage Directive 2014/35/EU ^{*4} EN 61010-1 (Class I ^{*5} , Pollution degree 2 ^{*6})				
Electromagnetic compatibility (EMC) ^{*3, *4}		Complies with the requirements of the following directive and standards. EMC Directive 2014/30/EU EN 61326-1 (Class A ^{*7}) EN 55011 (Class A ^{*7} , Group 1 ^{*8}) EN 61000-3-2 ^{*9} EN 61000-3-3 ^{*9} Under following condition. The maximum length of all connecting cables and wires to the PLZ-4W series are less than 3 m.				

*1. 900 VA when input voltage is 100 VAC.

*2. Contains Application & Samples, User's manual, the Communication Interface Manual and KI-VISA.

*3. Does not apply to specially ordered or modified PLZ-4Ws.

*4. Limited to products that have the CE mark on their panels. Not be in compliance with EMC limits unless the ferrite core is attached on the cable for connection of J1 connector.

- 
- *5. This is a Class I equipment. Be sure to ground this product's protective conductor terminal. The safety of this product is only guaranteed when the product is properly grounded.
 - *6. Pollution is addition of foreign matter (solid, liquid or gaseous) that may produce a reduction of dielectric strength or surface resistivity. Pollution Degree 2 assumes that only non-conductive pollution will occur except for an occasional temporary conductivity caused by condensation.
 - *7. This is a Class A equipment. This product is intended for use in an industrial environment. This product may cause interference if used in residential areas. Such use must be avoided unless the user takes special measures to reduce electromagnetic emissions to prevent interference to the reception of radio and television broadcasts.
 - *8. This is a Group 1 equipment. This product does not generate and/or use intentionally radio-frequency energy, in the form of electromagnetic radiation, inductive and/or capacitive coupling, for the treatment of material or inspection/analysis purpose.
 - *9. Excluding the PLZ664WA.

9.3 Dimensions

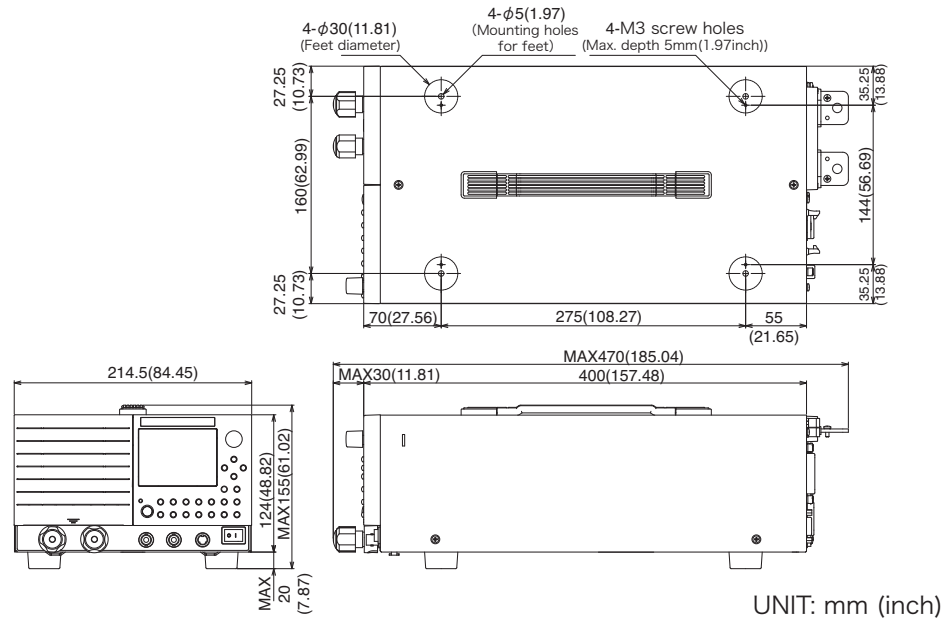

Fig.9-1 Outline drawing (PLZ164W, PLZ164WA, and PLZ334W)

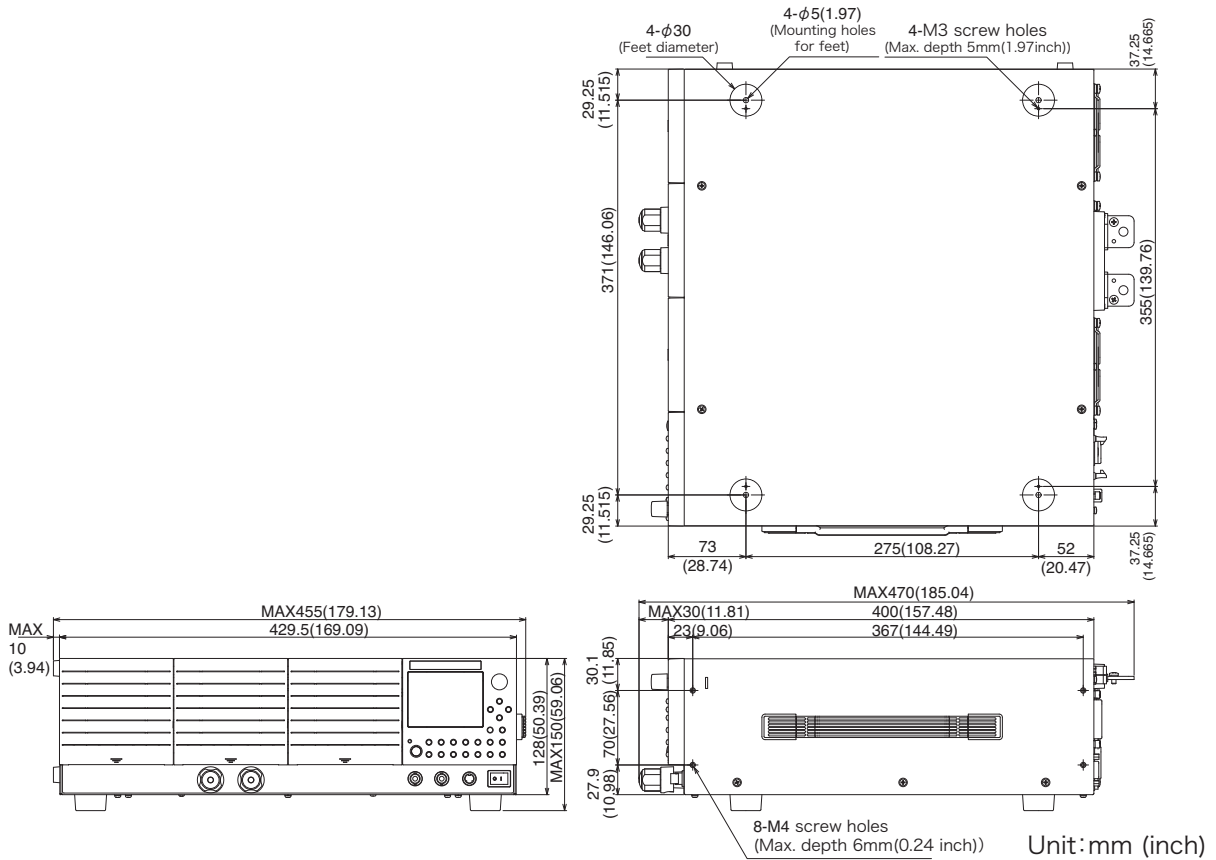

Fig. 9-2 Outline drawing (PLZ664WA and PLZ1004W)

Appendix

The appendices cover the operating area of the PLZ-4W, the basic operation modes and sequence program creation table.

A.1 Operating Area of the PLZ-4W

As shown in Fig. A-1, the PLZ-4W can be used within the area enclosed by the constant voltage line according to the rated voltage (L1), the constant power line according to the rated power (L2), the constant current line according to the rated current (L3), and the constant voltage line according to the minimum operating voltage (L4) (operating area where specifications are guaranteed). For PLZ-4Ws with the minimum operating voltage of 0 V, the specifications are guaranteed at input voltages at 0 V and greater. For 1.5 V input types, the specifications are guaranteed at input voltages of 1.5 V and greater. If the current is decreased, these types can be used even at voltages lower than 1.5 V (actual operating area). However, the specifications are not guaranteed.

For the operating areas of each individual model, see appendix A.3, “Operating Area of Each Model.”

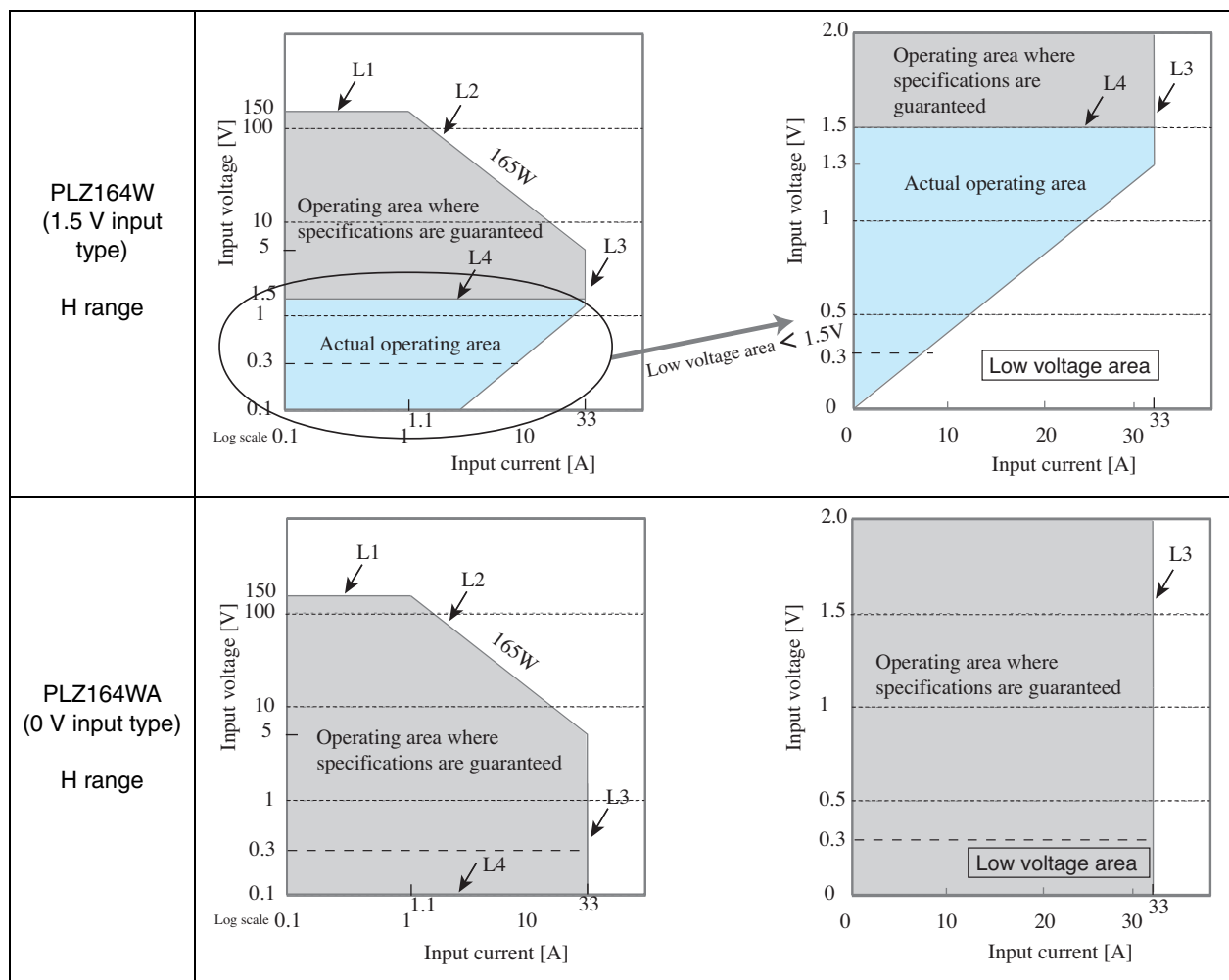

Fig.A-1 Operating area

A.2 Basic Operation Modes

The following six operation modes are available on the PLZ-4W.

1. Constant current mode (CC mode)
2. Constant resistance mode (CR mode)
3. Constant power mode (CP mode)
4. Constant voltage mode (CV mode)
5. Constant current and constant voltage mode (CC+CV mode)
6. Constant resistance and constant voltage mode (CR+CV mode)

A.2.1 Operation of the CC Mode

In CC mode, the current is kept constant even when the voltage changes.

■ CC mode operation

When the PLZ-4W is used in CC mode, the PLZ-4W operates as a constant current load as shown in Fig. A-2. The PLZ-4W sinks the specified current (I) independent of the output voltage of the constant-voltage power supply ($V1$).

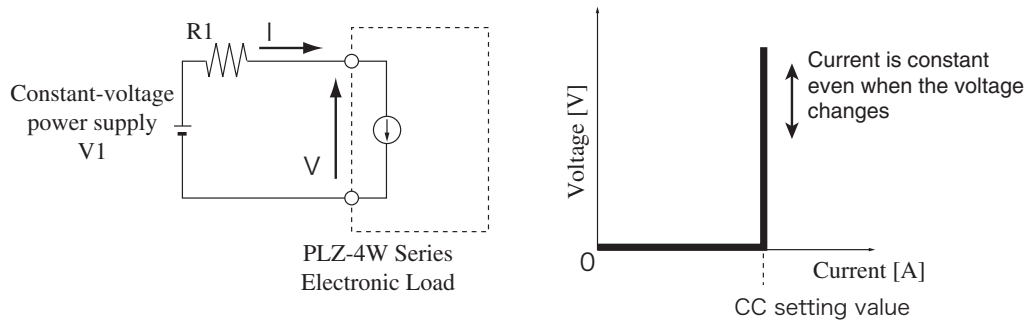

Fig. A-2 Equivalent circuit of the constant current load and operation

■ Transition of the operating point: Overpower protection (OPP)

We will consider the case when checking the load characteristics of the constant-voltage power supply of Fig. A-3 using CC mode.

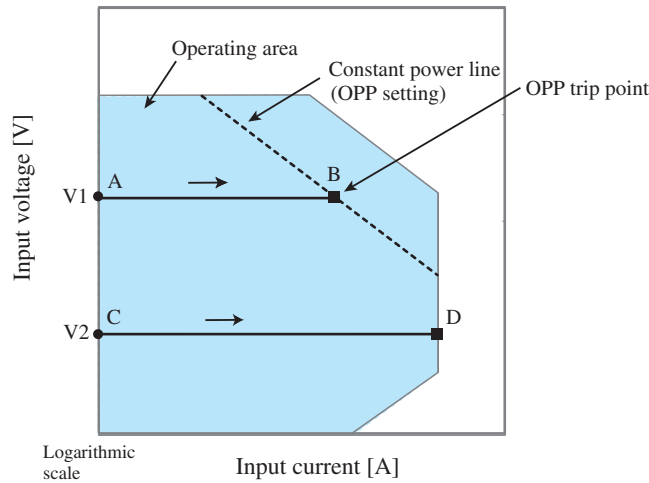

Fig. A-3 Transition of the operating point in CC mode (OPP trip point)

Fig. A-3: Operation on segment AB

If the voltage of the constant-voltage power supply is set to V1 and the input current (load current) of the PLZ-4W is increased, the operating point moves along segment AB.

When point B is reached, overpower protection (OPP) trips. At this point, two types of operation are available on the PLZ-4W depending on the protection action setting of the OPP.

If Protect Action is set to LOAD OFF, the load is turned off.

If protection action is set to LIMIT, the PLZ-4W sinks current as a constant power load at point B. Even if you attempt to increase the input current, the current is limited at point B. If you decrease the input current, the OPP is cleared. The PLZ-4W returns to CC mode, and the operating point moves along segment AB.

TableA-1 OPP action (protect action)

Point B	LOAD OFF	Turns off the load (stops the current flow). The PLZ-4W no longer operates as a load.
	LIMIT	CC mode ends. OPP continues, and the PLZ-4W sinks current as a constant power load.

Fig. A-3: Operation on segment CD

If the voltage of the constant-voltage power supply is set to V2 and the input current (load current) of the PLZ-4W is increased, the operating point moves along segment CD. Point D is the maximum current at the range being used.

A.2.2 Operation of the CR Mode

In CR mode, the PLZ-4W sinks current proportional to the voltage variation.

■ CR mode operation

When the PLZ-4W is used in CR mode, the PLZ-4W operates as a resistive load as shown in Fig. A-4. When the voltage (V_1) of the constant-voltage power supply varies, the PLZ-4W sinks current to maintain $I = V/R$, with the specified resistance R fixed. This mode cannot be used with an AC circuit.

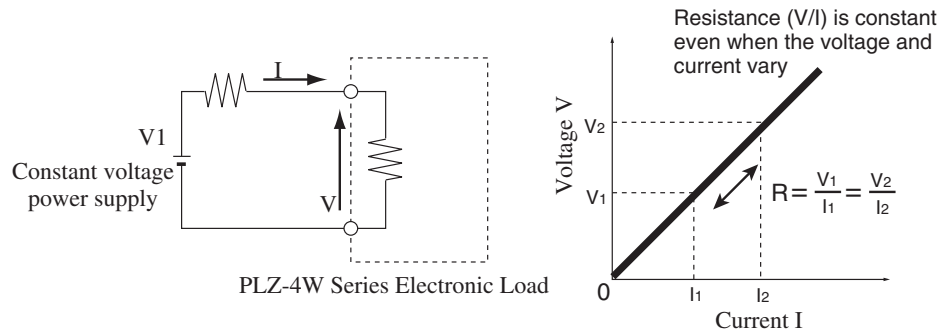

Fig. A-4 Equivalent circuit of the constant resistance load and operation

■ Transition of the operating point: Overpower protection (OPP)

We will consider the case when checking the load characteristics of the constant-voltage power supply of Fig. A-4 using CR mode.

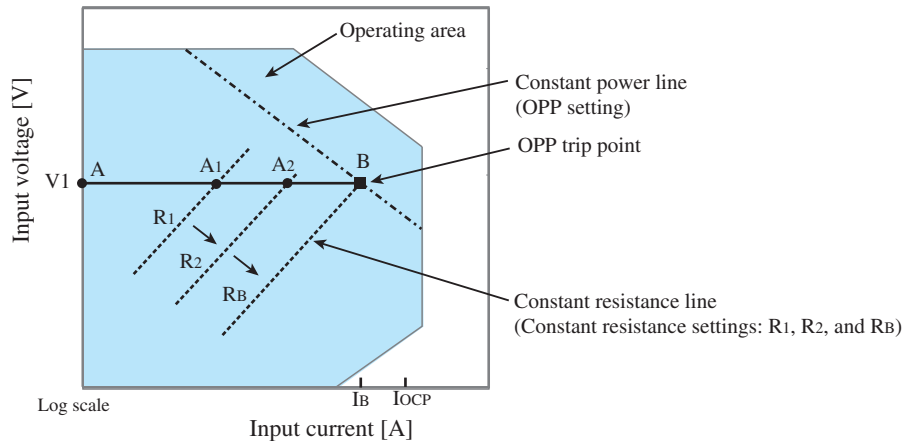

Fig. A-5 Transition of the operating point in CR mode (OPP trip point)

If the overcurrent protection (OCP) setting I_{OCP} is greater than the current value I_B at point B, when the PLZ-4W resistance is decreased ($R_1 \rightarrow R_2 \rightarrow R_B$) and the input current (load current) is increased with the voltage of the constant-voltage power supply at V_1 , the operating point moves along segment AB ($A_1 \rightarrow A_2 \rightarrow B$). When point B is reached, overpower protection (OPP) trips.

At this point, two types of operation are available on the PLZ-4W depending on the protection action setting of the OPP.

If Protect Action is set to LOAD OFF, the load is turned off.

If protection action is set to LIMIT, the PLZ-4W sinks current as a constant power load at point B. Even if you attempt to increase the input current by decreasing the resistance, the current is limited at point B. If you decrease the input current by increasing the resistance, the OPP is cleared. The PLZ-4W returns to CR mode, and the operating point moves along segment AB.

Table A-2 OPP action (protect action)

Point B	LOAD OFF	Turns off the load (stops the current flow). The PLZ-4W no longer operates as a load.
	LIMIT	CR mode ends. OPP continues, and the PLZ-4W sinks current as a constant power load.

■ Transition of the operating point: Overcurrent protection (OCP)

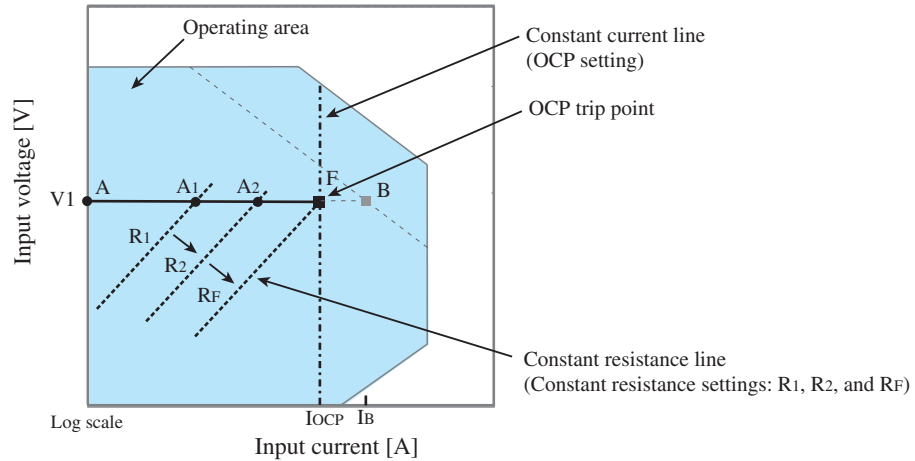

Fig. A-6 Transition of the operating point in CR mode (OCP trip point)

If the overcurrent protection (OCP) setting I_{OCP} is less than the current value I_B at point B, when the PLZ-4W resistance is decreased ($R_1 \rightarrow R_2 \rightarrow R_F$) and the input current (load current) is increased with the voltage of the constant-voltage power supply at V_1 , the operating point moves along segment AF ($A_1 \rightarrow A_2 \rightarrow F$). When point F is reached, overcurrent protection (OCP) trips.

At this point, two types of operation are available on the PLZ-4W depending on the protection action setting of the OCP.

If Protect Action is set to LOAD OFF, the load is turned off.

If protection action is set to LIMIT, the PLZ-4W sinks current as a constant current load at point F. Even if you attempt to increase the input current by decreasing the resistance, the current is limited at point F. If you decrease the input current by increasing the resistance, the OCP is cleared. The PLZ-4W returns to CR mode, and the operating point moves along segment AF.

Table A-3 OCP action (protect action)

Point F	LOAD OFF	Turns off the load (stops the current flow). The PLZ-4W no longer operates as a load.
	LIMIT	CR mode ends. OCP continues, and the PLZ-4W sinks current as a constant current load.

A.2.3 Operation of the CP Mode

In CP mode, the PLZ-4W sinks current so that the power consumed inside the electronic load is constant.

■ CP mode operation

When the PLZ-4W is used in CP mode, the PLZ-4W operates as a constant power load as shown in Fig. A-7. When the voltage (V_1) of the constant-voltage power supply increases the input current (I) decreases so that the power consumed by the PLZ-4W $P = V \times I$ is kept constant. In Fig. A-7, $P = V_2 \times I_2 = V_3 \times I_3$.

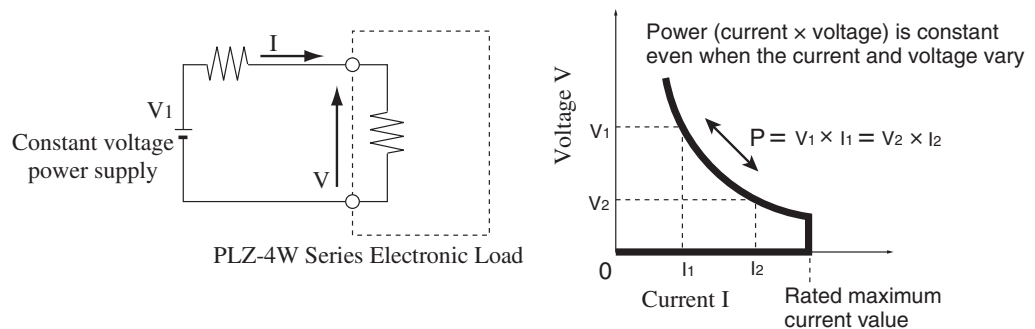

Fig. A-7 Equivalent circuit of the CP mode and operation

■ Transition of the operating point: Overcurrent protection (OCP)

We will consider the case when checking the load characteristics of the constant-voltage power supply of Fig. A-7 using CP mode.

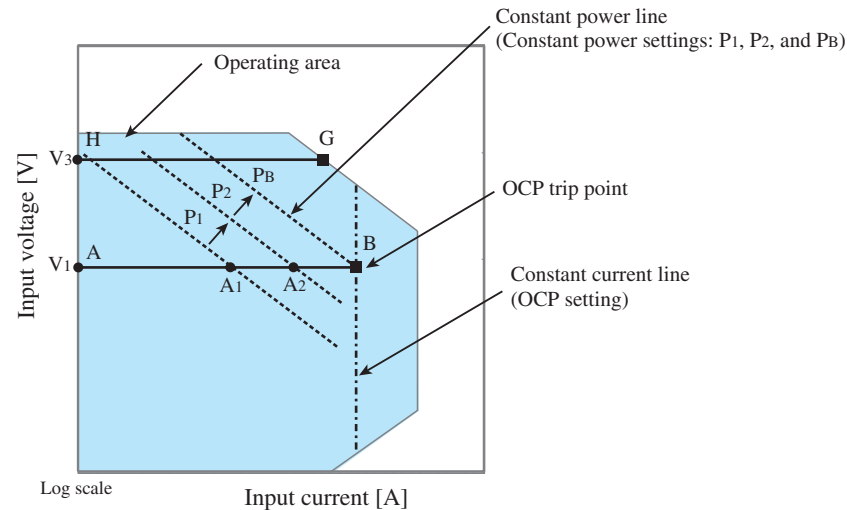

Fig. A-8 Transition of the operating point in CP mode (OCP trip point)

Fig. A-8: Operation on segment AB

If the voltage of the constant-voltage power supply is set to V1 and the power of the PLZ-4W is increased ($P_1 \rightarrow P_2 \rightarrow P_B$), the operating point moves along segment AB ($A_1 \rightarrow A_2 \rightarrow B$).

When point B is reached, overcurrent protection (OCP) trips. At this point, two types of operation are available on the PLZ-4W depending on the protection action setting of the OCP.

If Protect Action is set to LOAD OFF, the load is turned off.

If protection action is set to LIMIT, the PLZ-4W sinks current as a constant current load at point B. Even if you attempt to increase the input current, the current is limited at point B. If you decrease the input current, the OCP is cleared. The PLZ-4W returns to CP mode, and the operating point moves along segment AB.

Table A-4 OCP action (protect action)

Point B	LOAD OFF	Turns off the load (stops the current flow). The PLZ-4W no longer operates as a load.
	LIMIT	CP mode ends. OCP continues, and the PLZ-4W sinks current as a constant current load.

Fig. A-8: Operation on segment GH

If the voltage of the constant-voltage power supply is set to V3 and the power of the PLZ-4W is increased ($P_1 \rightarrow P_2 \rightarrow P_B$), the operating point moves along segment GH. Point G is the maximum power at the range being used.

A.2.4 Operation of the CV Mode

In CV mode, the PLZ-4W sinks current so that the voltage at the load input end of the PLZ-4W is constant.

■ CV mode operation

When the PLZ-4W is used in CV mode, the PLZ-4W operates as a constant voltage load (shunt regulator) as shown in Fig. A-9. When V_1 is greater than V , the input voltage V is kept constant even when the input current I varies. Current does not flow when V_1 is less than or equal to V .

In the Fig. A-9, R_1 is the internal resistance of the constant-voltage power supply. The PLZ-4W may operate unstably if R_1 is low.

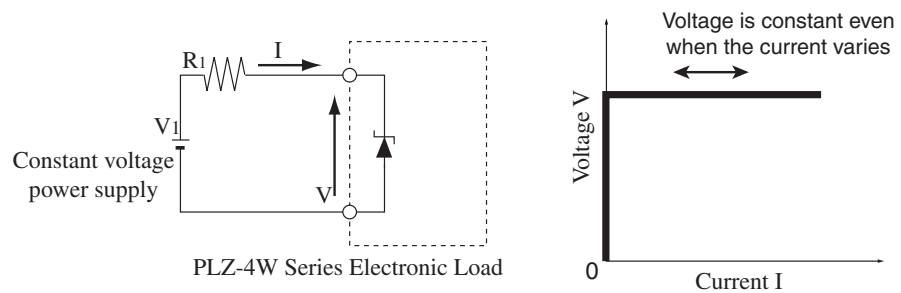

Fig. A-9 Equivalent circuit of the CV mode and operation

■ Transition of the operating point: Overpower protection (OPP)

We will consider the case when checking the load characteristics of the constant-voltage power supply of Fig. A-9 using CV mode.

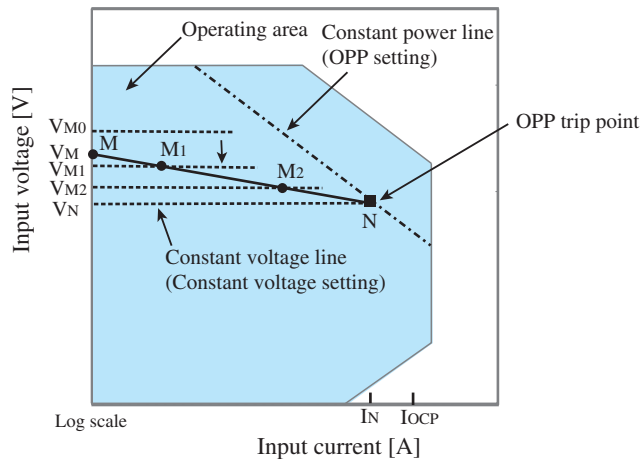

Fig. A-10 Transition of the operating point in CV mode (OPP trip point)

We assume that the overcurrent protection (OCP) setting I_{OCP} is greater than current I_N at point N and denote the voltage of the constant voltage power supply as V_M . When the voltage of the PLZ-4W is equal to V_{M0} ($V_{M0} > V_M$), no current flows. When the voltage of the PLZ-4W is decreased to a point in which V_{M0} is smaller than V_M , the current starts flowing. If the voltage is decreased further ($V_{M1} \rightarrow V_{M2} \rightarrow V_N$) to increase the input current (load current), the operating point moves along segment MN ($M_1 \rightarrow M_2 \rightarrow N$).

When point N is reached, overpower protection (OPP) trips. At this point, two types of operation are available on the PLZ-4W depending on the protection action setting of the OPP.

If Protect Action is set to LOAD OFF, the load is turned off.

If protection action is set to LIMIT, the PLZ-4W sinks current as a constant power load at point N. Even if you attempt to decrease the voltage, the current is limited at point N. If you increase the voltage, the OPP is cleared. The PLZ-4W returns to CV mode, and the operating point moves along segment MN.

Table A-5 OPP action (protect action)

Point N	LOAD OFF	Turns off the load (stops the current flow). The PLZ-4W no longer operates as a load.
	LIMIT	CV mode ends. OPP continues, and the PLZ-4W sinks current as a constant power load.

■ Transition of the operating point: Overcurrent protection (OCP)

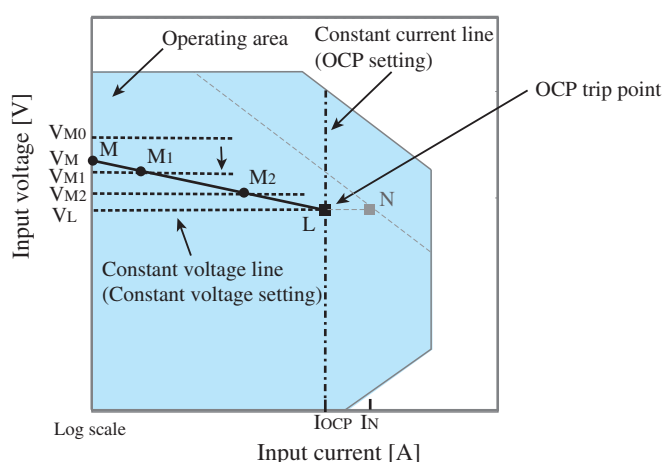

Fig. A-11 Transition of the operating point in CV mode (OCP trip point)

We assume that the overcurrent protection (OCP) setting I_{OCP} is less than current I_N at point N and denote the voltage of the constant voltage power supply as V_M . When the voltage of the PLZ-4W is equal to V_{M0} ($V_{M0} > V_M$), no current flows. When the voltage of the PLZ-4W is decreased to a point in which V_{M0} is smaller than V_M , the current starts flowing. If the voltage is decreased further ($V_{M1} \rightarrow V_{M2} \rightarrow V_L$) to increase the input current (load current), the operating point moves along segment ML ($M_1 \rightarrow M_2 \rightarrow L$).

When point L is reached, overcurrent protection (OCP) trips. At this point, two types of operation are available on the PLZ-4W depending on the protection action setting of the OCP.

If Protect Action is set to LOAD OFF, the load is turned off.

If protection action is set to LIMIT, the PLZ-4W sinks current as a constant current load at point L. Even if you attempt to decrease the voltage, the current is limited at point L. If you increase the voltage, the OCP is cleared. The PLZ-4W returns to CV mode, and the operating point moves along segment ML.

Table A-6 OCP action (protect action)

Point L	LOAD OFF	Turns off the load (stops the current flow). The PLZ-4W no longer operates as a load.
	LIMIT	CV mode ends. OCP continues, and the PLZ-4W sinks current as a constant current load.

A.2.5 Operation of the CC+CV Mode

The PLZ-4W allows you to add CV mode to CC mode.

■ CC+CV mode operation

When the PLZ-4W is used in CC+CV mode, the PLZ-4W operates as a constant current load and a constant voltage load (shunt regulator) as shown in Fig. A-12. When operating as a constant current load, the PLZ-4W sinks the specified current (I) independent of the output voltage of the constant-voltage power supply (V_M). When operating as a constant voltage load and V_M is greater than V , the input voltage V is kept constant even when the input current I varies. Current does not flow when V_M is less than or equal to V .

The switching between the modes is automatic. In the Fig. A-12, R_1 is the internal resistance of the constant-voltage power supply. In constant-voltage (CV) mode, the PLZ-4W may operate unstably if R_1 is low.

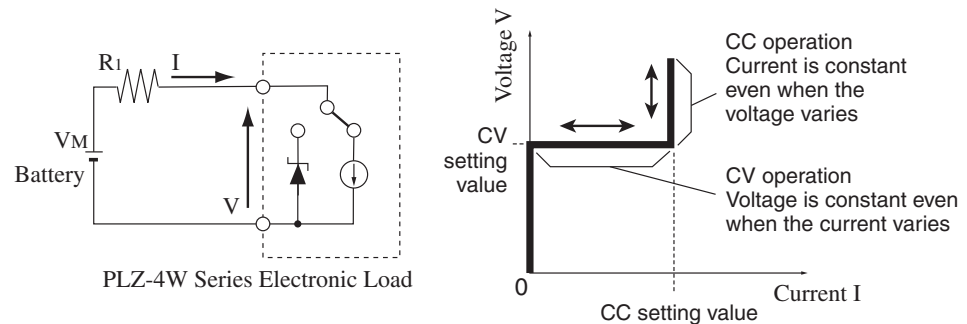

Fig. A-12 Equivalent circuit of the CC+CV mode and operation

■ Transition of the operating point: Overpower protection (OPP)

We will consider the case when checking the discharge characteristics of a battery of Fig. A-12.

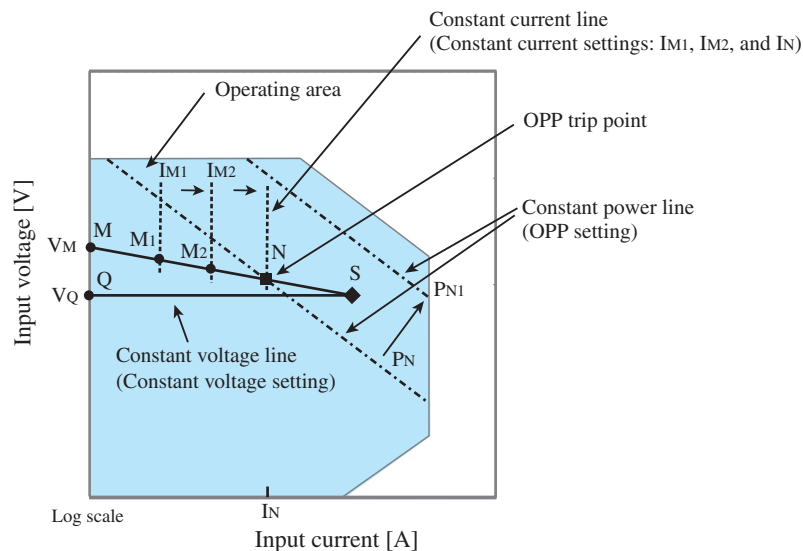

Fig. A-13 Transition of the operating point in CC+CV mode (OPP trip point)

We denote the voltage of the battery as V_M . In CC mode, if the current is increased ($I_{M1} \rightarrow I_{M2} \rightarrow I_N$) to increase the input current (load current), the operating point moves along segment MN ($M_1 \rightarrow M_2 \rightarrow N$).

When the overpower protection (OPP) setting is P_N , the OPP trips when point N is reached.

At this point, two types of operation are available on the PLZ-4W depending on the protection action setting of the OPP.

If Protect Action is set to LOAD OFF, the load is turned off.

If protection action is set to LIMIT, the PLZ-4W sinks current as a constant power load at point N. Even if you attempt to increase the current, the current is limited at point N. If you decrease the current, the OPP is cleared. The PLZ-4W returns to CC mode, and the operating point moves along segment MN.

Table A-7 OPP action (protect action)

Point N	LOAD OFF	Turns off the load (stops the current flow). The PLZ-4W no longer operates as a load.
	LIMIT	CC mode ends. OPP continues, and the PLZ-4W sinks current as a constant power load.

If the overpower protection (OPP) setting is P_{N1} , the OPP does not trip as the current is increased, and the operating point reaches point S.

Here, the operation mode is CV. The voltage is fixed to voltage V_Q set in advance. In this case, the operating point moves along segment QS. The current is determined by the battery voltage and its internal resistance.

A.2.6 Operation of the CR+CV Mode

The PLZ-4W allows you to add CV mode to CR mode.

■ CR+CV mode operation

When the PLZ-4W is used in CR+CV mode, the PLZ-4W operates as a constant resistance load and a constant voltage load (shunt regulator) as shown in Fig. A-14. When operating as a constant resistance load and the voltage (V_M) of the constant-voltage power supply is varied, the PLZ-4W sinks current to meet $I=V/R$ according to the specified resistance R . When operating as a constant voltage load and V_M is greater than V , the input voltage V is kept constant even when the input current I varies. Current does not flow when V_M is less than or equal to V .

The switching between the modes is automatic. In the Fig. A-14, R_1 is the internal resistance of the constant-voltage power supply. In constant-voltage (CV) mode, the PLZ-4W may operate unstably if R_1 is low.

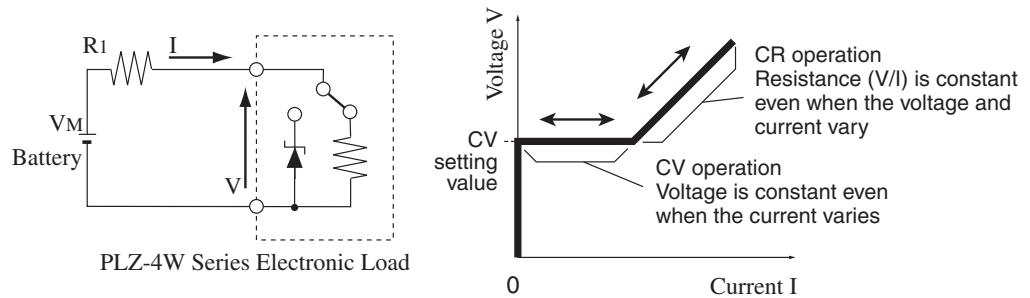

Fig. A-14 Equivalent circuit of the CR+CV mode and operation

■ Transition of the operating point: Overpower protection (OPP)

We will consider the case when checking the discharge characteristics of a battery in Fig. A-14.

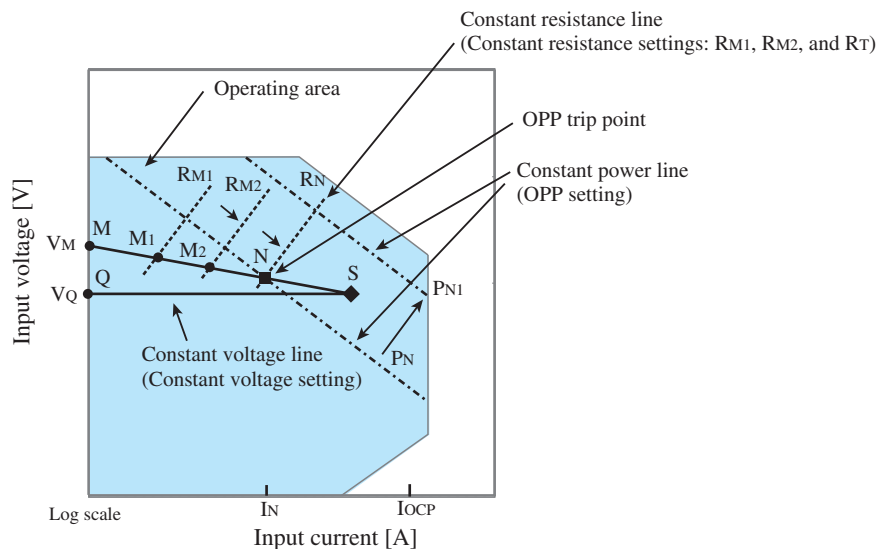

Fig. A-15 Transition of the operating point in CR+CV mode (OPP trip point)

We assume that the overcurrent protection (OCP) setting I_{OCP} is greater than current I_N at point N and denote the voltage of the battery as V_M . In CR mode, if the resistance is decreased ($R_{M1} \rightarrow R_{M2} \rightarrow R_N$) to increase the input current (load current), the operating point moves along segment MN ($M_1 \rightarrow M_2 \rightarrow N$).

When the overpower protection (OPP) setting is P_N , the OPP trips when point N is reached.

At this point, two types of operation are available on the PLZ-4W depending on the protection action setting of the OPP.

If Protect Action is set to LOAD OFF, the load is turned off.

If protection action is set to LIMIT, the PLZ-4W sinks current as a constant power load at point N. Even if you attempt to increase the current by decreasing the resistance, the current is limited at point N. If you decrease the current by increasing the resistance, the OPP is cleared. The PLZ-4W returns to CR mode, and the operating point moves along segment MN.

Table A-8 OPP action (protect action)

Point N	LOAD OFF	Turns off the load (stops the current flow). The PLZ-4W no longer operates as a load.
	LIMIT	CR mode ends. OPP continues, and the PLZ-4W sinks current as a constant power load.

If the overpower protection (OPP) setting is P_{N1} , the OPP does not trip as the resistance is decreased to increase the current. Consequently, the operating point reaches point S.

Here, the operation mode is CV. The voltage is fixed to voltage V_Q set in advance. In this case, the operating point moves along segment QS. The current is determined by the battery voltage and its internal resistance.

■ Transition of the operating point: Overcurrent protection (OCP)

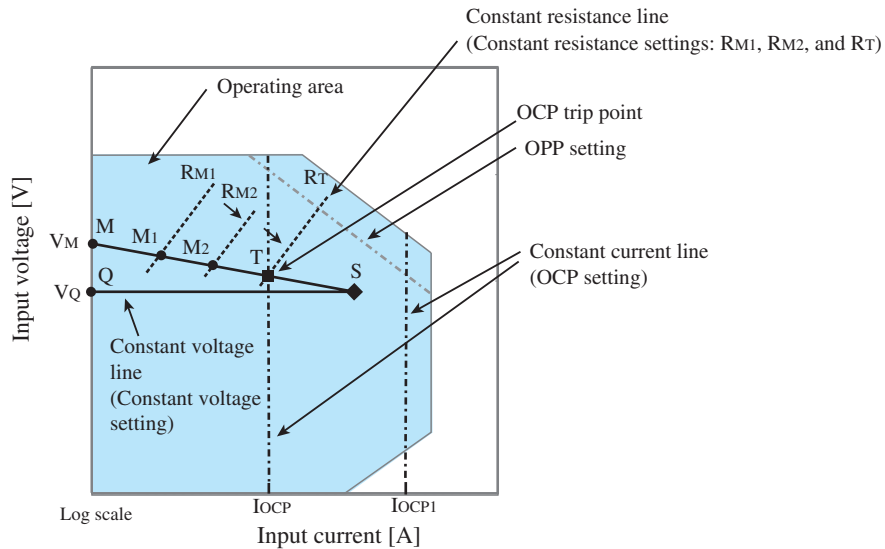

Fig. A-16 Transition of the operating point in CR+CV mode (OCP trip point)

We assume that the overcurrent protection (OCP) setting I_{OCP} is less than the current produced by the tripping of the overpower protection (OPP) and denote the voltage of the battery as V_M . In CR mode, if the resistance is decreased ($R_{M1} \rightarrow R_{M2} \rightarrow R_T$) to increase the input current (load current), the operating point moves along segment MT ($M_1 \rightarrow M_2 \rightarrow T$).

When the overcurrent protection (OCP) setting is I_{OCP} , the OCP trips when point T is reached. At this point, two types of operation are available on the PLZ-4W depending on the protection action setting of the OCP.

If Protect Action is set to LOAD OFF, the load is turned off.

If protection action is set to LIMIT, the PLZ-4W sinks current as a constant current load at point T. Even if you attempt to increase the current by decreasing the resistance, the current is limited at point T. If you decrease the current by increasing the resistance, the OCP is cleared. The PLZ-4W returns to CR mode, and the operating point moves along segment MT.

Table A-9 OCP action (protect action)

Point T	LOAD OFF	Turns off the load (stops the current flow). The PLZ-4W no longer operates as a load.
	LIMIT	CR mode ends. OCP continues, and the PLZ-4W sinks current as a constant current load.

If the overcurrent protection (OCP) setting is I_{OCP1} , the OCP does not trip as the resistance is decreased to increase the current. Consequently, the operating point reaches point S.

Here, the operation mode is CV. The voltage is fixed to voltage V_Q set in advance. In this case, the operating point moves along segment QS. The current is determined by the battery voltage and its internal resistance.

A.3 Operating Area of Each Model

A.3.1 Operating Area of the PLZ164W

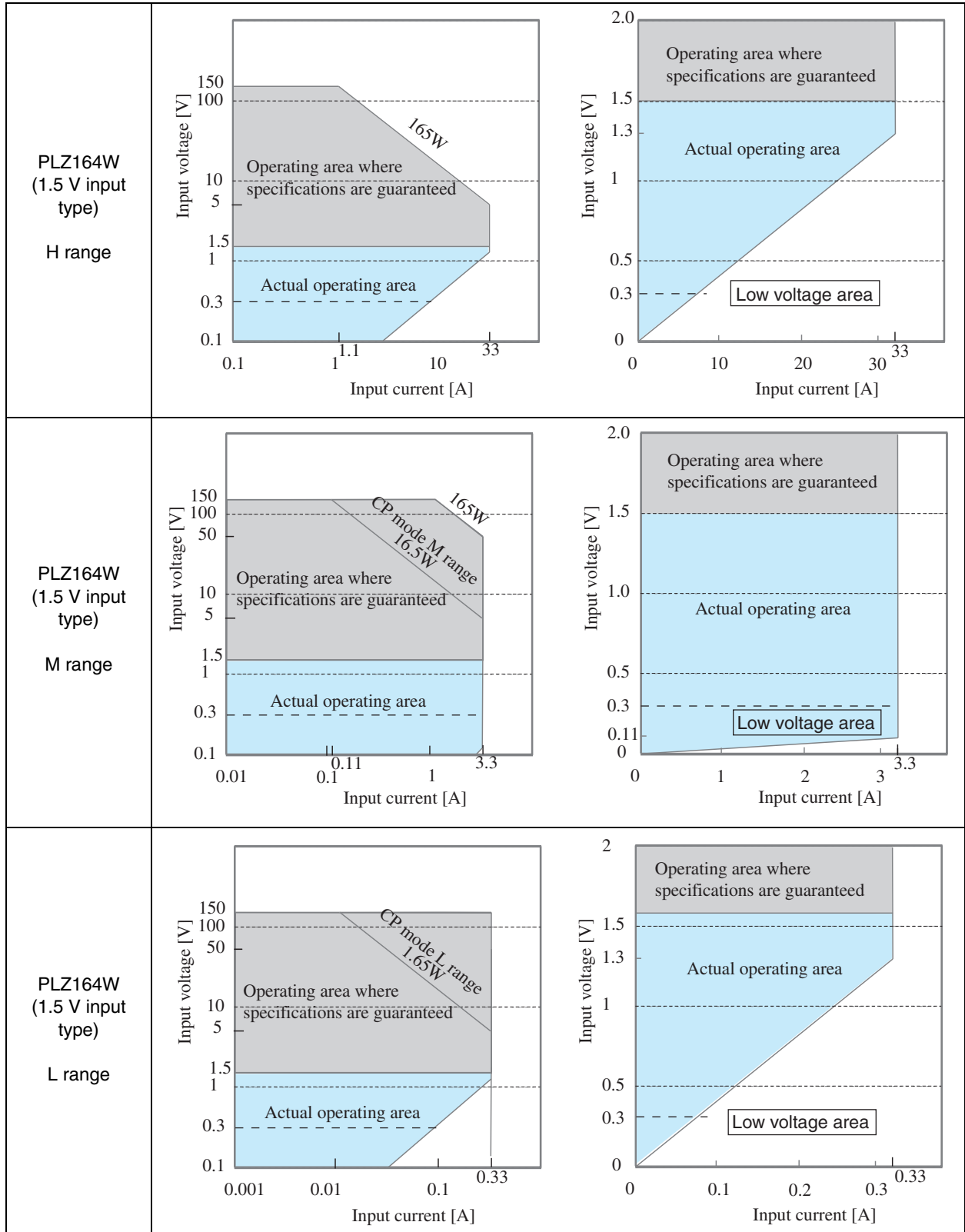

A.3.2 Operating Area of the PLZ334W

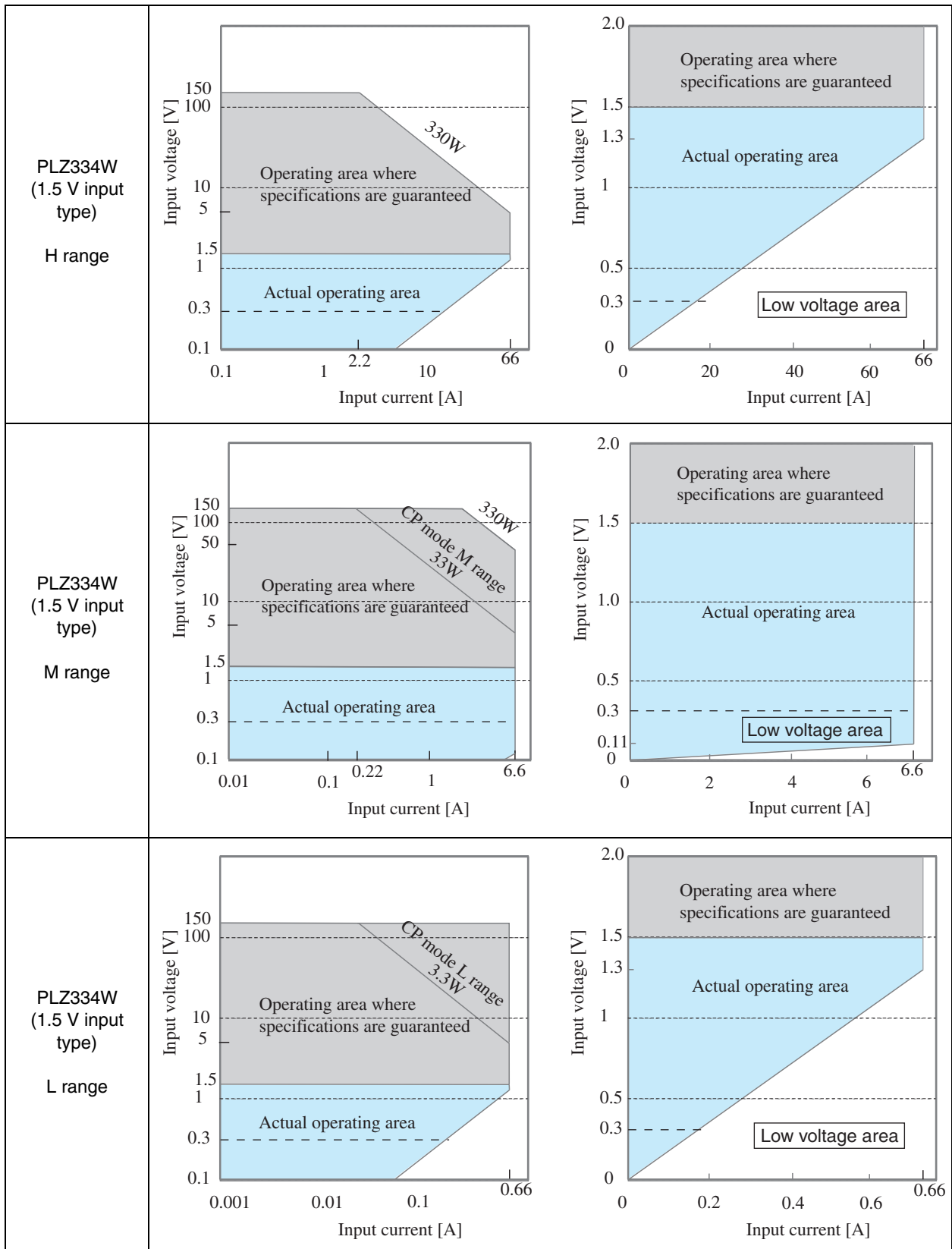

A.3.3 Operating Area of the PLZ1004W

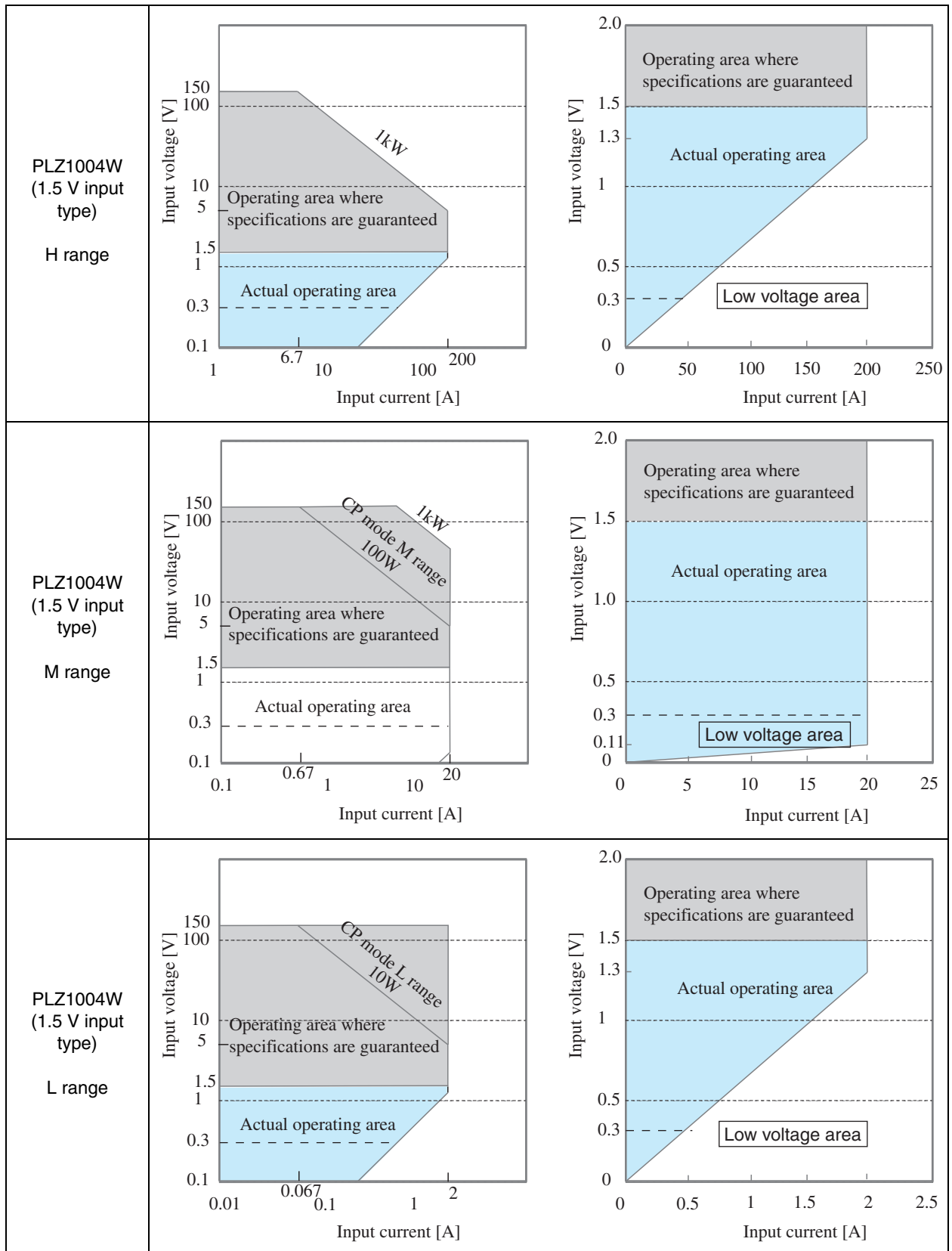

A.3.4 Operating Area of the PLZ164WA

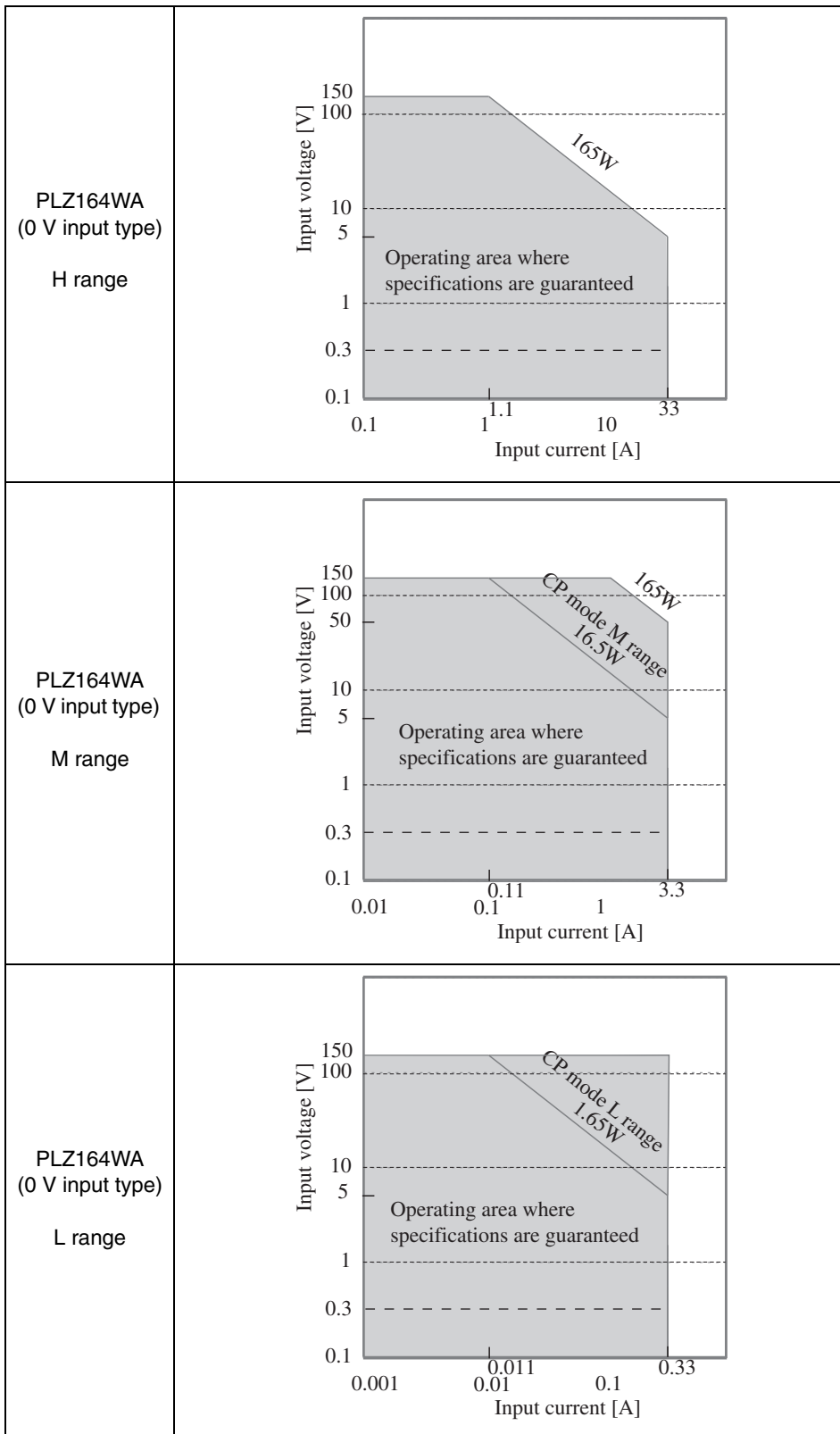

A.3.5 Operating Area of the PLZ664WA

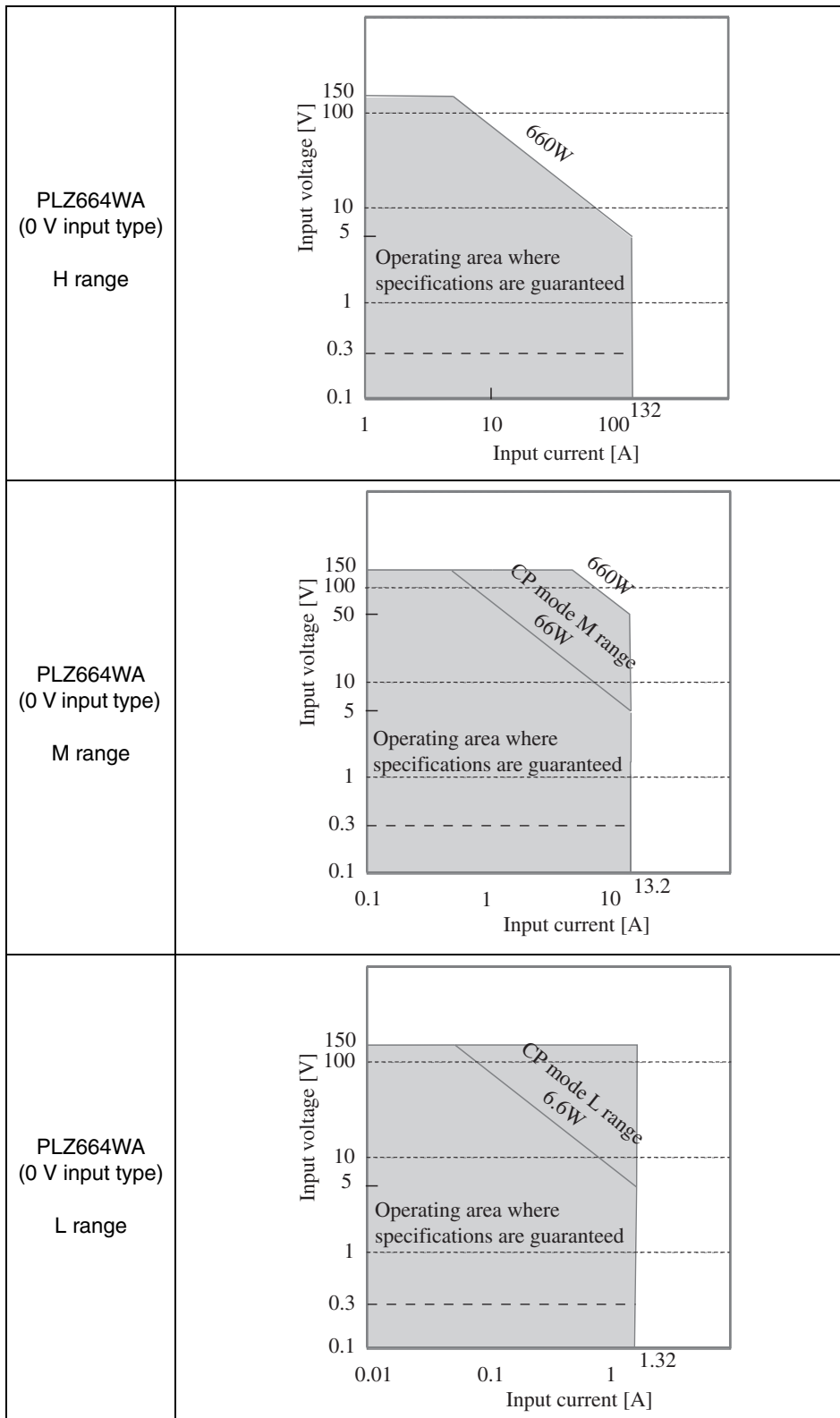

A.4 Sequence Program Creation Table

For normal sequence

Program name:		Date:	By:
Program number (1 to 10)			
Memo (Up to 11 characters)			
Operation mode	CC, CR, CV, CP		
Range Current (A) -- Voltage (V)	(A) -- (V)		
Loop (1 to 9999)			
Last Load (OFF/ON)	OFF, ON		
Last Set			
Chain (OFF, 1 to 10)			

Step number	Setting (mA, mS, V, W)	Execution time (h:min:s:ms)	LOAD	RAMP	TRIG	PAUSE	Note
1							
2							
3							
4							
5							
6							
7							
8							
9							
10							
11							
12							
13							
14							
15							
16							
17							
18							
19							
20							

Entry example

Program name: Example sequence of chapter 6: PLZ164W	
Date: _____ By: _____	
Program number (1 to 10)	1
Memo (Up to 11 characters)	Program1
Operation mode	CC
Range Current (A) -- Voltage (V)	33 (A) -- 150 (V)
Loop (1 to 9999)	0001
Last Load (OFF/ON)	OFF
Last Set	0
Chain (OFF, 1 to 10)	2

Step number	Setting (mA, mS, V, W)	Execution time (h:min:s:ms)	LOAD	RAMP	TRIG	PAUSE	Note
1	7 A	200 s	ON	ON	OFF	OFF	
2	7 A	150 s	ON	OFF	OFF	OFF	
3	0.5 A	80 s	OFF	OFF	OFF	OFF	

Program name: Example sequence of chapter 6: PLZ164W	
Date: _____ By: _____	
Program number (1 to 10)	2
Memo (Up to 11 characters)	Program2
Operation mode	CC
Range Current (A) -- Voltage (V)	33 (A) -- 150 (V)
Loop (1 to 9999)	0002
Last Load (OFF/ON)	OFF
Last Set	0
Chain (OFF, 1 to 10)	OFF

Step number	Setting (mA, mS, V, W)	Execution time (h:min:s:ms)	LOAD	RAMP	TRIG	PAUSE	Note
1	10 A	200 s	ON	ON	OFF	OFF	
2	5 A	50 s	ON	OFF	OFF	OFF	
3	8 A	150 s	ON	ON	OFF	OFF	



Index

Symbols

% key 4-10
+CV key 4-7
+CV mode 5-10, 5-13
+S end 6-38

Numerics

0 V input type 1-4, 3-6
1.5 V input type 3-6

A

A key 4-11
ABC key 4-11
ABC preset memories 6-2
AC INPUT connector 4-5
accessories 2-2, 9-8
actual operating area 3-6
air intake 4-3
air outlet 4-5
alarm input protection 5-7
ALARM is activated 8-15
alarms, clearing of 5-7
Analog external control 9-7
auto load off timer 6-13

B

B key 4-11
backup battery 8-3
basic setting entry condition 2-8

C

C key 4-11
calibration 5-28, 8-5
calibration items 8-5
calibration procedure 8-7
CC mode 3-7, 5-10, A-2
CC mode calibration 8-8
CC+CV mode 3-7, 5-11, A-10
chain 6-15
Class I equipment 2-6

closed circuit voltage 6-13
coarse adjustment 5-2
COARSE/FINE 4-6
communication function 9-7
conductance 5-13, 5-14, 5-15
configuration 5-28
constant current and constant voltage mode 3-7, A-10
constant current mode 3-7, 5-10, A-2
constant power mode 3-7, 5-18, A-6
constant resistance and constant voltage mode 3-7, A-12
Constant resistance mode 3-7
constant resistance mode 5-13, A-4
constant voltage mode 3-7, 5-16, A-8
contrast 4-6
control flat cables 1-8
control panel 1-6
count time 6-13
CP mode 3-7, 5-18, A-6
CR mode 3-7, 5-13, A-4
CR+CV mode 3-7, 5-15, A-12
current monitor output 6-60
current value 3-10
CURSOR key 4-6
cut off 5-28
cut off time 6-13
cutoff voltage 6-13
CV mode 3-7, 5-16, A-8
CV mode calibration 8-11

D

DATA1 6-28
DATA2 6-28
DC INPUT 4-3, 4-5
default settings 5-29
dimensions 9-10
DIRECT 6-3
display 4-12
display contrast, adjustment of 2-9
dust filter 8-2
duty cycle 6-10

E

Earth 2-6
EDIT key 4-11
elapsed time display 4-12
electronic load, definition of 3-2
ENTER key 4-11
EXT CONT 4-5
external 5-28
external communication interface 1-6
external control 6-39

F

fast sequence 6-14, 6-27
FILL function 6-28, 6-35
fine adjustment 5-2
firmware version 1-2
FREQ/DUTY key 4-9
Front panel BNC connector 9-7
function 5-28

G

gain 8-5
GPIB connector 4-5
GPIB control 7-3
grounding 2-6

H

h.min.s.ms 6-16
handle 4-3

I

IMON OUT connector 4-3
initial drift 8-6
initialization 5-29
input voltage range 2-5
inrush current 9-8
installation location 2-3
interface 5-28
interface setup 7-3
inverse proportional control 6-47, 6-51, 6-53, 6-55

J

J1 connector pin arrangement 6-42
J1/J2 connector 4-5, 6-40
J2 connector pin arrangement 6-43

K

key icon 5-23

L

large capacity, support for 1-7
last load 6-15
last set 6-15
LEVEL key 4-10
LIMIT 3-8
LOAD 6-16
load input terminal on the front panel 2-17
load input terminal on the rear panel 2-15
LOAD key 4-6
LOAD OFF 3-8
load off 3-9
load on 3-9
load wire inductance 2-11
load, turning on or off of 5-3
LOCAL key 4-7
lock function 5-23
LOCK key 4-7
lock plate 2-14
loop 6-15
louver 4-3
louver, removal of 8-2

M

M1,2,3,4,5,6,7,8 6-30
malfunctions and causes 8-14
master/slave 5-28
measured value display 4-12
memo 6-15
memory 5-28
memory, recalling of 6-8
memory, saving to 6-7
Menu 5-26
MENU key 4-8
menu setup 5-26

mode 6-15
MODE key 4-7
model info 5-28
multi display 4-12

N

No. 6-15
normal sequence 6-14

O

OCP 5-6
offset 8-5
OHP 5-7
operating area 3-6, A-1
operating area of each model A-15
operating humidity range 2-3, 9-8
operating temperature range 2-3, 9-8
operation mode display 4-12
operation modes 5-9
operation modes, transition of 5-9
operation status display 4-12
OPP 3-8, 5-6
OPP/OCP key 4-9
oscillation 2-13
overcurrent protection 5-6
overhaul 8-3
overheat protection 5-7
overpower protection 3-8, 5-6
overvoltage 2-13
overvoltage category II 2-5
overvoltage protection 5-6
OVP 5-6

P

panel control basics 5-2
parallel operation using load boosters 6-62, 6-65
parallel operation using the same model 6-62
PAUSE 6-16, 6-17
PAUSE key 4-11
polarity 2-13
pop-up menu 3-5, 5-2
power consumption 9-8
power cycle 3-3

power on 5-28
power supply 2-5
power supply, connection to 2-5
POWER switch 4-3
preset memory, recalling of 6-3
preset memory, saving to 6-3
product version 1-2
program 6-15
program 11 6-27
program number 6-15
program, creation of 6-22, 6-32
proportional control 6-47, 6-51, 6-53, 6-55
protect action 3-8, 5-28
protection functions 9-6

R

rack adapter 1-9
rack mount bracket 1-9
rack mounting 1-9
RAMP 6-16
RAMP (current transition) 6-16
range 6-15
range display 4-12
RANGE key 4-8
RECALL key 4-10
REMOTE connector 4-3
remote sensing 6-38
remote sensing terminal 4-5
response 5-28, 5-30
response speed 5-30
REV 5-7
reverse connection protection 5-7
ROM version 1-2
rotary knob 4-6, 5-2
RPTSTEP 6-27
RS-232C connector 4-5
RS-232C control 7-4
RUN/STOP key 4-11

S

-S end 6-38
SAFETY 6-3
sequence editing 6-18, 6-29
sequence example 6-21, 6-31

sequence, executing of 6-36
sequence, reediting of 6-26
SET/VSET key 4-8
settings, monitoring of 6-35
setup 5-28
setup display 4-12
setup memory 6-6
SHIFT key 3-5, 4-7, 5-2
short function 5-25
short icon 5-25
SHORT key 4-8
slew rate 6-12
SLEW RATE key 4-8
soft start 5-20
START 6-28
status display 4-12
step 6-15, 6-16
step, deletion of 6-26
step, insertion of 6-26
STOP 6-28
storage humidity range 2-3, 9-8
storage temperature range 2-3, 9-8
STORE key 4-10
SW ON key 4-9
switching function 6-10

T

terminal cover 2-14
Th/TL key 4-9
TIME BASE 6-27
time measurement 6-13
TRIG 6-16
TRIG (trigger output) 6-17
TRIG OUT connector 4-3
trigger signal output 6-60

U

undervoltage protection 5-7
USB connector 4-5
USB control 7-6
UVP 5-7
UVP key 4-9

V

ventilation, poor 2-3
version 1-2
voltage drop in the load wire 3-4
voltage measurement 6-13
voltage range 3-10
VRANGE key 4-8

W

warm-up 3-4, 8-6
weight 9-8

KIKUSUI ELECTRONICS CORP.

1-1-3 Higashiyamata, Tsuzuki-ku, Yokohama,
224-0023, Japan
Tel: +81-45-593-7570 Fax: +81-45-593-7571



Website

<http://www.kikusui.co.jp/en>