



## **Multi-functional Electronic Load PLZ-4WH Series**

Maximum operating voltage: 650 V

165 W, 330 W, 1000 W: 3 types

With connecting boosters (1000 W type exclusive), maximum of 9 kW/450 A

Operating mode for constant current, constant resistance, constant voltage, constant power, constant current + constant voltage, and constant resistance + constant voltage

Sequence function (up to 1024 steps)

Voltage monitor terminal for monitoring high voltage

Equipped as standard with USB 2.0, GPIB, and RS232C

# High-Voltage Electronic Load 650 V

## All new design with upgraded performance!

**For EV and HEV high-voltage converters.  
With the booster, extended capacity at  
a low cost can be realized!**

In recent years, the market trend of various devices that compose in the automotive electronics such as EV, HEV, and the new energy market for PV power generation, fuel cells, secondary batteries have been moved to higher voltage and larger capacities. At the same time, it has increased the demand for the Electronic Load evaluation equipment to meet these new requirement. The PLZ-4WH Series continues to provide excellent operability of the conventional model (PLZ-4W Series) while extending the maximum operating voltage to 650 V. Furthermore, when a booster unit (PLZ2004WHB) is connected, up to 9 kW/450 A can be realized with less space and at a low cost. The interface, USB, GPIB, and RS232C functions comes as standard and supports automated testing applications.

### Applications

EV and HEV high-voltage converter evaluation testing  
PV power generation, fuel cell, secondary batteries,  
and other evaluation testing High-voltage device  
evaluation testing

**Actual  
size**



D C E L E C T R O N I C L O A D

## Multi-functional Electronic Load

# PLZ-4WH Series

4 model

### Product line-up

Model	Operating voltage	Current	Power
PLZ164WH	5 V to 650 V	8.25 A	165 W
PLZ334WH		16.5 A	330 W
PLZ1004WH		50 A	1000 W
PLZ2004WHB		100 A	2000 W

### [Other features]

- Parallel operation function ●Communication function ●Voltage monitor output ●Current monitor output ●Adjustable slew rate ●Switching operation ●Soft start ●Elapsed time display
- Auto load-off timer ●Remote sensing ●External load on/off control input ●External range switching input ●External trigger input ●External alarm input ●Alarm status output
- Load-on status output ●Range status output ●Short signal ●External voltage control (CC, CR, CV, and CP modes) ●External resistance control (CC, CR, CV, and CP modes)
- Overvoltage protection (OVP) ●Overcurrent protection (OCP) ●Overpower protection (OPP) ●Overheat protection (OHP) ●Undervoltage protection (UVP) ●Reverse connection protection (REV)

# ACCESSIBILITY

## Reliable testing supported by ease of use

The front panel is the common design in all of PLZ-4W Series. Since operability is uniform, tests can be set up quickly and easily.

## Operating range up to 650 V

The PLZ-4WH supports input voltages of up to 650V, and it can be used to evaluate EV and HEV in-vehicle chargers, DC/DC converters, and battery cells; evaluate power supplies for high-voltage DC electric supply systems; perform PFC tests on European and other three-phase 400 V system input power supplies; and evaluate and test high-voltage parts related to such equipment. Moreover, it achieves to enlarge further operating range. (See the figure below.) It can operate from 5 V, and even if the current is more than 0.5 V and less than 5 V, it can be used with reduced current.

- Comparison with our conventional PLZ-3WH (PLZ1003WH) model

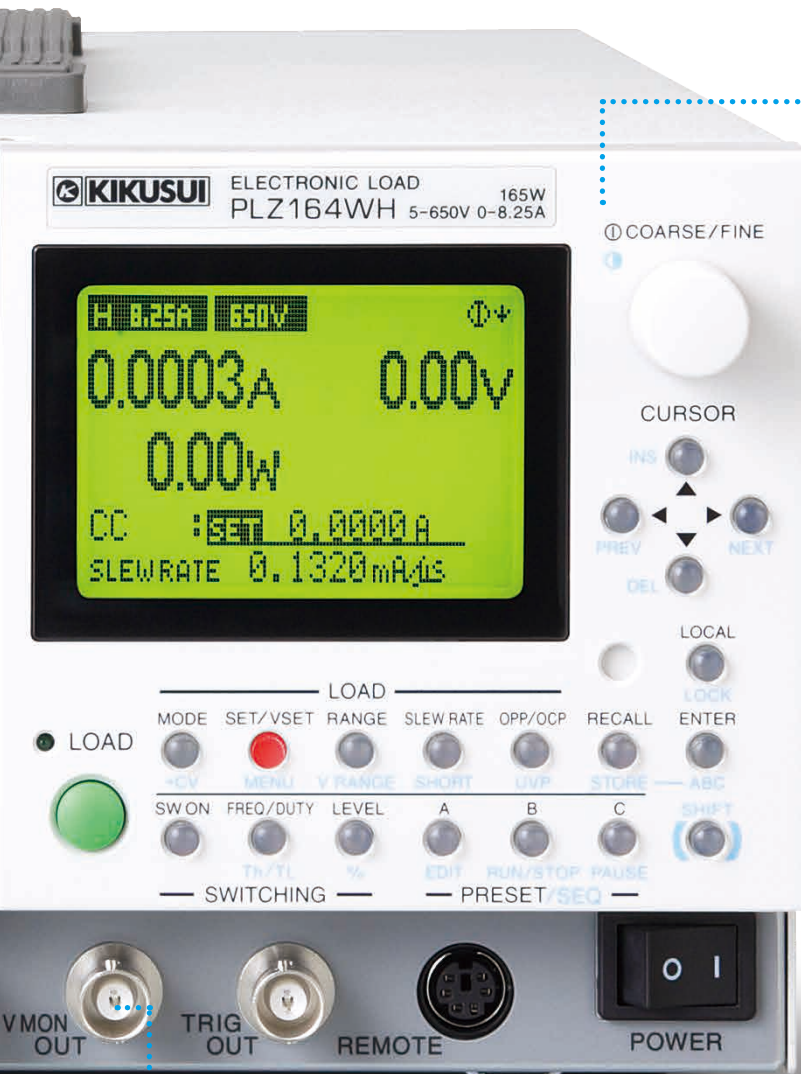
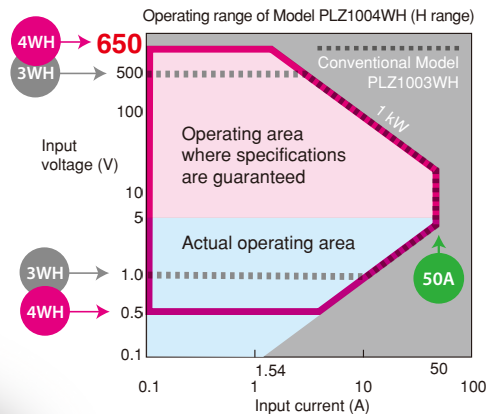

## Easy measurement of voltage and current



In addition to an insulated-type current monitor terminal, an insulated-type voltage monitor terminal has been attached to the front panel. This makes it possible to measure voltage and current simply and with confidence.

When set in 650 V range	100:1
When set in 65 V range	10:1

## Full-featured interface communication function



The unit comes equipped as standard with USB, GPIB, and RS232C functions, so it can easily be incorporated into a variety of inspection systems.



# PERFORMANCE

## Achieving up to 9 kW/450 A with less space and low cost

By connecting the maximum of four PLZ2004WHB boosters (sold separately) to the PLZ1004WH, it is possible to use the product as an Electronic Load unit for up to 9 kW/450 A. Compared to parallel operation of the same model, size (space) reductions of up to about 30 %, can be achieved. Incidentally, optional PC01-PLZ-4W and PC02-PLZ-4W parallel operation cables will be required for connections depend on the number of units to be connected.

### Boosters PLZ2004WHB



\*Exclusively used for Model PLZ1004WH.  
It can not be used to connect any other model.



●Example combination  
3 kW system consisting of PLZ1004WH (top)  
and PLZ2004WHB booster (bottom)

### ● In comparison of the conventional model for the maximum 9 kW system

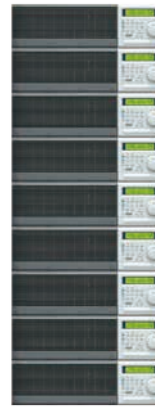

Conventional Model  
PLZ-3WH Series  
PLZ1003WH×9



Approx.  
**30%**  
of reduced  
volume



PLZ-4WH Series  
PLZ1004WH+PLZ2004WHB×4

### ●Parallel operating units and capacity (maximum current and power)

Slave Unit	1 Unit	2 Units	3 Units	4 Units
PLZ2004WHB	150 A 3000 W	250 A 5000 W	350 A 7000 W	450 A 9000 W

## Capable of parallel operation with up to five units of the same model

Parallel operation without the use of boosters is also possible up to five units of the same model, including the master unit, can be connected in parallel (5 kW/250 A maximum). In this case, the system operates under the master-slave configuration, and the master unit controls and displays the entire system. Note that optional PC01-PLZ-4W parallel operation cables will be required for connections depend on the number of units to be connected.

### ●Parallel operating units and capacity (maximum current and power)

Slave Unit	1 Unit	2 Units	3 Units	4 Units
PLZ164WH	16.5 A 330 W	24.75 A 495 W	33 A 660 W	41.25 A 825 W
PLZ334WH	33 A 660 W	49.5 A 990 W	66 A 1320 W	82.5 A 1650 W
PLZ1004WH	100 A 2000 W	150 A 3000 W	200 A 4000 W	250 A 5000 W

\*The constant current mode setting accuracy and current measurement accuracy can be set to the same accuracy as that of the main unit by calibrating in parallel operation.

### ●Basic connection diagram

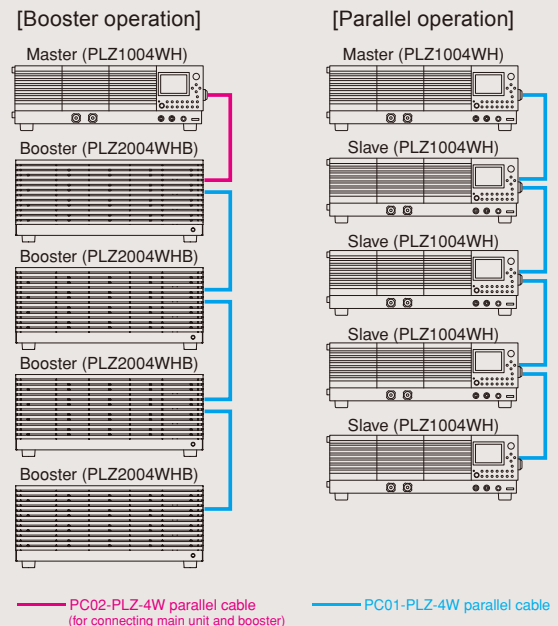

★ Large capacity systems (9kW and above), rack systems and so on is also able to be supported. For details, please contact us.

# PERFORMANCE

## Low range (1/100) feature

In CC, CR, and CP modes, three ranges are available: H, M, and L. The L range is 1/100, enabling coverage from low to high power with a single unit.

### ●Current setting resolution

	PLZ164WH	PLZ334WH	PLZ1004WH
H	300 $\mu$ A	1 mA	2 mA
M	30 $\mu$ A	100 $\mu$ A	200 $\mu$ A
L	3 $\mu$ A	10 $\mu$ A	20 $\mu$ A

## Ability to switch between a wide range of response speeds

The PLZ-4WH detects input current and voltage, and it operates by negative feedback control of those values. It secures and maintains stable operation by enabling the user to select the optimum speed of response by setting the negative feedback control response as shown below to counter operational instability that occurs in connection with the response characteristics of the test object, length of the load wiring, or size of the loop, for instance.

### CC, CR modes (4 stages)

- 1/1: Normal response speed
- 1/2: Half the normal speed
- 1/5: One-fifth the normal speed
- 1/10: One-tenth the normal speed

### CV mode (5 stages)

- 100: 100 times the normal speed
- 10: 10 times the normal speed
- 1/1: Normal response speed
- 1/10: One-tenth the normal speed
- 1/100: One-hundredth the normal speed

## Support for six operation modes

The PLZ-4WH is equipped with six operation modes: constant current, constant resistance, constant voltage, constant power, constant current + constant voltage, and constant resistance + constant voltage modes.

### Equivalent circuits and operation in each mode

#### ●Constant current mode(CC)

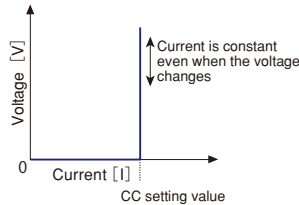
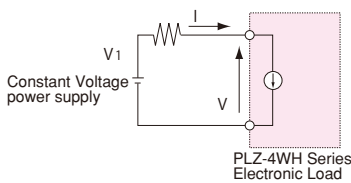

#### ●Constant power mode(CP)

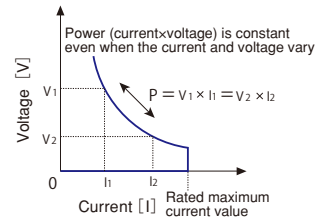
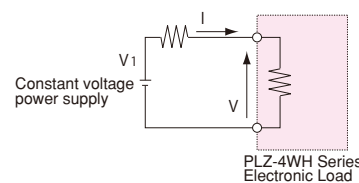

#### ●Constant resistance mode(CR)

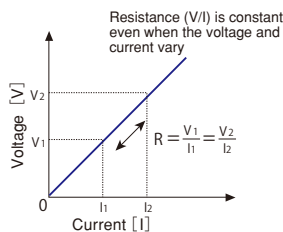
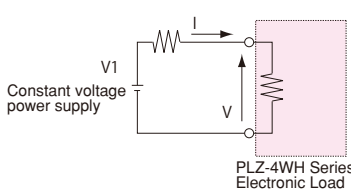

#### ●Constant current+constant voltage mode(CC+CV)

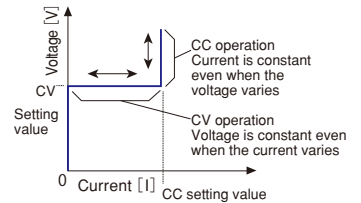
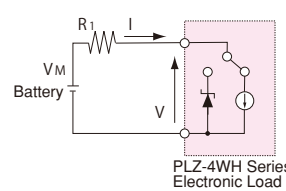

#### ●Constant voltage mode(CV)

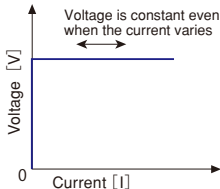
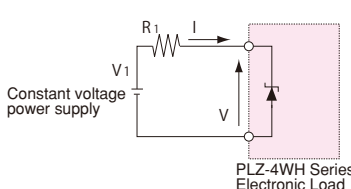

#### ●Constant resistance+constant voltage mode(CR+CV)

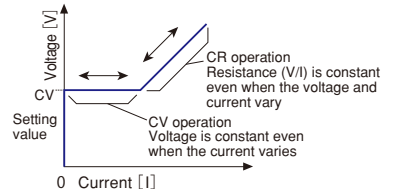
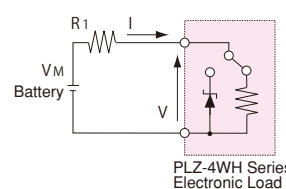

# FUNCTIONS

## Load-on/off operations

### ▶ Adopting the Load-on/off functions that flexibly apply to the system

With load-on/off operations, the following items can be selected in addition to standard operations:

- Start-up with load-on status when the power is turned on
- Display the elapsed time of the load-on period
- Load-off after a certain time has elapsed
- Load-on/off by the relay or other external signal

## Remote sensing function

### ▶ Compensating the voltage drop of the wiring

Connecting a sensing terminal to the DUT makes it possible to set the combined resistance, including even the resistance of the wiring, from the panel in constant resistance mode. Also, points that connect the sensing function can be set to a certain power and certain voltage in constant power mode and constant voltage mode. Furthermore, since transient characteristics are improved in these constant voltage, constant power, and constant resistance modes, it also leads to operational stability. (Voltage that can be compensated: 2 V one way)

## Switching function

### ▶ Transient response test conditions are also freely changeable on the spot

In constant current mode and constant resistance mode, switching operations of up to 4 kHz are possible with the built-in oscillator. Also, the level, frequency, duty cycle (ratio), and other configuration parameters can be changed even during a load-on period.

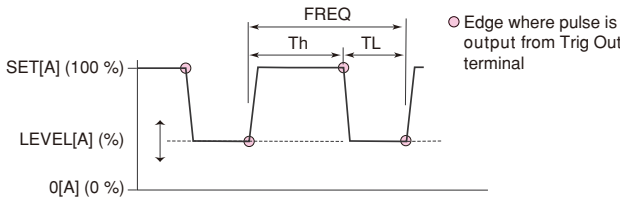

#### [Configuration parameters]

- Operation modes: CC and CR
  - Duty cycle settings: 5 % to 95 %, in 0.1 % steps
  - Frequency setting range: 1 Hz to 4 kHz
  - Frequency setting resolution:
    - 0.1 Hz at 1 Hz to 10 Hz
    - 1 Hz at 10 Hz to 100 Hz
    - 10 Hz at 100 Hz to 1 kHz
    - 100 Hz at 1 kHz to 4 kHz
  - Frequency setting accuracy:  $\pm 0.5$  % of set
- \*The minimum duration for a duty cycle is 50  $\mu$ s.

## Soft start function

### ▶ Assures even with steep voltage application

In constant current mode, the product can prevent the generation of overcurrent\* even when voltage is steeply applied from the DUT in "Load On condition and with the current having been set." For example, in a battery discharge test, it can suppress the generation of overcurrent when for some reason voltage is suddenly applied to an Electronic Load used for discharge.

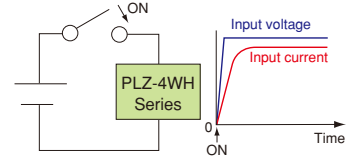

\*There is electrostatic capacitance between the Electronic Load input terminals. Charging and discharging current flows to this capacitance.

### ▶ Ability to start up the power in CC mode

In many cases during constant voltage power supply tests, testing is conducted in constant resistance mode for start-up time measurements (during start-up), and in constant current mode during load change tests. If, however, the soft start time is set to a time corresponding to the start-up time of the constant voltage power supply, it is possible to perform start-up time measurements and load change tests in constant current mode, without changing the operation mode. (Either 1, 2, 5, 10, 20, 50, 100, or 200 ms can be selected as the soft start time.)

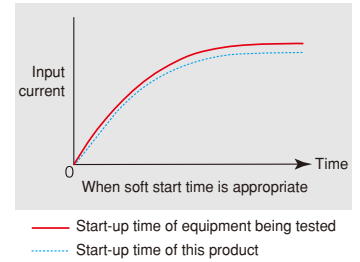

## Short function

### ▶ Improved efficiency for the current limit evaluation with a single action

In tests such as the DC power supply "fold-back type drooping characteristics test of current limiting characteristics," the maximum current (in constant current mode) or the minimum resistance (in constant resistance mode) can be set with a single action and thus increase work efficiency. At the same time, since contact signals are output to an EXT CONT connector, it is possible to achieve even lower impedance shorting by driving exterior relays and shorting the output of the tested device.

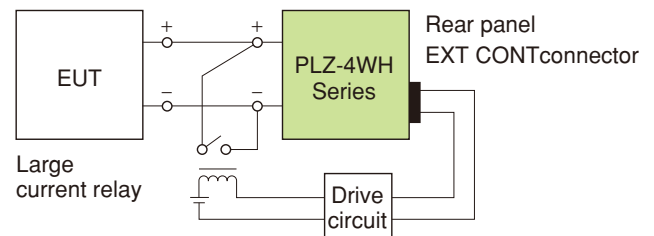

# FUNCTIONS

## Sequence function

### ▶ Actual load simulation by programming current waveforms internally

Arbitrarily set sequence patterns can be saved in the built-in memory and executed. Ten normal sequence programs and one fast sequence program can be saved. Although sequence editing and execution can be performed from the panel, those tasks can also be performed easily by using the application software separately sold "Wavy" sequence creation software.

\*A personal computer will require one of the following interfaces: USB, RS232C, or GPIB.

#### ■ Normal sequence

The execution time and Load ON/OFF can be set for each step. The level can be changed not only in a stepped form but also in a ramped form. It is also possible to cancel pausing both by using the PAUSE function and by external trigger input, and to synchronize with trigger output and other external equipment.

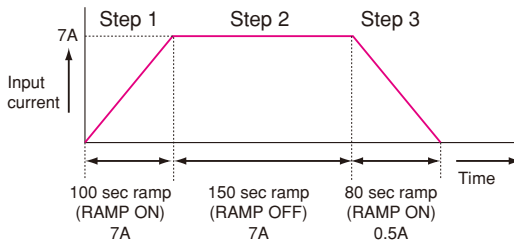

#### ■ Fast sequence

Each step is executed at high speed. Since the time resolution is high, fast simulation is possible. The execution time, level, and trigger output can be set.

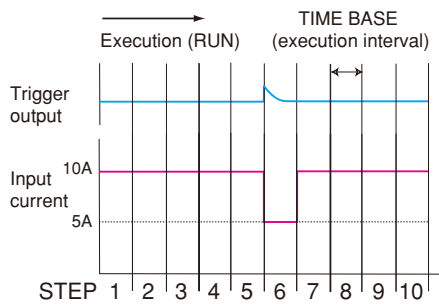

#### ● Sequence configuration parameters

	Normal Sequence	Fast Sequence
Operation mode	CC, CR, CV, CP	CC, CR
Maximum steps	256	1024
Step execution time	1 ms to 999 h 59 min	100 μs to 100 ms
Time resolution (setting range)	1 ms (1 ms to 1 min) 100 ms (1 min to 1 h) 1 s (1 h to 10 h) 10 s (10 h to 100 h) 1 min (100 h to 999 h 59 min)	100 μs

## Elapsed time display and automatic load-off timer

### ▶ Convenient battery discharge function

By combining four functions, namely, the elapsed time display, undervoltage protection (UVP), load-off voltage display, and automatic load-off timer, it is possible to perform two tests that are convenient for battery discharge



▲ Example of load-off voltage display

testing, namely, the "measurement of time from discharge start to the final voltage" and "measurement from discharge start to the closed circuit voltage after a certain time has elapsed."

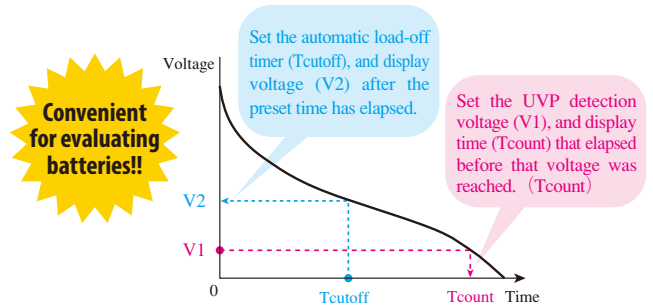

## ABC preset memory

### ▶ Instantaneous retrieval of settings

Settings can be saved in three memories (A, B, and C) that are available for each range of each mode. Saved settings can be freely retrieved and saved even during load-on periods. In constant current + constant voltage mode and constant resistance + constant voltage mode, the memories for the constant current and constant voltage, and for the constant resistance and constant voltage, can be retrieved and saved.

## Protective functions and other features

Overcurrent protection (OCP), overpower protection (OPP), overvoltage protection (OVP), undervoltage protection (UVP), overheat protection (OHP), reverse connection protection (REV), external alarm input detection, configuration setting, and setup memories (100)

# APPLICATIONS

## Evaluation Test on EV/HEV internal chargers and DC/DC converters

### ● Built-in charger characteristics test and battery simulation

By connecting a DC Electronic Load unit and high-voltage DC power supply in parallel, the PLZ-4WH is used as a simulated battery for an EV in-vehicle charger. Start-up tests and load change tests are performed in Electronic Load CV mode.

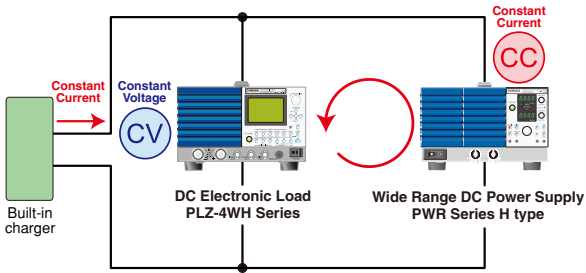

### ● Use as a high-speed constant-current power supply

The unit can be used as a high-speed constant-current power source by controlling high-speed positive current at A and negative current at B. A simulation of the regenerative current of brushless motor with regards to the interactive converter is performed.

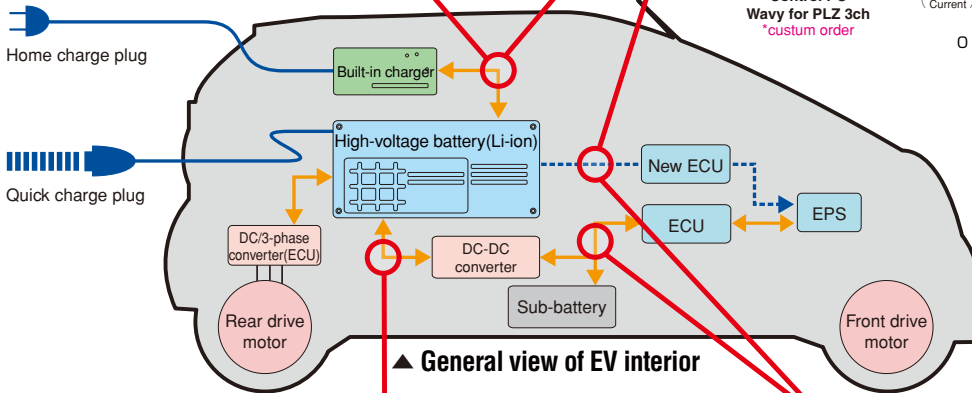
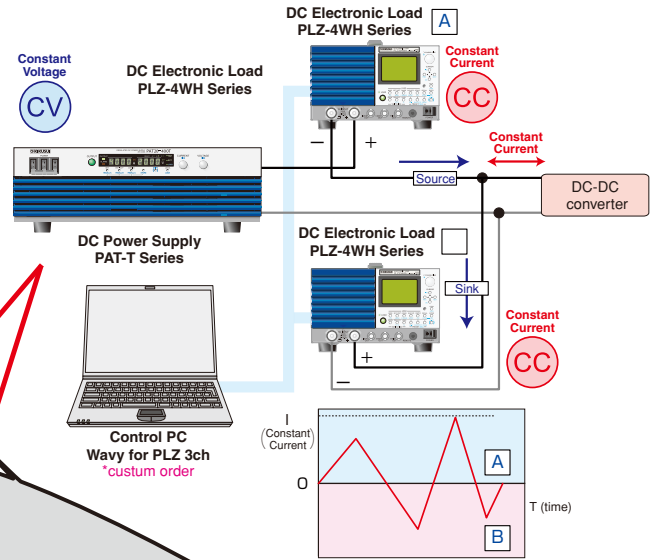

▲ General view of EV interior

### ● For power supply variation tests

By connecting a DC Electronic Load unit and high-voltage DC power supply in parallel, the PLZ-4WH is used as a simulated battery to simulate medium speed power supply variations. Variation waveforms can be created and executed with Wavy sequence creation software.

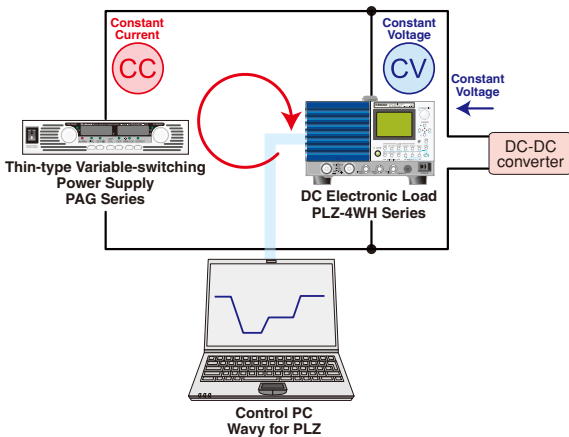

### ● For motor surge absorption measurement

During a brushless motor performance evaluation, the regenerative current from the brushless motor is absorbed, protecting the power supply and ECU.

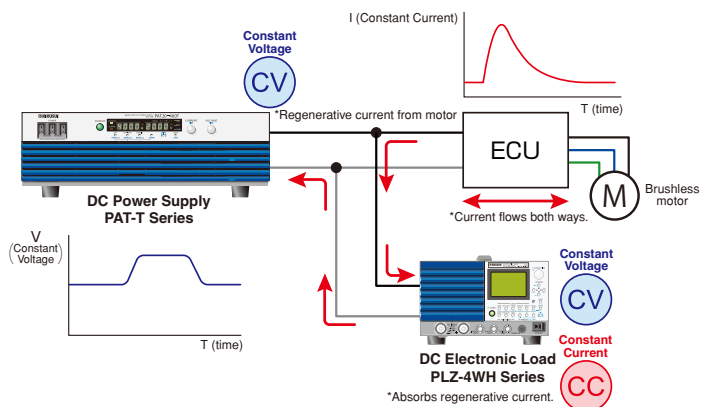

★ Select a PLZ-4W, 4WL, or 4WA Series unit according to the purpose of use. See the series lineup at the end of this catalogue.



# APPLICATIONS

## For evaluation test on parts

### ●For life performance acceleration tests

The PLZ-4WH can be used not only for temperature rise tests, long-term durability tests, pulse interrupt characteristics tests, and other high-accuracy constant current tests but also for pulse current evaluations.

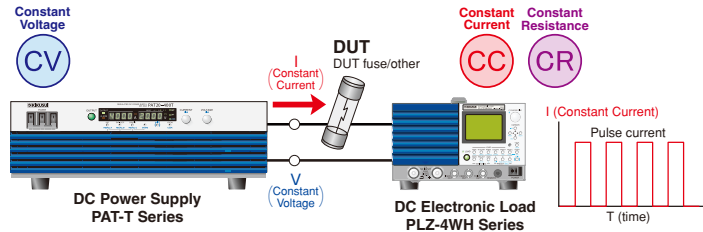

### ●As high-accuracy constant current power supply

By connecting a constant voltage power supply and a DC Electronic Load unit in series, the product achieves constant current at the DC Electronic Load unit's constant current accuracy.

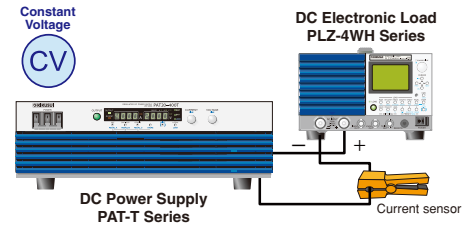

## For evaluation test on secondary batteries

### ●For battery charge-discharge tests

The PLZ-4WH can be used to evaluate impedance and residual capacity by discharging electricity not only at a normal constant current but also at a pulse current corresponding to the actual load. Waveform patterns can be created with Wavy for PLZ, too.

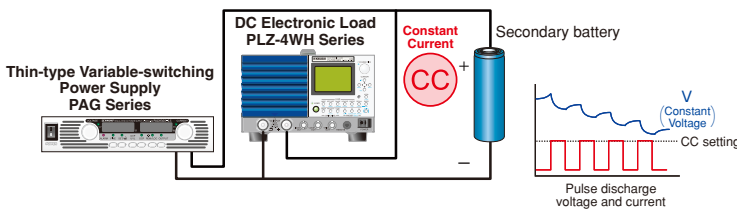

### ●Battery capacitor

During a secondary cell performance evaluation, it is necessary to perform a capacity test based on the battery's rating. Using the Electronic Load unit's +CV function, a capacity evaluation is performed by discharging the CV when the prescribed voltage is reached.

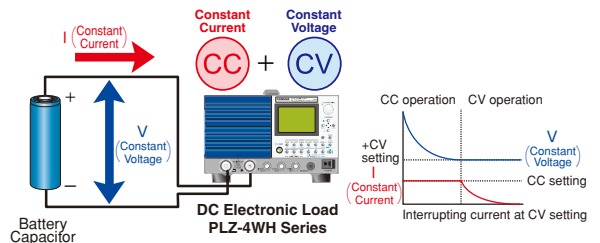

## OPTION

"Wavy" sequence creation and control software

# Wavy series



## Download !

### A Wavy trial version is available!

You can try it out for three weeks without functional limitations.  
<http://www.kikusui.co.jp/en/download/index.html>

This is software that further enhances the waveform generation and sequence functions of the PLZ-4WH Series. Using a mouse, it is possible to create and edit with the sensation of using a spreadsheet and drawing.

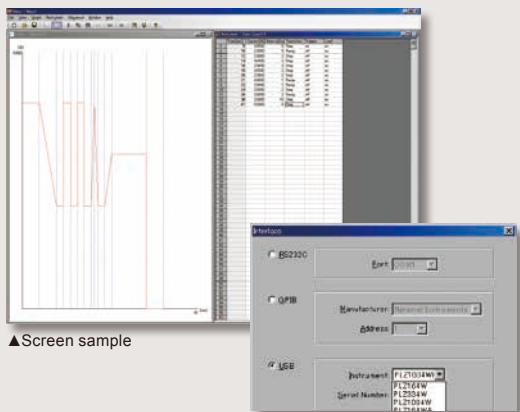

▲Screen sample

### ■ Sequence creation software Wavy for PLZ-4W

Operating environment : Windows 7/Windows 8  
 \*See our home page for details.

- Creating and editing data of test conditions required so that the sequence operation can be done easily.
- Using the save function for data files of test conditions makes routine test condition control easy.
- The progress of executed sequences is displayed by the cursor and settings on an "execution graph."
- It is possible to observe actual output intuitively, using a "monitor graph" that plots monitored values while an execution is in progress.
- Acquired monitor data can be saved as test results.
- A "waveform image" window was newly added, making it easy to see the waveforms of alternating current (AC) signals.
- Arbitrary new waveforms can be easily created and edited. Also, arbitrary waveforms that are created can be quickly written and output.
- The product supports the selection and nonselection of sequence step items. Functions such as the pause function, trigger function, and AC waveform can be selected as needed.

## PLZ164WH / PLZ334WH / PLZ1004WH specifications

Ratings			
Model	PLZ164WH	PLZ334WH	PLZ1004WH
Operating voltage (DC) *1	5 V to 650 V		
Current	8.25 A	16.5 A	50 A
Power	165 W	330 W	1000 W
Input resistance when the load is off	Approx. 2.21 MΩ *2		

\*1 The minimum operating voltage at which current begins to flow through the PLZ-4WH is approximately 50 mV. At the load input terminals on the rear panel.

\*2 Approx. 2.21/(the number of units) MΩ during parallel operation of units of the same model.

Constant current (CC) mode				
Model	PLZ164WH	PLZ334WH	PLZ1004WH	
Operating range	H range	0 A to 8.25 A	0 A to 16.5 A	0 A to 50 A
	M range	0 A to 825 mA	0 A to 1.65 A	0 A to 5 A
	L range	0 A to 82.5 mA	0 A to 165 mA	0 A to 500 mA
Setting range	H range	0 A to 8.6625 A	0 A to 17.325 A	0 A to 52.5 A
	M range	0 A to 866.25 mA	0 A to 1.7325 A	0 A to 5.25 A
	L range	0 A to 86.625 mA	0 A to 173.25 mA	0 A to 525 mA
Resolution	H range	300 μA	1 mA	2 mA
	M range	30 μA	100 μA	200 μA
	L range	3 μA	10 μA	20 μA
Setting accuracy	L, M range	±(0.2 % of set + 0.1 % of f.s) *1		
	L range, 300 μA or more	±(0.2 % of set + 0.1 % of f.s)		
	L range, less than 300 μA	±(0.2 % of set + 0.1 % of f.s) + Vin *2 / 2.21 MΩ		
	Parallel operation	±(0.2 % of set + 1.1 % of f.s) *1		
Input voltage variation *3	H, M range	20 mA		
	L range	2 mA		
Ripple	rms *4	2 mA	4 mA	12 mA
	p-p *5	20 mA	40 mA	120 mA

\*1 The full scale of the range. However, for the M range, it is the full scale of the H range.

\*2 Vin: The voltage at the load input terminals on the rear panel or sensing terminals

\*3 When the input voltage is changed from 5 V to 650 V at a current equal to the rated power/650 V.

\*4 Measurement frequency bandwidth: 10 Hz to 1 MHz

\*5 Measurement frequency bandwidth: 10 Hz to 20 MHz

Constant resistance (CR) mode				
Model	PLZ164WH	PLZ334WH	PLZ1004WH	
Operating range *1	H range	1.65 S to 30 μS	3.3 S to 60 μS	10 S to 200 μS
		(606.06 mΩ to 33.333 kΩ)	(303.03 mΩ to 16.666 kΩ)	(100 mΩ to 5 kΩ)
	M range	165 mS to 3 μS	330 mS to 6 μS	1 S to 20 μS
		(6.06 Ω to 333.333 kΩ)	(3.03 mΩ to 166.666 kΩ)	(1 Ω to 49.999 kΩ)
	L range	16.5 mS to 0.3 μS	33 mS to 0.6 μS	100 mS to 2 μS
		(60.606 Ω to 3.333 MΩ)	(30.303 Ω to 1.666 MΩ)	(10 Ω to 500 kΩ)
Setting range	H range	1.7325 S to 0 S	3.465 S to 0 S	10.5 S to 0 S
		(577.2 mΩ to OPEN)	(288.6 mΩ to OPEN)	(95.23 mΩ to OPEN)
	M range	173.25 mS to 0 S	346.5 mS to 0 S	1.05 S to 0 S
		(5.772 Ω to OPEN)	(2.886 Ω to OPEN)	(952.3 mΩ to OPEN)
	L range	17.325 mS to 0 S	34.65 mS to 0 S	105 mS to 0 S
		(57.72 Ω to OPEN)	(28.86 Ω to OPEN)	(9.523 Ω to OPEN)
Resolution	H range	30 μS	60 μS	200 μS
	M range	3 μS	6 μS	20 μS
	L range	0.3 μS	0.6 μS	2 μS
Setting accuracy *2	H, M range	±(0.5 % of set *3 + 0.5 % of f.s) *4		
	L range	±(0.5 % of set *3 + 0.5 % of f.s) + Vin *5 / 2.21 MΩ		
	Parallel operation (typ)	±(1.2 % of set *3 + 1.1 % of f.s) *4		

\*1 Conductance [S] = Input current [A]/input voltage [V] = 1/resistance [Ω]

\*2 Converted value based on the input current at the sensing point.

\*3 set = Vin/Rset

\*4 The full scale of the range. However, for the M range, it is the full scale of the H range.

\*5 Vin: The voltage at the load input terminals on the rear panel or sensing terminals

Constant voltage (CV) mode			
Model	PLZ164WH	PLZ334WH	PLZ1004WH
Operating range	H range	5 V to 650 V	
	L range	5 V to 65 V	
Setting range	H range	0 V to 682.5 V	
	L range	0 V to 68.25 V	
Resolution	H range	20 mV	
	L range	2 mV	
Setting accuracy *1	±(0.2 % of set + 0.2 % of f.s)		
	Parallel operation (typ)	±(0.2 % of set + 0.2 % of f.s)	
Input current variation *2	65 mV		

\*1 At the sensing point during remote sensing when the input voltage is within the operating range.

\*2 At an input voltage of 0.3 V when the current changes from 10 % to 100 % of the rating (during remotesensing)

Constant power (CP) mode				
Model	PLZ164WH	PLZ334WH	PLZ1004WH	
Operating range	H range	16.5 W to 165 W	33 W to 330 W	100 W to 1000 W
	M range	1.65 W to 16.5 W	3.3 W to 33 W	10 W to 100 W
	L range	0.165 W to 1.65 W	0.33 W to 3.3 W	1 W to 10 W
Setting range	H range	0 W to 173.25 W	0 W to 346.5 W	0 W to 1050 W
	M range	0 W to 17.325 W	0 W to 34.65 W	0 W to 105 W
	L range	0 W to 1.7325 W	0 W to 3.465 W	0 W to 10.5 W
Resolution	H range	10 mW	20 mW	100 mW
	M range	1 mW	2 mW	10 mW
	L range	0.1 mW	0.2 mW	1 mW
Setting accuracy	H, M range	±(2.5 % of f.s) *1		
	L range, 0.25 W or more	±(3 % of f.s)		
	L range, Less than 0.25 W	±(3 % of f.s + Vin *2 / 2.21 MΩ)		
	Parallel Operation (TYP)	±(5 % of f.s + Vin *2 / 2.21 MΩ) at 23 °C±5 °C		

\*1 The full scale of the range. However, for the M range, it is the full scale of the H range.

\*2 Vin: The voltage at the load input terminals on the rear panel or sensing terminals

Voltmeter				
Model	PLZ164WH	PLZ334WH	PLZ1004WH	
Display	H range	0.00 V to 650.00 V		
	L range	0.000 V to 65.000 V		
Accuracy	±(0.1 % of reading + 0.1 % of f.s)			
Parallel Operation (TYP)				
Ammeter				
Model	PLZ164WH	PLZ334WH	PLZ1004WH	
Display	H, M range	0.0000 A to 8.2500 A	0.000 A to 16.500 A	0.00 A to 50.000 A
	L range	0.000 mA to 82.500 mA	0.00 mA to 165.00 mA	0.00 mA to 500.00 mA
Accuracy	±(0.2 % of reading + 0.3 % of f.s)			
Parallel Operation (TYP)				
±(1.2 % of reading + 0.3 % of f.s) *1				

\*1 The full scale of the range. However, for the M range, it is the full scale of the H range.

Wattmeter				
Model	PLZ164WH	PLZ334WH	PLZ1004WH	
Display *1	H, M range	0.00 W to 165.00 W	0.00 W to 330.00 W	0.0 W to 1000.0 W
	L range, except CP mode	0.000 W to 53.625 W	0.00 W to 107.25 W	0.00 W to 325.00 W
	L range, CP mode	0.0000 W to 1.6500 W	0.0000 W to 3.3000 W	0.0000 W to 10.000 W

\*1 Displays the product of the voltmeter reading and ammeter reading.

Switching mode			
Model	PLZ164WH	PLZ334WH	PLZ1004WH
Operating mode	CC and CR		
Duty cycle	5 % to 95 % *1 in 0.1 % steps		
Frequency range	1 Hz to 4 kHz		
Frequency resolution	1 Hz to 10 Hz	0.1 Hz	
	10 Hz to 100 Hz	1 Hz	
	100 Hz to 1 kHz	10 Hz	
	1 kHz to 4 kHz	100 Hz	
Frequency setting accuracy	±(0.5 % of set)		

\*1 The minimum time width is 50 μs. Between 1 kHz and 4 kHz, the maximum duty cycle is limited by the minimum time width.

Slew rate				
Model	PLZ164WH	PLZ334WH	PLZ1004WH	
Setting range *1	H range	0.132 mA/μs to 132 mA/μs	0.264 mA/μs to 264 mA/μs	0.8 mA/μs to 0.8 A/μs
	M range	13.2 μA/μs to 13.2 mA/μs	26.4 μA/μs to 26.4 mA/μs	80 μA/μs to 80 mA/μs
	L range	1.32 μA/μs to 1.32 mA/μs	2.64 μA/μs to 2.64 mA/μs	8 μA/μs to 8 mA/μs
Resolution (Setting range)	H range	50 μA/μs (13.2 mA/μs to 132 mA/μs)	100 μA/μs (26.4 mA/μs to 264 mA/μs)	300 μA/μs (0.08 A/μs to 0.8 A/μs)
		5 μA/μs (1.32 mA/μs to 13.2 mA/μs)	10 μA/μs (2.64 mA/μs to 26.4 mA/μs)	30 μA/μs (8 mA/μs to 80 mA/μs)
		0.5 μA/μs (0.132 mA/μs to 1.32 mA/μs)	1 μA/μs (0.264 mA/μs to 2.64 mA/μs)	3 μA/μs (0.8 mA/μs to 8 mA/μs)
		5 μA/μs (1.32 mA/μs to 13.2 mA/μs)	10 μA/μs (2.64 mA/μs to 26.4 mA/μs)	30 μA/μs (8 mA/μs to 80 mA/μs)
	M range	0.5 μA/μs (0.132 mA/μs to 1.32 mA/μs)	1 μA/μs (0.264 mA/μs to 2.64 mA/μs)	3 μA/μs (0.8 mA/μs to 8 mA/μs)
		50 nA/μs (13.2 μA/μs to 132 μA/μs)	100 nA/μs (26.4 μA/μs to 264 μA/μs)	0.3 μA/μs (80 μA/μs to 800 μA/μs)
		0.5 μA/μs (0.132 mA/μs to 1.32 mA/μs)	1 μA/μs (0.264 mA/μs to 2.64 mA/μs)	3 μA/μs (0.8 mA/μs to 8 mA/μs)
		50 μA/μs (13.2 mA/μs to 132 mA/μs)	100 μA/μs (26.4 mA/μs to 264 mA/μs)	0.3 μA/μs (80 μA/μs to 800 μA/μs)
	L range	0.5 μA/μs (0.132 mA/μs to 1.32 mA/μs)	10 nA/μs (2.64 μA/μs to 26.4 μA/μs)	30 nA/μs (8 μA/μs to 80 μA/μs)
		50 μA/μs (13.2 mA/μs to 132 mA/μs)	100 nA/μs (26.4 μA/μs to 264 μA/μs)	30 nA/μs (8 μA/μs to 80 μA/μs)
		5 nA/μs (1.32 μA/μs to 13.2 μA/μs)	10 nA/μs (2.64 μA/μs to 26.4 μA/μs)	30 nA/μs (8 μA/μs to 80 μA/μs)
		50 μA/μs (13.2 mA/μs to 132 mA/μs)	100 nA/μs (26.4 μA/μs to 264 μA/μs)	30 nA/μs (8 μA/μs to 80 μA/μs)
Setting accuracy *2	±(10 % of set + 25 μs)			

\*1 Can only be set in constant current mode. In constant resistance mode, the maximum slew rate of each range is 1/10.

\*2 The time it takes to shift from 10 % to 90 % when the current is varied from 2 % to 100 % (20 % to 100 % in the M range) of the rated current

Soft start		PLZ164WH	PLZ334WH	PLZ1004WH
Model		PLZ164WH	PLZ334WH	PLZ1004WH
Operating mode		CC mode		
Selectable times		1 ms, 2 ms, 5 ms, 10 ms, 20 ms, 50 ms, 100 ms, 200 ms *The time it takes to shift from 10 % to 90 % of the rated current		
Time accuracy		±(30 % of set +100 μs)		
Response speed				
Response speed	CC/CR mode	1/1, 1/2, 1/5, 1/10		
	CV mode	100, 10, 1, 1/10, 1/100		
Remote sensing				
Voltage that can be compensated		2 V for a single line		
Protection function				
Overvoltage protection (OVP)		Turns off the load when 110 % of the range's maximum voltage is detected.		
Overcurrent protection (OCP)		Can be set to 110 % of each range's maximum current or the values given below. The action can be set to load off or limit.		
Overpower protection (OPP)		Can be set to 110 % of each range's maximum power or 0.1 % to 110 % of the rated power. The action can be set to load off or limit.		
Overheat protection (OHP)		Turns off the load when the heat sink temperature reaches 90 °C.		
Undervoltage protection (UVP)		Turns off the load when the specified value is detected. Can be set to a value from 5 V to 650 V of OFF.		
Reverse-connection protection (REV)		Implemented through a fuse and a diode. Turns off the load when an alarm occurs.		
Sequence function				
Normal sequence	Operating modes	CC, CR, CV, and CP		
	Maximum number of steps	256		
	Step execution time	1 ms to 999 h 59 min		
	Time resolution (setting range)	1 ms for 1 ms to 1 min, 100 ms for 1 min to 1 h, 1 s for 1 h to 10 h, 10 s for 10 h to 100 h, 1 min for 100 h to 999 h 59 min		
Fast sequence	Operating mode	CC and CR		
	Maximum number of steps	1024		
	Step execution time	100 μs to 100 ms		
	Time resolution	100 μs		
Other functions				
Elapsed time display		Measures the time from load on to load off. Can be turned on and off. Measures from 1 s up to 999 h 59 min 59 s		
Auto load-off timer		Automatically turns off the load after a specified time elapses. Can be set to off or a time within the range of 1 s to 999 h 59 min 59 s.		
Analog external control (EXT CONT connector)				
Load-on/off control input		Turn on the load with a high (or low) CMOS level signal. Logic level switchable. The internal circuit is pulled up to 5 V by a 10 kΩ resistor.		
Range switch input		Switches ranges L, M, and H using a 2-bit signal.		
Trigger input		Clear the sequence operation pause with a high CMOS level signal whose duration is 10 μs or longer. The internal circuit is pulled down to common by a 100 kΩ resistor.		
External alarm input		Activate the alarm with a low CMOS level signal. The internal circuit is pulled up to 5 V by a 10 kΩ resistor.		
Alarm status output		On when OVP, OCP, OPP, OHP, or REV is activated or when an external alarm input is applied (open collector output from a photocoupler)		
Load-on status output		On when the load is on (open collector output from a photocoupler)		
Range status output		Outputs range L, M, or H using a 2-bit signal (open collector output from a photocoupler).		
Short signal output		Relay contact output (30 Vdc/1 A).		
External voltage control (CC, CR, CP, and CV mode)		External input voltages in the range of 0 V to 10 V correspond to 0 % to 100 % of the rated current (CC mode), rated power (CP mode), and rated voltage (CV mode). External input voltages in the range of 0 V to 10 V correspond to the range of resistances from the maximum resistance to the minimum resistance (CR mode).		
External resistance control (CC, CR, CP, and CV mode)		External resistances in the range of 0 Ω to 10 kΩ correspond to 0 % to 100 % or 100 % to 0 % of the rated current (CC mode), rated power (CP mode), or rated voltage (CV mode). External resistances in the range of 0 Ω to 10 kΩ correspond to the range of resistances from the maximum resistance to the minimum resistance or from the minimum resistance to the maximum resistance (CR mode).		
Current monitor output		10 V for f.s (H or L range), 1 V for f.s (M range)		
Voltage monitor output		For each range, 10 V for f.s		
Front-Panel BNC Terminal				
TRIG OUT		Transmits pulses during sequence operation and switching operation. Output impedance: 1 kΩ, Output voltage: approx. 4.5 V, Pulse width: 2 μs		
Current monitor output		10 V for f.s (H or L range), 1 V for f.s (M range), Output current: up to 5 mA		
Voltage monitor output		For each range, 6.5 V for f.s, Output current: up to 5 mA		
Communication functions				
GPIB		IEEE std. 488.1-1987SH1, AH1, T6, L4, SR1, RL1, PP0, DC1, DT1, C0, E1 Supports the SCPI and IEEE std. 488.2-1992 command sets. Sets panel functions except for the function of the power switch and reads measured values		
RS232C		D-SUB 9-pin connector (conforms to EIA-232-D) Supports the SCPI and IEEE std. 488.2-1992 command sets. Sets panel functions except for the function of the power switch and reads measured values Baud rate: 2400, 4800, 9600, 19200 bps. Data length: 8 bits, Stop bits: 1/2 bits, Parity bit: None. Flow control: Xon/Xoff		
USB		Conforms to the USB 2.0 specifications and the USBTMC-USB488 device class specifications. Standard Type B socket. Sets panel functions except for the function of the power switch and reads measured values. Communication speed 12 Mbps (Full speed)		
General specifications				
Input voltage range / input frequency range		100 Vac to 240 Vac (90 Vac to 250 Vac), single phase, continuous / 47 Hz to 63 Hz		
Power consumption		80 VAmax	90 VAmax	160 VAmax
Inrush current *1		140 Amax		
Protective conductor current		600 μA (100 Vac at 50 Hz; TYP)		
Operating temperature range/humidity range		0 °C to 40 °C (32 °F to 104 °F) / 20 %rh to 85 %rh (no condensation)		
Storage temperature range/humidity range		-20 °C to 70 °C (-4 °F to 158 °F) / 90 %rh or less (no condensation)		
Isolation voltage		±750 Vdc		
Insulation resistance	Primary to input terminal	1000 Vdc, 30 MΩ or more (ambient humidity of 70 %rh or less)		
	Primary to chassis	1000 Vdc, 30 MΩ or more (ambient humidity of 70 %rh or less)		
	Secondary to chassis	1000 Vdc, 30 MΩ or more (ambient humidity of 70 %rh or less)		
Withstand voltage	Primary to input terminal	No abnormalities at 1500 Vac for 1 minute		
	Primary to chassis	No abnormalities at 1500 Vac for 1 minute		
	Secondary to chassis	No abnormalities at 1000 Vdc for 1 minute		
Dimensions (mm)		See the outline drawing.		
Weight		Approx. 7 kg (15.4 lb.)	Approx. 8kg (17.6 lb.)	Approx. 16kg (35.3 lb.)
Battery backup		Backs up setup information		
Accessories		Power cord: 1 pc. (with plug, length: 2.4 m), Load input terminal cover: 1pc., Lock plates for load input terminal cover: 2 sets, Set of screws for the load input terminal: 2 sets, CD-R: 1pc., Operation Manual/Setup Guide: 1 pc., Quick Reference(English & Japanese): Each 1 pc.)		
Electromagnetic compatibility *2 *3		Complies with the requirements of the following directive and standards. EMC Directive 2014/30/EU EN 61326-1 (Class A*6), EN55011 (Class A*6, Group 1*7), EN 61000-3-2, EN 61000-3-3		
Safety *2		Complies with the requirements of the following directive and standards. Low Voltage Directive 2014/35/EU*3, EN 61010-1 (Class I*4, Pollution degree 2*5)		

\*1 Approx. 70 A when receiving an input of 100 Vac. \*2 Does not apply to specially ordered or modified PLZ-4WHs.

\*3 Limited to products that have the CE mark on their panels. Not be in compliance with EMC limits unless the ferritecore is attached on the cable for connection of J1 connector.

\*4 This is a Class I equipment. Be sure to ground this product's protective conductor terminal. The safety of this product is only guaranteed when the product is properly grounded.

\*5 Pollution is addition of foreign matter (solid, liquid or gaseous) that may produce a reduction of dielectric strength or surface resistivity. Pollution Degree 2 assumes that only non-conductive pollution will occur except for an occasional temporary conductivity caused by condensation.

\*6 This is a Class A equipment. This product is intended for use in an industrial environment. This product may cause interference if used in residential areas. Such use must be avoided unless the user takes special measures to reduce electromagnetic emissions to prevent interference to the reception of radio and television broadcasts.

\*7 This is a Group 1 equipment. This product does not generate and/or use intentionally radio-frequency energy, in the form of electromagnetic radiation, inductive and/or capacitive coupling, for the treatment of material or inspection/analysis purpose.

## PLZ2004WHB specifications

Ratings	
Model	PLZ2004WHB
Operating voltage	5 Vdc to 650 Vdc *1
Current	100 A
Power	2000 W
Input resistance when the load is off	2.21 MΩ *2

\*1 Minimum voltage at which the current starts flowing to the PLZ2004WHB is approx. 0.5 V. The PLZ2004WHB detects no signal at an input voltage less than or equal to approx. 0.5 V and an input current less than or equal to approx. 1 % of the range rating. If the input voltage is gradually increased from 0 V, no current will flow until 0.5 V is exceeded. Once a current greater than or equal to 1 % of the range rating starts flowing, the current can flow at voltages less than or equal to 0.5 V.

\*2 Condition in which the booster is connected to the master unit.

Constant current (CC) mode		
Operating range	H range	0 A to 100 A
	M range	0 A to 10 A
	L range	0 A to 1 A
Setting range	H range	0 A to 105 A
	M range	0 A to 10.5 A
	L range	0 A to 1.05 A
Resolution*3	H range	10 mA
	M range	1 mA
	L range	0.1 mA
Ripple*4	H,M,L range	PLZ1004WH specification x (total power capacity/1 kW) (TYP)

\*3 When one PLZ2004WHB is connected.

\*4 Condition in which the booster is connected to the master unit.

Accuracy of setting	
CC mode *5	±(1.2 % of set + 1.1 % of f.s *6)
CR mode	±(1.2 % of set + 1.1 % of f.s *6) (TYP)
CV mode	±(0.2 % of set + 0.2 % of f.s) (TYP)
CP mode	±(5 % of f.s *6) (TYP), at 23°C±5°C

Measurements	
Accuracy of voltmeter	±(0.1 % of reading + 0.1 % of f.s) (TYP)
Accuracy of ammeter	±(1.2 % of reading + 1.1 % of f.s *6) (TYP)
Wattmeter	Displays the product of the voltmeter reading and ammeter reading

\*5 Condition in which the booster is connected to the master unit.

\*6 The full scale of the range. However, for the M range, it is the full scale of the H range.

Protection function	
Overheat protection (OHP)	Turns off the load when the heat sink temperature reaches 95 °C
Reverse connection protection (REV)	Protection by fuse

\*7 Other Protection functions detect and operate with the PLZ1004W/PLZ1004WH.

## Dimensions Unit: mm (inch)

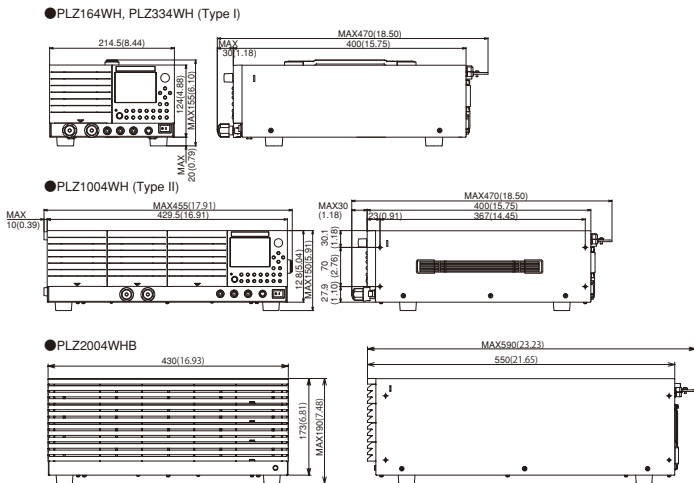

General specifications	
Model	PLZ2004WHB
Input voltage range	100 Vac to 240 Vac(90 Vac to 250 Vac) single phase, continuous
Input frequency range	47 Hz to 63 Hz
Power consumption	200 VAmax
Inrush current *8	120 A
Protective conductor current	600 μA (100 Vac at 50 Hz; TYP)
Operating temperature range	0 °C to 40 °C (32 °F to 104 °F)
Operating humidity range	20 %rh to 85 %rh (no condensation)
Storage temperature range	-25 °C to 70 °C (-13 °F to 158 °F)
Storage humidity range	Less than or equal to 90 %rh (no condensation)
Insulation resistance	Primary - input connector, Primary - chassis, Input connector - chassis 1000 Vdc, 30 MΩ or more (ambient humidity of 70 %rh or less)
Withstand voltage	Primary - input connector, Primary - chassis No abnormalities at 1500 Vac for 1 minute
Dimensions/Weight	See the outline drawing. /Approx. 24 kg (52.91 lb)
Accessories	Power cord(1 pc. (Cable length of 2.4 m)), Load input terminal cover(1 pc. (cover and two lock plates)), Screw set for th load input(2 sets (bolts, nuts, and spring washers)), Heavy object warning label(1 pc.), Operation manual(1 pc.)
Electromagnetic compatibility (EMC) *9 *10	Conforms to the requirements of the following directive and standard. EMC Directive 2014/30/EU EN 61326-1 (Class A*11), EN55011 (Class A*11, Group 1*12), EN 61000-3-2, EN 61000-3-3
Safety *9	Conforms to the requirements of the following directive and standard. Low Voltage Directive 2014/35/EU*10 EN 61010-1 (Class I*13, Pollution degree 2*14)

\*8 Approximately 70 A when 100 Vac is applied

\*9 Not applicable to custom order models.

\*10 Only on models that have CE marking on the panel.

\*11 This is a Class A equipment. This product is intended for use in an industrial environment. This product may cause interference if used in residential areas. Such use must be avoided unless the user takes special measures to reduce electromagnetic emissions to prevent interference to the reception of radio and television broadcasts.

\*12 This is a Group 1 equipment. This product does not generate and/or use intentionally radio-frequency energy, in the form of electromagnetic radiation, inductive and/or capacitive coupling, for the treatment of material or inspection/analysis purpose.

\*13 This instrument is a Class I equipment. Be sure to ground the protective conductor terminal of the instrument. The safety of the instrument is not guaranteed unless the instrument is grounded properly.

\*14 Pollution is addition of foreign matter (solid, liquid or gaseous) that may produce a reduction of dielectric strength or surface resistivity. Pollution Degree 2 assumes that only non-conductive pollution will occur except for an occasional temporary conductivity caused by condensation.

## Series Selection

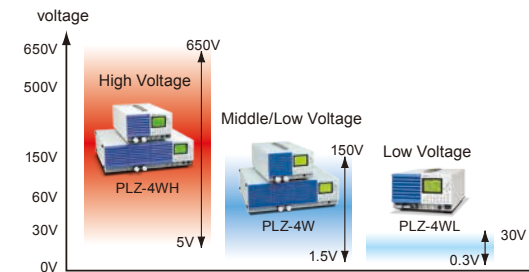

## KIKUSUI ELECTRONICS CORPORATION

Southwood 4F,6-1 Chigasaki-chuo,Tsuzuki-ku,Yokohama,224-0032,Japan  
Phone: (+81)45-482-6353, Facsimile: (+81)45-482-6261, www.kikusui.co.jp

KIKUSUI AMERICA, INC. 1-310-214-0000 [www.kikusuiamerica.com](http://www.kikusuiamerica.com)



3625 Del Amo Blvd, Suite 160, Torrance, CA 90503  
Phone: 310-214-0000 Facsimile: 310-214-0014

KIKUSUI TRADING (SHANGHAI) Co., Ltd. [www.kikusui.cn](http://www.kikusui.cn)



Room 305, Shenggao Building, No.137, Xianxia Road, Shanghai City, China  
Phone: 021-5887-9067 Facsimile: 021-5887-9069

For our local sales distributors and representatives, please refer to "sales network" of our website.

## ●Distributor/Representative

■ All products contained in this catalogue are equipment and devices that are premised on use under the supervision of qualified personnel, and are not designed or produced for home-use or use by general consumers. ■ Specifications, design and so forth are subject to change without prior notice to improve the quality. ■ Product names and prices are subject to change and production may be discontinued when necessary. ■ Product names, company names and brand names contained in this catalogue represent the respective registered trade name or trade mark. ■ Colors, textures and so forth of photographs shown in this catalogue may differ from actual products due to a limited fidelity in printing. ■ Although every effort has been made to provide the information as accurate as possible for this catalogue, certain details have unavoidably been omitted due to limitations in space. ■ If you find any misprints or errors in this catalogue, it would be appreciated if you would inform us. ■ Please contact our distributors to confirm specifications, price, accessories or anything that may be unclear when placing an order or concluding a purchasing agreement.