



2019 Catalog
All Rights Reserved

Lead in CFL and LED Test Instruments



Lead in CFL and LED Test Instruments

Lisun Group (Hong Kong) Limited

Add: Room C, 15/F Hua Chiao Commercial Center, 678 Nathan Road, Mongkok, Kowloon, Hong Kong
Tel: 00852-68852050 Fax: 00852-30785638
Email: SalesHK@Lisungroup.com

Lisun Instruments Limited

Add: 113-114, No.1 Building, Nanxiang Zhidi Industry Park, No. 1101, Huyi Road, Jiading District, Shanghai, China
Tel: +86(21)51083341 Fax: +86(21)51083342
Email: SalesSH@Lisungroup.com

Lisun Sales Rep & Show Room (India)

Add: Plot No 362 Industrial Area, Phase II, PANCHKULA, HARYANA, PIN 134112, India
Email: Sales@Lisungroup.com

Lisun Sales Rep & Show Room (Korea)

Add: 2F, 20, Guui-ro, Gwangjin-gu, Seoul, Korea
Email: Sales@Lisungroup.com



FACEBOOK



FACEBOOK



www.Lisungroup.com

www.Lisungroup.com

Email: Sales@Lisungroup.com

Company Profile

Lisun Instruments Limited was found by Lisun Group in 2003. We have sales & show room in Shanghai, Russia, USA, India and Korea. In 2012, we built a high level products show room & lab center in Shanghai. Lisun Group has set up a new manufactory in China to research and develop the world high-technology CFL & LED Test Instruments. Its quality system has been strictly certified by ISO9001:2008. The Lisun Group products have been authenticated by the third party lab and were awarded by CE certificate. As a CIE Supportive Membership, all of the test instruments produced by Lisun Group were designed according to CIE Standards.

Our main products are Goniophotometer, Spectrophotometer, Integrating Sphere, Photometer and Colorimeter, LED Test Instruments, CFL Test Instruments, EMC Testing, Electronic Ballast Tester, Equipments For Testing Electronic Components, Electrical Safety Testing, Environmental Testing, AC and DC Power Supply and etc.

Lisun Group's products have been sold to more than 150 countries and regions in Europe, America, Australia, Africa and Asia. Its quality was well accepted by many of world-famous companies such as TUV, SGS, UL, GE, Philips, Sharp, OSRAM, SONY and so on. Lisun Group wins thousands of customers' trust with motto "Right Product, Right Price and Right Service". We will continue presenting more and more high quality products to our customers in future.

- **Right Product**
- **Right Price**
- **Right Service**



Our Customers



LM-79 Mirror Goniophotometer in U.S.A

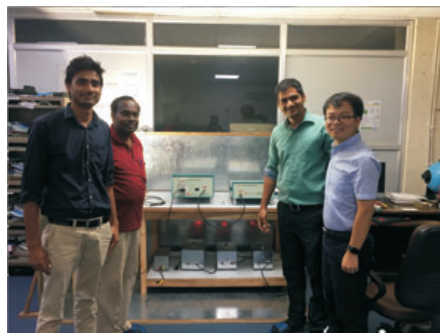

EMI and EMC Install & Training in India



LSG-1800B Goniophotometer in Germany



3m Integrating Sphere in Spain



IP Water-proof Test System in Costa Rica



Glow-Wire & Needle Flame Tester in Mexico

CONTENTS

Part 1 Goniophotometer			
LM-79 Goniophotometer System	LSG-5000, LSG-3000, LSG-2000		1
Goniophotometer for Automotive and Signal Lamps	LSG-1950, LSG-1950S		3
Near Field Moving Detector Goniophotometer	LSG-1900B		4
Rotation Luminaire Goniophotometer	LSG-1800B, LSG-1700B, LSG-1600B		5
Goniospectroradiometer	LSG-1800BCCD, LSG-1700BCCD		6
Compact Goniophotometer	LSG-1200A		7
Part 2 Spectroradiometer			
Scientific Grade CCD Spectroradiometer	LMS-9500B, LMS-9500A		8
High Precision CCD Spectroradiometer	LMS-9000B		9
CCD Spectroradiometer	LMS-7000		10
Portable CCD Spectroradiometer	LMS-6000		11
Part 3 Integrating Sphere			
Integrating Sphere with Testing Holder Base	IS-*MA		12
Integrating Sphere with Side Assistant Opening	IS-*MA**P, IS-*MA**C		13
Constant Temperature Integrating sphere	IS-*MT		14
Part 4 LED Test Instruments			
CCD Spectroradiometer Sphere Compact System	LPCE-3		15
Integrating Sphere Spectroradiometer System for LED	LPCE-2		15
Optical Radiation Safety Test System	EN62471-C		16
LED Lumen Maintenance and Aging Life Test System	LEDLM-80PL		17
Lamp Start, Run-up time and Flicker Test	LSRF-2		18
Fast Photo-Electric Tester	LS616S		18
LED Power Driver Tester	WT2080		19
LED Driver Online Tester	LEDLS-60, LEDLS-12		20
DC Electric Load	M9822, M9822B		20
Part 5 CFL Testing Instrument			
High Frequency Fluorescent Lamp Test System	HFP-800, RB-3, LPS-3		21
Adjustable Reference Ballast	DYJ-50HZ, DYJ-60HZ, DYJ-HID		22
Adjustable High Frequency Reference Ballast	HCS-109A		22
Multiplex Temperature Tester	TMP-8, TMP-16		22
Multiway Life Tester	CH316		23
Digital Torsion Meter	CH338		23
"Go" and "Not Go" Gauge	GNG-E27		24

Part 6 EMC and EMI Test System

EMI Test System	EMI-9KC, EMI-9KB, EMI-9KA	24
Magnetic Shielding Cabinet for EMI Testing	SDR-2000B, SDR-800S	24
Electrostatic Discharge Simulator	ESD61000-2	25
EFT Immunity Measurement	EFT61000-4	25
Surge Generator	SG61000-5	26
Impulse Withstand Voltage Tester	SUG255	26
Voltage Dips and Interruptions Generator	CSS61000-11	27
Magnetic Field Generator	PFM61000-8A	28
RF Conducted Immunity Test System	RFCI61000-4-6	28
Ring Wave Generator	RWG61000-12	29
Three Loop Antenna	VVLA-30M	29

Part 7 Electronic Ballast Tester

Electronic Ballast Tester	WT5000	30
HID Ballast Tester	WT2000-HID	30
Electronic Ballast Automatic Test Equipment	ATE-1	30

Part 8 Electrical Safety Test

Glow-wire Test Apparatus	ZRS-3HS, ZRS-3H	31
Needle Flame Test	ZY-3S, ZY-3	31
Horizontal Vertical Flame Tester	HVR-LSS, HVR-LS	32
Hot Wire Ignition tester	RSY-LT	32
Tracking Test Chamber	TTC-1	33
Temperature Meter for Lamp Caps & Luminaires Test	TMP-L	33
Automatic Safety Test System	LS9955, LS9956	34
Programmable Withstanding Voltage & Insulation Test	LS9923	34

Part 9 Environmental Test Chamber

High and Low Temperature & Humidity Chamber	GDJS-015A, GDJW-010A	35
Waterproof Testing Machine	JL-X	36
High Temperature & Pressure Jet Waterproof Test	JL-9K1L	37
Aging and Life Test Rack for CFL and LED	SY2036	37
Dustproof Testing Machine	SC-015	38
IK Level Tester	IK01-06, IK07-10	38
Salt Spray Test Machine	YWX/Q-010	39
Electrodynamic Vibration Generator System	LVD-100KG-6D	39
UV Lamp Aging Test Chamber	UV-263LS	40
Xenon Lamp Aging Test Chamber	XD-80LS	40
Automatic Double Drop Test Machine	DT-63KG	40

Part 10 AC and DC Power Supply

Digital CC and CV DC Power Supply	DC3005, DC3005S	41
AC power Source	LSP-500VAR, LSP-500VAS	41
PWM Type AC Power Supply	LSP-3KVA, LSP-5KVA	42
Digital Power Meter	LS2008R, LS2010, LS2012, LS2050	42

LM-79 Goniophotometer Systems (LSG-5000, LSG-3000, LSG-2000)

According to LM-79 clause 9.3.1, only there are two kinds of type C goniophotometer can be accepted: LSG-5000/LSG-3000 Moving Detector Goniophotometer and LSG-2000 Goniophotometer with Moving Mirror. The LSG-5000/LSG-3000 and LSG-2000 are automatic light distribution intensity 3D curve testing systems. The measuring distance is from 5m to 30m. It can measure all types of lighting sources, LED or HID luminaires such as indoor and outdoor luminaires, roadway luminaires, street lamps, flood lights and other kinds of luminaires.

Measurement:

Luminous Intensity Data, Luminous Intensity Distribution, Zonal Luminous Flux, Luminaires Efficiency, Luminance Distribution, Coefficient Of Utilization, Luminance Limitation Curves, Glare, Maximum Ratio of Distance to Height, Equal Illuminance Diagrams, Curves of Luminaires VS Lighting Area, Isocandela Diagrams, Efficient Luminescence Angle and so on.

Specification:

- The mirror or detector rotating the luminaires with an angle of $(\gamma) \pm 180^\circ$ (or $0 \sim 360^\circ$)
- The accuracy of angle: 0.05° , Resolution of angle: 0.001°
- Accuracy of photo detector: Constant temperature photo detector DIN5032-6/CIE pub1. No. 69 Class L
- The test result can be exported as CIE, IES, LDT and other format files. This kind of format files can be transferred by other illumination and luminaire design software such as DiaLux
- The rotation motor is from Japan MITSUBISHI SERVO MOTORS and it uses Germanic Angle decode system; It will help rotation smoothly and with high accuracy. It is very stable when start and stop.
- The LSG-5000/LSG-3000 completely meets the LM-80, LM-79, LM-75, GB, EN and CIE121-1996.
- Connect to PC via USB, English version software can be run in Win7, Win8 or Win10
- It can be an option working with a USB CCD Spectroradiometer to test spatial CCT Distribution and other Spectral color parameters. We call this system as Goniospectroradiometer

Model Number	LSG-5000B/LSG-2000B (Big Size)	LSG-5000/LSG-2000 (Standard Size)	LSG-5000S/LSG-3000B LSG-2000S(Small Size)
Measure Non-Flood Lamp	Φ 1600*800mm, 50kg	Φ 1400*500mm, 40kg	Φ 1000*460mm, 30kg
Measure Flood Lamp	600*600mm, 50kg	600*600mm, 40kg	400*400mm, 30kg
Measure Power(W)	600V/10A, AC/DC	600V/10A, AC/DC	600V/10A, AC/DC

LSG-3000 is the cost-effective version of Moving Detector Goniophotometer

Test Report:

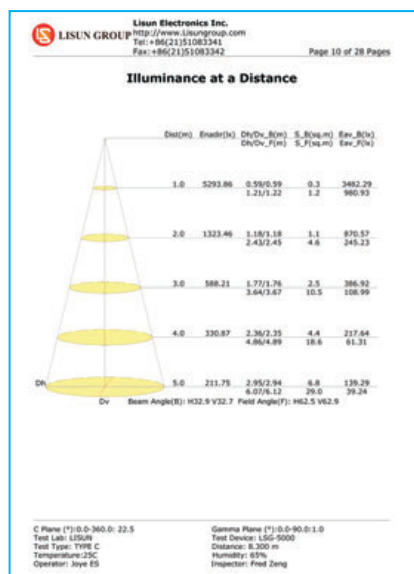
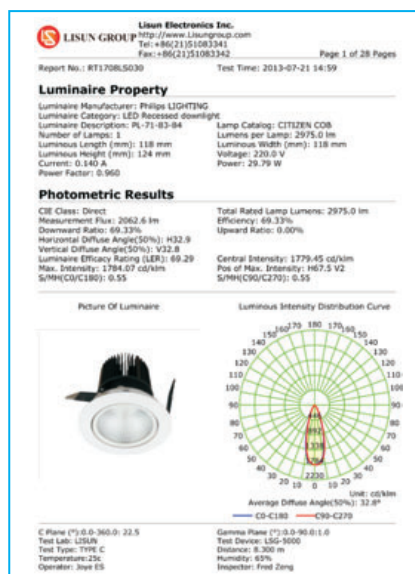

Test Principle:

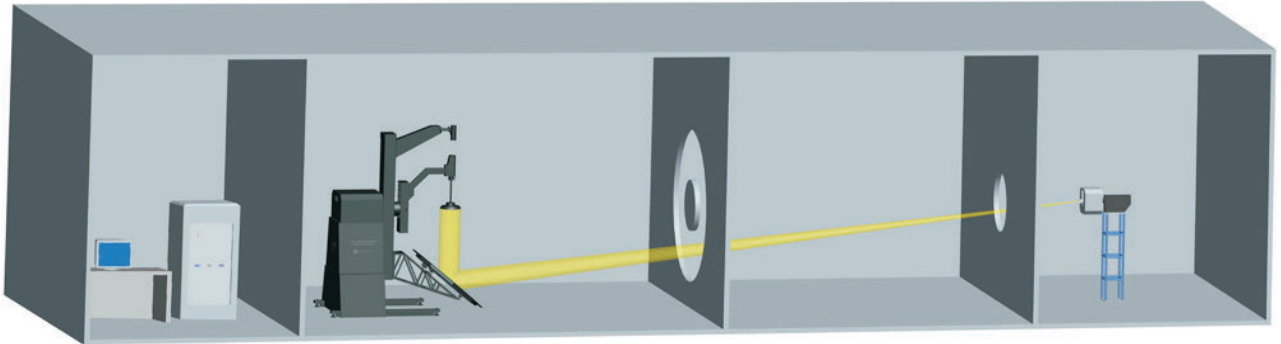
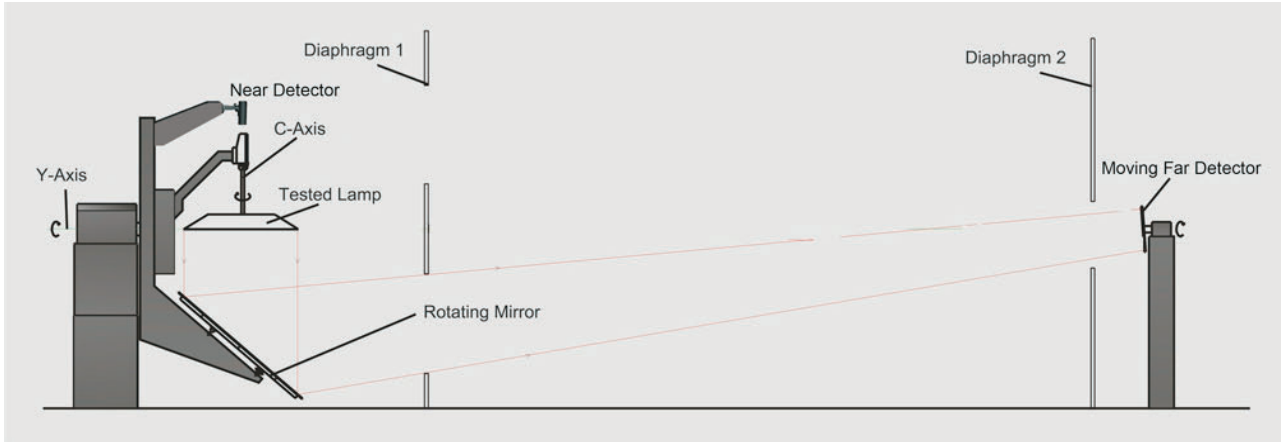

LSG-5000/LSG-3000 Moving Detector Goniophotometer

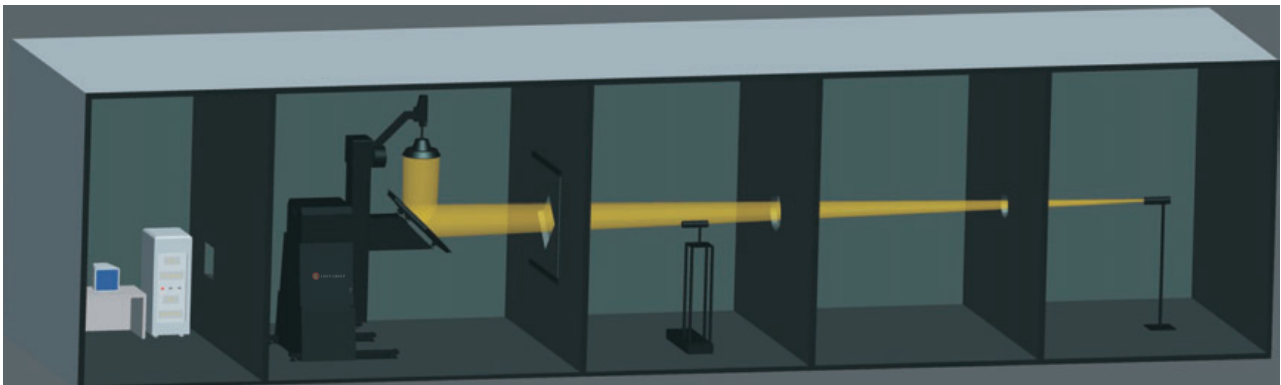
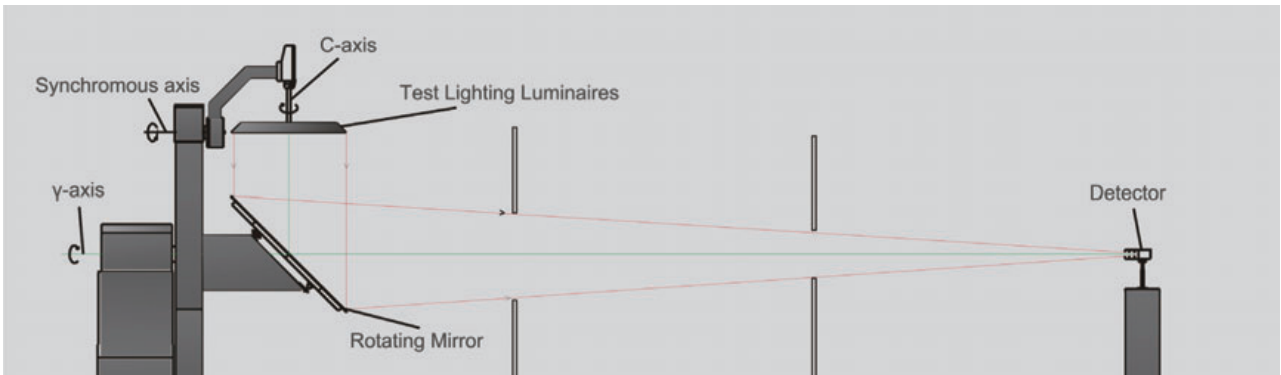

LSG-2000 Goniophotometer with Rotating Mirror

Goniophotometer for Automotive and Signal Lamps (LSG-1950, LSG-1950S)

Measurement:

LSG-1950/LSG 1950S is the CIE A-a Goniophotometer which used to test automotive lighting industry, traffic signal, bus, train, ship, and aircraft lighting. The photometer head keeps static and face to the test sample while the test sample rotates around both horizontal axis and vertical axis, so the luminous intensity and illuminance of the tested lamp or luminaires can be tested.



LSG-1950 Standard Version



LSG-1950S Economic Version

Specification:

- It is designed according to EN, IEC, GB, ECE, SAE and FMVSS108
- The accuracy of angle: 0.01°(LSG-1950) or 0.1° (LSG-1950S), Resolution of angle: 0.001°
- Luminosity Testing Range: Illuminance 0.001lx~99,999lx
- Accuracy of photometry: CIE Class A (Class L is option)
- Testing Accuracy: 2% (Under Standard lamp); Stray Light: less than 0.1%
- Can test max lamp up to 35kg and English version software can be run in Win7, Win8 and Win10

Traffic Lights Test

	-4.0°	-3.0°	-2.0°	-1.5°	-1.0°	-0.5°	0.0°	0.5°	1.0°	1.5°	2.0°	3.0°	4.0°
1.0°	10000	10000	10000	10000	10000	10000	10000	10000	10000	10000	10000	10000	10000
0.5°	10000	10000	10000	10000	10000	10000	10000	10000	10000	10000	10000	10000	10000
0.0°	10000	10000	10000	10000	10000	10000	10000	10000	10000	10000	10000	10000	10000
-0.5°	10000	10000	10000	10000	10000	10000	10000	10000	10000	10000	10000	10000	10000
-1.0°	10000	10000	10000	10000	10000	10000	10000	10000	10000	10000	10000	10000	10000
-1.5°	10000	10000	10000	10000	10000	10000	10000	10000	10000	10000	10000	10000	10000
-2.0°		10000	10000	10000	10000	10000	10000	10000	10000	10000	10000	10000	
-3.0°			10000	10000	10000	10000	10000	10000	10000	10000	10000		
-4.0°				10000	10000	10000	10000	10000	10000	10000			

Current Lx:10000.00cd

Project file: "C:\Program Files\Lisun\LSG Goniophotometer\DesignatedTest.xml"

Function	Min	Max	H	V	Value
-4.0°, 1.0°	70000.0	71400.0	-4.0°	1.0°	10000.00cd
-3.0°, 1.0°	120000.0	122400.0	-3.0°	1.0°	10000.00cd
-2.0°, 1.0°	160000.0	163200.0	-2.0°	1.0°	10000.00cd
-1.5°, 1.0°	200000.0	204000.0	-1.5°	1.0°	10000.00cd
-1.0°, 1.0°	400000.0	408000.0	-1.0°	1.0°	10000.00cd
-0.5°, 1.0°	500000.0	510000.0	-0.5°	1.0°	10000.00cd
0.0°, 1.0°	600000.0	612000.0	0.0°	1.0°	10000.00cd
0.5°, 1.0°	500000.0	510000.0	0.5°	1.0°	10000.00cd
1.0°, 1.0°	400000.0	408000.0	1.0°	1.0°	10000.00cd

Start Save

Pause Open

Reset Print

Settings Save Excel

Project File

Install Lamp

HAngle: 0 HOffset: 0

VAngle: 0 VOffset: 0

Begin Position Open Laser

Exit

Near Field Moving Detector Goniophotometer (LSG-1900B)

LSG-1900B Goniophotometer is a near field Moving Detector goniophotometer which is for luminous intensity distribution measurement. It fully meets LM-79 Clause 9.3.1 for industrial laboratory photometric data measurements of small luminaires such as down light, bulb light and etc.

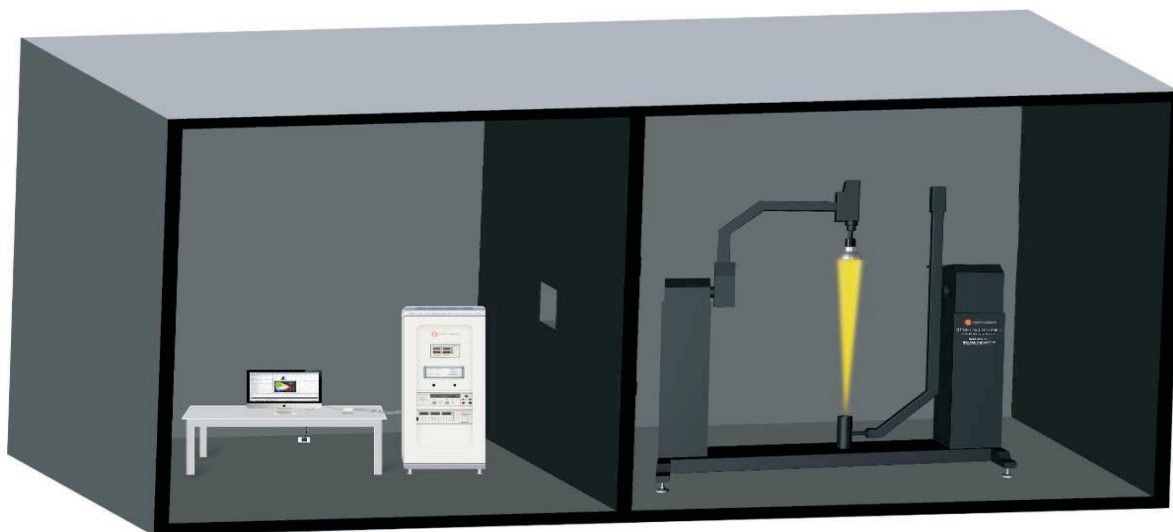
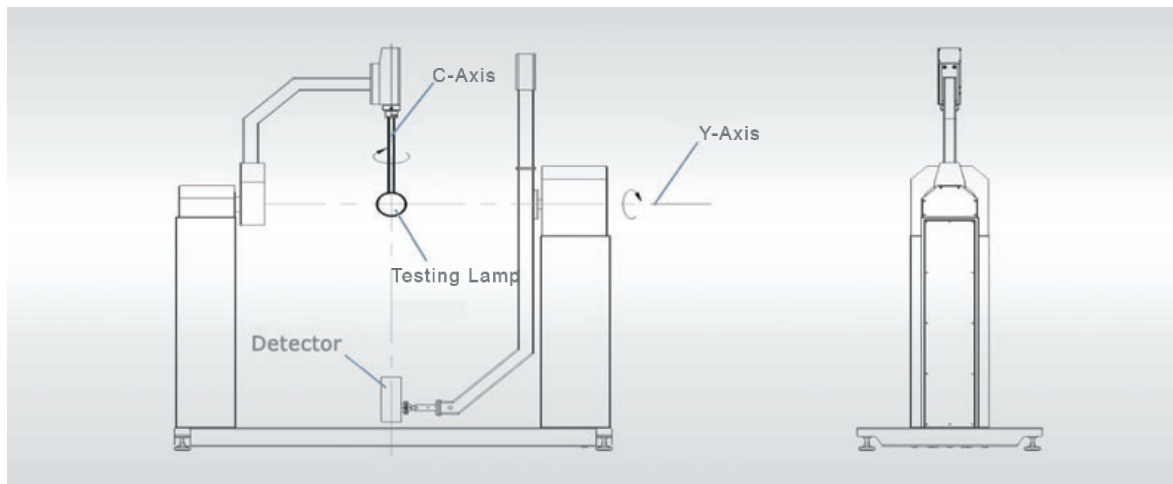

Specification:

- Meet the requirements of CIE, IEC, IES LM-79 & GB standards
- The luminaires will keep the burning point but not rotating during the testing
- The tested luminaires rotate around an angle of $(\gamma) \pm 180^\circ$ (or $0 \sim 360^\circ$) and the tested luminaires rotate around itself with an angle of $(C) \pm 180^\circ$ (or $0 \sim 360^\circ$)
- Maximum size of testing luminaires: $\Phi 300 \times 550 \text{mm}$ (diameter*depth), Weight: 20kg max
- Distance from lamp to detector: 1250mm
- Luminosity Testing Range: Illuminance $0.001 \text{lx} \sim 99,999 \text{lx}$; Light Intensity $0.015 \text{cd} \sim 10^7 \text{cd}$ (detector)
- The accuracy of angle: 0.1° , the resolution of angle: 0.01°
- Accuracy of photometry: CIE Class A (Class L is option)
- Testing Accuracy: 2% (Under Standard lamp); Stray Light: less than 0.1%
- English version software can be run in Win7, Win8 or Win10
- This system can export data files as following formats: ies, ldt, cie, cib, tm4, cen, excel and so on. This kind of format files can be transferred by luminaires design software such as DiaLux

Rotation Luminaire Goniophotometer (LSG-1800X, LSG-1800B, LSG-1700B, LSG-1600B)

The Rotation Luminaire Goniophotometer is an automatic goniophotometric measurement system for measuring photometric parameters of luminaires, such as LED road lighting fixture, room lighting fixture and projecting lighting fixture. The measured data meets IES standard format and can be applied in lighting design by lighting design software. The measurement system fully satisfies the requirements of lighting design work.

Measurement:

Luminous Intensity Data, Luminous Intensity Distribution, Zonal Luminous Flux, Luminaries Efficiency, Luminance Distribution, Coefficient Of Utilization, Luminance Limitation Curves Glare, Maximum Ratio of Distance to Height, Equal Illuminance Diagrams, Curves of Luminaires VS Lighting Area, Isocandela Diagrams, Efficient Luminescence Angle, EEI, UGR and so on.

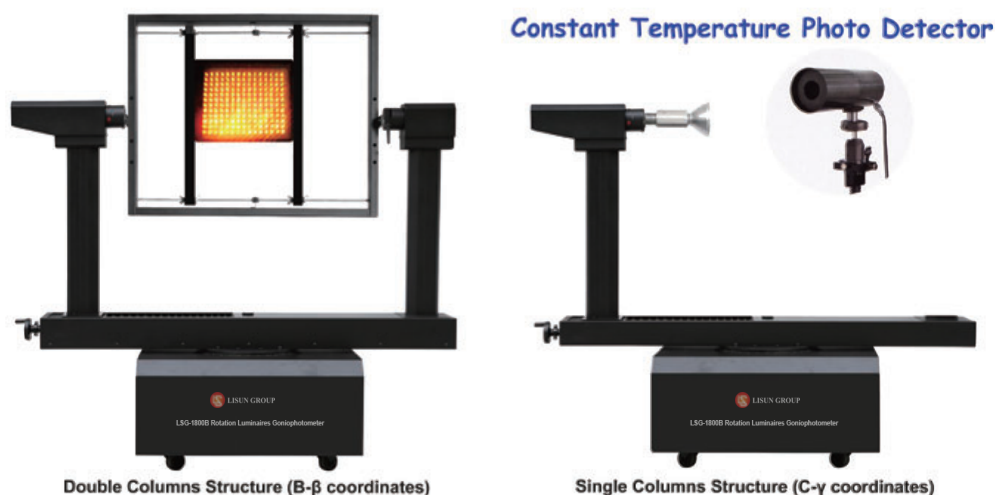

LSG-1800X/LSG-1800B use Japanese MITSUBISHI SERVO MOTORS and German Angle decode

Specification:

- Meet the requirements of CIE, IEC, IES LM-79 & GB standards
- Reach many measurement ways such as B-β and C-γ
- The tested luminaries rotate around an angle of (γ)±180°(or 0~360°) and the tested luminaire rotates around itself with an angle of (C)±180° (or 0~360°)
- Luminosity Testing Range: Illuminance 0.001lx~99,999lx; Light Intensity 0.015cd~10⁷cd
- The accuracy of angle: 0.1° (LSG-1800X/LSG-1800B) and 0.2° (LSG-1700B/LSG-1600B)
- Accuracy of photometry: CIE Class A (Class L is option)
- Testing Accuracy: 2%(Under Standard lamp); Stray Light: less than 0.1%
- English version software can be run in Win7, Win8 or Win10
- This system can export data files as following formats: ies, ldt, cie, cib, tm4, cen, excel and so on. This kind of format files can be transferred by luminaire design software such as DiaLux.

Model Number	The max size for the Testing Lamp (Unit: mm)		Max Weight
	C-Gamma Test with one Pillar	B-Beta Test with Two Pillars	
LSG-1800X	Φ 2500*550(Diameter*Depth)	700*600(Length*Width)	60kg
LSG-1800B	Φ 1600*550(Diameter*Depth)	700*600(Length*Width)	50kg
LSG-1700B	Φ 1600*550(Diameter*Depth)	700*600(Length*Width)	40kg
LSG-1600B	Φ 1300*400(Diameter*Depth)	400*400(Length*Width)	30kg

Goniospectroradiometer (LSG-1800XCCD, LSG-1800BCCD, LSG-1700BCCD, LSG-1600BCCD)

The Goniospectroradiometer System can do the spatial CCT, CRI and other colorimetric parameters test when do the intensity distribution test. It is for industrial laboratory measurements the photometric data of luminaires such as LED luminaires, HID lamps, fluorescent lamps and so on.

High Precision CCD Spectroradiometer with fixture set

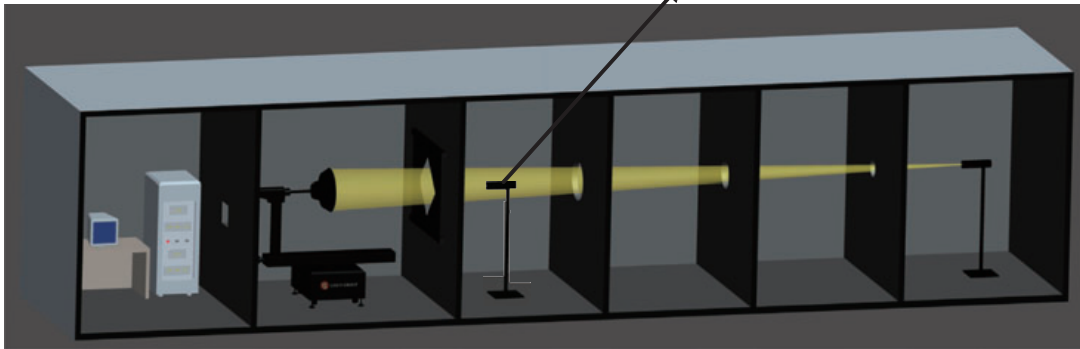

Goniospectroradiometer Test System

Specification:

- Meet the requirements of CIE, IEC, IES LM-79 & GB standards
- The Goniospectroradiometer system=Goniophotometer+Spectroradiometer integrating Sphere system
- The tested luminaires rotate around an angle of (γ)±180°(or 0~360°) and the tested luminaires rotate around itself with an angle of (C)±180°(or 0~360°)
- Luminosity Testing Range: Illuminance 0.001lx~99,999lx; Light Intensity 0.015cd~10⁷cd
- The accuracy of angle: 0.1° (LSG-1800XCCD/LSG-1800BCCD) and 0.2° (LSG-1700BCCD/LSG-1600BCCD)
- Work with High Accuracy and quick CCD Spectraidomeeter to measure spatial color parameters.
- Accuracy of chromaticity coordinate: ±0.0015 or ±0.0005(under standard A lamp)
- Spectral Range Wavelength: 380nm~780nm; Accuracy of wavelength: ±0.5nm
- Accuracy of photometry: CIE Class A (Class L is for option)
- Testing Accuracy: 2%(Under Standard lamp); Stray Light: less than 0.1%
- English version software can be run in Win7, Win8 or Win10

Test Report:



P.S. The test files can be export as following formats: ies, ldt, cib, tm4, cie, cen, csv

Compact Goniophotometer (LSG-1200A)

The compact goniophotometer of LSG-1200A is applied to measure the luminous intensity distribution curve, intensity data, spread angle and other parameters for chip LED, LED module, LED spotlight and all other lights which beam angle is no more than 180 degree.

Option Function: The LSG-1200A can work with Digital Power Meter (LS2012 DC & AC Power Meter or LS2010 Harmonic Analyzer), LSP Series AC Power Source or DC Series DC Power Source.



Specification:

- Meet the requirements of IEC, CIE and LM-79 standards
- Measure beam angle automatically: staple half intensity angle as well as 1/4 intensity angle, 3/4 intensity angle and 1/10 intensity angle which meets the special requirements.
- Measured data are matched with international standard form (IES) and can be applied for lighting design by other lighting design software such as Dialux
- LSG-1200A has included a dark chamber, measures the maximum size of lamps: 180mm
- Test range of luminosity: 0.1~30,000lx. Test accuracy of detector: Class 1
- The distance between the tested lamp and detector is 316mm/1000mm
- Angle interval: Horizontal angle: 1°/5°/10°/15°/22.5°/30°/45°/90°, Vertical angle: 0.5°/2°/1.5°
- The LSG-1200A horizontal automatic rotating on 0°~360° and Vertical automatic rotating on -90°~+90°
- Test accuracy of angle: ±0.2°.

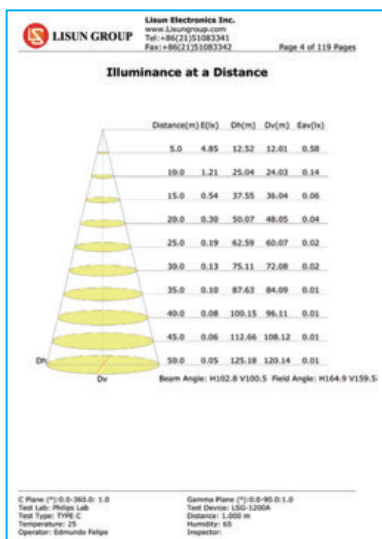

Illuminance

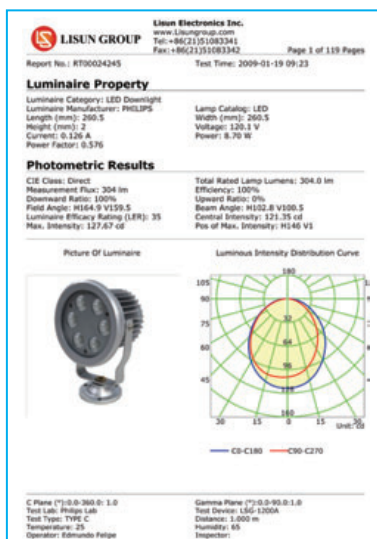

Photometric

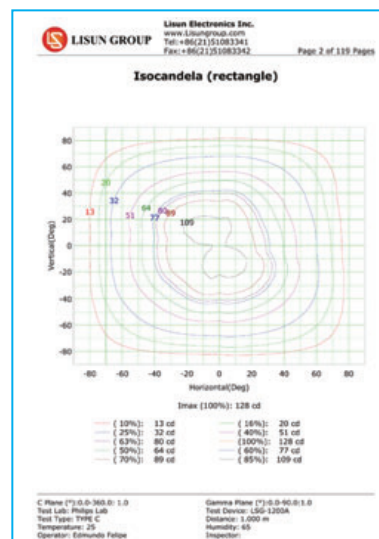

Isocandela

Scientific Grade CCD Spectroradiometer(LMS-9500B, LMS-9500A)

LMS-9500 Scientific Grade CCD Spectroradiometer fully meets Energy Star IESNA LM-79 and GB/T24824 standards etc. It is used to test CFL, HID, Promise Light, Tungsten Halogen Lamps, which can reach the scientific grade measurement accuracy. LMS-9500 is composed of Concave Average Diffraction Grating and Scientific Grade CCD, and uses unique stray light control technology, wide dynamic linear technology, precision CCD electronic drive technology and complex matrix software technology. The instrument can be traceable to the Chinese National Institute of Metrology(NIM) and the USA NIST standards.



Specification:

- CCD Detector: Hamamatsu TE cooled (Temp: 10°C ±0.05°C) high sensitivity back thinned CCD (LMS 9500B), Hamamatsu high sensitivity back thinned CCD (LMS 9500A)
- Spectral Range Wavelength: 380nm~800nm (200~800nm and 380~1050nm are option)
- Spectral Wavelength Accuracy: ±0.2nm, Resolution: ±0.1nm, Sample Scanning Steps: ±0.1nm
- Accuracy of Chromaticity Coordinate (Δx, Δy): ±0.0015
- Correlated Color Temperature CCT: 1,500K~100,000K, CCT Accuracy: ±0.2%
- Color Rendering Index Range: 0~100.0, Accuracy: ±(0.3%rd±0.3)
- Photometric linear: ±0.2%, Stray light: <0.015%(600nm) and <0.03%(435nm)
- Time of integration: 0.1ms 60s
- Total flux testing method: Spectrum, Photometric and Spectrum with Photometric revision
- Spectrum sensors: SMA905 optical fiber

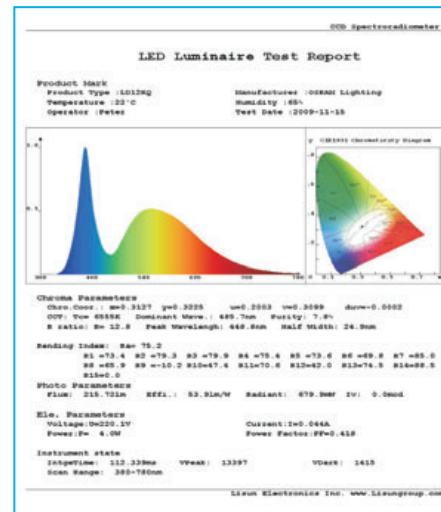
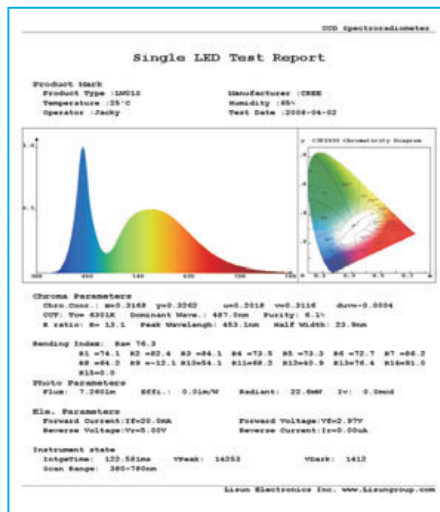

High Precision CCD Spectroradiometer (LMS-9000B)

LMS-9000B is adopting the world advanced Holographic grating with flat-field correction, precision optical system and the electronic shutter control technology. The test speed can be in milliseconds and the test accuracy is in the laboratory level. It has the lowest value of stray light. LMS-9000B has high repeatability and stability testing. It fully meets CIE127-1997, IES LM-79-08 and IES LM-80-08.

Specification:

- Spectral Range Wavelength: 380nm~800nm
- Spectral Wavelength Accuracy: $\pm 0.3\text{nm}$, Resolution: $\pm 0.1\text{nm}$, Sample Scanning Steps: $\pm 0.1\text{nm}$
- Accuracy of Chromaticity Coordinate (Δx , Δy): ± 0.002
- Correlated Color Temperature CCT: 1,500K~100,000K, CCT Accuracy: $\pm 0.3\%$
- Color Rendering Index Range: 0~100.0, Accuracy: $\pm(0.3\% \text{rd} \pm 0.3)$
- Photometric linear: $\pm 0.3\%$, Stray light: $< 0.015\%$ (600nm) and $< 0.03\%$ (435nm)
- Time of integration: 0.1ms 20s
- Total flux testing method: Spectrum, Photometric and Spectrum with Photometric revision
- Spectrum sensors: SMA905 optical fiber and Class A Photo detector
- It can measure the temperature inside and outside of integrating sphere

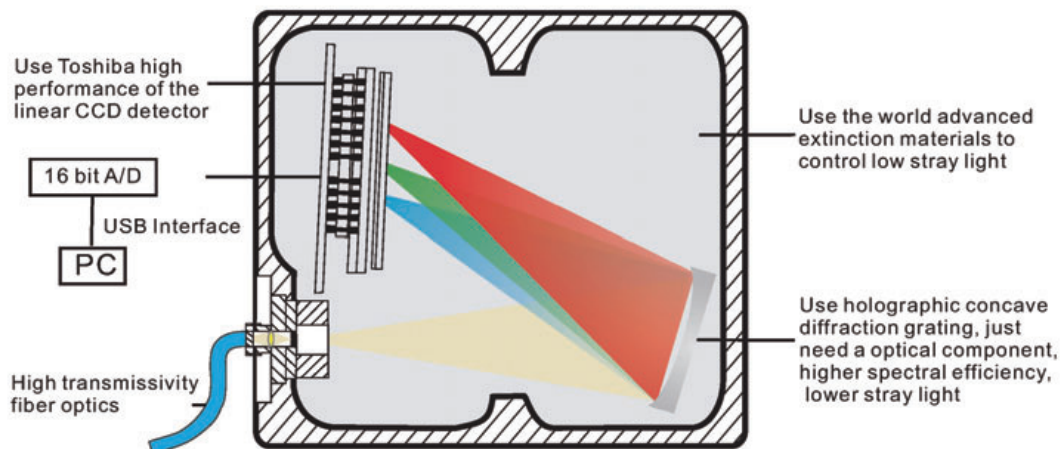

LMS-9000B High Precision CCD Spectroradiometer

LMS-9000B uses the Band pass-filter Wheel Correcting Technique, Spectrometer & Broadband-radiometer & photometer Combined Technique, and modified with NIST stray light correction technology, the LMS-9000B can realize ultra low stray light and super photometry linearity in overall dynamic range.

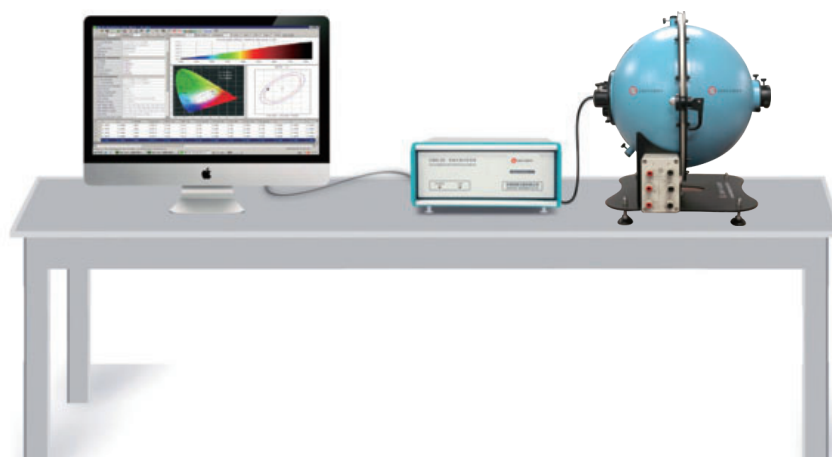

CCD Spectroradiometer (LMS-7000)

Typical Application:

The LMS-7000 works with LISUN a molding integrating sphere to be an ALL-IN-ONE system to test single LED and LED luminaires photometric, colorimetric and electrical parameters. The test speed is quick and test results are very accuracy. It fully meets CIE127-1997, IES LM-79-08 and IES LM-80-08. The LMS-7000 is a cost-efficient CCD Spectroradiometer which was widely used by the LED manufactory.

The LMS-7000 is quick and high accuracy testing. It has been certificated by the third CNAS lab, the test results can be traced to NIM and NIST.

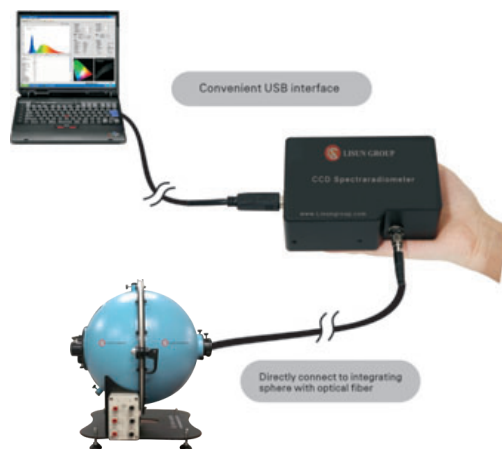

LMS-7000UV	LMS-7000UV-VIS	LMS-7000VIS	LMS-7000VIS-NIR	LMS-7000UV-VIS-NIR
200~400nm	200~950nm	350~950nm	380~1050nm	200~1050nm

Measurement:

- Colorimetric: Chromaticity coordinates, CCT, Color Ratio, Peak Wavelength, Half Bandwidth, Dominant Wavelength, Color Purity, CRI, Spectrum Test
- Photometric: Luminous Flux, Luminous Efficiency, Radiant Power
- Electric: Voltage, Current, Power, Power Factor
- LED optical maintenance test according to LM-80: Flux VS time, CCT VS time, CRI VS time, Power VS time, Power Factor VS time, Current VS time and Flux Efficiency VS time.

Specification:

- Spectral Wavelength Accuracy: $\pm 0.5\text{nm}$, Resolution: $\pm 0.2\text{nm}$, Sample Scanning Steps: $\pm 0.1\text{nm}$
- Accuracy of Chromaticity Coordinate ($\Delta x, \Delta y$): ± 0.003
- Correlated Color Temperature CCT: 1,500K~25,000K, CCT Accuracy: $\pm 0.5\%$
- Color Rendering Index Range: 0~100.0, Accuracy: $\pm(0.3\% \text{rd} \pm 0.3)$
- Photometric linear: $\pm 0.5\%$, Stray light: $< 0.015\%$ (600nm) and $< 0.03\%$ (435nm)
- Time of integration: 0.1ms 5s
- Spectrum sensors: SMA905 optical fiber
- Communicate with PC via USB2.0, the software can be run-in Win7, Win8 and Win10

Other Application:

The LMS-7000 works with other accessories, it can be used to do test and analysis in the following field and area. We supply the DLL which allow you to do the system build-in and re-design functions.



Portable CCD Spectroradiometer (LMS-6000)

Specification:

- Spectral platform: telephoto asymmetrical crossed CT system
- Spectral Wavelength Accuracy: $\pm 0.5\text{nm}$, Resolution: $\pm 0.2\text{nm}$, Sample Scanning Steps: $\pm 0.1\text{nm}$
- Accuracy of Chromaticity Coordinate ($\Delta x, \Delta y$): ± 0.005
- Correlated Color Temperature CCT: 1,500K~25,000K, CCT Accuracy: $\pm 0.6\%$
- Color Rendering Index Range: 0~100.0, Accuracy: $\pm(0.3\%rd\pm 0.3)$
- Photometric linear: $\pm 0.6\%$, Stray light: $< 0.015\%(600\text{nm})$ and $< 0.03\%(435\text{nm})$
- Time of integration: 0.1ms 5s
- LCD screen: 5inch high definition IPS capacitive touch screen and resolution is up to 480*854
- With 4000mAh rechargeable Li-ion battery continuous working time 20 hours max
- The size (L*W) is similar to Iphone 6S and the thickness is similar to the diameter of 1RMB coin
- Include 8GB SD Card which can storage the test data, communicate with PC via software which can be run in Win7, Win8 and Win10.

Measurement:

- LMS-6000: illuminance (lux), E(Fc), Ee(W/m²), Tc (K), Duv Correlated Color Temperature (CCT), Chromaticity Coordinates, CRI, Purity, Peak Wavelength, Dominant Wavelength, Half Bandwidth, Center Wavelength, Centroid Wavelength, Total Color Difference, Brightness Difference, Red-Green Degree, Yellow-Blue Degree, CCT Difference, SDCM Diagram, Spectrum Diagram
- LMS-6000P: LMS-6000 Parameters+PAR, PPFD, YPFD, Blue-purple irradiance Eb, Yellow-green irradiance Ey, Red-orange irradiance Er, Ratio of red and blue radiation Erb Ratio
- LMS-6000S: LMS-6000 Parameters+PAR, PPFD, YPFD, Blue-purple irradiance Eb, Yellow-green irradiance Ey, Red-orange irradiance Er, Ratio of red and blue radiation Erb Ratio, Rf and Rg according to TM-30
- LMS-6000F: LMS-6000 Parameters+Flicker test
- LMS-6000B: LMS-6000 Parameters+Blue Light Hazard Weighted Irradiance according to GB/T20145, CIE S009/E:2002
- LMS-6000BF: LMS-6000 Parameters+Flicker test, Blue Light Hazard Weighted Irradiance according to GB/T20145, CIE S009/E:2002

Test Report:

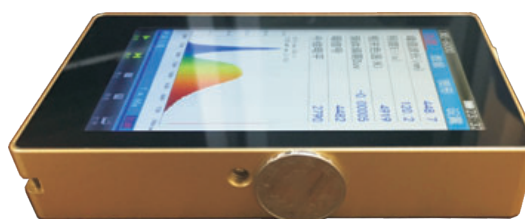
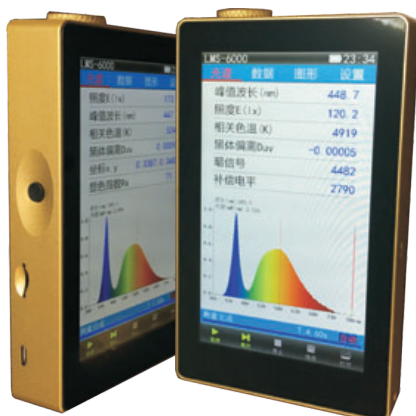
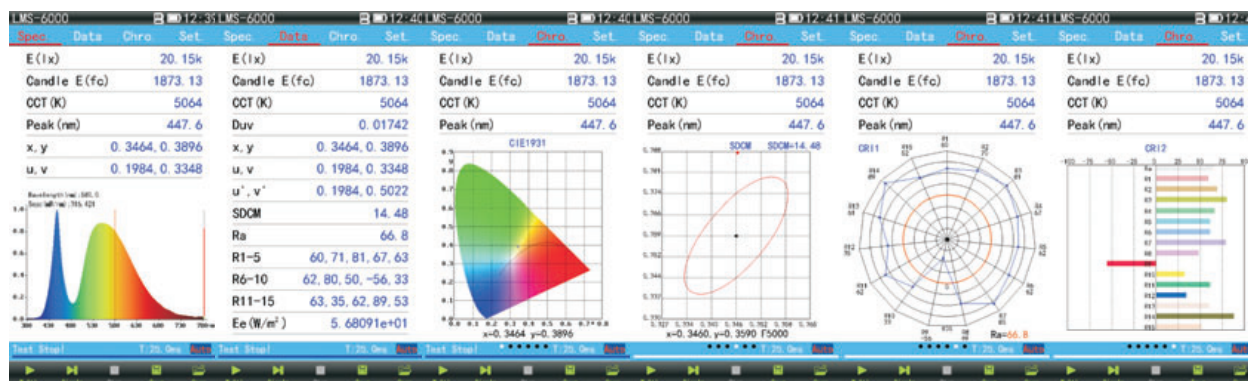

Integrating Sphere with Testing Holder Base (IS-*MA)

Due to the LED luminaries such as LED street luminaries developed, to do 4π geometry testing, it is hard to be hold in the traditional integrating sphere design. To solve this problem, Lisun designed this new kind of sphere.



1. The hold base can bear max 20kg, it can expanding to test all lamps such as E27/E40, all tubes such as T5/T8/T12, and all kinds of luminaries
2. The hold base can be installed in the ceiling or down, it can be adjusted the height
3. Hold base has four power cables connected to the outside Power Supply and max is 5KW
4. The holder base is detachable. For some kinds of light sources you may need to change the position of the holder base.
5. Diameter: IS-0.3M (Φ 0.3m), IS-0.5M (Φ 0.5m), IS-1.0MA (Φ 1.0m), IS-1.5MA (Φ 1.5m), IS-1.75MA (Φ 1.75m), IS-2.0MA (Φ 2.0m). Other sizes can be designed according to the customer's request.
6. The painting of integrating spheres is designed according to CIE Pub. No.84 (1989)

Integrating Sphere theory and Applications:

The integrating sphere works with a Spectroradiometer to do the photometry, colorimetry and radiometry parameters measurement:

- IS-0.3M/IS-0.5M is suitable for LEDs, LED modules, High Power LED, mini bulbs and other small lamps. The flux testing range is 0.001 to 1,999 lm
- IS-1.0MA is for suitable CFL or LED bulbs. The flux testing range is 0.1 to 199,990 lm
- IS-1.5MA/IS-1.75MA is suitable for CFL, LED bulb and tube, fluorescent lamp, CCFL. The flux testing range is 0.1 to 1,999,900 lm
- IS-2.0MA is suitable for HID lamps or high power lamps. The flux testing range is 0.1 to 1,999,900lm

Integrating Sphere with Side Assistant Opening (IS-*MAP, IS-*MA**C)**

According to IES LM-79 Clause 9.1.2, it requires the 4 geometry and 2 geometry configuring Integrating Sphere for the LED Testing. Lisun Group developed the integrating sphere with side assistant Opening in A Molding Technology to meet the requirements.

The traditional integrating sphere is assembled by several pieces. Lisun Group developed A Molding Technology to produce the sphere. A Molding Integrating Sphere will be more round and the test results will be more accuracy than the traditional integrating sphere.



Figure: A Molding Integrating Sphere VS the traditional Integrating Sphere

Specification:

- Painting material of integrating spheres is designed according to CIE Pub.No.84(1989)
- The painting material is BaSO₄ coating: $\rho(\lambda) \geq 0.96(450\text{nm} \sim 800\text{nm})$ and $\rho(\lambda) \geq 0.92(380\text{nm} \sim 450\text{nm})$
- Fine diffuse reflection: Reflectance $\rho \approx 0.8$ and accuracy of $\rho(\lambda) < 1.5\%$
- Build-in all functional lamp testing jigs: the vertical is for E40/E27, the horizontal is for T5/T8/T12 tubes and the Testing Holder Base for LED street luminaires. All of the testing jigs can allow the lamp be tested up and down in the sphere.
- Power Cable, Power Terminal and Auxiliary lamp position has been built-in (Auxiliary lamp is option).
- Two photo detector ports, one optical fiber port and temperature sensor hole are built-in
- Ordering Code: IS-1.5MA55P or IS-1.5MA55C ($\Phi 1.5\text{m}$, IS-1.5MA55P means square side opening is $0.5 \times 0.5\text{m}$, IS-1.5MA55C means cycle side opening diameter is 0.5m). IS-1.75MA66P or IS-1.75M66C ($\Phi 1.75\text{m}$ and side opening is 0.6m). IS-2.0MA77P or IS-2.0MA77C ($\Phi 2.0\text{m}$ and side opening is 0.7m). Other size such as diameter 2.5m , 3.0m can be special order according to customer's request.

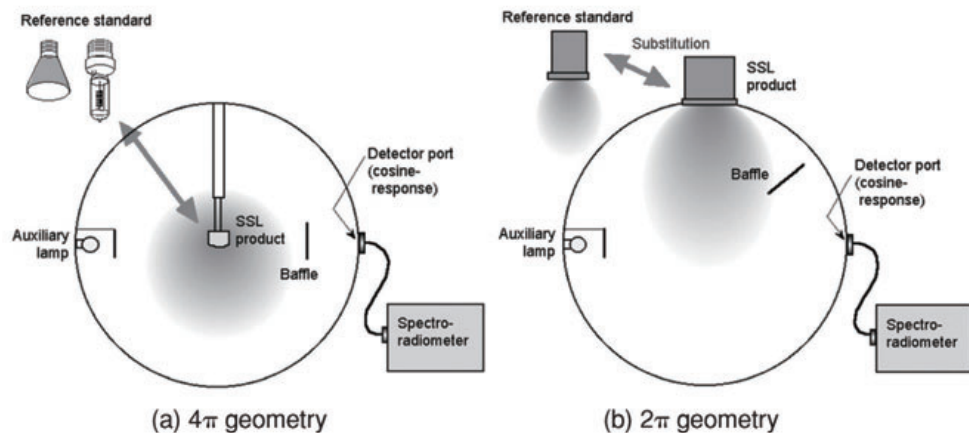

Fig: LM-79 Clause 9.1.2

Constant Temperature Integrating Sphere (IS-*MT)

According to requirements of IEC standards, the standard test temperature is 25°C, but high power lamps such as HID lamps and LED outdoor luminaires will produce a lot of heat during the test, thus the temperature inside the integrating sphere can not meet the requirements of IEC standards. Lisun Group designed the Constant Temperature Integrating Sphere which allows the lamp to be tested in a constant air temperature.

Specification:

- Diameter: IS-0.3MT (Φ0.3m), IS-0.5MT (Φ0.5m), IS-1.0MT (Φ1.0m), IS-1.5MT (Φ1.5m), IS-1.75MT (Φ1.75m), IS-2.0MT (Φ2.0m). Other size can be designed according to the customer's request.
 - Painting of integrating spheres is designed according to CIE Pub. No.84 (1989).
 - Material: Pure barium soleplate (BaSO₄).
 - BaSO₄ coating: $\rho(\lambda) \geq 0.96$ (450nm~800nm) and $\rho(\lambda) \geq 0.92$ (380nm~450nm).
 - Fine diffuse reflection: Reflectance $\rho \approx 0.8$ and accuracy of $\rho(\lambda) < 1.5\%$.
 - Build-in all functional lamp testing jigs: the vertical is for E40/E27, the horizontal is for T5/T8/T12 tubes and the Testing Holder Base for LED street luminaires. All of the testing jigs can allow the lamp be tested up and down in the sphere.
 - Auxiliary lamp position has been built-in. Auxiliary lamp and Auxiliary lamp device are optional.
 - Power cable and socket has been build-in, it is convenient to power the testing lamp.
 - Two photo detector ports, one optical fiber port and temperature sensor hole are built-in.
 - Constant Temperature controlled range: 25°C~55°C (refer to the environmental temperature at 25°C).
- A. Temperature Increasing tolerance: $\pm 1^\circ\text{C}$
 B. Temperature Down tolerance: $\pm 2^\circ\text{C}$

Application:

The integrating sphere works with a Spectrophotometer to do the photometry, colorimetry and radiometry parameters measurement:

- IS-0.3MT/IS-0.5MT is suitable for LEDs, LED modules, High Power LED, mini bulbs and other small lamps. The flux testing range is 0.001 to 1,999 lm.
- IS-1.0MT is suitable for CFL or LED bulbs. The flux testing range is 0.1 to 199,990 lm.
- IS-1.5MT/IS-1.75MT is suitable for CFL, LED bulb and tube, fluorescent lamp, CCFL. The flux testing range is 0.1 to 1,999,900 lm.
- IS-2.0MT is suitable for HID lamps or high power lamps. The flux testing range is 0.1 to 1,999,900 lm



UV-VIS High Index of Reflective Coating

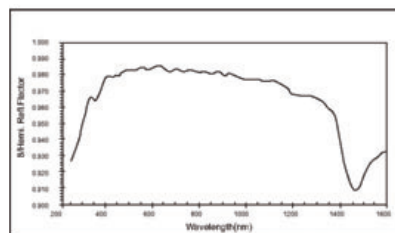

VIS High Index of Reflective Coating

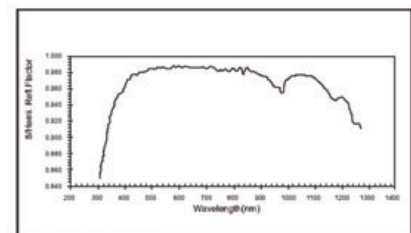

Spectroradiometer and Integrating Sphere Compact System for LED (LPCE-3)

Due to the LED Test System is hard to install and debug, LISUN developed a Spectroradiometer and Integrating Sphere compact System LPCE-3. The LPCE-3 system combines the cabinet, test equipments and integrating sphere together, so it allows the customers only to connect with PC and use the system immediately but no need to install. In the other side, the compact system saves a lot of delivery cost.

The LPCE-3 is used for identifying the performance of single LEDs and LED lamps. LED's quality should be tested by checking its photometric, colorimetric and electrical parameters. The LPCE-3 system fully meets CIE127-1997, IES LM-79-08 and IES LM-80-08. The integrating sphere produced by A Molding technology, it was built-in cross laser system and auxiliary position to improve the test accuracy.

ALL-IN-ONE LED Test System

1. CCD Spectroradiometer
2. Big Integrating Sphere with Cabinet
3. Standard Lamp
4. Auxiliary Lamp
5. Digital Power Meter
6. AC Power Source
7. DC Power Supply
8. Optical Fiber
9. Mini PC (without Monitor)

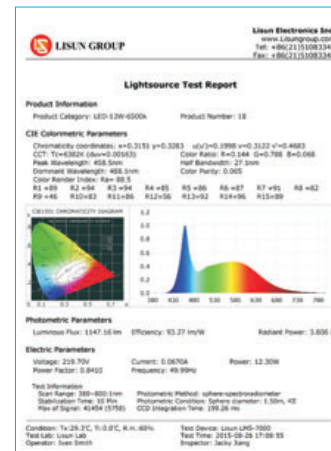

Integrating Sphere Spectroradiometer System (LPCE-2)

LPCE-2 is an Integrating Sphere Spectroradiometer Test System to test Energy-saving lamps, Fluorescent lamps, HID lamps (high voltage sodium lamps and high voltage mercury lamps), CCFL and LED. The test results meet the requirements of CIE and IES LM-79 for the measurement of photometry and colorimetry. The LPCE-2 is applied with LMS-9000/LMS-9500 CCD Spectroradiometer and a molding integrating sphere with testing holder base function which will be more circle and the test results will be more accurate than the traditional integrating sphere.

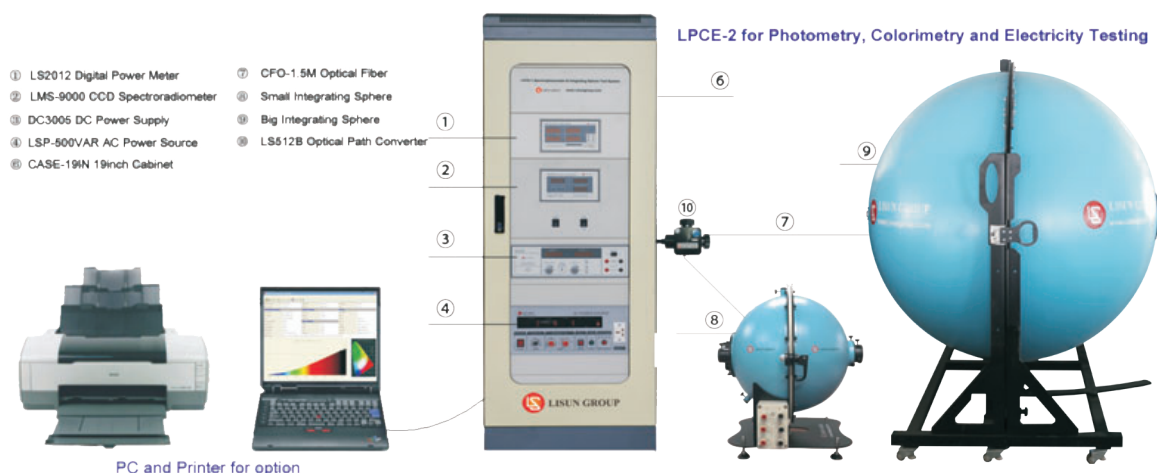

Measurement:

- Colorimetric: Chromaticity coordinates, CCT, Color Ratio, Peak Wavelength, Half Bandwidth, Dominant Wavelength, Color Purity, CRI, CQS, TM-30, Spectrum Test
- Photometric: Luminous Flux, Efficiency, Radiant Power, EEI, Energy Efficiency Class, Pupil Flux, Circopic Flux, PAR, PPF
- Electric: Voltage, Current, Power, Power Factor
- LED optical maintenance test according to LM-80: Flux VS time, CCT VS time, CRI VS time, Power VS time, Power Factor VS time, Current VS time and Flux Efficiency VS time.

Optical Radiation Safety Test System (EN62471-C)

The Optical Radiation Safety Test System is used to test the spectral power distribution, radiance, irradiance, radiation exposure, specific effective radiant ultraviolet power (mW/klm), illuminance, size of apparent source, CCT, color coordinate, CRI, SDCM and other parameters of LED, LED modules, LED lamps, LED luminaires, fluorescent lamps, HID lamps, halogen lamps and all other luminaires. The testing parameters include actinic UV hazard weighted irradiance, near UV irradiance, retinal blue light hazard weighted radiance, retinal thermal hazard, infrared irradiance, visible and infrared irradiance etc. The tested lamps and lamp systems can be classified as per the photobiological hazard values.

The test system is designed according to the following standards: IEC62471, EN62471, CIE S009, GB/T 20145, IEC/EN60598 Annex P., IEC/EN60432, GB7000.1, 2005/32/EC, EUP directives and etc.



Fig. EN62471-C in dark room

Specification:

- Wavelength range: 200~800nm(EN62471-A), 200~1500nm(EN62471-B), 200~3000nm(EN62471-C)
- Radiance geometry: optics simulating human eye's retina
- Acceptance aperture: Dia. 7mm for radiance; Dia. 20mm & 7mm for irradiance
- FOV range: 1.5mrad to 110mrad (1.7mrad, 11mrad, 100/110mrad) according to exposure duration of radiance measurement; 100mrad, 1.4rad and 6.28rad for irradiance measurement
- Testing distance: 200mm to 6.0m(optional) with constant FOVs and input aperture
- Image resolution:1600*1200
- Maximum exposure scanning range: 2pi-space
- Calibration: It can be traced to NIM
- Detectors: PMT/InGaAs/Si/PbS
- Imaging radiance meter: scientific grade 16bit CCD camera with TEC
- Sampling speed of pulse source:20us to 10s
- Wavelength accuracy: 0.1nm(UV), 0.2nm(VIS), 0.4nm(IR)
- Goniophotometer (LSG-1800B/LSG-1700B) is option

LED Lumen Maintenance and Aging Life Test System (LEDLM-80PL)

LEDLM-80PL LED Lumen Maintenance and Aging Life Test System is designed according to standards of IES-LM-80, IES-LM-82, TM-21 and GB2312-80, the software is developed base on Arrhenius model. LED has the features of long life, but with the different working condition and drive current, its life will be different, but generally the life will be around 50K hours. Differ from the traditional lightsource, LED light will decay gradually rather than extinguish instantly, so in the standard of LM-80, it introduces L70, L50 and etc.

- 1) L70 (hour): time to 70% lumen maintenance
- 2) L50 (hour): time to 50% lumen maintenance

Features:

- 1) Record the changing curves of lumen VS time, and colorimetric parameters VS time
- 2) Test and record the light attenuation data within a short time, then software will predict the LED life
- 3) Introduce the Arrhenius Model to make the test result more reliable and effective

System Configuration:

LM-80PL LED Aging Control System with Arrhenius software, TMP-8 Multiplex Temperature Meter, LMS-4000 Quick Test System for Photo and Color, CFO-1.5M Optical Fiber, LS2008R Digital Power Meter, LSP-18CH The Switching Power System for the LED lamp, CASE-19IN Cabinet

Design according to IES LM-80
Economic & Flexiable



The Life Calculated by TM-21:

Slope(m)	-3.067E-06
Intercept(b)	1.365E-02
$\alpha 1$	3.067E-06
B 1	1.014
Calculated $L_{70}(6k)$	121.000

P.S The LEDLM-80PL needs to work with a GDJW Series High/Low Temperature Chamber and a LSP Series AC Power Source.

LISUN GROUP		Lisun Electronics Inc. http://www.Lisungroup.com Tel: +86(21)351083341 Fax: +86(21)351083342	
Report No.: 201401002	Page 2 of 6 Pages		
Lumen Maintenance Life Prediction(Based on TM-21)			
Test Condition - 55°C Case Temp			
Sample Name: White SMD LED			
Model: YL-T3528W-AA-60C			
Ratings: 20mA, 6.5lm, 75(Ra), 6000K			
Manufacturer: OSRAM Lighting			
Sample Quantity	6		
Number Of Failures	0		
DUT drive voltage used in the test (V/Hz)	220.1/50.02		
Test duration (hours)	6000		
Test duration used for projection (hour to hour)	1000 - 6000		
Tested case temperature (°C)	55		
α	6.081E-006		
B	0.998		
Calculated L70(6k) (hours)	815715		
Reported L70(6k) (hours)	>33000		
Calculated L50(6k) (hours)	871049		
Reported L50(6k) (hours)	>33000		

Lumen Maintenance Life Prediction Report

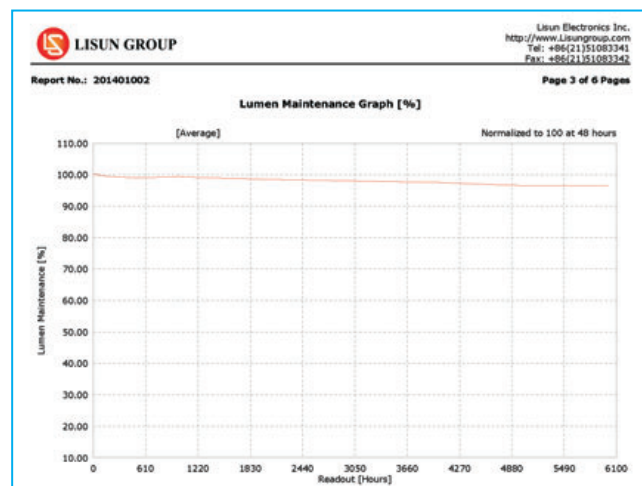

Lumen Maintenance Graph

Lamp Start, Run-up time and Flicker Test System (LSRF-2)

Dated 14th December, 2012, the EU officially released the (EU) NO.1194/2012 rules <Implementing rules of the European Parliament and the EU Council Directive 2009/125/EC on the eco-design requirements of directional lights, LED lights and related equipment requirements>. Compared with <European Parliament and Council Directive 2005/32/EC implementing rules for non-directional household lamps eco-design requirements> which posted by the European Commission Regulation (EC) NO 244/2009 Regulations dated 18th March, 2009, the new rules have complete mandatory and eco-design requirements. Start and Run-up time as the two indicators functional requirements in the industry have been more emphasis by manufacturers.

To meet EU ErP requirements, IEC60969 Self-ballasted Lamps for General Lighting Services Performance requirements and Energy Star. LISUN developed ErP test system LSRF-2 to test the Lamp Start, Run-up Time and Lamp Flick.

The LSRF-2 system can be an option function for LISUN LPCE-2 or LPCE-3 Integrating Sphere and Spectroradiometer Test System.

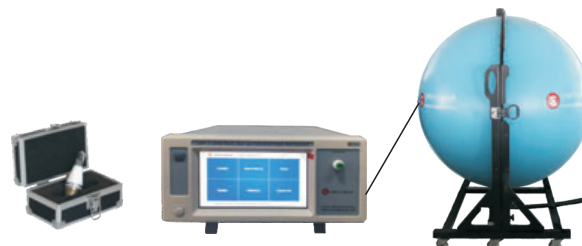

The integrating sphere & calibrate lamp are option

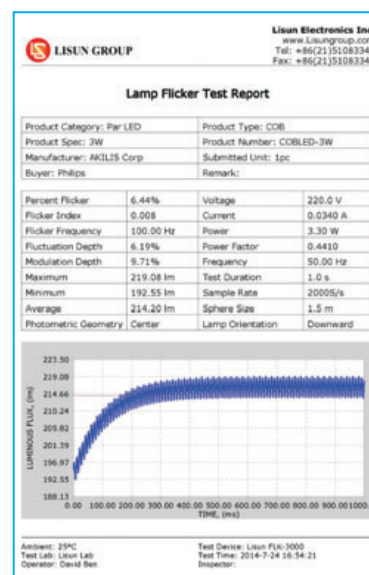
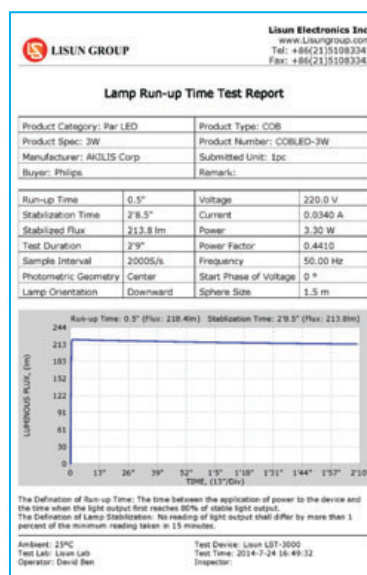
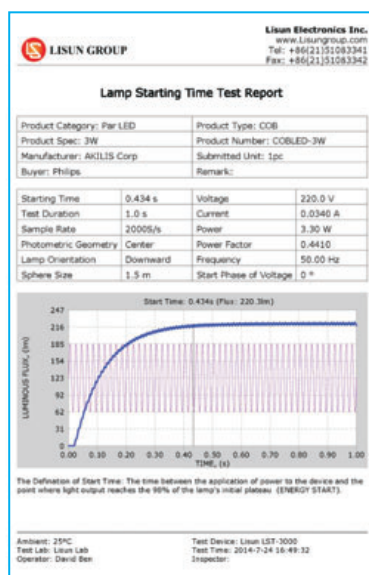

Fast Photo-Electric Tester (LS616S)

The LS616S is designed in a Luggage which can be taken out conveniently. The LS616S can be used to test the CFL, Single LED, LED Spotlight and LED bulb which lamp holder is E27, E40, MR16 and so on.

Specification:

- Electric parameters:
 - Measuring range: Voltage: 0~300V; Current: 0~0.5A
 - Accuracy: Voltage, Current, Power: $\pm(0.4\% \text{ read value} + 1\text{digit})$
Power factor: $\pm(0.004 + 0.001/\text{read value} + 1\text{digit})$
- Photometric parameters:
 - Measuring range of brightness: $0.001\text{kcd}/\text{m}^2 \sim 999.9\text{kcd}/\text{m}^2$
 - Accuracy grade: Class 1



LED Power Driver Tester (WT2080)

WT2080 LED Power Driver Test Instrument is the comprehensive test instrument for LED Power Driver which is according to GB/T 24825-2009 and IEC 62384:2006. It can measure the following parameters: Input Characteristics Test (AC&DC), Output Characteristics Test (AC&DC), Output Start Characteristics Test (DC) and Harmonic Test.

The WT2080 usually works with LISUN LSP-500VAR pure sine AC Power Source and LISUN M9822 DC Electronic Load to test LED Driver. The software can be run Win7, Win8 and Win10.

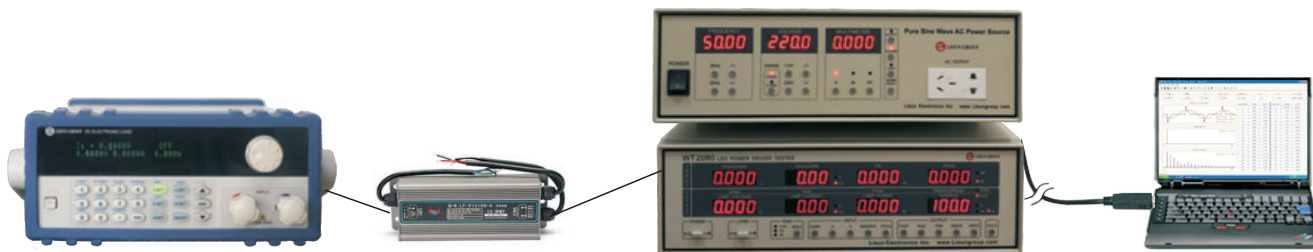

Specification:

1. Input Characteristics Test (AC)

- To measure the input voltage, current, power, power factor, power grid frequency
- The fundamental frequency scope of the current and voltage: 45Hz~65Hz; Narrow band range: 45Hz~5kHz; Broadband range: 45Hz~1MHz.
- U range: 3~300V (CF=1.67); Current: 5mA~2.7A (CF=3); Power: 0.015~800W; PF: 0.000~+1.000.

2. Input Characteristics Test (DC)

- Measuring voltage, current, power.
- Voltage range: 3~500V; Current range: 5mA~8A; Power range: 0.015~4KW

3. Output Characteristics Test (AC)

- Measuring lamp voltage, lamp current and lamp power.
- Lamp U range: 3~300V(CF=3); Lamp I range: 5mA~2.7A(CF=3); Lamp P range: 0.015~800W

4. Output Characteristics Test (DC)

- Measuring output lamp voltage, lamp current, lamp power, ripple wave current.
- U range: 3~500V; I range: 5mA~8A; P: 0.015~4KW; Ripple wave current: 5mA~2.5A.

5. Output Start Characteristics Test (DC)

- Change curve and data of the measuring lamp voltage and lamp current within 0~2 seconds.
- Lamp voltage range: 3~500V; Lamp current range: 5mA~8A

6. Harmonic Testing

- Total harmonic components test of 0~50times, wave ratio, initial phase angle and peak phase angle

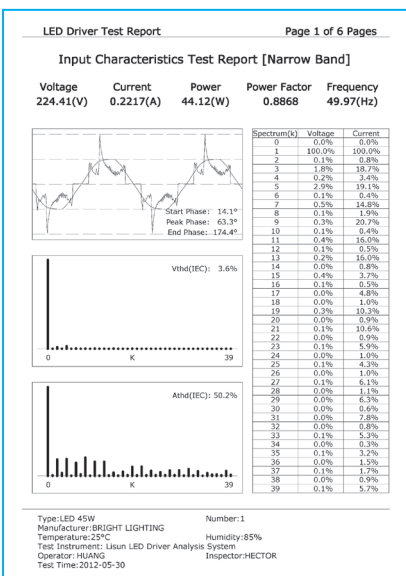

Input Characteristics

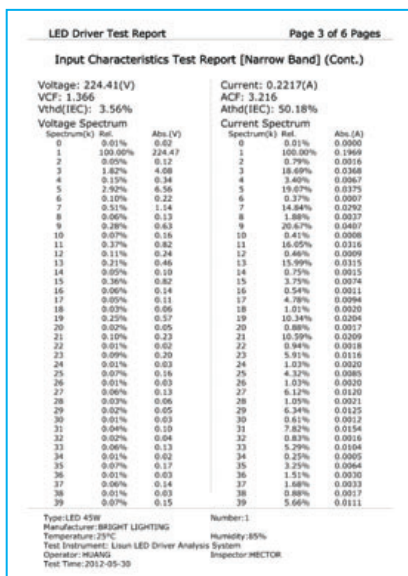

Start Characteristics

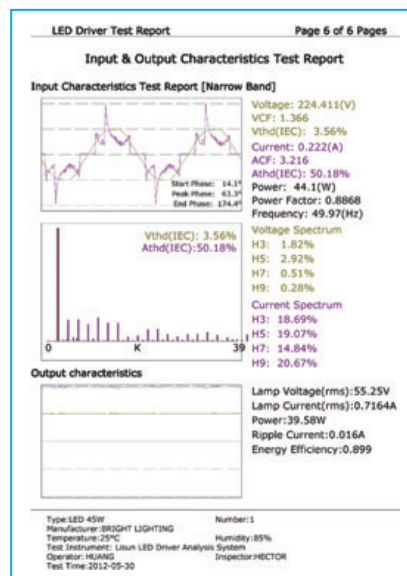

Input & Output Characteristics

LED Driver Online Tester (LEDLS-60, LEDLS-12)

LEDLS-60/LEDLS-12 LED Driver Online Tester is applied to the production line for the finished products testing. With features of simplified operation and nice-looking, the workers can operate it at very short time. This system can meet the requirements of IEC62384, GB24825-2009 and other relative standards.

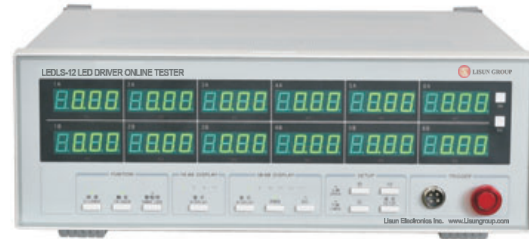

Specification:

- The LEDLS-12 has one channel which can test 6 LED Driver input and output parameters at one time (or 12 LED Driver input or output parameters at one time).
- The LEDLS-60 has ten channels which can test 60 LED Driver input and output parameters at one time.
- The tester can measure the following parameters:
 - 1). Input Parameter Test (AC) in RMS value: U, I, P, PF, Hz, THD
 - 2). Output Parameter Test (AC/DC) in RMS or Average value: U, I, P, PF, Efficiency, Ripple Wave Current
 - 3). The Hardmonic Test: THD and harmonic components test of 2, 3, 5, 7, 9 and 11 (total 50 is option)
- The LEDLS-60 has 8inch LCD screen to display all of the test parameters, the LEDLS-12 has 12 windows to display all the test parameters
- The test speed is quick: The LEDLS-60 needs only 20s include the LED load light on and test. The LEDLS-12 needs only 2s include the LED load light on the test
- They only need to connect six LED DC electric load (LISUN M9822) or LED lamp to do test
- It allows to set upper or lower limit, it will have Noisy/Light warning if the test results were over limit.
- The manual trigger and software connect to PC to storage test results are option (extra cost)

DC Electric Load (M9822, M9822B)

M9822/M9822B is newly designed circuit adopts rapid AD and DA technology to achieve rapid measurements with high accuracy. And the resolution of 0.1mV/0.1mA can effectively display the minor change of voltage and current, so the instrument has a wider application field and achieves better test results.

The new CR-LED test mode can be a real simulation of LED light features set by the increase in the diode turn-on voltage, fully simulate the working principle of the diode, so that the test voltage and current to achieve a normal and stable value, to avoid the traditional fixed resistor mode under voltage and current instability or shock, the real reflect the LED drive power load situation.



Specification:

- Input voltage: 0~150V(M9822) or 0~500V(M9822B); Input current: 1mA~30A; Input power: 300W
- CR-LED measurement mode, fully simulate the load characteristics of LED power
- High-light and high-visibility VFD display
- High resolution of 0.1mV and 0.1mA
- Test functions of OCP and OPP can accurately capture critical parameters
- Modes of CC, CV, CR, CP
- Battery test mode can automatically record the discharge time and the capacity
- The dynamic transition time of 0.1mA can effectively detect the power dynamic response.
- List test can flexibly set test mode and time and finally judge the test result
- Remote test function and multiple groups of data storage

High Frequency Fluorescent Lamp Test System(HFP-800, RB-3 and LPS-3)

This High Frequency Fluorescent Lamp Test System includes HFP-800 (High Frequency Power Supply), LPS-3 (Auxiliary Power Supply) and RB-3 (Adjustable Resistance Ballast). This system is applied to all kinds of fluorescent lamp such as 50Hz/60Hz T8/T12 or 25KHz T5 Tube test. The system is according to Double end fluorescent lamp adopts the IEC 60081 (GB/T10682) and the single-ended fluorescent lamp adopts the IEC60901 (GB/T17262), where in the standard of electricity parameters as in Fig 1

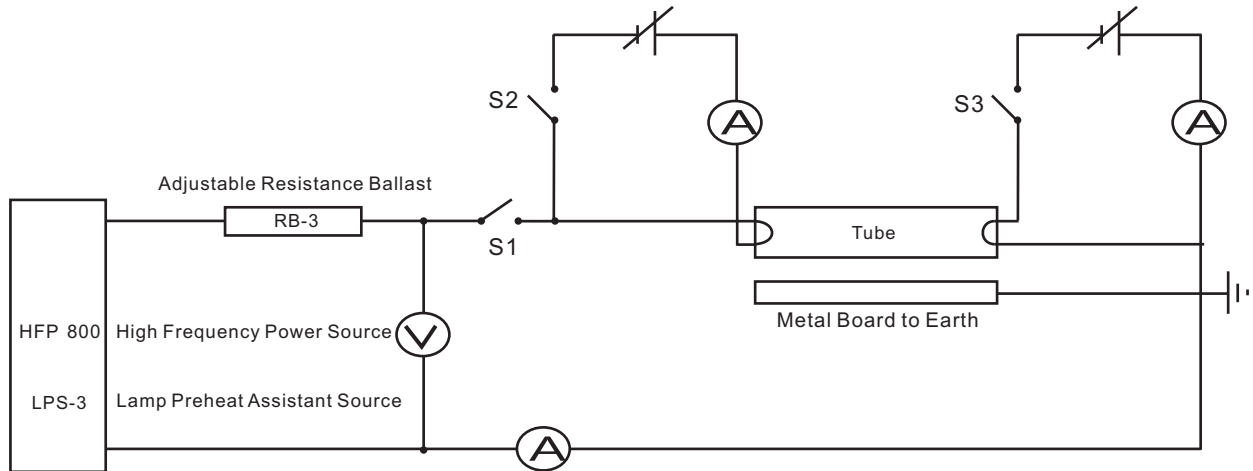



Fig 1 Preheating Method of Cathode High Frequency Fluorescent Lamp

- High Frequency Power Supply (HFP-800):**
 output frequency is 20~26kHz (meets the requirements of IEC 60081:1997), the frequency should be kept in the range of $\pm 2\%$ at working. Output Power Range is 10~600V (Adjustable). Range for output current: 0~0.600A. Range for output power: 0~300W



- Adjustable Resistance Ballast (RB-3):**
 impedance values of high frequency reference ballast which used by any high frequency lamp with regard to GB/T10682 (IEC 60081) and GB/T17262 (IEC60901), RB-3 conforms to the requirements of IEC60929 and ANSI C82.11. Available current range: 0~0.700A. Impedance range: 100~2047 Ω



- Lamp Preheat Assistant Source | Auxiliary Power Supply (LPS-3):** Preheating method of cathode during the high frequency fluorescent lamp starting. Adjustable pre-heat time for filament is 0~10.00s.



Adjustable Reference Ballast (DYJ-50HZ, DYJ-60HZ, DYJ-HID)

According to double end fluorescent lamp of IEC 60081 (GB/T10682), the single-ended fluorescent lamp of IEC60901 (GB/T17262), ANSI C78.81 and ANSI C82.3, DYJ Reference Ballast is used to test for 4W~85W fluorescent lamp and electronic ballast test.

Specification:

- Inductance: 0~1240Ω (adjustable)
- Inductance Power Factor COSφ: 0.075~0.120
- Resistance: 0~111Ω (adjustable)
- Current Range 0.150~0.670A (Imax: 1A)
- Order Code: DYJ-50HZ is for 50Hz lamp test and DYJ-60HZ is for both 50 and 60Hz lamps test.



According to IEC60188, IEC60662 and ANSI C82.5, Lisun Group developed the DYJ-HID Standard Ballast (Reference Ballast) to test the HID lamp, HID ballast, High-Voltage Mercury Lamp, High Voltage Sodium Lamp, Metal Halide Lamp and Halide Reactor. More information, please contact Lisun Group.

Adjustable High Frequency Reference Ballast (HCS-109A)

HCS-109A Adjustable High Frequency Reference Ballast also called High Frequency Current Source. Comparing to IEC Test Method, HCS-109A is an Equivalent Test Method which is economic solution. HCS-109A equipped with Spectrophotometer & Integrating Sphere Test System. It can also measure the photo, color and electricity parameters for high frequency fluorescent lamp.

Application:

- According to UL1993, HCS-109A is used to do input, temperature rise, leakage current and harmonic distortion test for LED Type A tube direct replacement fluorescent tube.
- According to GB/T 10682-2002 and IEC 60081:1997, HCS-109A is used to test the high frequency fluorescent lamp such as T5 tube (How to Measure the High Frequency Fluorescent Lamp), power frequency fluorescent lamp such as T8/T12 tube.

Specification:

- Input voltage: 200V~240V, 50/60Hz
- Input Power: 80 W max
- Output Current: 130mA~400mA (Adjustable)+/- 1%
- Output Frequency: 25kHz< +/-2.0% (Adjustable), accuracy: +/- 0.3kHz
- Output current total harmonic wave distortion: THD<2.5% (HF current wave)



Multiplex Temperature Tester (TMP-8, TMP-16)

Specification:

- 8 channels temperature signal(TMP-8) or 16 channels temperature signal(TMP-16)
- K type thermocouple
- Temperature range: -40~300°C. Testing accuracy: 0.5%
- Channel sequence is displayed by 2 LED and temperature is displayed by 4 LED
- Freely set up the software with PC and record the change of temperature and select the channel.



Multiway Life Tester (CH316)

Feature:

- Measure 16 samples at the same time, evaluate and record the life of each sample.
- Very flexible: Samples can be added and changed at anytime.
- The life of each sample is readable at anytime.
- The switch ON/OFF time is adjustable (Test period is min 1s).
- Automatically remember the test result when the power is off, and resume the old measurement when power is on.
- Sound and light alarm when the products were failed.



Specification:

- Current range (normal load): 30mA~1000mA (RMS). Invalid if the load current is smaller than 30mA.
- Tested sample life range: 0~1,000,000 times.
- Switch on or switch off time can be set at: 1 second~99 hours 59 minutes 59 seconds.

Digital Torsion Meter (CH338)

Digital Torsion Meter is mostly applied to measure the torque of all kinds of luminares lamp cap. The CH338 is a newly developed intelligent product with microprocessor built-in.

Specification:

- Range: 0~10N•m; Accuracy≤1%
- Repeatability≤0.5%FS; Over loading: 120%FS
- It can measure the clockwise and anti-clockwise torque of lamp cap and it can preset upper limit alarm. The data won't be lost after shutting down the instrument.
- Instrument is convenient to be used because it has several mating clamps of various lamp caps such as E27/E26, B22d, E14/E12, G13/G5 and so on.



"Go" and "Not Go" gauge (GNG-E27)

Specification:

According to the requirement of IEC60061, Lisun produced high accuracy and high quality "Go" and "Not go" gauge

- GNG-E27 is for E27 lamp cap standard source measurement. It includes 7006-27B-1, 7006-28A-1, 7006-27C-1, 7006-50-1, 7006-51A-2, 7006-51-2
- GNG-E27H is for E27 lamp holder standard source measurement. It includes 7006-25A-2, 7006-26-4, 7006-21-5, 7006-22A-4, 7006-22B-1, 7006-22C-1, 7006-22D-1
- GNG-E14 is for E14 lamp cap standard source measurement: 7006-27F-1, 7006-54-2, 7006-27G-1, 7006-55-2
- GNG-E40 is for E40 lamp cap standard source measurement: 7006-27-7, 7006-28D-1, 7006-52-1, 7006-53-1
- GNG-B22D is for B22d lamp cap standard source measurement: 7006-12-8, 7006-15-7, 7006-20-4, 7006-12A-2, 7006-12B-2, 7006-15A-2, 7006-13-5, 7006-17B-1
- GNG-B22DH is for B22d lamp holder standard source measurement: 7006-12A-2, 7006-12B-2, 7006-15A-2, 7005-10-8



EMI Receiver System (EMI-9KC, EMI-9KB, EMI-9KA)

EMI-9KB is an automatic EMI receiver system. It is a main test system for EMI (Electro Magnetic Interference) testing. The EMI-9KB is produced by the full closure structure and strong electro-conductibility material, which has high shielding effect. Due to the new technology for the EMI Test System, it solved the instrument self-EMI problem. The test results are according to the international format test report. The EMI Test System EMI-9KB fully meets CISPR16-1, GB17743, FCC, EN55015 and EN55022.

- Specification:**
- Detection frequency range: 9kHz~30MHz (EMI-9KA) or 9kHz~300MHz (EMI-9KB) or 9kHz~1GHz (EMI-9KC)
 - Frequency stability: 1×10^{-6}
 - Frequency resolution: (9kHz~150kHz) 30Hz; (150kHz~30MHz) 1kHz
 - Test Tolerance: $\pm 2\text{dB}$
 - Measure and detection method: PK, QP and AV
 - Measure range from 20dB μV to 140dB μV
 - Frequency scanning step length: 20Hz~2MHz
 - Sweep bandwidth: 200Hz; 9kHz; 120kHz
 - Connect PC via USB and software can be run Win7, Win8.



Magnetic Shielding Cabinet for EMI Testing (SDR-2000B)

The SDR-2000B and SDR-800S Magnetic Shielding Cabinet is designed according to GB/T12190:2006, GJB5792:2006, IEEE std299 and EN50147. The shielding cabinet is tested based 9K~100K>70db and 100K~300MHz>100db. The SDR-2000B and SDR-800S can work with EMI-9KA/EMI-9KB to reduce the testing load self or environmental EMI.



Specification:

Product Model	SDR-2000B	SDR-800S
Cabinet Shell	2mm Galvanized cold rolled steel sheet	
Cabinet Door	0.9*1.7m(L*H)	0.6*0.6m
Cabinet Window	0.3*0.3*0.025m (L*W*T) with 4mm hole	N/A
Power Supply Filter	30A/220V	30A/220V
Internet Line Filter	RJ-45	N/A
Cabinet Inside decoration	Ceiling and Wall are PVC, the ground is 10mm wooden plug 2mm zincification sheet	
Cabinet Inside Size	2*2*2m	0.8*0.8*0.8m
After Packing Size	2.2*2.3*2.3m	1*1.1*1.2m
After Packing Weight	800kg	200kg
Work with EMI-9KA/EMI-9KB	EMI-9KA/EMI-9KB, PC, Testing load and operator are put inside	Testing load is put inside to connect with EMI-9KA/EMI-9KB via BNC

Note: Other size Shielding cabinet can be designed according to customer's request

Electrostatic Discharge Simulator (ESD61000-2)



ESD simulator (Electrostatic Discharge Generator or Electrostatic Gun) is in full compliance with IEC 61000-4-2, EN61000-4-2, ISO10605, GB/T17626.2, GB/T17215.301 and GB/T17215.322. The ESD generator is designed for the assessment of electrical and electronic equipment to withstand ESD performance. ESD61000-2 /ESD61000-2A has LCD display in both English and Chinese, they are equipped with an infrared remote control which can allow you do the test in some special place.

Touch screen with super big LCD and built-in Windows CE

Specification:

Product Model	ESD61000-2	ESD61000-2A
Output Voltage	0.1~20kV±5%	0.1~30kV±5%
Polarity	Positive/Negative	Positive/Negative
Energy Storage Capacitance	150pF±10% (Replaceable)	150pF±10% (Replaceable)
Discharge Resistor	330Ω±5% (Replaceable)	330Ω±5% (Replaceable)
Current Rise Time	0.6~1ns	0.6~1ns
Testing Functions	Single, Count, 20pps, Air, Contact, IEC level	Single, Count, 20pps, Air, Contact, IEC level
Trigger Mode	MANUAL/AUTO	MANUAL/AUTO
Numbers of Discharge	1~9999	1~9999
Repetition	0.05s~99.99s	0.05s~99.99s
Working Power	AC220V(Option 110V)±10%, 50/60Hz	AC220V(Option 110V)±10%, 50/60Hz

EFT Immunity Measurement (EFT61000-4)

EFT immunity tester EFT61000-4 is specially designed according to the characteristics and requirements of EFT measurement and it is an ideal disturbance source of EMS measurement. They have fine performance, such as high stability, high reliability, easy to use and etc. It meets the standard requirements of IEC 61000-4-4, EN 61000-4-4, GB/T17215.301, GB/T17215.322 and GB/T17626.4. EFT61000-4 has LCD display in both English and Chinese.

Specification:

- Output voltage: 0~5000V
- Pulse frequency: 1kHz~1000kHz (Adjustable)
- Polarity: Positive, Negative or Positive/Negative, auto
- Source impedance: 50Ω±20% and 1000Ω±20%
- Rise time of a pulse: 5ns±30%
- Pulse width: 50Ω is 50ns±30%, 1kΩ is 35ns~150ns
- Burst duration: 0.01ms~20ms
- Burst period: 100ms~500ms, Test time: 1s~9999s
- Testing functions: Set test mode freely or IEC Level
- Coupling/Decoupling Network: Built-in 20A with 3 phases/5 wires
- Working Power: AC220V (Option 110V), 50/60Hz



Touch screen with super big LCD and built-in Windows CE

Surge Generator (SG61000-5)



Automatic lightning surge generator (or Lightning surge immunity) SG61000-5 is used to assess the power cord and connect the internal switch stood in line to connect the internal switch to provide a common basis for switching the natural world and lightning caused by the high-energy transient interference performance. It fully meets the IEC 61000-4-5, EN61000-4-5 and GB/T17626.5 standards.

Specification:

**Touch screen with super big LCD
and built-in Windows CE**

Product Model	SG61000-5	SG61000-5T	SG61000-5H12	SG61000-5H
Output Voltage (Open)	1.2/50 μ s \pm 20%	1.2/50 μ s \pm 20%	1.2/50 μ s \pm 20%	1.2/50 μ s \pm 20%
Output Current (Short)	8/20 μ s \pm 20%	8/20 μ s \pm 20%	8/20 μ s \pm 20%	8/20 μ s \pm 20%
Output Impedance	2 Ω	2 Ω	2 Ω and 500 Ω	2 Ω and 500 Ω
Output Voltage Range	0~6KV \pm 10%	0~6KV \pm 10%	0~12KV \pm 10%	0~10KV \pm 10%
Output Current Range	0~3KA \pm 10%	0~3KA \pm 10%	0~6KA \pm 10%	0~5KA \pm 10%
Surge Repetition	1~9999 times	1~9999 times	1~9999 times	1~9999 times
Interval Time	20~9999s	20~9999s	20~9999s	20~9999s
Polarity	Positive, Negative or Positive/Negative automatic			
Phase Shift	Asynchronous, Synchronization 0 $^{\circ}$ ~ 360 $^{\circ}$ or Specific Angle			
Coupling/Decoupling Network (CDN)	Includes a 16A single phase CDN	Includes a 20A 3phases CDN	Includes a 30A 3phases CDN	Built-in 20A 3phases CDN
Package Size/ Gross Weight	44x45x35cm About 30kg	44x45x55cm About 48kg	56x69x165cm About 300kg	56x69x155cm About 270kg

Impulse Withstand Voltage Tester (SUG255LX, SUG255PX)

The Impulse Withstand Voltage Tester (or High Voltage Surge Generator) is designed according to IEC255-5, IEC60060, GB14711, GBT17215.301 and GBT17215.322. It is suitable for doing all kinds of electrical and electronic products insulation performance test.

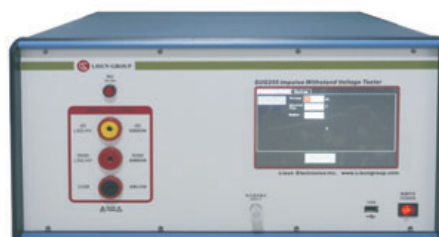

Specification:

Product Model	SUG255LX	SUG255PX
Voltage Output Waveform	1.2/50 μ s	1.2/50 μ s
Range of Output Voltage	0~12kV	0~12kV
Polarity of Output Voltage	Positive or Negative	Positive or Negative
Impedance of Generator	12 Ω and 500 Ω	2 Ω and 500 Ω
Operation Mode	Manually or Automatic	Manually or Automatic
Test Repetition	1~9999	1~9999
Interval Time	3~9999s	3~9999s

Voltage Dips and Interruptions Generator (CSS61000-11)

The voltage dip and interruptions generator is specially designed according to the characteristics and requirements of EMS measurement under a sudden reduction or interruption of the voltage at a point, CSS61000-11/ CSS61000-11T used a big LCD in both English and Chinese operating interface. They have more fine performance such as high reliability, convenient operation, and fully meet the standard requirements of IEC 61000-4-11, EN 61000-4-11 and GB/T17626.11



Touch screen with super big LCD and built-in Windows CE

Specification:

Product Model	CSS61000-11	CSS61000-11T
Wave Generator	AC Sine Wave	AC Sine Wave
Range of Voltage Variations	0~110% of 220V	0~110% of 380V
IEC Level Build-in	100%, 80%, 70%, 40%, 0%	100%, 80%, 70%, 40%, 0%
Dip Phase Set	0°~360°(1° Step)	0°~360°(1° Step)
Duration Time of Voltage Variation	0.5~9999.5T	0.5~9999.5T
Internal Time of Voltage Variation	1s~9999s	1s~9999s
Voltage Dip Count	0~9999 times	0~9999 times
Operating Mode	Automatic Dip	Choose 1 to 3 phases to automatic dip at the same time
Trigger Mode	Manual, Auto and 50ms	Manual, Auto and 50ms
Power Capacity For EUT	Single Phase AC 220V±10%, 16A max	3 Phase AC 380V±10%, 20A max
Working Power	AC220V(Option 110V)±10%, 50/60Hz	
Dimension (DxWxH)	44x45x90cm	56x58x130cm
Gross Weight	About 90kg	About 150kg

RF Conducted Immunity Test System (RFCI61000-4-6)

RFCI61000-4-6 RF Conducted Immunity Test System is an automatic test system which is for the conduction sensitivity testing, it fully meets IEC61000-4-6.2006, ISO11452-4

Specification:

- Main Instrument: Programmable signal source and 20 w linear power amplifier
- Attenuator: 50W/6dB(50Ω)
- Coupling/decoupling network : CDN (RFCI61000-4-6CDN) or EM (RFCI61000-4-6EM)
- Cable Jumper: One meter N-N(50Ω)and one USB
- Frequency range: 150K~230M;
- Calibration for continuous wave: 1V(120dBμ), 3V(130dBμ), 10V(140dBμ);
- 80% AM radio frequency modulation signal (modulation frequency is 1k) when testing;
- Frequency step: Segmentation step, specific steps as below: 150K~1M(10K), 1M~30M(1M) and 30M~230M(10M), the proportion step (1%~100% adjustable);
- Dwell time: 1s~120s (adjustable);
- Output power error: ±1dB



Magnetic Field Generator (PFM61000-8A)

PFM61000-8A Magnetic Field Generator is high reliability test equipment with stable performance, specially designed for electrical and electronic products for measuring immunity characteristics and requirements of normal frequency magnetic fields. It fully meets IEC61000-4-8 and GB / T17626.8 standards.

Specification:

- LCD display, built-in PC for controlling, easy to operate.
- Freely set the time of current injection and interval, and the time of test.
- Intelligently acquire current, voltage and magnetic field strength, all the parameters will be showed on the LCD display.
- Magnetic field coil: 1 square meter (others can be customized)
- Magnetic field strength: 0A/m~1000A/m continuously adjustable
- Output Current: AC
- The time of test: 999 times
- Test of interval: 1~99min
- Current injection time: 1s to 99min
- Current distortion rate: <5%
- Work mode (current range for continuous working): 1A~100A
- Work mode (current range for short-time working): >100A~500A is 1~5s and >500A~1000A is 1~3s
- Methods of operation: manual, semi-automatic, automatic
- Power supply: AC220V 50/60Hz
- Working environment temperature: 15°C-35°C



Ring Wave Generator (RWG61000-12)

Ring Wave Generator is the test equipment in conformity to IEC61000-4-12, EN61000-4-12, ANSI-C62-41. This instrument is used for the simulative electrical network, the power supply of the reactive load and the control line switch, as well as sensing the ring wave of the low voltage cables terminal equipment caused by the disconnection of the power circuit, fault and insulation breakdown or lightning stroke. The RWG61000-12 series products have LCD display in both English and Chinese.



Touch screen with super big LCD and built-in Windows CE

Specification:

Product Model	RWG61000-12	RWG61000-12T	RWG61000-12A	RWG61000-12AT
Output Voltage	0~4KV		0~6KV (Special Order)	
Voltage/Current Wave	Open circuit voltage wave: frontier: 0.5 μ s \pm 20%. Short circuit current wave: frontier: \leq 1 μ s. Oscillation frequency: 100kHz \pm 10%			
Polarity	Positive, Negative or Positive/Negative automatic			
Phase Shift	Asynchronous, Synchronization 0 $^\circ$ ~360 $^\circ$ or Specific Angle			
Output Impedance	12 Ω , 30 Ω			
Coupling/Decoupling Network (CDN)	Includes a 16A single phase	Includes a 20A 3phases/5wires	Includes a 16A single phase	Includes a 20A 3phases/5wires
Working Power	AC220V(Option 110V) \pm 10%, 50/60Hz			
Dimension (DxWxH)	44x45x35cm	44x45x20cm 44x45x35cm(CDN)	44x45x30cm 44x45x20cm(CDN)	44x45x30cm 44x45x35cm(CDN)
Gross Weight	About 28kg	About 46kg	About 45kg	About 48kg

Order Noted:

1. The RWG61000-12 can be assembly with SG61000-5 in one unit to down the cost
2. The 0~6KV Ring Wave Generator is special designed according to the customer's request

Three Loop Antenna (VVLA-30M)

Specification:

- The three loop antenna VVLA-30M is a standard measurement antenna according to CISPR15-2005. it can coordinate LISUN GROUP EMI- 9KB, EMI-9KA EMI Receiver System for EUT magnetic field radiation test measurement between X, Y and Z planes
- Frequency range: 9KHz ~30MHz
- It can switch between X, Y and Z planes
- The sensor coefficient of current probe is 0dB
- Impedance: 50 Ω /BNC
- The antenna Ring diameter: 2m
- The volume of antenna: 2.4*2.4*2.5m
- It can provide non metal base with various heights (capacity is 6kg)
- No need to move EUT or loop during measurement process
- The shielded room influence on the test result is greatly reduced
- Interference in open area test environment is greatly reduced



Electronic Ballast Tester (WT5000)

WT5000 has LCD for displaying waveforms and parameters directly. Reports can be printed if printer is connected. It also meets the latest requirements for electronic ballasts in international standards IEC 60929, IEC 60969, IEC 61000-3-2.



Specification:

- WT5000 has expanding analysis for envelope wave
- Communicate the PC via RS-232, the English software can be run in Win7, Win8 and Win10
- Input Parameters Measurement:
 - 1) Test voltage, current, power, power factor, power net frequency, total harmonic and 0~39 harmonic.
 - 2) Range of voltage and current basic wave frequency: 45Hz~65Hz:
 - 3) Range of voltage: 10.0~300.0V (virtual value); Range of power: NR: 0~450.0W; WR: 0~999.9W
 - 4) Range of current: NR: 0.010~1.500A (virtual value); WR: 0.010- 4.500A (virtual value)
 - 5) Range of power factor: 0.000~1.000
- Output Stably Parameters Measurement:
 - 1) Test lamp voltage, current, power, filament current, input cathodic current, crest factor, frequency
 - 2) Range of lamp voltage: 10.0~300.0V; Range of lamp power: NR:0.5~200.0W, WR:0.5~400.0W
 - 3) Range of lamp current, filament current, cathodic current: NR:0.010~0.750A; WR:0.010~1.500A
- Output Startup Parameters Measurement:
 - 1) Test preheats time and lamp voltage, current, filament current, changing curve and data of input cathodic current within 0 to 5s.
 - 2) Range of lamp voltage: 10.0~800.0V; NR: 0.010~0.750A, WR: 0.010~1.500A
 - 3) Range of lamp current, filament current and input cathodic current:

HID Ballast Tester (WT2000-HID)

Specification:

- Test voltage, current, power, power factor, power line frequency, total harmonic and 0~50 harmonic
- Range of voltage and current basic wave frequency: 45Hz~65Hz;
- Range of narrow frequency: 45Hz~5kHz;
- Range of wide frequency: 45Hz~1MHz;



Electronic Ballast Automatic Test Equipment (ATE-1)

Specification:

Test series connection, parallel connection and series/parallel connections of the electronic ballast (about 15 kinds of connections), available for various electronic ballast.

- With a precise resistance box, tube is substituted for the resistance, can act as many as 6 tubes. Resistance value: 1~4095Ω adjustable.
- Measure input parameters (vrms, irms, W, PF, harmonics, etc), output parameters (on-circuit voltage, lamp voltage, filament voltage, lamp current, lamp power, oscillatory frequency), can also test the ballast efficiency, abnormality protection, and power symmetry of partial rectifier effect and etc.
- Program controlled AC power source to guarantee the smart choice of input voltage and the frequency.
- Equipped with 17 inch LCD controlled machine, specially designed A/D combined with special CPU, has the two left and right testing interfaces to achieve stability of data and high-speed testing.
- Communicate the PC via RS-232, English software can be run in Win7 and Win10



Glow-wire Test Apparatus (ZRS-3HS, ZRS-3H)

It is designed according to IEC60695-2-1, IEC60695-2-10, IEC60695-2-13 (GB/T5169.10-2006~GB/T5169.13-2006), < basic testing methods of glow wire device> and UL 746A, IEC829, DIN695, VDE0471, the glow wire tester ZRS-3H is suitable for resistance to abnormal heat and fire test on lighting lamps, electronic products and household appliances. Adopting high-temperature coating spraying on steel structure and imported instrument display, with easy operation, stable performance. The equipment is applicable to flame resistance tests of all levels of QC departments and corresponding enterprises.

Note: The ZRS-3HS Gross weight is 50kg and package size 80*70*50cm

Specification:

- Thermocouple diameter: 1mm K type, import insulated thermocouple which can endure high temperature, and it can endure about 1100°C (superior to standard 1050°C)
- Heating temperature: adjustable continuously within the range of $\leq 500\sim 1000^{\circ}\text{C}$, the accuracy of temperature is 1°C , the resolution of temperature is $\pm 3^{\circ}\text{C}$.
- Glowing time: $0.1\sim 999.9\text{s}\pm 0.1\text{s}$ (time range is adjustable).
- Burning time: $0.1\sim 999.9\text{s}$, auto record, manual pause.
- Flame chilling time: $0.1\sim 999.9\text{s}$, auto record, manual pause.
- Glow wire pressure on test specimen : $1\pm 0.2\text{N}$. Limit pressure depth is 7mm.
- Glow wire: 80%Ni, 20%Cr and made in specific dimensions.



Compact Version



Touch Screen Version

Needle Flame Test (ZY-3S, ZY-3)

According to IEC60695-2-2 and IEC60695-11-5, ZY-3 Needle Flame Test is applied in the production and quality control department of lighting instrument, hyperpiesia electrical apparatus, domestic appliance, machine electric appliance, electrical machine, power tool, electronic instrument, electrician instrument and technical equipment. Also, it is fit for the industry of insulation material, engineering plastics and solid combustible material.

Note: The ZY-3S Gross weight is 50kg and package size 80*70*50cm

Specification:

- Angle of burner: incline with 45° (when in test) / plumb(when adjust the flame's height)
- Time of start burning: $0\sim 999.9\text{s}\pm 0.1\text{s}$ adjust (30s in general)
- Time of keep burning: $0\sim 999.9\text{s}\pm 0.1\text{s}$, auto record, manual pause
- Height of flame: $12\text{mm}\pm 1\text{mm}$ (test tool with height, adjustable)
- Burning air: 95% of butagas
- Test range of temperature: $0\sim 1000^{\circ}\text{C}$
- Requirement of flame's temperature: within 23.5 seconds $\pm 1\text{s}$ when the temperature rises from $100^{\circ}\text{C}\pm 2^{\circ}\text{C}$ to $700^{\circ}\text{C}\pm 3^{\circ}\text{C}$
- Temperature testing thermocouple: $\Phi 0.5\text{mm}$ K pattern thermocouple



Compact Version



Touch Screen Version

Horizontal Vertical Flame Tester (HVR-LSS, HVR-LS)

This equipment meets the requirements of ANSI/UL94, IEC60950-1, IEC695-2-2 and GB. It is used to test the appliances and plastic materials parts of electrical equipment for the horizontal, vertical flammability test. The product tank shell is iron spray, and configured a transparent viewing window, the digital meter shows the burning time, after flame time, afterglow time. This device has beautiful appearance, is easy to use and has reliable performance.

Note: The HVR-LSS Gross weight is 50kg and package size 80*70*50cm

Specification:

- Burning Time: 0~999.9S(Adjustable), After flame Time: 0~999.9S(Adjustable), After-blanch Time: 0~999.9S(Adjustable)
- Burning Angle: 0°, 20°, 45° and optional, Flame Height: 20mm~175mm (Adjustable)
- Gas Flow: 0.03~0.3ml/Min, Gas Pressure: 0~16Kpa pressure gauge ±200mm spout
- Burning Lamp: Internal tube diameter: 9.5±0.3mm, Length:100mm±10mm
- Time Device: It can be accurate to 0.5S, Linear Measure: In millimeter
- Pressure Gauge: It can measure 0.2m water, taking 5mm as the increment.
- Flow Meter: The maximum measurement accuracy is ±2%
- Position Adjustment: Sample clamp bracket can be up and down, left and right controlled.



Compact Version



Touch Screen Version

Hot Wire Ignition tester (RSY-LT)

Hot wire ignition tester is designed according to the standard requirement of IEC60695-2-20 and GB4943, which meets Standard Test Method for Ignition of Materials by Hot Wire Sources. It is suitable for electric and electronic products, household appliance materials to do ignition dangerous test. It simulates the heat source or ignition source of simulates glow component and overload resistance which may cause thermal stress in a short time

Hot-wire coil ignition test adopts the specific size (Dia: 0.5mm; Length: 250mm) and specific material (Ni80/Cr20) of heater strip which is pre-annealed with required heating power (0.26W/mm) and specified time (8s~12s). Then coil heater strip on the specimen for 5 cycles according to certain wire wrapping tension (5.4N) and certain wire wrapping distance (6.35mm). Then take the specimen with wrapping heater strip to test until 120s under the stipulate heating power (0.26W/mm). The users can judge the fire risk according to the specimen ignite and the ignite time.

Specification:

- It is designed according to IEC60695-2-20 and GB4943
- Heating coil: ϕ 0.5mm, Ni80/Cr20, Length: 250mm±5mm, Cold Resistance: 5.28Ω/m, Anneal holder. Distance: 250mm
- Specimen holder distance and height: 70mm, Height: 60mm (The distance from stand surface to the connector plate surface)
- Wire wrapping tension and its distance: 5.4N±0.05N, 6.3mm±0.2mm (within 31.5mm±0.5mm, coil 5 cycle, national standard is 6mm)
- Annealing time and power: 8s~12s (Digital display can be preset). 0.26W/mm±4%(Digital display is adjustable)
- Testing time and power 120s (1s~999.9s Digital display can be preset), 0.26W/mm±4%(Digital display is adjustable)
- Specimen size:
L×W×H: (125±5)×(13.0±0.5)×(0.75+0.075)mm, 1.5+0.150mm, 3+0.30mm national standard 0.75±0.1 mm, 1.5±0.1 mm, 3±0.2 mm
- Combustion box volume is bigger than 0.5 cubes(other sizes can be optional)



Tracking Test Chamber (TTC-1)

It fully meets IEC60695 and IEC60112 (Gb4207) and the Tracking Test Chamber TTC-1 is intended for determining the degree of protection against formation of conducting paths in solid insulating materials, due to the electric stress and electrolytic contamination of the surface. This method simulates tracking currents on insulation material by providing drops between electrodes. During the process of normal use, insulating material may be exposed to moisture and dirt, if conductive, may cause stress and fire hazard.

Specification:

- It applied with rectangle size of platinum electrode, each electrode can force to the sample is $1.0 \pm 0.05N$
- The testing voltage is 100~600V (48~60Hz) which can be adjustable
- When the short-circuit current in the $1.0 \pm 0.1A$, the voltage drops will be no more than 10%
- During the testing, the short-circuit current is more than 0.5 A to keep 2 seconds, then shut off current, it will show the sample not pass
- The liquid drop device can make the liquid height from 30~40mm (adjustable), drops liquid size is 44~55 drops/ $1cm^3$. The interval drops of liquid is 30S $\pm 5S$ (adjustable)
- Inside dimension: 800x800x800mm and outside dimension: 1120x520x1250mm (Special size can be ordered as customer's request)



Touch Screen Version

Temperature Meter for Lamp Caps & Luminaires Test (TMP-L)

TMP-L fully meets IEC60360-1998 and GB2512-2001 (Standard method of measurement of lamp cap temperature rise). It is used to test the working and environmental temperature as well as temperature-rise of the burner and lamp. It meets the requirement of IEC and GB Standards

Specification:

- Channel sequence is displayed by 2 LED and temperature is displayed by 4 LED; Simultaneously display temperature rise curve
- Sensor: K type thermocouple and 8 channels for input temperature signal
- Temperature range: $-40 \sim 300^{\circ}C$ and testing accuracy: Class 0.5
- Capable of circle monitoring, single monitoring, printing and RS-232 communication with PC
- Freely set up for channel sequence when circle monitoring
- Application software in Windows can track the changing of the selected channel temperature and provide print and save operation
- Dimension of standard testing box: 90*90*90cm (inner box) and 105*105*120cm (outer box), or customized; Lamp holder: E14, E27, E40, B22d and other holders



Automatic Safety Test System (LS9955)

The LS9955/LS9956 Automatic Safety Test System fully meets GB4706.1, IEC/EN60335-1, UL60335, GB7000, IEC60598, GB4943, IEC60950 and GB9706.1 standard. It is used for luminaries, home application and motor tools safety test in production line or Lab R&D.



Specification:

- Include the handle to do remote operation
- Display all setting parameters and testing results in the same big LCD menu
- It can set the PASS/FAIL limit value. It has light/noisy to warn
- Test mode programmable; Quick discharge, 50 memory groups, 8 steps per group
- Support 50Hz and 60Hz frequency; Electric safety wall detecting feature
- The LS9955 can do test for Withstand Voltage (AC/DC), Insulation Resistance (IR), Leakage Current (LLC) and Ground Resistance (GR)
- The LS9956 can do test for Withstand Voltage (AC/DC), Insulation Resistance (IR), Leakage Current (LLC), Ground Resistance (GR) and Power

Withstand Voltage Test (AC/DC)			Insulation Resistance Test (IR)		
Voltage Range	Accuracy	Current Range	IR Range	Accuracy	Voltage Range
100~4000V	±(5%+3V)	0.02~12.00mA	0.50~500MΩ	5%+0.5MΩ	DC100~1000V
Leakage Current Test (LLC)			Grounding Resistance Test (GR)		
LLC Range	Accuracy	Voltage Range	GR Range	Accuracy	Output Current
0.01~20mA	±(0.3%+5uA)	AC10.0~300.0V	0~600mΩ	±(5%+2mΩ)	AC1.00~30.00A
Power Test					
Voltage	Current	Power	PF	Accuracy	Test Time
10.0~300.0V	0.010~20.00A	1.0~6000.0W	0.2~1.0	Class 0.5	0~999.9s

Programmable Withstanding Voltage & Insulation Test (LS9923)

The LS9923 is a high-performance testing device special for AC & DC Withstanding Voltage and Insulation Resistance Test, It allows setting the output voltage. The warning value, testing time and some other parameters can be set in the screen. It has a variety of automatic test functions. The testing is quick and high accuracy which is not only applied in the production line but also in the lab developing research.



Withstanding Voltage	Output Voltage Range	AC/DC Max 5.00KV
	Output Voltage Accuracy	±(2%+3bits)
	Breakdown Current Range	AC/DC: 0.10~12mA
	Test time	0~999.9s
Insulation Resistance	Output frequency	50Hz/60Hz
	Output Voltage Range	DC Max 1.00KV
	Output Voltage Accuracy	±(2%+3bits)
	Insulation Resistance Range	1.0~2000MΩ
Insulation Resistance Accuracy	±(5% +3bits) <100 MΩ and ±(10% +5bits) >100 MΩ	
Test time	0~999.9s	

High & Low Temperature and Humidity Chamber (GDJS-015A, GDJW-010A)

The High&Low Temperature and Humidity Chamber is designed according to the IEC60068-2-1. It fully meets the test requirement of CFL/LED lamps , electricity products, electronic components, material ect.

Specification:

- The chamber is produced by SUS304 Steel, the Insulation material is produced by Polyurethane hard foam and ultra-fine fiber glass. Using double-deck aging silicone rubber door sealing strip to insulate the high temperature steam.
- The controller is English and can communicate with PC.
- The temperature accuracy is 0.1°C and humidity is 0.1%R.H
- The temperature sensor is PT100 Ohms/MV resistor
- The humidity sensor is Finland brand electronic hygrometer.
- The heating system is full separately system which produced by Nickel chromium alloy electric heating type heater
- The cold system is applied by fully enclosed fan cooled single-stage and cascade refrigeration mode, the compressor is from France TECUMSEH brand which allow you get after sales support from local country.
- Include the water pure system which allows you to connect to your
- The cyclical system is applied by low noise motor and Multi centrifugal wind wheel blade
- The self-protection function include Electric leakage, short circuit, over temperature, motor overheating, compressor pressure, overload, over-current protection and lack water alarm



High & Low Temperature and Humidity Chamber with Programmable Function (GDJS Series)

Model (cm)	GDJS-225*	GDJS-500*	GDJS-010*	GDJS-013*	GDJS-015*
Workroom Dimensions	50*60*75	70*80*90	100*100*100	100*100*130	100*100*150
Exterior Dimensions	105*102*200	132*132*217	167*152*231	217*152*231	245*160*231
Work Power	7.0kW	13.5kW	15.0kW	16.5kW	16.5kW
Temperature Range	A: 20°C~150°C B: 40°C~150°C C: 60°C~150°C				
Humidity Range	30%~98% R.H				
Fluctuation/Evenness	±0.5°C/±2°C				
Humidity Deviation	2%~ 3% R.H				
Temperature Rise Speed	1.0~3.0°C/min				
Temperature Fall Speed	0.7~1.0°C/min				

High and Low Temperature Chamber with Programmable Function (GDJW Series)

Working Room Size	GDJW-225*	GDJW-500*	GDJW-010*	GDJW-013*	GDJW-015*
Workroom Dimensions (cm)	50x60x75	70x80x90	100x100x100	100x100x130	100x100x150
Temperature Range	A: -20°C~150°C B: -40°C~150°C C: -60°C~150°C				
Fluctuation/Evenness	±0.5°C/±2°C				
Temperature Rise Speed	1.0°C~3.0°C/min				
Temperature Down Speed	0.7°C~1.0°C/min				

The * in GDJS-225* means the temperature range A: -20°C~150°C, B: -40°C~150°C, C: -60°C~150°C

Waterproof Test (JL-X)

JL-X waterproof test system is designed according to IEC60529, IEC60598, IEC60335 and IEC 60034-5. The JL-X includes the following test grades: IPX1, IPX2, IPX3, IPX4, IPX5, IPX6, IPX7 and IPX8 (Refer to page 51 of IEC60529). It is widely used in the authentication test organization for the products waterproof test such as electrical & electronic products.



JL-34



JL-56



The whole JL-X waterproof test system includes:

- **Drip Box (JL-12)**: The drip box is for IPX1 and IPX2 drip test. The drip box size is 800x800x75mm (LxWxH). The diameter of drip hole is 0.4mm, distant between each drip hole is 20mm, sample can be over 150kg
- **Swing Pipe Water Spray Test Equipment (JL-34)**: It is for IPX3 and IPX4 test, the semi-diameter of swing pipe is 1meter. IPX3 is 120degree and IPX4 is 180degree. The diameter of inside swing pipe is 0.4mm. The automatic sample rotating table's diameter is 600mm and speed is 1~5rpm which be controlled by PLC
- **Waterproof Jet Test Device (JL-56)**: With water supply device size is 1000x1000x600mm, the bore diameter is $\phi 6.3\text{mm}$ (IPX5) and $\phi 12.5\text{mm}$ (IPX6). Diameter of hole is 6.3mm for IPX5 and 12.5mm for IPX6. The water speed is $12.5 \pm 0.626\text{L/min}$ for IPX5 and $100 \pm 5\text{L/min}$ for IPX6.
- **Immersion tank Waterproof test Device (JL-7)**: It is for IPX7 test. The top of the water tank size is 1000x1000x1200mm. The sample testing base is max 120kg.
- **Immersion tank Waterproof test Device (JL-8)**: It is for IPX8 test. It can measure 0~50m water depth. The water immersion size is diameter is 600mm and height is 1200mm, the compressive stress is 10 atmospheric pressures or design customer request

High Temperature & Pressure Jet Waterproof Test Chamber (JL-9K1L)

JL-9K1L High Temperature & Pressure Jet Waterproof Test Chamber is designed according to IEC60529, GB4208, DIN40050-9 and ISO20653 for protection level IPX9K testing. It is a waterproof test machine designed for vehicle spare parts, electrical and electronic industry, to simulate natural environment or human factors.

The both interior and exterior material of this chamber is high quality stainless steel, big glass observation window and elegant appearance. The turntable and spray lance motor adopt imported motor, rotation speed can be adjusted according to requirement. .



Specification:

- Working Chamber: 1000*1000*1000mm
- Test time: 30s (Pre-settable and adjustable)
- Angle of Water Ring: 0°, 30°, 60°, 90°(The testing angle can be adjusted)
- Testing table: Load bearing 15kg/Φ400~500mm
- Based on horizontal line, distribute nozzle hole at anticlockwise±0°±30°±60°±90°with valve on nozzle
- Water Temperature in Tank: 80±5°(Adjustable, enhanced temperature and water overflow protection)
- Spraying distance: 100mm~200mm and can be adjustable nozzle distance by manual
- Spraying pressure: 8000~10000kPa (81.5~101.9kg/cm²)
- Electrical high temperature flow meter: Flow is 14~16 L/min
- Rotation speed of testing table: 5~17r/min (Motor drives turbine slow rotating, control speed and adjust to appropriate speed by frequency converter)

Aging and Life Test Rack (SY2036)

Specification:

- Input Power supply: AC220V, 50/60HZ, 12KVA Min (110V is option)
- Built-in transformer: 0-250V 5KVA and 0-300V 5KVA (Other power is option)
- Maximum power for EUT: 5KVA and 12A (Other power is option)
- EUT and Number: 112pcs B22, 112pcs E27. 36pcs T5/T8/T12 Tube. 32pcs LED panel (Other EUT can be designed according to customer request)
- ON/OFF test: Can be set on the touch screen with program
- Test number: 0~99999(Adjustable)



The aging rack can be special designed according customer's request

Dustproof Testing Machine (SC-015)

The Dustproof Test Chamber SC-015 is designed according to IEC60529, GB2423.37-89 (Test L: dust test methods), GB 4208-93 protective casing grade (IP code), GB/T 4942.2-93(protective casing grade of low-voltage apparatus), GB 7000.1-1996, GB 7001-1986(protective casing grade of lamps), DIN40050 and IP5K0. The SC-015 is applied in LED or other luminaires IP5X and IP6X test.

Specification:

- Temperature Range: environmental temperature +5~50°C (Adjustable)
- Standard metal net line diameter: 50µm
- Test dust: dry talcum powder, portland cement, smoke ash and etc.
- Metal net diameter: 75µm
- Dust selection: Use french chalk which can pass the metal net. Need replace the dust after 20 times test. And add 2kg/m³ each time.
- Have a flow meter and press meter to adjust the flow meter of the vacuum pump. Can run the IPX6 test.
- Power supply: 380V 3phases 50Hz/60Hz



Model Number	Working Room Size (mm)	Remark
SC-500	600*700*800	Single door structure
SC-800	800*800*800	
SC-010	1000*1000*1000	
SC-015	1000*1500*1000	Cabinet can be put in a horizontal direct or vertical direct
SC-020	1000*2000*1000	

IK Level Tester (IK07-10)

Most of the luminaires manufactories are requested to do IK level test (Impact Protection). LISUN can supply the IK test instrument from IK01-10.

IK ratings are defined as IKXX, where "XX" is a number from 00 to 10 indicating the degrees of protection provided by enclosures (including luminaires) against external mechanical impacts. The different IK ratings relate to the ability of an enclosure to resist impact energy levels measured in joules (J). IEC 62262 specifies how the enclosure must be mounted for testing, the atmospheric conditions required, the quantity and distribution of the test impacts and the impact hammer to be used for each level of IK rating. The IK application on lighting luminaires testing is according to IEC60598 (GB7000) and IEC60068-2-75 (GB2423.55).

Degrees of protection against external mechanical impacts:

IK01	IK02	IK03	IK04	IK05	IK06	IK07	IK08	IK09	IK10
0.14J	0.2J	0.35J	0.5J	0.7J	1J	2J	5J	10J	20J



IK01-06 Spring Impact Hammer

Salt Spray Test Machine (YWX/Q-010)

The Salt Spray Test Machine/Chamber is applicable to the salt spray corrosive test for the protection level of components, parts, electronic and electrical parts and metal materials and industrial products.

Specification:

- The Salt Spray Test Machine is made of transparent materials so that the operator can see the tested sample in it and the spraying situation.
- A waterproof structure is adopted between the chamber cover and chamber body, thus there is no salt spray overflow.
- Can do continuous test and cycle test.
- It meets the following standards: IEC60068-2-11(GB/T2423.17), GB/T10125, ISO9227, ASTM-B117, GB/T2423-18, IEC 60068-2-52, ASTM-B368, MIL-STD-202, EIA-364-26, ASTM-B117, GJB150, DIN50021-75, ISO3768, 3769, 3770; CNS 3627, 3885, 4159, 7669 etc.



Model	Work Room Size (mm)	Exterior Size (mm)	Voltage	Power (kW)
YWX/Q-150	600*450*400	1100*750*930	1Phase/220V	2.5
YWX/Q-250	900*600*500	1500*900*1150	1Phase/220V	3.5
YWX/Q-750	1100*750*500	1700*1050*1150	1Phase/220V	4.5
YWX/Q-010	1200*800*500	1800*1100*1200	3Phase/380V	6.5
YWX/Q-016	1600*900*600	2300*1300*1300	3Phase/380V	9.5
YWX/Q-020	2000*1000*600	2700*1400*1500	3Phase/380V	11

Electrodynamic Vibration Generator System (LVD-100KG-6D)

Electrodynamic Vibration Generator System is complied with IEC 60068, IEC68-2-6, JJG189-97, GB/T13309-91, IEC60598 and GB2423 etc.

- LVD-100KG: Vibration table combined vertical table and horizontal table in one set
- LVD-100KG-6D: Vibration table combined vertical table and two directions horizontal table in one set

Specification:

- Sine Wave, Frequency Modulation, Sweep Frequency, Programmable, Frequency Doubling, Logarithm, High Acceleration speed, Amplitude Modulation, Time Control, Full function Computer Control, simple and easy to set the acceleration and amplitude.
- Vibration table size: 500*500mm (Other size can be designed)
- Vibration: 0~5mm (Adjustable range P-P). Vibration waveform: sine wave (half wave and full wave). Acceleration speed: 0~20g (Adjustable)
- Maximum test load Capacity: 100kg
- Accuracy: Frequency can be displayed to 0.01 Hz. Precision 0.1 Hz
- Sweep Frequency function (1~600Hz): (Upper frequency, Lower frequency, Time range) It can set real standard arbitrarily to sweep frequency back and forth



UV Lamp Aging Chamber (UV-263LS)

UV lamp aging test Chamber is designed for evaluating the resistant performance of non-metallic materials, organic materials (plastics, paints, coatings, rubbers, etc.) under the specified conditions such as sunlight, temperature and other climatic conditions. The chamber fully complies with the requirements of Standard ISO 4892-1, ISO 4892-3, ASTM G53 and etc.

Specification:

- Temperature range: RT+40°C~70°C, Temperature uniformity: $\pm 1^{\circ}\text{C}$
- Temperature fluctuation: $\pm 0.5^{\circ}\text{C}$, Humidity range: $\geq 90\% \text{RH}$
- Irradiance is $1.0 \text{W}/\text{m}^2$ (adjustable) and Effective area is $900 \times 210 \text{mm}$
- Temperature of irradiation blackboard: $50^{\circ}\text{C} \sim 70^{\circ}\text{C}$
- Include 8pcs UVA lamps: L=1200mm, 40W and life $\geq 2000 \text{hrs}$
- Sink depth: 25mm and auto control
- Testing time: 0~999H (adjustable)
- Distance between lamps is 70mm, sample to lamp is $50 \pm 3 \text{mm}$
- Standard sample size: $75 \times 290 \text{mm}$, Standard sample holder: 24 inches



Xenon Lamp Aging Test Chamber (XD-80LS)

Xenon lamp aging test Chamber adopts xenon arc lamp which can imitate the full spectrum of sunlight to reappear destructive spectral wave that exists in different environment. It is designed according to standard ISO 4892-1, ISO 4892-2, GB/T16585-1996, GB14522-93, GB/T16422.3-97, D2565 ASTM D2565 and etc.

Specification:

- Working Room size: $400 \times 400 \times 500 \text{mm}$ (W*D*H)
- Temperature range is $0^{\circ}\text{C} \sim 80^{\circ}\text{C}$ with tolerance is $\pm 2^{\circ}\text{C}$
- Humidity range is 30~98% with tolerance is 2.5%
- The air cooling type long arc xenon lamp with full solar spectrum
- Xenon lamp wavelength: 290~800nm, Power: 1.8kW, Life: 1600 hours
- Raining Time is 1~9999min & Raining Cycle is 1~240min (adjustable)
- The distance between the lamp center and the sample: 350~380mm
- Sample rotation speed: 1r/min
- Water Spray time: 0~99h59min (adjustable)
- Refrigeration mode: mechanical refrigeration air cooling



Automatic Double Drop Test Machine (DT-60KG)

This series drop test bench for measuring the main simulation packages in the transportation, loading and unloading process under drop impact influence, identification package impact strength and packaging design.

Specification:

- The drop height is 400~1500mm and motor rotation for height
- The max weight test is 60kg and max size is $2000 \times 800 \times 300 \text{mm}$
- Drop angle tolerance is $< 1^{\circ}$ and drop height tolerance is $\pm 10 \text{mm}$
- Drop method: face, edge and corner
- Power supply: AC380V/50HZ and 4KVA
- The machine height display by the digital measuring instrument, also combined with calibration function
- Drop method: Electromagnetic drive drop control, click on the drop button can be achieved the drop test

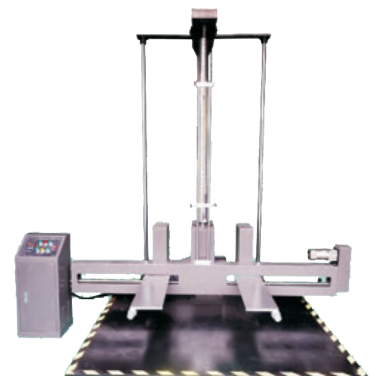

Digital CC and CV DC Power Supply (DC3005)

Specification:

The DC Series Power Supplies are with high stability and high accuracy. The voltage and current can be adjustable and simple operation. They are suitable to supply DC Power for the standard lamp and the large power LED. Other voltage and current DC Power Supply can be designed according to customer's request.



Model	DC3005	DC3010	DC6005	DC6010	DC12005
Output Voltage Range	0.005~30.00V	0.005~30.00V	0.005~60.00V	0.005~60.00V	0.0010~120V
Output Current Range	0.005~5.000A	0.005~10.00A	0.005~5.000A	0.005~10.00A	0.005~5.00A
Voltage	0~30V, 0~60V or 0~120V				
Resolution of Voltmeter	0.0001V(0.1V~10.000V) 0.001V(10.000V~60.000V)				
Accuracy of Voltage and Current	+/- (0.02% Reading + 0.01% Range + 1 Digit)				
Stability of Output Voltage	+/-0.01% Reading/3min				
Stability of Output Current	+/-0.01% Reading/3min				

AC Power Source (LSP-500VAR)

Specification:

- AC-DC-AC frequency conversion technology
- Output frequency range: 45.00~65.00Hz
- Output voltage range: AC 0.0~300.0V
- Zero output impedance, equivalent resistance ≤ 0.1
- Insulation for power output to make test safely and steady
- Protection for over hot and thundering voltage and current
- Input by keyboard, big/small adjustment, fast parameter set-up
- Total voltage distortion: $\leq 0.6\%$; Voltage stability: $\leq 0.1\%/30$ min
- Load adjust rate: $\leq 0.1\%$; Frequency stability: $\leq 0.05\%/30$ min
- Digital wave synthesis, wave feed-back technology, low power distortion
- Controlled and tested by 16 bits MCU, which has high automation
- High speed 12 bits A/D sampling technology, exactly display Voltage, Current, Power, Power factor, Frequency



Model	Output Power	Remark
LSP-500VAS LSP-500VAR	500W	0~150V: 4.2A, 150~300V: 2.1A (LSP-500VAR is pure sine wave AC Power Source)
LSP-1KVAS LSP-1KVAR	1000W	0~150V: 8.4A, 150~300V: 4.2A (LSP-1KVAR is pure sine wave AC Power Source)

All of AC Power Source can communicate with PC via Lisun software

PWM Type AC Power Supply (LSP-5KVA)

Specification:

- Circuit Type: (IGBT) MPWM Pulse Duration Modulation
- Input: 1 Phase 220V±10%, 50Hz/60Hz±5%
- Output Voltage: HIGH/LOW Adjustable
 - 1) 1 Phase Voltage Range: (HIGH)0~300V, (LOW)0~150V
 - 2) Nominal Voltage: +10%~+25%, -10%~-30%
- Output Frequency: 50Hz, 60Hz, adjustable between 45 and 70 Hz, 400Hz
- Load Voltage Stabilization Rate: ≤0.5%
- Frequency Stabilization Rate: 0.1% (Fix Point 50Hz, 60Hz and 400Hz)
- Wave Distortion Rate: ≤2% (Resistor Load); Efficiency: ≥85%
- Output Instruments: Frequency Indicator, 4-digits RMS digital frequency indicator, resolution is 0.1Hz Voltage Meter, 4-digits RMS digital voltage meter, resolution 0.1V Ampere Meter, 4-digist RMS digital ampere meter, resolution 1Ma Power Indicator, 4-digits RMS digital power indicator, resolution 1W Power Factor Meter Resolution 0.001
- Over load, short circuit, over voltage, over current, over temperature protective with alarm
- Operating Environment: Temperature 0~40℃. Relative Humidity:0~90%



Model	Output Power	Specification
LSP-3KVA	3000W	0~150V: 25A, 150~300V: 12.5A
LSP-5KVA	5000W	0~150V: 42A, 150~300V: 21A

PS. More than 5KVA AC Power Source can be designed as customer's request

Digital Power Meter (LS2008R, LS2010, LS2012, LS2050)

- Measure Voltage, Current, Power and Power Factor
- Voltage range: 10~600V; Current range: 0.005~20A
- Accuracy: ± (0.4%reading + 0.1%range + 1digit). LS2050: ± (0.1%reading+0.1%range+1digit)
- Communicate with PC by RS-232. It can communicate with LISUN other instruments such as LMS-7000, LMS-9000 and LMS-9500

Model	Measure	Remark
LS2008R	AC Parameters: U, I, P, PF	AC model
LS2010	AC Parameters: U, I, P, PF and harmonic	Special Software can show harmonic in Win7 or Win8
LS2012	AC+DC Parameters: U, I, P, PF	DC: 1~600V, DC Current Range: 0.005~20A (small current 0.005~2A optional), out of limit alarming
LS2050	AC+DC Parameters: U, I, P, PF and harmonic	High accuracy with Special Software can show harmonic in Win7 or Win8, out of limit alarming



LS2010 Harmonic Model



LS2012 AC&DC Model



LS2050 High Accuracy Model

Application

LED Luminaires and LED Power Driver Test Solution

- Goniophotometer System: LSG-5000, LSG-1800B or LSG-1700B
- Spectroradiometer & Integrating Sphere Test System: LPCE-2 or LPCE-3
- LED Life Maintains Test System according to LM-80: LEDLM-80PL
- Waterproof Test for IPX5 and IPX6 level testing: JL-56
- Dustproof Testing Machine for IP5X and IP6X level testing: SC-015
- LED Driver Testers: WT2080 (for LAB) and LEDLS-60 (for production line)
- Electricity Safety Tester: LS9955, ZRS-3HS, ZY-3S



Single LEDs or LED Chips

CFL and Electronic Ballast Test Solution

- Goniophotometer System: LSG-1800B or LSG-1700B
- Integrating sphere and Spectrophotometer Test System: LPCE-2
- Adjustable Reference Ballast: DYJ-50HZ, HCS-109A and DYJ-HID
- Electric Ballast Tester: WT5000 (for LAB) and ATE-1 (for production line)
- Digital Torsion Meter and Multiway Life Tester: CH338 and CH316
- Electricity Safety Tester: LS9923, ZRS-3HS, ZY-3S



LED Luminaires

EMC and EMI Test Solution for CFL and LED Luminaires

- EMI Test System: EMI-9KB or EMI-9KA
- Electrostatic Discharge Simulator: ESD61000-2
- EFT Immunity Measurement: EFT61000-4
- Surge Generator: SG61000-5
- Voltage Dips and Interruptions Generator: CSS61000-11
- Ring Wave Generator: RWG61000-12

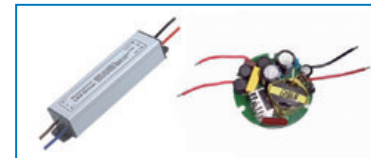

LED Power Driver

Certificate & Awards

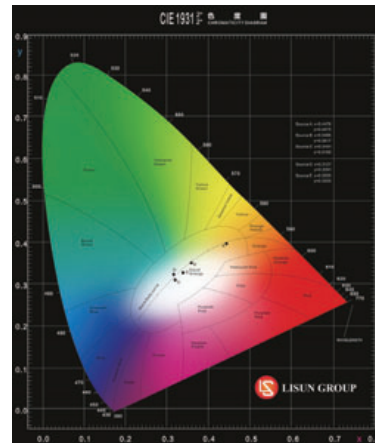
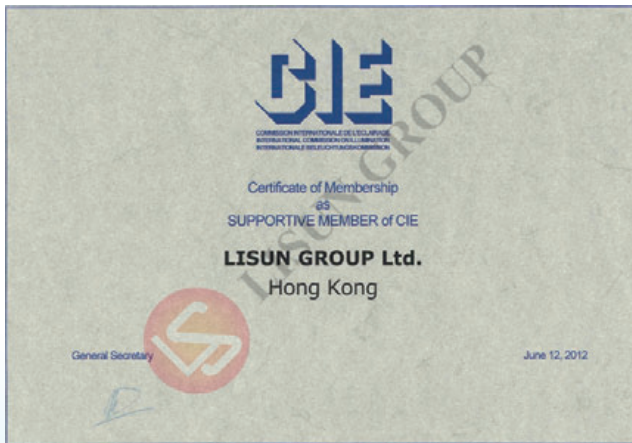

CIE Supportive Membership



CE-EMC Certificate



CE-LVD Certificate



ISO9001:2008