

# PHASE AND FEEDER ON LINE CONTROLLER



## mPAD



CAUTION: Read this manual before using the device



### MADE

S.A. au capital de 270 130 €  
167, Impasse de la garrigue  
F 83210 LA FARLEDE

Tél. : +33 (0) 494 083 198 - Fax : +33 (0) 494 082 879  
E-mail : [contact@made-sa.com](mailto:contact@made-sa.com) - Web : [www.made-sa.com](http://www.made-sa.com)



## REVISION HISTORY

<b>Rév.</b>	<b>Modifications</b>	<b>Date &amp; author</b>
1.61	Translation from French version	P. PICON

This manual is important for your safety. Read it carefully in its entirety before using the device, and keep it for future reference.

# SUMMARY

<b>1.</b>	<b>SAFETY INFORMATION</b> .....	<b>5</b>
1.1.	Safety recommendations.....	5
1.2.	Following the safety recommendations .....	5
1.3.	Warning labels.....	6
<b>2.</b>	<b>OVERVIEW</b> .....	<b>7</b>
2.1.	Operating principle .....	8
2.2.	Components .....	10
2.3.	Brief description of setting up the system .....	10
<b>3.</b>	<b>TRANSMITTER</b> .....	<b>11</b>
3.1.	Overview .....	11
3.2.	Description .....	12
3.3.	Voltage Connection.....	12
3.4.	Connection of the current measurement Rogowski coils .....	16
3.5.	Turn-On .....	18
3.6.	Uninstalling the transmitter .....	18
3.7.	System Test Mode.....	19
<b>4.</b>	<b>RECEIVER</b> .....	<b>20</b>
4.1.	Overview .....	20
4.2.	Connection .....	20
4.3.	Operation .....	22
<b>5.</b>	<b>ADVICE FOR USE IN DISTURBED ENVIRONMENT</b> .....	<b>22</b>
5.1.	If only the phase is identified .....	23
5.2.	The receiver receives nothing .....	23

<b>6.</b>	<b>FAULT CASES .....</b>	<b>24</b>
6.1.	Transmitter in normal mode .....	24
6.2.	Transmitter in test mode.....	24
<b>7.</b>	<b>TECHNICAL CHARACTERISTICS.....</b>	<b>25</b>
7.1.	System .....	25
7.2.	Transmitter .....	25
7.3.	Receiver .....	25
<b>8.</b>	<b>MAINTENANCE.....</b>	<b>25</b>
<b>9.</b>	<b>RECYCLING .....</b>	<b>26</b>
<b>10.</b>	<b>GUARANTEE .....</b>	<b>26</b>
10.1.	Limitations .....	26
10.2.	Claims limitations.....	27
<b>11.</b>	<b>COPYRIGHT .....</b>	<b>27</b>
<b>12.</b>	<b>ANNEXE .....</b>	<b>28</b>
12.1.	Declaration of conformity CE .....	28

This document is the mPAD User's Guide. It describes the implementation of the device, as well as the different modes of operation to facilitate its use.

# **1. SAFETY INFORMATION**

## **1.1. Safety recommendations**

Please read this guide carefully before unpacking, configuring or using this equipment. Note all indications of danger and other warnings. Failing to observe these recommendations could result in serious injury to the operator or could damage the equipment. To ensure that the protection provided by this equipment is appropriate, do not use or install it other than in accordance with the conditions indicated in this manual.

Dismantling the cases is forbidden. This operation is limited exclusively to personnel qualified by MADE.

## **1.2. Following the safety recommendations**





**DANGER:** Indicates a dangerous or potentially dangerous situation which, if not avoided, could cause serious or deadly injuries.

**WARNING:** Indicates a potentially dangerous situation which could cause superficial to moderate injuries.

**Remark:** Information requiring particular attention.

### 1.3. Warning labels

Read all labels and wordings shown on the instrument. Injuries or equipment damage could occur if these instructions are

	Symbol requiring reference to the instruction manual for instructions concerning operation or safety recommendations.
	Dangerous Voltage
	Ac current
	Do not throw away with household waste

## 2.OVERVIEW



Figure 1 VIEW of the M.PAD system

**mPAD** is developed, designed manufactured by the MADE S.A. company

Its main functions are:

- **The identification of the phase and feeder at any point in the LV network, live and under load, downstream of a distribution Substation.**

- **The verification of the complete electrical network layout supplied by a distribution substation live and under load.**

The complete system is housed in a robust transport case.

MPAD consists of a transmitter, left in place once turned on, and a receiver which is connected to the network at the points at which the phase and feeder are to be identified.

### **2.1. Operating principle**

The receiver forms a very specific load which draws a current, which in turn is detected by the transmitter. The transmitter responds by transmitting over the network the numbers of the feeder and phase to which the receiver is connected. Each component has two very specific and complementary functions which it is useful to understand so as to follow the system's operation:

- The transmitter detects a current (from the receiver) and transmits to the receiver a signal coded with the information on the phase and feeder.
- The receiver generates a current (detected by the transmitter), and subsequently decodes the signal transmitted by the transmitter so as to display the information to the operator.



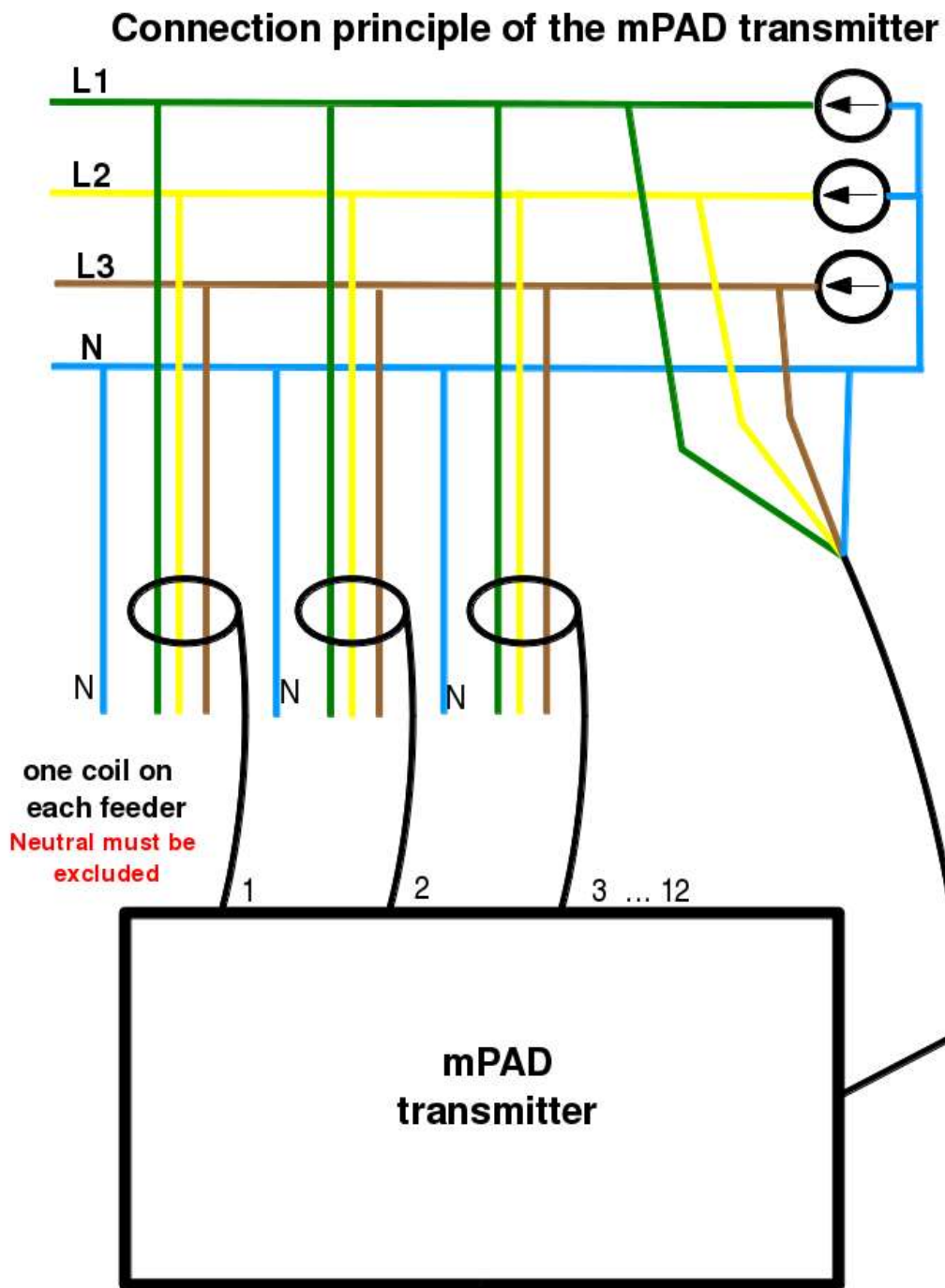
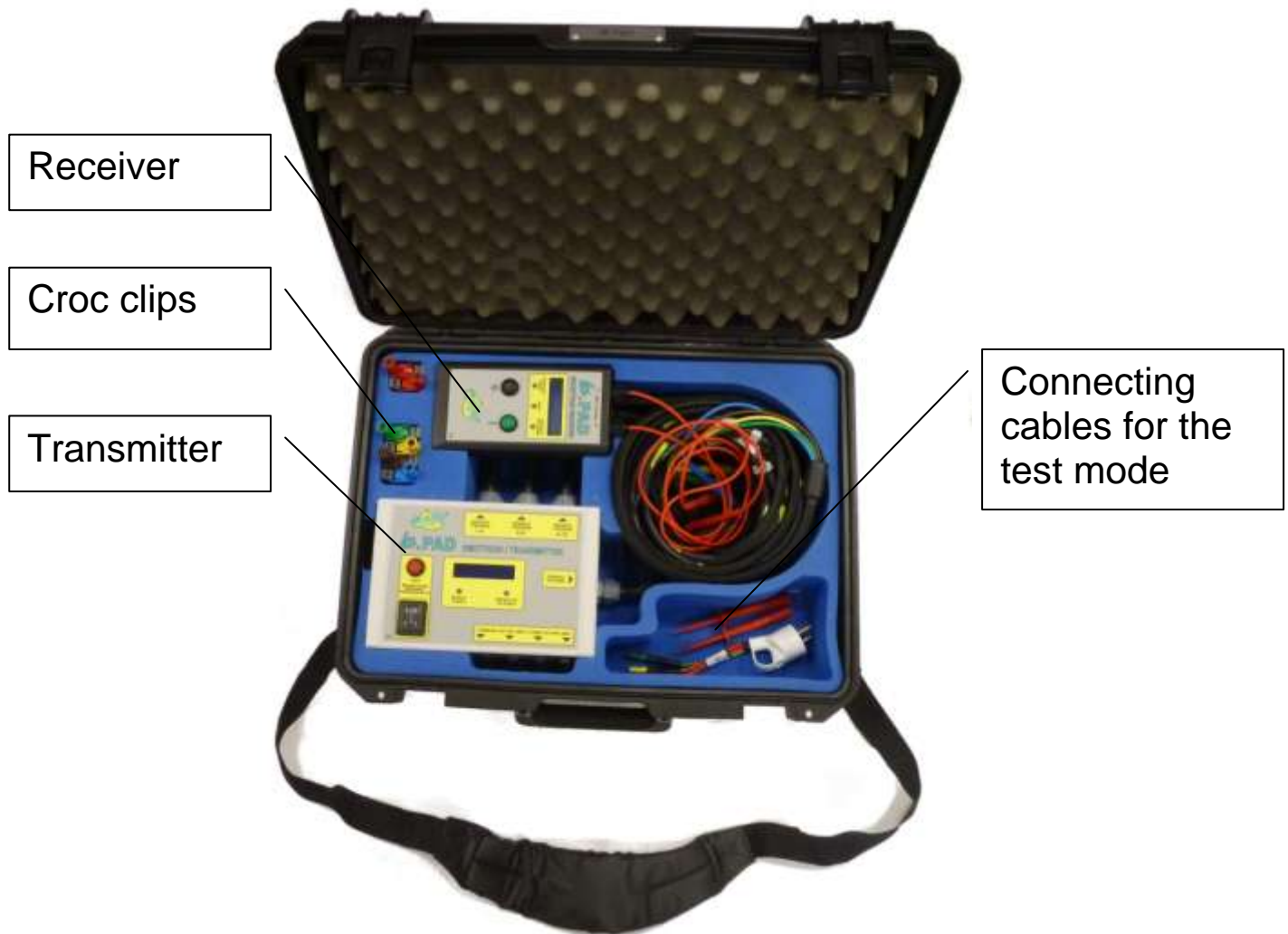

Figure 2 Transmitter connections

## 2.2.Components



## 2.3.Brief description of setting up the system

The conditions for access and connection are governed by the rules established by the Network Operator.

### 2.3.1.Placing the transmitter

- Connect the neutral and the three phases to one of the feeders from the distribution substation.
- Close one of the MadeFlex Rogowski coils around all three phases of each feeder, taking care NOT to include the NEUTRAL, and ensuring that all the coils are in the same directional sense. For this

## TRANSMITTER

it is only necessary that the directional marks on the underside are all facing the transformer.

- Turn on the transmitter and check that there are no error messages on the display.
- Take the receiver to the various points on the network requiring identification to carry this out.
- It is possible to run a complete test of the system as described below in order to confirm the correct functionality of the system.

### 2.3.2.Using the receiver

- The receiver is connected between **phase and neutral**, with either with the probes or the croc clips ; the connection sense is unimportant.
- Once connected, the connection must be maintained until reception of the information transmitted by the transmitter.
- The receiver is supplied directly from the network, and holds the information display for several seconds after disconnection. Nevertheless, the last information displayed can be re-called by pressing the left-hand button on the front face.

## 3.TRANSMITTER

### 3.1.Overview

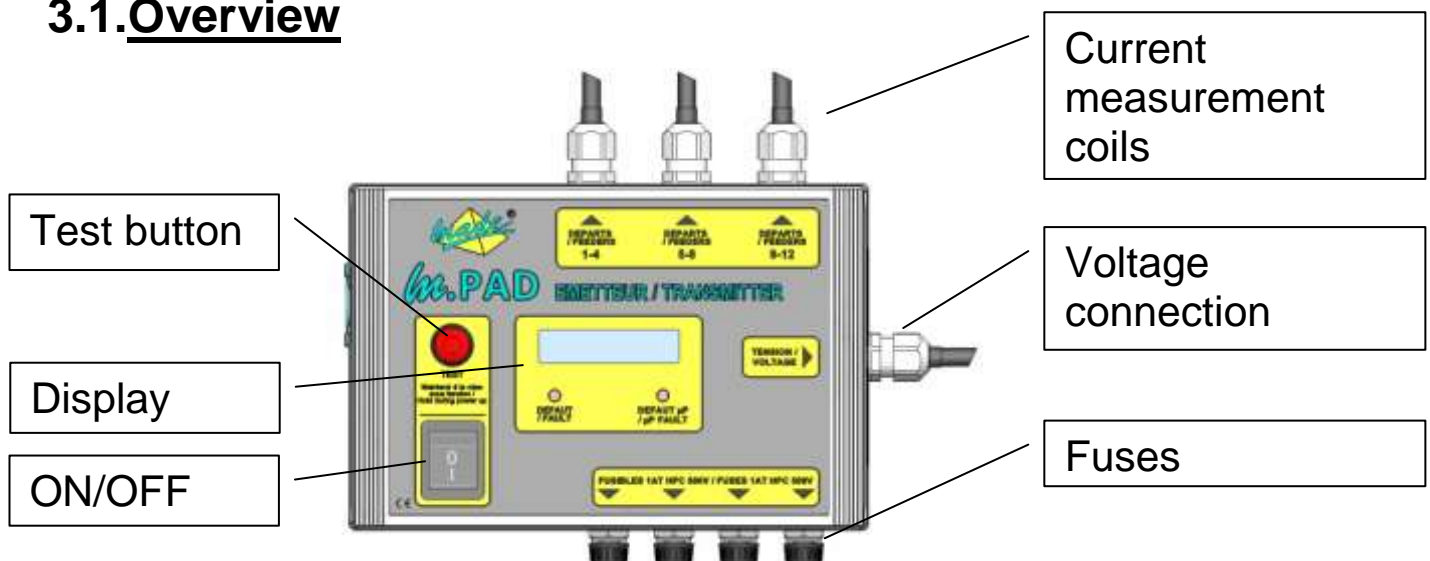

### **3.2. Description**

The mPAD transmitter has :

- A voltage connector (center right)
- Four fuse holders, one to protect each phase and one for the neutral (lower right)
- Three connectors for the current measurement coils (upper right)
- A display and two fault LEDs (center)
- A button to activate the TEST mode (left center)
- An ON/OFF switch (lower left)

### **3.3. Voltage Connection**

mPAD Functions equally well on 110 or 230V networks.

The transmitter is supplied by the green (L1) and yellow (L2) conductors. All the conductors are used for signal transmission to the receiver, the blue conductor (neutral) serving as a reference.

Connect each of the conductors in the cable to the corresponding phase as in §2.3:

1. Blue to neutral
2. Green to L1
3. Yellow to L2
4. Red to L3

This association must be complied with since the phase identification is made relative to these connections of the network to the transmitter. Thus the network phase connected to the green connector is shown as L1 on the receiver even this is the phase three in the substation. Additionally, this association is also important for the correct operation of the « network rotation », as the permutation of two phases will change the sense of rotation seen by the transmitter.

Each conductor is protected by a fuse in the connecting plug, which, in case of doubt, should be tested and if necessary replaced.

**3.3.1. Connection in a TIPI type substation:**



Figure 3 TIPI Substation



Figure 4 Voltage connection via  $\varnothing 4\text{mm}$  plugs from the TIPI voltage outputs



Figure 5 Installation of current coils around each TIPI feeder

### **3.3.2. Connection in a TUR type substation**



Figure 6 TUR





Figure 7 Voltage connections by croc clips on a feeder in a TUR type substation



Figure 8 Connection to LV terminals on a distribution transformer



Figure 9 Installation of current coils on each feeder in a TUR type substation

The uninstalled coil is kept closed without a cable so as to keep the correct number sequence

### **3.3.3. Connection in a T4 type substation:**



Figure 10 T4

### **3.4. Connection of the current measurement Rogowski coils**

The mPAD is equipped with 4 to 12 flexible (Rogowski) coils for current measurement depending on the chosen option.

These coils are grouped in fours in a robust cable sheath fixed to the transmitter. Each corresponds to groups 1-4, 5-8, and 9-12.

Each of these coils is numbered from 1 to 12. This number is that which is transmitted to the receiver. In fact, as soon as the presence of the receiver is detected, and since this is detected on only one feeder, the coil around it determines the number which will be transmitted. Thus, as for the phases, the association feeder/coil is important. If the identification of the feeders from the substation are numbered between 1 and 12, then the association is natural, but if they have letters (A,B,C,...) then A->1,B->2,C->3, ... also seems natural, in other cases, this remains to be decided. The chosen convention should nevertheless make it easy to deduce which physical feeder from the substation corresponds to the number displayed by the receiver.



## TRANSMITTER

The coils must definitely be closed around **the three phases and NOT the neutral**, see the drawing below. In addition, they **must all be in the same sense**. To be sure of this the marking on each coil should be **oriented towards the transformer** (the opposite, all towards the load is also useable, but for reasons of simplicity and to have a simple rule for setting up, the first is preferable ; in general the marking is visible from above). This point is **essential** for the correct operation of the system.

**If the substation has less feeders than there are coils, the remaining coils must remain closed around nothing.**

**If the substation has more feeders than there are coils, the clients supplied from the un-instrumented feeders cannot be identified.**

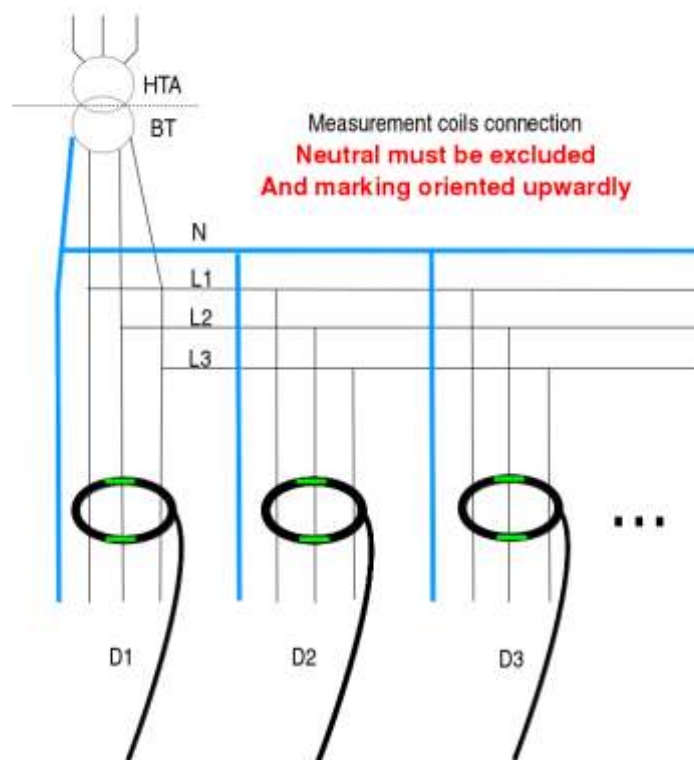

Figure 11 Connection principle of the measurement coils

### 3.5. Turn-On

Once the connections described in §3.2 and §3.3 above have been made, it suffices to press the “I” on the power switch. The cooling fan starts, the fault LED  $\mu$ P extinguishes, and the display gives some indications:

- The name of the device (mPAD)
- The address of the company site
- Then:
- The software version
- Further:
- The network frequency and the rotation sense <-ABC-> or <!ACB!>
- A situation line with a field for the feeder number, the phase number, and a timer showing the time since the last displayed result.

This situation line enables the operator to see on the transmitter which is the last network point identified.

The feeder numbers are D1 to D12, « D-- », or « D?? ». « D-- » signifies that no feeder is identified whereas « D?? » signifies an ambiguity. This implies that the signal generated by the receiver has been detected on more than one feeder.

The phase numbers are L1, L2, L3, « L-- ». « L-- » when no feeder is identified.

**The Number of the phase displayed on the transmitter is only valid when the rotation is <-ABC->, whereas this number is valid on the receiver for both <-ABC-> and <!ACB!> rotation.**

### 3.6. Uninstalling the transmitter

- Move the power switch to « O ».
- Disconnect all the voltage connection cables.
- Remove all the Rogowski coils.
- Replace the components and cables in their emplacements in the case.

### 3.7. System Test Mode

mPAD employs a significant number of Rogowski current measurement coils. Although the connections have been chosen with care for reliability and robustness, a bad contact could develop. To ensure that the system is functioning correctly, a test mode, easy to use, is available.

#### 3.7.1. Connection in test mode

Using the adapter shown left, connect the transmitter by its green and yellow plugs (the other red and blue plugs are not used) to those of the adapter green and yellow ring-marked TX.

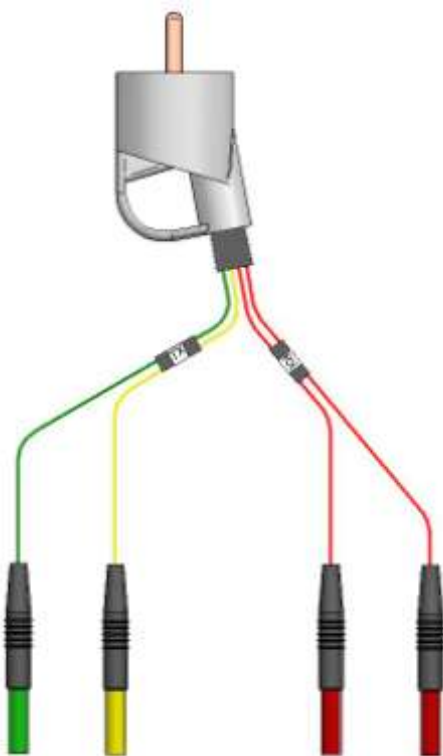

- Connect the receiver terminals to the two red plugs ring-marked RX (the sense is unimportant).
- Encircle with each coil one and one only of the receiver cables (the sense is unimportant in this mode). This roughly reproduces the normal operation of the system ; the liaison of the receiver to the mains by the adapter replaces the cable from the substation.
- Connect the adapter to the mains.
- Hold down the button TEST – above the power switch.
- Move the ON/OFF switch to “I”, holding the test button down until the display shows « Testing ».
- A complete test of all the groups of 4 coils connected and the receiver is carried out.
- One group is detected if its identifier (1-4, 5-8 or 9-12) is shown in the first line of the display next to « GRP : ». For example, the following line « **GRP :1-4 9-12** » indicates that only the groups 1-4

and 9-12 are connected, or that the group 5-8, if it is connected, is not detected, and thus there is a failure.

- On the second line is shown next to « DEF : », the list of the faulty coils.
- If no fault is shown after this test, the system is in good operational state and ready for normal use.
- Conversely, if any anomalies are shown, refer to the paragraph concerning actions to be taken in case of a fault.

## 4.RECEIVER

### 4.1.Overview

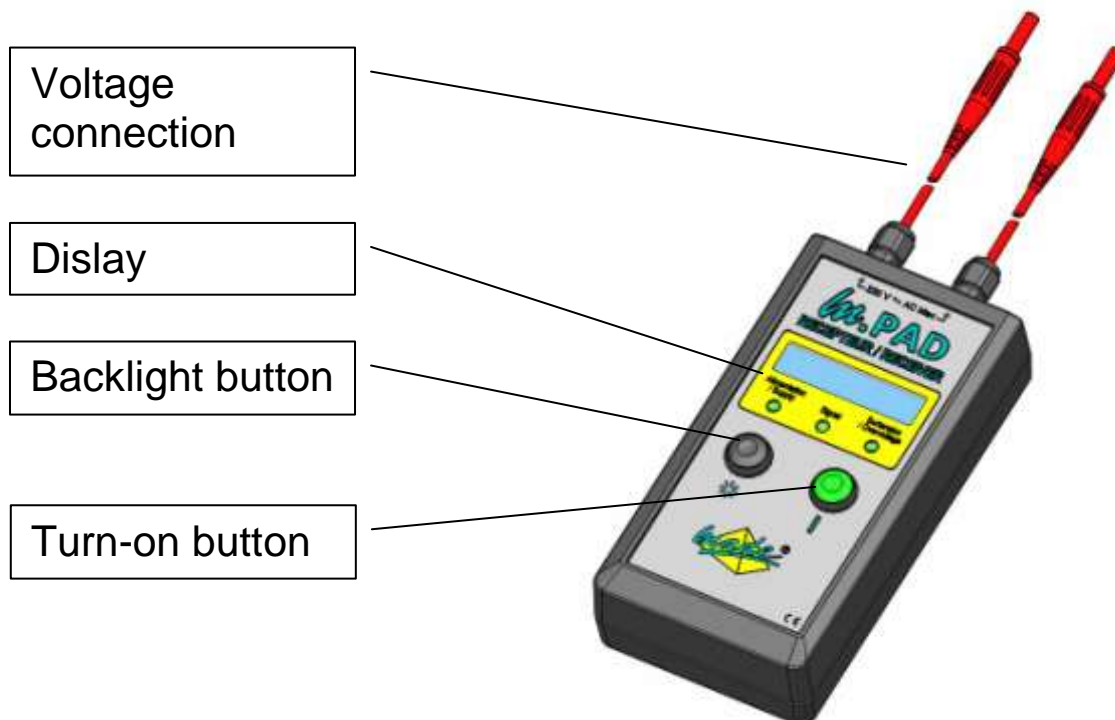

### 4.2.Connection

The MPAD receiver is connected to the LV network using the cables supplied with fused 4 mm. banana plugs IP2X CAT IV, on which are fitted probe points or croc clips. It is important that, once the connection is made, it is maintained without interruption until the full data block is received from the transmitter (between 4 and 20s). Particular care is needed when using the contact probes.

### 4.2.1. Connection to the client terminal cabinet



Figure 12 Connection by croc clips



Figure 13 Connection by probes



Figure 14 Special connection case



Figure 15 connection to a IP2X cabinet

### **4.3.Operation**

- The transmitter is connected and turned on as described above.
- Connect between **phase and neutral** (this is very important, otherwise the system will not start and the overvoltage LED will light), the receiver is automatically powered-up, the green LED lights, and the message « **Reception ...** » is shown. It then behaves as a « special » load detected by the transmitter.
- Check that the operation is correct by the « signal » LED. This lights briefly approximately each four seconds.
- Wait for the display to show the result in the form « Dxx Lx », for example « D05 L2 » for feeder N°5, phase N°2. The same conventions are adopted in the case of ambiguity of the feeder (**D??**) and feeder not identified (**D--**) as for the transmitter.
- Even if the feeder is not identified, the phase may be identified. However the inverse is not possible in principle.
- Once disconnected from the mains the receiver maintains the display for several seconds before shutting off. It is then possible to consult the result again by pressing the ON button, the receiver is turned back on (supplied by the internal battery), but the green LED remains unlit. Only the last result can be displayed.
- Once the receiver is reconnected to the network, the previous result is effaced (re-initialisation of the system) so that there is no doubt about the source of the result displayed;
- If the ambient lighting is too low, pressing the left-hand button starts the backlighting. A second press turns off the backlighting.

## **5.ADVICE FOR USE IN DISTURBED ENVIRONMENT**

The LV Network harbours many electrical disturbances due to the connected loads, generated harmonics, voltage drops and rises, power factor variations and distributed generation. It is thus possible that in some cases the sum of these effects militate against the correct operation of MPAD. Nevertheless, even if the performance may be affected, it can fulfil most of its function.

## **5.1.If only the phase is identified**

The data blocks are received from the transmitter but the feeder is not or ambiguously identified.

### **5.1.1.Single phase access**

- The phase to which the client is connected has a problem, it may be that this is temporary, in which case a new attempt a little later will work.
- Seek another network point nearby and retake a measurement. If the phase is different conditions may be more favorable. Repeat the operation if necessary.

### **5.1.2.Three phase access**

- The first check is to measure each phase, often that is enough.
- Retake the measurement a little later.
- If this fails, change the measurement point.

## **5.2.The receiver receives nothing**

The data blocks do not reach the receiver.

### **5.2.1.Check on the transmitter**

- If the substation is close (generally the case on an LV network), and if the transmitter has been able to detect the receiver, it will show the feeder and phase of the last measurement on the display, which should be checked. Take care that this result is the correct one by reference to the timer showing the “age” of the displayed measurement
- Change access point to make a measurement on another phase if possible.
- Retake a measurement a little later.

### **5.2.2.Three phase access**

- Change phase
- Retake the measurement a little later.
- Change access point.

## **6. FAULT CASES**

### **6.1. Transmitter in normal mode**

#### **6.1.1. The system cannot be powered up**

Check the fuses, especially those of phases 1 & 2.

#### **6.1.2. The LED fault $\mu$ P is lit**

This is a fault which requires repair.

#### **6.1.3. The LED fault $\mu$ P is lit but nothing is shown on the display**

Power-down and re-start, if the fault persists it requires repair.

#### **6.1.4. The LED fault $\mu$ P is lit and there is a message on the display**

- Connection fault : Check that the connections are correctly made, that there are no inversions phase/neutral and that all fuses are OK.
- Transmission problem : Check the connections, there could be a bad contact or a fuse blown. If this is not the case. it requires repair.

### **6.2. Transmitter in test mode**

#### **6.2.1. Coil group not detected**

A coil group is connected but does not appear in the list of the groups on test : check that the connector is correctly tightened, and that no pins are bent or broken or the cable damaged. Depending on the type of problem, the cable group requires repair.

#### **6.2.2. All the coils of one or more groups are in fault**

The coils are closed around two connections to the receiver or none at all.

#### **6.2.3. One or more coils in one or more groups are in fault**

The cable or cables of de the group or groups has a fault, the cable group requires repair.



## **7. TECHNICAL CHARACTERISTICS**

### **7.1. System**

Size	540x410x220 mm.
Weight	9,85 Kg

### **7.2. Transmitter**

Supply	230/400V AC
Size	240x160x120 mm.
Weight	3 Kg
Protection Rating	IP 22
Fuses on the cables	1,6A@1000V breaking power 30KA
Fuses on the transmitter	3A@415V breaking power 70KA

### **7.3. Receiver**

Supply	230V/battery 9V
Size	195x100x60 mm.
Weight	600 g
Protection Rating	IP 64
Fuses on the cables	1,6A@1000V breaking power 30KA

## **8. MAINTENANCE**

Opening the system is not allowed. This is reserved exclusively for qualified personnel accredited by MADE-SA.

An annual check can be programmed.

Use only a clean dry cloth for cleaning.

Never use solvent or a product based on solvent to clean the system or its accessories.

**If the connection accessories (probes, croc clips) need replacement by the user, they must all conform to CAT IV 600V.**

Similarly, the fuses must be replaced by a model conforming to specification of §7.2 for the transmitter and §7.3 for the receiver.

## **9.RECYCLING**

In Conformity with the decree n° 2005-829 of the 20th of July, 2005 concerning the elimination of remains of electrical and electronic equipment (DEEE), the user assures and assumes as his responsibility the collection and

## **10.GUARANTEE**

MADE guarantees this product, to the initial purchaser, against any material or operational fault for the duration of one year from the date of delivery, unless otherwise indicated in the product manual. If such a fault is discovered during the period of the guarantee, MADE decides at its choice to repair or replace the defective product, excluding the costs of transport and initial delivery. Any product repaired or replaced according to this agreement will only be guaranteed for the remainder of the period of the initial guarantee of the system.

### **10.1.Limitations**

This guarantee does not cover:

- Damage caused by a "cause beyond control", natural disasters, strikes, wars (declared or not), terrorism, social conflicts or any acts under governmental jurisdiction
- Damage due to misuse, to carelessness, to any accident or an unsuitable application or installation
- Damage caused by a repair or an attempted repair not authorized by MADE
- Any product that is not used in accordance with the instructions provided by MADE
- Cost of transport back to MADE
- Cost of transport by express delivery of parts or products under guarantee
- Cost travel for a repair on site under guarantee

This guarantee constitutes the unique explicit guarantee established by MADE for its products. All implied guarantees, including, but not

limited to, guarantees on the commercial value of the product and its suitability for a particular use are positively rejected.

The present guarantee confers certain rights : the legislation of the country or jurisdiction can grant others. This guarantee constitutes the final declaration, complete and exclusive, of the terms of the guarantee and nobody is allowed to give other guarantees or promises on MADE's account.

## **10.2.Claims limitations**

Claims having for object repair or replacement are the only allowable claims in case of the breaking of this guarantee. The MADE Company cannot be held responsible, whether on the basis of strict responsibility or any other legal basis, of any incidental or consecutive damage resulting from a violation of the guarantee or from carelessness.

## **11.COPYRIGHT**

© All rights reserved. The distribution and the copying of this document, as well as the use and the communication of its content, are forbidden without written authorization of MADE.

The content of this document is destined for use only as information. It can be modified without prior notice and must not be considered as an obligation by MADE.

MADE declines all responsibility for mistakes or inaccuracies that the present document may contain.

**12. ANNEXE****12.1. Declaration of conformity CE****déclaration CE of conformity**Déclaration : **CE\_mPAD / 01 / 2013**

The manufacturer:

**MADE SA**167, Impasse de la Garrigue  
F 83210 LA FARLEDE

Declares the product:

**mPAD**

Has been designed and manufactured to conform to :

The EU directives and specifications listed

- CEM 2004/108/CE relative to « Marking CE»
- 2006/95/CE : Low voltage Directive (LVD, relating to the safety of electrical equipment designed for use within certain voltage limits.

Tests performed by the laboratory of the "Ecole Centrale of Marseille" (Test report Ref: R12-051-EC), showed that the device referenced above is in accordance with Directive 2004/104/EC.

In addition, the product described above has been designed, manufactured and tested as part of a Quality Assurance System certified according to EN ISO 9001/2008, by the French Association for Quality Assurance - AFAQ certificate: QUAL / 2005 / the 24473B: 05/05/2011.

Signed at La Farlède, the 3rd September, 2013

Directeur Général	Directeur Technique	Responsable Qualité
Marc Rivasseau 	Laurent Zomerg 	Jean Yves Creste 

