

6,000VA
15-1,200 Hz

1Ø → 0-330V_{L-N}
2Ø → 0-600V_{L₁-L₂}
3Ø → 0-330/572V_{L-L}



Standard Features:

- 1 phase / 3 phase Selectable Output from front panel or bus command. 15 to 1,200 Hz. Operation – 5,000 Hz small signal bandwidth.
- Precision Voltage Programming – 0.05% with Continuous Self-Calibration (CSC) engaged.
- True-RMS metering of volts, amps, and power.
- GPIB (IEEE-488.2) or RS-232 Interface.
- Waveform Library – Arbitrary Waveform Generator.
- 99 stored programs with associated transients for static and dynamic test applications.
- UPC Studio Software Suite.
- UPC Interactive LabVIEW™ Libraries.

Available options:

- Rack enclosures with caster base.
- Programmable Output Impedance.
- Harmonic Analysis and Waveform Synthesis.
- Peak Inrush Capture and Waveform Analysis.
- UPCTestManager Software Application.
- Wide range of Output transformer options for world-wide testing.

UPC Manager Software Suite
Master the Power of the Wave!

UPC Manager Software gives you the tools necessary to quickly and easily operate your AC Power Source. With our graphical interface control all areas of your AC Power Source testing with simple presets, user prompts, test sequences, test plans and custom reports.

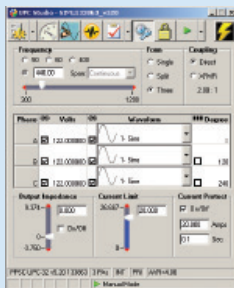

Model 360-ASX

As a member of Pacific's ASX-Series family of high performance AC Power Sources, the 360ASX offers the low acoustic noise, ease of installation, and maximum power density found in all of Pacific's high frequency, pulse width modulated AC Power Sources. Control and operational features provide a high degree of versatility and ease for applications ranging from simple, manually controlled frequency conversion to harmonic testing and sophisticated bus programmable transient simulation.

AC TEST POWER

The 360-ASX is equipped with a powerful micro-controller with the ability to operate as a fully integrated test system. It supplies a variety of power conditions and transients to the device under test while metering and analyzing all output performance parameters.

FREQUENCY/VOLTAGE CONVERSION

The 360-ASX is an excellent source of stable AC Voltage over the frequency range of 15 to 1,200 Hz. The output frequency is quartz-crystal stabilized. Output voltages up to 600V are available.

PHASE CONVERSION

With the ability to provide single, two, and three-phase outputs, the 360ASX is an ideal choice to convert three-phase line voltage into precisely controlled split (two-phase) or single-phase output power.

UPC SERIES CONTROLLER

Three controller models are available offering both manual and programmable control. All controllers provide manual operation from the front panel. Programmable Controllers may be operated from the front panel or from a remote interface via RS 232 or GPIB.

The Leader in AC Power Technology

An early pioneer in the development solid-state power conversion equipment, Pacific Power Source continues to develop, manufacture, and market both linear and high-performance PWM AC Power Sources. Pacific's reputation as a market and technology leader is best demonstrated by its continuing investments in both research and development and world-wide customer support. With corporate owned offices in the United States, Germany, the United Kingdom, and China, local personalized support is always available.



THE POWER OF EXPERTISE

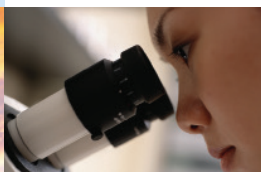

FREQUENCY CONVERSION

AEROSPACE

R & D

MILITARY

MANUFACTURING

CUSTOM

Output Ratings

360ASX

Rated Power (VA) ¹	Coupling Mode	Form ²	Output Voltage ³ V _{rms} Max (L-N/L-L)	Current ⁴ (A _{rms})	Frequency Range	Input Power	Unit Height In/mm/U	Unit Weight (Lbs/Kg)
6000 ⁵	Direct	1Ø/2Ø	132/264	48/16	15-1200	3Ø 47-63Hz	8.75/222/5U	145 Lbs/66 kgs
		3Ø	132/228	16/Ø	15-1200			

360ASXT

Rated Power (VA) ¹	Coupling Mode	Form ²	Output Voltage ³ V _{rms} Max (L-N/L-L)	Current ⁴ (A _{rms})	Frequency Range	Input Power	Unit Height In/mm/U	Unit Weight (Lbs/Kg)
6000 ⁵	Direct	1Ø/2Ø	132/264	48/16	15-1200	3Ø 47-63Hz	360ASX 8.75/222/5U Transformer Module 5.25/133/3U	360ASX 145 Lbs/66 Kgs Transformer Module 125 Lbs/56.8 Kgs
		3Ø	132/228	16/Ø	15-1200			
		1Ø/2Ø	198/396 198/343	32/11 11/Ø	45-1200 45-1200			
		1Ø/2Ø	264/528 264/457	24/8 8/Ø	45-1200 45-1200			
	Transformer 2.5:1	1Ø/2Ø	330/600 330/572	19/6 6/Ø	45-1200 45-1200			

NOTES:

- Rated output power is based on a combination of nominal output voltage, rated current and load power factor. Values stated represent the maximum capabilities of a given model. Consult factory for assistance in determining specific unit capabilities as they might apply to your application.
- Unit is operable as single phase with dual range capability or as a three phase. Output voltage range and 1/3 conversions are selected by front panel or bus commands.
- V_{max} is output voltage with nominal input and full rated load applied.
- Available current will vary with output voltage and power factor.
- Source rated at 4kVA in 2Ø mode.

ASX Power Source Specifications (PF = 1.0, V_{out} > 25% F.S.)

Output Frequency	Line Regulation	Load Regulation (Typ. 3 Phase)	Output Distortion	Ripple and Noise	Response Time
Full Power 15-1,200Hz Direct Coupled 45-1,200 Hz Transformer Coupled	0.1% max for a ±10% line change	3Ø direct coupled: 0.25% 15 to 400 Hz, 0.50% 400 to 1,200 Hz. 3Ø transformer coupled: 2 to 5% depending on ratio Improves to less than 0.1% with external sense and CSC enabled	0.25% THD _{AVG} 15 to 200 Hz 1.25% THD _{AVG} 200 to 1,200 Hz	-66dB	60 µsec typical, 10-90% load step

Input Power Requirements (47-63 Hz)

Input Voltage	208V 3ØΔ ±10%	220V 3ØΔ ±10%	240V 3ØΔ ±10%	220/380V 3ØΔ ±10%	230/400V ±10%	240/416V ±10%	277/480V ±10%
Input Current	20A _{rms}	18A _{rms}	16A _{rms}	11A _{rms}	11A _{rms}	10A _{rms}	Cost Option
Recommended Input service	30A	30A	25A	15A	15A	15A	Consult Factory

* Power Source equipped with soft start feature. In-rush current at application of input power will not exceed recommended input service.

Power Factor Rating Curves

Rated Continuous load current as a function of Power Factor and Output Voltage-Nominal Input Line

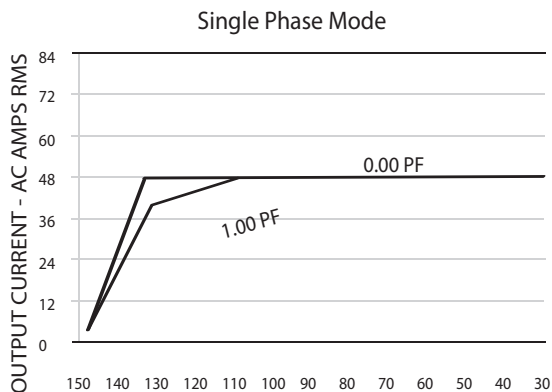

OUTPUT VOLTAGE - AC VOLTS RMS

Short term overloads to 60A are permitted. Operating time before thermal shutdown or circuit breaker trip varies from seconds to several minutes depending upon line and temperature conditions.

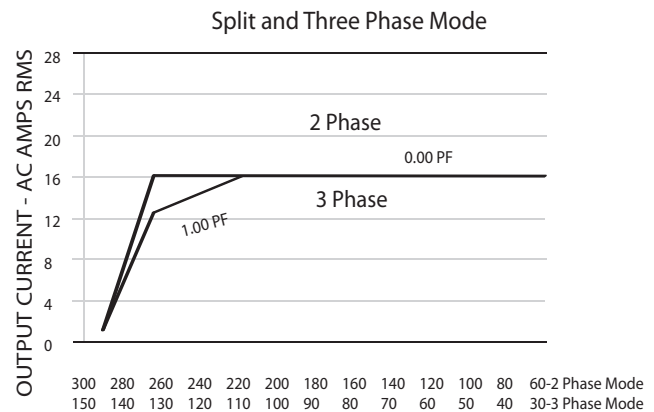

OUTPUT VOLTAGE - AC VOLTS RMS

Short term overloads to 20A are permitted. Operating time before thermal shutdown or circuit breaker trip varies from seconds to several minutes depending upon line and temperature conditions.

Total Control, Metering, and Analysis of AC Power - Simple, Intuitive Operation

The UPC Controller is a highly versatile one, two, or three phase oscillator/signal generator designed to control any of Pacific's AC Power Sources. Three controller models, UPC-3M, UPC-3, or UPC-32 are offered for use with the 360ASX.

Using the front panel keyboard and display, all controller models provide for selection of power source output mode, coupling, voltage, and frequency. Selecting the correct UPC controller for a given application varies with your test requirement, desired features, and price.

Both the UPC-3 and UPC-32 Controllers are available with either RS-232 or GPIB remote interface. Commands are structured in accordance with SCPI (Standard Commands for Programmable Instruments).

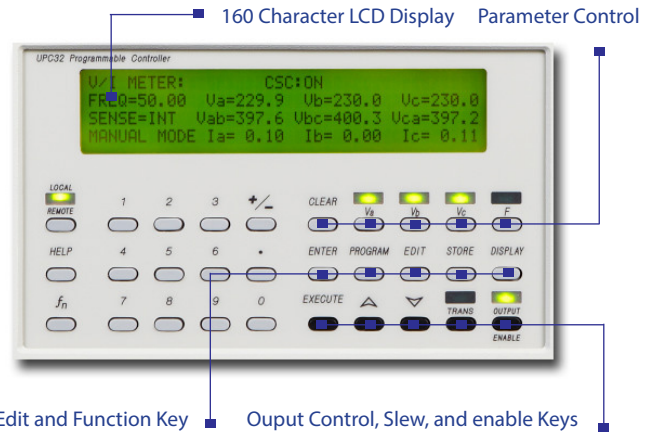

Controller Models

Features	UPC-3M	UPC-3	UPC-32
Output Modes	1Ø, 2Ø, & 3Ø	1Ø, 2Ø, & 3Ø	1Ø, 2Ø, & 3Ø
Waveform Library	Sine	Sine + 21 Editable	Sine + 15 Editable
Transient Functions	NO	YES, 50 Steps	YES, 99 Steps
Program Library	NO	99 Programs	99 Programs
Programmable Current Limit	YES	YES	YES
Programmable Current Protect	YES	YES	YES
Programmable Phase Angle	NO	YES, 0 to 359°	YES, 0 to 359°
CSC (Continuous Self-Calibration)	YES	YES	YES
Remote Interface	Std	NONE	GPIB
	Opt	NONE	RS-232
Waveform Synthesis/Analysis	NO	OPTIONAL	OPTIONAL
Prog. Output Impedance	NO	OPTIONAL	OPTIONAL
Inrush Peak Detect	NO	OPTIONAL	NO
DRM Link-Synchronization	NO	NO	OPTIONAL
Line Synchronization	NO	NO	OPTIONAL

Output Control Specifications

	UPC-3M/UPC-3	UPC-32
Frequency	Range	15-1,200Hz
	Resolution	4 Significant Digits
	Accuracy	±0.01% of full scale
Voltage	Range (l-n)	0 - 150/375
	Resolution	0.1V/ 0.5V
	Accuracy	0.5% of full scale (CSC Disabled) ±0.05% referenced to Internal Meter (CSC Enabled)
Phase Angle ØB and ØC relative to ØA	Range	0 - 359°
	Resolution	± 1°
	Accuracy	15.00 - 150Hz, ± 0.5° 15.00 - 300 Hz, ± 1° 15.00 - 600 Hz, ± 2° 15.00 - 1,200Hz, ± 3°
Current Limit	Range	1Ø = 0 - 300 Apk 3Ø = 0 - 100 Apk
	Resolution	0.05% F.S.
	Accuracy	±3% F.S. ±1% F.S.

(1) Full power output limited to 1,200 Hz in ASX models

External Inputs/Outputs

Analog Auxiliary Input	Each phase is algebraically summed with UPC waveform and amplified 25X to the direct coupled output. ±10Vpk (20Vpk-pk). One input per phase. $Z_{in} = 600 \Omega$
AM-Amplitude Modulation	±10 Vdc (20Vpk-pk) modulates the output voltage ±100% One input per phase. $Z_{in} = 600 \Omega$
Sync Outputs Zero Crossing	Positive Zero Crossing (0°) of Phase A analog output
Transient Trigger	Pulse at the start of a transient event. (UPC-32 only)
Transient Pedestal	TTL True when a transient is in progress
Output Clock	UPC-3, TTL level pulse rate varies with output frequency UPC-32, TTL level 1024 x output frequency

Waveform Control

Waveform Synthesis (/HAS Option)	Creates waveform by entering magnitude as % of fundamental and specified phase angle for 2nd through the 51st harmonic
Waveform Analysis (/HAS Option)	Reports waveform harmonic content and phase angle relative to the fundamental for the 2nd through the 51st harmonic as Total, Odd, and Even harmonic distortion

Output Metering

	UPC-3M/UPC-3	UPC-32
Voltmeter True V_{rms} each phase	Range	0-354 V _{l-n} , 708V _H
	Resolution	0.1 Vrms front panel, 0.001 Vrms via remote interface
	Accuracy	±0.2% F.S. plus Cal ref. 50-500Hz, ± 0.25% or rdg. ± 0.1% F.S. 20-5,000 Hz, ± 0.5% F.S.
Ammeter True A_{rms} and Apk each phase	Range	1Ø = 120 Apk, 3Ø = 40Apk
	Resolution	0.01 Arms or peak front panel, 0.001 Arms via remote interface
	Accuracy	±0.2% F.S. plus Cal ref. ±0.25% of rdg. 50-500Hz, ± 0.1% F.S. 20-5,000 Hz, ± 0.5% F.S.
Power Meter True Watts and Volt-Amps each phase	Range	1Ø = 42,480Ø (W or VA), 3Ø = 28,320Ø (W or VA)
	Resolution	1.0 Watt or VA to front panel, 0.001 kW or kVA via remote interface
	Accuracy	1% full range ±0.25% of rdg. plus 50-500Hz, ± 0.1% F.S. 20-5,000 Hz, ± 0.5% F.S.
Power Factor Ratio: kW_{mtr}/kVA_{mtr}	Resolution	Calculated and displayed to three digits following the decimal point.
	Accuracy	± 1% full range
Crest Factor Ratio: Apk/Arms	Resolution	Calculated and displayed to three digits following the decimal point.
	Accuracy	± 1% full range
Freq. Display	Range	15.00 - 1,200 Hz 20.00 - 5,000Hz
	Resolution	10.00-99.99 Hz, 0.01 Hz 100.0-999.9 Hz, 0.1 Hz 1,000-5,000 Hz, 1 Hz
	Accuracy	± 0.01% full range

360ASXT-UPC3 Power Source with external transformer module

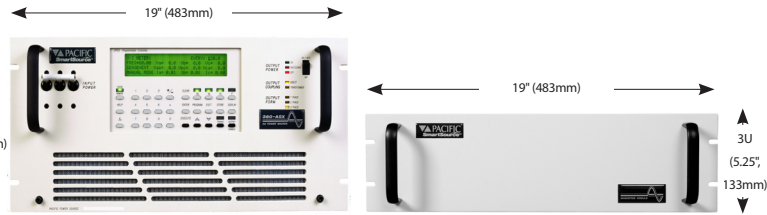
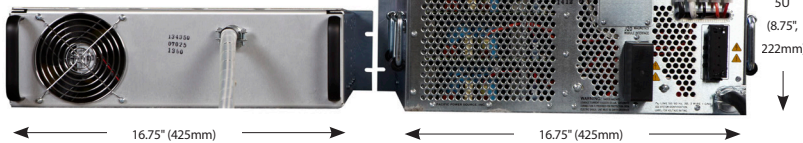

360ASXT-UPC3 Power Source shown with external high range magnetics module.

General/Environmental

Temperature:	Operating: 0° to 55° C Storage: -10° to 70° C
Humidity:	0 - 95%, Non-condensing
Cooling:	Front and side forced air intake (300 CFM) with rear exhaust. Automatic Fan Speed Control for low acoustic noise and extended fan life.
Altitude:	Operating: 6,500 Ft (1,981 m) Storage: 40,000 Ft (12,192 m)
Heat Dissipation:	2.5kBTU/ hr (Full kW Load)
Audible Noise:	Variable speed fans 65 dba Max @ 1 Meter
Agency Approvals:	Safety UL 61010 -1 EN 61010 -1 EMC EN 61326 -1

Protection and Safety

Hardware	Over-current, short circuit, over-temperature
Programmable Current Limit	A single RMS programmed, average responding, value provided for all phases. Limits current by reducing output voltage.
Programmable Current Protect	Allows the power source to operate in "constant voltage" mode, interrupting output when specified current protect limit is exceeded.

Mechanical Specifications

Height	360ASX: 5U (8.75", 222mm) Transformer Module: 3U (5.25", 133mm)
Depth	360ASX: 23.12" (587mm) Transformer Module: 23.5" (597mm) (Approx. from front panel to the rear of chassis).
Weight	360ASX - 145 lbs (66kg) Transformer Module: 125 lbs (56.8 kg)
Mounting	Standard 19" rack (483mm). Cabinet options available.

Hardware Options

/M7073	Safety Interlock Normally Open Contacts
/M99413	Safety Interlock Normally Closed Contacts
/P000828	15U rack enclosure, heavy duty vertical cabinet with casters and rear screen. Ordered as separate line item.
/MXXXXX	Other factory specified modification

Software/Firmware Options

/S	RS-232 Interface, 38.4 Kbps (std UPC-3)
/G	GPIB Interface, IEEE-488.2, (std UPC-32)
/Prog-z	Programmable Output Impedance (not available with UPCxM)
/HAS	Harmonic Analysis and Synthesis (not available with UPCxM)
/IR	In-Rush Meter. Capture and view peak in-rush current values via front panel or remote interface (UPC-3 only).
Test MGR	UPC Test Manager License: Create, edit, and execute Test sequences and reports. Ordered as separate line item.
Test SEQ	Avionics test sequences; DO-160, ABD-0100, ABD-0100 (A350), Ordered as separate line item, Requires 'Test' Manager License.

Ordering Information

Model	Controller	Options	T-Ratio (360ASXT Only)	Input Voltage (V_{IN})
<input type="checkbox"/> 360ASX	<input type="checkbox"/> UPC3M	See List Above	<input type="checkbox"/> Ratio 1.5:1	<input type="checkbox"/> 208 VACΔ ± 10%, 47-63Hz
<input type="checkbox"/> 360ASXT	<input type="checkbox"/> UPC3 <input type="checkbox"/> UPC32		<input type="checkbox"/> Ratio 2.0:1 <input type="checkbox"/> Ratio 2.5: 1	<input type="checkbox"/> 220VACΔ ± 10%, 47-63Hz <input type="checkbox"/> 240VACΔ ± 10%, 47-63Hz <input type="checkbox"/> 220/380VACΔ ±10%, 47-63Hz <input type="checkbox"/> 230/400VACΔ ±10%, 47-63Hz <input type="checkbox"/> 240/416 VACΔ ±10%, 47-63Hz

Available Models

With Manual Controller

360ASX-UPC3M
360ASXT-UPC3M

With Programmable Controller

360ASX-UPC3 360ASXT-UPC3
360ASXT-UPC32 360ASXT-UPC32



17692 Fitch, Irvine, CA 92614 USA
Phone: +1 949.251.1800
Fax: +1 949.756.0756
Toll Free: 800.854.2433
E-mail: sales@pacificpower.com
www.pacificpower.com

Order Example

360ASXT-UPC3/G, T= 2.0:1, V_{IN} : 220/380VAC

- 6 kVA, 3-Phase, AC Power Source with optional transformer assembly and UPC-3 programmable controller.
- Optional GPIB Interface
- 2.0:1 Transformer Ratio
- 220/380V, 3 Phase Input Voltage

Typical Delivery Items

- AC Power Source
- English Manuals (AC Source and Controller)
- UPC Studio Software - (Download)
- UPC Interactive LabVIEW™ Libraries (Download)
- Compliance Certificate with Test data
- CE Conformity Document (CE Models)