



PCE Americas Inc.
 711 Commerce Way
 Suite 8
 Jupiter
 FL-33458
 USA
 From outside US: +1
 Tel: (561) 320-9162
 Fax: (561) 320-9176
 info@pce-americas.com

PCE Instruments UK Ltd.
 Units 12/13
 Southpoint Business Park
 Ensign way
 Hampshire / Southampton
 United Kingdom, SO31 4RF
 From outside UK: +44
 Tel: (0) 2380 98703 0
 Fax: (0) 2380 98703 9
 info@industrial-needs.com

www.pce-instruments.com/english
 www.pce-instruments.com

Manual

Gas Detector PCE-WMM 50



Version 1.0
 Date of creation: 31.05.2016
 Date of last change: 28.11.2017

Contents

1	Safety notes	3
2	Specifications	4
2.1	Technical specifications	4
2.2	Delivery content	5
3	System description	6
3.1	Device	6
3.2	Display	9
4	Getting started	10
4.1	Preparation	10
4.2	Power connection	11
5	Operation	12
5.1	Further measuring functions	12
5.2	Settings	13
6	Maintenance	14
6.1	Repair, cleaning and maintenance	14
6.2	Troubleshooting	16
7	Contact	16
8	Disposal	17
9	Contact	17
9.1	PCE Instruments UK	17
9.2	PCE Americas	17

Thank you for purchasing a gas detector from PCE Instruments.

1 Safety notes

Please read this manual carefully and completely before you use the device for the first time. The device may only be used by qualified personnel and repaired by PCE Instruments personnel. PCE Instruments cannot be held liable for any damage or injuries caused by non-observance of the manual.

- The device must only be used as described in this instruction manual. If used otherwise, this can cause dangerous situations for the user and damage to the meter.
- The instrument may only be used if the environmental conditions (temperature, relative humidity, ...) are within the ranges stated in the technical specifications. Do not expose the device to extreme temperatures, direct sunlight, extreme humidity or moisture.
- When the air quality meter is exposed to extreme heat, fire and explosions as well as deformations of the device are very likely.
- Do not expose the CO₂ analyser to any impact, shocks or vibration.
- The case should only be opened by qualified PCE Instruments personnel. Touching the electrical conductor inside the instrument can cause electric shocks.
- Never use the meter when your hands are wet.
- You must not make any technical changes to the device.
- The appliance should only be cleaned with a damp cloth. Use only pH-neutral cleaner, no abrasives or solvents.
- The device must only be used with accessories from PCE Instruments or equivalent. Using the wrong mains adaptor can cause damage to the device as well as fatal injuries of the user.
- The mains adaptor should be fixed tightly with the elastic plug lock, so that it can only be removed using mechanical tools.
- If you wish to connect a fan to the potential-free contacts of the sensor unit, make sure that the fan has its own external power supply. Otherwise, the fan will not work. This can cause dangerously high CO₂ concentrations in the monitored area.
- Before each use, inspect the case for visible damage. If any damage is visible, do not use the device.
- Do not use the instrument in explosive atmospheres.
- Pay special attention to the "ESC" indication in the display. If it appears, adopt protective measures before entering the room where the sensor unit has been installed.
- Check the cable connection between the sensor unit and the remote display unit thoroughly. The cable is connected to the remote display unit's input, coming from the sensor unit.
- Communication between the sensor unit and the remote display unit should work flawlessly. Therefore, you should use the "DIAG" function to test flawless communication.
- The limit values for the measuring variables as stated in the specifications must under no circumstances be exceeded.
- Non-observance of the safety notes can lead to damage of the device or injuries of the user.
- Moreover, observe the applicable national health and safety regulations and those set up by the relevant trade associations in your country, as well as any relevant regulations for safe and professional operation. Particularly, make sure to comply with your national accident prevention regulations for the handling of gases.



This instruction manual is published by PCE Instruments without any guarantee.

We expressly point to our general guarantee terms which can be found in our general terms of business.

If you have any questions please contact PCE Instruments.

Safety symbols

Safety-related instructions the non-observance of which can cause damage to the device or personal injury carry a safety symbol.

Symbol	Designation / description
	General safety symbol Non-observance can cause personal injury and/or damage to the device.
	Warning of electric voltage Non-observance can cause electric shocks.

2 Specifications

2.1 Technical specifications

Sensor unit	
Measured gas	carbon dioxide (CO ₂): 0 ... 50,000 ppm (5 %) (vol.) NDIR sensor
Temperature (gas / environment)	0 ... +45 °C
Supply of gas samples	by diffusion
Alarm contacts	- 1 potential-free normally open contactor to control external devices by releasing alarm 1 - switching power: 30 V DC / 250 V AC, max. 2 A
Alarm thresholds	Alarm 1 0.5 / 1 / 1.5 / 2 % Alarm 2 1.5 / 2 / 2.5 / 3 / 3.5 / 4 %
Menu items	Function test of connection between sensor unit and remote display unit, calibration, switching between °C and °F, alarms 1, 2 and factory default settings
Display elements	- 4-digit digital display for measured gas concentration within range 0 ... 9999 ppm - 3-digit digital display for measured gas concentration within range 1 ... 5 % - additional 3-digit digital display for measurement and temperature in °C and °F - LEDs for operation, alarms 1, 2 and monitoring of voltage supply
Operating elements	Reset, menu selection, Enter
Safety	continuous self-surveillance of temperature range, sensor life, implausible values, EEPROM system, internal data transfer
Enclosure	plastic, IP 54, splash-water proof
Voltage Supply	Mains adaptor 100 ... 240 V AC, 50 / 60 Hz
Diameters	168 x 125 x 47 mm (without connections)

Remote display unit	
Temperature (gas / environment)	0 ... +45 °C
Menu items	- 4-digit digital display for gas concentration within range 0 ... 9999 ppm - 3-digit digital display for concentration within range 1 ... 5 % - additional digital display to measure temperature in °C and °F - LEDs for operation, alarms 1, 2 and monitoring of voltage supply
Display elements	Function test, Reset, menu selection, Enter, shifting between °C and °F
Enclosure	aluminium, IP 54, splash-water proof
Voltage supply	via data cable to gas detector
Dimensions	118 x 85 x 34 mm (without connections)

2.2 Delivery content

- 1 x gas detector PCE-WMM 50
- 1 x instruction manual

3 System description

3.1 Device

The gas detector PCE-WMM 50 is equipped with a buzzer as well as a visual indication. These are activated when the CO₂ concentration reaches or exceeds a threshold previously set. Also, high CO₂ concentrations activate a potential-free contact which can, for instance, activate a fan which reduces the increased CO₂ concentration in the room concerned.

Sensor unit

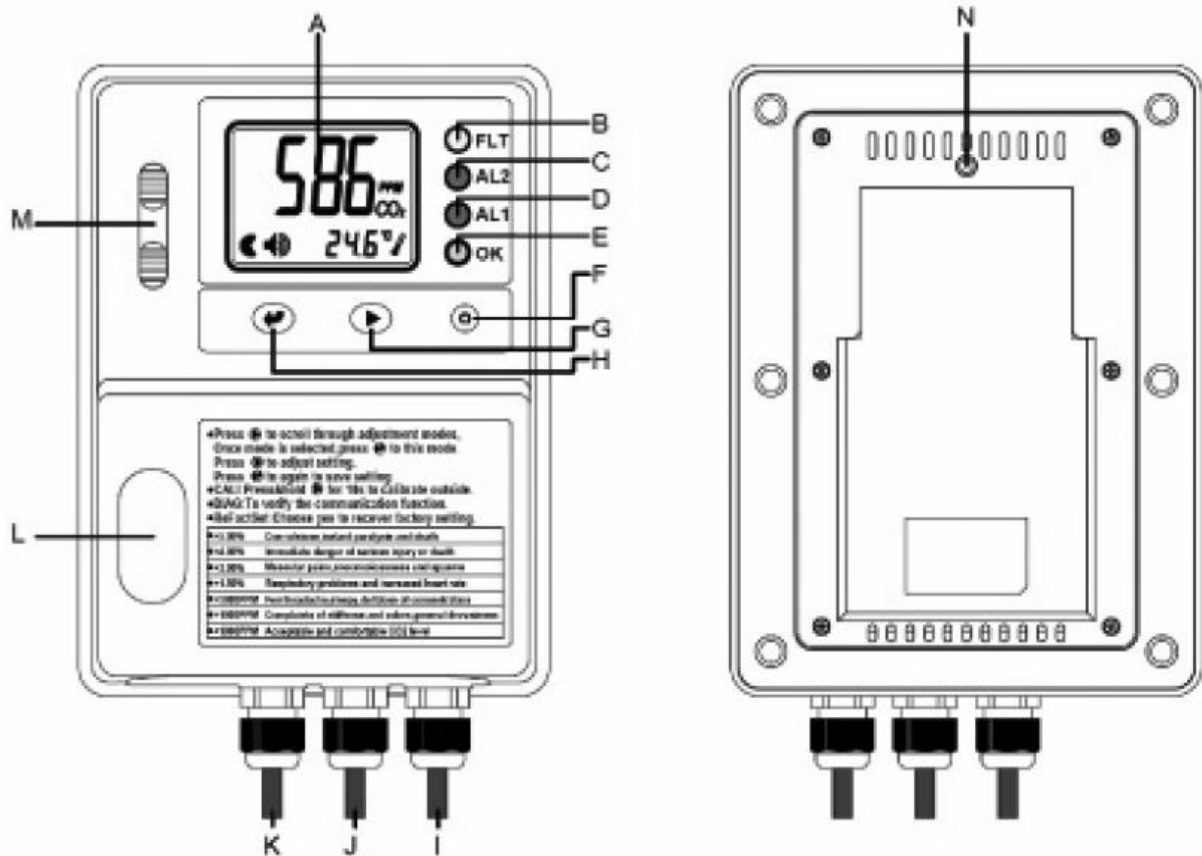

- A LC display
- B Yellow LED (error indication)
- C Red LED 2 (AL2)
- D Red LED 1 (AL1)
- E Green LED (power supply)
- F Reset key
- G Mode key
- H Enter key
- I Communication cable to remote display
- J Potential-free contact:
 - Red cable
 - White cable
 - Blue cable (central contact of the relay)
- K Power supply
- L Rubber protective cap
- M Gas input
- N Buzzer

The sensor unit must be installed in the room to be inspected, such as a room where CO₂ gas bottles are stored. The LC display shows the CO₂ concentration in the ambient air as well as the temperature. When the green LED glows constantly, the power supply of the device is granted.



If "ESC" is indicated in the LC display of the remote display unit, you must adopt protective measures before entering the room where the sensor unit has been installed. Check the room's ventilation and find out whether there is a CO₂ leak, wearing protective clothing / equipment. As soon as the CO₂ concentration in the ambient air has reached the second alarm threshold, "ESC" appears in the display of the sensor unit as well as in the display of the remote display unit. The yellow LED "FLT" (standing for fault) flashes. Use the „ReFactSet“ function to reset the gas leak detector to factory defaults. The "ESC" indication should now disappear. Alternatively, you can remove the mains adaptor and plug it back into the socket.

The sensor unit has the following functions:

- DIAG** Communication test between sensor unit and remote display unit
- CAL** Calibration of gas detector
- ReFactSet** Reset to factory default settings

You can set two alarm thresholds:



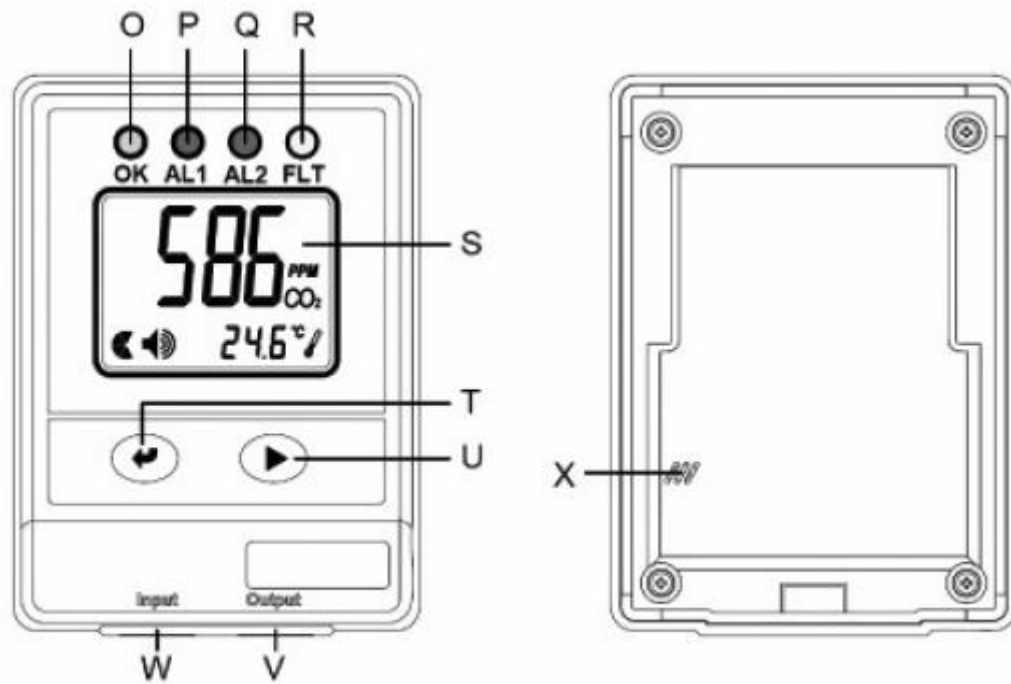

AL1	AL2
<p>1. Alarm threshold</p> <p>Selectable threshold values: 0.5 %; 1 %; 1.5 %; 2 % (Factory default setting: 1.5 %)</p> <p>When the CO₂ concentration exceeds the first threshold value, the red AL1 LED (LED 1) will flash, the buzzer will sound and the potential-free contact will close if the red and blue cables are connected or closes when the white and blue cables are connected.</p> <p>The AL1 LED will stop flashing and the buzzer will stop sounding as soon as the CO₂ concentration falls below the first alarm threshold value.</p>	<p>2. Alarm threshold</p> <p>Selectable threshold values: 1.5 %; 2 %; 2.5 %; 3 %; 3.5 %; 4 % (Factory default setting: 3 %)</p> <p>When the CO₂ concentration exceeds the second threshold value, the red AL1 and AL2 LEDs will flash at the same time, the time between the buzzer intervals becomes shorter and „ESC“ appears in the LC display.</p> <p>When the CO₂ concentration falls below the second alarm threshold, even if it falls below the first alarm threshold, the red AL1 and AL2 LEDs will keep flashing and the buzzer will sound until you restart the device. To restart the gas meter, press the "Reset" key (F) or disconnect the mains plug from the socket and plug it back in.</p>

Remote display unit

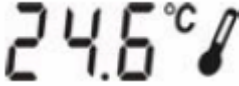

- O Green LED (power supply)
- P Red LED 1 (AL1)
- Q Red LED 2 (AL2)
- R Yellow LED (error indication)
- S LC display
- T Enter key
- U Mode key
- V RJ45 connection (Output)
- W RJ45 connection for sensor unit (Input)
- X Buzzer

3.2 Display

Symbol	Meaning	Description
	CO ₂ concentration in ppm	CO ₂ concentration in the monitored room
	Temperature (degrees Centigrade)	Temperature in the monitored room in degrees Centigrade
	Temperature (degrees Fahrenheit)	Temperature in the monitored room in degrees Fahrenheit
	Alarm	Alarm icon
DIAG	Diagnosis	Test of communication between the sensor unit and the remote display unit
AL 1	First alarm threshold	If the CO ₂ concentration exceeds the first alarm threshold, - the red LED 1 flashes, - the buzzer sounds and - the potential-free contact closes if the red and blue cables are connected or closes if the white and blue cables are connected
AL 2	Second alarm threshold	If the CO ₂ concentration exceeds the second alarm threshold, - "ESC" appears in the LCD - the two red LEDs 1 and 2 flash, - the buzzer sounds
CALI	Calibration	Calibration of the CO ₂ sensor if the measurement value deviates too much from the current CO ₂ concentration
ReFactSet	Restore Factory Settings	Deletes all custom settings and restores the factory default settings.
	Escape	Appears once the second alarm threshold is exceeded, what might be a sign of CO ₂ leakage.
	High	The CO ₂ concentration is higher than 5 %.

! If “ESC” is indicated in the LC display of the remote display unit, you must adopt protective measures before entering the room where the sensor unit has been installed. Check the room’s ventilation and find out whether there is a CO₂ leak, wearing protective clothing / equipment. As soon as the CO₂ concentration in the ambient air has reached the second alarm threshold, “ESC” appears in the display of the sensor unit as well as in the display of the remote display unit. The yellow LED “FLT” (standing for fault) flashes. Use the „ReFactSet“ function to reset the gas leak detector to factory defaults. The “ESC” indication should now disappear. Alternatively, you can remove the mains adaptor and plug it back into the socket.

The remote display unit shows the readings and safety warnings of the sensor unit. It is connected to the sensor unit via a communication cable (cable length: max. 8 m). the remote display unit should not be placed in the same room as the sensor unit. It should be mounted in a way which provides high visibility and an easy reading of the CO₂ concentration before entering the room where the sensor unit is located. The connection between both devices can be checked by using the “DIAG” function which is described in the further course of this manual. To reset the PCE-WMM 50, the “Reset” key on the sensor unit is used.

4 Getting started

4.1 Preparation

! When taking the PCE-WMM 50 out of its box, remove the protective rubber cap from the gas input (M) and put it to position L. During operation, make sure that the gas input (M) is not blocked at any time.

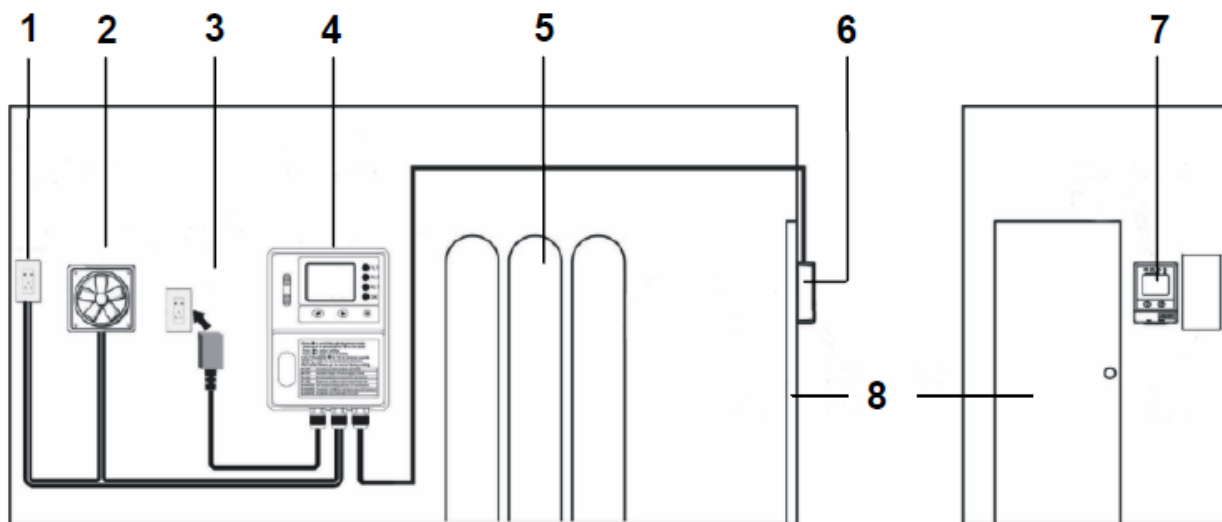

- 1 power supply (ventilation)
- 2 fan
- 3 mains adaptor
- 4 sensor unit
- 5 gas bottles
- 6 / 7 remote display unit
- 8 door

Open the box and take out the sensor unit, the remote display unit and all accessory parts.

Mount the sensor unit in the area which you want to monitor. It should be placed 0.45 m above the ground and as near as possible to the pipes and valves. Mount the wall mounting to a wall by using 4 screws. The sensor unit can be placed in the mounting afterwards. Make sure that the sensor unit sits in the mounting tightly.

Mount the remote display unit outside of the room to be monitored. Mount the wall mounting to the wall by using screws. The display unit can be placed in the mounting afterwards. Make sure the display unit sits in the mounting tightly.

Connect the sensor unit to the remote display unit by using the communication cable which is wired to the sensor unit. Make sure the cable is run properly and attach it to the wall by using cable clips. Once it is plugged in the remote display unit, the devices can communicate with each other.

There is also a potential-free contact (J) wired to sensor unit which can be used to turn on or off a fan, for example, which is used for ventilation of the monitored room. When the red and white cables are connected, the contact closes. When the white and blue cables are connected, the contact closes.

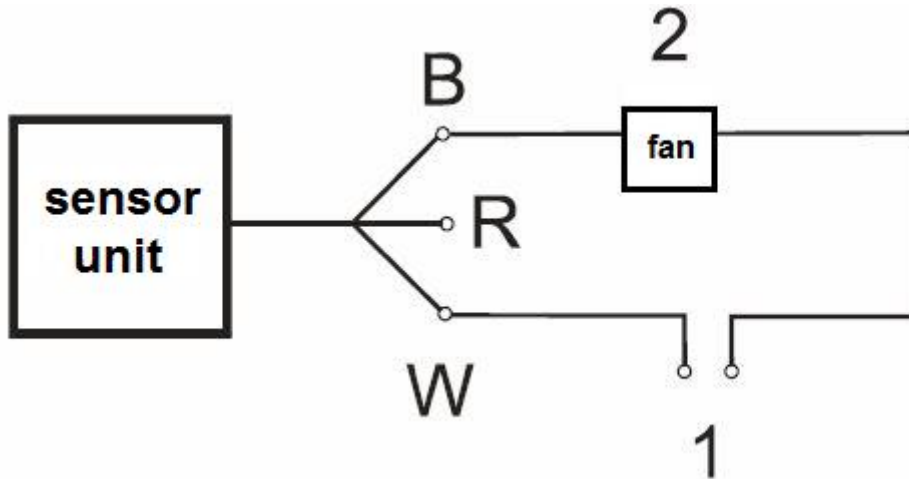

- B blue cable
- R red cable
- W white cable
- 1 power connection fan
- 2 fan

4.2 Power connection

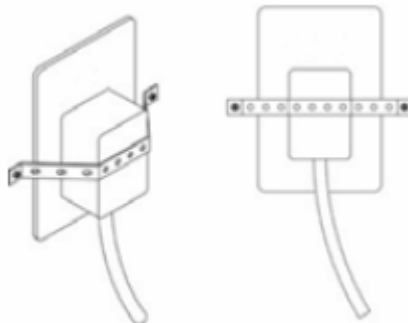

Connect the mains adaptor to the wall socket. Attach the elastic safety strip to the power plug by using screws and wall plugs. The strip should sit so tight that the plug cannot be pulled out of the socket without using mechanical tools. Once the mains adaptor is connected to the power source, the Sensor unit and the remote display unit start monitoring.

Check the communication between both devices by using the “DIAG” function which is described in the further course of this manual. If all four LEDs flash and the buzzer makes a sound the communication is good and both devices show the same readings on their displays.

5 Operation

! When the remote display unit shows “ESC” you should take necessary safety actions before entering the monitored room. Check the ventilation of the room and find out if there is CO₂ leakage while using proper safety equipment. Once the CO₂ concentration in the air exceeds the second alarm threshold, both devices (sensor unit and remote display unit) show an “ESC” indication on their displays. The yellow LED “FLT” starts to flash. Use the “ReFactSet” function to restore the factory settings of the gas detector. The “ESC” indication should disappear. You can also unplug the power plug from the wall socket and plug it in again.

! Make sure that the power plug sits in the wall socket tightly and that it is secured with the elastic safety strip so that it cannot be unplugged without using mechanical tools.

! When you take the PCE-WMM 50 out of its box, remove the protective rubber cap from the gas input (M) and put it in position L. During operation, you should make sure that the gas input (M) is not blocked.

Once the mains adaptor is connected to a power source, the gas detector starts monitoring the CO₂ concentration in the ambient air, as well as the ambient air temperature. Set up the threshold levels in a way that the alarms are triggered early.

5.1 Further measuring functions

“DIAG” function

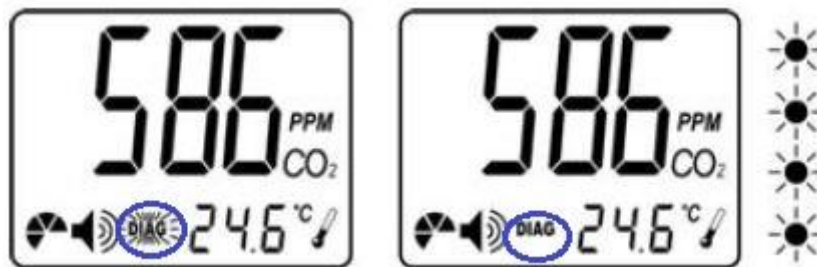

The communication between the sensor unit and the remote display unit should be checked on a regular basis by using the “DIAG” function. To do so, press the “Mode” key until a “DIAG” indication appears on the display. Now press the “Enter” key for confirmation. All four LEDs on the sensor unit should now start to flash and the buzzer should make a noise. After that the same should happen with the remote display unit as well. If this worked properly, the communication between both devices is good.

Calibration function

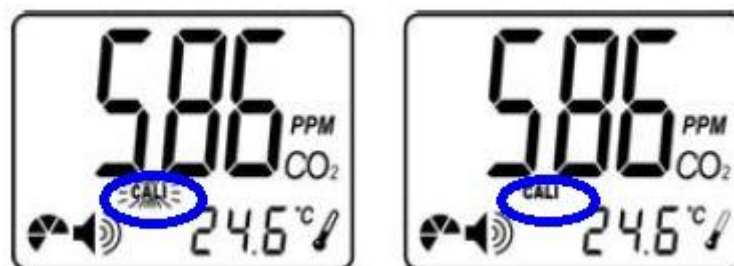

The gas detector should be calibrated at least every two years. To do so, you can use the ambient air outdoors. The housing needs about 10 minutes to acclimate. Wait until the CO₂ reading on the display is stable. The display should indicate between 380 and 420 ppm.

Do not breathe in the direction of the gas detector while calibrating it. This might falsify the readings. Press the “Mode” key until a flashing “Cali” indication appears on the display. After that, press “Enter” to confirm. Now the “Cali” indication is shown on the display continuously. Press and hold the “Mode” key for at least 10 seconds. The calibration is carried out automatically. After 10 minutes, the display shows “Pass” or “Fail”. “Fail” means that the calibration failed and has to be done again. “Pass” means that the calibration was successful. Press the “Enter” key to exit the calibration function.

Restore factory settings



Using this function deletes all stored settings and sets the device back to factory default settings. This might be reasonable if the calibration has not been done properly, for example.

To reset the gas detector, press the “Mode” key until “ReFactSet” appears on the display. Now press the “Enter” key and the “mode” key afterwards. Now you can select between “Yes” and “No”. Confirm your selection by pressing “Enter”. When “Yes” was selected, the factory default settings are restored after the confirmation.

5.2 Settings

Lock/unlock



The gas detector has an automatic lock function to prevent the settings from being changed unintentionally. If you wish to adjust the settings you have to unlock the device first. To do so, press and hold the “Mode” key and the “Enter” key at the same time for 5 seconds. Now the device is unlocked and you can change the settings. After 30 minutes, the device will be locked again. To activate the lock function manually, press and hold the “Mode” and “Enter” key once again for 5 seconds.

Change the temperature unit

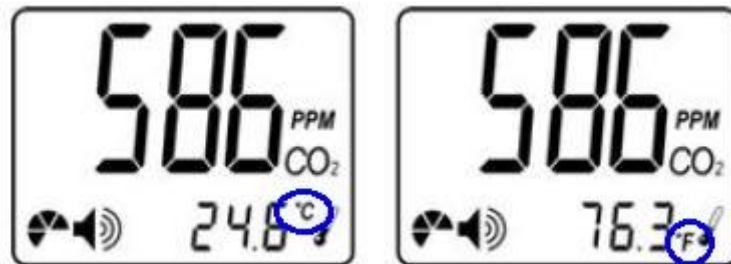

To switch between “°C” and “°F”, press the “Enter” key.

AL1 and AL2 threshold levels

AL1

To adjust the AL1 threshold level, press the “Mode” key until “AL1” appears on the display and press “Enter” to confirm. Now you can switch between the available options by pressing the “Mode” key. The following options are available: 0.5 %, 1 %, 1.5 %, 2 %. Select the desired option and press the “Enter” key to confirm.

AL2

To adjust the AL2 threshold level, press the “Mode” key until “AL2” appears on the display and press “Enter” to confirm. Now you can switch between the available options by pressing the “Mode” key. The following options are available: 1.5 %, 2 %, 2.5 %, 3 %, 3.5 %, 4 %. Select the desired option and press the “Enter” key to confirm.

6 Maintenance**6.1 Repair, cleaning and maintenance****Repairing**

Do not try to repair the gas detector on your own and do not manipulate the circuits. If the device is broken, please send it back to PCE Instruments. Our trained personnel will repair the device, if possible, and send it back to you.

Behaviour in case of CO₂ leakage

If the remote display unit shows “ESC”, you should take proper safety actions before entering the monitored room where the sensor unit is located. Check the ventilation of the room and find out if there is a CO₂ leakage while using proper safety equipment.

Cleaning

Before cleaning the gas detector, unplug the mains adaptor. Then clean the device with a damp cloth. Use only pH neutral cleaner, no abrasives or solvents. Liquid cleaning agents might damage the device.

 Before cleaning the room where the sensor unit is located, put the protective rubber cap on the gas input (M) to prevent water from getting into the device.



Maintenance

The communication between the sensor unit and the remote display unit should be checked on a regular basis by using the “DIAG” function. If the buzzer on each device makes a noise and all four LEDs flash on each device, the communication between both devices works properly.

The gas detector should be calibrated at least every two years.

Check the proper functionality of the gas detector at least every two years.

6.2 Troubleshooting

Error code	Possible cause	Indication		Possible solution
		Sensor unit	Remote display unit	
Er3	Ambient temperature exceeds measuring range (0 ... +50 °C // 32 ... 122 °F)	- "Er3" flashing - LED "FLT" flashing - buzzer makes noise	- "Er3" flashing - LED "FLT" flashing - buzzer makes noise	Indications disappear once the ambient temperature is within the measuring range
Er4	Measuring error or sensor reached the end of its lifetime	- "Er4" flashing - LED "FLT" flashing - buzzer makes noise	- "Er3" flashing - LED "FLT" flashing - buzzer makes noise	Unplug the power plug from the wall socket and plug it in again. If this does not help please contact our customer support.
Er5 Er6	EEPROM problem	- "Er5" and "Er6" flashing - LED "FLT" flashing - buzzer makes noise	- "Er5" and "Er6" flashing - LED "FLT" flashing - buzzer makes noise	Unplug the power plug from the wall socket and plug it in again. If this does not help please contact our customer support.
Er7	Internal data transfer error	- "Er7" flashing - LED "FLT" flashing - buzzer makes noise	- "Er7" flashing - LED "FLT" flashing - buzzer makes noise	Unplug the power plug from the wall socket and plug it in again. If indication only appears on remote display unit: check the RJ45 plug on the communication cable and the RJ45 input (W).
Er8	Accuracy of the CO ₂ sensor might deviate from current CO ₂ concentration	- "Er8" flashing - LED "FLT" flashing - buzzer makes noise	- "Er8" flashing - LED "FLT" flashing - buzzer makes noise	Unplug the power plug from the wall socket and plug it in again. If this does not help please contact our customer support.
°C / °F	Internal data transfer error	-	- °C / °F flashing	Check the RJ45 plug on the communication cable and the RJ45 input (W).
LED "FLT"	Mains adaptor not connected properly	- LED "FLT" flashing		Unplug the power plug from the wall socket and plug it in again.

7 Contact

If you have any questions, suggestions or technical problems, please do not hesitate to contact us. You will find the relevant contact information at the end of this user manual.

8 Disposal

For the disposal of batteries, the 2006/66/EC directive of the European Parliament applies. Due to the contained pollutants, batteries must not be disposed of as household waste. They must be given to collection points designed for that purpose.

In order to comply with the EU directive 2012/19/EU we take our devices back. We either re-use them or give them to a recycling company which disposes of the devices in line with law.

If you have any questions, please contact PCE Instruments.



9 Contact

If you have any questions about our range of products or measuring instruments please contact PCE Instruments.

9.1 PCE Instruments UK

By post:

PCE Instruments UK Ltd.
Units 12/13 Southpoint Business Park
Ensign Way, Southampton
Hampshire

United Kingdom, SO31 4RF

By phone:

02380 987 035

9.2 PCE Americas

By post:

PCE Americas Inc.
711 Commerce Way
Suite 8
Jupiter
33458 FL
USA

By phone:

561 320 9162