



PCE Americas Inc.
711 Commerce Way
Suite 8
Jupiter
FL-33458
USA
From outside US: +1
Tel: (561) 320-9162
Fax: (561) 320-9176
info@pce-americas.com

PCE Instruments UK Ltd.
Units 12/13
Southpoint Business Park
Ensign way
Hampshire / Southampton
United Kingdom, SO31 4RF
From outside UK: +44
Tel: (0) 2380 98703 0
Fax: (0) 2380 98703 9
info@pce-instruments.com

www.pce-instruments.com/english
www.pce-instruments.com

Manual

Moisture Meter

PCE -A 315



Version 1.0
Date of creation: 13.04.2016
Date of last change: 09.05.2016

Contents

1	Introduction	2
2	Safety notes	2
3	Specifications	3
3.1	Specifications sensor.....	3
3.2	Specifications control unit.....	3
4	System description	3
4.1	Principle of operation.....	3
4.2	Control unit	4
5	Instructions.....	6
5.1	Product selection and moisture measurement.....	6
5.2	Trend view	9
5.3	Corrections / settings.....	10
5.4	Time and date.....	16
5.5	Installation of the moisture sensors.....	17
5.6	Troubleshooting.....	19
6	Disposal	21
7	Contact.....	21
7.1	PCE Instruments UK	21
7.2	PCE Americas	21

1 Introduction

Thank you for purchasing a microwave moisture sensor from PCE Instruments. This microwave moisture sensor can be used for the continuous measurement of the moisture content of goods like grains, beans, rice, nuts, powder, coal, paste, biomass and soil on conveyor systems or in silos. PCE Instruments offers delivery, modification and on-site installation, calibration and maintenance in Western Europe, the United States, Canada, and South America. The default calibration curves of this moisture analyser allow for continuous, automated measurement of absolute moisture content in goods like grains, legumes, and oil seeds. Since grain-drying is an energy intensive process, controlling this drying process offers tremendous cost savings. The online moisture analyzer is particularly well suited for this task when it is employed during the drying process and before milling the grain. The microwave moisture sensor makes a quick and accurate measurement possible.

2 Safety notes

Please read this manual carefully and completely before you use the device for the first time. The device may only be used by qualified personnel and repaired by PCE Instruments personnel. There is no warranty of damages or injuries caused by non-observance of the manual.

- The device may only be used in the approved temperature range.
- The case / device should only be opened by qualified personnel of PCE Instruments.
- The instrument should never be placed with the user interface facing objects (e. g. keyboard on a table).
- You must not make any technical changes to the device.
- The appliance should only be cleaned with a damp cloth / use only pH-neutral cleaner.
- After all measurements have been made within one drying season, the sensors should be disassembled and stored in a heated, dry area. Make sure (just like during all measurements) that the device is not directly exposed to any fluids.

This user's handbook is published by PCE Instruments without any guarantee. We expressly point to our general guarantee terms which can be found in our general terms of business. If you have any questions please contact PCE Instruments.

3 Specifications

3.1 Specifications sensor

Measurement range for moisture content during continuous mass flow	5 ... 40 %
Max. absolute error of moisture measurement	±0.5 % (measurement range 5 ... 18 %) ±1.0 % (>18 %)
Temperature necessary for grain flow	+5 ... +55 °C
Ambient temperature	0 ... +55 °C
Output	4 ... 20 mA and / or Modbus RTU
Operation mode	continuous
Power supply	24 VDC
Input power	up to 5 W
Warm-up time at start-up	Max. 60 min
Power consumption	>5 W
Protection class sensor	IP65
Weight	max. 14.5 lbs / 6.5 kg

3.2 Specifications control unit

Display	7" TFT LCD
Interfaces	RS-232, RS-485
Input	4 ... 20 mA
Ambient temperature	0 ... +55 °C
Protection class	IP65
Power supply	100 ... 260 V AC
Power consumption	>25 W
Weight	4.5 kg

4 System description

4.1 Principle of operation

The operating principle of the microwave moisture meter is based on the considerable differences between the ultrahigh-frequency dielectric characteristics of most grains and water. The meter has a ring resonator in the centre of which there is a measuring channel in the form of a dielectric pipe. The parameters of the resonator change when the electromagnetic waves interact with grains of different degrees of moisture.

An important advantage and main feature of this microwave moisture sensor is the fact that due to the simultaneous measurement of two parameters of the resonator (resonant frequency and resonance amplitude) and the special processing algorithm, grain moisture values are practically independent of their densities, which ensures a high reliability and reproducibility of inline moisture measurement results. Moreover, the moisture of the grains is determined without damaging them or causing abrasion of the sensor. Thus, microwave moisture measurement allows for inline non-destructive testing. The transmission power is low, which means that the material does not warm up or deform. One of the most important advantages of microwave measurement is that the core moisture of a product can be determined. Additionally, this method makes huge savings possible, as compared to using traditional moisture balances.

The temperature sensor which is also integrated in the measuring channel allows for an automatic correction of the measured grain moisture value, depending on the grain temperature. The unloaded resonator has a resonant frequency F_0 and an amplitude of A_0 . When wet grains are filled into the measuring channel, the resonant frequency and the amplitude will decrease to F_1 and A_1 or even to F_2 and A_2 . The simultaneous measurement of these parameters makes it possible to determine the material moisture which is independent of the density of the grains. This is one of the most important factors when it comes to getting reliable results.

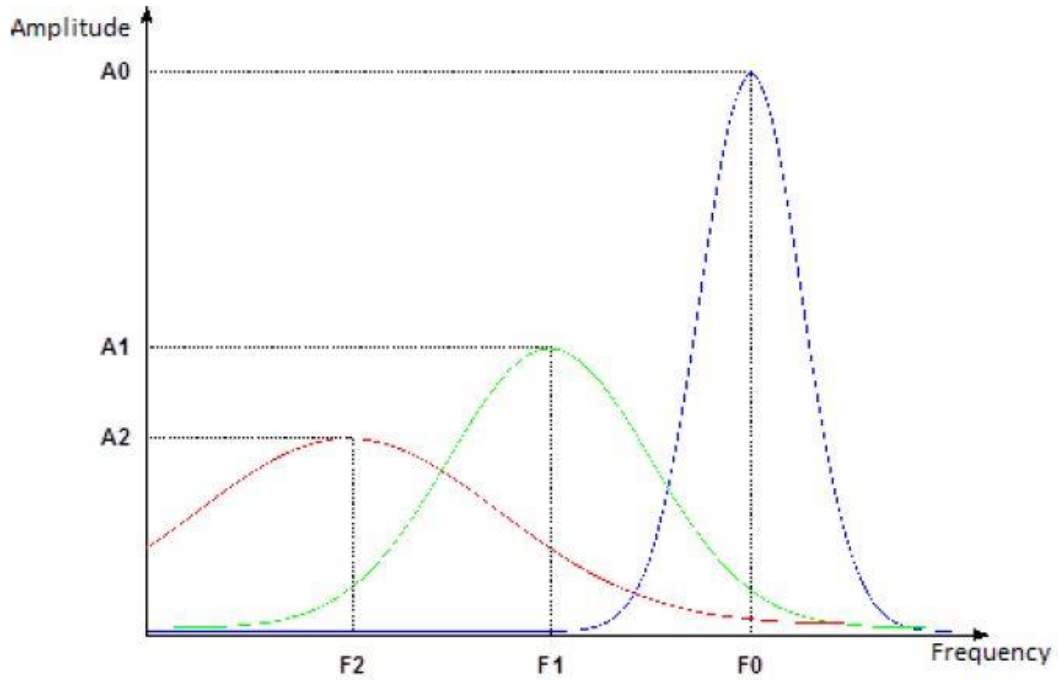

4.2 Control unit

Wiring diagram

The control unit is designed to work with two grain moisture sensors. One of the sensors is called “moisture sensor A” and the second one is called “moisture sensor B.” The wiring diagram is shown below.

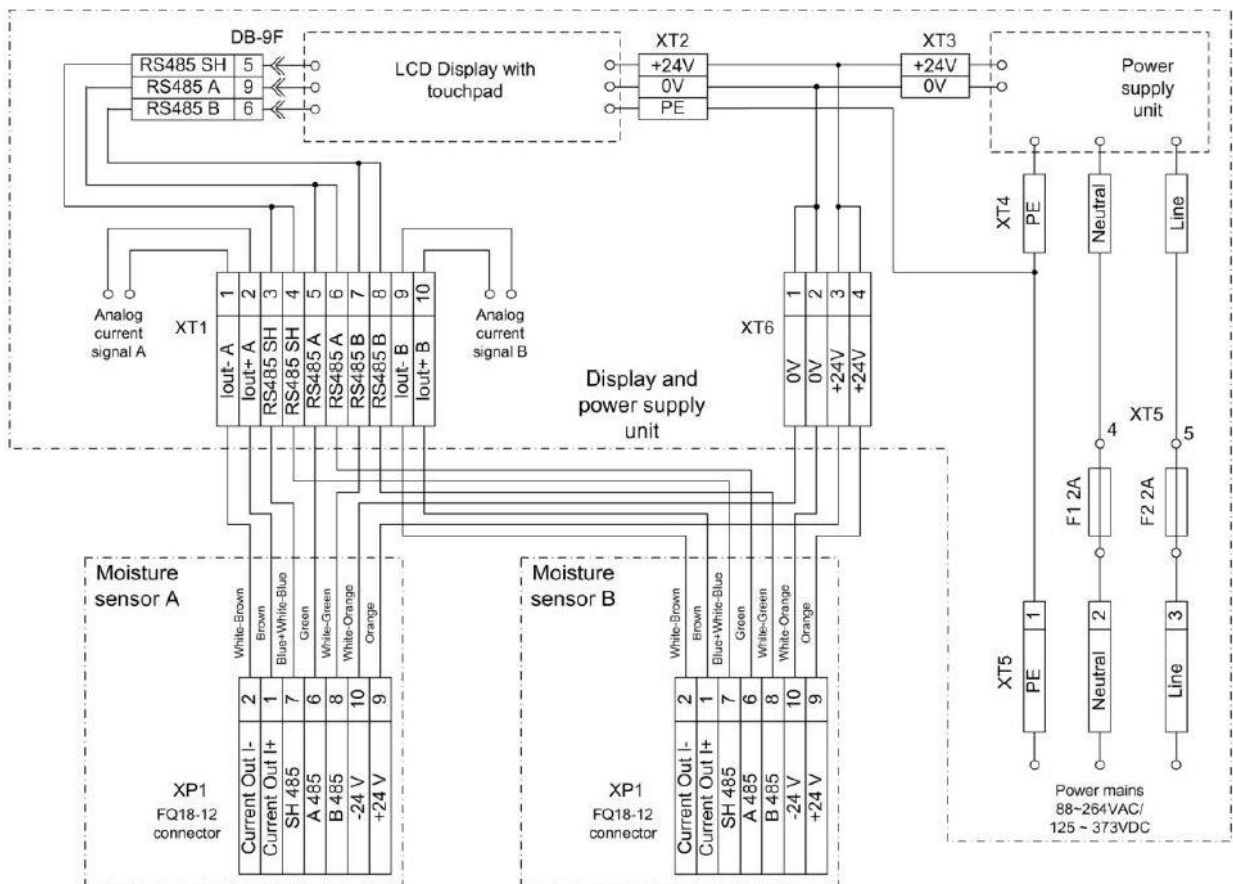

The display and control unit is supplied with two 3 m sensor connection cables. This is to enable immediate connection of the sensors for a quick measurement. Please check the sensors for proper function before use and make sure that you install the equipment as described in the manual.

If you wish to install the moisture sensor in a grain drying system, a switchbox with 7 contacts must be mounted at a distance of 3 m from each sensor and a sensor cable should be connected to it. Communication lines (4 twisted pairs) of the required length (up to 100 m) from each contact are wired to the operator station where the display unit is installed. The line connection must be performed according to the wiring diagram

In order to check the operability of the grain moisture control system, place both sensors on the table, plug the connectors into sensors A and B and power on the display and control unit. After the operation programme has been loaded, the following figure will appear in the display. The two glowing green LEDs (●) indicate that the sensors are ready for measurement. You will see the following indication:

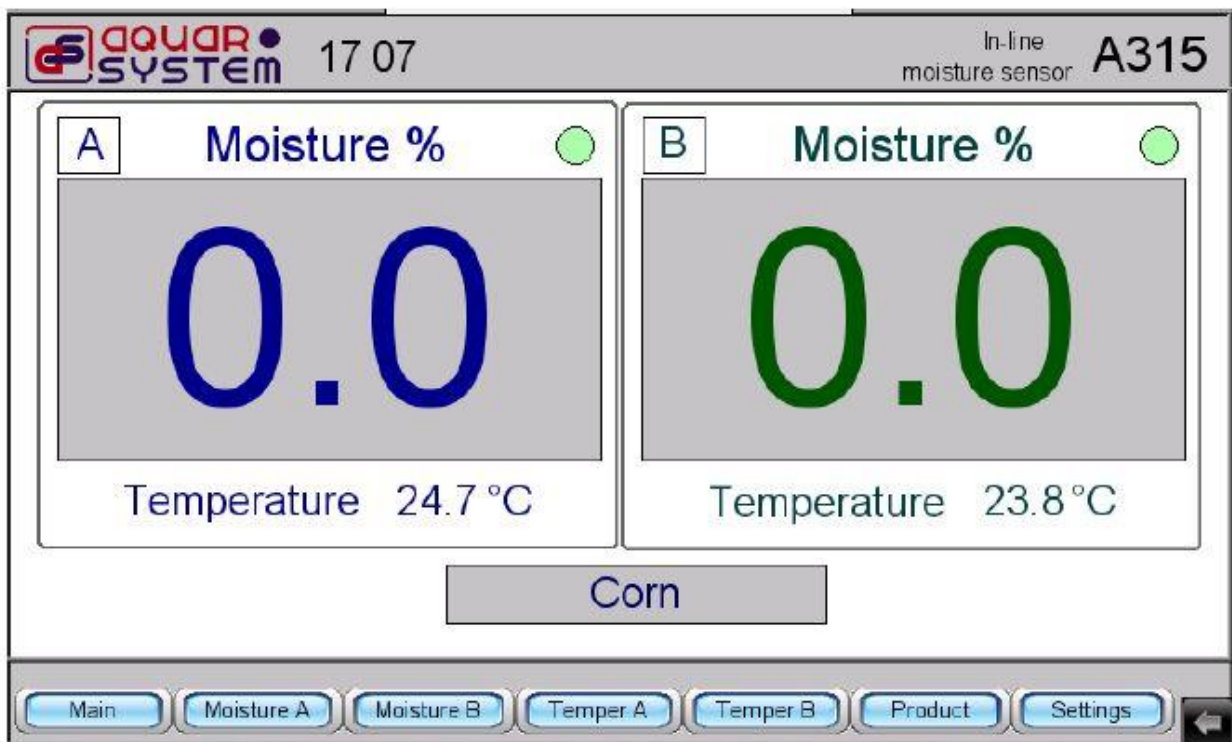

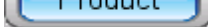

5 Instructions

5.1 Product selection and moisture measurement

Working with moisture sensors starts with the product selection. Press the  button and the names of 15 products will be displayed, as shown in the following figure.

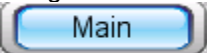

Select the product you want to measure and confirm your selection by pressing . The moisture sensors are now ready to work with the selected product. Select  mode and fill the measurement channels of the sensors with grain. The moisture values will then be displayed and the green LEDs will stop glowing (), as shown in the following image.

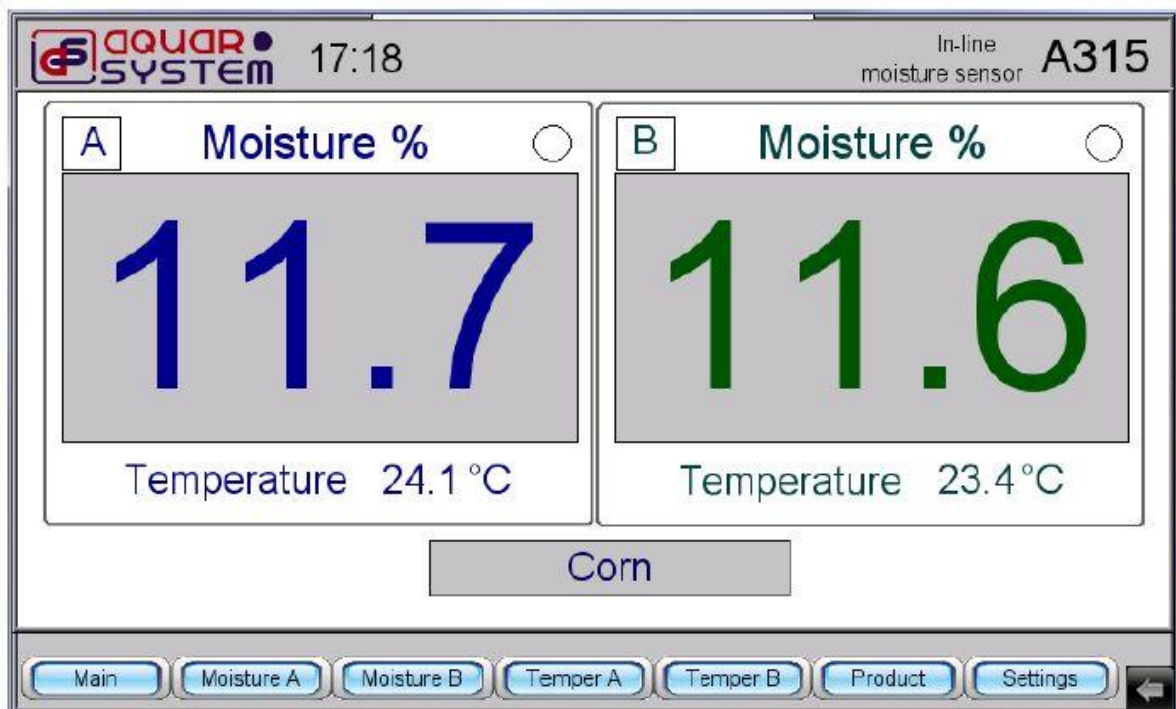

In order to simulate the in-line process of grain moisture measurement in the moisture control system, a

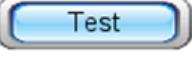
special test mode ( key) is provided that helps to obtain an average moisture value based on the results of several moisture sensor fillings. This value acts as a reference value for future fillings of the same type of grain. After you made your product selection as described above, press

 and the following image will be displayed.

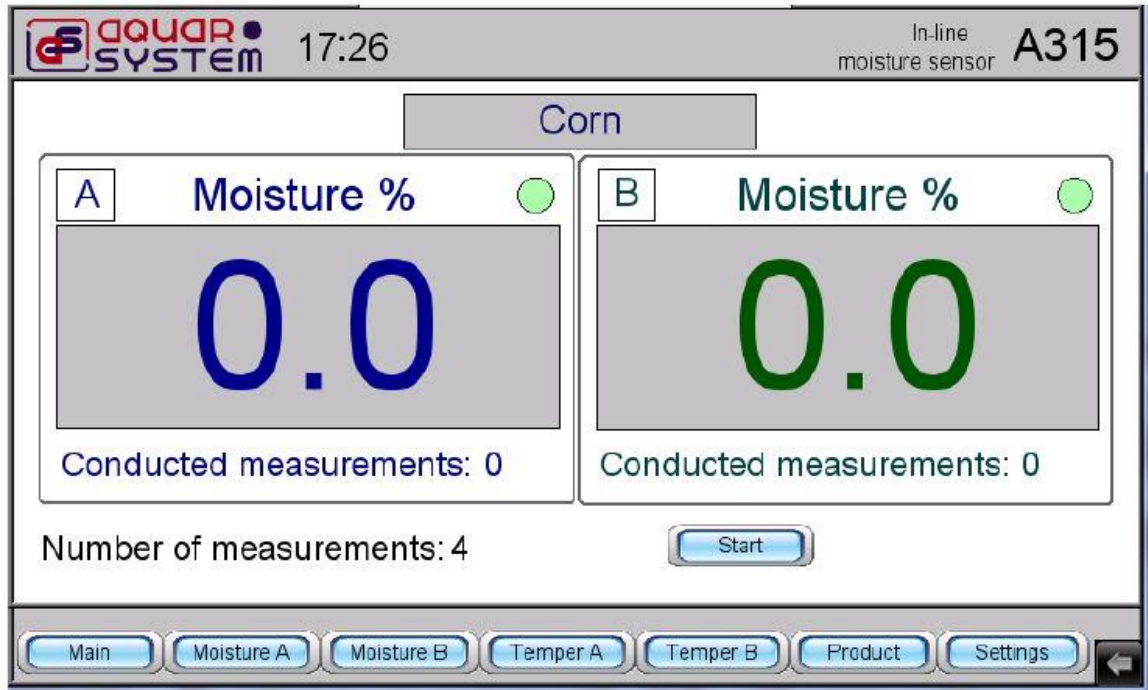

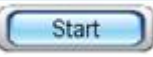
The “Number of measurements” in the example above is 4. Press the  button and fill the measuring channel of moisture sensor A with a portion of grain. Wait for the acoustic signal and appearance of “1” in the menu item “Conducted measurements”. Remove the grain from the moisture sensor and fill the moisture sensor with grain again. After an acoustic signal, “2” will appear in the “Conducted measurements” line. After the procedure was repeated 4 times, the moisture content which is the average of the four measurements will be displayed in the “Moisture %” window. After this, the same procedure can be performed for sensor B.

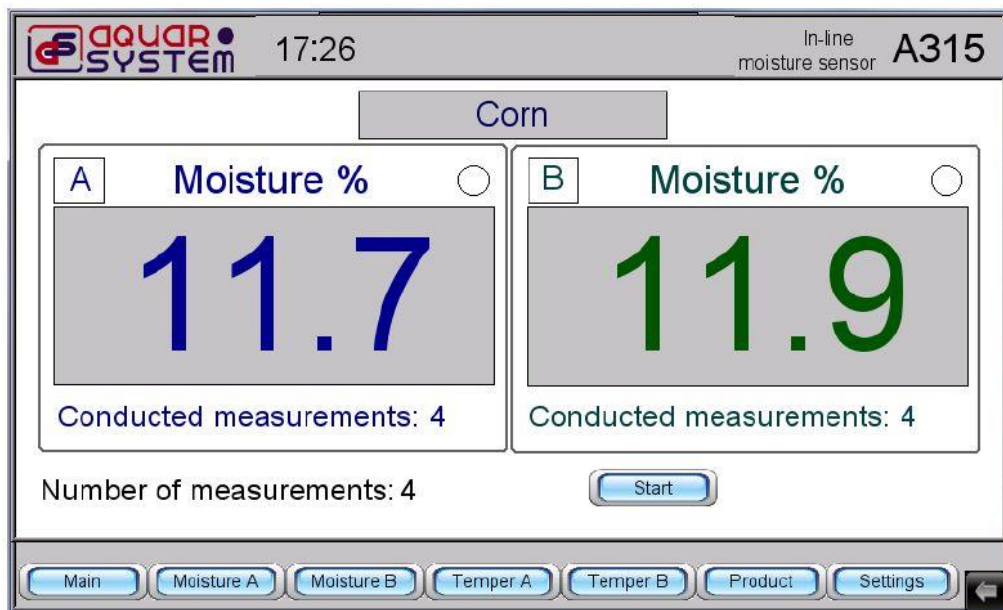

Test mode can be used for the imitation of the in-line operation. It is very important to know the grain moisture of the raw materials (more than 18 % for grain products and legumes and more than 13 % for oil seeds) and to find out if there is an excessive deviation of the moisture and the filling density. The number of measurements for products like corn in **Test** mode should be increased to 10 in order to obtain a more reliable result. In order to change the number of measurements, select the field behind "Number of measurements". A keypad will be displayed for you to enter a new number of measurements. Enter the number and confirm your entry by pressing the **ENT** button on the keypad.

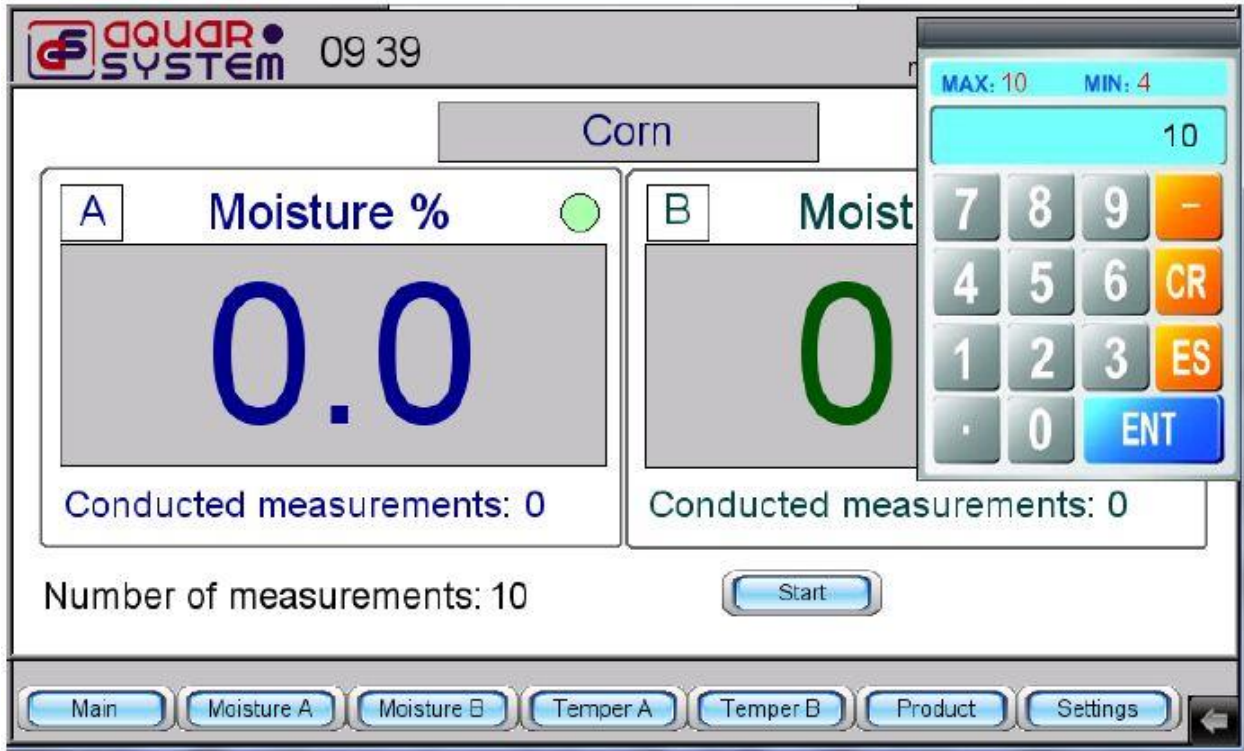

After having pressed the **Start** button and having made 10 fillings of grain, you will obtain a correct moisture value as an average.

5.2 Trend view

The moisture sensors can display trends with regards to grain moisture and temperature. In order to view moisture trends for sensors A and B, press the **Moisture A** or **Moisture B** key. In order to view the temperature trends, press the **Temper A** or **Temper B** key. As a result, the trend for the last 10 minutes of moisture sensor operation will be displayed. See the following figure:

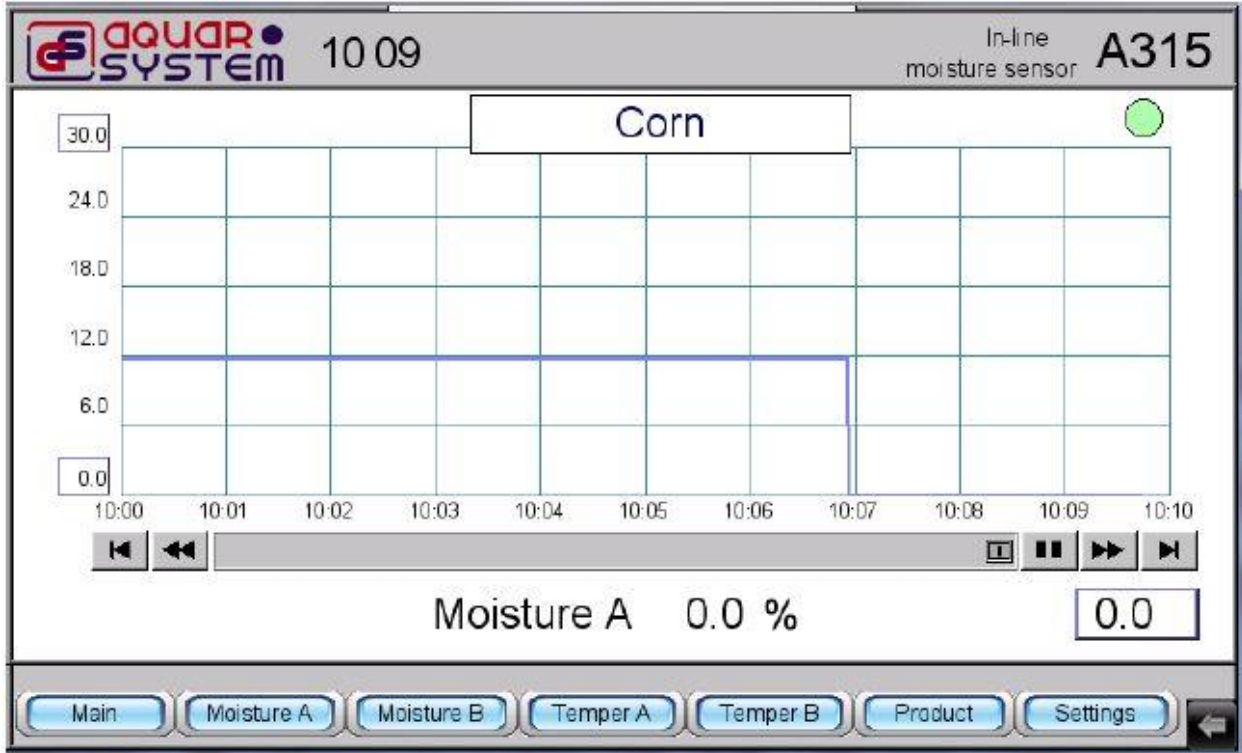

You can view trends for other periods of time using the arrow buttons below the chart. The moisture value for the desired period of time can be obtained by selecting the desired period in the trend indication. The measuring value will then appear in the bottom right corner of the display.

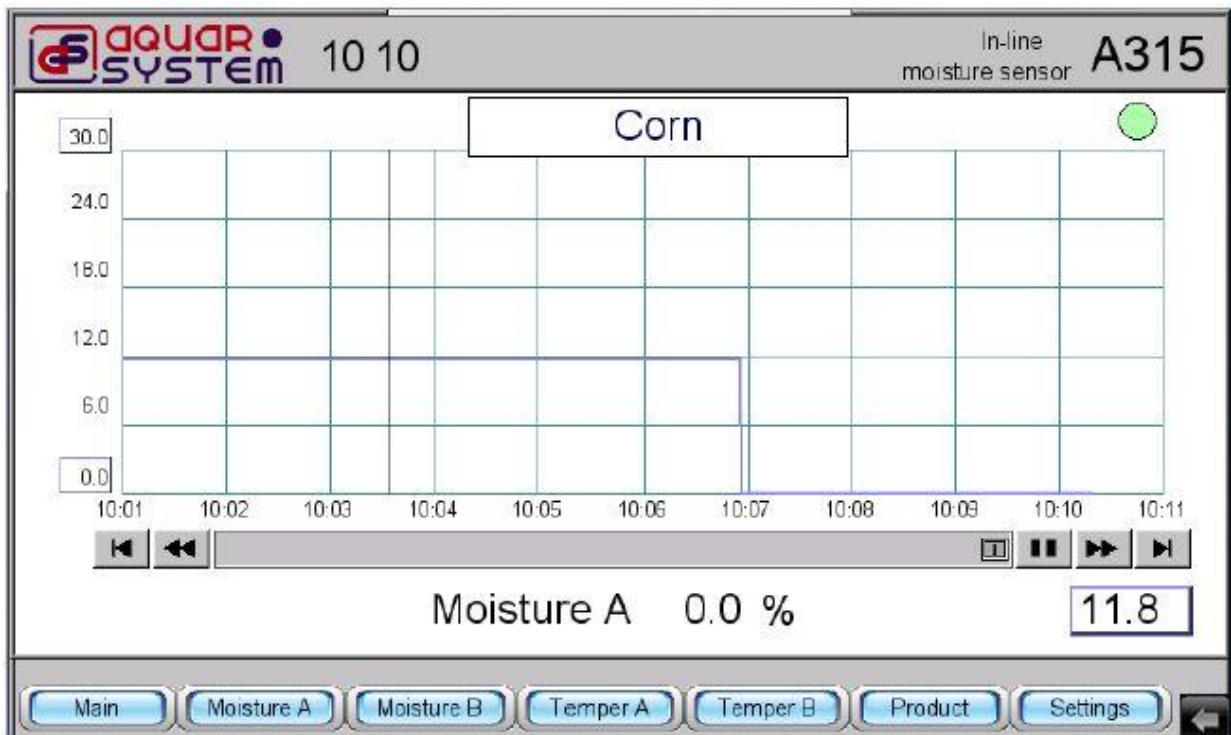

The trend scale regarding the moisture can be changed by means of the keypad. In order to change the maximum value, select the value in the top left corner of the chart. The numeric keypad will appear so that you can type in the new maximum value at increments of 5 %. Press **ENT** on the numeric keypad to confirm. The same procedure can be followed to set the minimum value. The only difference is that you have to select the value in the bottom left corner of the chart.

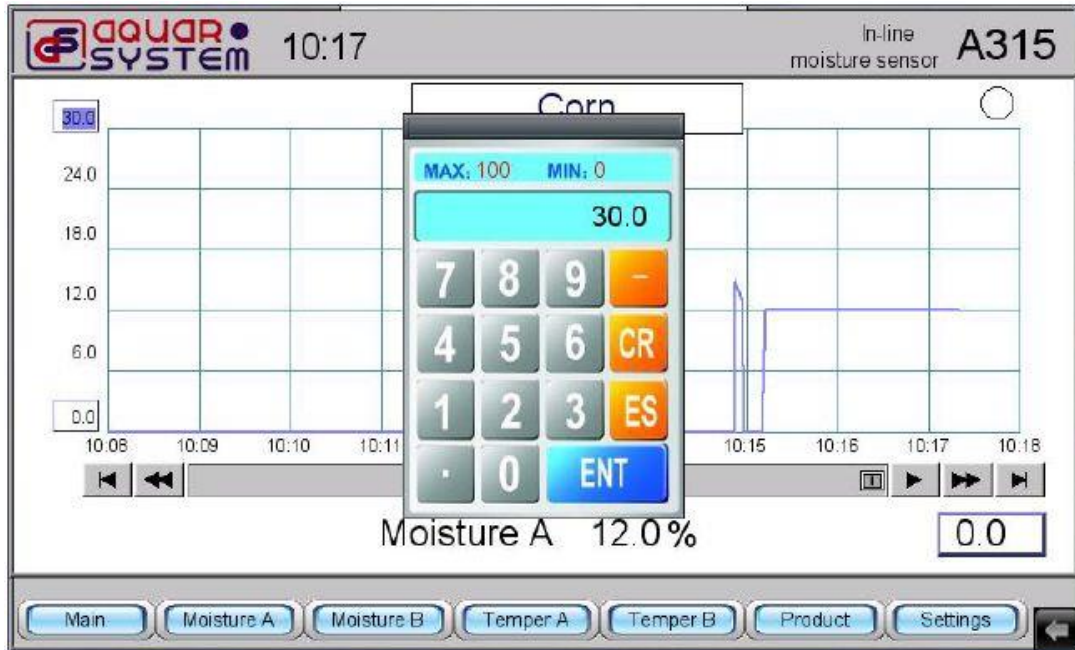

5.3 Corrections / settings

The **Settings** button provides the possibility of entering corrections for each moisture sensor as well as corrections of the average sensor limits. After pressing **Settings**, the following image will be displayed:



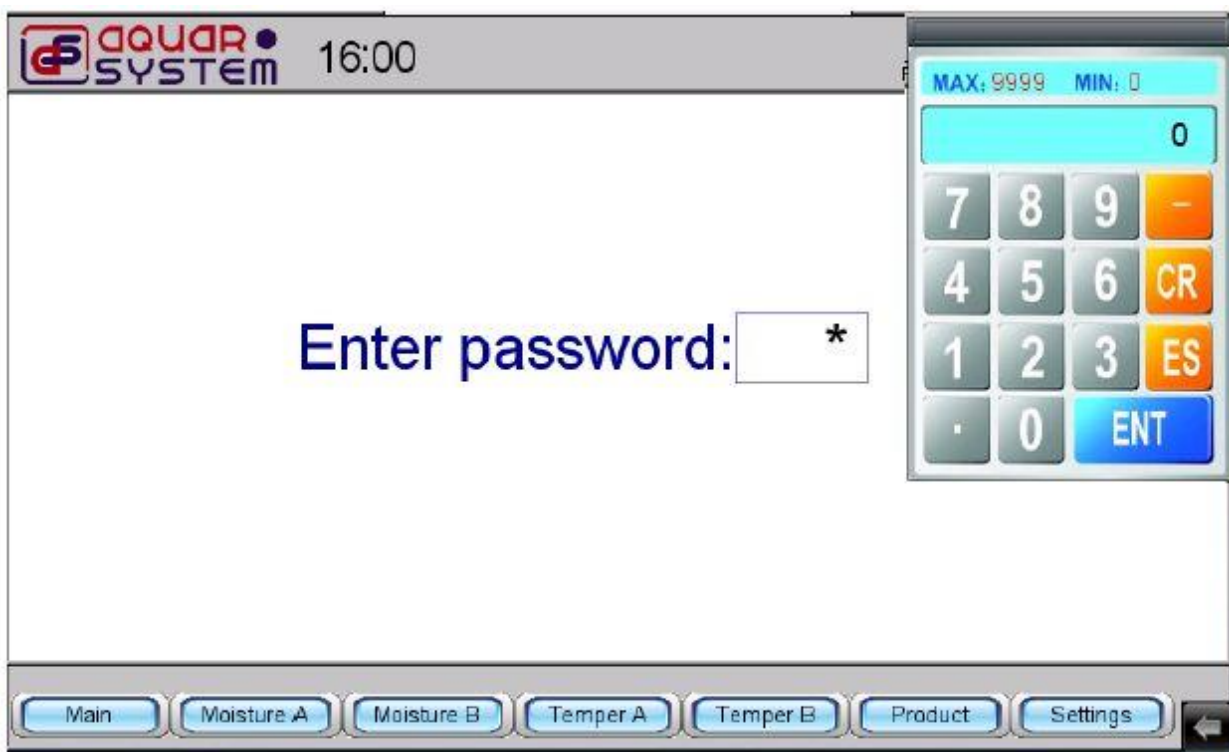

Select the "*" on the display to see the numeric keypad which you can use to enter the PIN (password).





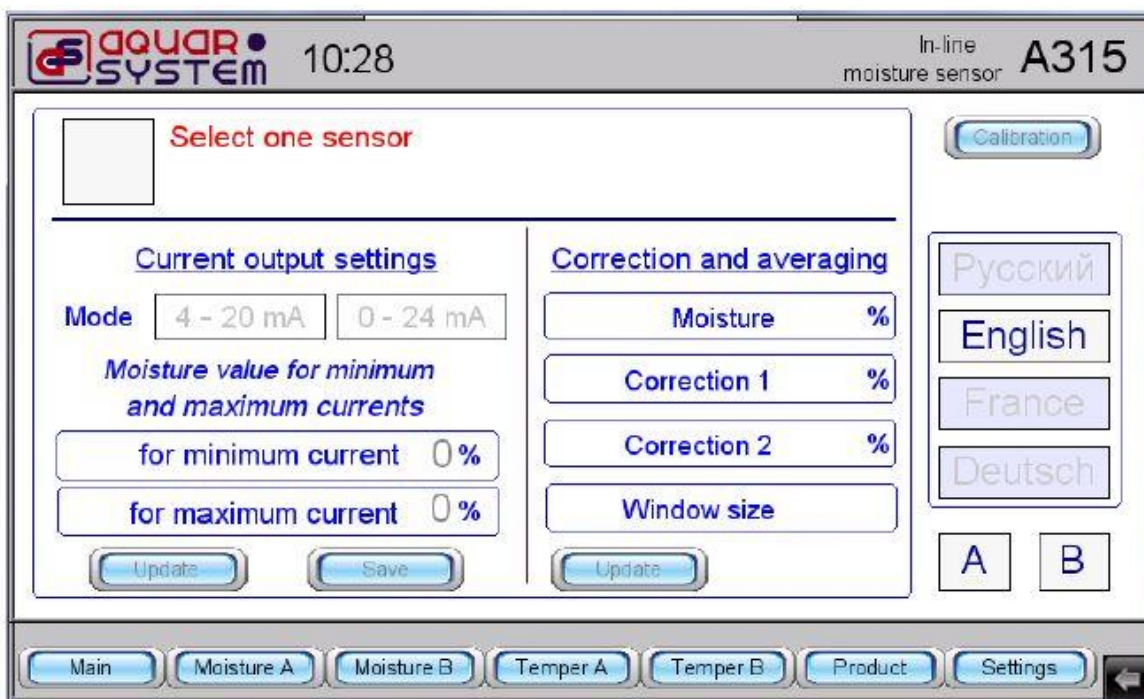

Enter "315" using the keypad and press the **ENT** button. The following indication will be displayed. A correction can only be carried out for one of the moisture sensors.

If the system operates two sensors simultaneously or both of them are switched off, the message "Select one sensor" will appear. In order to select the required sensor, press **A** or **B** in the bottom right corner of the display. The selected sensor is indicated by the corresponding letter in the top left corner of the display. Press **Update** to read the parameters set for the sensor.

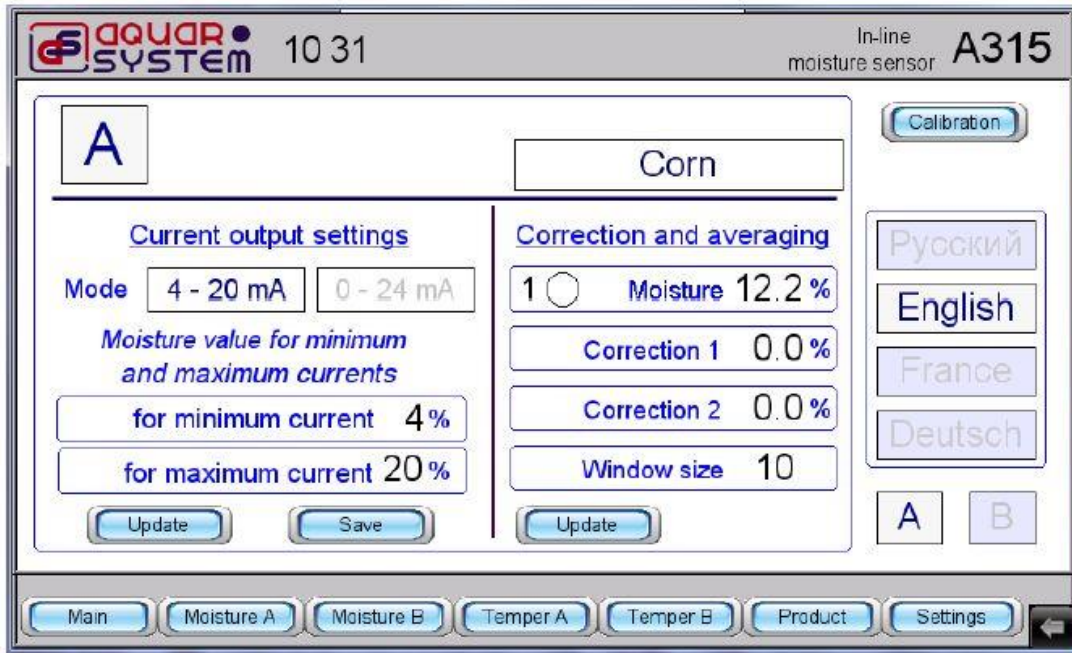

In order to select a type of current output, press on the corresponding window (4-20 mA or 0-24 mA can be selected) and confirm your selection by pressing . Check the correctness of your selection by pressing . The standard signal output can be adjusted by setting the moisture limits for the minimum and maximum current. Thus, as you can see in the figure below, the minimum moisture when an output current of 4-20 mA has been selected is 4 % (= 4 mA) whereas the maximum moisture is 20 % (= 20 mA). This means that if a moisture of 12.2 % is indicated, the current output will be 12.2 mA.



The moisture limit values are set as follows: to set the moisture limit for the maximum output current, press the moisture figure corresponding to the maximum output current which is 20 % in the following example and is already highlighted. The numeric keypad will appear. Press  on the keypad after entering a new value and then press  and  in the current output settings. The minimum output current can be set the same way.

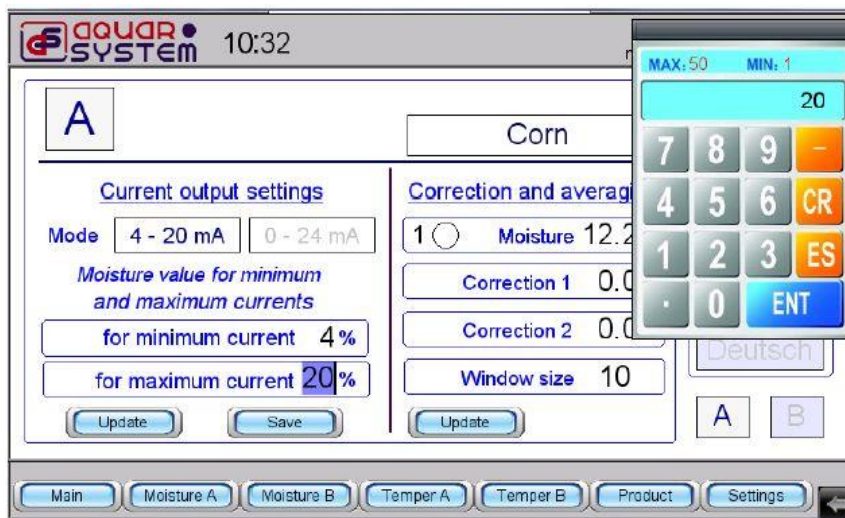

The microwave moisture sensor calculates the moisture using two algorithms. The algorithm for calculation depends on the grain moisture and temperature and uses the digits 1 and 2. In the next screen, you can see digit 1 in the menu item “Correction and averaging”, with a value of 12.2 % and a correction of 0.0 %.

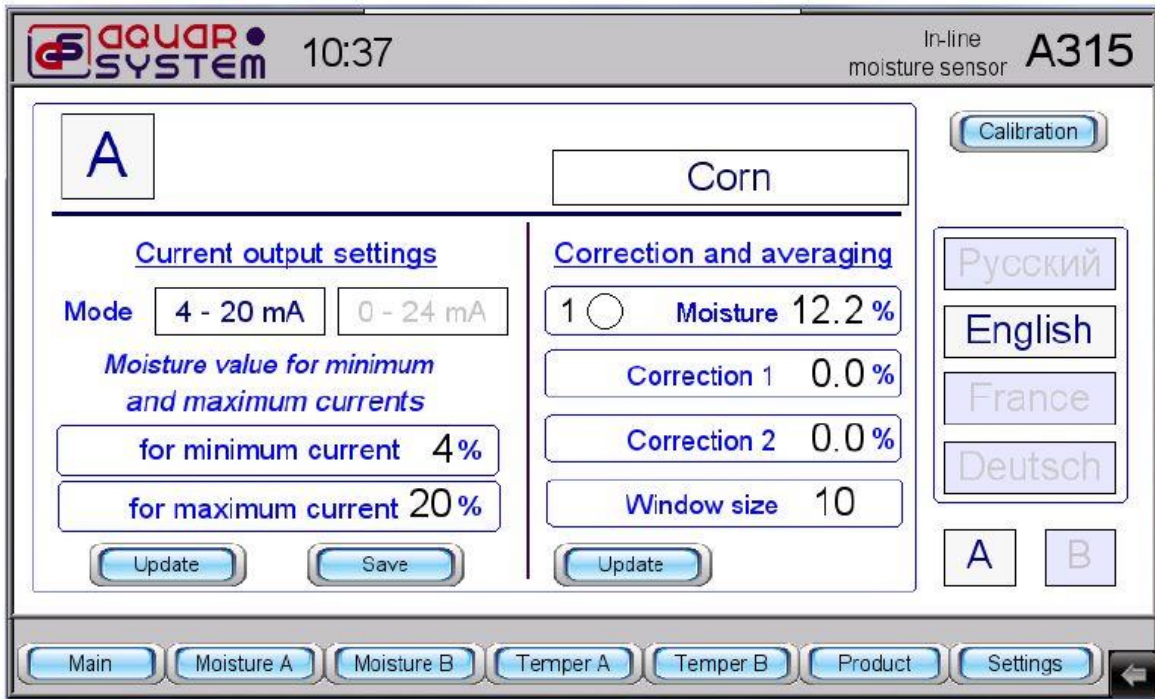

If, for example, an organization that receives grain determined that the grain moisture is 12.2 % and the moisture is 12.8 % according to the control measurement, a correction of 0.6 % must be entered. In order to enter such a correction, “Correction 1” must be selected. The numeric keypad will appear so that you can enter the correction value. Having entered the correction value of 0.6 % and having confirmed the entered value by pressing **ENT**, the new reading will be indicated correctly.

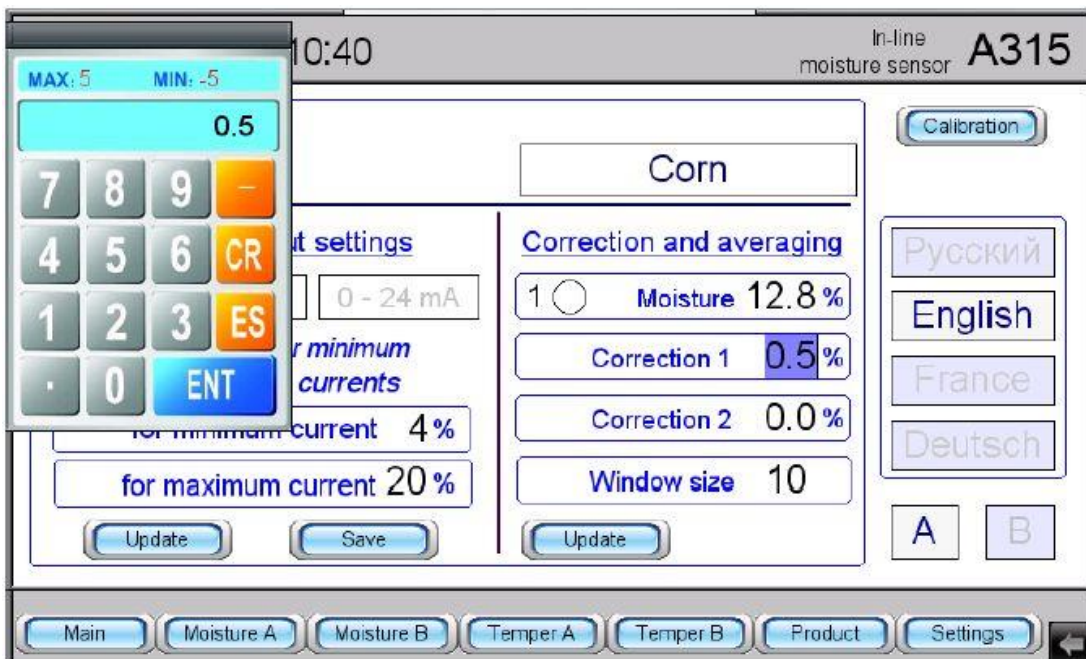



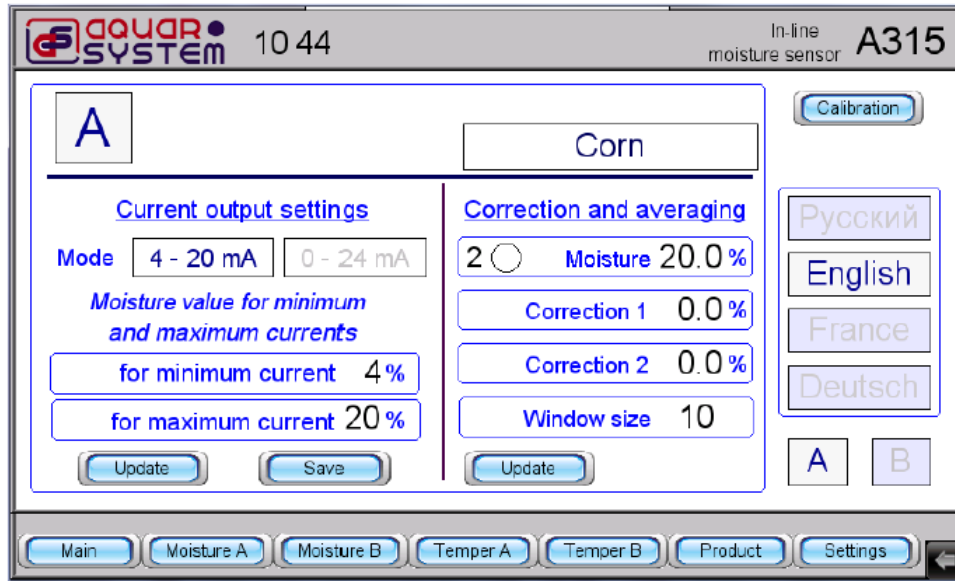

The moisture correction for algorithm 2 is carried out the same way as above, with the only difference that “Correction 2” is selected in this case.

**Warning!**

Moisture corrections may only be performed when the sensor's measurement channel is filled with grain as otherwise the system cannot recognise which correction value is to be edited ("Correction 1" or "Correction 2").

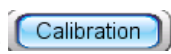
The sliding window algorithm is used for averaging the moisture measurement results. Its value is entered in the "Window size" line and it can vary from 1 to 255. The bigger the window size, the higher the number of values used for averaging. The window size value is chosen by means of experiments, i. e. by placing the moisture sensors in the product drying installations and taking into account the drying dynamics. The window size is set in the same way as the other parameters are set, as described above. The panel communication and setting of parameters for the grain moisture control system can be carried in 4 languages: English, Russian, French and German. To select your language, press the corresponding button on the right.

Attention! The calibration must only be carried out by a qualified staff member of PCE Instruments.

In the upper right corner of the  window, you can find the  button. It is used if a moisture sensor reads values >0 in  mode and no green indicator is glowing () indicating the readiness for measurement but there is no grain in the measurement channel of the sensor. If this is the case, check for the presence of grain in the measurement channel and press the  button for the selected sensor A or B. After pressing it, the following message will appear:

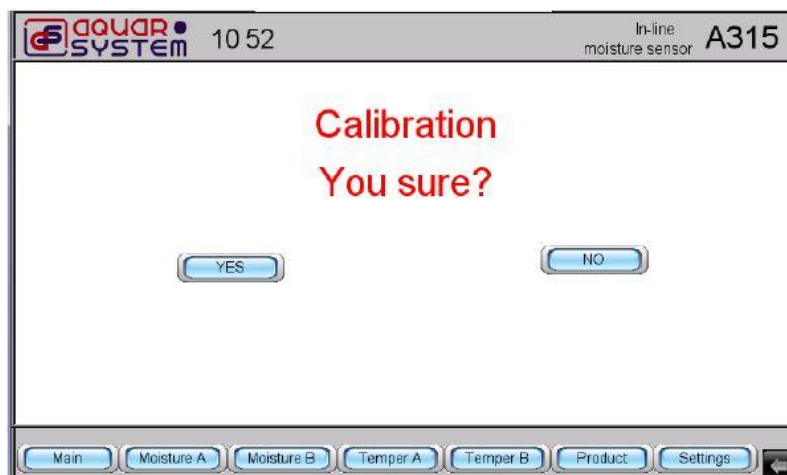

After pressing , you will see the following image with zero moisture and a glowing green light indicating the readiness for measurement (●). The measurement will be continued after switching to mode.

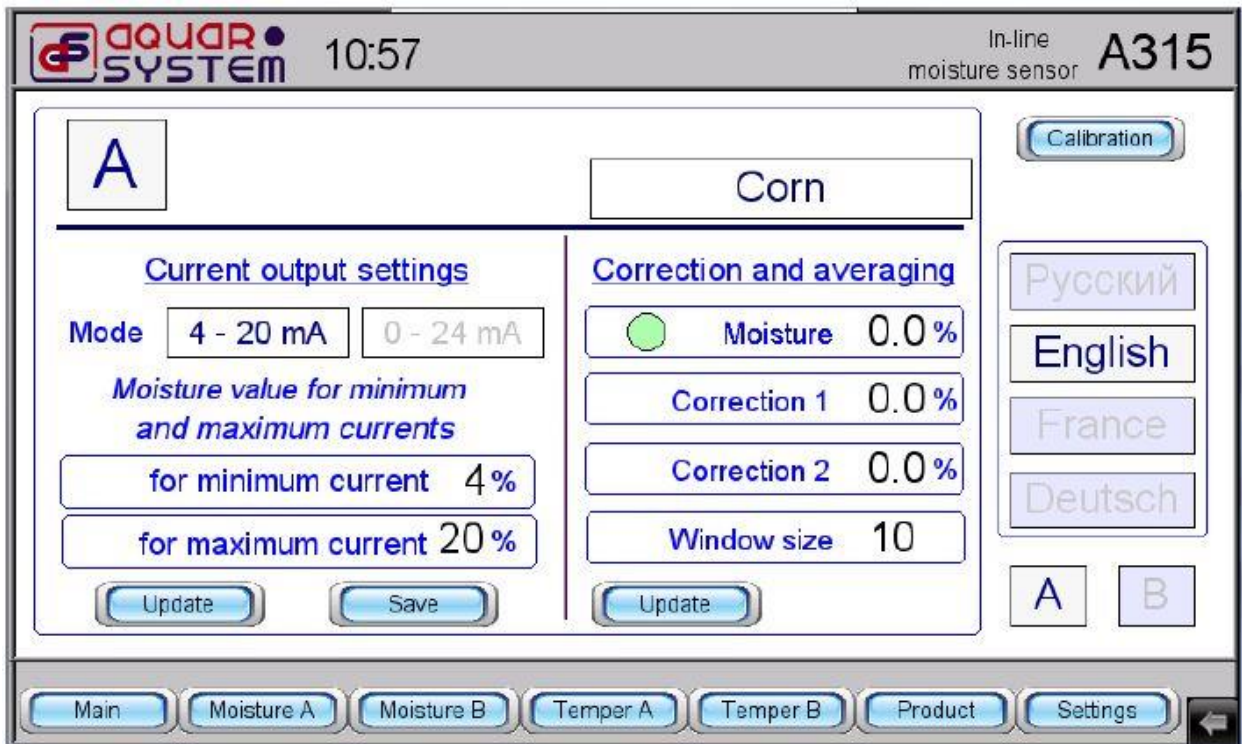

The sensor (A or B) used by the moisture control system cannot only be chosen in mode but also in mode.

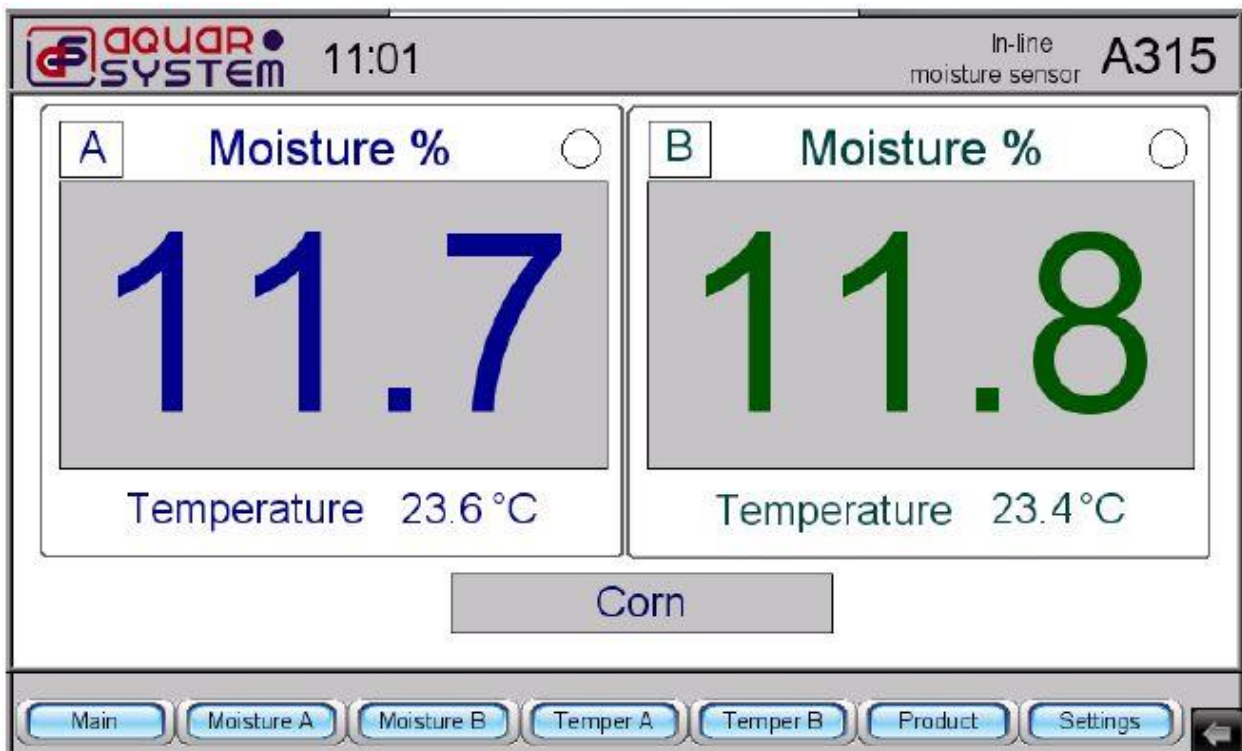



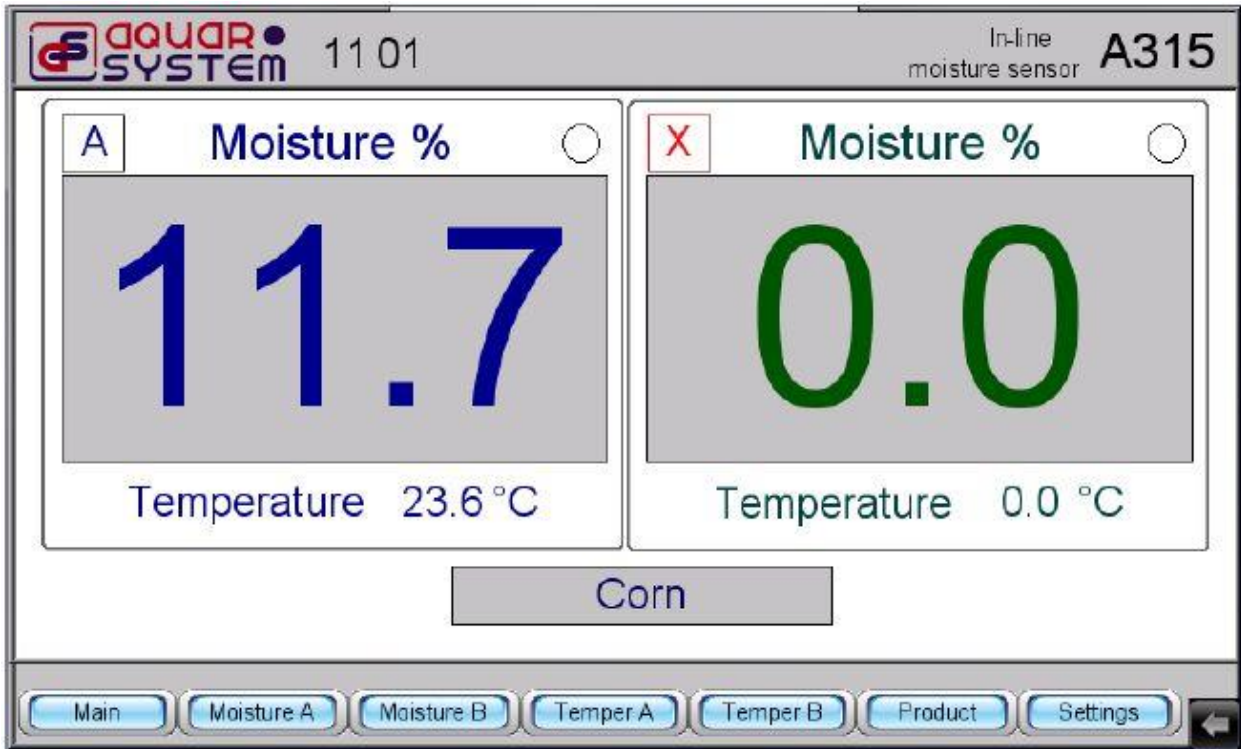

If, for example, in  mode you press the letter corresponding to sensor B, that sensor will be switched off and the values indicated for moisture and temperature will be zero.



Press the  button to switch on sensor B.

5.4 Time and date

To set the time and date, press the  button in the bottom right corner of the display. After pressing it and after the menu appears, press the  button. A window requiring the PIN (password) and a keyboard will appear. The PIN 111111 must be entered via the keyboard. Confirm with OK. Then press the Time/Date button to enter time and date settings mode and set the time and date by pressing the  and  buttons. Your time and date settings must be confirmed by pressing OK. After doing so, re-start the display module.

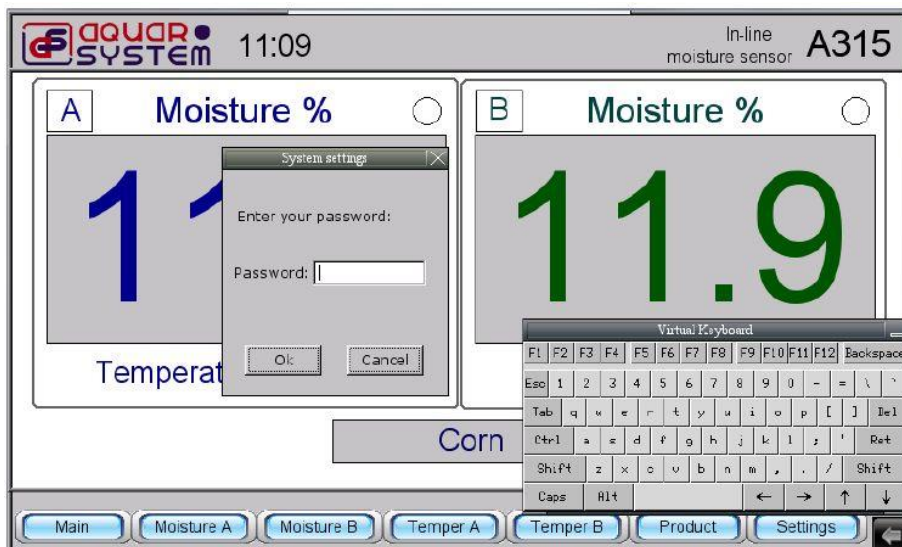

5.5 Installation of the moisture sensors

In order to operate a moisture sensor correctly, it is required to fill its measurement channel with grain. Depending on the design of the grain drying unit, this can be carried out in different ways. Some of them are described in the following.

To control the input moisture, one moisture sensor must be installed at the head of the shaft's side wall where the shaft is filled. Another moisture sensor must be placed between the sensors of high and low level of the drying shaft, closer to a low level sensor.

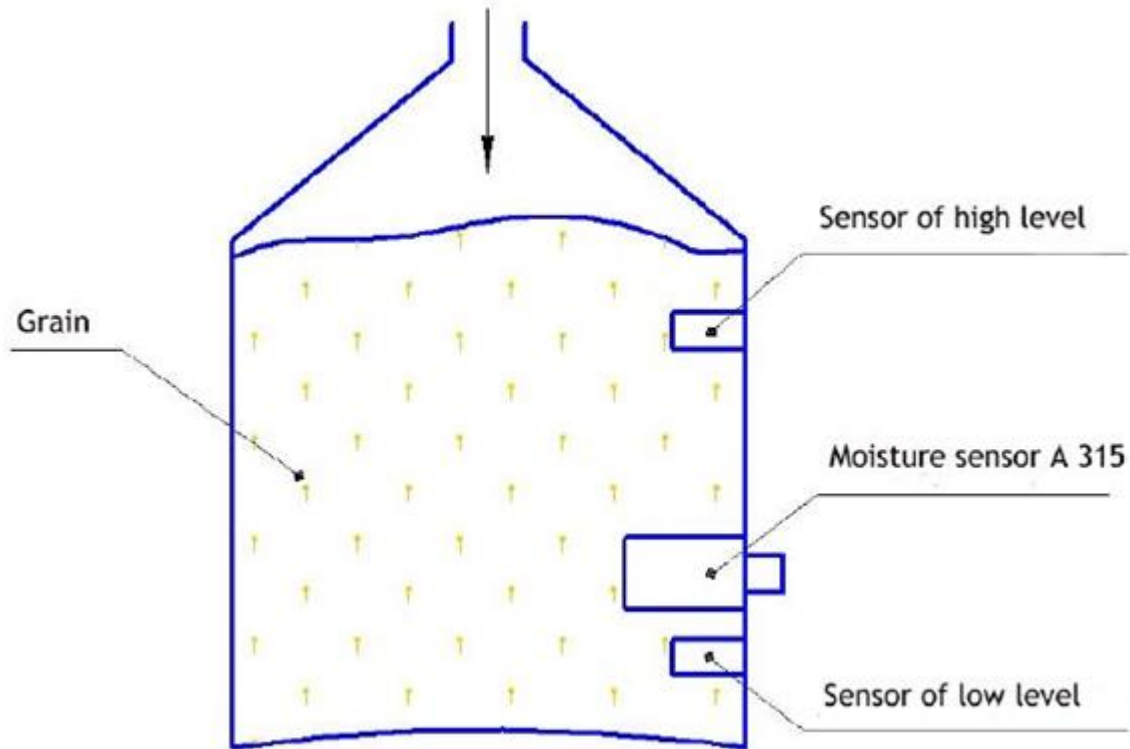

After filling the shaft with grain, the measurement channel of the moisture sensor is filled too and the current moisture measurement is carried out. When the grain level is below the moisture sensor and its measurement channel has been emptied as well, the moisture sensor will read zero and an automatic calibration will be performed (green LED  will glow). After a new portion of grain has been filled into the sensor, the moisture measurement process will be repeated.

To control the output moisture in a funnel, a moisture sensor must be placed in the discharge bunker above the output conveyor.

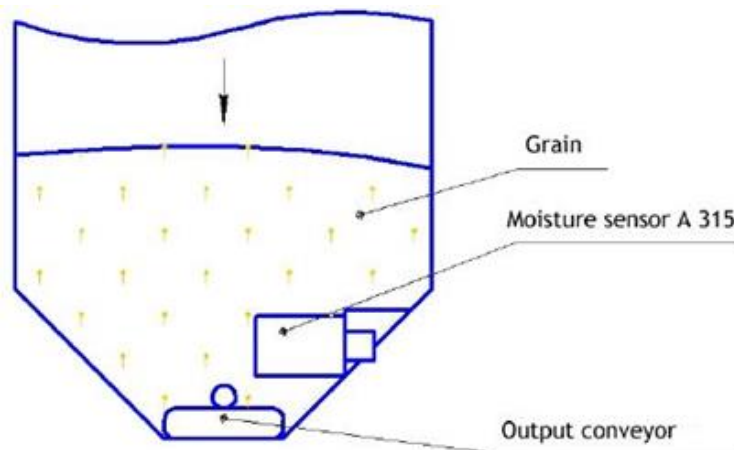

After the discharge of a certain portion of dried grain, the moisture sensor should be fully covered with grain. The grain slowly passes the measurement channel of the moisture sensor, being carried by an output conveyor. The moisture measurement is taken before the grain is discharged from the measurement channel of the moisture sensor which will then go through an automatic calibration process

(green light  glows on the panel). The device is now ready for the moisture measurement of a new portion of grain. However, not all grain drying systems have the possibility to fill the measurement channel of a moisture sensor this way. In case only a small portion of grain can be discharged to the output bunker, the best results will be achieved when using small flexible spiral auger conveyor mounted below the moisture sensor.

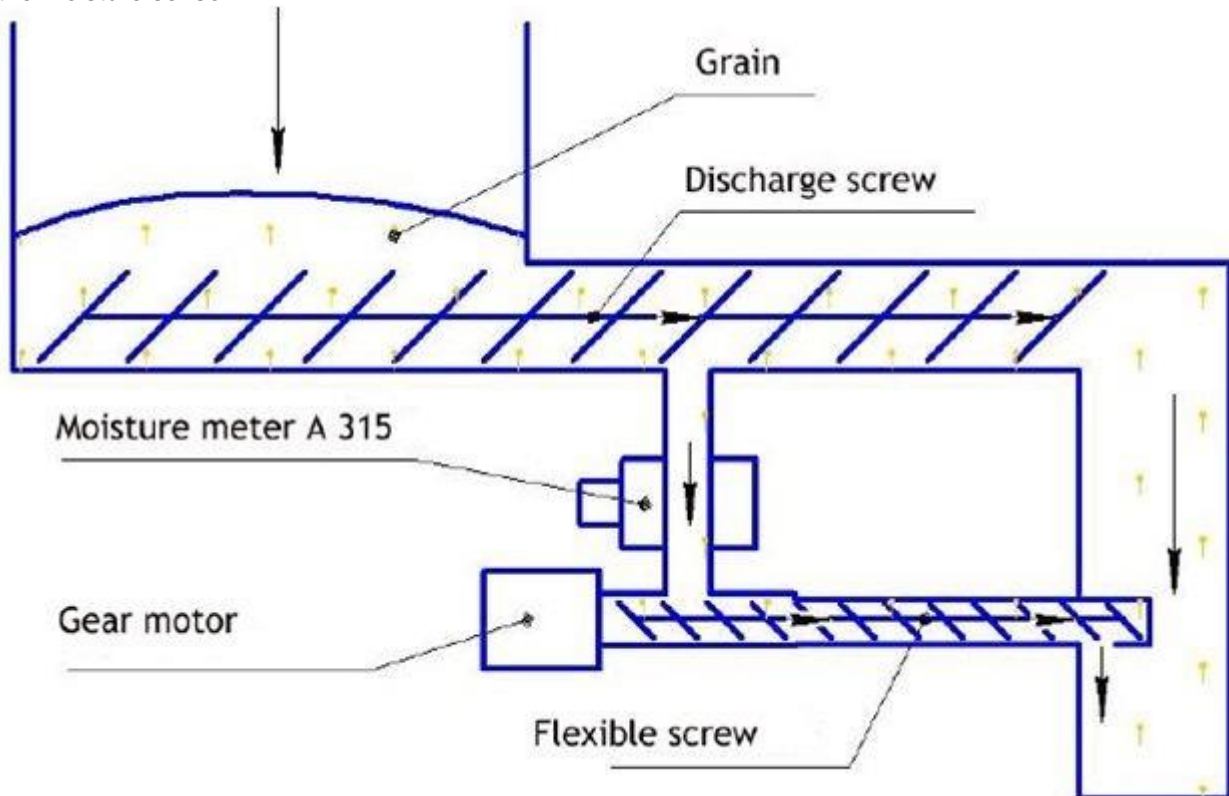

A portion of grain from the upper conveyor passes through a pipe with a diameter of 60 mm to the measurement channel of the moisture sensor. Below the moisture sensor a spiral auger conveyor of the same diameter is mounted. The spiral auger conveyor has an electric drive with a gearbox rotating at a speed of 1 round/s that slowly conveys grain through the moisture sensor and returns it to the main line. When using this type of grain drying system, the grain supply should be stopped for 20-30 s every 30 minutes in order to enable automatic calibration of the moisture sensor. After the cessation of the grain

supply, the moisture sensor should read zero moisture and the green LED  should glow on the panel, indicating its readiness for the moisture measurement of a new portion of grain.

5.6 Troubleshooting

1. While the system is switched on, the control unit has a “Communication error” message on it.

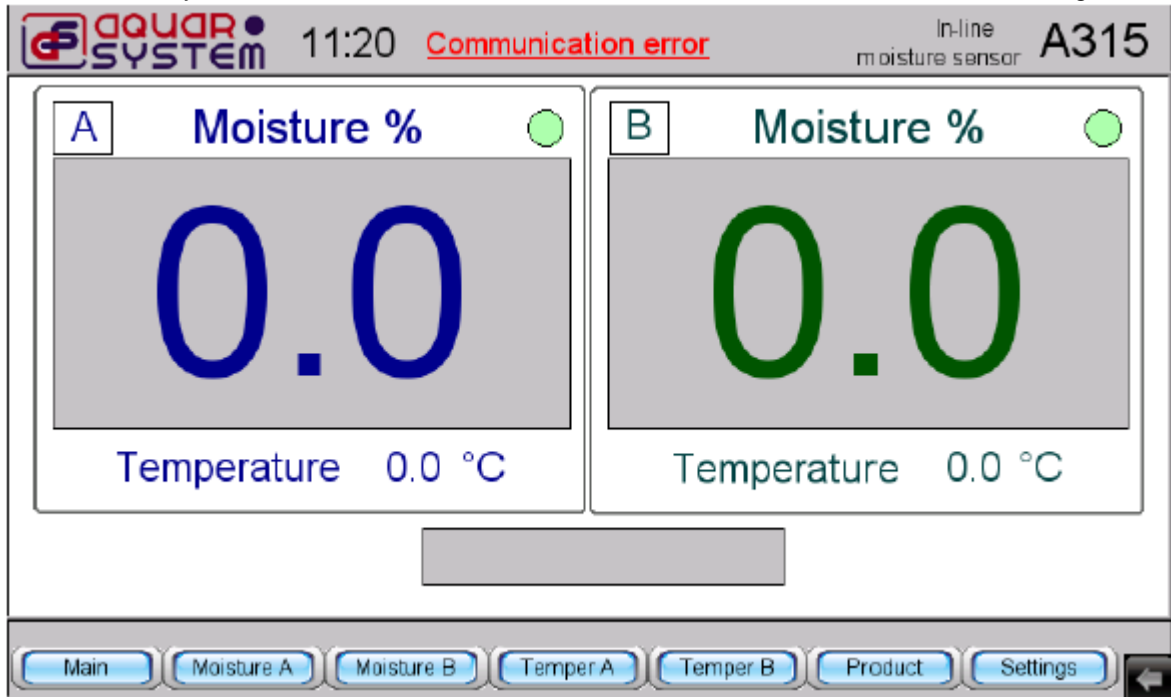

In this case, the intactness of the cables from the moisture sensors to the display panel and of the contacts must be checked. Failures of a certain cables can be detected by switching off one moisture sensor, using the control panel. If you switch off sensor B, for example, and sensor A starts to function (indicates moisture and temperature) and the “Communication error” message disappears, the communication cable going from sensor B to the display panel is faulty.

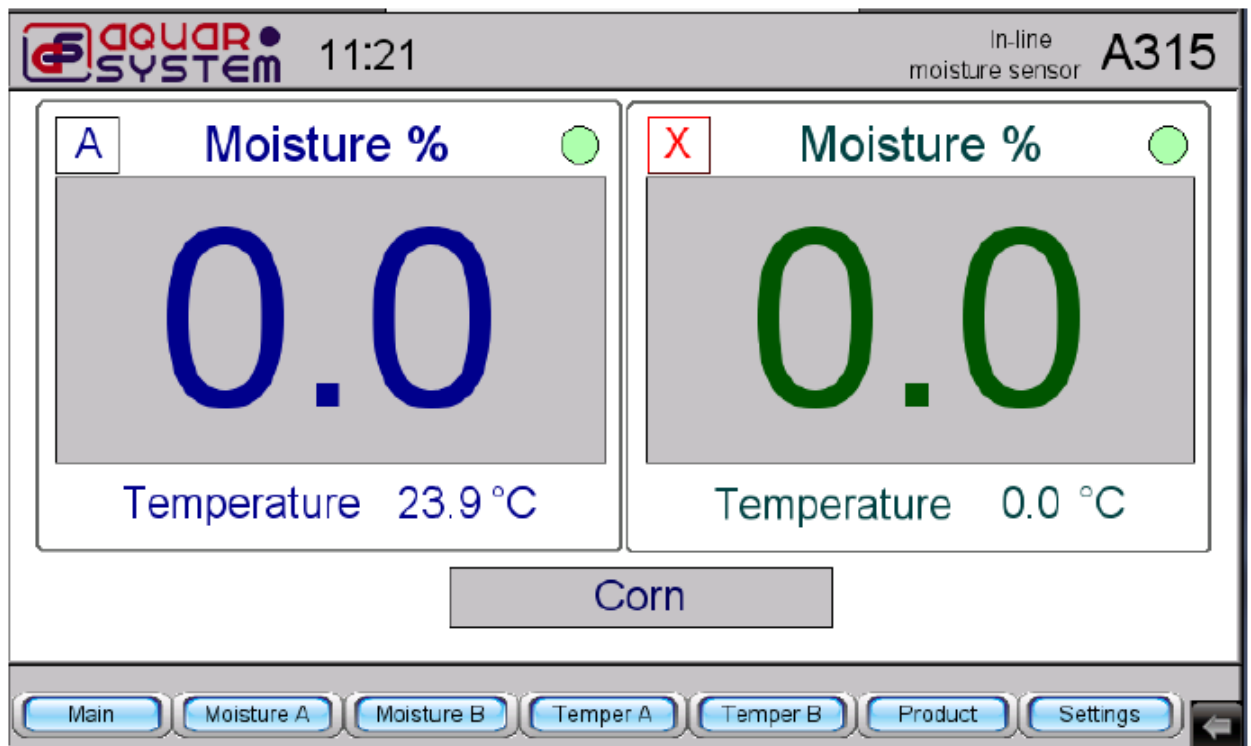

- The panel indicates "Error 7"

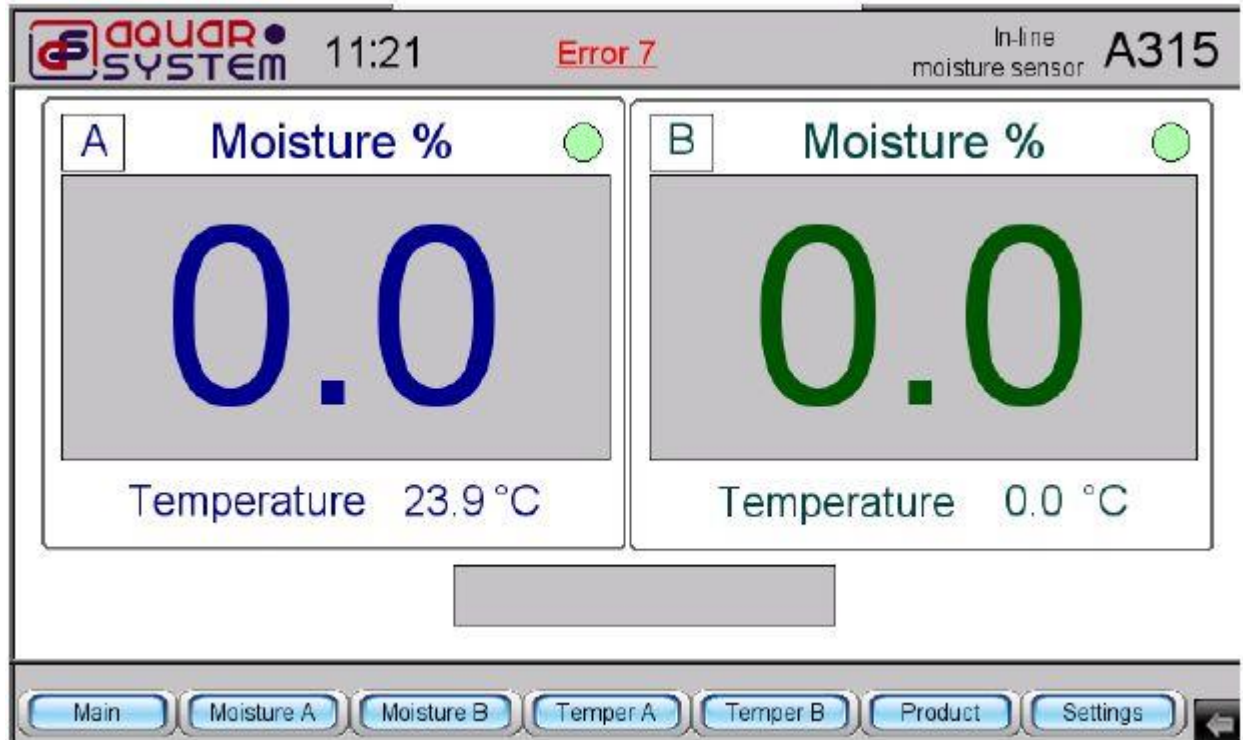

Repeat the product entry.

- If there is no grain in the moisture sensors and one of them or both of them have values exceeding zero and no green light is glowing (), the moisture sensor must be calibrated.
- In case of other failures please contact PCE Instruments.
- After the end of the drying session, it is recommended to dismount the moisture sensors from the grain drying system and store them in a dry heated place. Protect the moisture sensor connectors from direct effect of water.

6 Disposal

For the disposal of batteries, the 2006/66/EC directive of the European Parliament applies. Due to the contained pollutants, batteries must not be disposed of as household waste. They must be given to collection points designed for that purpose.

In order to comply with the EU directive 2012/19/EU we take our devices back. We either re-use them or give them to a recycling company which disposes of the devices in line with law.

If you have any questions, please contact PCE Instruments.



7 Contact

If you have any questions about our range of products or measuring instruments please contact PCE Instruments.

7.1 PCE Instruments UK

By post:

PCE Instruments UK Ltd.
Units 12/13 Southpoint Business Park
Ensign Way, Southampton
Hampshire

United Kingdom, SO31 4RF

By phone:

02380 987 035

7.2 PCE Americas

By post:

PCE Americas Inc.
711 Commerce Way
Suite 8
Jupiter
33458 FL
USA

By phone:

561 320 9162