



User Manual

PCE-CMM 8 CO₂ Analyser



User manuals in various languages (français, italiano, español, português, nederlands, türk, polski, русский, 中文) can be found by using our product search on: www.pce-instruments.com

Last change: 2 November 2020
v1.0



Contents

1	Safety notes	1
2	Device description	2
2.1	Technical specifications	2
2.2	Display / touch screen	3
2.3	Dimensions	3
3	Operating instructions	4
3.1	On/off	4
3.2	Settings	4
3.3	Measurement graph / data history	6
3.4	Alarms	6
3.5	CO ₂ traffic light function	7
4	Warranty	7
5	Disposal	7

1 Safety notes

Please read this manual carefully and completely before you use the device for the first time. The device may only be used by qualified personnel and repaired by PCE Instruments personnel. Damage or injuries caused by non-observance of the manual are excluded from our liability and not covered by our warranty.

- The device must only be used as described in this instruction manual. If used otherwise, this can cause dangerous situations for the user and damage to the meter.
- The instrument may only be used if the environmental conditions (temperature, relative humidity, ...) are within the ranges stated in the technical specifications. Do not expose the device to extreme temperatures, direct sunlight, extreme humidity or moisture.
- Do not expose the device to shocks or strong vibrations.
- The case should only be opened by qualified PCE Instruments personnel.
- Never use the instrument when your hands are wet.
- You must not make any technical changes to the device.
- The appliance should only be cleaned with a damp cloth. Use only pH-neutral cleaner, no abrasives or solvents.
- The device must only be used with accessories from PCE Instruments or equivalent.
- Before each use, inspect the case for visible damage. If any damage is visible, do not use the device.
- Do not use the instrument in explosive atmospheres.
- The measurement range as stated in the specifications must not be exceeded under any circumstances.
- Non-observance of the safety notes can cause damage to the device and injuries to the user.

We do not assume liability for printing errors or any other mistakes in this manual.

We expressly point to our general guarantee terms which can be found in our general terms of business.

If you have any questions please contact PCE Instruments. The contact details can be found at the end of this manual.



2 Device description

2.1 Technical specifications

Measured variable CO₂	
Measurement range	0 ... 9999 ppm CO ₂
Accuracy	±75 ppm or ±5 % of rdg. (the higher value applies)
Resolution	1 ppm
CO ₂ sensor type	NDIR sensor
Measured variable temperature	
Measurement range	-10 ... 50 °C / 14 ... 122 °F
Accuracy	±1 °C
Resolution	0.1 °C
Measured variable air humidity	
Measurement range	20 ... 95 % RH
Accuracy	±5 % RH
Resolution	1 % RH
General technical specifications	
Display	3.5" touch LCD
Alarm display	Traffic light function through colour change Alarm tone
Power supply	5 V mini USB
Standby power	<0.5 W
Environmental conditions	1 ... 85 °C / 14 ... 122 °F 20 ... 85 % RH
Protection class	IP21
Dimensions	approx. 96 x 86 x 32.5 mm / 3.7 x 3.3 x 1.2 mm
Weight	<200 g / <7 oz

2.2 Display / touch screen

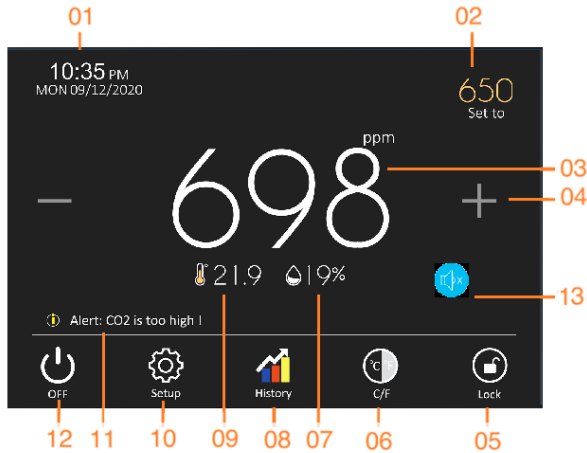

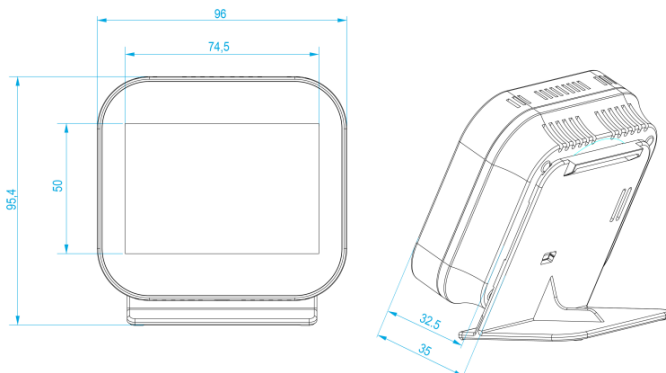

1. Date and time
2. Set lower or upper alarm
3. CO₂ reading
4. Increase or decrease alarm value
5. Lock screen
6. Unit change °C / °F
7. Air humidity reading in % RH
8. Show progress diagramme
9. Temperature reading
10. Settings
11. Alarm message
12. On & off
13. Mute alarm

2.3 Dimensions



3 Operating instructions

3.1 On/off

Touch the  icon to turn on the meter. Touch the  icon while the power is on to turn off the meter.

3.2 Settings

Touch the  icon to access the settings.

3.2.1 Setting the language

The following languages can be selected in the meter: English, Spanish, Italian, Russian, Polish, Czech, German, French, Slovenian, Swedish, Portuguese

3.2.2 Setting the date and time

Touch the menu item Clock Setting  to set the date and time.

3.2.3 Setting the temperature unit

Touch the menu item Temperature Format  to switch between °C and °F.

3.2.4 Setting the display brightness

Touch the menu item Backlight  to adjust the display brightness using the arrow keys at the bottom right of the display. If you touch the item Ambient Light Dimming, the display brightness is adjusted depending on the ambient light at the time of saving.

3.2.5 Standby screen

Touch the menu item Standby Screen  to set the time period when the display dims the brightness.

3.2.6 Screen lock

Touch the menu item Screen Lock  to set a 4-digit PIN to protect against menu access.
Attention: Remember the PIN well. However, if you have forgotten your PIN, you can use the master PIN 8657.

3.2.7 CO₂ alarm limits

Touch the menu item  to set the limits for the lower and upper alarm between 450 ... 4500 ppm.

3.2.8 CO₂ factory calibration

Touch the menu item RESET CO₂ To Factory Settings to calibrate the CO₂ sensor to factory settings. The meter must be placed in a well ventilated room or placed outside and run for 15 minutes.

3.2.9 Offset settings

3.2.9.1 CO₂ offset

Touch the menu item CO₂ Sensor Calibration  to set an offset for the CO₂ reading.

3.2.9.2 Temperature offset

Touch the menu item Built In Sensor  to set an offset for the temperature reading.

3.2.9.3 Humidity sensor offset

Touch the menu item Humidity Sensor  to set an offset for the humidity value reading.

3.2.10 Selecting the time zone

Touch this menu item to set the time difference from GMT. Press the  key to enable synchronisation of the power on/off time with the internet time. To do this, the meter must be successfully connected to the internet.

3.2.11 Daylight saving time

Touch the menu item  to set the daylight saving time based on the location.

3.2.12 Home screen colour

In the menu item Home Screen Colour , select whether the background colour should be blue or black.

3.2.13 Alarm tone

Select the option Alarm Speaker Settings . Touch the button  to enable/disable the alarm sound for the lower or upper alarm.



3.2.14 Reset to factory settings

Select Reset To Factory Settings  to reset the meter to its factory default settings.

Attention: All previously made settings are lost!

3.3 Measurement graph / data history

3.3.1 Graph

Touch the icon  to view the measurement history of the last 7 days. Here, you can view the course of CO₂, temperature and humidity.

To view the details of a particular day, touch the corresponding area above the date. Touch the icon  to view the previous screen.

3.3.2 Save data history

Touch the icon  to view the measurement history of the last 7 days. Then select the menu item Data Log Table. In the next window, you can save the measurement data per hour in a file on the device by selecting the Save to File item.

3.3.3 Read data history on the PC

Connect the meter to a PC using the USB cable. The CO₂ meter is recognised as a mass storage device. In the file DATALOG.TXT, you can view the previously saved measurement data.

3.4 Alarms

Touch the number in the top right corner to set the alarm values for High and Low. The CO₂ meter uses these values to change the colour of the digits for the measured value and an alarm tone can be heard, if selected.

3.4.1 Set upper alarm (High)

As soon as "high" appears in the upper right corner, you can set the upper alarm value using the + and - buttons. This default setting for this alarm threshold is 1200 ppm.

3.4.2 Set lower alarm (Low)

As soon as "low" appears in the upper right corner, you can set the lower alarm value using the + and - buttons. This default setting for this alarm threshold is 800 ppm.

3.4.3 Temporarily deactivating the alarm tone

If the alarm sound has been enabled in the settings, it sounds as soon as the measured value exceeds or falls below the upper/lower alarm value. However, you can also temporarily deactivate

it by touching the icon  on the main screen.

3.5 CO₂ traffic light function

The CO₂ meter has a traffic light function (CO₂ traffic light). The default limit values for changing colours are as follows:

Air quality	CO ₂ content	Colour
Good	400 ... 800 ppm	Green
Ok	800 ... 1200 ppm	Yellow
Poor	1200 ... 5000 ppm	Red

4 Warranty

You can read our warranty terms in our General Business Terms which you can find here: <https://www.pce-instruments.com/english/terms>.

5 Disposal

For the disposal of batteries in the EU, the 2006/66/EC directive of the European Parliament applies. Due to the contained pollutants, batteries must not be disposed of as household waste. They must be given to collection points designed for that purpose.

In order to comply with the EU directive 2012/19/EU we take our devices back. We either re-use them or give them to a recycling company which disposes of the devices in line with law.

For countries outside the EU, batteries and devices should be disposed of in accordance with your local waste regulations.

If you have any questions, please contact PCE Instruments.





PCE Instruments contact information

Germany

PCE Deutschland GmbH
Im Langel 4
D-59872 Meschede
Deutschland
Tel.: +49 (0) 2903 976 99 0
Fax: +49 (0) 2903 976 99 29
info@pce-instruments.com
www.pce-instruments.com/deutsch

United Kingdom

PCE Instruments UK Ltd
Unit 11 Southpoint Business Park
Ensign Way, Southampton
Hampshire
United Kingdom, SO31 4RF
Tel: +44 (0) 2380 98703 0
Fax: +44 (0) 2380 98703 9
info@pce-instruments.co.uk
www.pce-instruments.com/english

The Netherlands

PCE Brookhuis B.V.
Institutenweg 15
7521 PH Enschede
Nederland
Telefoon: +31 (0)53 737 01 92
info@pcebenelux.nl
www.pce-instruments.com/dutch

United States of America

PCE Americas Inc.
1201 Jupiter Park Drive, Suite 8
Jupiter / Palm Beach
33458 FL
USA
Tel: +1 (561) 320-9162
Fax: +1 (561) 320-9176
info@pce-americas.com
www.pce-instruments.com/us

France

PCE Instruments France EURL
23, rue de Strasbourg
67250 Soultz-Sous-Forets
France
Téléphone: +33 (0) 972 3537 17
Numéro de fax: +33 (0) 972 3537 18
info@pce-france.fr
www.pce-instruments.com/french

Italy

PCE Italia s.r.l.
Via Pesciatina 878 / B-Interno 6
55010 Loc. Gragnano
Capannori (Lucca)
Italia
Telefono: +39 0583 975 114
Fax: +39 0583 974 824
info@pce-italia.it
www.pce-instruments.com/italiano

China

PCE (Beijing) Technology Co., Limited
1519 Room, 6 Building
Zhong Ang Times Plaza
No. 9 Mentougou Road, Tou Gou District
102300 Beijing, China
Tel: +86 (10) 8893 9660
info@pce-instruments.cn
www.pce-instruments.cn

Spain

PCE Ibérica S.L.
Calle Mayor, 53
02500 Tobarra (Albacete)
España
Tel. : +34 967 543 548
Fax: +34 967 543 542
info@pce-iberica.es
www.pce-instruments.com/espanol

Turkey

PCE Teknik Cihazları Ltd.Şti.
Halkalı Merkez Mah.
Pehlivan Sok. No.6/C
34303 Küçükçekmece - İstanbul
Türkiye
Tel: 0212 471 11 47
Faks: 0212 705 53 93
info@pce- cihazlari.com.tr
www.pce-instruments.com/turkish

Hong Kong

PCE Instruments HK Ltd.
Unit J, 21/F., COS Centre
56 Tsun Yip Street
Kwun Tong
Kowloon, Hong Kong
Tel: +852-301-84912
jyi@pce-instruments.com
www.pce-instruments.cn