

PicoScope[®] 9300 Series

The new face of sampling oscilloscopes



Up to 25 GHz bandwidth
Electrical, optical, TDR/TDT and 4-channel models

Key features

- 15 TS/s (64 fs) sequential sampling
- Up to 15 GHz prescaled, 2.5 GHz direct trigger and 11.3 Gb/s clock recovery
- Industry-leading 16-bit 1 MS/s ADC and 60 dB dynamic range
- Eye and mask testing to 16 Gb/s with up to $2^{23}-1$ pattern lock
- Intuitive, touch-compatible Windows user interface
- Comprehensive built-in measurements, histogramming and editable data mask library
- Integrated, differential, deskewable TDR/TDT step generator

Applications include:

- Telecom and radar test, service and manufacturing
- Optical fiber, transceiver and laser testing
- RF, microwave and gigabit digital system measurements
- Ethernet, HDMI 1 and 2, USB 2 and 3, PCI, SATA
- Semiconductor characterization
- TDR/TDT analysis of cables, connectors, backplanes, PCBs and networks

Designed for ease of use

The PicoScope 3 workspace takes full advantage of your available display size and resolution. You decide how much space to give to the trace display and the measurements display, and whether to open or hide the control menus. The user interface is fully touch- or mouse-operable, with grabbing and dragging of traces, cursors, regions and parameters. There are enlarged parameter controls for use on smaller touch displays. To zoom, either draw a zoom window or use the more traditional dual timebase, delay and scaling controls.

A choice of screen formats

When working with multiple traces, you can display them all on one grid or separate them into two or four grids. You can also plot signals in XY mode with or without additional voltage-time grids. The persistence display modes use color-coding or shading to show statistical variations in the signal. Trace display can be in either dots-only or vector format.

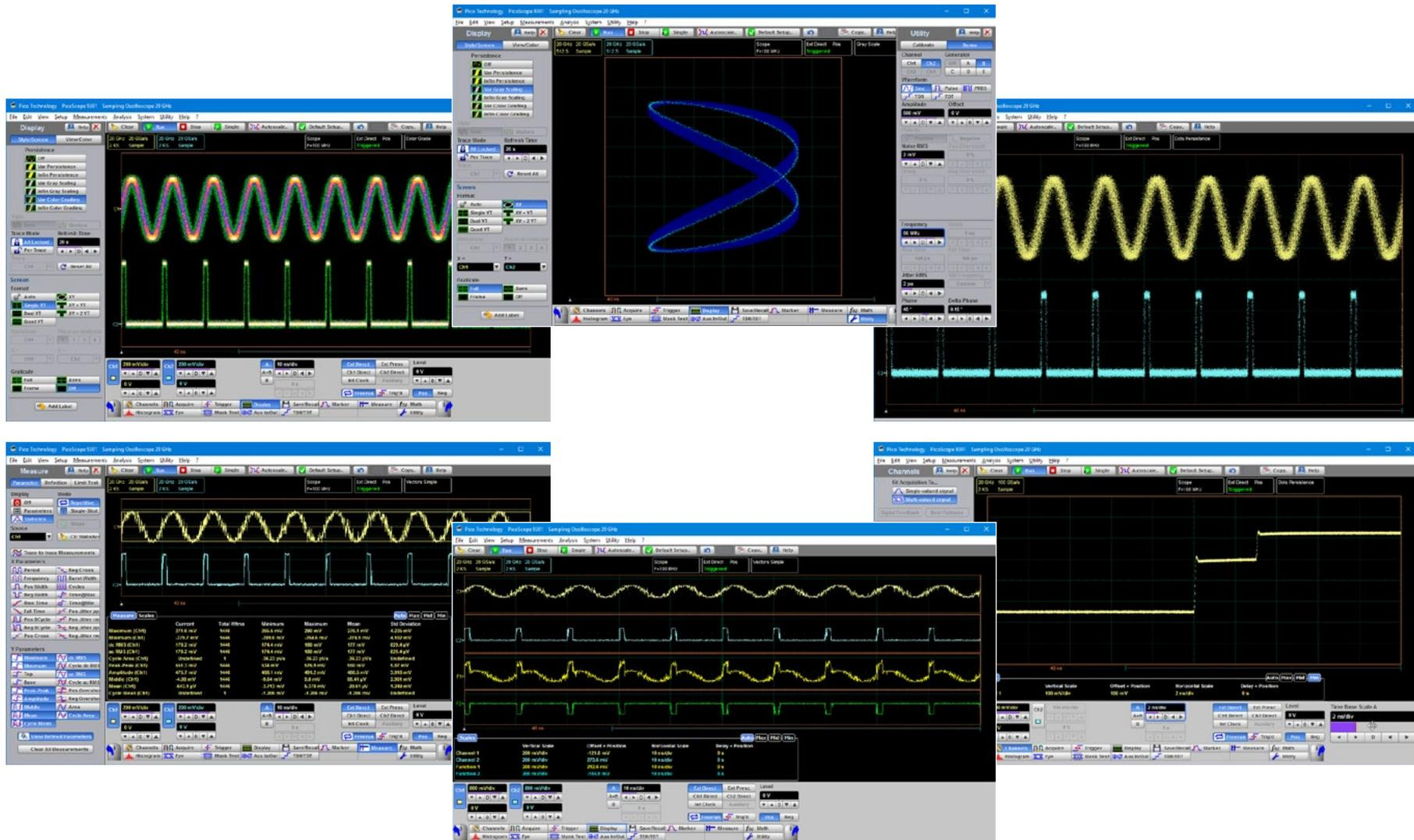

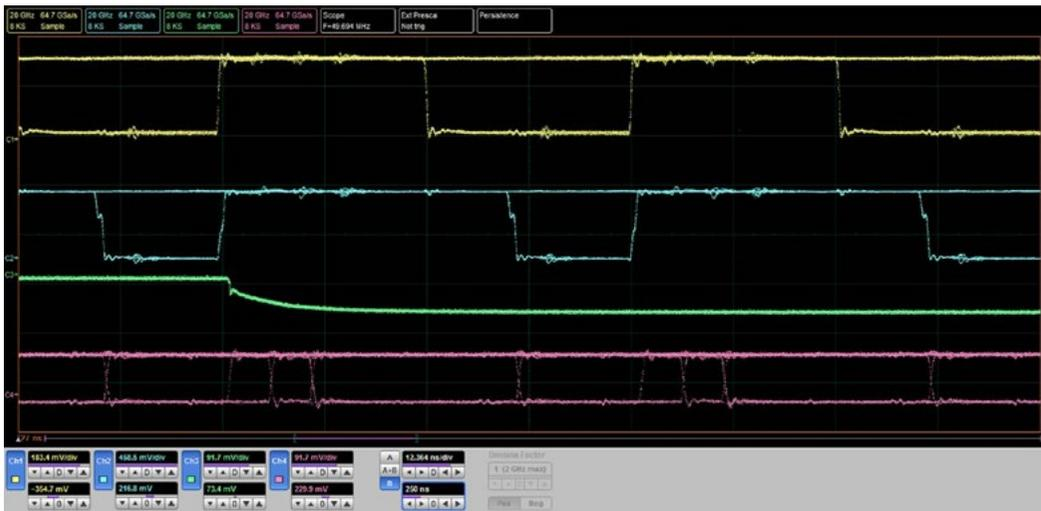

Up to 25 GHz electrical bandwidth

The PicoScope 9300 series offers models at 15, 20 and 25 GHz with low sampling jitter and fine timing resolution to support measurement of transitions down to 14 ps (calculated). Among the fastest of all sampling oscilloscopes, the 9300 Series captures your waveform at up to 1 MS/s with timing resolution down to 64 fs and with 16-bit vertical resolution. It achieves lively trace, persistence and eye updates, greater than 60 dB dynamic range, and trace lengths up to 32 kS.



Trigger modes

- 2.5 GHz direct and up to 15 GHz prescaled trigger
Sampling oscilloscopes accept their trigger from a separate input, either directly for repetition rates up to 2.5 GHz or via a prescaling divider input, for repetition rates up to 15 GHz (14 GHz on 15 and 20 GHz models).
- Built-in 11.3 Gb/s clock data recovery trigger
To support serial data applications in which the data clock is not available as a trigger, or for which trigger jitter needs to be reduced, the PicoScope 9302 and 9321 include a clock recovery module. This continuously regenerates the data clock from the incoming serial data or trigger signal and can do so with reduced jitter even over very long trigger delays or for pattern lock applications. A divider accessory kit is included to route the signal to both the clock recovery and oscilloscope inputs.

Eye-diagram analysis

The PicoScope 9300 Series scopes quickly measure more than 30 fundamental parameters used to characterize non-return-to-zero (NRZ) signals and return-to-zero (RZ) signals. Up to ten parameters can be measured simultaneously, with comprehensive statistics also shown.

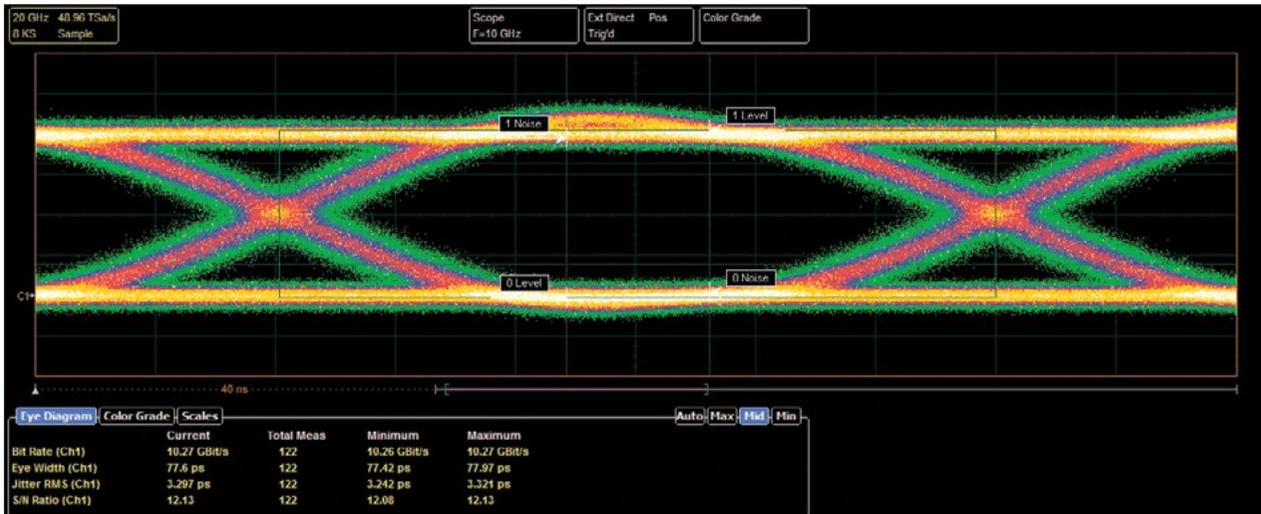

The measurement points and levels used to generate each parameter can optionally be drawn on the trace.

Eye-diagram analysis can be made even more powerful with the addition of mask testing, as described later in this data sheet.

Pattern sync trigger and eye line mode

When a repeating data pattern such as a pseudorandom bit sequence is present, an internal trigger divider can lock to it. You can then use eye-line mode to move the trigger point, and view point, along the whole pattern, bit by bit.

Eye-line scan mode is also available to build an eye diagram from a user-selected range of bit intervals through to the whole pattern. These features are useful for analyzing data-dependent waveshapes.

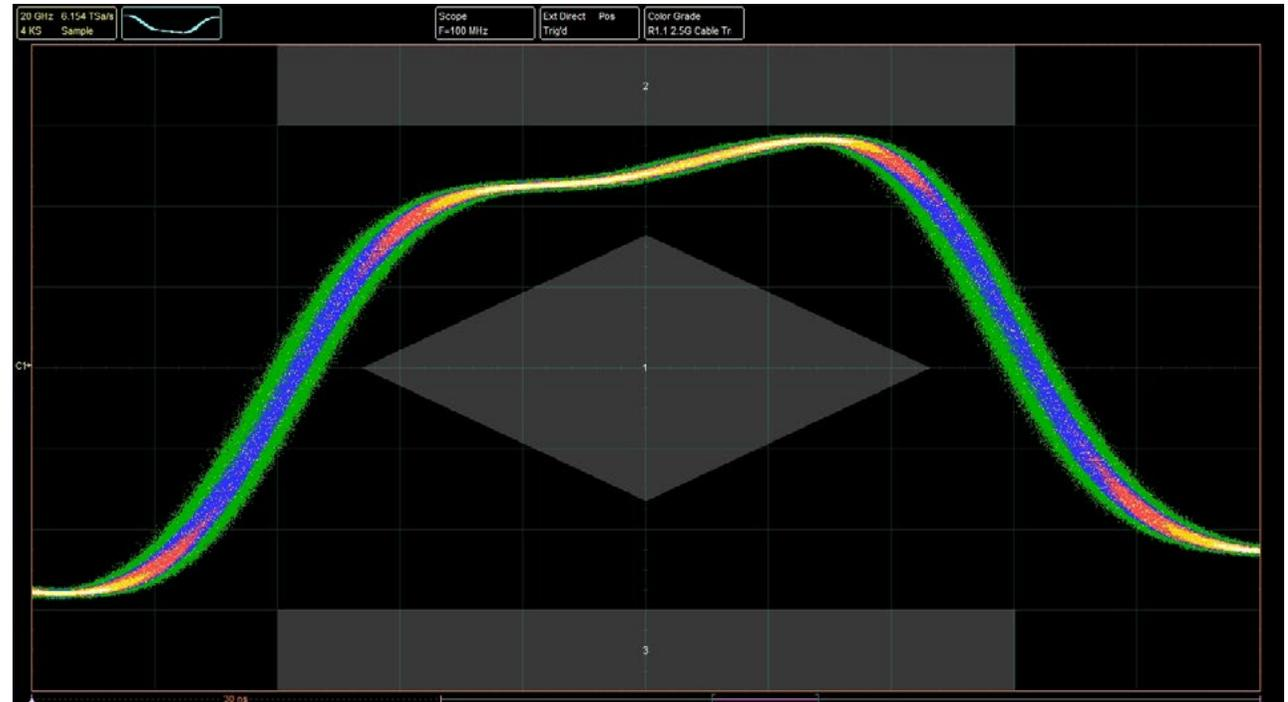

Mask testing

PicoSample 3 has a built-in library of over 160 masks for testing data eyes. It can count or capture mask hits or route them to an alarm or acquisition control. You can stress test against a mask using a specified margin, and locally compile or edit masks.

There's a choice of gray-scale and color-graded display modes to aid in analyzing noise and jitter in eye diagrams. There is also a statistical display showing a failure count for both the original mask and the margin.

The extensive menu of built-in test waveforms is invaluable for checking your mask test setup before using it on live signals.

Mask test features

- Failure count
- User-defined margins
- Count fails
- Built-in standard test waveforms
- Stop on fail

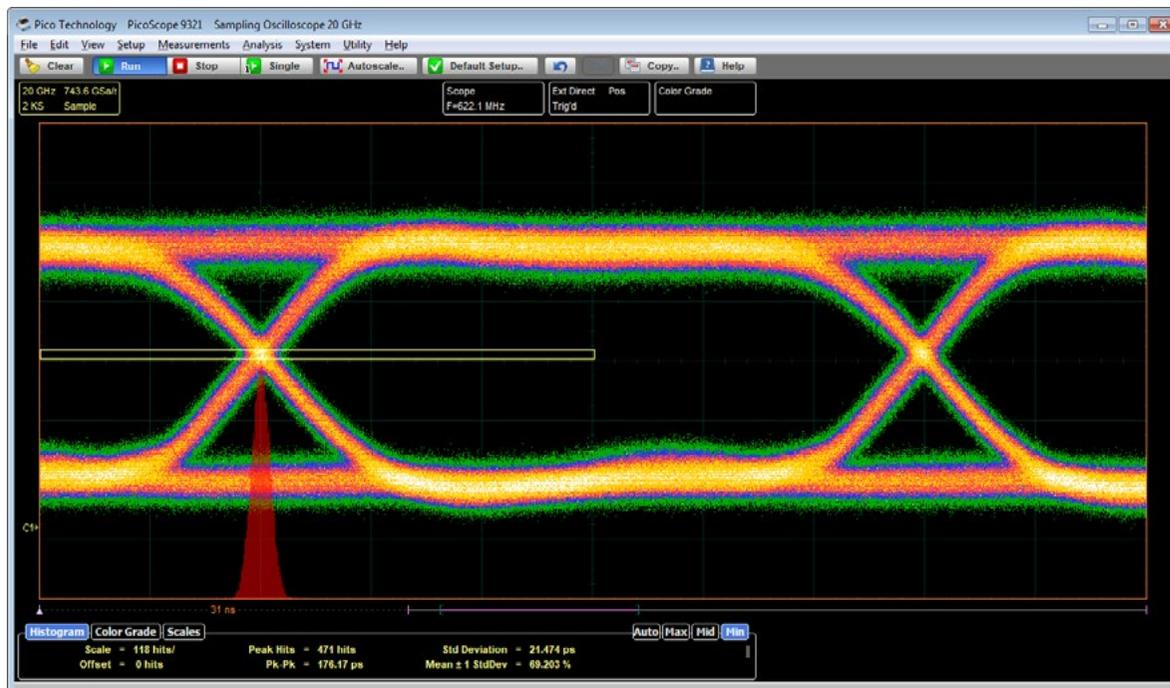
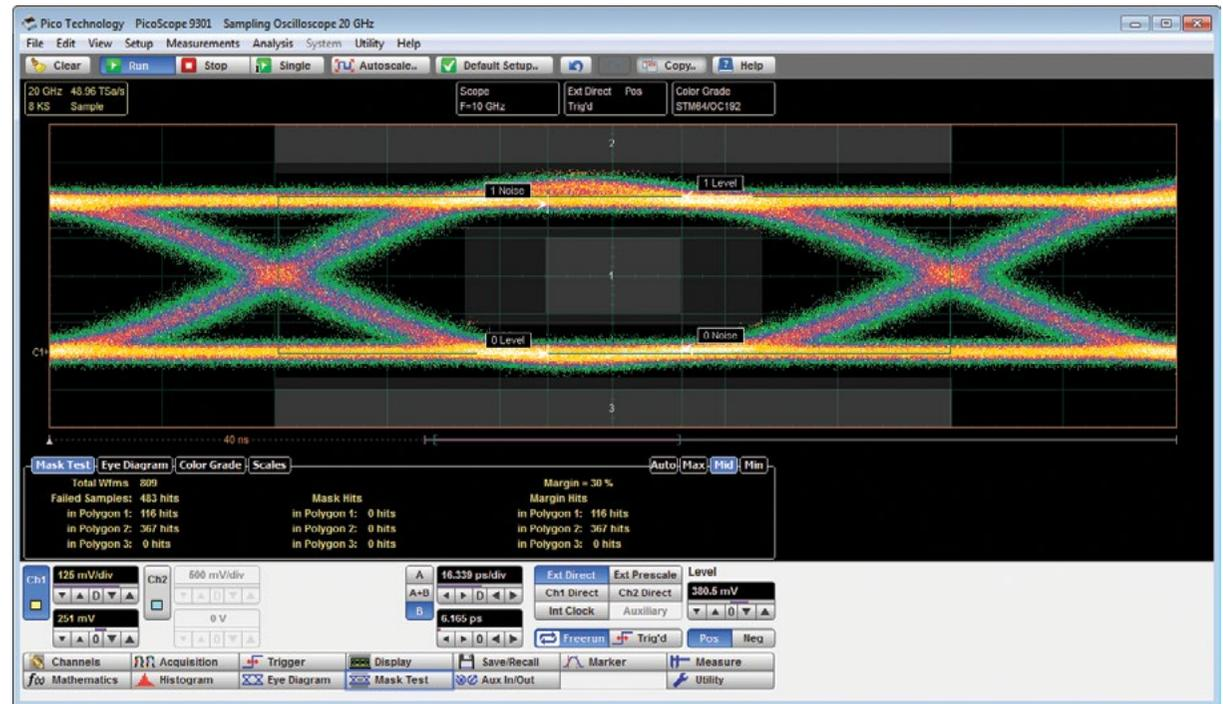
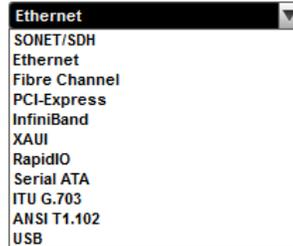

9.5 GHz optical model

The PicoScope 9321-20 includes a built-in precision optical-to-electrical converter. With the converter output routed to one of the scope inputs (optionally through an SMA pulse shaping filter), the PicoScope 9321-20 can analyze standard optical communications signals such as OC48/STM16, 4.250 Gb/s Fibre Channel and 2xGB Ethernet. The scope can perform eye-diagram measurements with automatic measurement of optical parameters including extinction ratio, S/N ratio, eye height and eye width. With its integrated clock recovery module, the scope is usable to 11.3 Gb/s.

The converter input accepts both single-mode (SM) and multi-mode (MM) fibers and has a wavelength range of 750 to 1650 nm.

TDR/TDT analysis

The PicoScope 9311 oscilloscopes feature built-in step generators for time-domain reflectometry and transmission measurements. The 9311-15 integrates a single rising step generator suited to single-ended TDR/TDT applications, while the 9311-20 features deskewable rising and falling step generators suited to single-ended and differential measurements. These features can be used to characterize transmission lines, printed circuit traces, connectors and cables with 16 mm resolution for impedance measurements and 4 mm resolution for fault detection.

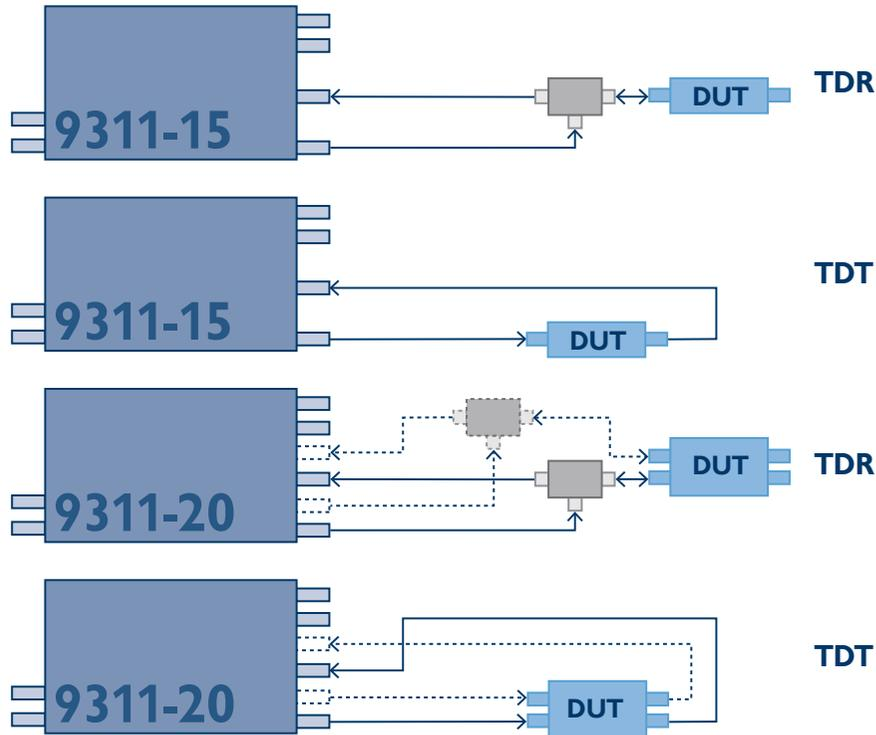

Connection diagrams: PicoScope 9311 sampling oscilloscopes in use with devices under test (DUT) in TDR and TDT applications



The PicoScope 9311-15 and 9311-20 generate 2.5 to 7 V steps with 60 ps rise time from built-in step recovery diodes. They are supplied with a comprehensive set of calibrated accessories to support your TDR/TDT measurements, including cables, signal dividers, adaptors, attenuator and reference load and short.

The PicoScope 9311-20 TDR/TDT model includes source deskew with 1 ps resolution and comprehensive calibration, reference plane and measurement functions. Voltage, impedance or reflection coefficient (ρ) can be plotted against time or distance.

An alternative approach to TDR/TDT capability is to pair any 9300 Series scope with a standalone PG900 pulse generator. These instruments include similar differential step recovery diode step generators and also offer an option of 40 ps tunnel diode step generation. This brings extra flexibility and the ability to remotely position the pulse source. The generators also enable TDT and TDR with the PicoScope 9301, 9302 clock recovery, 9321 optical and 9341 4-channel sampling oscilloscopes.

See back page for ordering details.

PicoConnect® 900 Series: the shape of probes to come

The PicoConnect 900 Series is a range of low-invasive, high-frequency passive probes, designed for microwave and gigabit applications up to 9 GHz and 18 Gb/s. They deliver unprecedented performance and flexibility at a low price and are an obvious choice to use alongside the PicoScope 9300 Series scopes.

A breakthrough in cost and convenience

Until now, the majority of 1 GHz test probes have been of familiar probe shape but with an active buffer amplifier within the probe body. They are mechanically complex, quite bulky, often heavy and always costly.

In a survey of all available active probe models between 3 GHz and 30 GHz, we found that list prices were around \$1000 + \$1000/GHz or higher, a figure which then multiplies with the number of signal channels to be probed. The PicoConnect 900 Series passive probes are all priced around \$100 + \$150/GHz, less when purchased as a kit: that is less than one sixth of the cost per channel!

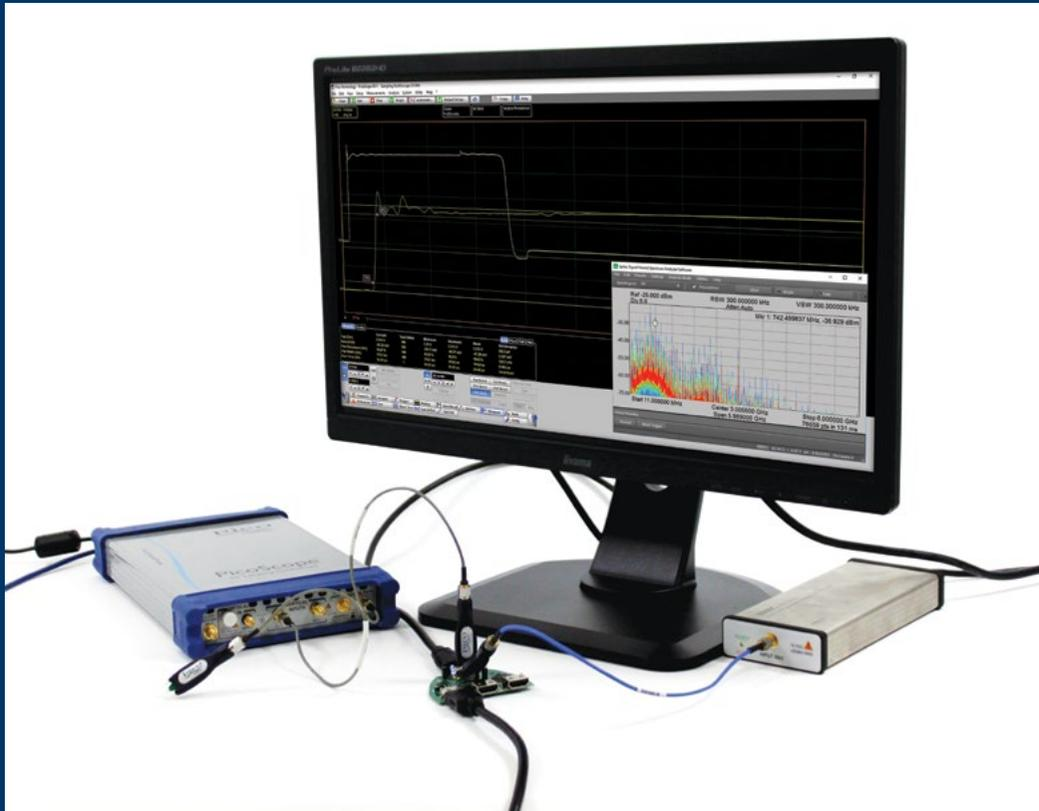

Soldered-in PicoConnect 900 Series probes working with a PicoScope 9300 Series sampling oscilloscope to capture an HDMI signal

Features of the PicoConnect 900 Series probes

- Extremely low loading capacitance of <math>< 0.3 \text{ pF}</math> typical, 0.4 pF upper test limit for all models
- Slim, fingertip design for accurate and steady probing or solder-in at fine scale
- Interchangeable SMA probe heads at division ratios of 5:1, 10:1 and 20:1, AC or DC coupled
- Accurate probing of high speed transmission lines for $Z_0 = 0 \Omega$ to 100Ω
- Specified probe ratio compensated to correct for loading of the low-impedance probe input
- Class-leading uncorrected pulse/eye response and pulse/eye disturbance
- High dynamic range, low noise, and implicit linearity and long-term flatness of a passive design
- Tolerant of very high input slew rate, hardened to EM discharge and no saturation and recovery characteristic. Can address high-amplitude pulse and burst applications.
- Screened to minimize noise or response change caused by finger proximity or EM interference
- Supplied with robust, high-performance, highly flexible low-loss microwave coaxial cable



Ultra-compact: the probe head is just 68 mm long and weighs only 5 g

Measurement of over 100 waveform parameters with and without statistics

The PicoScope 9300 Series scopes quickly measure well over 100 standard waveform and eye parameters, either for the whole waveform or constrained between markers. The markers can also make on-screen ruler measurements, so you don't need to count graticules or estimate the waveform's position. Up to ten simultaneous measurements are possible. The measurements conform to IEEE standard definitions, but you can edit them for non-standard thresholds and reference levels using the advanced menu or by dragging the on-screen thresholds and levels. You can apply limit tests to up to four measured parameters.

A dedicated frequency counter shows signal frequency at all times, regardless of measurement and timebase settings.

Powerful mathematical analysis

The PicoScope 9300 Series scopes support up to four simultaneous mathematical combinations or functional transformations of acquired waveforms.

You can select any of the mathematical functions to operate on either one or two sources. All functions can operate on live waveforms, waveform memories or even other functions. There is also a comprehensive equation editor for creating custom functions of any combination of source waveforms.

FFT analysis

All PicoScope 9300 Series oscilloscopes can calculate real, imaginary and complex Fast Fourier Transforms of input signals using a range of windowing functions. The results can be further processed using the math functions. FFTs are useful for finding crosstalk and distortion problems, adjusting filter circuits designed to filter out certain harmonics in a waveform, testing impulse responses of systems, and identifying and locating noise and interference sources.



Choose from 61 math functions, or create your own



Histogram analysis

Behind the powerful measurement and display capabilities of the 9300 Series lies a fast, efficient data histogramming capability. A powerful visualization and analysis tool in its own right, the histogram is a probability graph that shows the distribution of acquired data from a source within a user-definable window.



Histogram Scales		Max Mid Min	
Scale = 26.9 khits/	Peak Hits = 107.482 khits	Std Deviation = 3.6774 ps	
Offset = 0 hits	Pk-Pk = 29.8 ps	Mean ± 1 StdDev = 67.014 %	
Hits In Box = 5.61958 Mhits	Median = 81.9 ps	Mean ± 2 StdDev = 97.012 %	
Waveforms = 109468 Wfms	Mean = 81.776 ps	Mean ± 3 StdDev = 99.962 %	
Min = 67 ps	Max-Max = 0 s	Max = 96.8 ps	

Histograms can be constructed on waveforms on either the vertical or horizontal axes. The most common use for a vertical histogram is measuring and characterizing noise and pulse parameters. A horizontal histogram is typically used to measure and characterize jitter.

Compact, portable USB instruments

These units occupy very little space on your workbench and are small enough to carry with your laptop for on-site testing, but that's not all. Instead of using remote probe heads attached to a large bench-top unit, you can now position the scope right next to the device under test. Now all that lies between your scope and the DUT is a short, low-loss coaxial cable. Everything you need is built into the oscilloscope, with no expensive hardware or software add-ons to worry about.

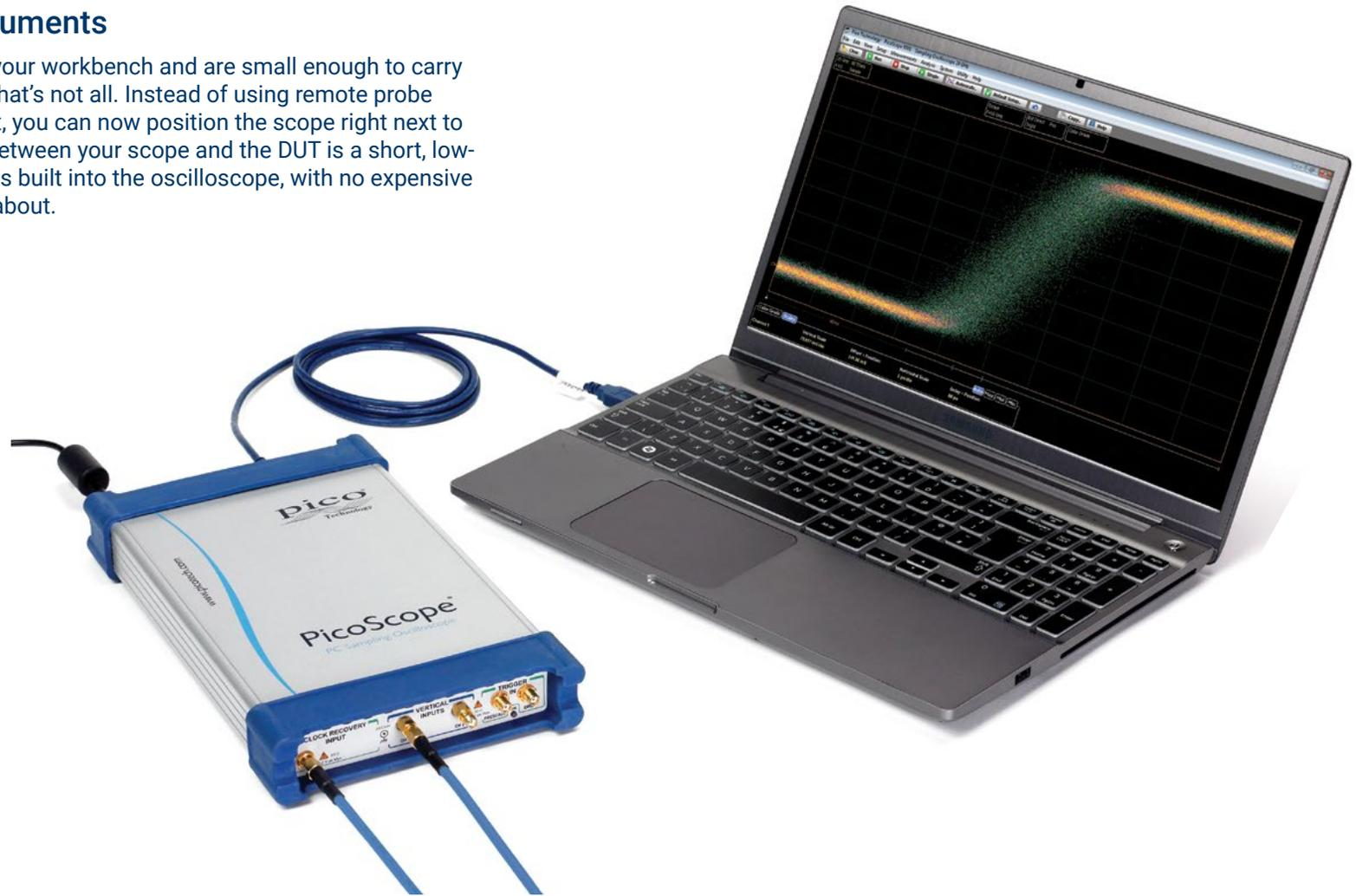

Software Development Kit

The PicoSample 3 software can operate as a stand-alone oscilloscope program or under ActiveX remote control. The ActiveX control conforms to the Windows COM interface standard so that you can embed it in your own software. Unlike more complex driver-based programming methods, ActiveX commands are text strings that are easy to create in any programming environment. Programming examples are provided in Visual Basic (VB.NET), MATLAB, LabVIEW and Delphi, but you can use any programming language or standard that supports the COM interface, including JavaScript and C. National Instruments LabVIEW drivers are also available. All the functions of the PicoScope 9300 and the PicoSample software are accessible remotely.

We supply a comprehensive programmer's guide that details every function of the ActiveX control. Our example code is freely available from our GitHub organization page, github.com/picotech. The SDK can control the oscilloscope over the USB or the LAN port.



Built-in signal generator

All the PicoScope 9300 Series scopes can generate industry-standard and custom signals including clock, pulse and pseudo-random binary sequence. You can use these to test the instrument's inputs, experiment with its features and verify complex setups such as mask tests. AUX OUTPUT can also be configured as a trigger output.



PicoSource® PG900 Series differential pulse generators

For greater versatility than a built-in signal generator can offer, you may want to separate your high-performance fast-step TDR/TDT pulse source from the sampling oscilloscope and have two instruments to use either stand-alone or together as required. The PicoSource PG900 Series generators contain the same step recovery diode pulse source as the PicoScope 9311, or slightly faster but reduced amplitude tunnel diode pulse heads, rehoused in a separate USB-controlled instrument. All are supplied with PicoSource PG900 control software.

Choose from three models

- PicoSource PG911 with integrated 60 ps pulse outputs
- PicoSource PG912 with 40 ps pulse tunnel diode heads
- PicoSource PG914 with both types of output



Key specifications

PicoSource PG911 and PG914

- Integrated 50 Ω SMA(f) step recovery diode outputs
- < 60 ps single-ended pulse transition time
- Two 2.5 V to 7 V variable amplitude outputs
- ±1 ns timing deskew in 1 ps steps
- 20 dB 10 GHz SMA(m-f) attenuators supplied fitted to SRD pulse outputs

PicoSource PG912 and PG914

- External 50 Ω N(m) positive and negative tunnel diode pulse heads
- < 40 ps pulse transition time
- Fixed 200 mV output amplitude
- ±500 ps timing deskew in 1 ps steps
- Inter-series N(f)–SMA(m) adaptors included with pulse heads

All PicoSource PG900 models

- Differential outputs
- 200 ns to 4 μs pulse width
- Adjustable 1 μs to 1 s internal clock period
- Typical 3.0 ps RMS jitter relative to external trigger

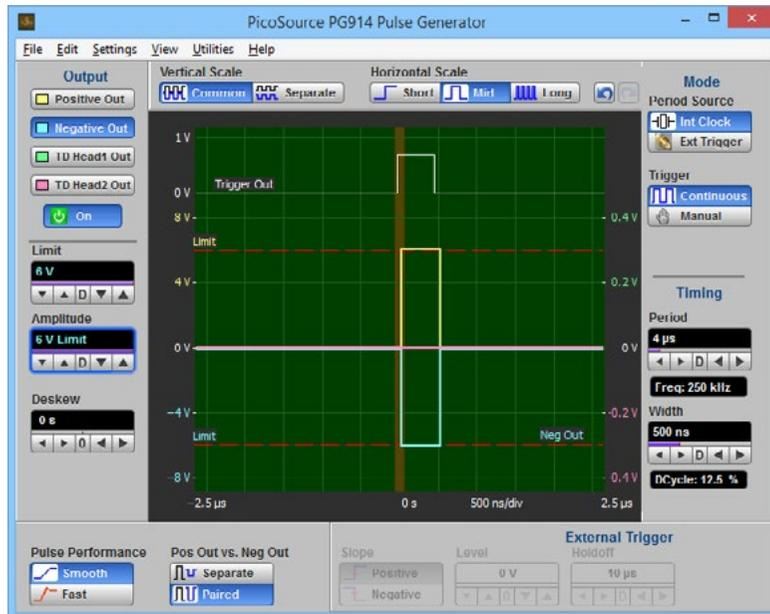

Intuitive Windows-based software

SMA Bessel–Thomson pulse-shaping filters

For use with the 9321-20 optical to electrical converter, a range of Bessel–Thomson filters is available for standard bit rates. These filters are essential for accurate characterization of signals emerging from an optical transmission system.

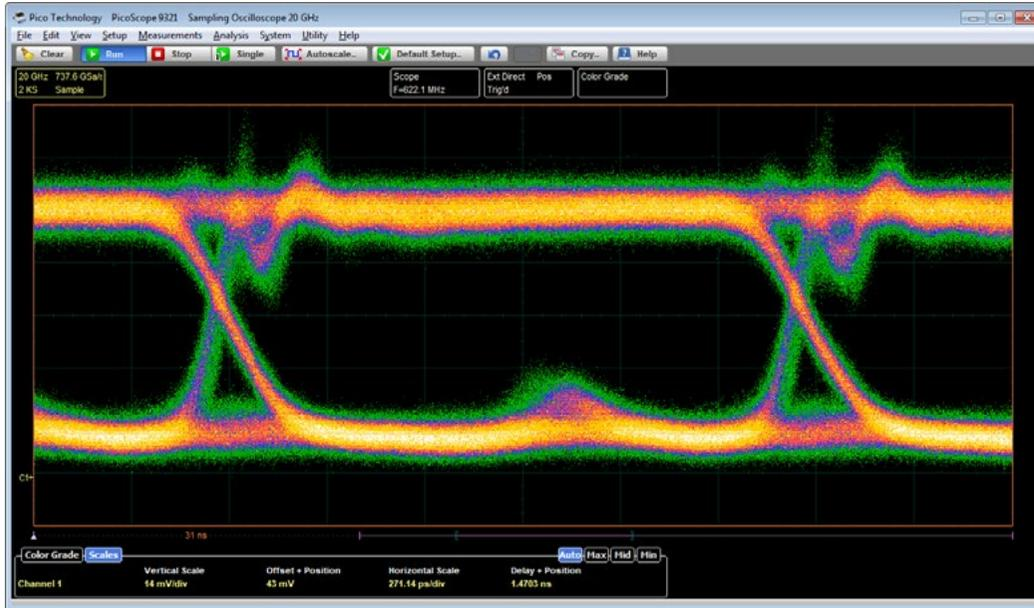

O/E converter output, raw

Above is the ringing typical of an unequalized O/E converter output at 622 Mb/s.

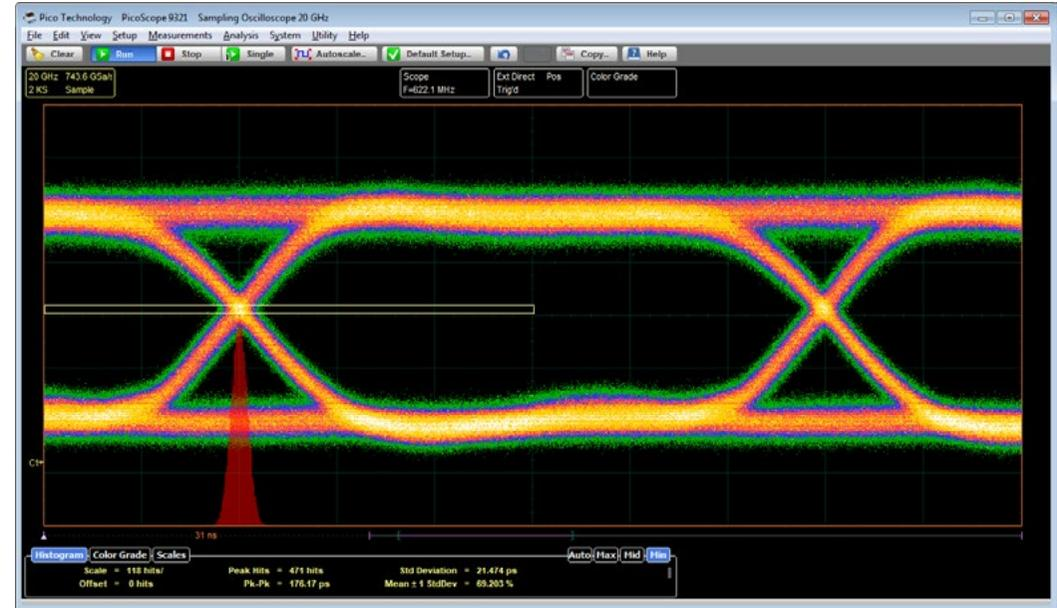

O/E converter output, filtered

Above is the result of connecting the 622 Mb/s B–T filter. This is an accurate representation of the signal that an equalized optical receiver would see, enabling the PicoScope 9321-20 to display correct measurements.



PicoScope 9300 Series inputs and outputs

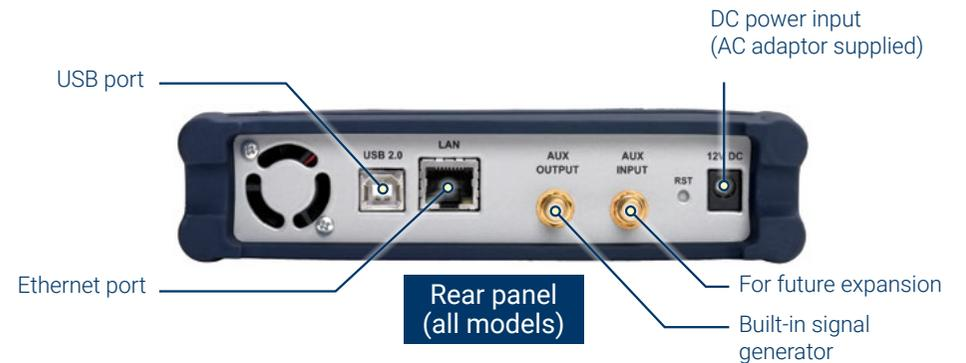
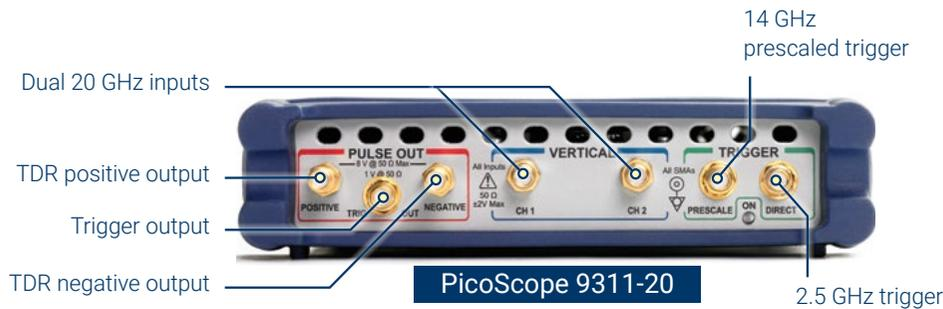
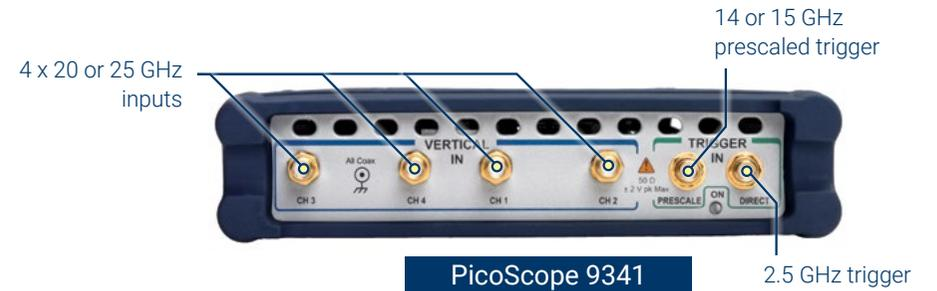
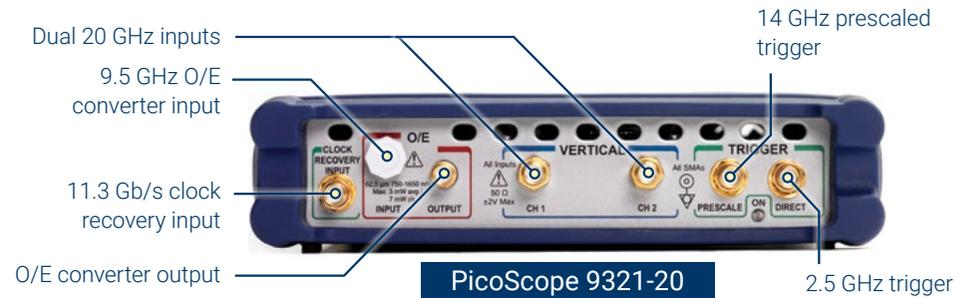

PicoScope 9300 Series specifications

VERTICAL

	9300-15 models	9300-20 models	9300-25 models
Number of channels	PicoScope 9341: 4 Other models: 2		
Acquisition timing	Selectable simultaneous or alternate acquisition		
Bandwidth, full	15 GHz	20 GHz	25 GHz
Bandwidth, narrow	8 GHz	10 GHz	12 GHz
Pulse response rise time, full bandwidth	23.4 ps (10% to 90%, calculated)	17.5 ps (10% to 90%, calculated)	14.0 ps (10% to 90%, calculated)
Pulse response rise time, narrow bandwidth	43.8 ps (10% to 90%, calculated)	35.0 ps (10% to 90%, calculated)	29.2 ps (10% to 90%, calculated)
Noise, full bandwidth	< 1.2 mV RMS typical, < 1.6 mV RMS maximum	< 1.5 mV RMS typical, < 2.0 mV RMS maximum	< 1.9 mV RMS typical, < 2.5 mV RMS maximum
Noise, narrow bandwidth	< 0.7 mV RMS typical, < 0.9 mV RMS maximum	< 0.8 mV RMS typical, < 1.1 mV RMS maximum	< 1.0 mV RMS typical, < 1.3 mV RMS maximum
Noise with averaging	100 μ V RMS system limit, typical		
Operating input voltage with digital feedback	1 V p-p with \pm 1 V range (single-valued)		
Operating input voltage without digital feedback	\pm 400 mV relative to channel offset (multi-valued)		
Sensitivity	1 mV/div to 500 mV/div in 1-2-5 sequence with 0.5% fine increments		
Resolution	16 bits, 40 μ V/LSB		
Accuracy	\pm 2% of full scale \pm 2 mV over temperature range for stated accuracy (assuming temperature-related calibrations are performed)		
Nominal input impedance	(50 \pm 1) Ω		
Input connectors	2.92 mm (K) female, compatible with SMA and PC3.5		

TIMEBASE (SEQUENTIAL TIME SAMPLING MODE)

Ranges	5 ps/div to 3.2 ms/div (main, intensified, delayed, or dual delayed)		
Delta time interval accuracy	For > 200 ps/div: \pm 0.2% of delta time interval \pm 12 ps For \leq 200 ps/div: \pm 5% of delta time interval \pm 5 ps		
Time interval resolution	64 fs		
Channel deskew	1 ps resolution, 100 ns max.		

TRIGGERS

Trigger sources	All models: external direct, external prescaled, internal direct and internal clock triggers. PicoScope 9302 and 9321 only: external clock recovery trigger		
External direct trigger bandwidth and sensitivity	DC to 100 MHz : 100 mV p-p; to 2.5 GHz: 200 mV p-p		
External direct trigger jitter	1.8 ps RMS (typ.) or 2.0 ps RMS (max.) + 20 ppm of delay setting		
Internal direct trigger bandwidth and sensitivity	DC to 10 MHz: 100 mV p-p; to 100 MHz: 400 mV p-p (channels 1 and 2 only)		
Internal direct trigger jitter	25 ps RMS (typ.) or 30 ps RMS (max.) + 20 ppm of delay setting (channels 1 and 2 only)		
External prescaled trigger bandwidth and sensitivity	1 to 14 GHz, 200 mV p-p to 2 V p-p		1 to 14 GHz, 200 mV p-p to 2 V p-p 14 to 15 GHz, 500 mV p-p to 2 V p-p
External prescaled trigger jitter	1.8 ps RMS (typ.) or 2.0 ps RMS (max.) + 20 ppm of delay setting		
Pattern sync trigger clock frequency	10 MHz to 14 GHz	10 MHz to 14 GHz	10 MHz to 15 GHz
Pattern sync trigger pattern length	7 to 8 388 607 ($2^{23} - 1$)		

CLOCK RECOVERY (PICOSCOPE 9302 AND 9321)

Clock recovery trigger data rate and sensitivity	6.5 Mb/s to 100 Mb/s: 100 mV p-p > 100 Mb/s to 11.3 Gb/s: 20 mV p-p
Recovered clock trigger jitter	1 ps RMS (typ.) or 1.5 ps RMS (max.) + 1.0% of unit interval
Maximum safe trigger input voltage	±2 V (DC + peak AC)
Input characteristics	50 Ω, AC coupled
Input connector	SMA (f)
ACQUISITION	
ADC resolution	16 bits
Digitizing rate with digital feedback (single-valued)	DC to 1 MHz
Digitizing rate without digital feedback (multi-valued)	DC to 40 kHz
Acquisition modes	Sample (normal), average, envelope
Data record length	32 to 32 768 points (single channel) in x2 sequence
DISPLAY	
Styles	Dots, vectors, persistence, gray-scaling, color-grading
Persistence time	Variable or infinite
Screen formats	Auto, single YT, dual YT, quad YT, XY, XY + YT, XY + 2 YT
MEASUREMENTS AND ANALYSIS	
Markers	Vertical bars, horizontal bars (measure volts) or waveform markers
Automatic measurements	Up to 10 at once
Measurements, X parameters	Period, frequency, pos/neg width, rise/fall time, pos/neg duty cycle, pos/neg crossing, burst width, cycles, time at max/min, pos/neg jitter ppm/RMS
Measurements, Y parameters	Max, min, top, base, peak-peak, amplitude, middle, mean, cycle mean, AC/DC RMS, cycle AC/DC RMS, pos/neg overshoot, area, cycle area
Measurements, trace-to-trace	Delay 1R-1R, delay 1F-1R, delay 1R-nR, delay 1F-nR, delay 1R-1F, delay 1F-1F, delay 1R-nF, delay 1F-nF, phase deg/rad/%, gain, gain dB
Eye measurements, X NRZ	Area, bit rate, bit time, crossing time, cycle area, duty cycle distortion abs/%, eye width abs/%, rise/fall time, frequency, period, jitter p-p/RMS
Eye measurements, Y NRZ	AC RMS, average power lin/dB, crossing %/level, extinction ratio dB%/lin, eye amplitude, eye height lin/dB, max/min, mean, middle, pos/neg overshoot, noise p-p/RMS one/zero level, p-p, RMS, S/N ratio lin/dB
Eye measurements, X RZ	Area, bit rate/time, cycle area, eye width abs/%, rise/fall time, jitter p-p/RMS fall/rise, neg/pos crossing, pos duty cycle, pulse symmetry, pulse width
Eye measurements, Y RZ	AC RMS, average power lin/dB, contrast ratio lin/dB/%, extinction ratio lin/dB/%, eye amplitude, eye high lin/dB, eye opening, max, min, mean, middle, noise p-p/RMS one/zero, one/zero level, peak-peak, RMS, S/N
Histogram	Vertical or horizontal
MATH FUNCTIONS	
Mathematics	Up to four math waveforms can be defined and displayed
Math functions, arithmetic	+, -, ×, ÷, ceiling, floor, fix, round, absolute, invert, (x+y)/2, ax+b
Math functions, algebraic	e ^x , ln, 10 ^x , log ₁₀ , a ^x , log _a , d/dx, ∫, x ² , sqrt, x ³ , x ^a , x ⁻¹ , sqrt(x ² +y ²)
Math functions, trigonometric	sin, sin ⁻¹ , cos, cos ⁻¹ , tan, tan ⁻¹ , cot, cot ⁻¹ , sinh, cosh, tanh, coth
Math functions, FFT	Complex FFT, complex inverse FFT, magnitude, phase, real, imaginary
Math functions, combinatorial logic	AND, NAND, OR, NOR, XOR, XNOR, NOT
Math functions, interpolation	Linear, sin(x)/x, trend, smoothing

Math functions, other	Custom formula																																							
FFT	Up to two FFTs simultaneously																																							
FFT window functions	Rectangular, Hamming, Hann, Flat-top, Blackman–Harris, Kaiser–Bessel																																							
Eye diagram	Automatically characterizes NRZ and RZ eye diagrams based on statistical analysis of waveform																																							
MASK TESTS																																								
Mask geometry	Acquired signals are tested for fit outside areas defined by up to eight polygons. Standard or user-defined masks can be selected.																																							
Built-in masks, SONET/SDH	OC1/STMO (51.84 Mb/s) to FEC 1071 (10.709 Gb/s)																																							
Built-in masks, Ethernet	1.25 Gb/s 1000Base-CX Absolute TP2 to 10xGB Ethernet (12.5 Gb/s)																																							
Built-in masks, Fibre Channel	FC133 (132.8 Mb/s) to 10x Fibre Channel (10.5188 Gb/s)																																							
Built-in masks, PCI Express	R1.0a 2.5G (2.5 Gb/s) to R2.1 5.0G (5 Gb/s)																																							
Built-in masks, InfiniBand	2.5G (2.5 Gb/s) to 5.0G (5 Gb/s)																																							
Built-in masks, XAUI	3.125 Gb/s																																							
Built-in masks, RapidIO	Level 1, 1.25 Gb/s to 3.125 Gb/s																																							
Built-in masks, SATA	1.5G (1.5 Gb/s) to 3.0G (3 Gb/s)																																							
Built-in masks, ITU G.703	DS1 (1.544 Mb/s) to 155 Mb (155.520 Mb/s)																																							
Built-in masks, ANSI T1.102	DS1 (1.544 Mb/s) to STS3 (155.520 Mb/s)																																							
Built-in masks, G.984.2	XAUI-E Far (3.125 Gb/s)																																							
Built-in masks, USB	USB 2.0, USB 3.0 and USB 3.1																																							
SIGNAL GENERATOR OUTPUT																																								
Modes	Pulse, PRBS (NRZ and RZ), 500 MHz clock, trigger out																																							
Period range, pulse mode	8 ns to 524 μ s																																							
Bit time range, NRZ/RZ mode	4 ns to 260 μ s																																							
NRZ/RZ pattern length	2^7-1 to $2^{15}-1$																																							
<table border="1"> <thead> <tr> <th></th> <th>PicoScope 9311-15</th> <th>PicoScope 9311-20</th> </tr> </thead> <tbody> <tr> <td>Number of output channels</td> <td>1</td> <td>2 (1 differential pair)</td> </tr> <tr> <td>Output enable</td> <td>Yes</td> <td>Independent or locked control for each source</td> </tr> <tr> <td>Pulse polarity</td> <td>Positive-going from zero volts</td> <td>Channel 1: positive-going from zero volts Channel 2: negative-going from zero volts</td> </tr> <tr> <td>Rise time (20% to 80%)</td> <td>60 ps guaranteed</td> <td></td> </tr> <tr> <td>Amplitude</td> <td>2.5 V to 7 V into 50 Ω</td> <td></td> </tr> <tr> <td>Amplitude adjustment</td> <td>5 mV increments</td> <td></td> </tr> <tr> <td>Amplitude accuracy</td> <td>$\pm 10\%$</td> <td></td> </tr> <tr> <td>Offset</td> <td></td> <td></td> </tr> <tr> <td>Output amplitude safety limit</td> <td>Adjustable from 2.5 V to 8 V</td> <td></td> </tr> <tr> <td>Output pairing</td> <td>N/A</td> <td>Amplitudes and limit paired or independent</td> </tr> <tr> <td>Period range</td> <td>1 μs to 60 ms</td> <td></td> </tr> <tr> <td>Period accuracy</td> <td>± 100 ppm</td> <td></td> </tr> </tbody> </table>			PicoScope 9311-15	PicoScope 9311-20	Number of output channels	1	2 (1 differential pair)	Output enable	Yes	Independent or locked control for each source	Pulse polarity	Positive-going from zero volts	Channel 1: positive-going from zero volts Channel 2: negative-going from zero volts	Rise time (20% to 80%)	60 ps guaranteed		Amplitude	2.5 V to 7 V into 50 Ω		Amplitude adjustment	5 mV increments		Amplitude accuracy	$\pm 10\%$		Offset			Output amplitude safety limit	Adjustable from 2.5 V to 8 V		Output pairing	N/A	Amplitudes and limit paired or independent	Period range	1 μ s to 60 ms		Period accuracy	± 100 ppm	
	PicoScope 9311-15	PicoScope 9311-20																																						
Number of output channels	1	2 (1 differential pair)																																						
Output enable	Yes	Independent or locked control for each source																																						
Pulse polarity	Positive-going from zero volts	Channel 1: positive-going from zero volts Channel 2: negative-going from zero volts																																						
Rise time (20% to 80%)	60 ps guaranteed																																							
Amplitude	2.5 V to 7 V into 50 Ω																																							
Amplitude adjustment	5 mV increments																																							
Amplitude accuracy	$\pm 10\%$																																							
Offset																																								
Output amplitude safety limit	Adjustable from 2.5 V to 8 V																																							
Output pairing	N/A	Amplitudes and limit paired or independent																																						
Period range	1 μ s to 60 ms																																							
Period accuracy	± 100 ppm																																							
TDR PULSE OUTPUTS																																								
Number of output channels	1	2 (1 differential pair)																																						
Output enable	Yes	Independent or locked control for each source																																						
Pulse polarity	Positive-going from zero volts	Channel 1: positive-going from zero volts Channel 2: negative-going from zero volts																																						
Rise time (20% to 80%)	60 ps guaranteed																																							
Amplitude	2.5 V to 7 V into 50 Ω																																							
Amplitude adjustment	5 mV increments																																							
Amplitude accuracy	$\pm 10\%$																																							
Offset																																								
Output amplitude safety limit	Adjustable from 2.5 V to 8 V																																							
Output pairing	N/A	Amplitudes and limit paired or independent																																						
Period range	1 μ s to 60 ms																																							
Period accuracy	± 100 ppm																																							

	PicoScope 9311-15	PicoScope 9311-20
Width range	200 ns to 4 μ s, 0% to 50% duty cycle	
Width accuracy	\pm 10% of width \pm 100 ns	
Deskew between outputs	N/A	-1 ns to 1 ns typical, in 1 ps increments
Timing modes	Step, coarse timebase, pulse	
Impedance	50 Ω	
Connectors on scope	SMA(f)	SMA(f) x 2
TDR PRE-TRIGGER OUTPUT		
Polarity	Positive-going from zero volts	
Amplitude	700 mV typical into 50 Ω	
Pre-trigger	25 ns to 35 ns typical, adjustable in 5 ps steps	
Pre-trigger to output jitter	2 ps max.	
TDT SYSTEM		
Number of TDT channels	1	2
Incident rise time (combined oscilloscope and pulse generator, 10% to 90%)	65 ps or less	60 ps or less, each polarity
Jitter	3 ps + 20 ppm of delay setting, RMS, maximum	
Corrected rise time	Min. 50 ps or 0.1 x time/div, whichever is greater, typical Max. 3 x time/div, typical	
Corrected aberrations	\leq 0.5% typical	
TDR SYSTEM		
Number of channels	1	2
Incident step amplitude	50% of input pulse amplitude, typical	
Incident rise time (combined oscilloscope, step generator and TDR kit, 10% to 90%)	65 ps or less	60 ps or less, each polarity
Reflected step amplitude, from short or open	25% of input pulse amplitude, typical	
Reflected rise time (combined oscilloscope, step generator and TDR kit, 10% to 90%)	65 ps or less @ 50 Ω termination	60 ps or less @ 50 Ω termination, each polarity
Corrected rise time	Minimum: 50 ps or 0.1 x time/div, whichever is greater, typical. Maximum: 3 x time/div, typical.	
Corrected aberration	\leq 1% typical	
Measured parameters	Propagation delay, gain, gain dB	
TDR/TDT SCALING		
TDT vertical scale	Volts, gain (10 m/div to 100 /div)	
TDR vertical scale	Volts, rho (10 mrho/div to 2 rho/div), ohm (1 ohm/div to 100 ohm/div)	
Horizontal scale	Time (800 ns/div max.) or distance (meter, foot, inch)	
Distance preset units	Propagation velocity (0.1 to 1.0) or dielectric constant (1 to 100)	

OPTICAL/ELECTRICAL CONVERTER (PICOSCOPE 9321-20)

Bandwidth (-3 dB)	9.5 GHz typical
Effective wavelength range	750 nm to 1650 nm
Calibrated wavelengths	850 nm (MM), 1310 nm (MM/SM), 1550 nm (SM)
Transition time	51 ps typical (10% to 90% calculated from $T_R = 0.48/\text{optical BW}$)
Noise	4 μW (1310 & 1550 nm), 6 μW (850 nm) maximum @ full electrical bandwidth
DC accuracy	$\pm 25 \mu\text{W} \pm 10\%$ of full scale
Maximum input peak power	+7 dBm (1310 nm)
Fiber input	Single-mode (SM) or multi-mode (MM)
Fiber input connector	FC/PC
Input return loss	SM: -24 dB typical MM: -16 dB typical, -14 dB maximum
GENERAL	
Temperature range, operating	+5 °C to +35 °C
Temperature range for stated accuracy	Within 2 °C of last autocalibration
Temperature range, storage	-20 °C to +50 °C
Calibration validity period	1 year
Power supply voltage	+12 V DC \pm 5%
Power supply current	1.7 A max.
Mains adaptor	Universal adaptor supplied
PC connection	USB 2.0 (compatible with USB 3.0)
LAN connection	10/100 Mbit/s
PC requirements	Microsoft Windows XP (SP2 or SP3), Vista, 7, 8 or 10. 32-bit or 64-bit versions.
Dimensions	170 mm x 285 mm x 40 mm (W x D x H)
Weight	1.3 kg max.
Compliance	FCC (EMC), CE (EMC and LVD)
Warranty	5 years

More detailed specifications can be found in the *PicoScope 9300 Series User's Guide*, available from www.picotech.com/downloads.

PicoScope 9300 Series models compared

	PicoScope model				
	9301	9302	9311	9321	9341
15 GHz model	•	•	•		
20 GHz model			•	•	•
25 GHz model	•	•			•
Number of electrical inputs	2	2	2	2	4
Signal generator output	•	•	•	•	•
Integrated TDR/TDT (60 ps, 2.5 to 7 V)			•		
Add external PG900 TDR/TDT source	•	•	Optional*	•	•
9.5 GHz optical-electrical converter				•	
Clock recovery trigger		•		•	
Pattern sync trigger	•	•	•	•	•
USB port	•	•	•	•	•
LAN port	•	•	•	•	•

* PG900 external source can be used in addition to the built-in TDR/TDT source.

Kit contents (all models)

- Picoscope 9300 Series PC sampling oscilloscope
- PicoSample™ 3 software CD
- Quick Start Guide
- 12 V power supply, universal input
- Localized mains lead (line cord)
- USB cable, 1.8 m
- SMA / PC3.5 / 2.92 wrench
- Storage and carry case
- LAN cable, 1 m



Kit contents (model-dependent)

	Order code	PicoScope model					
		9301	9302	9311-15	9311-20	9321	9341
18 GHz 50 Ω SMA(m-f) connector saver adaptor*	TA170	•	•	•	•	•	•
30 cm precision sleeved coaxial cable	TA265			1	2		
10 dB 10 GHz SMA(m-f) attenuator (fitted to pulse outputs)	TA262		•			•	
20 dB 10 GHz SMA(m-f) attenuator (fitted to pulse outputs)	TA173			1	2		
14 GHz 25 ps TDR/TDT kit (details below)	TA237			1	2		
14 GHz power divider kit (details below)	TA238		•	1	2	•	

* One TA170 is fitted to each input channel. Remove adaptor and connect directly to input for demanding applications.

Optional accessories

	Order code	USD*	EUR*	GBP*
PicoConnect 900 Series passive probes				
PicoConnect 911 20:1 960 Ω AC-coupled 4 GHz RF, microwave and pulse probe	TA274	699	579	459
PicoConnect 912 20:1 960 Ω DC-coupled 4 GHz RF, microwave and pulse probe	TA275	699	579	459
PicoConnect 913 10:1 440 Ω AC-coupled 4 GHz RF, microwave and pulse probe	TA278	699	579	459
PicoConnect 914 10:1 440 Ω DC-coupled 4 GHz RF, microwave and pulse probe	TA279	699	579	459
PicoConnect 915 5:1 230 Ω AC-coupled 5 GHz RF, microwave and pulse probe	TA282	849	709	559
PicoConnect 916 5:1 230 Ω DC-coupled 5 GHz RF, microwave and pulse probe	TA283	849	709	559
PicoConnect 921 20:1 515 Ω AC-coupled 6 GHz gigabit probe	TA272	1 005	839	659
PicoConnect 922 20:1 515 Ω DC-coupled 6 GHz gigabit probe	TA273	1 005	839	659
PicoConnect 923 10:1 250 Ω AC-coupled 7 GHz gigabit probe	TA276	1 165	969	769
PicoConnect 924 10:1 250 Ω DC-coupled 7 GHz gigabit probe	TA277	1 165	969	769
PicoConnect 925 5:1 220 Ω AC-coupled 9 GHz gigabit probe	TA280	1 395	1 165	919
PicoConnect 926 5:1 220 Ω DC-coupled 9 GHz gigabit probe	TA281	1 395	1 165	919
PicoConnect 910 Kit: all six microwave and pulse probe heads with two cables	PQ067	3 095	2 595	2 045
PicoConnect 920 Kit: all six gigabit probe heads with two cables	PQ066	5 105	4 285	3 375
Tetris high-impedance 10:1 active probes				
1.5 GHz 0.9 pF probe, 50 Ω BNC(m) output, with accessory kit and SMA adaptor	TA222	1 085	969	759
2.5 GHz 0.9 pF probe, 50 Ω SMA(m) output, with accessory kit and BNC adaptor	TA223	2 005	1 785	1 405



Optional accessories

Bessel–Thomson reference optical receiver filters

For use with the PicoScope 9321 O/E converter, to reduce peaking and ringing.
Choice of filter depends on the bit rate of the signal under analysis

51.8 Mb/s bit rate (OC1/STM0)

155 Mb/s bit rate (OC3/STM1)

622 Mb/s bit rate (OC12/STM4)

1.250 Gb/s bit rate (GBE)

2.488 Gb/s bit rate (OC48/STM16) / 2.500 Gb/s bit rate (Infiniband 2.5G)

Order code

USD*

EUR*

GBP*

TA120

129

119

92

TA121

129

119

92

TA122

129

119

92

TA123

129

119

92

TA124

129

119

92



14 GHz 25 ps TDR kit

- 18 GHz SMA(f) reference short
- 18 GHz SMA(f) reference load

TA237

329

289

229



14 GHz power divider kit

- 18 GHz 50 Ω SMA(f-f-f) 3-resistor 6 dB power divider
- 2 x 10 cm precision coaxial SMA(m-m) cable

TA238

539

479

379



Attenuator 3 dB 10 GHz 50 Ω SMA (m-f)

Attenuator 6 dB 10 GHz 50 Ω SMA (m-f)

Attenuator 10 dB 10 GHz 50 Ω SMA (m-f)

Attenuator 20 dB 10 GHz 50 Ω SMA (m-f)

TA181

75

67

53

TA261

75

67

53

TA262

75

67

53

TA173

75

67

53



Optional accessories

	Order code	USD*	EUR*	GBP*	
18 GHz, 50 Ω N(f) to SMA(m) interseries adaptor	TA172	129	119	92	
18 GHz SMA(f) to N(m) interseries adaptor	TA314	119	99	81	
18 GHz 50 Ω SMA(m-f) connector saver adaptor	TA170	20	18	14	
Precision high-flex unsleeved coaxial cable 60 cm SMA(m-m) 1.9 dB loss @ 13 GHz	TA263	75	67	53	
Precision high-flex unsleeved coaxial cable 30 cm SMA(m-m) 1.1 dB loss @ 13 GHz	TA264	65	58	46	
Precision sleeved coaxial cable 30 cm SMA(m-m) 1.3 dB loss @ 13 GHz	TA265	65	58	46	
Precision sleeved coaxial cable 60 cm SMA(m-m) 2.2 dB loss @ 13 GHz	TA312	70	59	47	

* Prices correct at time of publication. Sales taxes not included. Please contact Pico Technology for the latest prices before ordering.

PicoScope 9300 Series ordering information

	Bandwidth (GHz)	Channels	Clock recovery (Gb/s)	Optical-to-electrical converter (GHz)	TDR/TDT output(s) (V) (ps)	Order code	USD*	EUR*	GBP*	
PicoScope 9301-15	15	2	11.3		2.5 to 7	60	PQ089	10 935	9 285	7 675
PicoScope 9301-25	25						PQ094	16 765	14 235	11 765
PicoScope 9302-15	15						PQ090	13 485	11 455	9 465
PicoScope 9302-25	25						PQ095	20 415	17 335	14 325
PicoScope 9311-15	15	4	11.3	9.5	2.5 to 7	60	PQ096	14 285	12 135	10 025
PicoScope 9311-20	20						PQ091	18 985	16 915	13 315
PicoScope 9321-20	20						PQ092	29 495	26 275	20 685
PicoScope 9341-20	20						PQ093	22 395	19 955	15 705
PicoScope 9341-25	25					PQ097	26 235	22 275	18 405	

Calibration prices

	Order code	USD*	EUR*	GBP*
PicoScope 9301 models	CC033	779	659	549
PicoScope 9302 models	CC034	849	719	599
PicoScope 9311 models	CC035	1355	1145	949
PicoScope 9321-20	CC037	1235	1055	869
PicoScope 9341 models	CC038	1355	1145	949

* Prices correct at time of publication. Sales taxes not included. Please contact Pico Technology for the latest prices before ordering.

UK global headquarters:

Pico Technology
James House
Colmworth Business Park
St. Neots
Cambridgeshire
PE19 8YP
United Kingdom

☎ +44 (0) 1480 396 395
☎ +44 (0) 1480 396 296
✉ sales@picotech.com

North America regional office:

Pico Technology
320 N Glenwood Blvd
Tyler
Texas 75702
United States

☎ +1 800 591 2796
☎ +1 620 272 0981
✉ sales@picotech.com

Asia-Pacific regional office:

Pico Technology
Room 2252, 22/F, Centro
568 Hengfeng Road
Zhabei District
Shanghai 200070
PR China

☎ +86 21 2226-5152
✉ pico.china@picotech.com

* Prices correct at the time of publication. Sales tax not included. Please check www.picotech.com for the latest prices before ordering. Errors and omissions excepted.

Pico Technology, PicoScope, PicoSample and PicoSource are internationally registered trademarks or trademarks of Pico Technology Ltd. *LabVIEW* is a trademark of National Instruments Corporation. *MATLAB* is a registered trademark of The MathWorks, Inc. *Windows, Excel* and *Visual Basic* are registered trademarks of Microsoft Corporation in the United States and other countries.

MM046.en-15. Copyright © 2008–2019 Pico Technology Ltd. All rights reserved.

www.picotech.com



Pico Technology



@LifeAtPico



@picotechnologyltd



Pico Technology



@picotech