



G5110A



15MHz Function/Arbitrary Generator

User's Manual

Table of Contents

TABLE OF CONTENTS	2
1 GENERAL INFORMATION	5
1.1 FEATURE OVERVIEW.....	5
1.2 WARRANTY INFORMATION	6
1.3 PRECAUTION OF OPERATION	7
1.4 UPKEEP OF G5110A.....	8
1.5 SAFETY INFORMATION.....	8
1.6 SYMBOLS AND TERMS	9
1.7 INSPECTION	10
1.8 OPTIONS AND ACCESSORIES.....	10
2 OVERVIEW	12
2.1 TO ADJUST THE HANDLE	12
2.2 FACTORY DEFAULT SETTINGS	15
2.3 G5110A OPERATION PANELS	17
2.3.1 <i>Front Panel</i>	17
2.3.2 <i>Rear Panel</i>	18
3 COMMON OPERATIONS	20
3.1 TEXT MODE LCD.....	20
3.2 TO SELECT OUTPUT FUNCTION	21
3.3 TO SET OUTPUT FREQUENCY.....	22
3.4 TO SET OUTPUT AMPLITUDE	23
3.5 TO SET DC OFFSET VOLTAGE.....	25
3.6 TO SET HIGH-LEVEL AND LOW-LEVEL BOUNDS	26
3.7 TO SET WAVEFORM POLARITY	26
3.8 TO SET OUTPUT TERMINATION	27
3.9 TO ENABLE/DISABLE VOLTAGE AUTORANGING.....	28
3.10 TO CONTROL OUTPUT CONNECTOR.....	29
3.11 TO ENABLED/DISABLE SYNC OUT SIGNAL.....	30
3.12 TO RESTORE THE FACTORY DEFAULT SETTINGS.....	32
4 WAVEFORM OUTPUT OPERATIONS	32
4.1 SINE WAVE	33
4.2 SQUARE WAVE.....	33

4.3 RAMP WAVE	34
4.4 PULSE WAVEFORM.....	35
4.5 ARBITRARY WAVEFORM	37
4.5.1 <i>The Application Notes of the Sequencing Mode</i>	40
4.6 AMPLITUDE MODULATION	46
4.7 FREQUENCY MODULATION	48
4.8 PHASE MODULATION	51
4.9 FSK MODULATION	53
4.10 PWM WAVEFORM	54
4.11 FREQUENCY SWEEP.....	56
4.12 BURST OPERATION	59
5 SYSTEM OPERATIONS.....	64
5.1 TRIGGERING.....	64
5.2 STORING THE INSTRUMENT STATE	65
5.3 DISPLAY CONTROL	67
5.4 BEEPER	68
5.5 SOUND.....	69
5.6 ERROR DISPLAY	69
5.7 CALIBRATION	70
5.8 SCREEN SAVER	70
6 REMOTE INTERFACE OPERATIONS.....	71
6.1 REMOTE INTERFACE CONFIGURATION	71
6.1.1 <i>USB Interface</i>	71
6.1.2 <i>GPIB Interface</i>	71
6.1.3 <i>RS-232 Interface</i>	72
6.2 REMOTE INTERFACE COMMANDS.....	73
7 ERROR MESSAGES	82
7.1 COMMAND ERRORS	83
7.2 EXECUTION ERRORS.....	85
7.3 DEVICE DEPENDENT ERRORS	93
7.4 QUERY ERRORS	94
7.5 INSTRUMENT ERRORS	95
7.6 SELF-TEST ERRORS	95
7.7 CALIBRATION ERRORS	96
7.8 ARBITRARY WAVEFORM ERRORS.....	97

APPENDIX.....	99
A SPECIFICATION LIST	100
B REMOTE INTERFACE REFERENCE.....	105
<i>B.1 An Introduction to the SCPI Language</i>	<i>105</i>
B.1.1 Command Format Used in This Manual.....	105
B.1.2 Command Separators	106
B.1.3 Using the <i>MIN</i> and <i>MAX</i> Parameters	107
B.1.4 Querying Parameter Settings.....	107
B.1.5 SCPI Command Terminators	108
B.1.6 IEEE-488.2 Common Commands	108
B.1.7 SCPI Parameter Types.....	108
B.1.8 The SCPI Status System.....	110
B.1.8.1 The Status Byte Register.....	111
B.1.8.2 Using SRQ (Service Request) and Serial Poll	113
B.1.8.3 To read the Status Byte Using *STB?	113
B.1.8.4 Using MAV (The Message Available) Bit	114
B.1.8.5 To Interrupt Your PC Using SRQ.....	114
B.1.8.6 To Determine as a Command Sequence is finished.....	114
B.1.8.7 The Questionable Data Register	115
B.1.8.8 Bit Definitions – Questionable Data Register.....	115
<i>B.2 Output Data Formats</i>	<i>116</i>
<i>B.3 Command Reference</i>	<i>116</i>
<i>B.4 SCPI Compliance Information</i>	<i>154</i>
<i>B.5 IEEE-488 Compliance Information</i>	<i>155</i>
C. GENERAL SPECIFICATIONS	157
D. APPLICATION PROGRAMS.....	159

1 General Information

This chapter contains general information about the PICOTEST G5110A Waveform Generator. The information includes:

- Feature Overview
- Warranty Information
- Operational Precautions
- G5110A Maintenance
- Safety Information
- Symbols and Terms
- Inspection
- Options and Accessories

You can contact Picotest Corp. via the following telephone number for warranty, service, or technical support information.

Telephone: (886) 7-815-7183

Website <http://www.picotest.com.tw>

Or contact Picotest for more help by email.

Email: sales@picotest.com.tw or info@picotest.com.tw

1.1 Feature Overview

G5110A offers:

- 15 MHz sine and 15 MHz square waveforms.
- 14-bits, 50 MSa/s, 8 k-point arbitrary waveforms.
- Pulse, ramp, noise, and dc waveforms.
- AM, FM, PM, FSK, and PWM modulation types.
- Linear and logarithmic sweeps and burst operation.
- External timebase (10MHz +/- 500Hz) synchronization (Optional).
- Connection via USB (Standard) and GPIB/RS-232 (Optional).

- Text Model LCD for visual verification of signal settings.
- Store up to 8 waveforms x 8 K points in a nonvolatile memory.
- Easy-to-use shortcut keys and knobs.
- Free and easy-to-use PC applications.

※ **Note:** Full G5110A specifications are included in Appendix A.

1.2 Warranty Information

If the equipment is used in a manner not specified by the manufacturer, the protection provided by the equipment may be impaired and your warranty may be voided.

1. **Warranty:** PICOTEST CORP. guarantees that this product meets its published specifications. Under correct installation it should work as expected.
2. **Warranty Period:** This equipment is warranted against defects in material and manufacturing for a period of one year from the date of shipment. During the warranty period, PICOTEST is responsible for the necessary repairs, as long as the product can be proved to be defective.

For warranty service or repair, this product must be returned to a service facility designated by PICOTEST. Please contact your local service representative for further assistance.

3. **Excluded Items:** This warranty does not include parts subject to general wear and tear and degradation such as fuses, USB cord, buttons and relays. Neither does this warranty cover defects caused by improper installation, improper or insufficient maintenance, unauthorized modification, improper operation, ignorance of environmental specifications, or improper software or interfacing.
4. **Remarks:**
 - No other warranty is expressed or implied, except for that mentioned above.
 - The remedies provided herein are the buyer's sole and exclusive remedies. PICOTEST shall not be liable for any direct, indirect, special, incidental or consequential damages.

Limitation of warranty

- 1.** Our warranties do not cover any damage resulting from unauthorized modification or misuse.
- 2.** Unless mentioned elsewhere in this document, our warranty does not apply to fuses and problems arising from normal wear or user's failure to follow instructions.
- 3.** Our warranties do not apply to any direct, incidental, special, or consequential damages.
- 4.** The above warranties are exclusive, and no other warranty is expressed or implied. PICOTEST disclaims any implied warranties of MERCHANTABILITY, SATISFACTORY QUALITY, and FITNESS for any particular reasons.

1.3 Precaution of Operation

- Please carefully read the manual before operating this device.
- This manual is for reference only. Please consult your local service representative for further assistance.
- The contents of this manual may be amended by the manufacturer without notice.
- The equipment may never be dismantled by an unauthorized person, or the equipment may be damaged.
- The equipment has been strictly tested for quality before delivery from our factory. However, this equipment must not be used in dangerous situations where damage may result.
- This product should be placed in a safe area in case of unauthorized use.
- The rear protective conduct terminal needs to be connected to actual earth ground or electrical shock may occur.
- The patent and the copyrights of the related documents for the equipment belong to PICOTEST CORP., any reproduction is illegal.

1.4 Upkeep of G5110A

- Although the G5110A waveform generator is very durable and weather resistant, care should be taken not to expose it to severe impact or pressure.
- Keep the G5110A unit far from water and a damp environment.
- Calibration should be performed every year. Please contact your local service representative for more information.
- If an incorrect display, or abnormal beeps occur, you should stop using the equipment immediately.
- Do not use the waveform generator around explosive gas or flammable vapors.
- To clean the surface of the waveform generator, wipe it with a piece of clean, dry cloth.
- The maximum allowable weight loading on G5110A's aluminum case is 20Kgs. Any further weight on the case is likely to cause the equipment to malfunction.

1.5 Safety Information



Caution! Please read through the following safety information before using the product.

To avoid possible electrical shock, or personal injury, please read and follow these guidelines carefully:

- Follow the guidelines in this manual and DO NOT use the waveform generator if the case is damaged. Check the case and terminals, and make sure all interconnecting devices are in their proper positions.
- The waveform generator should be connected to the actual earth ground to avoid electrical shock.
- Do not apply excessive voltage to the waveform generator. Apply voltages only within their rated range.
- If you need to open the instrument case or replace any parts, follow the instructions in this manual. You must be a qualified technician to perform this action.

- The AC socket contains either a 250V/T630mAL or T630mAH rated fuse. When replacing the fuse, use only the same types and same rating as specified.
- Do not put your equipment into improper places. It will cause your equipment operate abnormally.
- Do not try to operate the waveform generator if it is damaged. Disconnect the power from the equipment and consult the local service representative. Return the product to Picotest's service department if necessary.
- Make sure the power cord corresponds to the requirements of your local power. When replacing it, its specification must be the same as the previous one. An incorrect power cord will cause unpredictable harm or damage. There are some rules you should follow below.
 - A. Use a proper power cord. Use the one that is shipped with your product and make sure that the power cord is certificated by your country.
 - B. Ground the product. The G5110A is grounded through the grounding conductor of the power cord. To avoid electric shock, only use an approved power cord with the product, and verify that it's properly connected to earth ground.
 - C. Position the G5110A appropriately. Do not position the equipment such that it's difficult to reach the unit.
 - D. Use an adequately-rated power cord only. Before replacing your old power cord with a new power cord, check to see if the new cord is adequately rated.

1.6 Symbols and Terms



This symbol indicates hazards that may cause damage to the instrument or even result in personal injury.





This symbol indicates high voltage may be present. Use extra caution before taking any action.

 This symbol indicates the frame or chassis terminal presented need to be connected to the actual earth ground.

 This symbol indicates "Protective Conductor Terminal".

 Underwriters Laboratories[®].

 This symbol indicates earth (ground) terminal.

 This symbol indicates this product complies with the essential requirements or the applicable European laws or directives with respect to safety, health, environment, and consumer protections.

1.7 Inspection

Your product package is supplied with the following items:

- One G5110A waveform generator unit. [107(H) x 230(W) x 290(D) mm, approx. 2.14Kg]
- One power cord.
- One USB cable.
- One CD (including this User's Manual and software applications).
- Optional accessories as ordered.
- GPIB/RS-232 interface card. (Optional)

1.8 Options and Accessories

The following options and accessories are available from Picotest for use with the G5110A. Please refer to **Table 1-1**.

Table 1-1 Accessory list.

Part Name	Part Number
External Time Base Card	G5110-opt01
GPIB Card	M3500-opt04
RS-232 Card	M3500-opt06

2 Overview

This chapter prepares you for using the G5110A waveform generator. You may want to check if you have all the parts with your waveform generator first. All Picotest products are handled and inspected professionally before shipping. If you find any damaged/missing parts, or have any doubts about the product, please contact your local service representative immediately and do not attempt to operate a damaged product.

2.1 To Adjust the Handle

You may adjust the carrying handle to suit your needs. The following figures show you how to do it.

I. Taking off the handle from the waveform generator

【Step 1】 (Turn up the handle)

Pull slightly outward on both sides of the handle and slowly rotate it up vertically to 90° as shown in **Figure 2-1**.

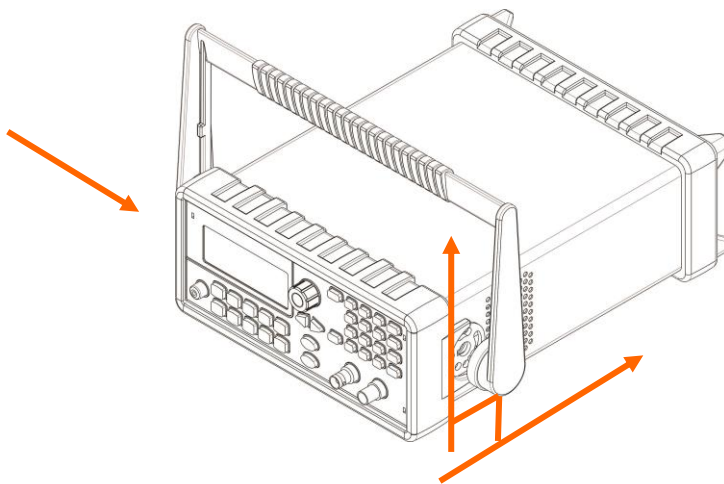

Figure 2-1

【Step 2】 (Pull out the handle)

When the handle is turned up to 90°, pull out the handle from the waveform generator as shown in **Figure 2-2**.

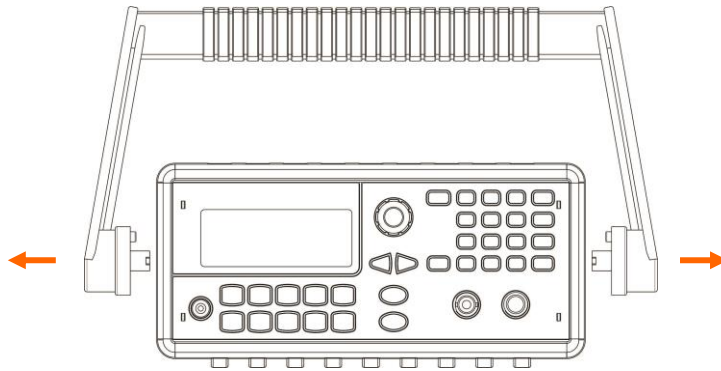

Figure 2-2

II. Adjusting the position for your convenience

Here are some example positions for different needs.

【Position 1】

The default position is for packing as shown in **Figure 2-3**.

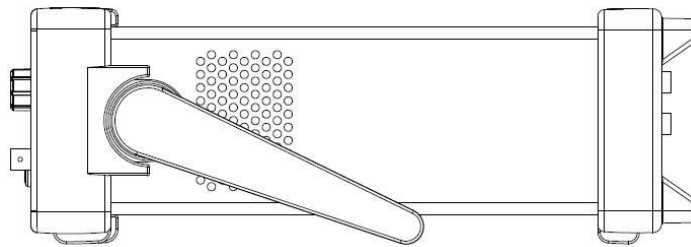

Figure 2-3

【Position 2】

The adjusted position is for operation as shown in **Figure 2-4**.

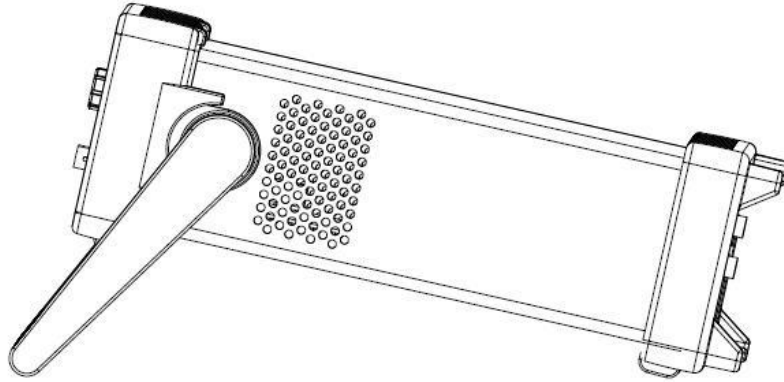

Figure 2-4

【Position 3】

The adjusted position is for carrying as shown in **Figure 2-5**.

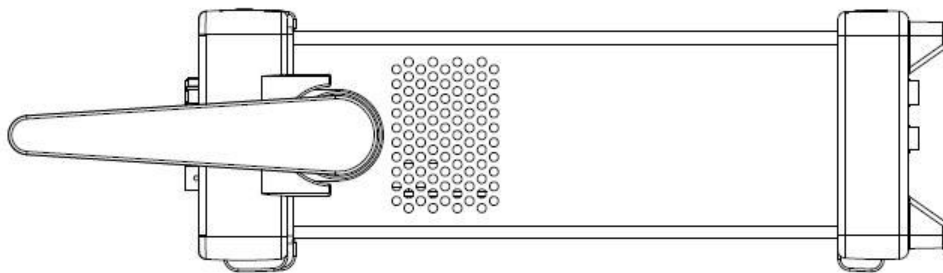

Figure 2-5

2.2 Factory Default Settings

Table 2-1 shows the factory default settings for the G5110A when it is powered-on for the first time.

Table 2-1 Factory default settings

Parameters marked with a star (*) are stored in a non-volatile memory.

<i>Output Configuration</i>	<i>Default Setting</i>
Function	Sine wave
Frequency	1 mHz
Amplitude/Offset	100 mVpp/0.000Vdc
Output Units	Vpp
Output Termination	50Ω
Autorange	On
<i>Modulation</i>	
Carrier	1 kHz Sine (AM, FM, PM, FSK)
	1 kHz Pulse (PWM)
Mod. Waveform(AM)	100 Hz Sine
Mod. Waveform(PM, FM, PWM)	10 Hz Sine
AM Depth	100%
FM Deviation	100 Hz
PM Deviation	180 degrees
FSK Hop Frequency	100 Hz
FSK Rate	10 Hz
PWM Width Deviation	10 μs
Modulation State	Off

<i>Output Configuration</i>	<i>Default Setting</i>
<i>Sweep</i>	
Start/Stop Frequency	100 Hz/1 kHz
Sweep Time	1 sec.
Sweep Mode	Linear
Sweep State	Off
<i>Burst</i>	
Burst Count	1 Cycle
Burst Period	10 ms
Burst Start Phase	0 degree
Burst State	Off
<i>System-Related Operations</i>	
Power-Down Recall	Disabled
Display Mode	ON
Error Queue	0 errors
Stored States, Stored Arbs	
Output State	Off
<i>Triggering Operations</i>	
Trigger Source	Internal (Immediate)
<i>Remote Interface Configuration</i>	
GPIB Address	10

2.3 G5110A Operation Panels

Brief descriptions are provided in this chapter for all the connectors and buttons on both front and rear panels of G5110A waveform generator.

2.3.1 Front Panel

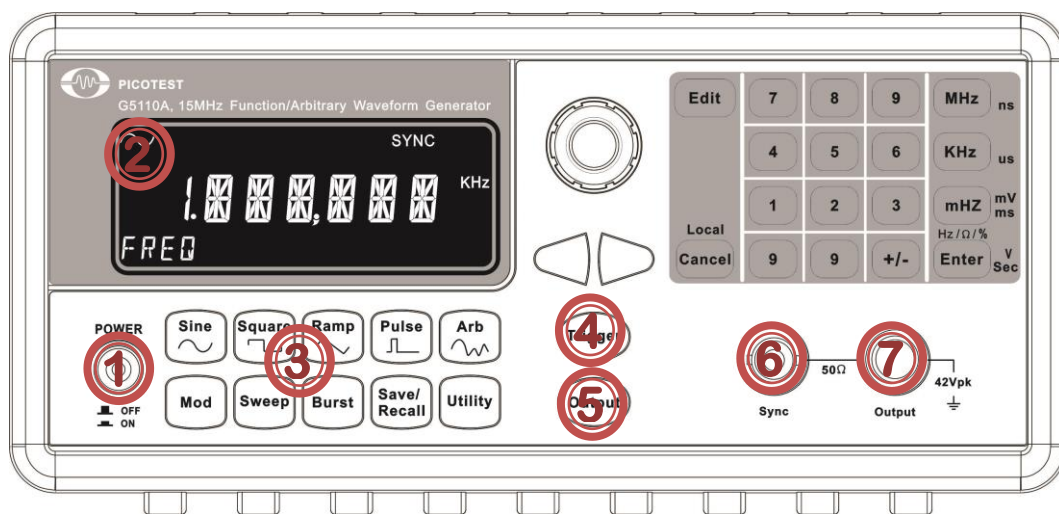

Figure 2-6

1. Power

Press the power button to activate/shutdown the G5110A.

2. Display

After activating the G5110A, the 7-digit LCD will appear.

3. Keys for Function Selection

- I. Waveform Selection: There are Sine, Square, Ramp, Pulse, and Arb (Arbitrary) waves for you to choose from.
- II. Modulation Selection: There are FM, AM, PM, PWM, FSK, Sweep, and Burst for you to choose from.
- III. Save/Recal Selection: There are four save locations. When there is data inside, they show "STATE X". When they are empty, they show "NONE".
- IV. Utility: There are DC, SYNC (Synchrony), OUTPUT, and SYSTEM options for you to choose from.

※ **Note:** There are some highlighted buttons among the Function selections.

- i. **Edit Button:** Enter the function you would like to setup.

- ii. Knob: Switch to a selection or number you want.
- iii. Direction Buttons (<>): Jump to a specific digit/selection.
- iii. ENTER Button: Confirm a setting you set.
- iv. Numerical Buttons: Enter a value.
- v. Cancel (Local) Button: Abandon a setting or selection. Or release control from the remote side to the front panel.
- vi. Unit Buttons: It contains the unit selections, such as MHz, KHz, mHz, Hz, Ω , %, ns, us, mV, ms, V, and Sec.

4. Trigger

When you press this trigger button, your G5110A will trigger a single signal to a receiver.

5. Output Button

When you press the output button, data/values are transmitted to a receiver.

6. Sync output Connector

This connector is used for simultaneously transmitting data/values to a receiver when the main signal output port is activated.

7. Main signal output Connector

This connector mainly transmits data/values to a receiver when OUTPUT button is pressed.

2.3.2 Rear Panel

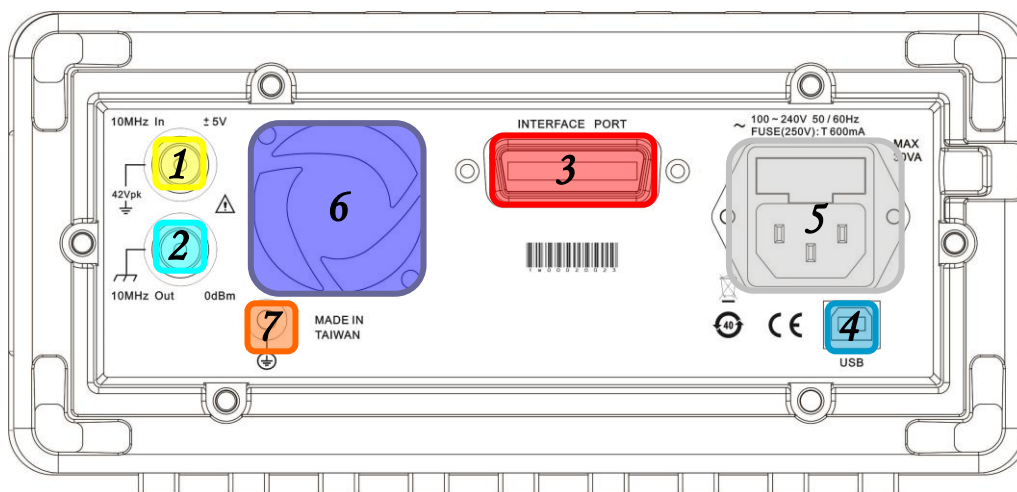

Figure 2-7

- 1. 10MHz In (External 10 MHz Reference Input) Connector**
- 2. 10MHz Out (Internal 10 MHz Reference Output) Connector**
- 3. GPIB Connector(Optional)**
- 4. USB Port**
- 5. Power cord Connector**
- 6. Vent**
- 7. Chassis Ground**

3 Common Operations

This chapter describes the basic operations and configurations that are commonly used to set up a waveform output. Operations for outputting specific waveforms are covered in chapter 4.

3.1 Text Mode LCD

The G5110A provides you a Text Mode LCD with seven digits in orange light. The default display is shown in Figure 3-1, as an example.

In the upper row, each figure stands for a main function that is being used. SYNC means the SYNC function is enabled.

In the middle row, it shows the desired value and units. The maximum frequency for a sine wave is 15MHz, for a square wave it is 15MHz, and for an arbitrary wave it is 3MHz. When a value exceeds the limit, the display shows the maximum value allowable.

In the lower row, it shows the advanced settings.



Figure 3-1
Default Display

3.2 To Select Output Function

The G5110A provides various output functionality:

- **Standard waveforms:** The G5110A provides five standard waveforms: Sine, Square, Ramp, Pulse, and DC. The default waveform output is sine wave.
- **Arbitrary waveforms:** There is an arbitrary waveform available. Or you can create your own custom waveform with the Wavepatt software which comes with the unit.
- **Modulation:** The waveform generator also provides modulation for sine, square, ramp and arbitrary waveforms using AM, FM, PM, or FSK. You can also use PWM to modulate a pulse waveform.
✘ **Note: The square function doesn't support AM modulation.**
- **Frequency sweeping:** Linear and logarithmic frequency sweeping modes are available for sine, square, ramp and arbitrary waveforms.
- **Burst operation:** The burst waveforms can be generated with any one of the standard or arbitrary waveforms (except dc).

Front-panel Operation

To select a desired output function, press the corresponding button and then set up the related parameters. Refer to Chapter 4 for setting up each individual waveform type.

Remote Interface Operation

FUNCTION {SINusoid|SQUare|RAMP|PULSe|DC|USER }

You may also use the APPLY command to select the function, frequency, amplitude, and offset in one action.

Notes

- **Frequency limitation:** When a newly-selected function has a smaller maximum frequency than the previous function, the waveform generator will automatically adjust the frequency from the old value to the new, smaller maximum value.
- **Amplitude limitation:** When the newly-selected function has a

smaller maximum amplitude, the waveform generator will automatically adjust the amplitude from the previous function's value to the new smaller maximum allowable value. This may occur when the output units are Vrms or dBm due to the differences in crest factor for the various output functions.

3.3 To Set Output Frequency

The initial frequency setting uses the factory default or a previously set value. The steps for setting a new frequency are listed below.



Figure 3-2
Frequency Settings

Front-panel Operation

1. Select your desired function by pressing one of the function keys.
2. Press the Edit button and make sure one of the Freq digits is highlighted with a cursor.
3. Use the numeric keypad or the knob with cursor keys to change the value.
4. Press the Enter button to confirm the settings.

Remote Interface Operation

FREQUency {<frequency>|MINimum|MAXimum}

Notes

- Each waveform function has its own frequency range, but the default frequency is 1 kHz for all functions. The table below lists the frequency ranges for different functions:

Function	Frequency Range
Sine	1 mHz ~ 15 MHz
Square	1 mHz ~ 15 MHz
Ramp	1 mHz ~ 200 KHz
Pulse	1 mHz ~ 5 MHz
Arbitrary	1 mHz ~ 3 MHz

- Frequency limitation: When you choose a new function and the current frequency setting is larger than the maximum frequency of the new function, the waveform generator will automatically adjust the frequency to the smaller maximum value.
- Burst limitation: For internally-triggered bursts, the minimum frequency is 2 mHz. For sine and square waveforms, frequencies above 3 MHz are allowed only with an "infinite" burst count.

3.4 To Set Output Amplitude

The default amplitude for all functions is 0.1Vpp (into 50 ohms). The procedure to set a new amplitude value is described as follows.



Figure 3-3
AMPL State

Front-panel Operation

1. Select your desired function by pressing one of the function keys.
2. Rotate the knob to AMPL.
3. Press the Edit button.
4. Use the numeric keypad or the knob with cursor keys to change the value.
5. Press the Enter button to confirm the settings.

Remote Interface Operation

VOLTage {<amplitude>|MINimum|MAXimum}

Use this command to set units:

VOLTage:UNIT {VPP}

Notes

- Specifying a high (voltage) level and a low level (Section 3.7) is equivalent to specifying amplitude and DC offset (Section 3.6). For example, if you set the high level to +2 volts and the low level to -3 volts, the resulting amplitude will be 5 Vpp, with an offset voltage at -0.5 V.



Figure 3-4
AMPL Settings

- The output unit is Vpp.
- Offset Voltage limitations: The value of output amplitude is constrained by the equation below:

$$V_{pp} \leq 2 \times (V_{max} - |V_{offset}|)$$

where V_{max} is the maximum peak voltage allowed for the selected output termination (5 volts for a 50 Ω load or 10 volts for a high-impedance load).

- Output Termination Limits: When the Output Termination Setting is changed, the Output Amplitude is automatically adjusted. For instance, when you change the output termination from 50 ohms to "high impedance", your offset voltage doubles. Therefore, it affects your output amplitude, and when Output Termination has been changed from "high impedance" to 50 ohms, the offset voltage decreases by half.
- Arbitrary Waveform Limitations: For arbitrary waveforms, if the data points do not span the full range of the output DAC

(Digital-to-Analog converter), the maximum amplitude will be limited. For example, the built-in Sinc wave does not span the full ± 1 range and, therefore, its maximum amplitude is limited to 6.087 Vpp (into 50 Ω).

- While changing amplitude, you may notice a momentary disruption in the output waveform at certain voltages due to switching of the output attenuators. The amplitude is controlled, however, so the output voltage will never exceed the current setting while switching ranges. You may disable the voltage autoranging to prevent this output disruption.

3.5 To Set DC Offset Voltage

The default DC offset voltage is 0 volt for all functions. To specify a non-zero DC offset value, follow the steps below.

Front-panel Operation

1. Select your desired function by pressing one of the function keys.
2. Press the Utility. (It shows the DC function.)
3. Press the Edit button.
4. Rotate the knob to ON, and press ENTER. (It shows DONE.)
5. Press the Edit button once again.
6. Use the numeric keypad, or the knob with cursor keys, to change the value.
7. Press the Enter button to confirm the settings.
8. Press the Utility again to return to the upper layer menu.

Remote Interface Operation

VOLTage :OFFSet {<offset>|MINimum|MAXimum}



Figure 3-5
DC State

- Limits with amplitude and output termination: DC offset value is constrained by the equation below:

$$|V_{\text{offset}}| \leq V_{\text{max}} - \frac{V_{\text{pp}}}{2}$$

where V_{max} is the maximum peak voltage allowed for the selected output termination (5 volts for a 50 Ω load or 10 volts for a high-impedance load).

If the specified dc offset is not valid, the waveform generator automatically adjusts it to the maximum value allowed with the specified amplitude.

- Arbitrary Waveforms Limitations: For arbitrary waveforms, if the waveform data points do not span the full range of output DAC (Digital-to-Analog Converter), the maximum offset and amplitude will be limited.
- For dc volts, the output level is actually controlled by setting the offset voltage. You can set the dc level to any value between ± 5 Vdc into 50 ohms or ± 10 Vdc into an open circuit.

3.6 To Set High-Level and Low-Level Bounds

For this function, the front panel operation is not available. To set high-level and low-level bounds, remote commands are provided. The results in Amp/Vos type are shown on the display.

Remote Interface Operation

VOLTage:HIGH {<voltage>|MINimum|MAXimum}

VOLTage:LOW {<voltage>|MINimum|MAXimum}

3.7 To Set Waveform Polarity

The default waveform polarity mode is Normal, in which case the waveform goes positive during the first part of the waveform cycle. It may be changed to the Inverted mode where the waveform goes negative during the first part of the waveform cycle. To set the waveform

polarity mode, follow the steps below.

Front-panel Operation

- Press Utility button.
- Rotate the knob to OUTPUT selection.
- Press the Enter button to access.
- Rotate the knob to INVERT selection.
- Press the Edit button to get into the setting.
- Rotate the knob to ON/OFF selection.
- Press the Enter button under ON/OFF to invert/normalize the waveform you are dealing with.
- Press the Utility again to return to the upper layer menu.

Remote Interface Operation

OUTPut: POLarity {NORMal|INVerted}

Notes

- When a non-zero offset is used, the waveform is inverted relative to the offset voltage, so the offset remains the same in the inverted waveform.
- When the waveform is inverted, the Sync signal associated with the waveform is not inverted.



Figure 3-6
Invert Settings

3.8 To Set Output Termination

A fixed series output impedance of 50 ohms to the front-panel *Output* connector is set by default. If the actual load impedance does not match the value specified, the output amplitude and offset levels will be incorrect. To change this setting, follow the steps below.

Front-panel Operation

1. Press the Utility button.
2. Rotate the knob to OUTPUT selection.
3. Press the Enter button to access.
4. Rotate the knob to HIGH Z selection.
5. Press the Edit button to get into the setting.
6. Rotate the knob to ON selection.
7. Press the Enter button to use the 50 ohms impedance.
8. Press the Utility again to return to the upper layer menu.



Figure 3-7
High-Z Settings

Remote Interface Operation

Use this command for output termination setting:

```
OUTPut:LOAD {<ohms>|INFinity|MINimum|MAXimum}
```

Notes

- The range for Output Termination is from 1 ohm to 10k ohms, or Infinite. The default is 50 ohms.
- The output termination setting is stored in a non-volatile memory and it stays after power-off or a remote interface reset.

3.9 To Enable/Disable Voltage Autoranging

The waveform generator by default turns on autoranging at power-on and finds the optimal settings for the output amplifier and attenuators. If autoranging is turned off, the G5110A uses the current amplifier and attenuator settings. To enable/disable voltage autoranging, follow the steps below.

Front-panel Operation

1. Press the Utility button.
2. Rotate the knob to OUTPUT selection.
3. Press the Enter button to access.
4. Rotate the knob to RANGE selection.
5. Press the Edit button to get into the setting.
6. Rotate the knob to AUTO/HOLD selection.
7. Press Enter under AUTO/HOLD to enable/disable the autorange.
8. Press the Utility again to return to the upper layer menu.



Figure 3-8
Range Settings

Remote Interface Operation

VOLTage:RANGe:AUTO {OFF|ON|ONCE}

Notes

- While changing the amplitude, you may notice a momentary disruption in the output waveform at certain voltages due to switching of the output attenuators. You may disable the voltage autoranging to prevent this output disruption.
- With auto-ranging off, the resolution and accuracy of amplitude and offset may be affected when reducing the amplitude below the expected range change. You may not be able to achieve the minimum amplitude that is available when autoranging is on.

3.10 To Control Output Connector

The G5110A output is controlled by the Output button. The output is disabled at power on by default to protect the equipment connected to G5110A.

Front-panel Operation

- To enable/disable output, press the Output button to toggle. The Output button becomes lit when output is enabled.

Remote Interface Operation

OUTPut {OFF|ON}

Notes

- The Output is automatically disabled when an excessive external voltage is applied to the Output connector on the front panel. An error will be generated and the error message will be shown. Remove the overload from the Output connector and enable the Output again.

3.11 To Enabled/Disable Sync Out Signal

All the standard output functions, except dc, can be associated with a sync-out signal. It is outputted at the Sync connector on the front panel.

Front-panel Operation

1. Press the Utility button.
2. Rotate the knob to SYNC selection.
3. Press the Edit button to access.
4. Rotate the knob to ON/OFF/AUTO selection.
5. Press ON/OFF to enable/disable the function, or AUTO to detect automatically.
6. Press the Utility again to return to the upper layer menu.



Figure 3-9
SYNC Settings

Remote Interface Operation

OUTPut:SYNC {OFF|ON}

Notes

- If the Sync connector is disabled, the output signal is at a logic "low" level.
- The Sync setting is stored in a non-volatile memory, so it does not change after power-off or a remote reset command is issued.
- For Sine, ramp and pulse waveforms, the Sync signal is a TTL "high" when the waveform output is positive, relative to zero volts (discard the dc offset setting). The Sync signal is a TTL "low" when the waveform output is negative, relative to zero volts (discard the dc offset setting).
- For arbitrary waveforms, the Sync signal is a TTL "high" when the first waveform point is output.
- For internal-modulated AM, FM, PM, and PWM, the Sync signal is aligned with the modulating waveform. The Sync signal is a TTL "high" during the first half of the modulating waveform.
- For FSK, the Sync signal is aligned with shifts in frequency. The Sync signal is a TTL "high" during the output of the "hop" frequency and "low" during that of the "carrier" frequency.
- For frequency sweeps with Marker Off, the Sync signal is a TTL "high" in the first half of the sweep and "low" in the second half. The frequency of the sync signal is equal to the reciprocal of the sweep time. If the Marker is enabled, the Sync signal setting will be ignored and the Sync signal is a TTL "high" at the beginning of the sweep and transitions to "low" at the marker frequency.
- For a triggered burst, the Sync signal becomes a TTL "high" when the burst is triggered. The Sync signal transitions to a TTL "low" at the end of the specified number of cycles (may not be the zero-crossing point if the waveform has a non-zero phase). If the burst count is infinite, the Sync signal works the same way described above for continuous waveforms.
- When the output waveform polarity is inverted, the associated sync out signal is not affected.

3.12 To Restore the Factory Default Settings

To reset the waveform generator to its factory default settings, press the "Save/Recall" button and then rotate the knob to DEFAULT. Press Enter to confirm. When it's finished, the display will show DONE and disappear. The waveform generator has been restored to factory default settings.



Figure 3-10
Default Settings

For the G5110A factory default settings, please refer to Table 2.2. To create your own default after power-on, please refer to Section 5.2 Storing the instrument state.

4 Waveform Output Operations

This chapter describes each of the waveforms that the G5110A generates. It also discusses the detailed front-panel, menu and remote interface operations used for generating waveforms.

4.1 Sine Wave

How to generate a sine wave

1. The default waveform output of the G5110A is a sine wave. To select a sine wave, press the Sine button on the front panel. (The left-upper corner of the display shows )
2. Press the Edit button, then the numeric buttons plus a unit to define a desired value. If necessary, press Edit again. Use/rotate the <>/knob to adjust it slightly.
3. Press the Enter button to confirm.
4. Press the Output button to generate the sine wave



Figure 4-1
Generate a Sine Wave

Remote interface operation

APPLY:SINusoid [<frequency>[,<amplitude>[,<offset>]]]

or

FUNCTION {SINusoid}

FREQuency {<frequency> | MINimum | MAXimum}

VOLTage {<amplitude> | MINimum | MAXimum }

VOLTage:OFFSet {<offset> | MINimum | MAXimum }

4.2 Square Wave

A square wave consists of instantaneous transitions between two voltage levels.

How to generate a square wave

1. To select a square wave, press the Square button on the front panel to. (The left-upper corner of the display shows )
2. Press the Edit button, then the numeric buttons plus a unit to define a desired value. If necessary, press Edit again. Use/rotate

- the <>/knob to adjust it slightly.
3. Press the Enter button to confirm.
 4. Press the Output button to generate the square wave you set.



Figure 4-2
Generate a Square Wave

Remote interface operation

APPLY:SQUare [<frequency>[,<amplitude>[,<offset>]]]

or

FUNCTION {SQUare}

FREQUency {<frequency> | MINimum | MAXimum}

VOLTage {<amplitude> | MINimum | MAXimum }

VOLTage:OFFSet {<offset> | MINimum | MAXimum }

Notes

- The default value will be restored after power off or a remote interface reset as the setting is stored in the non-volatile memory.
- When you change the output function from a square wave to another waveform type, the previously-set parameters are remembered and will be applicable when the square wave is re-selected.

4.3 Ramp Wave

A ramp wave is a triangle waveform with adjustable symmetry. Symmetry represents the percentage of time in a cycle when the ramp wave is rising (assuming that the waveform polarity is not inverted). The default symmetry is 95%.

How to generate a ramp wave

1. Press the Ramp button on the front panel to make the selection. (The left-upper corner of the display shows  .)
2. Refer to Chapter 3 for configuring common parameters, including

- frequency, amplitude, offset voltage, and symmetry.
- Use the knob with the cursor keys to change the symmetry setting. Or use the numeric keypad to enter a new value and then press Enter to confirm or Cancel to withdraw the changes.
 - Press the Output button to generate the ramp wave.



Figure 4-3
Generate a Ramp Wave

Remote interface operation

APPLY:RAMP [<frequency>[,<amplitude>[,<offset>]]]

(The command generates ramp wave with 95% symmetry)

Or

FUNCTION {RAMP}

FREQUENCY {<frequency> | MINimum | MAXimum}

VOLTage {<amplitude> | MINimum | MAXimum }

VOLTage:OFFSet {<offset> | MINimum | MAXimum }

FUNCTION:RAMP:SYMMetry {<percent>|MINimum|MAXimum}

Notes

- Symmetry value is stored in the non-volatile memory so the default setting (95%) will be restored after power-off or a remote interface reset.
- When you change the output function from a ramp wave to another waveform, the previously-set symmetry is remembered and will resume when the ramp wave is re-selected.
- The symmetry setting does not apply to the case where a ramp wave is used as the modulating wave for AM, FM, PM, or PWM.

4.4 Pulse Waveform

A pulse waveform consists of a period and a pulse width. The parameters

are described further below.

Pulse Period / Frequency

The default pulse period is 1 ms (or 1kHz in frequency), and the allowable value is ranged from 200 ns to 1000s (or 5 MHz down to 1 mHz in frequency). The pulse period constrains the other parameters with the following equation:

$$\text{PulsePeriod} \geq \text{PulseWidth} + 40\text{ns}$$

The waveform generator adjusts the other parameters when needed to accommodate the given pulse period.

Pulse Width

The pulse width represents the time from the 50% point of the ascending edge to the 50% point of the following descending edge. The default pulse width is 100 μs , and the possible value ranges from 40 ns to 1000s. The actual allowable range is determined as follows:

$$40\text{ns} \leq \text{PulseWidth} \leq \text{PulsePeriod} - 40\text{ns}$$

$$W_{\text{min}} \leq \text{PulseWidth} \leq \text{PulsePeriod} - W_{\text{min}}$$

where W_{min} is the minimum allowable value determined by the following conditions on PulsePeriod:

$W_{\text{min}} =$	$40 \text{ ns, if PulsePeriod} \leq 10\text{s}$
	$200 \text{ ns, if } 10\text{s} < \text{PulsePeriod} \leq 100\text{s}$
	$2 \text{ us, if } 100 < \text{PulsePeriod} \leq 1000\text{s}$

If the specified value for PulseWidth is outside of the allowable range, the waveform generator will automatically adjust it to accommodate the given pulse period.

How to generate a pulse wave

1. Press the Pulse button. (The upper row of the display



shows .)

2. Refer to Chapter 3 for specifying the common parameters, including frequency, amplitude and dc offset voltage.
3. Rotate the knob to the Width function.
4. Press the Edit button with the knob and the cursor keys to change the value. Or use the numeric keypad to enter a new value and then the unit button to finish the entry or Cancel to withdraw the changes.
5. Press the Output button to generate the pulse wave.



Figure 4-4
Generate a Pulse Wave

Remote interface operation

APPLY:PULSE [<frequency>[,<amplitude>[,<offset>]]]

Or use the following commands for setting parameters of your pulse waveform:

FUNCTION {PULSE}

FREQUENCY {<frequency> | MINimum | MAXimum }

VOLTage {<amplitude> | MINimum | MAXimum }

VOLTage:OFFSet {<offset> | MINimum | MAXimum }

PULSE:PERiod {<seconds> | MINimum | MAXimum }

FUNCTION:PULSE:WIDTH {<seconds> | MINimum | MAXimum }

4.5 Arbitrary Waveform

The G5110A waveform generator provides five built-in arbitrary waveforms and up to four user-defined arbitrary waveforms that are stored in a non-volatile memory. The built-in waveforms are exponential-rise, exponential-fall, negative-ramp, sinc, and cardiac. The default arbitrary waveform is an exponential-rise wave.

Each user-defined waveform may contain up to 8192 (8k) points. The waveform is defined by the remote interface. If you choose an arbitrary waveform as the modulating waveform for AM, FM, PM, or PWM, the waveform is automatically limited to 1000 points. Any extra points will be removed by decimation. On the other hand, user-defined waveforms can be also made through the Sequencing Mode in the Wavepatt software.

Under the sequencing mode, you can generate a kind of mixed waveform. However, it must be used under this arbitrary waveform function with Wavepatt. For more detailed instructions, please refer to the following settings. You can also refer to the next section, "The Application Notes of the Sequencing Mode."

.....
How to set "seq arb" (Sequencing Arbitrary Waveform) via Wavepatt. The brief instructions and notes are below.

1. Set individual waveform.
2. Leave basic settings on the individual waveform (including freq, counts, and so on).
3. Click to execute the application.

For example, you can set a sin wave with the settings (freq=10 kHz in 1000 times) and a ramp wave with the settings (freq=1 kHz in 200 times). In addition, please note:

1. Trig Mode: There is a selection you should choose, such as Internal/Manual/External (for G5100A only). For this selection, it relates to the seq arb which can run cyclically or just once.
2. When executing the sequencing mode, the mod, sweep, and burst are disabled.
3. The built-in arbitrary waveforms do not support sequencing. This feature only exists when using self-defined waveforms .
4. The followings are the relevant SCPI commands for sequencing control.

a. DATA:SEQuence VOLATILE,#[LENGTH] [DATA]

This command is used for transmitting data via Wavepatt.

b. DATA:SEQuence:STATe ON/OFF

This command is used for enabling or disabling the sequencing mode.

c. DATA:SEquence:STATE?

This command is used for showing the state of the sequencing mode.

5. The sequencing mode on the front panel is located at the path Utility > Seqarb.

.....

User-defined waveforms

The G5110A supports user-defined waveforms. You may use the **Wavepatt** waveform and pattern editor to create the waveforms you want or import waveforms from an oscilloscope that you may have previously captured. For more information on the user-defined waveforms, please refer to **Wavepatt's online help**.

Volatile waveforms (Simulated)

The G5110A provides a simulated waveform which is stored in the volatile memory. You can use the following commands DATA:DAC VOLATILE, {<binary block>|<value>, <value>, ...} and DATA VOLATILE, <value>, <value>, ... , to write data into the memory. The volatile waveform is made according to the simulation of the Serial Flash Memory. So its transmitting rate is slower than the one from a traditional RAM. Furthermore, the way of simulation is that when turning on the unit each time, make it invalid.

How to output a built-in arbitrary waveform

1. Press the Arb button. (The upper row of the display shows )
2. Refer to Chapter 3 for configuring frequency, amplitude and dc offset voltage.
3. Rotate the knob, and choose Built In or USER.
4. Press the Enter to confirm (It shows DONE), or Cancel to withdraw the changes.
5. Rotate the knob again to next selection. Press the Edit button to choose the desired waveform from the five built-ins, such as EXP_RISE, EXP_FALL, NEG_RAMP, SINC, or CARDIAC.
6. Press the Output button to generate the arbitrary wave



Figure 4-5

Generate an Arbitrary Wave

Remote interface operation

FUNCTION USER {EXP_RISE | EXP_FALL | NEG_RAMP | SINC | CARDIAC}

Remote interface operation

DATA:DAC VOLATILE, {<binary block>|<value>, <value>, ...}

DATA VOLATILE, <value>, <value>, ...

FORMat:BORDER {NORMal | SWAPped}

DATA:COPIY <destination arb name> [,VOLATILE]

DATA:CATalog?

DATA:NVOLatile:CATalog?

DATA:NVOLatile:FREE?

DATA:ATTRibute:AVERAge? [<arb name>]

DATA:ATTRibute:CFACTOR? [<arb name>]

DATA:ATTRibute:POINTs? [<arb name>]

DATA:ATTRibute:PTPeak? [<arb name>]

4.5.1 The Application Notes of the Sequencing Mode

The principle of DDS suggests that by sampling an original waveform at a high sampling rate, and then filtering out the sampling noise with high frequency, the original waveform can be greatly refined.

For example, a sine waves is sampled using 100 points at a 50MHz sampling rate, in 20ns. The result will be...

A. (Ordinary Solution under The Arbitrary Mode)

1. If 10 points are sampled in one cycle, the frequency of the output sine wave is 5MHz, i.e. the equation: $1/(20\text{ns} \cdot 10)$.
2. If 5 points are sampled in one cycle, the frequency of the output sine

wave is 10MHz, i.e. the equation: $1/(20\text{ns} \cdot 5)$.

Therefore, different sampling rates produce different output frequencies for the output waveform which has the same number of points. In conclusion, if the interval time of the sampling rate is getting longer, the points and the frequency will get less and higher respectively, but the distortion is getting greater than before. The ordinary complex waveforms under the arbitrary mode will be generated like the following Case1 and Case 2.

Case 1: Waveforms consisting of components in 90% low and 10% high frequencies.

Case 2: Waveforms consisting of components in 10% low and 90% high frequencies.

In other words, in the traditional applications if building a waveform under an ordinary Arb function, the result might be that ...

Case 1: The low frequency components in 90% length and the high frequency components in 10% are built.

Case 2: The low frequency components in 10% length and the high frequency components in 90%, which have been repeated 9 times, are built.

The disadvantages of the tradition for the usage of memory and output frequency are that ...

For the usage of memory:

Case 1: Using 90% memory for the low frequency components and 10% for the high, the waveform resolution generated from the original high frequency is imperfect.

Case 2: Using 90% memory for the repeated high frequency components, the waveform resolution generated from the original high frequency is imperfect.

For the output frequency:

*Since the arb function uses the same sampling interval for showing complete waveforms of high frequency components, for example, "a complete cycle of high frequency waveforms needs 5 points", the complete waveform will need 50 points to present. To be more precisely, the detailed equation is that $(5/10\% = 50, 5*9/90\% = 50)$. In addition, you also have to set the output frequency as 1MHz $[1/(20ns*50)]$ to completely resolve the high frequency components, 10MHz.*

B. (Improved Solution under The Sequencing Mode)

Therefore, the SequencingArb function is the perfect solution to deal with this kind of waveform since it can divide a waveform into several segments, outputting different segments in different sampling intervals, and provide higher resolution and frequency. It can even be used to build complex waveforms in a great scale.

The advantages of the SequencingArb function for the usage of memory and output frequency are that ...

For the usage of memory:

Case 1: The segments are allocated to memorize low frequency components in 10% and high frequency components in 90%. The original waveform resolution in high frequency will be raised 9 times.

Case 2: Memorizing high frequency components at a time using 90% memory, the original waveform resolution in high frequency will be raised 9 times.

The reason is that because the original waveform resolution is raised, under the same distortion, the SequencingArb function can output frequency 9 times.

For the output frequency:

Since the arb function will divide a waveform into several segments, and output different segments in different sampling intervals, each segment can be individually set only. You can read and make it easily without a complicated calculation.

In the above negative/positive aspects, the waveforms made by the

traditional arbitrary mode and the sequencing mode are different. Using arbitrary mode limits your waveform status. Using sequencing mode gives your waveform more variations and flexibilities when dealing with complex waveforms in need. In the following two examples, through the illustration, you might deeply understand why the advantages of the sequencing mode are mentioned several times in this section.

In the Figure-1, say that there is the typical arbitrary waveform (AW) with 8192 points. The high frequency part, 90-cycle sinewaves, occupies 90% (eq. 7372 points) of the AW, and each cycle has 82 points only. Therefore, the insufficient points cause the distortion on high frequency presentation when working with an oscilloscope.

By the sequencing mode, since each wave segment can be set separately, you don't need the same point proportion to create waveforms. Here is the sinewave created with 4096 points, and its repeat time is set as 90. Comparing with any traditional AW, the resolution can be improved 50 times. Due to the sufficient points, the sinewave in 1 MHz can be output perfectly without distortion.

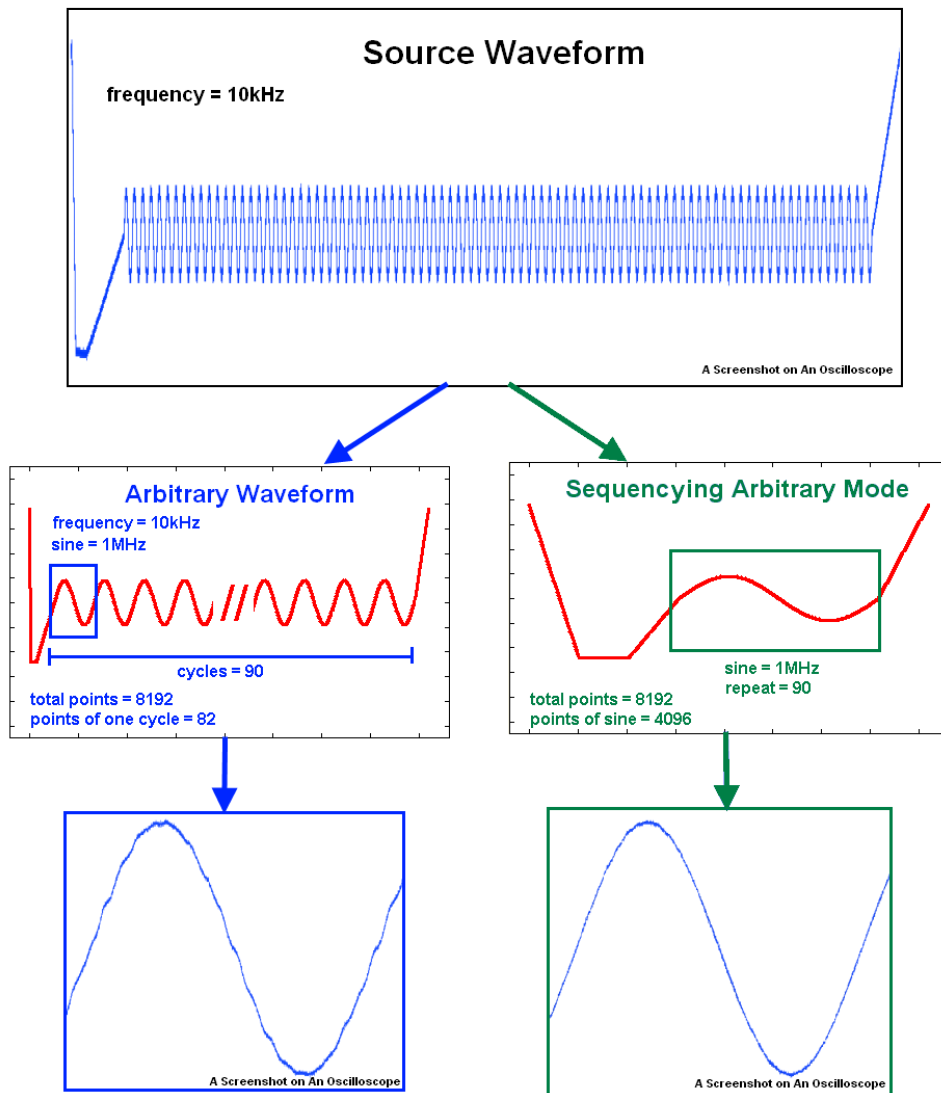

Figure-1

In the Figure-2, say that the length and frequency of the AW are 1000 points and 10 kHz. Since a typical AW uses a single sampling frequency, and can't be separated, to define the frequency of a specific sinewave, you have to calculate and adjust the point proportion in an AW. It's annoying and wastes time.

By the sequencing mode, you don't need the same point proportion to create waveforms. Here is the sinewave created with 512 points. You can just set its output frequency as 100 kHz under the same limited 1000 points. After that, the waveforms without distortion can be generated. And you don't have to calculate and adjust the point proportion. It

improves the convenience greatly when generating complex waveforms in need.

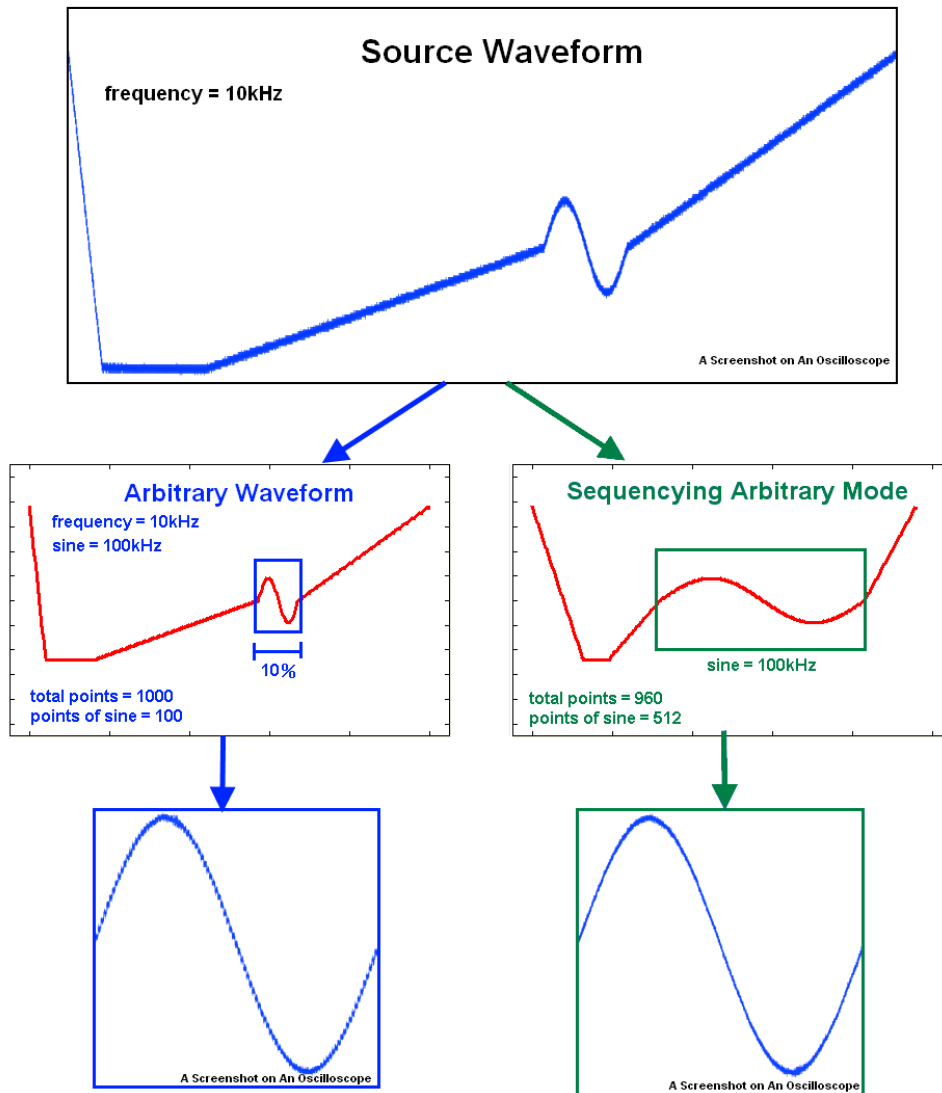

Figure-2

In conclusion, after using the Sequencing Arbitrary Mode to generate different segments in different sampling intervals, you can connect any complex waveforms you want, adjusting their lengths depending on the demands of the application, transferring them without distortion concerns, and finally generating waveforms for high-speed output. This so long as each waveform complies with the requirement of arbitrary waveforms.

4.6 Amplitude Modulation

Amplitude modulation provides a waveform in which the amplitude of the carrier waveform varies with the modulating waveform.

Carrier Waveform

The default carrier waveform is sine. One may also choose from ramp and arbitrary waveforms but not square, pulse, and dc waveforms. The default carrier frequency is 1kHz for all waveforms. Each carrier waveform has its own acceptable range of frequencies. Refer to the table in Section 3.4 "To Set Output Frequency" for details.

Modulating Waveform

The G5110A accesses the internal modulating waveform as the modulating source, and the default modulating waveform is a sine wave. Square with URamp (Up or Positive Ramp with 100% symmetry), DRamp (Down or Negative Ramp with 0% symmetry), triangle (ramp with 50% symmetry) and arbitrary waveforms are available. If an arbitrary waveform is chosen, the number of points in the waveform will be limited to 1000 points with an automatic decimation process. In addition, the default frequency for modulating is 100Hz and the acceptable range is from 2 mHz to 20 kHz.

Modulation Depth

The modulation depth controls the magnitude of the amplitude variation of the modulation output. It is defined as the following formula:

$$\text{ModulationDepth} = (\text{MaxAmplitude} - \text{MinAmplitude}) / \text{Amplitude} \times 100\%$$

where Amplitude is the specified amplitude of the carrier waveform; MaxAmplitude and MinAmplitude are the maximum and minimum amplitudes of the resulting modulation waveform. The G5110A is designed so that when Modulation Depth is 0%, the amplitude of the modulation waveform stays at half of the specified amplitude of the carrier waveform. As a result, MinAmplitude may be negative when ModulationDepth is larger than 100%. The default Modulation Depth is 100% and the allowable range is from 0% to 120%.

Note that the modulation output of the G5110A will not exceed $\pm 5V$ peak (into a 50-ohm load) even if the modulation depth is greater than 100%.

How to set up amplitude modulation

1. Press one of the following function buttons to choose your carrier waveform: Sine, Square, Ramp, and Arb. Specify all of the necessary waveform parameters for the carrier waveform as described in Section 4.1, 4.2, 4.3 and 4.5.

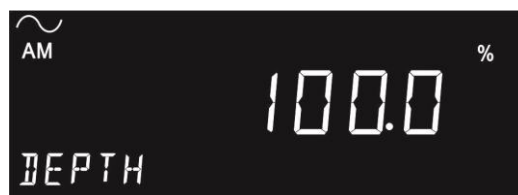

Figure 4-6

2. Press the Mod button.
3. Rotate the knob to AM.
4. Press the Edit button at AM mode. Rotate the knob. The TYPE, DEPTH, AM FRQ, and SHAPE will show up in sequence. Input your desired parameter, or press Edit to adjust the DEPTH and AM FRQ. Then press the Enter button to confirm the settings. An amplitude modulation output will be generated with the current parameters.
5. Press the Edit button under SHAPE for different types of modulating waveform selection, such as SINE, SQUARE, TRIANGLE, UPRAMP, DNRAMP, and ARB. If arbitrary waveform (Arb) is selected with the Enter button as the modulating signal source, then the modulating signal source will be dependent on the previous waveform selection in the Arb function.
6. Press the Output button to generate the waveform with the specific modulation you defined.

Remote interface operation

Use these commands to output an amplitude modulation waveform:

FUNCTION {SINusoid|RAMP|USER}

FREQuency {<frequency> | MINimum|MAXimum}

VOLTage {<amplitude> | MINimum|MAXimum}

VOLTage:OFFSet {<offset> | MINimum|MAXimum}
AM:INTernal:FUNCTion
 {SINusoid|SQUare|RAMP|NRAMP|TRIangle|USER}
AM:INTernal:FREQuency {<frequency> | MINimum|MAXimum}
AM:DEPTH {<depth in percent> | MINimum | MAXimum }
AM:SOURce {INTernal}
AM:STATe ON

Notes

- Only one type of modulation can be activated at one time. When amplitude modulation is enabled, the previously selected modulation is automatically disabled.
- Amplitude modulation cannot be enabled with sweep or burst mode at the same time. When amplitude modulation is enabled, sweep or burst mode will be disabled.

4.7 Frequency Modulation

Frequency modulation provides a waveform in which the frequency of the carrier waveform varies with the modulating waveform.

Carrier Waveform

The default carrier waveform is sine. One may also choose from square, ramp and arbitrary waveforms but not pulse or dc waveforms. The default carrier frequency is 1 kHz for all waveforms. Each carrier waveform has its own acceptable range of frequencies. Please refer to the table in Section 3.3 "To Set Output Frequency" for details.

Modulating Waveform

The G5110A accesses the internal modulating waveform as the modulating source. The default modulating waveform is a sine wave. One may also choose from square with URamp (Up or Positive Ramp with 100% symmetry), DRamp (Down or Negative Ramp with 0% symmetry), triangle (ramp with 50% symmetry) and arbitrary waveforms. If an arbitrary waveform is chosen, the number of points in the waveform will be limited to one thousand with an automatic decimation process. In

addition, the default frequency for modulation is 10Hz. The acceptable range is from 2 mHz to 20 kHz.

Frequency Deviation

The frequency deviation represents the peak variation in the frequency of the modulation output based on that of the carrier waveform. The default value is 100 Hz. Each type of carrier waveform has a different acceptable range as follows:

- Sine: 1mHz to 7.55 MHz(at carrier frequency = 7.55 MHz).
- Square: 1mHz to 7.55 MHz(at carrier frequency = 7.55 MHz).
- Ramp: 1mHz to 150 kHz(at carrier frequency = 150 kHz).
- Arbitrary: 1mHz to 1.55 MHz(at carrier frequency = 1.55 MHz).

In addition, the maximum allowable value is constrained by the following two conditions:

- The frequency deviation must not be greater than the carrier frequency.
- The sum of frequency deviation and the carrier frequency must not be greater than the maximum frequency of the selected carrier waveform plus 100 kHz; that is, 15.1 MHz for sine and square, 300 kHz for ramp, and 3.1 MHz for arbitrary waveforms.

If a value is set greater than one of the above constraints, the G5110A will automatically adjust it to the maximum value allowed.

How to set up frequency modulation

1. Press one of the following function buttons to choose your carrier waveform: Sine, Square, Ramp, and Arb. Specify all of the necessary waveform parameters for the carrier waveform as described in Section 4.1, 4.2, 4.3 and 4.5.



Figure 4-7

2. Press the Mod button.

3. Rotate the knob to FM.
4. Press the Edit button at FM mode. Rotate the knob. The TYPE, FM DEV, FM FRQ, and SHAPE will show up in sequence. Input your desired parameter, or press the Edit to adjust FM DEV and FM FRQ. Then press the Enter button to confirm the settings. A frequency modulation output will be generated with the current parameters.
5. Press the Edit button under SHAPE for different types of modulating waveform selection, such as SINE, SQUARE, TRIANGLE, UPRAMP, DNRAMP, and ARB. If arbitrary waveform (Arb) is selected with the Enter button as the modulating signal source, then the modulating signal source will be dependent on the previous waveform selection in Arb function.
6. Press the Output button to generate the waveform with the specific modulation you defined.

Remote interface operation

Use these commands to output a frequency modulation waveform:

```

FUNCTION {SINusoid|SQUare|RAMP|USER}
FREQUency {<frequency> | MINimum|MAXimum}
VOLTage {<amplitude> | MINimum|MAXimum}
VOLTage:OFFSet {<offset> | MINimum|MAXimum}
FM:INTernal:FUNCTion
    {SINusoid|SQUare|RAMP|NRAMP|TRIangle|NOISe|USER}
FM:INTernal:FREQUency {<frequency>MINimum|MAXimum}
FM:DEVIation {<peak deviation in Hz> | MINimum|MAXimum }
FM:SOURce {INTernal}
FM:STATe ON

```

Notes

- Only one type of modulation can be activated at one time. When frequency modulation is enabled, the previously selected modulation is automatically disabled.
- Frequency modulation cannot be enabled with sweep or burst mode at the same time. When frequency modulation is enabled, sweep or burst mode will be disabled.

4.8 Phase Modulation

Phase modulation provides a waveform in which the phase of the carrier waveform varies with the modulating waveform.

Carrier Waveform

The default carrier waveform is sine. One may also choose from square, ramp and arbitrary waveforms but not pulse or dc waveforms. The default carrier frequency is 1 kHz for all waveforms. Each carrier waveform has its own acceptable range of frequencies. Refer to the table in Section 3.4 "To Set Output Frequency" for details.

Modulating Waveform

The G5110A accesses the internal modulating waveform as the modulating source. The default modulating waveform is a sine wave. One may also choose from square with URamp (Up or Positive Ramp with 100% symmetry), DRamp (Down or Negative Ramp with 0% symmetry), triangle (ramp with 50% symmetry) and arbitrary waveforms. If an arbitrary waveform is chosen, the number of points in the waveform will be limited to one thousand points with an automatic decimation process. In addition, the default frequency for modulating is 10Hz. The acceptable range is from 2 mHz to 20 kHz.

Phase Deviation

The phase deviation represents the peak variation in the phase of the modulation output based on that of the carrier waveform. The range of the phase deviation is from 0 to 360 degrees. The default is 180 degrees.

How to set up phase modulation

1. Press one of the following function buttons to choose your carrier waveform: Sine, Square, Ramp, or Arb. Specify all of the necessary waveform parameters for the carrier waveform as described in Section 4.1, 4.2, 4.3 and 4.5.

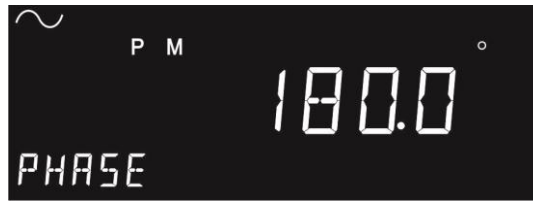

Figure 4-8

2. Press the Mod button.
3. Rotate the knob to PM.
4. Press the Edit button at PM mode. Rotate the knob. The TYPE, PHASE, PM FRQ, and SHAPE will show up in sequence. Input your desired parameter, or press the Edit to adjust the PHASE and PM FRQ. Then press the Enter button to confirm the settings. A phase modulation output will be generated with the current parameters.
5. Press the Edit button under SHAPE for different types of modulating waveform selection, such as SINE, SQUARE, TRIANGLE, UPRAMP, DNRAMP, and ARB. If arbitrary waveform (Arb) is selected with the Enter button as modulating signal source, then the modulating signal source will be dependent on the previous waveform selection in arbitrary function.
6. Press the Output button to generate the waveform with the specific modulation you defined.

Remote interface operation

Use these commands to output a phase modulation waveform:

FUNCTION {SINusoid|SQUare|RAMP|USER}

FREQuency {<frequency>|MINimum|MAXimum}

VOLTage {<amplitude>|MINimum|MAXimum }

VOLTage:OFFSet {<offset>|MINimum|MAXimum }

PM:INTern:FUNCTion

{SINusoid|SQUare|RAMP|NRAMP|TRIangle|USER}

PM:INTern:FREQuency {<frequency> | MINimum|MAXimum}

PM:DEVIation {<deviation in degrees> | MINimum|MAXimum }

PM::SOURce {INTernal}

PM:STATe ON

4.9 FSK Modulation

The G5110A provides the capability to output FSK (Frequency-Shift Keying) modulation where the frequency of the waveform shifts between two frequencies (called "carrier frequency" and "hop frequency"). The shifting rate is determined by the modulating signal.

Carrier Waveform

The default carrier waveform is sine. One may also choose from square, ramp and arbitrary waveforms but not pulse or dc waveforms. The default carrier frequency is 1 kHz for all waveforms. Each carrier waveform has its own acceptable range of frequencies. Refer to the table in Section 3.4 "To Set Output Frequency" for details.

Modulating Waveform

The G5110A accesses the internal modulating waveform as the modulating source. The default source is square and it is the only choice available.

"Hop" Frequency

The default is 100Hz for all functions. Each carrier waveform has its own acceptable range of allowable hop frequency as follows.

- Sine: 1mHz to 15 MHz(at carrier frequency = 1mHz).
- Square: 1mHz to 15 MHz(at carrier frequency = 1mHz).
- Ramp: 1mHz to 200 kHz(at carrier frequency = 1mHz).
- Arbitrary: 1mHz to 3 MHz(at carrier frequency = 1mHz).

FSK Rate

This is the rate at which the output frequency shifts between the carrier frequency and the hop frequency when "internal source" is selected. The default FSK rate is 10 Hz and the range is from 2 mHz to 100 kHz.

How to generate a FSK waveform

1. Press one of the following function buttons to choose your carrier waveform: Sine, Square, Ramp, or Arb. Specify all of the necessary waveform parameters for the carrier waveform as

described in Section 4.1, 4.2, 4.3 and 4.5.

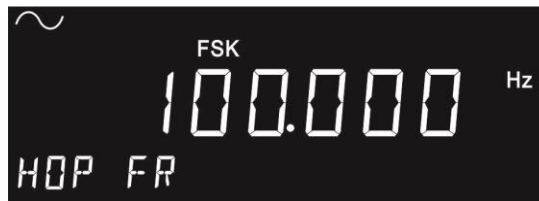

Figure 4-9

2. Press the Mod button.
3. Rotate the knob to FSK.
4. Press the Edit button at FSK mode. Rotate the knob. The TYPE, HOP FR, and RATE will show up in sequence. Input your desired parameter or press the Edit to adjust HOP FR and RATE. Then press the Enter button to confirm the settings. A FSK modulation output will be generated with the current parameters.
5. Press the Output button to generate the waveform with the specific modulation you defined.

Remote interface operation

FUNcTION {SINusoid|SQUare|RAMP|USER}

FREQUency {<frequency>|MINimum|MAXimum}

VOLTage {<amplitude>|MINimum|MAXimum }

VOLTage:OFFSet {<offset>|MINimum|MAXimum }

FSKey: FREQUency {<frequency>|MINimum|MAXimum}

FSKey:INTernal:RATE {<rate in Hz>|MINimum|MAXimum }

FSKey:SOURce {INTernal}

FSKey:STATe ON

4.10 PWM Waveform

The G5110A waveform generator provides the capability to output a pulse width modulation (PWM) for pulse carrier waveforms. In PWM mode, the pulse width of the pulse carrier waveform varies with the modulating waveform. The pulse width can be expressed in time units.

Carrier Waveform

Pulse waveform is the only waveform that is available for PWM. The default period for the carrier pulse is 1 ms, and the range is from 200 ns to 1000 s.

Modulating waveform

The G5110A accesses the internal modulating waveform as the modulating source and the default modulating waveform is a sine wave. One may also choose from square with URamp (Up or Positive Ramp with 100% symmetry), DRamp (Down or Negative Ramp with 0% symmetry), triangle (ramp with 50% symmetry) and arbitrary waveforms. If an arbitrary waveform is chosen, the number of points in the waveform will be limited to one thousand points with an automatic decimation process. In addition, the default frequency for modulating is 10Hz and the acceptable range is from 2 mHz to 20 kHz.

Width Deviation

The width deviation represents the peak variation in the pulse width of the modulation output based on that of the original pulse carrier waveform. The default deviation is 10µs and the range is from 0s to 500s. In addition, it must not be greater than the pulse width of the carrier waveform which is also constrained by the following formulas:

$$\begin{aligned} \text{WidthDeviation} &\leq \text{PulseWidth} - W_{\text{min}} \\ \text{WidthDeviation} &\leq \text{Period} - (\text{PulseWidth} + W_{\text{min}}) \end{aligned}$$

where W_{min} is the minimum pulse width as described in Section 4.4.

How to set up PWM (pulse width modulation)

1. Press the Pulse button to select the pulse carrier waveform and then set the waveform parameters as described in Section 4.4.

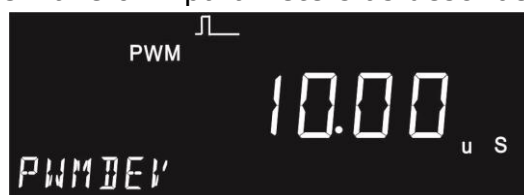

Figure 4-10

2. Press the Mod button. (The PWMDEV will show up promptly.)
3. Press the Edit button at PWMDEV mode. Input a parameter you desire. Press the Enter button to confirm the setting. Then rotate the knob to PWMFRE. Set width the same way. A PWM modulation will be generated with the current parameters.
4. Press the Edit button under SHAPE for different types of modulating waveform selection, such as SINE, SQUARE, TRIANGLE, UPRAMP, DNRAMP, and ARB. If arbitrary waveform (Arb) is selected with the Enter button as modulating signal source, then the modulating signal source is dependent on the previous waveform selection in Arb function.
5. Press the Output button to generate the waveform with the specific modulation you defined.

Remote interface operation

Use the following commands for PWM:

FUNC PULSe

VOLTage {<amplitude> | MINimum|MAXimum}

VOLTage:OFFSet {<offset> | MINimum|MAXimum}

PULSe:PERiod {<seconds>|MINimum|MAXimum}

FUNCTION:PULSe:WIDTh {<seconds>|MINimum|MAXimum}

PWM:INTernal:FUNction

{SINusoid|SQUare|RAMP|NRAMP|TRIangle|USER}

PWM:INTernal:FREQuency {<frequency>|MINimum|MAXimum }

PWM:DEVIation {<deviation in seconds>|Minimum|Maximum}

PWM:SOURce {INTernal}

PWM:STATe ON

4.11 Frequency Sweep

Frequency Sweep provides the capability to generate a waveform that gradually steps from a start frequency to a stop frequency at a specified rate. It can sweep up or down in frequency and with logarithmic or linear spacing. Only sine, square, ramp, and arbitrary waveforms work with the

frequency sweep function.

Sweep Mode

The default sweep mode is linear where the waveform generator sweeps the frequency with spacing calculated in a linear function. In logarithmic sweep mode, the waveform generator sweeps with spacing calculated in a logarithmic function.

Start Frequency and Stop Frequency

The waveform generator begins sweeping from the start frequency to the stop frequency. The waveform generator will sweep down when the start frequency is greater than the stop frequency. The waveform generator will sweep up when the stop frequency is greater than the start frequency.

The default start frequency is 100 Hz and the stop frequency is 1 kHz. The allowable range is 1 mHz to 15 MHz for sine and square, 1 mHz to 200 kHz for ramp, and 1 mHz to 3 MHz for arbitrary waveforms.

Center Frequency and Frequency Span

Center frequency and frequency span provide another way to set the frequency sweep range. The default center frequency is 550 Hz. The allowable range is 1 mHz to 15 MHz for sine and square, 1 mHz to 200 kHz for ramp, and 1 mHz to 3 MHz for arbitrary waveforms. The default frequency span is 900 Hz. The allowable range of the frequency span is dependent on the center frequency setting and waveform selection. Set the positive frequency span for sweeping up and the negative frequency span for sweeping down.

Sweep Time

The sweep time is the period of time (in seconds) required to sweep from the start frequency to the stop frequency. The number of discrete frequency points is calculated by the waveform generator according to the sweep time specified. The default sweep time is 1 second and the range is from 1 ms to 500 s.

Marker Frequency

The marker frequency provides a way to control the Sync signal that is output from the front panel *Sync* connector. For sweeps with Marker On, the Sync signal is a TTL “high” at the beginning of the sweep and turns to “low” at the marker frequency. For sweeps with Marker Off, the Sync signal is a square waveform. That is, the Sync signal is a TTL “high” at the beginning of a sweep and turns to “low” at the midpoint of the sweep. The frequency of the Sync signal is the reciprocal of the specified sweep time.

The default marker frequency is 500 Hz. The range of the marker frequency is dependent on the stop frequency setting or frequency span setting. The marker frequency must be less than or equal to the maximum output frequency.

Trigger Source

The waveform generator outputs a single sweep when it receives a trigger signal. It keeps outputting the same type of waveform with the start frequency before it receives next trigger and sends out another sweep.

The Trigger Source can be internal, or manual; the default is Internal.

- With internal trigger source, the waveform generator continuously outputs sweeps with the specified sweep time.
- If manual trigger is selected, the waveform generator sends out a sweep each time the Trigger button on the front panel is pressed.

How to set up frequency sweep

1. Press one of the following function buttons to choose your waveform for sweeping: Sine, Square, Ramp, and Arb. Specify all of the necessary waveform parameters for the waveform as described in Section 4.1, 4.2, 4.3 and 4.5.



Figure 4-11

2. Press the Sweep button to enable or disable the sweep mode. To enable the sweep mode, make sure the Sweep button is lit.
3. Press the Edit button at MODE. Rotate the knob to LINEAR/LOG/ARB, and then confirm it with the Enter button.
4. Rotate the knob to START/STOP/TIME/MARK(OFF/ON:MARKER)/TRIG(INTERNAL/MANUAL).
5. Use the numeric keypad, the Edit button, the knob, or cursor keys to change parameters, and then confirm it with the Enter button.
 - a. To specify the trigger source, you have to select either INTERNAL or MANUAL.
 - b. If MANUAL is selected, the Trigger button on the front panel will be lit.
6. Press the Output button to generate the waveform with the specific modulation you defined.

Remote interface operation

```

SWEep:SPACing {LINear|LOGarithmic|USER}
SWEep:TIME {<seconds>|MINimum|MAXimum }
FREQuency:STARt {<frequency>|MINimum|MAXimum }
FREQuency:STOP {<frequency>|MINimum|MAXimum }
FREQuency:CENTer {<frequency>|MINimum|MAXimum }
FREQuency:SPAN {<frequency>|MINimum|MAXimum }
MARKer:FREQuency {<frequency>|MINimum|MAXimum }
MARKer {OFF|ON}
SWEep:STATe ON
  
```

Use this command to specify the trigger source:

```
TRIGger:SOURce {IMMediate|BUS}
```

4.12 Burst Operation

The G5110A offers the burst operation to generate the selected type of waveform with a specified number of cycles, called a *burst*. Bursts may be triggered internally or manually. Sine, ramp, pulse, square and

arbitrary waveforms are allowed in the triggered burst modes.

Triggered Burst Mode

This is the default burst mode. The G5110A outputs a waveform with a specified number of cycles, called *burst count*, each time it receives a trigger. When the specified number of cycles is outputted, the waveform generator pauses and waits for next trigger. One may choose to trigger the bursts using the internal source or to press the *Trigger* button manually on the front panel to trigger a burst.

Table 4.12-1

The available parameters in each burst mode.

		Burst Count	Burst Period	Burst Phase
Triggered mode	Internal	√	√	√
	Manual	√		√

Burst Count

The Burst Count represents the number of cycles appeared in each burst. It is only used in the triggered burst mode. The default burst count is 1 cycle. The range is from 1 to 50,000 cycles in 1 cycle increment. One may also set an infinite burst count.

When the trigger source is set to internal, the waveform generator outputs bursts repeatedly at a rate determined by the specified burst period. This represents the time interval between the start times of two consecutive bursts. The burst count must be less than the product of the burst period and the waveform frequency:

$$\text{BurstCount} < \text{BurstPeriod} \times \text{WaveformFrequency}$$

The waveform generator will automatically increase the burst period up to its maximum allowable value to accommodate the specified burst count. The waveform frequency is not affected by burst count.

Waveform Frequency

The waveform frequency defines the frequency of the output waveform

when the trigger signal is logic true. In the triggered mode, the specified number of cycles is generated at the waveform frequency.

The default waveform frequency is 1 kHz. The range is from 1 mHz to 200 kHz for ramps, 1 mHz to 15 MHz for square, 1 mHz to 5 MHz for pulse, 1 mHz to 3 MHz for arbitrary, 1 mHz to 15 MHz for Sine. In the internally triggered burst mode, the minimum frequency is 2 mHz. For sine and square waveforms, frequencies greater than 3 MHz are allowed only when an infinite burst count is set.

Burst Period

The burst period represents the time interval between the start times of two consecutive bursts. It is only used in the internally triggered burst mode. The default burst period is 10 ms and the range is from 1 μ s to 500 seconds.

The burst period must be long enough for the generator to produce the specified burst count. If the burst period is set too short, the waveform generator automatically adjusts it to the shortest value that can accommodate the specified burst count and waveform frequency:

$$\text{BurstPeriod} > \frac{\text{BurstCount}}{\text{WaveformFrequency}} + 200\text{ns}$$

Burst Phase

Burst Phase defines the starting phase of a burst. The default is 0 degrees and the range is from -360 degrees to +360 degrees. You can only set the burst phase in degree from the front panel operation, while degrees and radians are both available from the remote interface operation.

For sine, square and ramp waveforms, zero degrees are the points at which the waveform crosses zero volts or the dc offset when ascending. For an arbitrary waveform, it is the first waveform point specified. The burst phase has no effect on pulse waveform.

Trigger Source

The default trigger source is internal. The available options are internal

and manual. When the waveform generator is set to be in the triggered burst mode, it generates a burst with a specific number of cycles each time a trigger is received. Then it stops and waits for the next trigger event to occur. When the trigger source is internal, the bursts are generated at a rate determined by the burst period. When the trigger source is manual, the burst is generated only when the Trigger button is pressed.

When the trigger source is set to be manual, the burst count and burst phase remain the same, but the burst period is ignored.

How to set up burst output

1. Press one of the function buttons.
2. Refer to Section 3.3, and specify the waveform frequency for the selected function.
3. Press the Burst button on the front panel (dc is not allowed).
4. Press the Edit, and rotate the knob to choose CYCLE or INFINITE. Then confirm it with the Enter button.

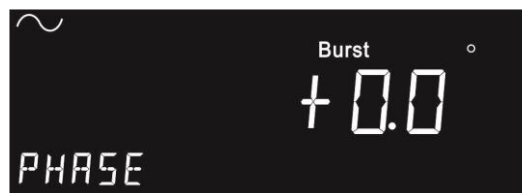

Figure 4-12

4.1 Choose CYCLE mode

- Set a burst count using the numeric keypad or the knob with the cursor keys.
- Use the same way to set PHASE > PERIOD > TRIG (INTERNAL/MANUAL) in sequence.

4.2 Choose INFINITE mode

- Set PHASE > TRIG (INTERNAL/MANUAL) in sequence using the numeric keypad or the knob with the cursor keys.

5. Press the Output button to generate the waveform with the specific modulation you defined.

Remote interface operation

FUNCTION {SINusoid|SQUare|RAMP|PULSe | USER}
FREQuency {<frequency>|MINimum|MAXimum}
BURSt:MODE {TRIGgered }
BURSt:NCYCles {<#cycles>|INFinity|MINimum|MAXimum}
BURSt:INTernal:PERiod {<seconds>|MINimum|MAXimum}
BURSt:PHASe {<angle>|MINimum|MAXimum}
UNIT:ANGLE {DEGree|RADian}
TRIGger:SOURce {IMMEDIATE| BUS}
BURSt:STATe ON

5 System Operations

5.1 Triggering

This feature is only available for bursts and sweeps. There are two options to choose from, internal triggering and manual triggering. The default is internal triggering during which the waveform generator continuously produces the selected waveform.

In manual triggering, the waveform generator outputs a burst or a sweep each time the Trigger button on the front panel is pressed. The Trigger button is lit when the waveform generator is waiting for the next trigger event. Triggering is disabled when functions other than burst or sweep are chosen.

How to choose a trigger source

1. After the burst or sweep is activated, rotate the knob to TRIG.
2. Press the Edit button, and then select among Int (internal), and Man (manual).
3. After your selection is made with the Enter button, DONE will be shown on the display.

Note that the trigger source setting is stored in the volatile memory. The default setting will be restored after the power is cycled.

Remote interface operation

TRIGger:SOURce {IMMEDIATE| BUS}

Software Triggering

In software triggering, a bus command is sent through the remote interface to trigger the waveform generator. The waveform generator produces a burst or a sweep when it receives one such command. The operation is similar to the Trigger button on the front panel for manual triggering.

Remote interface operation

To trigger the waveform generator from the remote interface, choose BUS as the trigger source:

TRIGger:SOURCe BUS

and send one of the following commands to trigger:

*TRG

TRIGger

5.2 Storing the instrument state

The G5110A provides four storage locations (1-4) in a non-volatile memory for the user to store instrument states. A fifth storage location, location 0, holds the default configuration of the instrument. The stored instrument state holds all the parameters for the selected function, including the waveform, frequency, dc offset, amplitude, symmetry, modulation type and modulation parameters.

Location "0" can only be accessed from the remote interface. You may assign a custom name to any of these locations from the remote interface, but cannot assign a name for location "0." The name can contain up to 12 characters, but the first character has to be a letter. The rest can be numbers, letters, or the underscore character ("_").

How to store /recall/delete the instrument state

1. Press the Store/Recall button. If one of the locations is not used, it shows NONE with a space number like the state on Figure 5-1.



Figure 5-1

- 1.1 To store an instrument state:
 - a. Rotate the knob or use direction buttons to reach SAVE.
 - b. Press the Edit button.

- c. Use the knob to select a location you want to save settings in, for example; NONE 1 (Only 1 to 4 is available from front panel operation. Any saved locations can be refreshed or replaced by any other reset.).
- d. Press the ENTER button to save your settings. The display shows a brief DONE, and then STATE 1.



Figure 5-2

- 1.2 To recall a saved state:
 - a. Rotate the knob or use direction buttons to reach RCALL.
 - b. Press the Edit button.
 - c. Use the knob to select the location you want to recall settings from, for example; DEFAULT (The other saved location is also available to select).
 - d. Press the ENTER button to recall the default parameters. When finished, the display shows a brief DONE.



Figure 5-3

- 1.3 To delete a saved state:
 - a. Rotate the knob or use direction buttons to reach DELETE.
 - b. Press the Edit button.
 - c. Use the knob to select the location you want to delete, for example: STATE 1.
 - d. Press the ENTER button to delete it. When finished, the display shows a brief DONE.



Figure 5-4

- 1.4 To set the power-on state (i.e., the instrument state restored when the waveform generator is powered on):
 - a. Rotate the knob or use direction buttons to reach PWR ON.
 - b. Press the Edit button.
 - c. Use the knob to select the location you want to recall settings from, for example; DEFAULT (The other saved location is also available to select).
 - d. Press the ENTER button to recall the DEFAULT/STATE 1-4 after power-on. When finished, the display shows a brief DONE.



Figure 5-5

Remote interface operation

*SAV {1|2|3|4}

*RCL {0|1|2|3|4}

MEMory:STATE:NAME {1|2|3|4} [,<name>]

5.3 Display Control

The G5110A provides an option to turn off the front display screen. One may choose to do this for security reasons or for speeding up the command execution from the remote interface. This option is available via remote operation only.

Remote interface operation (only)

Use this command to turn off the front panel display:

DISP OFF

Use this command to display a message and turn the display back on:

DISP:TEXT 'message to display'

Use this command to clear the current message on display.

DISP:TEXT CLEAR

Notes

- The display is automatically enabled when the waveform generator is powered on, the *RST (reset) command is issued, or it is returned to the local front-panel operation.
- Error messages are always displayed even when the display is turned off.
- The display setting may be saved with the *SAV command. When the instrument state is restored using the *RCL command, the display setting will return to the saved state.

5.4 Beeper

The G5110A normally produces a beep when an error is detected. One may turn off the beep. The beeper setting is stored in non-volatile memory, so the setting remains even after the waveform generator is turned off or the reset command is issued from the remote operation.

How to turn on/off the beeper

1. Press the Utility button and use the knob and directions button to reach SYSTEM.
2. Press the ENTER button to confirm.
3. Do the same to reach BEEP. Then press the Edit button
4. Select either ON to turn on the beep or OFF to turn off the beep.
5. Press the ENTER button to finish the setting.



Figure 5-6

Remote interface operation

SYSTem:BEEPer

SYSTem:BEEPer:STATe {OFF|ON}

5.5 Sound

The G5110A normally produces sounds when the operation buttons and knob are used. One may turn off the sound when needed. The sound setting is stored in non-volatile memory, so the setting remains even after the waveform generator is turned off or the reset command is issued from the remote operation.

How to turn on/off the beeper

1. Press the Utility button and use the knob and directions button to reach SYSTEM.
2. Press the ENTER button to confirm.
3. Do the same to reach SOUND. Then press the Edit button
4. Select either ON to turn on the sound or OFF to turn off the sound.
5. Press the ENTER button to finish the setting.



Figure 5-7

Remote interface operation

SYSTem:SOUNd

SYSTem:SOUNd:STATe {OFF|ON}

5.6 Error Display

The waveform generator can store up to 30 syntax or hardware errors in its error queue. Each error string may contain up to 255 characters. The waveform generator beeps every time it detects an error (unless the beeper is turned off). Errors are stored in first-in-first-out (FIFO) order and they are cleared once read. To clear the error queue through the

remote interface, use the *CLS command. The error queue will not be cleared by the *RST command, but will be cleared when the waveform generator is turned off. Refer to Chapter 7 for more details about the error queue and error messages.

Remote interface operation

Use this command to read one error from the error queue:

SYSTem:ERRor?

Use this command to clear all the errors in the error queue:

*CLS

5.7 Calibration

For the calibration, the G5110A doesn't support the calibration via front panel operation, but via the remote interface.

5.8 Screen Saver

This function can help you save the screen's electricity consumption according to your usage rate. There are seven choices, such as off, 1 min, 10 mins, 30 mins, 1 hr, 2 hrs, or 8 hrs.

To enable this function, press Utility > Rotate the Knob > System > ENTER > Rotate the Knob > SCRSVR > Edit > Rotate the Knob to choose a preferable selection mentioned above. Once you confirm the selection, press ENTER to apply. The display will show "DONE" in 0.5 second.

When the display extinguishes after a period of non-operation on the front panel, it means that the screen saver actuates. To wake it up, press any keys on the front panel.

6 Remote Interface Operations

The G5110A supports three remote interfaces: USB, GPIB (IEEE-488), and RS-232. For GPIB, you will need an additional GPIB interface card to be installed. This chapter describes the operations for setting up these remote interfaces and lists the SCPI (Standard Commands for Programmable Instrument) commands available to control the waveform generator remotely. For the first time SCPI users, refer to Appendix B for the introductory materials on SCPI commands.

6.1 Remote Interface Configuration

6.1.1 USB Interface

The USB connector on the rear panel of the G5110A, which conforms to the USBTMC protocol, is a series "B" connector. The USB cord should be securely connected between the G5110A and your PC. Install the G5110A application in your PC and execute the program.

How to set up USB interface

Connect the proper USB cable to the USB connector on the rear panel and your computer. The waveform generator sets up the USB interface automatically once the cable is properly connected. You may navigate from the Utility button and rotate the knob to IO, then press Enter. Doing it again will cause the USB ID to show its ID. Press the Edit button and use the knob to get all of the information.

6.1.2 GPIB Interface

Before you can set up the GPIB interface, you will need to insert the GPIB interface card into the interface slot on the rear panel, install the G5110A application in your PC, and execute the application. To set up the GPIB interface, connect the waveform generator and your computer with the proper GPIB cable and assign a GPIB address for the waveform generator. The factory default GPIB address is 10. It can be set to any number

between 0 and 30. The address is stored in non-volatile memory, so it is not affected by power cycle or a remote interface reset command. Avoid using the same address for the GPIB interface card in your computer.

How to set up GPIB interface

1. Press the Utility button, and rotate the knob to the I/O softkey. Then Press Enter.
2. Rotate the knob to "GPIB A" then press Enter.
3. Use the numeric keypad or the knob with cursor keys to change the value.
4. Press the Enter button to confirm the settings.

6.1.3 RS-232 Interface

If you want to utilize this interface, you need to know the configuration including how to set the front-panel's baud rate, parity, and number of data bits. You can configure the RS-232 interface by pressing MENU>INTERFACE>RS-232 on the G5110A and using the parameters shown below.

- Baud Rate: 300, 600, 1200, 2400, 4800, 9600 (Default), 19200, 38400, 57600, 115200 baud
- Parity & Data Bits: None / 8 data bits (Default)
Even / 7 data bits, or
Odd / 7 data bits
- Number of Start Bits: 1 bit (fixed)
- Number of Stop Bits: 2 bits (fixed)

※ Note: The settings on the AWG must be the same as the settings on the application software.

How to connect a computer or Terminal with the RS-232

To connect the G5110A to a computer or terminal, a proper interface cable is essential. Most computers and terminals belong to DTE (Data Terminal Equipment) devices including the generator. You must apply a DTE-to-DTE interface cable, which is commonly called a null-modem, modem-eliminator, or crossover cable (DB-9, Female to Female pin). The cable's pin diagram is shown below.

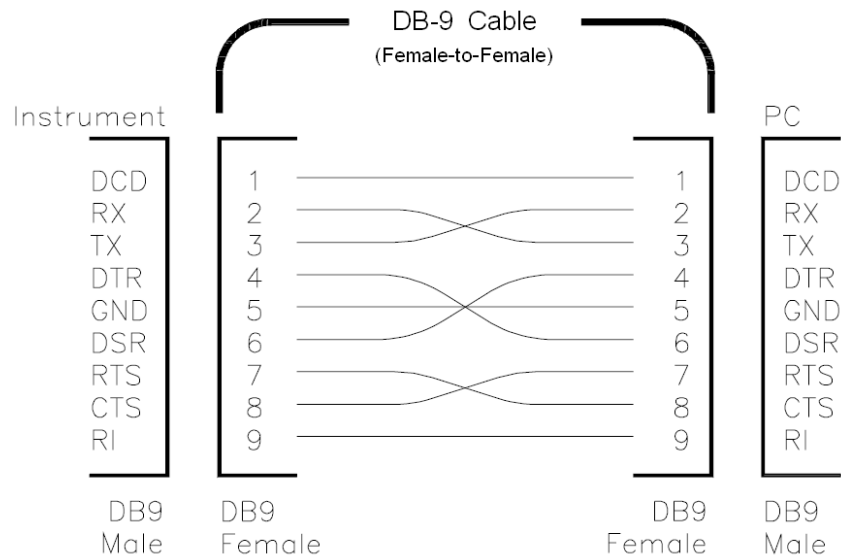

Troubleshooting about the RS-232

Here are some troubleshooting tips when you encounter problems with RS-232 communication.

- Check that the G5110A and your computer are configured for the same baud rate, parity, and number of data bits. Confirm that your PC is set up for 1 start bit and 2 stop bits (The values are fixed on the AWG).
- Check that the interface cable and adapters have been connected correctly, even the DB-9 Cable type (straight or crossover type).
- Check that the interface cable has been connected to the correct serial port on your PC (COM1, COM2, etc).

6.2 Remote Interface Commands

You may instruct your G5110A waveform generator to generate waveforms by using the SCPI (Standard Commands for Programmable Instrument) commands after the selected remote interface is appropriately set up. This section lists the SCPI commands available for remotely controlling the waveform generator. For first time SCPI users, please refer to Appendix B for the introductory materials on SCPI

commands.

Note that the following conventions are used in SCPI command syntax. The triangle brackets, <>, indicate that you must specify a value for the enclosed parameter. The square brackets, [], indicate that the parameter is optional and can be omitted. The curly braces, {}, enclose the parameter choices for a given command string. A vertical bar, |, separates several choices for a parameter.

The APPLY Commands

```
APPLY:SINusoid [<frequency>[,<amplitude>[,<offset> ] ]]  
APPLY:SQUare [<frequency>[,<amplitude>[,<offset> ] ]]  
APPLY:RAMP [<frequency>[,<amplitude>[,<offset> ] ]]  
APPLY:PULSe [<frequency>[,<amplitude>[,<offset> ] ]]  
APPLY:DC [<frequency|DEF>[,<amplitude>[,<offset> ] ]]  
APPLY:USER [<frequency>[,<amplitude>[,<offset> ] ]]  
APPLY?
```

Output Configuration Commands

```
FUNCTion {SINusoid|SQUare|RAMP|PULSe|DC|USER}  
FUNCTion?  
FREQuency {<frequency>|MINimum|MAXimum}  
FREQuency? [MINimum|MAXimum]  
VOLTage {<amplitude>|MINimum|MAXimum}  
VOLTage? [MINimum|MAXimum]  
VOLTage:OFFSet {<offset>|MINimum|MAXimum}  
VOLTage:OFFSet ?[MINimum|MAXimum]  
VOLTage:HIGH {<voltage>|MINimum|MAXimum}  
VOLTage:HIGH? [MINimum|MAXimum]  
VOLTage:LOW {<voltage>|MINimum|MAXimum}  
VOLTage:LOW? [MINimum|MAXimum]  
VOLTage:RANGe:AUTO {OFF|ON|ONCE}  
VOLTage:RANGe:AUTO?  
VOLTage:UNIT {Vpp|Vrms|dBm}  
VOLTage:UNIT?  
FUNCTion:RAMP:SYMMetry {<percent> | MINimum | MAXimum}  
FUNCTion:RAMP:SYMMetry? [MINimum | MAXimum]
```

OUTPut {OFF | ON}

OUTPut?

OUTPut:LOAD {<ohms> | INFinity | MINimum | MAXimum}

OUTPut:LOAD? [MINimum | MAXimum]

OUTPut:POLarity {NORMAL | INVERTed}

OUTPut:POLarity?

OUTPut:SYNC {OFF | ON}

OUTPut:SYNC?

Pulse Configuration Commands

PULSe:PERiod {<seconds> | MINimum | MAXimum}

PULSe:PERiod? [MINimum | MAXimum]

FUNcTION:PULSe:HOLD {WIDTh }

FUNcTION:PULSe:HOLD? [WIDTh]

FUNcTION:PULSe:WIDTh {<seconds> | MINimum | MAXimum }

FUNcTION:PULSe:WIDTh? [MINimum | MAXimum]

Amplitude Modulation Commands

AM:INTernal:FUNcTION{SINusoid | SQUare | RAMP | NRAMp |
TRIangle | USER}

AM:INTernal:FUNcTION?

AM:INTernal:FREQUency {<frequency> | MINimum | MAXimum}

AM:INTernal:FREQUency? [MINimum | MAXimum]

AM:DEPTTh {<depth in percent> | MINimum | MAXimum }

AM:DEPTTh? [MINimum | MAXimum]

AM:SOURce {INTernal}

AM:SOURce?

AM:STATe {OFF | ON}

AM:STATe?

Frequency Modulation Commands

FM:INTernal:FUNcTION{SINusoid | SQUare | RAMP | NRAMp |
TRIangle | USER}

FM:INTernal:FUNcTION?

FM:INTernal:FREQUency {<frequency> | MINimum | MAXimum}

FM:INTernal:FREQUency? [MINimum | MAXimum]

FM:DEVIation {<peak deviation in Hz> | MINimum | MAXimum}

FM:DEVIation? [MINimum | MAXimum]

FM:SOURce {INTernal}

FM:SOURce?

FM:STATe {OFF | ON}

FM:STATe?

Phase Modulation Commands

PM:INTernal:FUNction{SINusoid | SQUare | RAMP | NRAMp |
TRIangle | USER}

PM:INTernal:FUNction?

PM:INTernal:FREQuency {<frequency> | MINimum | MAXimum}

PM:INTernal:FREQuency? [MINimum | MAXimum]

PM:DEVIation {<peak deviation in Hz> | MINimum | MAXimum}

PM:DEVIation? [MINimum | MAXimum]

PM:SOURce {INTernal}

PM:SOURce?

PM:STATe {OFF | ON}

PM:STATe?

FSK Commands

FSKey: FREQuency {<frequency> | MINimum | MAXimum }

FSKey: FREQuency? [MINimum | MAXimum]

FSKey:INTernal:RATE{<rate in Hz> | MINimum | MAXimum }

FSKey:INTernal:RATE? [MINimum | MAXimum]

FSKey:SOURce {INTernal}

FSKey:SOURce?

FSKey:STATe {OFF | ON}

FSKey:STATe?

PWM Commands

PWM:INTernal:FUNction{SINusoid | SQUare | RAMP | NRAMp |
TRIangle | USER}

PWM:INTernal:FUNction?

PWM:INTernal:FREQuency {<frequency> | MINimum | MAXimum}

PWM:INTernal:FREQuency? [MINimum | MAXimum]

PWM:DEVIation {<deviation in seconds> | MINimum | MAXimum}

PWM:DEVIation? [MINimum | MAXimum]

PWM:SOURce {INTernal}

PWM:SOURce?

PWM:STATe {OFF | ON}

PWM:STATe?

Sweeps Commands

FREQuency:START {<frequency> | MINimum | MAXimum}

FREQuency:START? [MINimum | MAXimum]

FREQuency:STOP{<frequency> | MINimum | MAXimum}

FREQuency:STOP? [MINimum | MAXimum]

FREQuency:CENTer {<frequency> | MINimum | MAXimum}

FREQuency:CENTer? [MINimum | MAXimum]

FREQuency:SPAN{<frequency> | MINimum | MAXimum}

FREQuency:SPAN? [MINimum | MAXimum]

SWEep:SPACing {LINear | LOGarithmic | User}

SWEep:SPACing?

SWEep:TIME {<seconds> | MINimum | MAXimum}

SWEep:TIME? [MINimum | MAXimum]

SWEep:STATe {OFF | ON}

SWEep:STATe?

TRIGger:SOURce {IMMediate | BUS}

TRIGger:SOURce?

MARKer:FREQuency {<frequency> | MINimum | MAXimum}

MARKer:FREQuency? [MINimum | MAXimum]

MARKer {OFF | ON}

MARKer?

Burst Commands

BURSt:MODE {TRIGgered}

BURSt:MODE?

BURSt:NCYCles {<#cycles> | INFinity | MINimum | MAXimum}

BURSt:NCYCles? [MINimum | MAXimum]

BURSt:INTernal:PERiod {<seconds> | MINimum | MAXimum }

BURSt:INTernal:PERiod? [MINimum | MAXimum]

BURSt:PHASe {<angle> | MINimum | MAXimum }

BURSt:PHASe? [MINimum | MAXimum]

BURst:STATe {OFF | ON}
BURst:STATe?
UNIT:ANGLE {DEGree | RAdIAN}
UNIT:ANGLE?

For triggered burst

TRIGger:SOURce {IMMediate | BUS}
TRIGger:SOURce?

Arbitrary Waveform Commands

DATA VOLATILE, <value>, <value>, ...
DATA:DAC VOLATILE, {<binary block> | <value>, <value>, ...}
FORMat:BORDER {NORMal | SWAPPed}
FORMat:BORDER?
DATA:COPY <destination arb name> [, VOLATILE]
FUNction:USER {<arb name> | VOLATILE}
FUNction:USER?
FUNction USER
FUNction?
DATA:CATalog?
DATA:NVOLatile:CATalog?
DATA:NVOLatile:FREE?
DATA:ATTRibute:AVERage? [<arb name>]
DATA:ATTRibute:CFACTOR? [<arb name>]
DATA:ATTRibute:POINTs? [<arb name>]
DATA:ATTRibute:PTPeak? [<arb name>]

Triggering Commands

TRIGger:SOURce {IMMediate | BUS}
TRIGger:SOURce?
TRIGger
*TRG

State Storage Commands

*SAV{1 | 2 | 3 | 4}
*RCL{1 | 2 | 3 | 4}
MEMory:STATe:NAME {1 | 2 | 3 | 4} [, <name>]

MEMory:STATe:NAME? {1 | 2 | 3 | 4}
MEMory:STATe:DELeTe {1 | 2 | 3 | 4}
MEMory:STATe:RECall:AUTO {OFF | ON}
MEMory:STATe:RECall:AUTO?
MEMory:STATe:RECall:SElect {0 | 1 | 2 | 3 | 4}
MEMory:STATe:RECall: SElect?
MEMory:STATe:VALid? {1 | 2 | 3 | 4}
MEMory:NSTates?

System-related Commands

SYSTem:ERRor?
*IDN?
DISPlay {OFF | ON}
DISPlay?
DISPlay:TEXT <quoted string>
DISPlay:TEXT?
DISPlay:TEXT:CLEar
*RST
*TST?
SYSTem:VERSion?
SYSTem:BEEPer
SYSTem:BEEPer:STATe {OFF | ON}
SYSTem:BEEPer:STATe?
SYSTem:KLOCK[:STATe] {OFF | ON}
SYSTem:KLOCK:EXCLude {NONE | LOCAL}
SYSTem:KLOCK:EXCLude?
SYSTem:SECurity:IMMediate
*LRN?
*OPC
*OPC?
*WAI

Interface Configuration Commands

SYSTem:COMMunication:RLState {LOCAL | REMote | RWLock}

Phase-lock Commands

PHASe {<angle> | MINimum | MAXimum}

PHASe? [MINimum | MAXimum]
PHASe:REFerence
PHASe:UNLock:ERRor:STATe {OFF | ON}
PHASe:UNLock:ERRor:STATe?
UNIT:ANGLE {DEGree | RADian}
UNIT:ANGLE?

Status Reporting Commands

*STB?
*SRE <enable value>
*SRE?
STATus:QUEStionable:CONDition?
STATus:QUEStionable[:EVENT]?
STATus:QUEStionable:ENABle <enable value>
STATus:QUEStionable:ENABle?
*ESR?
*ESE <enable value>
*ESE?
*CLS
STATus:PRESet
*PSC {0 | 1}
*OPC

Calibration Commands

CALibration?
CALibration:SECure:CODE <*new code*>
CALibration:SECure:STATe {OFF|ON},<*code*>
CALibration:SECure:STATe?
CALibration:SETup <0 | 1 | 2 | 3 | ... | 84>
CALibration:SETup?
CALibration:STRing<*quoted string*>
CALibration:STRing?
CALibration:VALue<*pos,value*>
CALibration:VALue? Pos
CALibration:MVALue <value>
CALibration:MVALue? <pos>
CALibration:SAVE

Timebase Commands

REference:TIMEbase:STATe ON | OFF

REference:TIMEbase:OUTPut ON | OFF

REference:TIMEbase:MODE INT | EXT | AUTO

REference:TIMEbase:MODE?

REference:TIMEbase:OUTPut ?

REference:TIMEbase:STATe?

IEEE 488.2 Common Commands

*CLS

*ESE<enable value>

*ESE?

*ESR?

*IDN?

*LRN?

*OPC

*OPC?

*PSC {0|1}

*PSC?

*RST

*SAV{1 | 2 | 3 | 4}

*RCL{1 | 2 | 3 | 4}

*SRE <enable value>

*SRE?

*STB?

*TRG

*TST?

7 Error Messages

Error messages are issued when an incorrect remote command is sent to your G5110A waveform generator for execution. This may occur for several reasons such as incorrect command syntax, issuing the parameters of a command that violate some system constraints, hardware failures and so on. All of possible error messages are categorized and listed in this chapter for your reference. If you cannot find a particular error message in this chapter, please contact your service representative.

Error messages are stored in an error queue in the G5110A and may be retrieved in the first-in-first-out (FIFO) order. The first error returned is the first error that was stored. The G5110A beeps in different lengths when different errors occur, and the ERROR annunciator is lit whenever there are error messages in the error queue. Only when all the errors in the queue are read will the ERROR annunciator be turned off.

Should more than 30 errors have been generated, the last error stored in the queue (the most recent error) is replaced with -350, "Queue Overflow." No additional errors are saved until errors are read and cleared from the queue. If there is no error in the error queue, the waveform generator will respond with +0, "No Error."

The error queue is cleared with a power cycle or a *CLS (clear status) command. The *RST (reset) command does not clear the error queue.

How to read error messages

1. Press the Utility button.
2. Rotate knob to SYSTEM and then press Enter.
3. Rotate knob to CMDERR and then press Enter.
4. Rotate knob to see all queued Error Message or press Edit to see the entire text of one Error Message.

Note. Once you enter the CMDERR, the system will read all Error Messages from the Queue. This action also clears the Queue. Therefore, it will be empty when you get into CMDERR the next time.

Remote interface operation

Use this command to read one error from the error queue:

SYSTem:ERRor?

Use this command to clear all the errors in the error queue:

*CLS

7.1 Command Errors

-101 Invalid character

An invalid character was detected in the command string.

-102 Syntax error

Invalid syntax was detected in the command string.

-103 Invalid separator

An invalid separator was detected in the command string.

-105 GET not allowed

GET is not allowed in a command string.

-108 Parameter not allowed

More parameters than expected were received.

-109 Missing parameter

Fewer parameters than expected were received.

-112 Program mnemonic too long

More characters than allowed in the command header were received.

-113 Undefined header

An invalid command was received.

-123 Exponent too large

A numeric parameter with exponent larger than 32,759 was detected.

-124 Too many digits

A numeric parameter with too many digits (> 255) was detected.

-128 Numeric data not allowed

A numeric parameter was received when the waveform generator was expecting a string parameter.

-131 Invalid suffix

A suffix was incorrectly specified for a numeric parameter.

-138 Suffix not allowed

A suffix is not supported for this command.

-148 Character data not allowed

A discrete parameter was received when it was not expected.

-151 Invalid string data

An invalid character string was received.

-158 String data not allowed

A character string was received when it was not allowed for this command.

-161 Invalid block data

For a definite-length block, the number of bytes of data sent does not match the number of bytes that you specified in the block header.

-168 Block data not allowed

This command does not accept the data format.

-170 to -178 Expression errors

Mathematical expressions are not acceptable for the instrument.

7.2 Execution Errors

-211 Trigger ignored

AGET or *TRG was received but the trigger was ignored.

-221 Settings conflict; turned off infinite burst to allow immediate trigger source

An infinite burst count is only allowed when an external or bus (software) trigger source is used.

-221 Settings conflict; infinite burst changed trigger source to BUS

An infinite burst count is only allowed when an external or bus (software) trigger source is used.

-221 Settings conflict; burst period increased to fit entire burst

The specified number of cycles in the BURS:NCYC command takes priority over the burst period and the waveform generator increased the burst period to accommodate the burst count or the waveform frequency.

-221 Settings conflict; burst count reduced to fit entire burst

Since the burst period is currently at its maximum, the waveform generator has adjusted the burst count to accommodate the waveform frequency.

-221 Settings conflict; amplitude units changed to Vpp due to high-Z load

dBm is not available as unit when the output termination is set to "high impedance."

-221 Settings conflict; frequency reduced for user function

The maximum output frequency for arbitrary waveform is 3 MHz. When you change function from one allowing higher frequency to arbitrary waveform, the frequency is adjusted to 3 MHz.

-221 Settings conflict; frequency changed for pulse function

The maximum output frequency for pulse waveform is 5 MHz. When you change function from one allowing higher frequency to pulse waveform, the frequency is adjusted to 5 MHz.

-221 Settings conflict; frequency reduced for ramp function

The maximum output frequency for ramp waveform is 200 kHz. When you change function from one allowing higher frequency to ramp waveform, the frequency is adjusted to 200 kHz.

-221 Settings conflict; frequency made compatible with burst mode

The maximum output frequency for an internal-triggered burst is 2 mHz. The waveform generator has adjusted the frequency to be compatible with the current setting.

-221 Settings conflict; burst turned off by selection of other mode or modulation

Only one modulation can be enabled at one time.

-221 Settings conflict; FSK turned off by selection of other mode or modulation

Only one modulation can be enabled at one time.

-221 Settings conflict; FM turned off by selection of other mode or modulation

Only one modulation can be enabled at one time.

-221 Settings conflict; AM turned off by selection of other mode or modulation

Only one modulation can be enabled at one time.

-221 Settings conflict; PM turned off by selection of other mode or modulation

Only one modulation can be enabled at one time.

-221 Settings conflict; PWM turned off by selection of other mode or modulation

Only one modulation can be enabled at one time.

-221 Settings conflict; sweep turned off by selection of other mode or modulation

Only one modulation can be enabled at one time.

-221 Settings conflict; not able to modulate this function

This waveform generator cannot generate an AM, FM, PM, FSK modulated waveform using the pulse or dc voltage function.

-221 Settings conflict; PWM only available in pulse function

The waveform generator can only generate PWM modulated waveform using pulse function.

-221 Settings conflict; not able to sweep this function

The waveform generator cannot generate a sweep using the pulse or dc voltage function.

-221 Settings conflict; not able to burst this function

The waveform generator cannot generate a burst using the dc voltage function.

-221 Settings conflict; not able to sweep pulse, sweep turned off

The waveform generator cannot generate a sweep using the pulse function.

-221 Settings conflict; not able to modulate dc, modulation turned off

The waveform generator cannot generate a dc voltage function.

-221 Settings conflict; Not able to sweep dc, sweep turned off

The waveform generator cannot generate a sweep using the dc voltage function.

-221 Settings conflict; not able to burst dc, burst turned off

The waveform generator cannot generate a burst using the dc voltage function.

-221 Settings conflict; pulse width decreased due to period

With edge time at its minimum, the waveform generator has adjusted the pulse width to accommodate the specified period.

-221 Settings conflict; edge time decreased due to period

The edge time has been decreased to accommodate the period.

-221 Settings conflict; pulse width increased due to large period

The waveform generator has adjusted the pulse width to a greater minimum determined by the current period.

-221 Settings conflict; edge time decreased due to pulse width

The waveform generator adjusts first the edge time then the pulse width, then period, if needed, to accommodate the following the limitation: $\text{EdgeTime} \leq 0.625 \times \text{PulseWidth}$. In this case, the edge time is decreased by the waveform generator to accommodate the specified pulse width.

-221 Settings conflict; amplitude changed due to function

When the new function chosen has a smaller maximum amplitude, the waveform generator will automatically adjust the amplitude from the old value to the new smaller maximum value. This may occur when the output units are Vrms or dBm due to the differences in crest factor for the various output functions.

-221 Settings conflict; offset changed on exit from dc function

In the dc voltage function, the voltage level is controlled by adjusting the offset voltage (the current amplitude is ignored). When you select a different function, the waveform generator will adjust the offset voltage as needed to be compatible with the current amplitude setting.

-221 Settings conflict; FM deviation cannot exceed carrier

The frequency deviation cannot exceed the carrier frequency, or the

waveform generator will adjust the deviation to a maximum allowed value.

-221 Settings conflict; FM deviation exceeds max frequency

The sum of the carrier frequency and the deviation cannot exceed the maximum frequency for the chosen function plus 100 kHz (15.1 MHz for sine and square, 300 kHz for ramp, and 3.1 MHz for arbitrary waveforms). If you set the carrier to a value that is not valid, the waveform generator will adjust the deviation to the maximum value allowed.

-221 Settings conflict; PWM deviation decreased due to pulse parameters

The PWM deviation must follow the limitation concerning the pulse width, edge time, and period (see Ch 4.11 for these limitations), or the waveform generator will adjust it automatically.

-221 Settings conflict; marker forced into sweep span

The marker frequency must be a value between the start and the stop frequency.

-221 Settings conflict; selected arb is missing, changing selection to default

If you delete an arbitrary waveform after storing its instrument state, you will lose the waveform data and not able to output the waveform. The built-in exponential-rise wave is outputted instead.

-221 Settings conflict; offset changed due to amplitude

When the existing offset voltage does not conform the following limitation: $|V_{\text{offset}}| + V_{\text{pp}} / 2 \leq V_{\text{max}}$, it is adjusted automatically to the maximum dc voltage allowed with the specified amplitude.

-221 Settings conflict; amplitude changed due to offset

When the existing amplitude does not conform to the following limitation: $|V_{\text{offset}}| + V_{\text{pp}} / 2 \leq V_{\text{max}}$, it is adjusted automatically to the maximum value allowed with the specified offset voltage.

-221 Settings conflict; low level changed due to high level

The high level must always be greater than the low level. If you specify a high level that is smaller than the low level, the waveform generator will adjust the low level to be 1 mV less than the high level.

-221 Settings conflict; high level changed due to low level

The high level must always be greater than the low level. If you specify a low level that is greater than the high level, the waveform generator will adjust the high level to be 1 mV greater than the low level.

-222 Data out of range; value clipped to upper limit

The specified parameter is out of range and is adjusted to the maximum value allowed.

-222 Data out of range; value clipped to lower limit

The specified parameter is out of range and is adjusted to the minimum value allowed.

-222 Data out of range; pulse edge time limited by period; value clipped to upper limit

The specified edge time does not conform within the existing period and is adjusted to the maximum value allowed.

-222 Data out of range; pulse width time limited by period; value clipped to...

The specified pulse width does not conform to the following condition and is adjusted to accommodate the period:

$$\text{PulseWidth} \leq \text{Period} - 40\text{ns}$$

-222 Data out of range; large period limits minimum pulse width

The minimum pulse width for pulse waves with period larger than 10 s. Refer to the table of minimum pulse width in Section 4.5 for details.

-222 Data out of range; pulse edge time limited by width; value clipped to...

The specified pulse edge time does not conform to the following

condition and is adjusted to accommodate the pulse width:

$$\text{EdgeTime} \leq 0.625 \times \text{PulseWidth}$$

-222 Data out of range; period; value clipped to...

The pulse period is out of range and is adjusted.

-222 Data out of range; frequency; value clipped to...

The frequency is out of range and is adjusted.

-222 Data out of range; user frequency; value clipped to upper limit

The frequency is out of range and is adjusted to the maximum value allowed due to selection of arbitrary waveform.

-222 Data out of range; ramp frequency; value clipped to upper limit

The frequency is out of range and is adjusted to the maximum value allowed due to selection of ramp waveform.

-222 Data out of range; pulse frequency; value clipped to upper limit

The frequency is out of range and is adjusted to the maximum value allowed due to selection of pulse waveform.

-222 Data out of range; burst period; value clipped to...

The burst period is out of range and is adjusted.

-222 Data out of range; burst count; value clipped to...

The burst count is out of range and is adjusted.

-222 Data out of range; burst period limited by length of burst; value clipped to lower limit

The burst period is too short to accommodate the burst count and frequency and is adjusted to the minimum value allowed.

-222 Data out of range; burst count limited by length of burst; value clipped to upper limit

The burst count is out of range. When the immediate trigger source is selected, the burst count must be less than the product of the burst period and the waveform frequency.

-222 Data out of range; amplitude; value clipped to...

The amplitude is out of range and is adjusted.

-222 Data out of range; offset; value clipped to...

The offset voltage is out of range and is adjusted.

-222 Data out of range; frequency in burst mode; value clipped to...

The frequency is adjusted as indicated by the burst period.

-222 Data out of range; frequency in FM; value clipped to...

This message indicates that the carrier frequency is adjusted to the lower boundary determined by the FM:DEV command. The carrier frequency must be greater than or equal to the frequency deviation.

-222 Data out of range; marker confined to sweep span; value clipped to...

The specified marker frequency is out of range and is adjusted to the start or stop frequency, whichever is closer.

-222 Data out of range; pulse width; value clipped to...

The desired pulse width is limited to the upper or lower boundary as indicated by the instrument hardware.

-222 Data out of range; pulse edge time; value clipped to...

The desired edge time is limited to the upper or lower boundary as indicated by the instrument hardware.

-222 Data out of range; FM deviation; value clipped to...

The desired frequency deviation is limited to the upper or lower boundary set by the carrier frequency.

-222 Data out of range; FM deviation limited by minimum frequency

The frequency deviation is limited to the lower limit.

-222 Data out of range; FM deviation limited by maximum frequency; value clipped to upper limit

The frequency deviation cannot exceed the carrier frequency. The maximum should be limited to 7.55 MHz for sine or square carrier waveforms and 1.55 MHz for an arbitrary waveform.

-222 Data out of range; PWM deviation

The width deviation is allowed to be in the range of 0 and the width of the underlying pulse waveform. But this message indicates that either parameter is further limited by minimum pulse width and edge time parameters.

-222 Data out of range; PWM deviation limited by pulse parameters

The PWM deviation (width) is adjusted to accommodate the current pulse parameters such as pulse width, period and edge time.

-223 Too much data

An arbitrary waveform specified contains more than 8192 points. Verify the number of points in the DATA VOLATILE or DATA:DAC VOLATILE command.

-224 Illegal parameter value

An exact parameter value was expected.

7.3 Device Dependent Errors

-313 Calibration memory lost; memory corruption detected

A checksum error was detected in the non-volatile memory used to store calibration constant.

-314 Save/recall memory lost; memory corruption detected

A checksum error was detected in the non-volatile memory used to

store instrument states.

-315 Configuration memory lost; memory corruption detected

A checksum error was detected in the non-volatile memory used to store configuration settings.

-350 Queue overflow

More than 30 errors were found and the error queue was full.

7.4 Query Errors

-410 Query INTERRUPTED

A command was received, but the output buffer contained data from a previous command (the previous data is lost).

-420 Query UNTERMINATED

A query command was sent to read the output buffer over the interface, but no such command that generates data to the output buffer was previously sent for execution.

-430 Query DEADLOCKED

An executed command generated too much data for the output buffer and the input buffer is also full. The command continues to execute but the data is lost.

-440 Query UNTERMINATED after indefinite response

The *IDN? command must be the last query command within a series of commands in a command string.

7.5 Instrument Errors

501 Cross-isolation UART framing error

502 Cross-isolation UART overrun error

Internal hardware failure.

580 Reference phase-locked loop is unlocked

The PHAS:UNL:ERR:STAT has been turned on and the internal phase-locked loop is currently unlocked.

7.6 Self-Test Errors

621 Self-test failed; square-wave threshold DAC

A possible malfunctioning DAC, failed DAC multiplexer (U8_2) channels, or associated circuitry.

623 Self-test failed; dc offset DAC

624 Self-test failed; null DAC

625 Self-test failed; amplitude DAC

A possible malfunctioning DAC, failed DAC multiplexer (U8_2) channels, or associated circuitry.

626 Self-test failed; waveform filter path select relay

627 Self-test failed; -10 dB attenuator path

628 Self-test failed; -20 dB attenuator path

629 Self-test failed; +20 dB amplifier path

These errors indicate that the specified relay is not properly switched or the attenuator/amplifier does not provide the expected attenuation or gain. These self-tests use the internal ADC to verify whether the output path relays, output amplifier (+20 dB), and output attenuators properly operate or not.

630 Self-test failed; internal ADC over-range; condition

A probable ADC failure.

631 Self-test failed; internal ADC measurement error

A probable ADC failure.

632 Self-test failed; square/pulse DAC test failure

A probable failure of the square/pulse DAC (U10_7).

7.7 Calibration Errors

701 Calibration error; security defeated by hardware jumper

The calibration security feature has been disabled by shorting the two "CAL ENABLE" pads on the internal circuit board.

702 Calibration error; calibration memory is secured

The calibration memory is secured to disallow a calibration from performing. Use the CAL:SEC:STAT ON command with correct security code to unsecure the calibration memory.

703 Calibration error; secure code provided was invalid

Security code provided in the CAL:SEC:STAT ON command was invalid.

706 Calibration error; provide value is out of range

The specified calibration value is out of range.

707 Calibration error; signal input is out of range

The analog-to-digital converter (ADC) verified that the signal applied to the *Modulation In* connector on the rear panel is out of range.

707 Calibration error; cal edge time: rise time cal error

707 Calibration error; cal edge time: fall time cal error

707 Calibration error; cal edge time: default value loaded

A failure in the rise time or fall time circuitry has prevented calibration

from going forward.

850 Calibration error; setup is invalid

Invalid calibration setup number specified.

851 Calibration error; setup is out of order

Calibration setup procedures must be performed in a specific sequence in order to be valid.

7.8 Arbitrary Waveform Errors

770 Nonvolatile arb waveform memory corruption detected

A checksum error was found in the non-volatile memory used to store arbitrary waveform. As a result, the arbitrary waveform cannot be retrieved.

**781 Not enough memory to store new arb waveform; use
DATA:DELETE**

All non-volatile memory locations are occupied. There is no room to store a new waveform.

781 Not enough memory to store new arb waveform; bad sectors

Due to storage hardware failure, new waveforms cannot be saved.

782 Cannot overwrite a built-in waveform

The five built-in waveform names ("EXP_RISE", "EXP_FALL", "NEG_RAMP", "SINC", and "CARDIAC") are reserved and cannot be used with DATA:COPY command.

784 Name of source arb waveform for copy must be VOLATILE

When using the DATA:COPY command, the data source must be the VOLATILE one.

785 Specified arb waveform does not exist

Before using DATA:COPY command to copy from the volatile memory,

be sure to download the waveform to it using the DATA VOLATILE or DATA:DAC VOLATILE command.

786 Not able to delete a built-in arb waveform

Deleting the built-in waveform is not allowed.

787 Not able to delete the currently selected active arb waveform

Deleting the waveform that is currently outputting is not allowed.

788 Cannot copy to VOLATILE arb waveform

You can only use DATA:COPY command to copy from VOLATILE, not to VOLATILE.

800 Block length must be even

The binary data are represented as 16-bit integers. They are sent in groups of two bytes (DATA:DAC VOLATILE command).

810 State has not been stored

The storage location specified in the *RCL command was never used in previous *SAV commands. You cannot recall the instrument state from an empty storage location.

Appendix

This appendix contains the performance specifications of the G5110A. It covers the AC, DC, Resistance, Temperature, and Frequency/Period characteristics under a variety of conditions. It also contains the general characteristics and accuracy calculations.

A great deal of efforts has been put into making sure that these specifications serve the needs of production, engineering and/or academic research. All specifications apply to the G5110A unless noted otherwise.

A Specification List

Display	Text LCD for visual verification of signal settings	
Capability	Standard waveforms	Sine, Square, Ramp, Triangle, Pulse, DC
	Built-in arbitrary waveforms	Exponential Rise and Fall, Negative Ramp, Sin(x)/x, Cardiac
WAVEFORM CHARACTERISTIC		
Sine	Frequency	1 mHz to 15 MHz
	Amplitude	0.10dB(<100KHz)
	Flatness ^{1,2} (Relative to 1K)	0.15dB(<5MHz)
		0.2dB(<15MHz)
	Harmonic distortion ^{2,3} (unit: dBc)	DC to 20 KHz, -65
		20 KHz to 100 KHz, -65
		100 KHz to 1 MHz, -60
		1 MHz to 15 MHz, -40
	Total Harmonic distortion ^{2,3}	DC to 20 kHz, Output $\geq 0.32V_{pp}$ THD+N $\leq 0.2\%$
	Spurious ^{2,4} (non-harmonic)	DC to 1 MHz -60 dBc
1 MHz to 15 MHz -60 dBc + 6 dB/octave		
Phase Noise (10K Offset)	-100/dBc/Hz, typical when $f \geq 1MHz, V \geq 0.1V_{pp}$	

¹ Add 1/10th of output amplitude and offset spec per °C for operation outside the range of 18 °C to 28 °C.

² Autorange enabled.

³ DC offset set to 0V.

⁴ Spurious output at low amplitude is -65 dBm typical.

Square	Frequency	1 mHz to 15 MHz
	Rise/Fall time	< 15 ns
	Overshoot	< 2%
	Variable Duty Cycle	20% ~ 80% (to 5MHz) 40% ~ 60% (to 15MHz)
	Asymmetry	1% of period + 5 ns (@50% duty)
	Jitter (RMS)	1 ns + 100 ppm of Period
Ramp, Triangle	Frequency	1 mHz to 200 KHz
	Linearity	< 0.5% of peak output
	Symmetry	5.0% ~ 95.0%
Pulse	Frequency	1 mHz to 5 MHz
	Pulse width	40 ns minimum
		10 ns res. (period ≤ 10s)
	Variable Edge Time	< 15 ns (Untunable)
	Overshoot	< 2%
Jitter (RMS)	1 ns + 100 ppm of Period	
Arbitrary	Frequency	1 mHz to 3 MHz
	Length	2 to 8 K
	Resolution	14 bits (including sign)
	Sample Rate	50 MSa/s
	Min Rise/Fall Time	50ns typical
	Linearity	< 0.5%of peak output
	Settling Time	< 250ns to 2% of final value
	Jitter(RMS)	12 ns + 60ppm
Non-volatile Memory	4 waveforms * 8 K Points	
COMMON CHARACTERISTIC		
Frequency	Resolution	1mHz
Amplitude	Range	10mVpp to 10Vpp in 50Ω
		20mVpp to 20Vpp in Hi-Z

	Accuracy ^{1,2} (at 1kHz)	±2% of setting ± 3mVpp
	Units	Vpp, Vrms, dBm
	Resolution	3 digits
DC Offset	Range (Peak AC +DC)	±5V in 50Ω ±10V in Hi-Z
	Accuracy ^{1,2}	±2% of offset setting ±2% of amplitude setting ±2mV
	Resolution	3 digits
	Impedance	50 Ω typical
Main Output	Isolation	42 Vpk maximum to earth
	Internal Frequency reference Accuracy⁵	
		±0.5 ppm in 90 days
		±1.0 ppm in 1 year
External Frequency reference	Standard /Option	Option
External Frequency Input	Lock Range	10 MHz ± 500 Hz
	Level	100mVpp ~5Vpp
	Impedance	1kΩ typical, AC coupled
	Lock Time	< 2 Sec
External Frequency Output	Lock Range	10 MHz
	Level	632mVpp (0dBm), typical
	Impedance	50Ω typical, AC coupled
Phase Offset	Range	-360° to +360°
	Resolution	0.001
	Accuracy	20 ns
Modulation		
Modulation Type	AM, FM, PM, FSK, PWM, Sweep and Burst	
AM	Carrier	Sine, Ramp, Arb

⁵ Add 1 ppm/ °C average for operation outside the range of 18 °C to 28 °C.

	Source	Internal
	Internal Modulation	Sine, Square, Ramp, Triangle, Arb
	Frequency (Internal)	2mHz to 20KHz
	Depth	0.0% ~ 120.0%
FM	Carrier	Sine, Square, Ramp, Arb
	Source	Internal
	Internal Modulation	Sine, Square, Ramp, Triangle, Arb
	Frequency (Internal)	2mHz to 20KHz
	Deviation	DC ~ 7.5MHz
PM	Carrier	Sine, Square, Ramp, Arb
	Source	Internal
	Internal Modulation	Sine, Square, Ramp, Triangle, Arb
	Frequency (Internal)	2mHz to 20KHz
	Deviation	0.0° to 360°
PWM	Carrier	Pulse
	Source	Internal
	Internal Modulation	Sine, Square, Ramp, Triangle, Arb
	Frequency (Internal)	2mHz to 20KHz
	Deviation	0% ~ 100% of pulse width
FSK	Carrier	Sine, Square, Ramp, Arb
	Source	Internal
	Frequency (Internal)	2mHz to 100KHz
SWEEP	Waveforms	Sine, Square, Ramp, Arb
	Type	Linear, logarithmic, Arb

	Direction	up or down
	Sweep Time	1 ms ~ 500 Sec
	Trigger	Internal / Manual
	Marker	falling edge of sync signal (programmable frequency)
BURST⁶	Waveforms	Sine, Square, Ramp, Triangle, Arb
	Type	CYCLE / INFINITE
	Start/Stop Phase	-360 [°] to +360 [°]
	Internal Period	1uS ~ 500Sec
	Trigger Source	Internal / Manual

⁶ Sine and square waveforms above 3 MHz are allowed only with an "infinite" burst count.

B Remote Interface Reference

B.1 An Introduction to the SCPI Language

SCPI (Standard Commands for Programmable Instruments) is an ASCII-based instrument command language designed for testing and measurement instruments. It is based on a hierarchical structure, also known as a *tree system*. In this system, associated commands are grouped together under a common node or root, thus forming *subsystems*. A portion of the SOURce subsystem is shown below to explain the tree system.

SOURce:

FREQuency:

STARt {<frequency>|MINimum|MAXimum}

STARt? [MINimum|MAXimum]

FREQuency:

STOP {<frequency>|MINimum|MAXimum}

STOP? [MINimum|MAXimum]

SWEep:

SPACing {LINear|LOGarithmic}

SPACing?

SWEep:

TIME {<seconds>|MINimum|MAXimum}

TIME? [MINimum|MAXimum]

SOURce is the root keyword of the command, SWEep and FREQuency are second-level keywords, and STARt and STOP are third-level keywords. A colon (:) separates a command keyword from a lower-level keyword.

B.1.1 Command Format Used in This Manual

The command format used in this manual is shown below:

STARt {<frequency>|MINimum|MAXimum}

Most commands (and some parameters) are expressed as a mixture of upper- and lower-case letters. The upper-case letters indicate the abbreviated part that must be specified for the command. For shorter program lines, send the abbreviated form. For better program readability, use the long form. For example, in the above syntax statement, STAR and START are both acceptable forms for the same command. You may also mix upper- or lower-case letters in a command. For example, START, star, and Star are all acceptable for the same command. Other forms, such as STA will generate an error.

Braces ({ }) enclose parameter choices for a given command string. The braces are not sent with the command.

Vertical bars (|) separate multiple parameter choices for a given command string.

Triangle brackets (< >) indicate that you must specify a value for the enclosed parameter. For example, the above START command accepts a *frequency* parameter enclosed in triangle brackets. The brackets are not sent with the command string. You must specify a value for the parameter such as "STAR 6000."

Some parameters are enclosed in *square brackets* ([]). The brackets indicate that the parameter is optional and can be omitted. The brackets are not sent with the command string. If you do not specify a value for an optional parameter, the waveform generator uses the default value.

B.1.2 Command Separators

A *colon* (:) is used to separate a command keyword from a lower-level keyword. You must insert a *blank space* to separate a parameter from a command keyword. If a command requires more than one parameter, you must use a comma between two parameters:

```
"APPL:SIN 5 KHZ, 3.0 VPP, -2.5 V"
```

A *semicolon (;)* is used to separate commands within the *same* subsystem, and can reduce typing efforts. For example, sending the following command string:

```
"BURSt:MODE TRIG; NCYCles 10"
```

is the same as sending the following two commands:

```
"BURS:MODE TRIG"
```

```
"BURS:NCYCles 10"
```

Use a colon *and* a semicolon to link commands from different subsystems. For example, in the following command string, an error is generated if you do not use both the colon *and* semicolon:

```
"BURS:STATe ON;:TRIG:SOUR IMM"
```

B.1.3 Using the *MIN* and *MAX* Parameters

You may put MINimum or MAXimum in place of a parameter for many commands. For example, consider the following command:

```
FREQuency: STARt {<frequency>|MINimum|MAXimum}
```

Instead of specifying a specific frequency value, you may use MIN to set the frequency to its minimum value or MAX to its maximum value.

B.1.4 Querying Parameter Settings

You can query the current value of a parameter by adding a *question mark (?)* to the command. For example, the following command sets the start frequency to 5000 Hz:

```
"STAR 5000"
```

You can query the start frequency by executing:

```
"STAR?"
```

You can also query the minimum or maximum start frequency allowed for the current waveform function as follows:

```
"STAR? MIN"
```

```
"STAR? MAX"
```

Caution

- If you send two query commands without reading the response from the first, then when you attempt to read the response, you may receive some data from the first response followed by the complete second response. To avoid this, do not send a query command without reading the response. When you cannot avoid this situation, send a device clear before sending the second query command.

B.1.5 SCPI Command Terminators

A command string sent to the generator *must* terminate with a <new line> character. The IEEE-488 *EOI* (end-or-identify) message is interpreted as a <new line> character and can be used to terminate a command string in place of a <new line> character. A <carriage return> followed by a <new line> is also accepted. Command string termination will *always* reset the current SCPI command path to the root level.

B.1.6 IEEE-488.2 Common Commands

The IEEE-488.2 standard defines a set of *common commands* that perform functions like reset, self-test, and status operations. Common commands always begin with an asterisk (*), are four to five characters in length, and may include one or more parameters. The command keyword is separated from the first parameter by a *blank space*. Use a *semicolon* (;) to separate multiple commands as shown below:

```
"*RST; *CLS; *ESE 32; *OPC?"
```

B.1.7 SCPI Parameter Types

The SCPI language defines several different data formats to be used in program messages and response messages.

Numeric Parameters Commands that require numeric parameters will accept all commonly used decimal representations of numbers including optional signs, decimal points, and scientific notation. Special values for numeric parameters like MINimum, MAXimum, and DEFault are also accepted. You can also send engineering unit suffixes with numeric parameters (e.g., Mhz or Khz). If only specific numeric values are accepted, the waveform generator will automatically round the input numeric parameters. The following example demonstrates a command with a numeric parameter option:

```
FREQuency:STARt {<frequency>|MINimum|MAXimum}
```

Discrete parameters are used in the settings where only a limited number of values (like BUS, IMMEDIATE) are accepted. They have the short and long forms just like command keywords. You can mix upper- and lower-case letters. Query responses will *always* return the short form in all upper-case letters. The following example demonstrates a command with a discrete parameter:

```
TRIGger:SOURce {BUS|IMMEDIATE}
```

Boolean Parameters A Boolean parameter represents a condition that is either true or false. For a false condition, the waveform generator accepts "OFF" or "0" as parameter value. For a true condition, the generator accepts "ON" or "1" as parameter value. When you query a Boolean parameter, the instrument will *always* return "0" or "1." The following example demonstrates a command with a Boolean parameter:

```
SWEep:STATe {OFF|ON}
```

String Parameters A string parameter can contain any set of ASCII characters. A string *must* begin and end with matching quotes, either with single or double quotes. You can include the quote delimiter as part of the string by typing it twice without any characters in between. The following example demonstrates a command with a string parameter:

```
DISPlay:TEXT <quoted string>
```

B.1.8 The SCPI Status System

In this section, we will cover the structure of the SCPI status system used by the function generator. The following page shows the status system recording different conditions and states of the instrument in several register groups. Each of the register groups consists of several low-level registers including Condition registers, Event registers and Enable registers that control the action of specific bits within the register group. Please refer to the diagram below.

A Condition Register monitors the state of the instrument continuously. The condition register bits are updated in real time and aren't latched or buffered. Their characteristics are read-only and cannot be cleared when you read the register. This register query returns a decimal value corresponding to the binary-weighted sum of all bits set in that register.

An Event Register latches different events when changes occur in the condition register. No buffering is offered in this register. While setting an event bit, subsequent events corresponding to that bit will be ignored. The setting will be cleared by query commands, such as STAT:QUES:EVEN? and *CLS. This register query returns a decimal value corresponding to the binary-weighted sum of all bits set in that register.

An Enable Register defines which bits in the event register will be reported to the Status Byte register group. To write and to read from an enable register are allowable. The *CLS command will not clear the enable register, but it clears all bits in the event register. By contrast, the STAT:PRES command will clear all bits in the enable register. In order to enable bits in the enable register to be reported to the Status Byte Register, you have to write a decimal value corresponding to the binary-weighted sum of the corresponding bits.

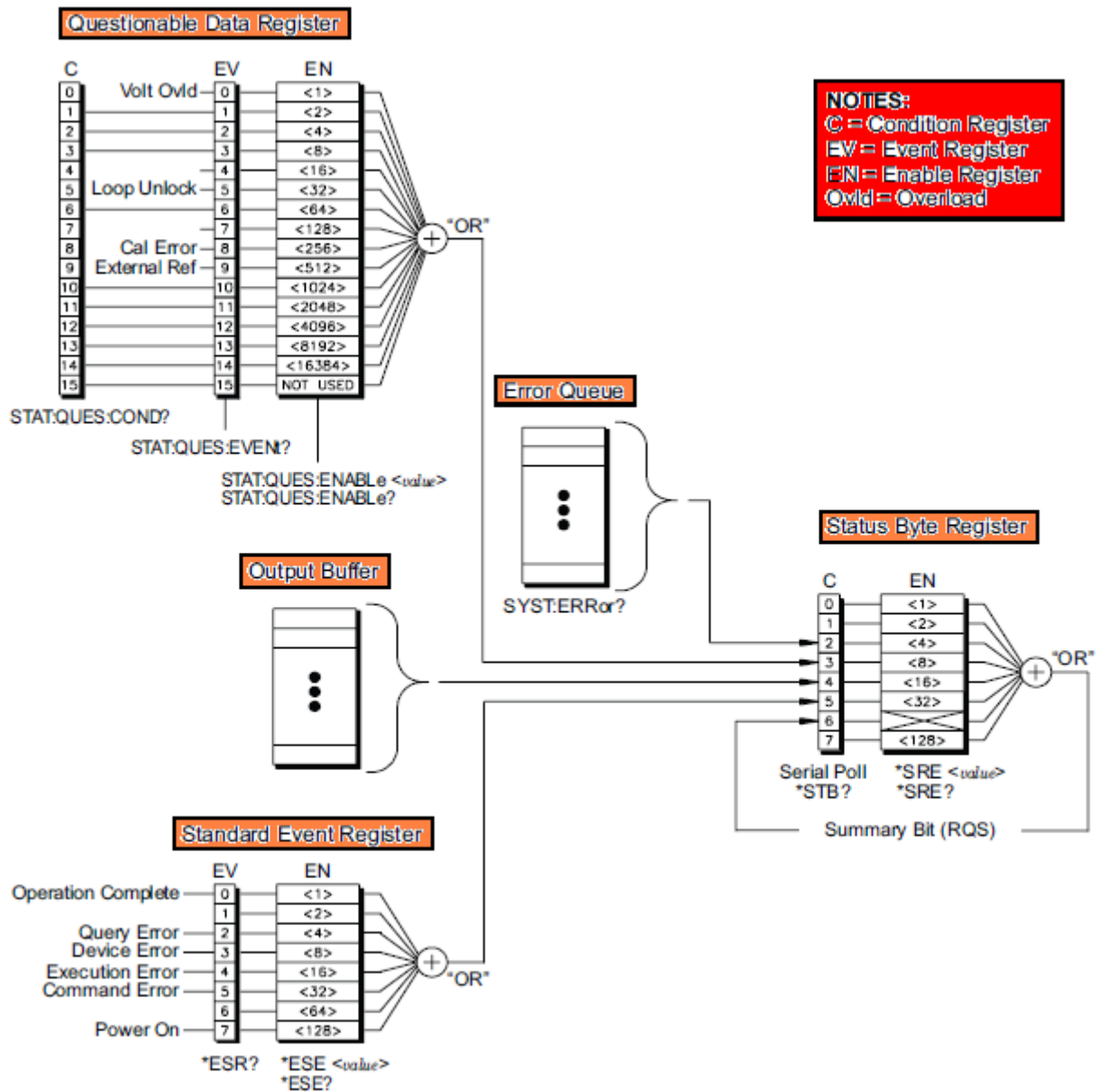

B.1.8.1 The Status Byte Register

The Status Byte summary register reports conditions from the other status registers. The waiting data in the function generator's output buffer is reported at once on the "Message Available" bit 4. While clearing an event register from one of the other register groups, the corresponding bits in the Status Byte condition register will be also cleared. In addition, reading all messages from the output buffer including pending queries will clear the Message Available bit. To set the enable register mask and generate a service request (SRQ), you must

write a decimal value, such as *SRE command to the register. For more information of the status byte register, refer to the following table.

Bit Number	Decimal Value	Definition
0. Not Used	1	Not Used. Returns "0"
1. Not Used	2	Not Used. Returns "0"
2. Error Queue	4	One or more errors are stored in the Error Queue
3. Questionable Data	8	One or more bits are set in the Questionable Data Register (Bits must be enabled.)
4. Message Available	16	Data is available in the equipment's output buffer
5. Standard Event	32	One or more bits are set in the Standard Event Register (Bits must be enabled.)
6. Master Summary	64	One or more bits are set in the Status Byte Register (Bits must be enabled.)
7. Not Used	128	Not Used. Returns "0"

Please note that the registers will be cleared under the following conditions.

1. The Status Byte condition register is cleared when...
 - the *CLS command is executed.
 - the event register from one of the other register groups is read. (Only the corresponding bits are cleared.)
2. The Status Byte enable register is cleared when...
 - the *SRE 0 command is executed.
 - you turn the power on and use the *PSC 1 command on the previously-configured function generator. (Note: The enable register will not be cleared after powering on if the *PSC 0 command is used on the previously configured function generator.)

B.1.8.2 Using SRQ (Service Request) and Serial Poll

You must configure your PC to respond to the IEEE-488 SRQ and interrupt to use this capability. Using the Status Byte enable register (*SRE command) to select one of the condition bits will assert the IEEE-488 SRQ line. If bit 6 is transitioned from a "0" to a "1", an IEEE-488 service request message will be sent to your PC. The PC will poll the equipment on the interface bus to identify which one is the asserting service request line. That is why the equipment with bit 6 is set in its Serial Poll response.

※ Note: When a Serial Poll is issued, bit 6 will be cleared in the Serial Poll response. The service request line will be cleared as well. Other bits will not be affected, including the "Master Summary Bit".

You can obtain the Serial Poll response by sending an IEEE-488 Serial Poll message. Then the equipment sends a one-byte binary response. In the meantime, the IEEE-488 bus interface hardware will handle a Serial Poll performance automatically.

※ Note: ASCII's and some other GPIB's commands are unlike a Serial Poll which is executed immediately and doesn't involve the equipment's main processor. Therefore, the status indicated by a Serial Poll might not indicate the effect of the most recent command. You can use the *OPC? Command to ensure that commands sent previously to the equipment have accomplished before executing a Serial Poll.

B.1.8.3 To read the Status Byte Using *STB?

The *STB? command is like a Serial Poll, but its process is like ASCII equipment command. The *STB? command's result is the same as a Serial Poll, but bit 6 won't be cleared once the conditions are still enabled.

The *STB? command will not be automatically handled by the IEEE-488 bus interface hardware and will be executed only after previous commands have accomplished. The *STB? command cannot clear an SRQ.

B.1.8.4 Using MAV (The Message Available) Bit

The Status Byte "Message Available" bit 4 can be used to determine if data can be read into your PC. The equipment continually clears bit 4 only after all messages are already read from the output buffer.

B.1.8.5 To Interrupt Your PC Using SRQ

1. Send a Device Clear message to return the function generator to a responsive state, and clear its output buffer.
2. Use the *CLS command to clear the event registers and error queue.
3. Set up the register masks using the *ESE command to configure the Standard Event enable register and the *SRE command to configure the Status Byte enable register.
4. Send the *OPC? command and read the result to verify synchronization.
5. Enable your PC's IEEE-488 SRQ interrupt.

B.1.8.6 To Determine as a Command Sequence is finished

1. Send a Device Clear message to return the function generator to a responsive state, and clear its output buffer.
2. Use the *CLS command to clear the event registers and error queue.
3. Execute the *ESE 1 command to enable the "Operation Complete" bit 0 in the Standard Event register.
4. Send the *OPC command and read the result to ensure synchronization.
5. Execute your command string to program the desired configuration and the *OPC command as the last command. When the command sequence is accomplished, the "Operation Complete" bit 0 is set in the Standard Event register.
6. Use a Serial Poll to check when bit 5, which is routed from the Standard Event register, is set in the Status Byte condition register. Then send *SRE 32 (Status Byte enable register, bit 5) to configure the function generator for an SRQ interrupt.

B.1.8.7 The Questionable Data Register

The Questionable Data register group provides information about the quality or integrity of the function generator. All of these conditions can be reported to the Questionable Data summary bit through the enable register. To set the enable register mask, you have to use the STAT:QUES:ENABLE command to write a decimal value to the register.

B.1.8.8 Bit Definitions – Questionable Data Register

Bit Number	Decimal Value	Definition
0. Voltage Overload	1	Voltage overload on OUTPUT connector. The Output has been disabled
1. Not Used	2	Not Used. Returns "0"
2. Not Used	4	Not Used. Returns "0"
3. Not Used	8	Not Used. Returns "0"
4. Not Used	16	Not Used. Returns "0"
5. Loop Unlocked	32	Function generator has lost phase lock. Frequency accuracy will be affected
6. Not Used	64	Not Used. Returns "0"
7. Not Used	128	Not Used. Returns "0"
8. Not Used	256	Error occurred during cal, or cal memory lost, or calibration is unsecured
9. External Reference	512	External timebase is being used
10. Not Used	1024	Not Used. Returns "0"
11. Not Used	2048	Not Used. Returns "0"
12. Not Used	4096	Not Used. Returns "0"
13. Not Used	8192	Not Used. Returns "0"
14. Not Used	16384	Not Used. Returns "0"
15. Not Used	132768	Not Used. Returns "0"

Please note that the registers will be cleared under the following conditions.

1. The Questionable Data event register is cleared when...
 - the *CLS command is executed.
 - using STAT:QUES:EVEN? command to query the event register.
2. The Questionable Data enable register is cleared when...
 - the power is on (the *PSC command doesn't apply).
 - the STAT:PRES command is executed.
 - the STAT:QUES:ENAB 0 command is executed.

B.2 Output Data Formats

Output data will be in one of formats shown in the table below.

Type of Output Data	Output Data Format
Non-reading queries	< 80 ASCII character string
Single reading (IEEE-488)	SD.DDDDDDDDESDD<nl>
Multiple readings (IEEE-488)	SD.DDDDDDDDESDD,...,<nl>
Single reading (RS-232)	SD.DDDDDDDDESDD<cr><nl>
Multiple readings (RS-232)	SD.DDDDDDDDESDD,...,<cr><nl>

S Negative sign or positive sign

D Numeric digits

E Exponent

<nl> newline character

<cr> carriage return character

B.3 Command Reference

-- A to F --

-- A --

AM:INTernal:

FUNction{SINusoid|SQUare|RAMP|NRAMP|TRIangle|USER}

Specify the modulating waveform for the modulation. This applies only when the modulating source is internal. Pulse nor dc can be a modulating waveform, but cannot be used as a carrier waveform. The default modulating waveform is a sine waveform.

AM:INTernal:

FUNCTION?

Query the modulating function in amplitude modulation. "SIN", "SQU", "RAMP", "NRAM", "TRI" or "USER" string indicating the modulating function will be returned.

--Ramp waveform has 100% symmetry

--Triangle waveform has 50% symmetry.

--Negative Ramp waveform has 0% symmetry.

--If an Arbitrary (USER) waveform is chosen to be the modulating waveform, it is automatically limited to one thousand points. Extra points are removed using decimation.

AM:INTernal:

FREQUENCY{<frequency>|MINimum|MAXimum}

Specify the frequency of the modulating waveform. This applies only when the modulating source is internal. The range is from 2 mHz to 20 kHz and the default is 100 Hz.

AM:INTernal:

FREQUENCY? [MINimum|MAXimum]

Query the internal modulating frequency. The frequency (in hertz) of the internal modulating waveform is returned.

AM:DEPTH {<depth in percent>|MINimum|MAXimum}

Specify the internal modulation depth (or "percent modulation") in percent. The range is from 0% to 120% and the default is 100%.

Notes:

- The modulation output of G5110A will not exceed $\pm 5V$ peak (into a 50 Ω load) even if the modulation depth is greater than 100%.

AM:DEPTH? [MINimum|MAXimum]

Query the modulation depth in amplitude modulation. The modulation depth (in

percent) is returned.

AM:SOURce {INTernal}

Specify the modulating signal source.

AM:SOURce?

Query the modulating source in amplitude modulation. "INT" string indicating the modulating source will be returned.

AM:STATe {OFF|ON}

Disable or Enable the amplitude modulation. The default is OFF.

To avoid multiple waveform changes, you can enable AM after setting the modulation parameters.

AM:STATe?

"0" (OFF) or "1" (ON) will be returned.

APPLY:SINusoid [<frequency> [,<amplitude > [,<offset>]]]

Output a sine wave with specific frequency, amplitude and offset. The waveform is output as soon as the command is executed.

APPLY:SQUare [<frequency> [,<amplitude > [,<offset>]]]

Output a square wave with specific frequency, amplitude and offset. The waveform is output as soon as the command is executed.

APPLY:RAMP [<frequency> [,<amplitude > [,<offset>]]]

Output a ramp wave with specific frequency, amplitude and offset. The symmetry is set automatically to 95%. The waveform is output as soon as the command is executed.

APPLY:PULSe [<frequency> [,<amplitude > [,<offset>]]]

Output a pulse wave with specific frequency, amplitude and offset. The waveform is output as soon as the command is executed. This command works with the current edge time setting and or pulse width setting, depending on which has been selected to "hold" (FUNC:PULS:HOLD command). However, the waveform generator will adjust the pulse width or the edge time to comply with the frequency restrictions for pulse waveforms.

APPLy:DC [<frequency | DEFault> [,<amplitude | DEFault> [,<offset>]]]

Output a dc voltage with the specified offset level. You can set the dc voltage to any value between $\pm 5\text{Vdc}$ into 50 ohms or $\pm 10\text{Vdc}$ into an open circuit. The waveform is output as soon as the command is executed. The specified frequency and amplitude have no effect on the pulse wave, but are remembered by the waveform generator and will be used on the next function you choose.

APPLy:USER [<frequency> [,<amplitude > [,<offset>]]]

Output an arbitrary waveform currently chosen by the FUNC:USER command with the specific frequency, amplitude and offset. The waveform is output as soon as the command is executed.

APPLy?

Query the current configuration and return a quoted string. The quoted string includes the function, frequency, amplitude and offset as in the following format:

"function frequency amplitude offset"

This command allows you to append this query response to an APPL: command in your programming application and use the result to place the waveform generator in the specified state.

-- B --

BURSt:MODE {TRIGgered}

Specify the burst mode. The default is Triggered mode. In the triggered mode, the waveform generator outputs a waveform with specified number of cycles (burst count) each time a trigger is received from the specified trigger source.

--The burst count, burst period and trigger source are for triggered burst mode only.

BURSt:MODE?

"TRIG" will be returned.

BURSt:NCYCles {<# cycles>|INFinity|MINimum|MAXimum}

Specify the number of cycles to be output in each burst (triggered burst mode only). The range is from 1 to 50,000 cycles in 1 cycle increments and the default is 1 cycle. The maximum value depends on the burst period and frequency as

shown below. Specify Infinite to generate a continuous burst waveform. When using the Immediate (Internal) trigger source (TRIG:SOUR IMM), the burst count must be less than the product of the maximum burst period and the waveform frequency:

Burst Count < Maximum period x Frequency.

-- The waveform generator will automatically increase the burst period up to its maximum value to accommodate the specified burst count, but it won't change the waveform frequency.

-- The burst count does not apply in the gated mode. However, if you specify a new burst count while in the gated mode, the waveform generator will remember it and use it when the triggered mode is selected.

BURSt:NCYCles?

The burst count will be returned. The range is from 1 to 50,000, and 9.9E+37 is returned if Infinite is specified.

BURSt:INTernal:PERiod {<seconds>|MINimum|MAXimum}

Specify the burst period for bursts with internal (immediate) trigger source. The burst period is ignored when manual trigger source is enabled. The range is from 1 μ s to 500 seconds and the default is 10 ms. The maximum value is 500 s, but the minimum value depends on the burst count and frequency as shown below:

BURSt:PERiod

BURSt:INTernal:PERiod? [MINimum|MAXimum]

The burst period in seconds will be returned.

BURSt:PHASe {<angle>|MINimum|MAXimum}

Specify the starting phase in degrees or radians according to UNIT:ANGL command. The range is from -360 degrees to +360 degrees (or from -2π to $+2\pi$ radians) and the default is 0 degree (0 radians).

--For sine, square and ramp waveforms, zero degrees are the point at which the waveform crosses zero volts or the dc offset in a positive going direction. For arbitrary waveform, it is the first waveform point downloaded to memory. The

burst phase has no effect on pulse waveform.

BURSt:PHASe? [MINimum|MAXimum]

The starting phase in degree or radians will be returned.

BURSt:STATe {OFF|ON}

Disable or enable the burst mode. To avoid multiple waveform changes, you can enable burst after setting the modulation parameters. The waveform generator allows only one of burst, sweep and modulations enabled at one time. As long as one is enabled, the other will be turned off.

BURSt:STATe?

"0" (OFF) or "1" (ON) will be returned.

-- C --

CALibration?

Perform a calibration using the specified calibration value (CALibration:VALue command). You need to enter a correct security code (see CALibration:SECure:STATe) before you can calibrate the waveform generator.

CALibration:COUNT?

Query the number of times the waveform generator has been calibrated. Note that your instrument was calibrated before it left the factory. Check the calibration count when you receive your waveform generator to determine its initial value.

CALibration:MVALue <value>

Is used with *cal:set* to set a count of the pos on the calibration procedures.

CALibration:MVALue? <pos>

Query a user-defined count of the pos on the calibration procedures.

CALibration:SAVE

Save user-defined value.

CALibration:SECure:CODE <new code>

Set a new security code. You have to first use the old security code to unsecure the waveform generator and then set a new security code. A security code may contain up to 12 characters and the first character must be a letter (A-Z). The rest of the characters can be any combination of numbers (0-9), letters and underscore character ("_").

CALibration:SECure:STATE {OFF|ON},<code>

Unsecure or secure the waveform generator for calibration.

CALibration:SECure:STATE?

Query the secured state of the waveform generator. Return "0" (OFF) or "1" (ON).

CALibration:SETup <0 | 1 | 2 | 3 | ... | 83>

Configure the waveform generator's internal state for each of the calibration step to be performed.

CALibration:SETup?

Query the calibration setup number. Return a value from "0" to "94".

CALibration:STRing<quoted string>

Record information about calibration. For instance, the name of the person who did the calibration, the date of the last calibration, or the date of next scheduled calibration. This information is stored in a non-volatile memory and newly recorded message will overwrite the previous one.

CALibration:STRing?

Query the information about the calibration. Return a quoted string.

CALibration:VALue<value>

Specify the value of the known calibration signal used by the calibration procedure.

CALibration:VALue?

Query the present calibration value. Return a number in the form of "+1.00000000000000E+01".

-- D --

DATA VOLATILE, <value>, <value>, ...

Download floating-point values from -1 to +1 into volatile memory. You can download from 1 to 8192 points per waveform. The waveform generator takes the specified number of points and expands them to fill waveform memory. If the specified number is less than 8,192, the waveform generator automatically generates a waveform with 8,192 points. If the specified number is more than 8,192, it would be decimated into 8,192 points.

- The values -1 and +1 correspond to the peak values of the waveform when the offset is zero volts.
- The maximum amplitude will be limited if the data points do not span the full range of the output DAC (Digital-to-Analog Converter).
- The DATA command overwrites the previous waveforms in volatile memory. If you need to save it, use DATA:COPY command to copy the waveform to non-volatile memory.
- Downloading floating-point values (using DATA VOLATILE) is slower than downloading binary values (using DATA:DAC VOLATILE) but is more convenient when using trigonometric functions which return values from -1 to +1.
- After downloading the waveform data to memory, use the FUNC:USER command to choose the active waveform and the FUNC USER command to output it.
- The following statement shows how to use the DATA command to download seven points to volatile memory.

```
DATA VOLATILE, 1, .67, .33, 0, -.33, -.67, -1
```

DATA:DAC VOLATILE, {<binary block>|<value>, <value>, ...}

Download binary or decimal integer values from -8191 to +8191 into volatile memory. You can download from 1 to 8,192 (8K) points per waveform in IEEE-488.2 binary block format or as a list of values. The range of values corresponds to the values available using internal 14-bit DAC (digital-to-Analog Converter) codes. The waveform generator takes the specified number of points and expands them to fill waveform memory. If you download less than 8,192 (8K) points, a waveform with 8,192 points will be automatically generated. If you download more than 8,192 points, it would be decimated into 8,192 points.

- The values -8191 and +8191 correspond to the peak values of the

waveform (if the offset is 0 volts). For example, if you set the output amplitude to 10 Vpp, "+8191" corresponds to +5V and "-8191" corresponds to -5V.

- The maximum amplitude will be limited if the data points do not span the full range of the output DAC (Digital-to-Analog converter). For example, the built-in sine wave does not use the full range of binary values between ± 1 and therefore its maximum amplitude is 6.087 Vpp (into 50 ohms).
- The **DATA:DAC** command overwrites the previous waveform in volatile memory (and no error will be generated). Use the **DATA:COPY** command to copy the waveform to non-volatile memory.
- The on-volatile memory can store up to four user-defined waveforms. Use DATA:CAT? Command to list all waveforms stored in volatile and non-volatile memory.
- After downloading the waveform data to memory, use the FUNC:USER command to choose the active waveform and the FUNC USER command to output it.
- The following statement shows how to use the DATA:DAC command to download seven integer points using the binary block format.

```
DATA:DAC VOLATILE, #214
```

- The following statement shows how to use the DATA:DAC command to download five integer points in decimal format.

```
DATA:DAC VOLATILE, 8191, 4096, 0, -4096, -8191
```

IEEE-488.2 Binary Block Format

In the binary block format, a block header precedes the data points. The block header follows the format below:

```
# 5 16384
```

"#" starts the data block. The second number represents the number of digits to follow and the third number represents the number of bytes to follow (16,384 bytes = 8,192 points).

A waveform data point is represented as a 16-bit integer sent in two bytes. Therefore, the total number of bytes is always twice the number of data points in the waveform (and must always be an even number). For example, 16,384 bytes are required to load a waveform with 8,192 points.

Use the FORM:BORD command to select the byte order for binary block

transfers. If you specify FORM:BORD NORM (the default setting), the most-significant byte (MSB) of each data point is sent first. If you specify FORM:BORD SWAP, the least-significant byte (LSB) of each data point is sent first. Most computers use the "swapped" byte order.

Notes:

- The values ± 8191 correspond to the peak values of the waveform (if the offset is 0 volts).
- The maximum amplitude will be limited if the data points do not span the full range of the output DAC (Digital-to-Analog converter). For example, the built-in sine wave does not use the full range of binary values between ± 8191 and thus its maximum amplitude is limited to 6.087 Vpp (into 50 Ω).
- The **DATA:DAC** command overwrites the previous waveform in the volatile memory (and no error will be generated). Use the **DATA:COPY** command to copy the waveform to non-volatile memory.

DATA:CATalog?

List all waveform names available for use. The names of the five built-in waveforms (in a non-volatile memory) and all user-defined waveforms (in a volatile memory) will be returned. "Volatile" will be returned when a built-in waveform is currently downloaded to volatile memory. To remove a waveform from volatile memory or any use-defined waveforms in a non-volatile memory, use DATA:DEL command.

DATA:NVOLatile:CATalog?

List the names of all user-defined arbitrary waveforms downloaded to non-volatile memory. Up to four waveform names will be returned. If there is no waveform currently downloaded, a null string "" will be returned. To remove any use-defined waveforms in a non-volatile memory, use DATA:DEL command.

DATA:NVOLatile:FREE?

Query the number of available slots for storing the user-defined waveforms.

DATA:DELeTe <arb name>

Remove the specific arbitrary waveform from memory. It can be the waveforms in volatile memory or the user-defined waveforms in a non-volatile memory.

You cannot delete an arbitrary waveform that is currently output, or an error will be generated.

DATA:DELeTe:ALL

Remove all user-defined waveforms from memory. All waveforms in volatile memory and user-defined waveforms in a non-volatile memory will be deleted, but the built-in waveforms in a non-volatile memory will not be deleted. You cannot delete an arbitrary waveform that is currently output, or an error will be generated.

DATA:ATTRibute:AVERAge? [<arb name>]

Query the arithmetic average of all data points for the specified waveform ($-1 \leq \text{average} \leq +1$). The default waveform is the currently active one (FUNC:USER command). If you query a waveform that is not stored in memory, an error "Specified arb waveform does not exist" will be generated.

DATA:ATTRibute:CFACTOR? [<arb name>]

Query the crest factor of all data points for the specified waveform. The crest factor represents the ratio of the peak value to the RMS value of the waveform. The default waveform is the currently active one (FUNC:USER command). If you query a waveform that is not stored in memory, an error "Specified arb waveform does not exist" will be generated.

DATA:ATTRibute:POINTs? [<arb name>]

Query the number of data points for the specified waveform. A value from 1 to 8,192 will be returned. The default waveform is the currently active one (FUNC:USER command). If you query a waveform which is not stored in memory, an error "Specified arb waveform does not exist" will be generated.

DATA:ATTRibute:PTPeak? [<arb name>]

Query the peak-to-peak value of all data points for the specified waveform. The default waveform is the currently active one (FUNC:USER command). A value from "0" to "+1.0" will be returned. "+1.0" indicates a full amplitude. The maximum amplitude will be limited if the data points do not span the full range of the output DAC (Digital-to-Analog converter). For example, the built-in sine wave does not use the full range of binary values between ± 1 and therefore its maximum amplitude is 6.087 Vpp (into 50 ohms). If you query a waveform that

is not stored in memory, an error "Specified arb waveform does not exist" will be generated.

DISPlay {OFF|ON}

Turn off or on the display. Disabling the front-panel display may speed up the command execution for remote interface operation. Remote interface error messages will be shown even when the display is off. Displaying a message on the front-panel display overrides the display state.

The display is automatically enabled when the waveform generator has been turned off or after *RST command, or when you return to local (front-panel) operation.

The display state is saved when you store the instrument state using *SAV command. Use *RCL command to recall the instrument state and the front-panel display will return to the previous state.

DISPlay?

Query the display setting. Returns "0" (OFF) or "1" (ON).

DISPlay:TEXT <quoted string>

Show a message on the front panel display. This command overrides the display state (DISP OFF command). The allowed message can be up to 12 characters in a large font and more characters in a small font; Any additional characters will be truncated.

With a message displaying on the front-panel display, information relating to the output waveform, such as frequency, is not shown on the display.

DISPlay:TEXT?

Query the message sent to the front panel display.

DISPlay:TEXT:CLEAr

Clear the message shown on the front panel display.

If the display is currently enabled, this command will clear the message on the front-panel display and return the normal front-panel display mode.

If the display is currently disabled, this command will clear the message on the display, but the display remains off.

-- F --

FM:INTernal:FUNction

{SINusoid|SQUare|RAMP|NRAMP|TRIangle|USER}

Specify the shape of the modulating waveform. This applies only when the modulation source is Internal (FM:SOUR INT command). Pulse nor dc can be a modulating waveform, but cannot be used as a carrier waveform. The default modulating waveform is a sine waveform.

FM:INTernal:FUNction?

Query the modulating function used in frequency modulation. "SIN", "SQU", "RAMP", "NRAM", "TRI" or "USER" string indicating the modulating function will be returned.

--Ramp waveform has 100% symmetry

--Triangle waveform has 50% symmetry.

--Negative Ramp waveform has 0% symmetry.

--If an Arbitrary(USER) waveform is chosen to be the modulating waveform, it is automatically limited to one thousand points. Extra points are removed using decimation.

FM:INTernal:FREQuency {<frequency>|MINimum|MAXimum}

Specify the frequency of the modulating waveform. This applies only when the modulating source is internal. The range is from 2 mHz to 20 kHz and the default is 10 Hz.

FM:INTernal:FREQuency? [MINimum|MAXimum]

Query the modulating frequency in frequency modulation. The modulating waveform frequency in hertz will be returned.

FM:DEVIation {<peak deviation in hertz>|MINimum|MAXimum}

Specify the peak frequency deviation in hertz. This value represents the peak variation in frequency of the modulated waveform from the carrier frequency. The range is from 1mHz to 150 kHz for ramps, from 1mHz to 1.55 MHz for arbitrary waveforms, from 1mHz to 7.55 MHz for sine or square waveforms, the default is 100 Hz. The minimum value is 1mHz, but the maximum value is calculated based on the frequency of the carrier waveform as below:

Maximum deviation = carrier frequency
if the carrier frequency is less than Maximum frequency/2
Maximum deviation = Maximum frequency – carrier frequency
if the carrier frequency is greater than Maximum frequency/2

The frequency deviation must not be greater than the carrier frequency. If a greater value is set to be the deviation, G5110 waveform generator will adjust it automatically to the maximum value allowed.

The sum of frequency deviation and the carrier frequency must not be greater than the maximum frequency of the function used plus 100 KHz (50.1 MHz for sine and for square, 300 kHz for ramp, and 3.1 MHz for arbitrary waveforms). If a greater frequency deviation is specified, the waveform generator will automatically adjust it to the maximum value allowed.

FM:DEVIation? [MINimum|MAXimum]

Query the peak frequency deviation in frequency modulation. The peak frequency deviation in hertz will be returned.

FM:SOURce {INTernal}

Specify the modulating signal source. The default is Internal.

FM:SOURce?

Query the modulating source in frequency modulation. "INT" string indicating the modulating signal source will be returned.

FM:STATe {OFF|ON}

Disable or Enable the frequency modulation. To avoid multiple waveform changes, you can enable it after setting up the modulation parameters. The waveform generator allows only one of burst, sweep and modulations enabled at one time. As long as one is enabled, the other will be turned off.

FM:STATe?

"0" (OFF) or "1" (ON) will be returned.

FORMat:BORDER {NORMal | SWAPped}

Used only for binary block transfers. Select the byte order for binary transfers in the block mode using the DATA:DAC command. The default is NORM.

In NORM byte order, the most significant byte (MSB) of each data point is assumed first.

In SWAP byte order, the least significant byte (LSB) of each data point is assumed first. Most computers use the "swapped" byte order.

The waveform generator represents binary data as signed 16-bit integers, which are sent as two bytes. Therefore, each waveform data point requires 16 bits, which must be transferred as two bytes on the waveform generator's interfaces.

FORMat:BORDER?

Query the byte order for binary transfers in the block mode. "NORM" or "SWAP" will be returned.

FREQuency:START {<frequency>|MINimum|MAXimum }

Specify the start frequency in Sweeps. The range is from 1mHz to 200 KHz for ramps, from 1mHz to 3 MHz for arbitrary waveforms, from 1mHz to 15 MHz for square and sine. The default is 100 Hz. The minimum value is 1mHz and the maximum value is independent for each function.

FREQuency:START? [MINimum|MAXimum]

The start frequency in sweeps will be returned.

FREQuency:STOP {<frequency>|MINimum|MAXimum }

Specify the stop frequency in Sweeps. The range is from 1mHz to 200 KHz for ramps, from 1mHz to 3 MHz for arbitrary waveforms, from 1mHz to 15 MHz for square and sine. The default is 1 KHz. The minimum value is 1mHz and the maximum value is independent for each function.

FREQuency:STOP? [MINimum|MAXimum]

The stop frequency in sweeps will be returned.

FREQuency:CENTer {<frequency>|MINimum|MAXimum }

Specify the center frequency in sweeps. The range is from 1mHz to 200 kHz for ramps, from 1mHz to 3 MHz for arbitrary waveforms, from 1mHz to 15 MHz for square and sine. The default is 550 Hz. The minimum value is 1mHz and the maximum value is calculated based on the frequency span and the maximum

frequency of the function used.

$$\text{Maximum center frequency} = \text{Maximum frequency} - \text{span}/2$$

FREQuency:CENTer? [MINimum|MAXimum]

The center frequency in sweeps will be returned in hertz.

FREQuency:SPAN{<frequency>|MINimum|MAXimum }

Specify the frequency span in sweeps. The range is from 0 Hz to 200 KHz for ramps, from 0 Hz to 3 MHz for arbitrary waveforms, from 1mHz to 15 MHz for square and sine. The default is 900 Hz. The minimum value is 0 Hz and the maximum value is calculated based on the center frequency and the maximum frequency of the function used.

$$\text{Maximum frequency span} = 2 \times (\text{Maximum frequency} - \text{center frequency})$$

--To sweep up in frequency, specify a positive frequency span.

--To sweep down in frequency, specify a negative frequency span.

The following equation shows the relationship between frequency span and start/stop frequency.

$$\text{Frequency span} = \text{Stop frequency} - \text{Start frequency}$$

FREQuency:SPAN? [MINimum|MAXimum]

The frequency span in hertz will be returned.

FSKey: FREQuency {<frequency>|MINimum|MAXimum}

Specify the FSK alternate (or "hop") frequency. The range is from 1mHz to 200 kHz for ramps, 1mHz to 3 MHz for arbitrary waveforms, from 1mHz to 15 MHz for square and sine, and the default is 100Hz.

FSKey: FREQuency? [MINimum|MAXimum]

Query the "hop" frequency in FSK. The "hop" frequency in hertz will be returned.

FSKey: INTernal:RATE {<rate in Hz>|MINimum|MAXimum }

Specify the rate at which the output frequency "shifts" between the carrier and the hop frequency. The range is from 2 mHz to 100 kHz and the default is 10 Hz. This FSK rate is used only when the FSK source is internal (FSK:SOUR INT).

--The modulating waveform is a square wave.

FSKey: INTernal:RATE? [MINimum|MAXimum]

Query the FSK rate. The FSK rate will be returned.

FSKey: SOURce {INTernal}

Specify the FSK source. The default is Internal.

FSKey: SOURce?

Query the FSK source. "INT" string indicating FSK source will be returned.

FSKey: STATe {OFF|ON}

Disable or enable FSK Modulation. The default is Off. To avoid multiple waveform changes, you can enable it after setting up the modulation parameters.



Only one type of modulation can be activated at one time. Also when FSK modulation is activated, sweep or burst mode will be disabled.

FSKey: STATe?

Query the FSK state. "0" (OFF) or "1" (ON) will be returned.

FUNCTION:PULSe:WIDTh {<seconds>|MINimum|MAXimum }

Specify the pulse width in seconds. The range is from 40 ns to 1000 seconds. The default is 100 μ s.

- The pulse width represents the time from the 50% threshold of the edge of the pulse to the 50% threshold of the next falling edge. 
- The minimum value of the pulse width is 40 ns and the maximum value is 999.99 seconds. 
- The minimum pulse width is restricted by the period as below:

$W_{min}=40$ ns when period is not greater than 10s.

$W_{min}=200$ ns when period is greater than 10 s, but not greater than 100s.

$W_{min}=2$ μ s when period is greater than 100 s, not greater than 1000s.

- The specified pulse width must be less than the difference between the period and the minimum pulse width.

$$\text{Pulse Width} \leq \text{Period} - W_{\text{min}}$$

The waveform generator adjusts width if necessary to accommodate the period. From the remote interface, a "Setting conflict" error is generated and the pulse width is adjusted.

- The specified pulse width must be less than the difference between the period and the edge time.

$$\text{Pulse Width} \leq \text{Period} - 40\text{ns}$$

The waveform generator adjusts the edge time first, and then the width if necessary to accommodate the period. From the remote interface, a "Data out of range" error is generated and the pulse width is adjusted.

- The specified pulse width must be greater than the total time of one edge:

$$\text{Pulse Width} \geq 40\text{ns}$$

- Among the pulse width, the FUNC:PULS:HOLD command determines which of them is to be held and it affects this function when the waveform generator adjusts the period.

FUNCTION:PULSe:WIDTh? [MINimum|MAXimum]

Query the pulse width. The pulse width in seconds will be returned.

FUNCTION:RAMP:SYMMetry {<percent> | MINimum|MAXimum }

Specify the symmetry percentage for ramp waves. Symmetry represents the amount of time per cycle that the ramp wave is rising (supposing the waveform polarity is not inverted). The range is from 5% to 95% and the default is 95%.

- The APPLY command overrides the current symmetry setting and used 95% symmetry.
- The specified symmetry is remembered and will be used when you change the function and then come back to ramp waves.
- The symmetry setting does not apply when you use a ramp wave as the modulating wave in AM or FM.

FUNCTION:RAMP:SYMMetry? [MINimum|MAXimum]

Query the current symmetry setting in percent.

FUNCTION:USER {<arb name> | VOLATILE}

Choose one of the five built-in arbitrary waveform functions, one of four user-defined waveforms, or the waveform currently downloaded to volatile memory.

The names of the five built-in arbitrary waveforms are "EXP_RISE", "EXP_FALL", "NEG_RAMP", "SINC", and "CARDIAC". The default is "EXP_RISE". If a waveform stored in volatile memory is desired, specify the VOLATILE parameter. This command does not output the chosen waveform. Use FUNCTION USER command to output the waveform.

If you specify a waveform name that is not currently downloaded, a "Specified arb waveform does not exist" error is generated.

FUNCTION:USER?

Query the selection of waveform specified by FUNCTION USER {<arb name> | VOLATILE} command.

FUNCTION USER

Select the arbitrary waveform function and output the current arbitrary waveform. The selected waveform is output using the current frequency, amplitude and offset settings. You can use the APPLY command or the FREQ, VOLT, and VOLT:OFFS commands to specify the frequency, amplitude, and offset.

The maximum amplitude will be limited if the data points do not span the full range of the output DAC (Digital-to-Analog converter). For example, the built-in sine wave does not use the full range of binary values between ± 1 and therefore its maximum amplitude is 6.087 Vpp (into 50 ohms).

When you use an arbitrary waveform as your modulating waveform ("USER"), the waveform is automatically limited to one thousand points. Extra waveform points are removed using decimation.

FUNCTION?

Query the selection made by FUNCTION USER command. One of the strings "SIN",

"SQU", "RAMP", "PULS", "DC", and "USER" will be returned.

-- I to O --

-- I --

***IDN?**

Query the waveform generator's identification string, which contains four fields separated by commas. The descriptions of these four fields are shown below:

Manufacturer's Name, Model Number, Serial Number, Revision Code

- The Revision code contains four numbers separated by dashes.

Firmware revision number-Book kernel revision number-ASIC revision number-Printed circuit board revision number

-- L --

***LRN?**

Query the waveform generator and return a string of SCPI commands containing the current settings (learn string). You can then send the string back to the instrument to restore this state later. For proper operation, do not modify the string before sending it back to the waveform generator. The string should contain about 1,500 characters. To avoid possible instrument errors, execute the *RST command first, and then send the string back to the waveform generator.

-- M --

MARKer {OFF | ON}

Disable or enable the frequency marker. The default is OFF. When the frequency marker is off, the signal output from the *Sync* connector is the normal Sync signal for the carrier waveform.

The OUTP:SYNC command is overridden by the setting of the MARK command, so when the marker frequency is turned on (and the sweep mode is also turned on), the OUTP:SYNC command is ignored.

MARKer?

"0" or "1" indicating the enable state of the frequency marker will be returned.

MARKer:FREQuency {<frequency> | MINimum | MAXimum}

Specify the marker frequency. The signal on the front-panel *Sync* connector goes to a logic low at the marker frequency during the sweep. The range is from 1mHz to 15 MHz (limited to 200 kHz for ramps and 3MHz for arbitrary waveforms) and the default is 500 Hz. The minimum value is the lower one of the start and stop frequencies and the maximum value is the higher one of the start and stop frequencies.

The marker frequency must be a value between the specified start and stop frequencies. If you select an out-of-range value, a "Settings conflict" error is generated and the waveform generator will automatically set it to either the start or the stop frequency depending on which is the closer one.

MARKer:FREQuency? [MINimum | MAXimum]

Query the marker frequency.

MEMory:STATe:NAME {1 | 2 | 3 | 4} [,<name>]

Assign a custom name for the specified storage location. You can assign a name to a location from either the front panel or the remote interface, but you can only recall a state by name from the front panel.

The custom name can contain up to 12 characters. The first character must be a letter (A-Z), but the remaining characters can be letters, numbers or the underscore character ("_"). Blank spaces are not allowed. Assigning the same name to different locations is allowed. You cannot assign a name to storage location "0" from the front panel.

MEMory:STATe:NAME? {1 | 2 | 3 | 4}

Query the name of the specified storage location. If the specified location has no custom name, its default name will be returned.

MEMory:STATe:DELeTe {1 | 2 | 3 | 4}

Erase the instrument state from the specified storage location, including the custom name specified to that location, if any, and restore the default name. You cannot recall the instrument state from a storage location that is empty or

an error will be generated.

MEMory:STATe:RECall:AUTO {OFF | ON}

This instrument doesn't support automatic recall of the power-down state. So it always returns "0" (OFF).

MEMory:STATe:RECall:AUTO?

This instrument doesn't support automatic recall of the power-down state. Therefore, it always returns "0" (OFF).

MEMory:STATe:RECall:SElect {0 | 1 | 2 | 3 | 4}

Select power-on state from stored state when power is turned on. The default is "0" (the default state).

MEMory:STATe:RECall: SElect?

Query the power-on state when power is turned on. The value 0 ~ 4 will be returned. 0: default state, 1: state 1, 2: state 2, 3: state 3, 4: state 4

MEMory:STATe:VALid? {1 | 2 | 3 | 4}

Query the specified storage location to determine if it currently stores a valid instrument state. "0" is returned when there is no valid state stored in that location and "1" is returned when there is a valid state stored in that location.

MEMory:NStates?

Query the number of storage locations available for storing the states. "4" is returned.

-- O --

***OPC**

Set the "Operation complete" bit (bit 0) in the Standard Event Register after all of the previous commands have been completed. Other commands may be executed before the bit is set. This command is used in the triggered sweep or triggered burst modes to provide a way to poll or interrupt the computer when the *TRG command is complete.

***OPC?**

Returns "1" to the output buffer after the previous commands have been completed. Other commands cannot be executed until this command completes.

OUTPut {OFF|ON}

Disable or enable the Output connector on the front panel. The default is OFF. The Output key is lit when enabled.

- The APPLY command overrides the current OUTP command setting and automatically enables the Output connector.
- The Output connector will be disabled when an excessive external voltage is applied to it. To re-enable it, remove the excessive voltage and use this command to enable it again.
- This command changes the state of the output connector by switching the output relay. However, this command does not zero the voltage to be output before switching the relay. Thus, the output signal may have "glitches" for about a millisecond until the signal stabilizes. You can minimize these glitches by first setting the amplitude to the minimum (using the VOLTage command) and the offset to zero (using the VOLTage:OFFSet command) before changing the output state.

OUTPut?

"0" or "1" indicating the on/off state of the Output connector on the front panel is returned.

OUTPut:LOAD {<ohms>|INFinity|MINimum|MAXimum}

Select the desired output termination. It can be any value (in ohms) between 1 Ω and 10k Ω . INF sets the output termination to "high impedance" (>10 k Ω). The default is 50 Ω . The specified value is used for amplitude, offset, and high/low level settings.

- When the output termination is changed, the displayed output amplitude, offset, and high/low levels are automatically adjusted, and no errors will be generated.
- The waveform generator has a fixed series output impedance of 50 ohms to the front-panel Output connector. If the actual load impedance is different than the specified value, the displayed amplitude, offset and high/low levels will be incorrect.

- When the output termination is set to “high impedance”, you cannot specify the output amplitude in dBm. The unit will be automatically converted to Vpp.

OUTPut:LOAD? [MINimum|MAXimum]

Query the current load setting in ohms. Return the current load setting or “9.9E+37” meaning “high impedance”.

OUTPut:POLarity { NORMal|INVerted }

Invert the waveform relative to the offset voltage. The default is NORM, in which the waveform goes positive during the first part of the cycle and in INV mode the waveform goes negative during the first part of the cycle. The offset remains the same when the waveform is inverted and the Sync signal is not inverted.

OUTPut:POLarity?

Query the polarity of the waveform. “NORM” or “INV” indicating the polarity will be returned.

OUTPut:SYNC {OFF|ON}

Disable or enable the Sync connector on the front-panel. The default is ON. By disabling the Sync signal, you can reduce the output distortion at lower amplitude. When the Sync signal is disabled, the output level on the Sync connector is a logic “low” level.

- When a waveform is inverted, its Sync signal is not inverted.
- This command is overridden by the setting of the MARK command used with the sweep mode, therefore when the marker frequency is enabled (and the sweep is enabled too), the OUTP:SYNC is ignored.

OUTPut:SYNC?

“0” or “1” indicating the enable state of the Sync connector on the front panel will be returned.

-- P to Z --

-- P --

PHASe {<angle> | MINimum | MAXimum}

Adjust the phase offset of the output waveform in degrees or radians as

specified by the previous UNIT:ANGL command (not available for pulse). The range is from -360 degrees to 360 degrees or -2π to $+2\pi$ radians. The default is 0 degrees.

- The specified phase adjustment causes a “bump” or “hop” in the output waveform in order to change the phase relationship to the external signal to which it is currently locked.
- The phase adjustment for phase-lock applications is independent of the burst phase as set by the BURS:PHAS command.

PHASe [MINimum | MAXimum]

Query the phase offset in degree or radians.

PHASe:REFerence

Set the zero-phase reference point immediately without changing the output. This command changes the phase reference only, and it does not change the phase offset as set with the PHAS command.

PHASe:UNLock:ERRor:STATe {OFF | ON}

Disable or enable the waveform generator to generate an error when the phase-lock is lost. The default is off. When the error is enabled, and the phase-lock is lost, a “Reference phase-lock loop is unlocked” error will be generated. The error setting is cleared after the waveform generator has been turned off.

PHASe:UNLock:ERRor:STATe?

Query the enable state of the lost phase-lock error.

PM:INTernal:FUNCTion

{SINusoid|SQUare|RAMP|NRAMP|TRIangle|USER}

Specify the shape of the modulating waveform. This applies only when the modulation source is Internal (PM:SOUR INT). Pulse nor dc can be a modulating waveform, but cannot be used as a carrier waveform. The default modulating waveform is a sine waveform.

--Ramp waveform has 100% symmetry

--Triangle waveform has 50% symmetry.

--Negative Ramp waveform has 0% symmetry.

--If an Arbitrary (USER) waveform is chosen to be the modulating waveform, it is automatically limited to one thousand points. Extra points are removed using decimation.

PM:INTernal:FUNction?

Query the modulating function used in phase modulation. "SIN", "SQU", "RAMP", "NRAM", "TRI" or "USER" string indicating the modulating function will be returned.

PM:INTernal:FREQuency {<frequency>|MINimum|MAXimum}

Specify the modulating waveform frequency. This applies only the modulation source is internal (PM:SOUR INT). The range is from 2 mHz to 20 kHz and the default is 10 Hz.

PM:INTernal:FREQuency? [MINimum|MAXimum]

Query the internal modulating frequency in Phase modulation. The internal modulating frequency in hertz will be returned.

PM:DEVIation {<peak deviation in hertz>|MINimum|MAXimum}

Specify the phase deviation in degrees. Phase deviation represents the peak variation in phase of the modulated waveform from the carrier waveform. The range is from 0 to 360 degrees and the default is 180 degrees.

PM:DEVIation? [MINimum|MAXimum]

Query the phase deviation in phase modulation. The phase deviation in degree will be returned.

PM:SOURce {INTernal}

Specify the modulating signal source. The default is INTernal.

PM:SOURce?

Query the modulating source in phase modulation. "INT" string indicating the modulating source will be returned.

PM:STATe {OFF|ON}

Disable or enable Phase Modulation. The default is Off. To avoid multiple waveform changes, you can enable it after setting up the modulation

parameters.

Only one type of modulation can be activated at one time. Also when Phase modulation is activated, sweep or burst mode will be disabled.

PM:STATE?

"0" (OFF) or "1" (ON) will be returned.

PWM:INTernal:FUNction

{SINusoid|SQUare|RAMP|NRAMP|TRIangle|USER}

Specify the shape of the modulating waveform. The default is sine. This applies when the modulation source is internal (PWM:SOUR INT). The carrier is  wave in PWM.

--Ramp waveform has 100% symmetry

--Triangle waveform has 50% symmetry.

--Negative Ramp waveform has 0% symmetry.

--If an Arbitrary (USER) waveform is chosen to be the modulating waveform, it is automatically limited to one thousand points. Extra points are removed using decimation.



PULSe:PERiod {<seconds> | MINimum | MAXimum}

Specify the pulse period. The range is from 200 ns to 1000 seconds. The default is 1 ms.

- The specified period must be greater than the sum of the pulse width and the edge time, if not, the waveform generator automatically adjust the edge time first and the pulse width (if needed) to accommodate the period.

$$\text{Period} \geq \text{Pulse Width} + 40\text{ns}$$

- The specified period stays when the function changes. If you select pulse waveform and specify the period by PULS:PER command, and then choose another function, the period will be used on the new function.
- If you change to a function whose minimum period is greater than that for a pulse waveform, the period is adjusted to the minimum value allowed for the new function. For example, if you output a pulse waveform with a period of 200 ns and then change to the ramp function, the waveform generator will automatically adjust the period to 5 μ s (the lower limit for ramps). A "Settings conflict" error will be generated and the period will be

adjusted.

PULSe:PERiod? [MINimum | MAXimum]

The period of the pulse waveform will be returned in seconds.

PWM:INTernal:FUNction?

Query the modulating function used in PWM. "SIN", "SQU", "RAMP", "NRAM", "TRI" or "USER" string indicating the modulating function will be returned.

PWM:INTernal:FREQuency {<frequency> | MINimum | MAXimum}

Specify the modulating waveform frequency. This applies only when the modulation source is internal (PWM:SOUR INT). The range is from 2 mHz to 20kHz and the default is 10 Hz.

PWM:INTernal:FREQuency? [MINimum | MAXimum]

Query the internal modulating frequency in PWM. The internal modulating frequency in hertz will be returned.

PWM:DEViation {< deviation in seconds> | MINimum | MAXimum}

Specify the pulse width deviation in seconds. Pulse width deviation represents the variation in seconds from the pulse width of the carrier pulse width. The range is from 0 to 1000 seconds and the default is 10 μ s. The pulse width deviation cannot exceed the current pulse width. The minimum value is 0 seconds and the maximum value is determined by period, minimum pulse width and edge time.

Here is the constraints pulse width deviation has to conform:

$$\text{Width Deviation} \leq \text{Pulse Width} - W_{\text{min}}$$

And

$$\text{Width Deviation} \leq \text{Period} - \text{Pulse Width} - W_{\text{min}}$$

Where:

$$W_{\text{min}} = 20 \text{ ns for period} \leq 10 \text{ s.}$$

$$W_{\text{min}} = 20 \text{ ns for period} > 10 \text{ s, but} \leq 100 \text{ s.}$$

$$W_{\text{min}} = 2 \mu\text{s for period} > 100 \text{ s, but} \leq 1000 \text{ s.}$$

Also

$$\text{Width Deviation} \leq \text{Pulse width} - 40\text{ns}$$

And

Width Deviation \leq Period - Pulse width - 40ns

Note: The operation of this command is affected by FUNC:PULS:HOLD command. FUNC:PULS:HOLD command decides if the pulse width is to be held constant as the period varies. If the pulse width is held constant, so is the pulse width deviation; if one is held constant, the other specified in the command will be automatically converted to the equivalent value.

PWM:DEVIation? [MINimum|MAXimum]

Query the pulse width deviation. The pulse width deviation in seconds will be returned.

PWM:SOURce?

Query the modulating source in PWM. "INT" string indicating modulating source will be returned.

PWM:STATe {OFF|ON}

Disable or enable PWM. The default is Off. To avoid multiple waveform changes, you can enable it after setting up the modulation parameters.

Only one type of modulation can be activated at one time. Also when PWM is activated, sweep or burst mode will be disabled. PWM is allowed only when pulse is used.

PWM:STATe?

Query the PWM state. "0" (OFF) or "1" (ON) will be returned.

-- R --

REFerence:TIMEbase:STATe ON | OFF

Disable or Enable the timebase function. The default is OFF.

REFerence:TIMEbase:OUTPut ON | OFF

Disable or Enable the timebase 10MHz output. The default is OFF.

REFerence:TIMEbase:MODE INT | EXT | AUTO

Force to use [INT]Internal 10MHz reference or [EXT]External timebase

10MHz In as the system clock reference, or [AUTO]to automatically switch the clock reference, when a legal signal input from Timebase. In connector, system uses it as clock reference, otherwise, use the internal 10MHz oscillator as clock reference. The default is AUTO.

REFerence:TIMEbase:MODE?

Show what the Timebase's mode is.

REFerence:TIMEbase:OUTPut ?

Show the 10Mout's state.

REFerence:TIMEbase:STATe?

Show the Timebase's state.

***RCL {1 | 2 | 3 | 4}**

Recall the instrument state previously stored in the non-volatile storage location.

- Storage location 0 stores the waveform generator's power-on state and storage location 1 to 4 are empty when the instrument is shipped out from the factory.
- You cannot recall a state from a storage location which is empty.
- Storage location 0 is automatically overwritten when the power is cycled.

***RST**

Reset the waveform generator to its factory default, independent of the MEM:STAT:REC:AUTO command setting. This command does not affect any stored instrument states, arbitrary waveforms, or the I/O settings. It also enables the front-panel display if it has been turned off. This command will abort a sweep or burst in progress.

-- S --

***SAV {1 | 2 | 3 | 4}**

Store the current instrument state to the specified non-volatile storage location.

- If there is any instrument state stored in the specified location, it will be overwritten.
- You can store an instrument state into location 0 only from the remote

interface. It is not accessible from the front panel.

- Storage location 0 is automatically overwritten when the power is cycled.
- If you store the instrument state for an arbitrary waveform and then delete it later, the waveform data is lost and the waveform generator is not able to output the waveform.
- When you store an instrument state, the selected function, frequency, amplitude, dc offset, symmetry, as well as any modulation parameters are saved also.

***TST?**

Order a complete self-test of the waveform generator. Return "0" when the test runs successfully or "1" when the test fails.

SWEep:SPACing {LINear | LOGarithmic | User}

Specify the spacing for the sweep. The default sweep mode is Linear, which waveform generator sweeps the frequency with spacing calculated in a linear function. In the logarithmic sweep mode, the waveform generator sweeps with spacing calculated in a logarithmic function. In the user mode, users can switch the sweep shape to the arbitrary waveform.

SWEep:SPACing?

Query the spacing used in sweeps. "LIN", "LOG", or "USER" string indicating the spacing will be returned.

SWEep:TIME {<seconds> | MINimum | MAXimum}

Specify the time duration in seconds to sweep from the start frequency to the stop frequency. The range is from 1 ms to 500 seconds and the default is 1 second.

The number of discrete frequency points in the sweep will be calculated according to the specified sweep time.

SWEep:TIME?

Query the sweep time. The sweep time in seconds will be returned.

SWEep:STATE{OFF | ON}

Disable or enable the sweep mode. The default is Off. To avoid multiple

waveform changes, you can enable it after setting up the modulation parameters.

Only one type of modulation can be activated at one time. Also when Sweep is activated, modulation or burst mode will be disabled.

SWEEp:STATe?

Query the sweep state. "0" (OFF) or "1" (ON) will be returned.

SYSTem:ERRor?

Query and clear one error from the waveform generator's error queue. Up to 30 errors can be stored in the queue. Errors are retrieved in first-in-first-out (FIFO) order. Each error string may contain up to 255 characters. The waveform generator beeps every time it detects an error unless the beeper is turned off. Errors are cleared once you read them.

If more than 30 errors are detected, "too many Errors" show up in the error queue. Unless user read the errors in the queue, the additional errors will not be stored. If there is no error in the error queue when you read it, "No error" string will be displayed.

SYSTem:BEEPer

Issue a single beeping tone.

SYSTem:BEEPer:STATe {OFF|ON}

Disable or enable the beeper.

SYSTem:BEEPer:STATe?

Query the beeper state. Return "0" (OFF) or "1" (ON).

SYSTem:COMMunicate:RLSTate {LOCAL | REMote | RWLock}

Set the remote/local state of the waveform generator over the LAN interface from a Telnet or socket session. Provides control analogous to the IEEE-488.2 commands such as GTL (Go To Local) over the GPIB and USB interfaces. The default is Local which sets the instrument state to local and removes any annunciator and locks the front-panel keyboard. The Remote parameter sets the instrument state to remote, displaying the annunciators, and locks the keyboard. The RWLock parameter sets the instrument state to remote with lock, and

displays the rwl annunciator and locks the keyboard.

SYSTem:VERSion?

Query the waveform generator's current SCPI version. A string in the form of "YYYY.V" will be returned. "YYYY" represents the year of the version and "V" represents the version number.

SYSTem:KLOCK[:STATe] {OFF | ON}

Disable or enable the front panel keyboard lock. The default is OFF (meaning the lock is off). When the lock is on, the front panel keyboard is locked. You can exclude "local" key when locking the front panel keyboard by using SYST:KLOC:EXCL LOC before you lock the keyboard.

SYSTem:KLOCK:EXCLude {NONE | LOCAL}

Specify if locking the front panel keyboard including the "local" key or excluding the "local" key.

SYSTem:KLOCK:EXCLude?

Query which key is excluded when locking the front panel keyboard.

SYSTem:SECurity:IMMediate

Clears all instrument memory except for the boot parameters and calibration constants. Reset all instrument setting to their *RST values. This command clears all user-defined state information, user-defined arbitrary waveforms, and user-defined I/O settings. This command is usually used to clear all memory for security purpose, therefore it is not recommended for use in routine applications because of the possibility of unintended loss of data.

-- T --

TRIGger

Issue an immediate trigger from the remote interface. This command can trigger a sweep or burst with any available trigger source (TRIG:SOUR IMM | BUS).

TRIGger:SOURce {IMMediate | BUS}

Specify a trigger source for the triggered burst mode only. The waveform

generator accepts a software (BUS) trigger, an immediate (internal) trigger. The default is IMM.

- When using the Immediate (internal) source, the frequency at which the burst is generated is determined by the burst period.
- When using the Bus (software) trigger source, the waveform generator outputs one burst each time it receives a bus trigger command. Use *TRG to trigger from the remote interface. The *Trigger* button is lit when the waveform generator is waiting for a trigger.
- The APPLY automatically sets the trigger source to be Immediate.
- When the Bus source is selected, the burst count and the burst phase remain in effect, but the burst period is ignored.
- To ensure synchronization when the Bus source is selected, send the *WAI (wait) command. When the *WAI command is executed, the waveform generator waits for all pending operations to complete before executing any additional commands. For example, the following command string guarantees that the first trigger is accepted and the operation is executed before the second trigger is recognized.

```
TRIG:SOUR BUS;*TRG;*WAI;*TRG;*WAI
```

- You can use the *OPC? (operation complete query) command or the *OPC (operation complete) command to signal when the burst is complete. The *OPC? Command returns "1" to the output buffer when the burst is complete. The *OPC command sets the "Operation Complete" bit (bit 0) in the Standard Event register when the burst is complete.

TRIGger:SOURce?

Query the trigger source. "IMM" or "BUS" string indicating the trigger source will be returned.

-- U --

UNIT:ANGLE {DEGREE | RADIAN}

Specified the unit of the starting phase for the burst with the BURS:PHAS command. The default is DEG. Radians are not available from the front panel, so if switching to the front panel operation after using radians on the remote interface operation, the waveform generator automatically converts the unit back to degrees for you.

UNIT:ANGLE?

"DEG" or "RAD" indicating the unit of the starting phase for the burst will be returned.

-- V --

VOLTage {<amplitude> | MINimum | MAXimum}

Specify the output amplitude. The minimum value is 10 mVpp into 50Ω and the maximum value is the largest amplitude for the chosen function (at most 10 Vpp into 50Ω depending on the chosen function and the offset voltage).

- The output amplitude and offset voltage are related to Vmax as shown below:

$$|V_{\text{offset}}| + V_{\text{pp}} \div 2 \leq V_{\text{max}}$$

Where Vmax is the maximum peak voltage for the selected output termination (5 volts for a 50Ω load or 10 volts for a high-impedance load), the function generator will take the new specified output amplitude, but the offset voltage may be reduced accordingly, and a "Settings conflict" error is generated.

- Output Termination Limits: When the Output Termination Setting is changed, the Output Amplitude is automatically adjusted. For instance, when you change the output termination from 50 ohms to "high impedance", your offset voltage doubles, thus it affects your output amplitude, and when Output Termination has been changed from "high impedance" to 50 ohms, the offset voltage decreases by half.
- Output amplitude in dBm is not available when the output termination is set to "high impedance". The units will be Vpp.
- For arbitrary waveforms, if the waveform data points do not span the full range of output DAC (Digital-to-Analog Converter), the maximum offset and amplitude will be limited.
- Setting a high level and low level is another way to specify the output amplitude. For instance, you will have an amplitude of 5 Vpp (with an associated offset voltage of -500 mV) when you set your high level to +2 Vpp and low level to -3 Vpp.
- While changing amplitude, you may notice a momentary disruption in the output waveform at certain voltages due to switching of the output attenuators. The amplitude is controlled, however, so the output voltage will never exceed the current setting while switching ranges. You may use

the VOLT:RANG:AUTO command to disable the voltage autoranging to prevent this output disruption.

- To output a dc voltage level, select the dc voltage function using the FUNC DC command and then set the offset voltage level using the VOLT:OFFS command. You can set the dc level to any value between ± 5 Vdc into 50 ohms or ± 10 Vdc into an open circuit.

VOLTage? [MINimum | MAXimum]

Query the output amplitude for the current function. The value is returned in the unit chosen by the VOLT:UNIT command.

VOLTage:OFFSet {<offset> | MINimum | MAXimum}

Specify the dc offset voltage. The default is 0 volts. The minimum value is the most negative dc offset for the chosen function and amplitude and the maximum value is the largest dc offset for the chosen function and amplitude.

- The output amplitude and offset voltage are related to V_{max} as shown below:

$$|V_{offset}| + V_{pp} \div 2 \leq V_{max}$$

Where V_{max} is the maximum peak voltage for the selected output termination (5 volts for a 50 Ω load or 10 volts for a high-impedance load). The function generator will take the new specified output amplitude, but the offset voltage may be reduced accordingly, and a "Settings conflict" error is generated.

- When the Output Termination Setting is changed, the offset limits are automatically adjusted. For instance, when you change the output termination from 50 ohms to "high impedance", your offset voltage doubles, thus it affects your output amplitude, and when Output Termination has been changed from "high impedance" to 50 ohms, the offset voltage decreases by half.
- For arbitrary waveforms, if the waveform data points do not span the full range of output DAC (Digital-to-Analog Converter), the maximum offset and amplitude will be limited.

Setting a high level and low level is another way to specify the offset. For instance, you will have an amplitude of 5 Vpp (with an associated offset voltage of -500 mV) when you set your high level to +2 Vpp and low level to -3 Vpp.

VOLTage:OFFSet? [MINimum | MAXimum]

Query the dc offset voltage for the current function.

VOLTage:HIGH {<voltage> | MINimum | MAXimum}

Specify the high voltage level. The default high level for all functions is +50 mV. The minimum value is the most negative voltage level and the maximum value is the largest voltage level for the chosen function.

- The high and low voltage level must conform the following restriction:

$$V_{\text{high}} - V_{\text{low}} \leq V_{\text{pp}} (\text{max}) \quad \text{and} \quad V_{\text{high}}, V_{\text{low}} \leq V_{\text{pp}} (\text{max})/2$$

Where $V_{\text{pp}} (\text{max})$ is the maximum peak-to-peak amplitude for the chosen output termination (10 Vpp for a 50-ohm load or 20 Vpp for a high-impedance load). If you specify an invalid voltage level, the waveform generator will adjust it automatically to the highest allowed value and "Data out of range" error is generated.

- The high voltage level should always be greater than the low level. If not, a "Setting conflict" error is generated and the waveform generator automatically set the high level to 1 mV larger than the specified low level.
- specifying a high level and low level also sets the offset. For instance, you will have an amplitude of 5 Vpp (with an associated offset voltage of -500 mV) when you set your high level to +2 Vpp and low level to -3 Vpp.
- When the Output Termination Setting is changed, the voltage levels are automatically adjusted. For instance, when you change the output termination from 50 ohms to "high impedance", your voltage shown on the display doubles, and when Output Termination has been changed from "high impedance" to 50 ohms, the voltage decreases in half.
- To invert the waveform relative to the offset voltage, you can use the OUTP:POL command.

VOLTage:HIGH? [MINimum | MAXimum]

Query the high voltage level.

VOLTage:LOW {<voltage> | MINimum | MAXimum}

Specify the low voltage level. The default low level for all functions is -50 mV. The minimum value is the most negative voltage level and the maximum value is the largest voltage level for the chosen function.

- The high and low voltage level must conform the following restriction:
 $V_{high} - V_{low} \leq V_{pp} (max)$ and $V_{high}, V_{low} \leq V_{pp} (max)/2$

Where $V_{pp} (max)$ is the maximum peak-to-peak amplitude for the chosen output termination (10 Vpp for a 50-ohm load or 20 Vpp for a high-impedance load). If you specify an invalid voltage level, the waveform generator will adjust it automatically to the highest allowed value and "Data out of range" error is generated.

- The high voltage level should always be greater than the low level. If not, a "Setting conflict" error is generated and the waveform generator automatically set the high level to 1 mV larger than the specified low level.
- specifying a high level and low level also sets the offset. For instance, you will have an amplitude of 5 Vpp (with an associated offset voltage of -500 mV) when you set your high level to +2 Vpp and low level to -3 Vpp.
- When the Output Termination Setting is changed, the voltage levels are automatically adjusted. For instance, when you change the output termination from 50 ohms to "high impedance", your voltage shown on the display doubles, and when Output Termination has been changed from "high impedance" to 50 ohms, the voltage decreases in half.

To invert the waveform relative to the offset voltage, you can use the OUP:POL command.

VOLTage:LOW? [MINimum | MAXimum]

Query the low voltage level.

VOLTage: RANGE:AUTO{OFF | ON | ONCE}

Disable or enable the voltage auto-ranging. The default is "On" where the waveform generator selects an optimal setting for the output amplifier and attenuators. When the auto-ranging is "Off", the current setting is used.

- The "ONCE" parameter enables the auto-ranging, selects an optimal setting and then disables it.
- The APPLY command overrides this command and turns the auto-ranging on.
- Disabling the auto-ranging can avoid momentary disruption caused by attenuators switching while changing amplitudes. However, the amplitude and offset accuracy may be adversely affected when reducing the amplitude below the expected range change.

VOLTage: RANGe:AUTO?

"0" (off) or "1" (on) indicating the auto-ranging enable state is returned.

VOLTage:UNIT {VPP | VRMS | DBM}

Select the unit of the output amplitude. The default is VPP. The waveform generator used the same unit for front panel and the remote interface, so the front panel display in the unit that you select from remote interface.

If you don't specify the unit in the APPLY or VOLT commands, the function generation uses the unit specified in this command.

When the output termination is set to "high impedance", you cannot specify the output amplitude in dBm. The unit will be automatically converted to Vpp.

VOLTage:UNIT?

Query the unit of the output amplitude. "VPP", "VRMS" or "DBM" will be returned.

-- W --

***WAI**

Wait for all pending operation to complete before executing any additional commands over the interface.

B.4 SCPI Compliance Information

This section encloses a list of commands that are device-specific to G5110A. Although not included in the 1999.0 version of the SCPI standard, these commands are designed with the SCPI format in mind and they follow all of the syntax rules of the standard.

Many of the required SCPI commands are accepted by the waveform generator but are not described in this manual for simplicity or clarity. Most of these non-documented commands duplicate the functionality of a command already described in this chapter.

B.5 IEEE-488 Compliance Information

The SCPI commands used in G5110A are in conformance with the SCPI standard Version 1992.0. The common commands are listed below:

*CLS
*ESE<NRf>
*ESE?
*ESR?
*IDN?
*LRN?
*OPC
*OPC?
*PSC {0|1}
*PSC?
*RCL<0 | 1 | 2 | 3 | 4>
*RST
*SAV<0 | 1 | 2 | 3 | 4>
*SRE<NRf>
*SRE?
*STB?
*TRG
*TST?
*WAI

B.6 Using Device Clear to Halt Measurements

Device Clear is a special IEEE-488 low-level bus message. It is used to return the waveform generator to a responsive state. Different programming languages and IEEE-488 interface cards provide their own special commands to perform this function. The status registers, the error queue, and all configuration states are left intact when a device clear is performed. In particular, device clear performs the following actions:

- The input and output buffers are cleared.
- An overlapped command, if any, will be terminated without "Operation Complete" indication (applies to the *TRG command).
- Any sweep or burst in progress will be immediately aborted.
- Get the waveform generator ready to accept a new command string.

C. General Specifications

item	Limitation & description
Power Supply Voltage	100V/240V 50Hz~60Hz
Power Consumption	30 VA Maximum
Operating Humidity	1) 0 °C/30%RH 2) 18 °C/40%RH 3) 23 °C/40%RH 4) 28 °C/40%RH 5) 35 °C/80%RH 6) 50 °C/30%RH
Operating Environment	0 to 55 °C
Storage Temperature	- 30 °C to 70 °C
Operating Altitude	Up to 2000m
Bench Dimensions (WxHxD)	290mm x 107mm x 230mm
Weight	2.14 kg
Safety	EN61010-1:2010/IEC61010-1:2010 (3 rd Edition) EN61010-2-030:2010/IEC61010-2-030:2010(1 st Edition) used in conjunction with EN61010-1:2010/IEC61010-1:2010 (3 rd Edition)
EMC	EN61326-1:2006 EN61326-2-1:2006 Emission: CISPR 11:2009 +A1:2010 (Class A) EN61000-3-2:2006 +A1:2009 +A2:2009 EN61000-3-3:2008 Immunity: IEC61000-4-2:2008 IEC61000-4-3:2010 IEC61000-4-4:2011 IEC61000-4-5:2005 IEC61000-4-6:2008 IEC61000-4-11:2004

D. Application Programs

This chapter contains several remote interface example programs to help you develop programs for your own application. "Remote Interface Reference" starting lists the syntax for the SCPI (*Standard Commands for Programmable Instruments*) commands available to program the function generator.

Introduction

Five example programs are included in this chapter to demonstrate controlling the PICOTEST G5110A using SCPI commands. All of these programs are written in Microsoft® Visual C++® 6.0 and use the NI-VISA.

If you want to modify the example programs, or write your own programs and compile them, you will need to install the NI-VISA.

- If you are using GPIB, the software should have been loaded when you installed your GPIB interface card in your PC.
- If you are using USB or LAN, you must have NI-VISA version to support USB and LAN.

Microsoft® and Visual C++® 6.0 are U.S. registered trademarks of Microsoft Corporation.

All of the sample application programs in this chapter are example programs intended for use with Microsoft Visual C++ 6.0 and the NI-VISA by USB.

To use VISA in another Visual C++ project, you have to set the environmental variable in Microsoft Visual C++ 6.0. The procedures are in the following.

- In the VC++, after the path Tools\Options\Directories\include has been entered, you have to add an "Include" path offered by NI-VISA, such as
C:\VXIPNP\WinNT\include.
- Add C:\VXIPNP\WinNT\lib\msc\visa32.lib to Project folder.

The command for USB interface in the following or others will be different on other unit. If you have to check the right information, please do the procedure of Utility/IO/Show USB Id (for USB interface) to get it.

```
char instrDesc[]="USB0::5710::5110::TW00009001::INSTR";
```

If the communication is via GPIB or LAN interface, you have to revise the following USB command 1). to be GPIB 2). or LAN 3). one.

- 1). char instrDesc[]="USB0::5710::5110::TW00009001::INSTR";
- 2). char instrDesc[]="GPIB0::10:: INSTR"; //GPIB control,Address:10
- 3). char instrDesc[]="TCPIP0::192.168.0.123::inst0::INSTR";//IP address:192.168.0.123

Program Listings

Example: A Simple Sine Waveform

This program (found in the "Examples\Sine" subdirectory on the CDROM) selects the function as "sine," and then sets the frequency, amplitude and offset of the waveform.

```
//A Simple Sine Waveform
#include <visa.h>
#include <stdio.h>
#include <ctype.h>
#include <dos.h>

void main (int argc,char *argv[])
{
    ViSession defaultRM,vi=0;
    ViStatus status;
    char instrDesc[]="USB0::5710::5110::TW00009001::INSTR";

    viOpenDefaultRM (&defaultRM);

    status = viOpen(defaultRM,instrDesc, VI_NULL,VI_NULL, &vi);
    if (status != VI_SUCCESS){
        printf("Can not Open device:\"%s\"\n",instrDesc);
        return;
    }
    //This program sets up a waveform by selecting the waveshape
    //and adjusting the frequency, amplitude, and offset.

    viPrintf(vi,"*RST\n");
```



```

viPrintf(vi,"FUNction SINusoid\n");//Select waveshape
// Other options are SQUARE, RAMP, PULSe, DC, and USER
viPrintf(vi,"OUTPut:LOAD 50\n");      //Set the load impedance in Ohms
//(50 Ohms default)
// May also be INFINITY, as when using oscilloscope or DMM
viPrintf(vi,"FREQuency 12500\n");    //Set the frequency.
viPrintf(vi,"VOLTage 1.25\n");      //Set the amplitude in Vpp.
//Also see VOLTage:UNIT
viPrintf(vi,"VOLTage:OFFSet 0.5\n"); //Set the offset in Volts
//Voltage may also be set as VOLTage:HIGH and VOLTage:LOW for low level
//and high level
viPrintf(vi,"OUTPut ON\n");        // Turn on the instrument output

viClose (vi);
viClose (defaultRM);
}

```

Example: Amplitude Modulation

This program (found in the "Examples\AM" subdirectory on the CDROM) configures a waveform with amplitude modulation using lower-level SCPI commands. It also shows how to use the *SAV command to store the instrument configuration in the function generator's internal memory.

```

//Amplitude Modulation
#include <visa.h>
#include <stdio.h>

void main (int argc,char *argv[])
{
    ViSession defaultRM,vi=0;
    ViStatus status;
    char instrDesc[]="USB0::5710::5110::TW00009001::0::INSTR";

    viOpenDefaultRM (&defaultRM);

    status = viOpen(defaultRM,instrDesc, VI_NULL,VI_NULL, &vi);
    if (status != VI_SUCCESS){

```

```

        printf("Can not Open device:\\"%s\\"\\n",instrDesc);
        return;
    }
    // This program uses low-level SCPI commands to configure
    // the function gnerator to output an AM waveform.
    // This program also shows how to use "state storage" to
    // store the instrument configuration in memory.

    viPrintf(vi,"*RST\\n");
    viPrintf(vi,"OUTPut:LOAD 50\\n");           //Output termination is 50 Ohms
    viPrintf(vi,"FUNCTion:SHAPE SINusoid\\n"); //Carrier shape is sine
    viPrintf(vi,"FREQUency 6000;VOLTage 3\\n");//Carrier freq is 6 kHz @ 3 Vpp

    viPrintf(vi,"AM:INTernal:FUNCTion SINusoid\\n");//Modulating shape is sine

    viPrintf(vi,"AM:INTernal:FREQUency 300\\n"); //Modulation freq = 300 Hz
    viPrintf(vi,"AM:DEPTth 90\\n");           //Modulation depth = 90%
    viPrintf(vi,"AM:STATe ON\\n");           //Turn AM modulation on
    viPrintf(vi,"OUTPut ON\\n");             //Turn on the instrument output
    viPrintf(vi,"*SAV 2\\n");                //Store state in memory location 2
    // Use the "*RCL 2" command to recall the stored state output

    viClose (vi);
    viClose (defaultRM);
}

```

Example: Linear Sweep

This program (found in the "Examples\Linear_Sweep" subdirectory on the CDROM) creates a linear sweep for a sine wave. It sets the start and stop frequencies, and the sweep time.

```

//Linear Sweep
#include <visa.h>
#include <stdio.h>

void main (int argc,char *argv[])
{

```

```

ViSession defaultRM,vi=0;
ViStatus status;
char instrDesc[]="USB0::5710::5110::TW00009001::0::INSTR";

viOpenDefaultRM (&defaultRM);

status = viOpen(defaultRM,instrDesc, VI_NULL,VI_NULL, &vi);
if (status != VI_SUCCESS){
    printf("Can not Open device:\\"%s\\"\\n",instrDesc);
    return;
}
//This program sets up a linear sweep using a sinusoid
//waveform. It sets the start and stop frequency and sweep
//time.

viPrintf(vi,"*RST\\n");
viPrintf(vi,"FUNction SINusoid\\n");    //Select waveshape
viPrintf(vi,"OUTPut:LOAD 50\\n");    //Set the load impedance to
// 50 Ohms (default)
viPrintf(vi,"VOLTagE 1\\n");    //Set the amplitude to 1 Vpp.
viPrintf(vi,"SWEep:SPACing LINear\\n"); //Set Linear or LOG spacing
viPrintf(vi,"SWEep:TIME 1\\n");    //Sweep time is 1 second
viPrintf(vi,"FREQUency:STARt 100\\n"); //Start frequency is 100 Hz
viPrintf(vi,"FREQUency:STOP 20e3\\n"); //Stop frequency is 20 kHz
//Frequency sweep limits may also be set as FREQUency:CENTer and
viPrintf(vi,"OUTPut ON\\n");    //Turn on the instrument output
viPrintf(vi,"SWEep:STATe ON\\n");    //Turn sweep on

viClose (vi);
viClose (defaultRM);
}

```

Example: A Pulse Waveform

This program (found in the "Examples\Pulse" subdirectory on the CD-ROM) configures a pulse waveform, setting pulse width, period, and high/low levels. The edge time is then incremented.

```

//A Pulse Waveform
#include <visa.h>
#include <stdio.h>
#include <windows.h>

void main (int argc,char *argv[])
{
    ViSession defaultRM,vi=0;
    ViStatus status;
    char instrDesc[]="USB0::5710::5110::TW00009001::0::INSTR";
    int i;

    viOpenDefaultRM (&defaultRM);

    status = viOpen(defaultRM,instrDesc, VI_NULL,VI_NULL, &vi);
    if (status != VI_SUCCESS){
        printf("Can not Open device:\\"%s\\"\\n",instrDesc);
        return;
    }
    //This program sets up a pulse waveshape and adjusts the edge
    //time. It also shows the use of high and low voltage levels
    //and period. The edge time is adjusted by 5 nsec increments.

    viPrintf(vi,"*RST\\n");
    viPrintf(vi,"FUNCTion PULSe\\n");           //Select pulse waveshape
    viPrintf(vi,"OUTPut:LOAD 50\\n");           //Set the load impedance to
    // 50 Ohms (default)
    viPrintf(vi,"VOLTage:LOW 0\\n");             //Low level = 0 V
    viPrintf(vi,"VOLTage:HIGh 0.75\\n");         //High level = .75 V
    viPrintf(vi,"PULSe:PERiod 1e-3\\n");         //1 ms intervals
    viPrintf(vi,"PULSe:WIDTh 100e-6\\n");       //Pulse width is 100 us
    viPrintf(vi,"PULSe:TRANSition 10e-9\\n");    //Edge time is 10 ns
    //(rise time = fall time)
    viPrintf(vi,"OUTPut ON\\n");                 //Turn on the instrument output

    for(i=0;i<19;i++){           //Vary edge by 5 nsec steps
        viPrintf(vi,"PULSe:TRANSition %E\\n",0.00000001 + i * 0.000000005);
    }
}

```

```

        Sleep(300);          //Wait 300 msec
    }

    viClose (vi);
    viClose (defaultRM);
}

```

Example: Pulse Width Modulation (PWM)

This program (found in the "Examples\PWM" subdirectory on the CD-ROM) configures a pulse waveform, which is then slowly modulated by a triangle waveform.

```

//Pulse Width Modulation (PWM)
#include <visa.h>
#include <stdio.h>

void main (int argc,char *argv[])
{
    ViSession defaultRM,vi=0;
    ViStatus status;
    char instrDesc[]="USB0::5710::5110::TW00009001::0::INSTR";

    viOpenDefaultRM (&defaultRM);

    status = viOpen(defaultRM,instrDesc, VI_NULL,VI_NULL, &vi);
    if (status != VI_SUCCESS){
        printf("Can not Open device:\'%s'\n",instrDesc);
        return;
    }

    //This program uses low-level SCPI commands to configure
    //the function gnerator to output an PWM waveform.
    //The pulse is set up and a depth
    //of 15%, and will vary in width from 20% to 50% with the
    //modulation. The pulse may also be configured in time
    //if preferred.

    viPrintf(vi,"*RST\n");
}

```

```

viPrintf(vi,"OUTPut:LOAD 50\n");      //Set the load impedance to
// 50 Ohms (default)
viPrintf(vi,"FUNCTion:SHAPE PULSe\n");//Carrier waveshape is pulse
viPrintf(vi,"FREQuency 5000\n");      //Carrier frequency is 5 kHz
viPrintf(vi,"VOLTage:LOW 0\n");        //Set parameters to 5 V TTL
viPrintf(vi,"VOLTage:HIGH 5\n");
viPrintf(vi,"FUNCTion:PULSe:DCYCLE 35\n");//Begin
viPrintf(vi,"PWM:INTernal:FUNCTion TRIangle\n");//Modulating waveshape
//is triangle
viPrintf(vi,"PWM:INTernal:FREQuency 2\n");//Modulation frequency is 2 Hz
viPrintf(vi,"PWM:DEVIation:DCYCLE 15\n"); //Modulation depth is 15%
viPrintf(vi,"PWM:SOURce INTernal\n");  //Use internal signal for
//modulation
viPrintf(vi,"PWM:STATe ON\n");         //Turn PWM modulation on
viPrintf(vi,"OUTPut ON\n");            //Turn on the instrument output

viClose (vi);
viClose (defaultRM);
}

```

Conformity with the following European Directives:

The product herein conforms to the requirements of the Low Voltage Directive 2006/95/EC and the EMC Directive 2004/108/EC and goes with the CE Marking accordingly.

Conformity with the following product standards:

Manufacturer Name: Picotest Corp.

Manufacturer Address: 5F-1, 286-9, Hsin-Ya Rd, 80673, Kaohsiung, Taiwan

Declaration of Product

Product Name: Arbitrary Waveform Generator

Model Number: G5110A

Product Accessories: This declaration applies to all accessories of the above product(s).

EMC:

EN61326-1:2006

EN61326-2-1:2006

Emission: CISPR 11:2009 +A1:2010 (Class A)

EN61000-3-2:2006 +A1:2009 +A2:2009

EN61000-3-3:2008

Immunity: IEC61000-4-2:2008

IEC61000-4-3:2010

IEC61000-4-4:2011

IEC61000-4-5:2005

IEC61000-4-6:2008

IEC61000-4-11:2004

Safety:

EN61010-1:2010/IEC61010-1:2010 (3rd Edition)

EN61010-2-030:2010/IEC61010-2-030:2010(1st Edition) used in conjunction with

EN61010-1:2010/IEC61010-1:2010 (3rd Edition)

13 Feb. 2014
Date

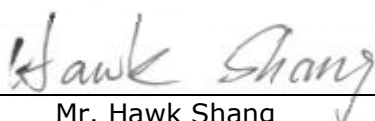
Mr. Hawk Shang
General Manager

For more information, please contact your local supplier, sales office or distributor.