

HD RANGER Eco

TV & SATELLITE ANALYSER

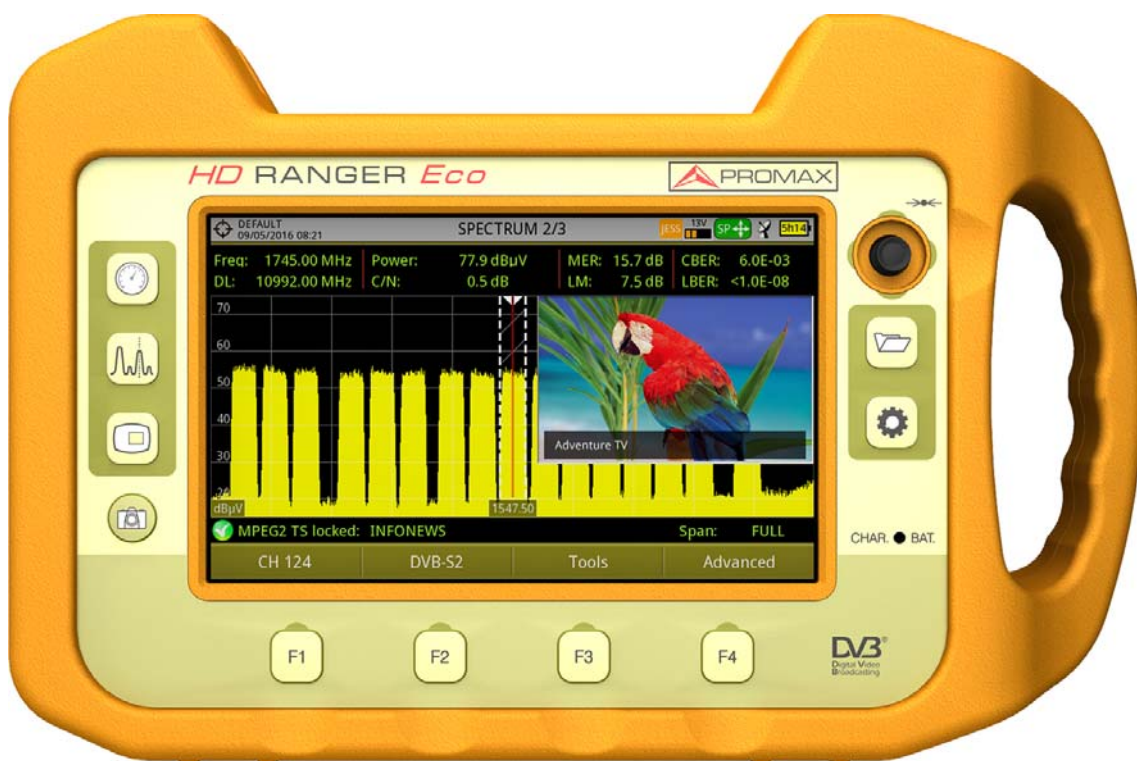

-0 MI2132 -



SAFETY NOTES

Read the user's manual before using the equipment, mainly "**SAFETY RULES**" paragraph.

The symbol  on the equipment means "**SEE USER'S MANUAL**". In this manual may also appear as a Caution or Warning symbol.

WARNING AND CAUTION statements may appear in this manual to avoid injury hazard or damage to this product or other property.

ELECTRONIC MANUAL VERSION

You can access instantly to any chapter by clicking on the title of the chapter in the table of contents.

Click on the arrow  at the top right page to return to the table of contents.

Click on video boxes  to access video-tutorial on PROMAX youtube channel.

At Index click on page number to access the subject.

USER'S MANUAL VERSION

Manual Version	Web Published Date	Firmware Version
F2.0	February 2019	26.8

■ Please update your equipment to the latest firmware version available.















WHAT'S NEW on manual F2.0

- It keeps main measurement selection in MEASUREMENT 1/3 screen even after switching off.
- Frequency marker shows up to 6 decimals (Hz).
- Compatible with LNB SKY UK.
- Offset adds a value to power/level measurement.
- It allows disabling short-circuit at LNB.
- Datalogger stores information from PLPs in DVB-T2 signals.
- In TV 3/3 screen shows subtitles, teletext and audio description if available.
- Compatible with DCII signals.
- User's manual re-structured to make it more user-friendly.
- Index sorted by words added at the end of the manual.
- Annex removed from manual and now available online at PROMAX website.

SAFETY RULES

- * The safety could not be assured if the instructions for use are not closely followed.
- * Use this equipment connected only to systems with their negative of measurement connected to ground potential.
- * The AL-103 external DC charger is a Class I equipment, for safety reasons plug it to a supply line with the corresponding ground terminal.
- * This equipment can be used in Overvoltage Category I installations and Pollution Degree 2 environments.
- * External DC charger can be used in Overvoltage Category II, installation and Pollution Degree 1 environments.
- * When using some of the following accessories use only the specified ones to ensure safety:
 - Rechargeable battery
 - External DC charger
 - Car lighter charger cable
 - Power cord
- * Observe all specified ratings both of supply and measurement.
- * Remember that voltages higher than 70 V DC or 33 V AC rms are dangerous.
- * Use this instrument under the specified environmental conditions.
- * When using the power adaptor, the negative of measurement is at ground potential.
- * Do not obstruct the ventilation system of the instrument.
- * Use for the signal inputs/outputs, specially when working with high levels, appropriate low radiation cables.
- * Follow the cleaning instructions described in the Maintenance paragraph.

SAFETY SYMBOLS

<p> DIRECT CURRENT</p> <p> ALTERNATING CURRENT</p> <p> DIRECT AND ALTERNATING</p> <p> GROUND TERMINAL</p> <p> PROTECTIVE CONDUCTOR</p> <p> FRAME TERMINAL</p> <p> EQUIPOTENTIALITY</p>	<p> ON (Supply)</p> <p> OFF (Supply)</p> <p> DOUBLE INSULATION (Class II protection)</p> <p> CAUTION (Risk of electric shock)</p> <p> CAUTION REFER TO MANUAL</p> <p> FUSE</p> <p> EQUIPMENT OR COMPONENT TO BE RECYCLED</p>
---	---

DESCRIPTIVE EXAMPLES OF OVER-VOLTAGE CATEGORIES

- * **Cat I:** Low voltage installations isolated from the mains.
- * **Cat II:** Portable domestic installations.
- * **Cat III:** Fixed domestic installations.
- * **Cat IV:** Industrial installations.

CAUTION: The battery used can present danger of fire or chemical burn if it is severely mistreat. Do not disassembly, cremate or heat the battery above 100 °C under no circumstances.

TABLE OF CONTENTS

1. INTRODUCTION	1
1.1. Description	1
2. SETTING UP	3
2.1. Package Content	3
2.2. Power	3
2.3. Equipment Details	6
2.5. Reset.....	8
2.4. Switching On/Off.....	8
2.6. Screen Icons and Dialog Boxes.....	9
2.7. Menu Tree.....	10
2.8. Controls.....	13
3. SETTINGS AND PREFERENCES.....	20
3.1. Settings Menu.....	20
3.3. Preferences Menu.....	23
3.2. Video & Audio Settings.....	23
4. RF SIGNAL TUNING.....	28
4.1. Introduction	28
4.2. Operation.....	28
4.3. General Menu Options.....	29
4.4. Advanced Options	36
4.5. Screen Description	38
4.6. Extra Information.....	51
5. TOOLS.....	54
5.1. Introduction	54
5.2. Constellation	54
5.3. LTE Ingress Test	58
5.4. Echoes.....	61
5.5. Attenuation Test	63
5.6. Datalogger	66
5.7. Screen and Data Capture (Export key)	74
5.8. Explore Channel Plan	76
5.9. Field Strength.....	79
5.10. Task Planner.....	84
6. INSTALLATIONS MANAGEMENT.....	89
6.1. Introduction	89
6.2. Operation.....	89
6.3. Installation Management	90
6.4. New Installation	93
6.5. Tools	93
6.6. Importing Data from USB.....	94
7. CONNECTING TO EXTERNAL DEVICES.....	96
7.1. Description.....	96
7.2. USB Port	96
7.3. Input Jack Connector.....	99
7.4. RF Connector.....	100
8. SPECIFICATIONS	105
8.1. General.....	105
8.2. Measurement Mode	107
8.3. Spectrum Analyzer Mode	111

8.4. TV Mode 112

8.5. Tools 113

9. MAINTENANCE 115

 9.1. Instructions for Returning by Mail 115

 9.2. Considerations about the Screen 115

 9.3. Cleaning Recommendations 115

i. ADDITIONAL INFORMATION 117

ii. INDEX 119



TV AND SATELLITE ANALYZER

HD RANGER Eco

1 INTRODUCTION

1.1 Description

The new **HD RANGER Eco** is the sixth generation of field meters that **PROMAX** launches. As each new generation, it represents an evolution from the previous, since it integrates the latest technological innovations and develops applications for the new demands and needs that have emerged in recent years.

The new **RANGER Neo** has been created with the aim to make easy the user experience. From its ergonomic design and stylized lines to the reduction of keys and the easy use of its interface, everything has been designed so the user has a simple tool to use but powerful and useful.

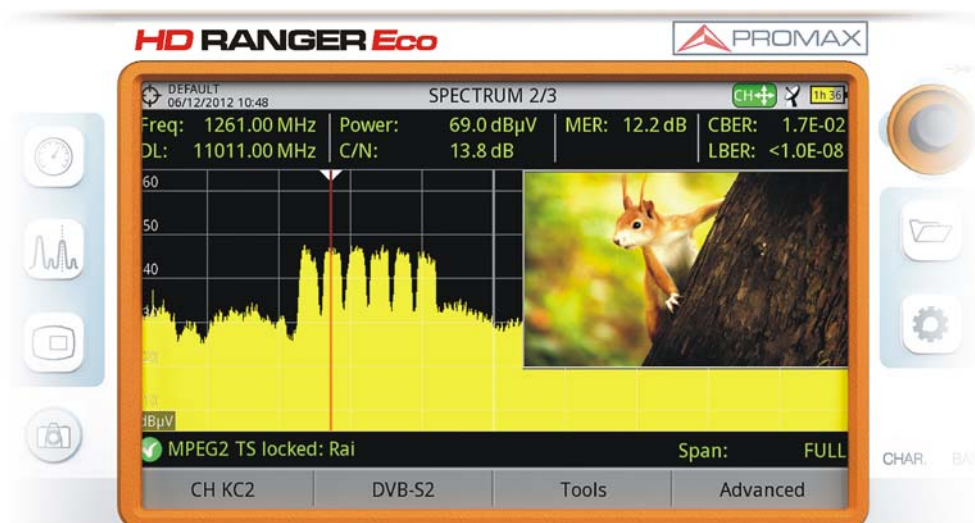

Figure 1.

The **HD RANGER Eco** is a universal analyzer that covers several of the most popular standards of the DVB family, as well as formats such as MPEG-2 and MPEG-4.

Besides the basic functions of TV meter and spectrum analyzer for terrestrial and satellite band, it provides additional tools, such as the detection of LTE signal interferences (some of its working frequencies are close to the TV bands), the diagrams constellations or the echoes detection.

The **HD RANGER Eco** has an application to manage data generated at each installation. This feature helps the user to manage information generated so he can access it at any time or download it to a PC for further analysis.



In an effort to facilitate its work to professionals, our long experience ensures an after sales quality service, which includes software updates and upgrades for free.

The *HD RANGER Eco* has been designed and developed entirely in the European Union. A multidisciplinary team of highly qualified professionals has dedicated effort and commitment to the development of a powerful, efficient and reliable tool. During the manufacturing process, all used materials have been subjected to a strict quality control.



Figure 2.



[Click here to watch this video: Introducing the HD RANGER Series](#)



2 SETTING UP

2.1 Package Content

Check that your package contains the following elements:

- **HD RANGER Eco** Analyzer.
- External DC charger.
- Mains cord for external DC charger.
- Car lighter charger.
- "F" adapters:
 - "F"/f - DIN/f adapter.
 - "F"/f - "F"/f adapter.
- Support belt and carrying bag.
- USB On-the-go (OTG) (A) Female - Mini USB (B) Male cable.
- USB (A) Male - Mini USB (A) Male cable.
- Monopod.
- Quick Start Guide.

NOTE: Keep the original packaging, since it is specially designed to protect the equipment. You may need it in the future to send the analyzer to be calibrated.

2.2 Power

The **HD RANGER Eco** is powered by a 7.2 V built-in rechargeable Li-Ion battery of high quality and long operation time. This equipment can operate on battery or connected to the mains using a DC adapter. An adapter is also supplied to use with the power connector car (cigarette lighter).

2.2.1 First Charge

The equipment comes with the battery half charged. Depending on the time elapsed from first charge and environmental conditions may have lost some of the charge. You should check the battery level. It is advisable a first full charge.



2.2.2 Charging the Battery

Connect the DC power adapter to the equipment through the power connector on the side panel (see figure).



Figure 3.

Then connect the DC power adapter to the mains via the mains cord. Ensure that your mains voltage is compatible with the adapter voltage.

For a **fast** charging is necessary to switch off the equipment.

If the equipment is ON, the battery charge will be slower, depending on the type of work you are doing. When connecting the equipment to the mains the mains connected symbol  appears inside the battery icon.

The CHARGER led indicator shows the battery status:

- **On:** Battery charging.
- **Off:** Battery full charge and / or not charging.
- **Blinking:** Battery failure or no battery.

When switching on the equipment, the battery voltage is checked. If the tension is too weak to start the equipment does not start up. In this case please charge the battery immediately.

2.2.3 Charge / Discharge Times

Average charging time with the equipment off (fast charge):

- 3 hours to achieve an 80% charge.
- 5 hours to achieve a 100% charge.



With the equipment on (slow charge):

- 5 hours to achieve an 80% charge.
- 8 hours to achieve a 100% charge.

Average discharge time (with external supply disabled):

- With the battery full charge the average battery time is 3 hours.
- With the battery at 80% charge the average battery time is 2 h.

2.2.4 Energy Saving

These options are available in the **Preferences** menu, pressing the key  for 1 s.

- **Power Off:** It allows the user to select the time to power off, which is the time after which the equipment shuts down automatically unless pressing any key.
- **TFT Screen:** User can select a time after which the TFT screen turns off, but the equipment is still running normally. The equipment can measure (for example, making a datalogger or channel exploration) and the battery will last longer, about 10% more. The screen turns on by pressing any key. Time options are: off, 1, 5, 10 or 30 minutes..

2.2.5 Usage Tips

The battery is losing storage capacity as you go through its life. Contact your **PROMAX** distributor when necessary to replace the battery.

To extend battery life the user should follow these tips:

- In case of providing a long inactivity period of the equipment it is advisable to make every 3 months a charge / discharge cycle and a subsequent partial charge (40% aprox.).
- It is advisable to keep it in a cool place and away from heat.
- You should avoid keeping the battery for a long period of time at full load or fully discharged.
- There is not necessary to wait to fully discharge before a charge because these batteries have no memory effect.



2.3 Equipment Details

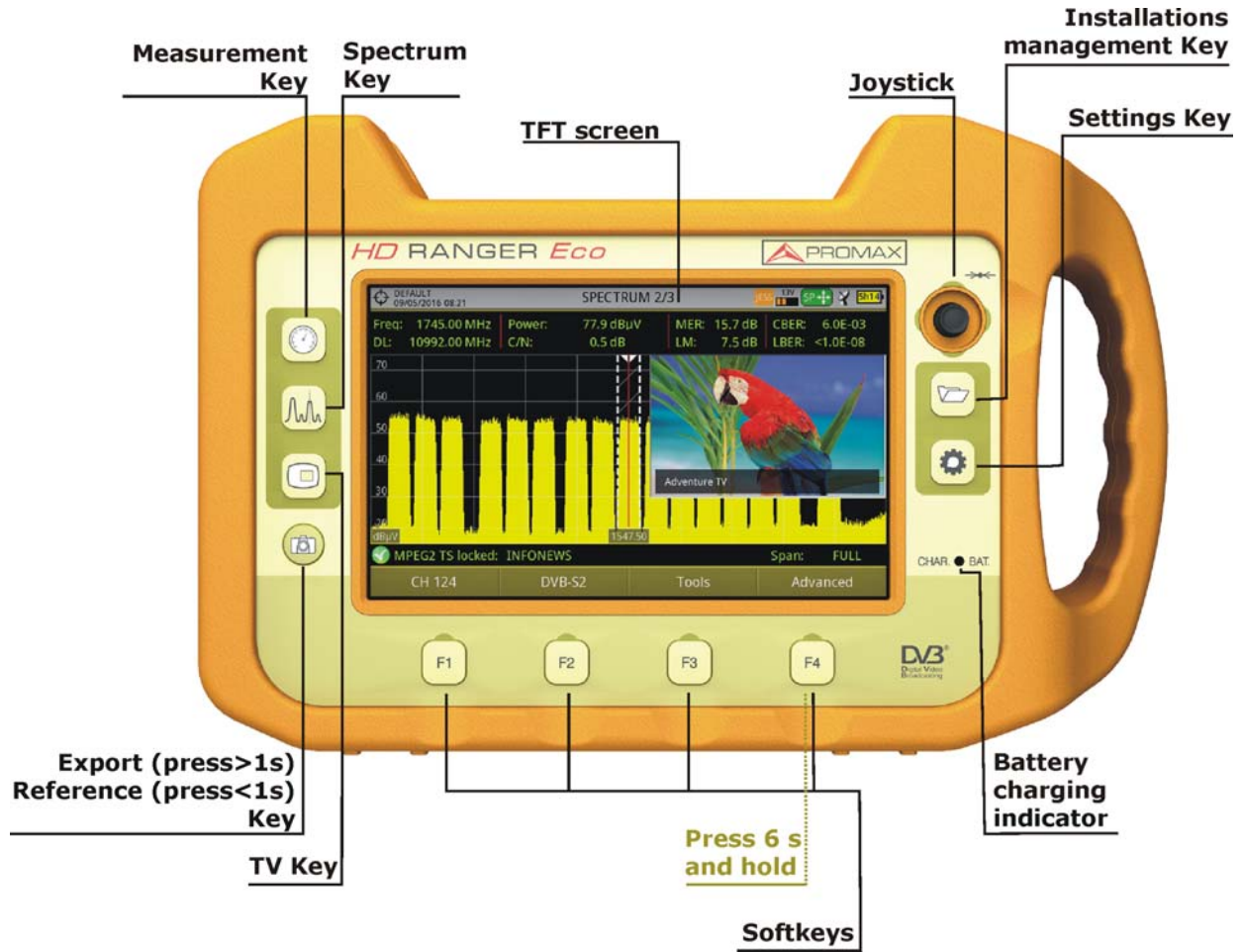

Figure 4. Front View.

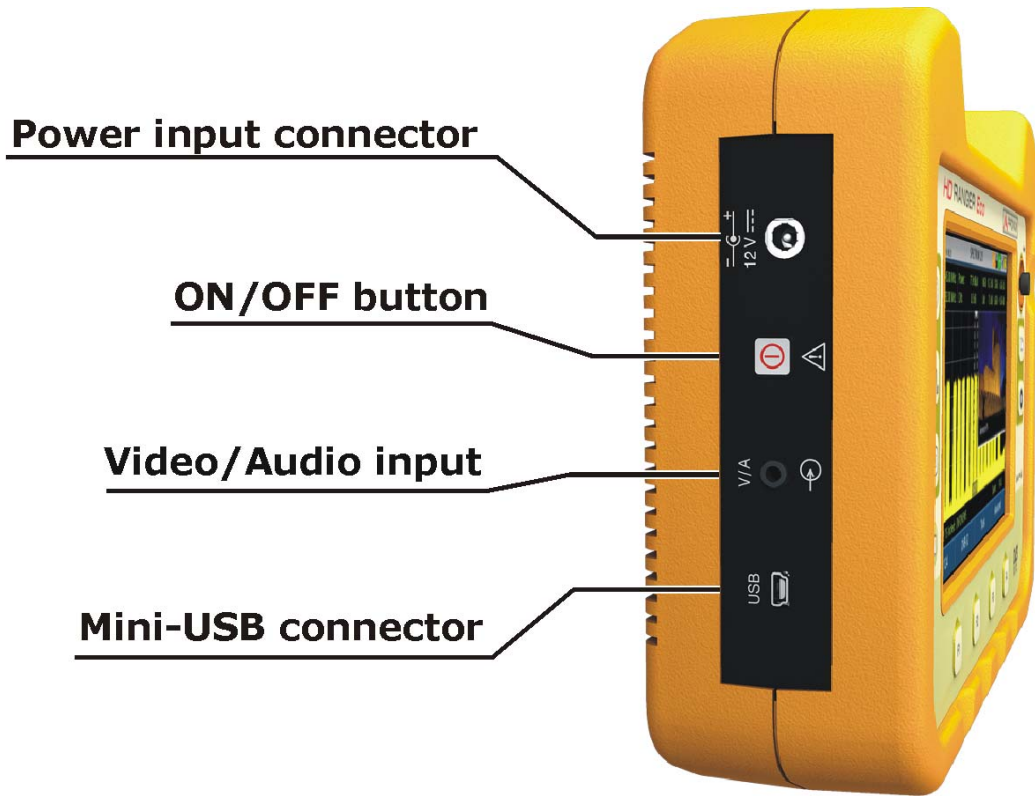

Figure 5. Side View.

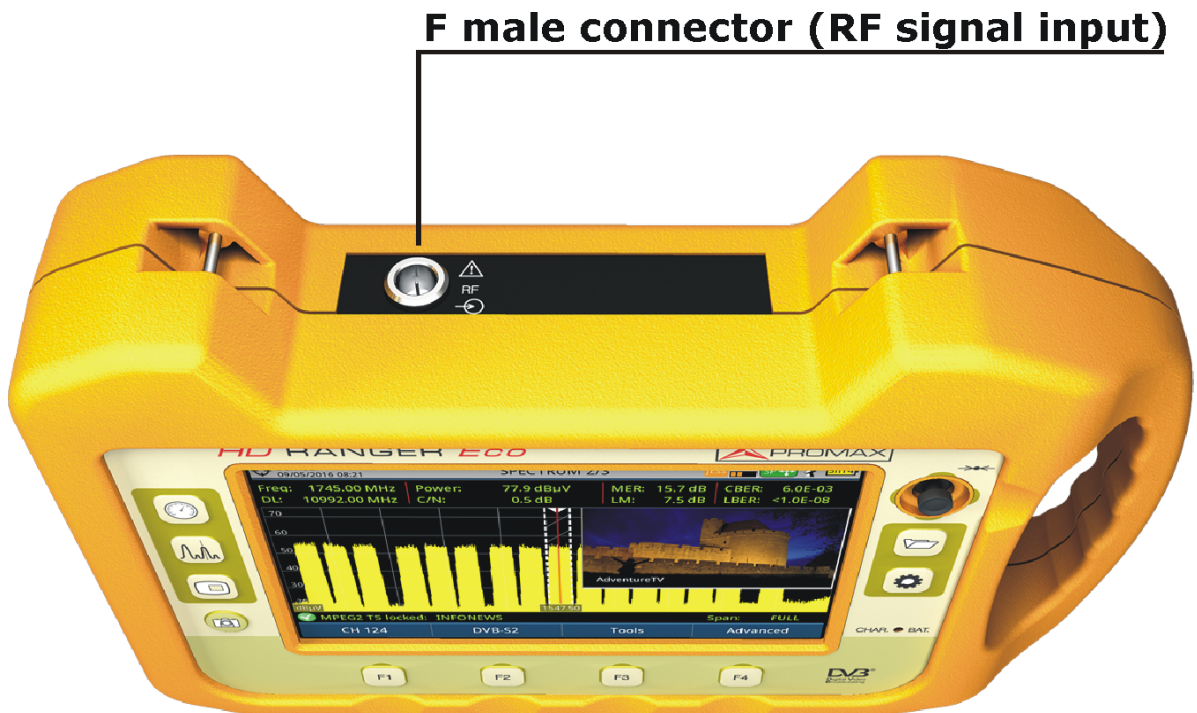

Figure 6. Top View.



2.4 Switching On/Off

► Switching On:

- 1 Press for a while (approximately one second) the ON/OFF button placed on the side of the equipment.
- 2 The boot screen appears and also a progress bar that indicates the system is loading. At the top left corner it shows the equipment model and release.
- 3 After the system loads, it shows the last status used (mode and screen).

► Switching Off:

- 1 Press the ON/OFF button placed on the side of the equipment:
 - **Short Press (<1 s):** A menu on screen allows the user to select between power off or reboot.
 - **Long Press (>2 s):** The equipment turns off directly.
- 2 The boot screen picture appears and also a bar showing the system shutdown progress.
- 3 The equipment keeps its last status (mode and screen) which is recovered when power on.

In the **PREFERENCES** menu  (press 1 s), APPEARANCE tab, option "**Off**" the user can activate the automatic shutdown option, selecting a waiting time (time without pressing any key) after which the equipment turns off automatically.

2.5 Reset

How to **RESET**: Hold down the  key for 6 seconds and release.

When to **RESET**:

- **When it crashes and does not respond to any key.** Hold down the ON/OFF button for 10 seconds and if the meter does not turn off then RESET.
- **When it does not switch on.** If it does not start after trying turning on by the normal procedure (by pressing the ON/OFF button with the meter connected to the mains) then RESET.



- **When it does not finish the boot process.** Hold down the ON/OFF button for 10 seconds and if the meter does not turn off then RESET.

2.6 Screen Icons and Dialog Boxes

On the screen are some icons that provide useful information to the user about the current status of the instrument.

	Battery charging.		Warning.
	Battery not charging. Yellow level indicates charge left.		USB flash drive inserted.
	USB in serial port mode.		Current installation.
	Satellite band.		SATCR (SCD/EN50494) commands enabled.
	Current voltage, 22 kHz signal and LNB power level		JESS (SCD2/EN50607) commands enabled.
	Terrestrial band.		Task scheduled.
	Compressed installation.		Multi-function Joystick enabled. Two-letter code indicates the exact function:
	OK.		FR Frequency tuning.
			CH Channel tuning.
			SP Span change.
			MK Marker moving.
	Searching.		EC Echo/zoom change.

Figure 7.



2.7 Menu Tree

► Spectrum Analyser Menu

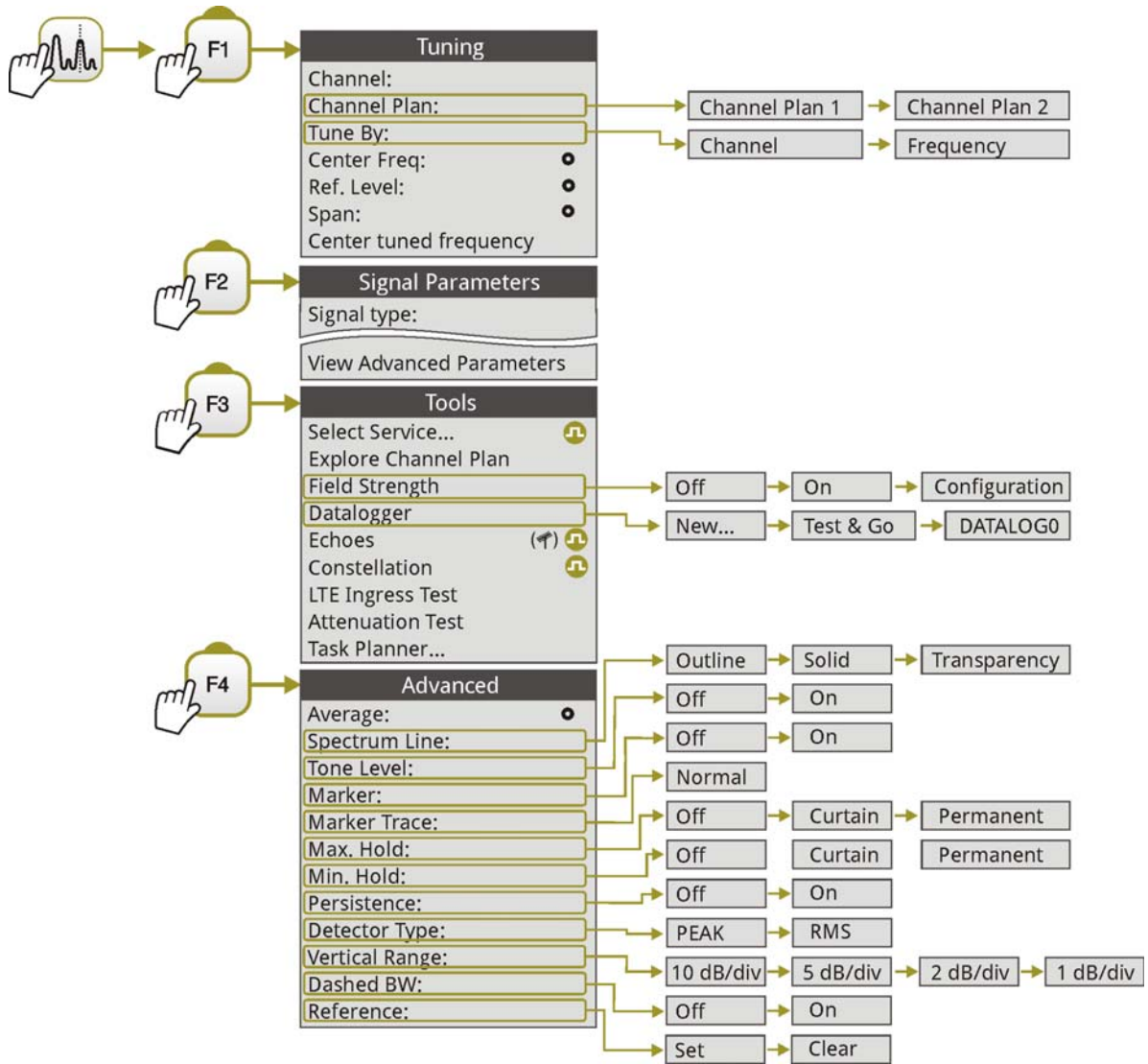

Figure 8.



► TV Menu

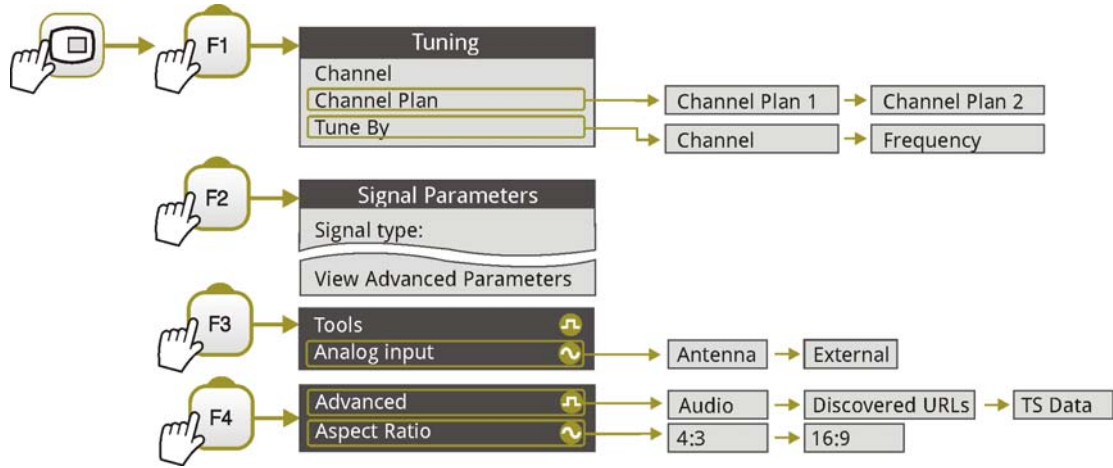

Figure 9.

► Measurement Menu

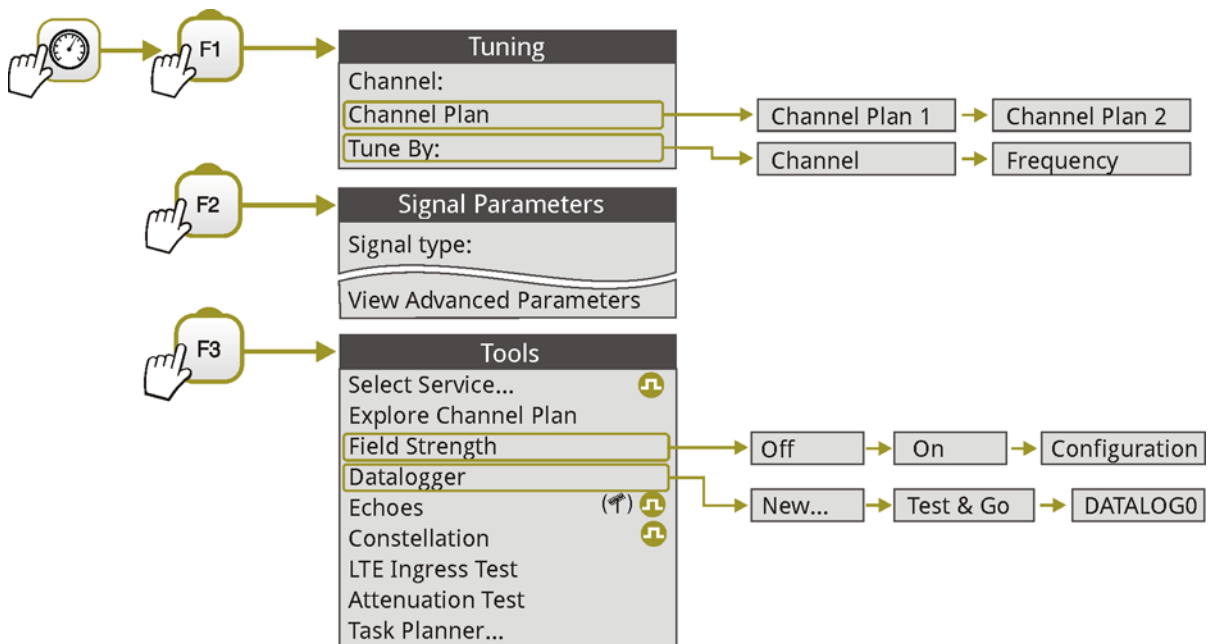

Figure 10.



► Settings Menu

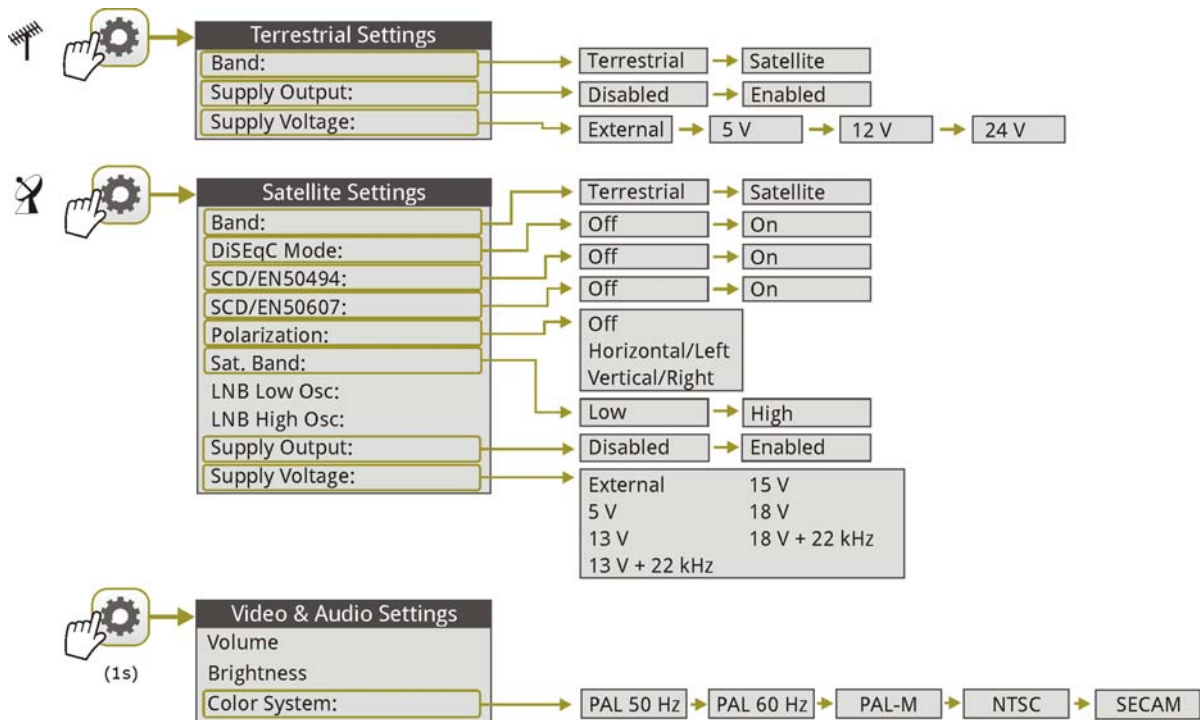

Figure 11.

► Installations Menu

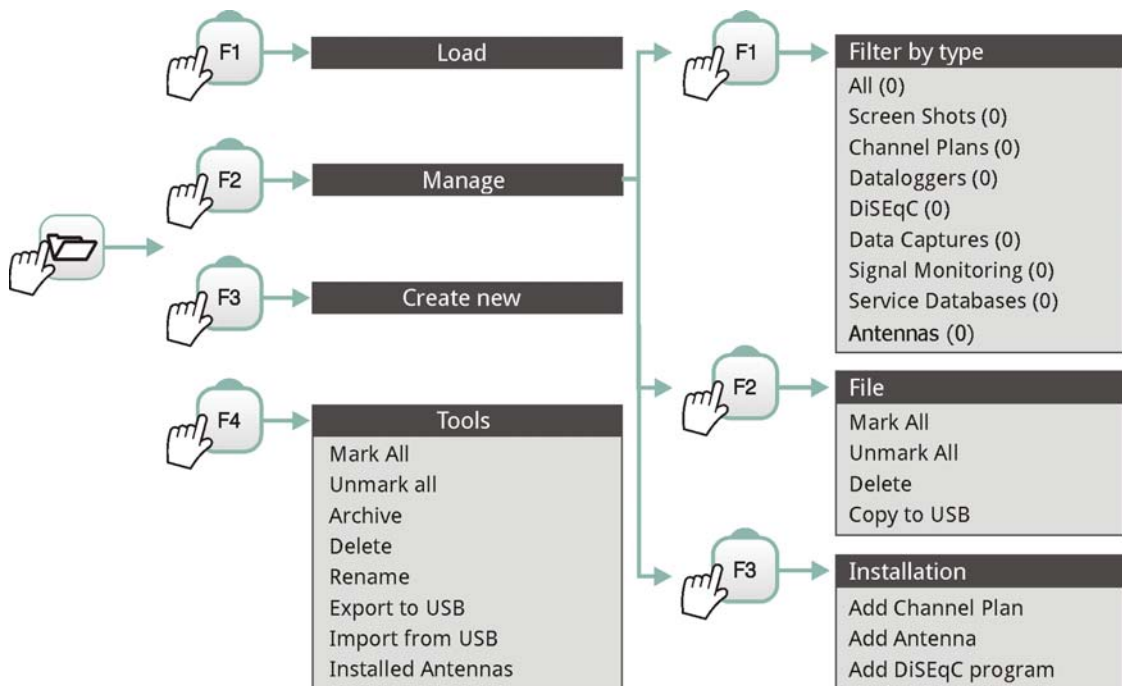

Figure 12.



► Preferences Menu

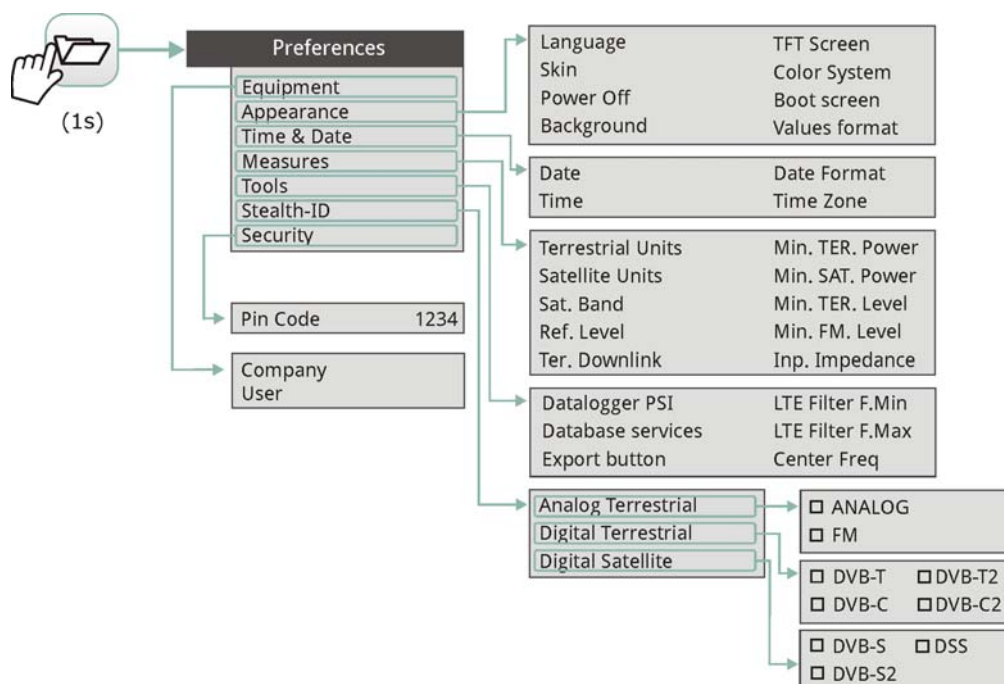

Figure 13.

2.8 Controls

The equipment has been designed to be an easy tool to use. For this reason the number of keys has been reduced and they are grouped by function.

The menu navigation includes hints that appear when the cursor is placed on an disabled (grayed) option for a while. These hints help the user to understand why an option is disabled and what to do to enable it

For measurement and navigation through the menus, the equipment has one joystick, 4 function keys (softkeys) and 6 direct access keys (shortcut keys).

2.8.1 Joystick

Joystick can make five movements:

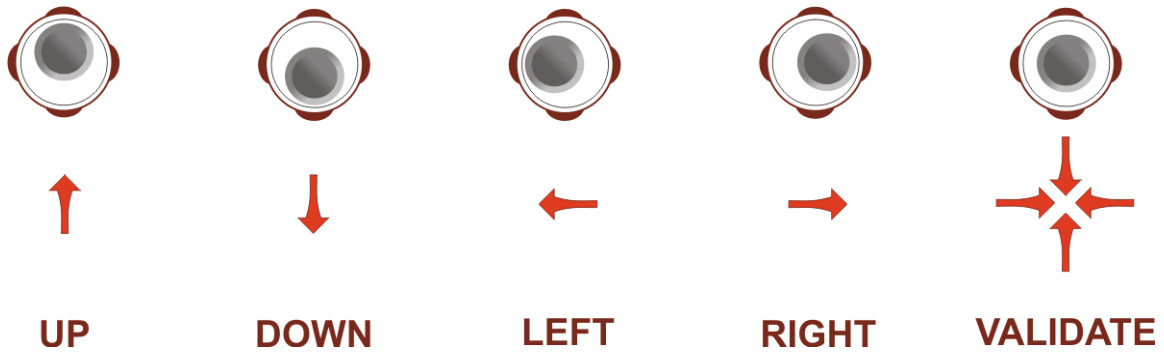

Figure 14.

In some modes or tools, the joystick is multifunctional, that is, each time you press on it (validate), its function changes:

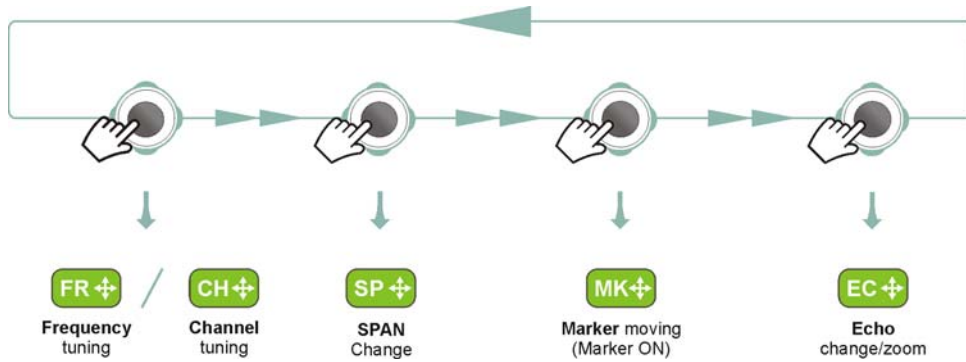

Figure 15. Functions of Joystick in SPECTRUM ANALYZER mode.

The user can see the active function according to the icon that is displayed at the upper right corner of the equipment (see next figure).



Figure 16. Joystick with SP function enabled (SP: Span)



Also, depending on the screen, the joystick has some specific functions. They are:

► In **MEASUREMENT** mode, the joystick has these functions:

- Left - Right
 - Channel change or frequency change (according to tune selected: tune by channel or tune by frequency).
- Up - Down
 - Change of main measure on screen (screen MEASUREMENT 1/3).

► In **TV** mode, the joystick has these functions:

- Left - Right
 - Channel change or frequency change (according to tune selected: tune by channel or tune by frequency).
- Up - Down
 - Change of TV service.

► In **SPECTRUM ANALYZER** mode, the joystick has these functions:

- Left - Right
 - CH or FR: Channel change (CH) or frequency (FR) change (according to tune selected: tune by channel or tune by frequency).
 - SP: Span change.
 - MK: Marker move (if marker is enabled).
- Up - Down
 - Reference level change.

Pressing the joystick for 1 second, a box appears explaining the joystick modes available. From here user can also select the joystick mode.

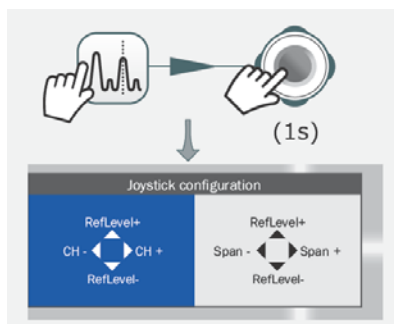

Figure 17.



- In **ECHOES** tool, the joystick has these functions:
- Left - Right
 - CH or FR:Channel (CH) change or frequency (FR) change (according to the tune selected: tune by channel or tune by frequency).
 - EC:Echo change.
 - Up - Down
 - Distance span.



[Click here to watch this video: Navigating through the menus](#)

2.8.2 Select and Edit Parameters

To edit or select any parameters follow these instructions:

- 1 Place over the option and press the joystick.
- 2 The data field gets into the edit mode (yellow background).
- 3 A menu is deployed with some options or if it is numeric, a number gets a black background.
- 4 Move the joystick up/down to select one option. To move between figures press right/left and to change it press up/down.
- 5 After finish press joystick to confirm or any function key to exit.



2.8.3 Shortcut Keys

► Management Keys

There are two Management keys. Depending on how long you press these keys, it has two different functions:

■ Installations / Preferences key



- Short Press (<1s): It shows the list of installations and the menus to manage them.
- Long Press (>1s): It shows the Preferences menu.

■ Tune Settings / Video - Audio Settings



- Short Press (<1s): It shows the Settings menu (menu changes according to signal source selected).
- Long Press (>1s): It shows the Video & audio settings.

► Screenshot / Reference key





Depending on how long you press this key, it has two different functions:

- Short Press (<1s): Pressing this key for less than one second on the Spectrum Analyzer mode, it holds on screen the current waveform as a trace or reference. It is equivalent to go to the option "Reference - Set" from the "Advanced" menu. Pressing short again, it deletes the waveform reference. It is equivalent to go to the option "Reference - Clear" in the "Advanced" menu.
- Long Press (>1s): Pressing this key for one second it makes a capture of what it is shown on screen at the time. The capture may be from the screen image, from the measurement data or from both. The type of capture, either screen, data, or both can be set in the "**Export button**" option which is on the label "**Measures**" in the "**Preferences**" menu (for more details refer to "Screen and Data Capture (Export key)" on page 74).





► **Mode keys**

On the left side there are three keys to access the most important modes of the meter.

-  Measurement key.
-  Spectrum Analyzer key.
-  TV Mode key.

Pressing on one of these keys repeatedly provides access to a different view within the same function. For analogue signals only the first view of each function is available. Each view name is shown at the top centre of the screen. When reaching the third view it returns to the first view.

2.8.4 Function keys or Softkeys

There are four programmable keys, also called softkeys, numbered from  to .

Each key provides access to one menu. This menu changes according to the mode or tool selected.

The menu is displayed over each softkey at the bottom of the screen.

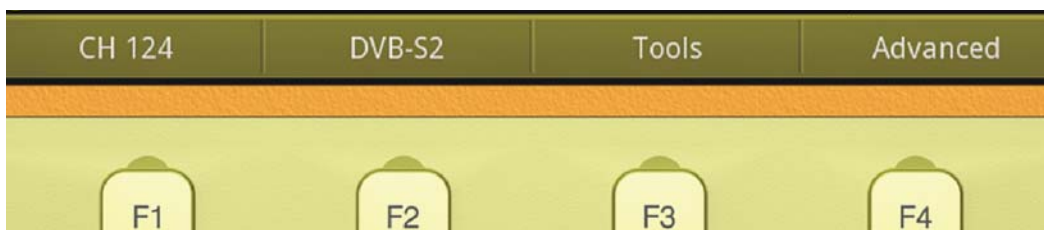

Figure 18.

2.8.5 Virtual Keyboard

When a user needs to enter or edit a text (from an image, Channel Plan, etc.), a screen with a virtual keyboard appears (see figure).





Figure 19.

To edit a word user should follow these steps:

- 1 Place the cursor over the text box where the name appears.
- 2 Move the cursor to place it next to the letter that user wants to edit.
- 3 Press on the virtual keyboard to edit.
- 4 Once edition is finished, press OK (F3) to accept or (F4) to Cancel.

To delete a letter, move the cursor to the right side of the letter and then press the joystick on the Delete key  or press Delete (F2).

To enter an upper case letter press first (F1) or press the joystick on the key . To block upper case press (F1) or press the joystick on the key  twice. To return to lower case press (F1) or the key  again.

Keys with a point at top right corner give access to special characters, by keeping pressed the joystick for one second on the key.



3 SETTINGS AND PREFERENCES

3.1

Settings Menu

Press the **Settings** key  to access the settings menu. Depending on the signal source, the menu may be different.

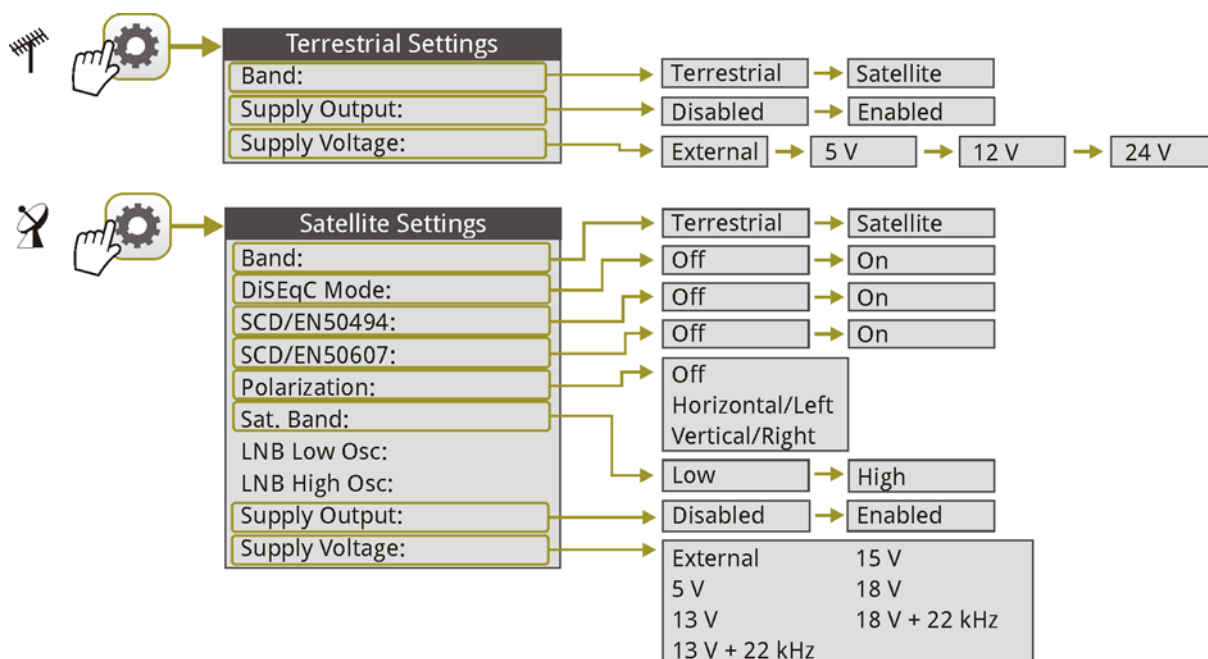

Figure 20. Settings for Terrestrial and Satellite band

► Band

It allows the user to select between terrestrial or satellite frequency band.



[Click here to watch this video: Switching satellite / terrestrial bands](#)

► External power supply (available for terrestrial and satellite band)

It enables or disables the power supplied to external units such as preamplifiers for antennas in terrestrial television or LNBS and FI simulators in the case of satellite TV.

When this option is enabled the equipment applies at the output the voltage selected by the user in the Supply Voltage option (see below). When this option



is disabled the equipment does not apply the voltage to the output but it will behave as if it did.

► **Supply voltages (available for terrestrial and satellite band)**

It selects the voltage to be applied to an external unit. Available voltage options change depending on the selected band. In tuning by channel mode this option can not be changed because is defined by the channel.

- Voltage available for terrestrial band: External, 5 V, 12 V and 24 V.
- Voltage available for satellite band: External, 5 V (for devices working with 5 V such as GPS active antennas), 13 V, 13 V + 22 kHz, 15V, 18 V, 18 V + 22 kHz.

In the External supply voltage option the power supplier to the external units is the power supplier of the antenna preamplifiers (terrestrial television) or the satellite TV receiver (collective or domestic).

► **LNB Drain (available for terrestrial and satellite band)**

The LNB drain option shows the voltage and current flowing to the external unit.

If there is any problems (e.g. short circuit), an error message appears on the screen ('SHORTCIRCUIT'), a warning beep sounds. The equipment allows you to disable the output tension that feeds the LNB when the short-circuit warning is displayed.

The equipment does not return to its normal operating state until the problem is solved. During this time the equipment checks every three seconds if there still the problem, warning with an audible signal.

► **DiSEqC Mode (only available for satellite band)**

It enables or disables DiSEqC mode. DiSEqC (Digital Satellite Equipment Control) is a communication protocol between the satellite receiver and accessories of the satellite system (see chapter "Connecting to External Devices").

► **SCD/EN50494 (only available for satellite band)**

It enables or disables the SCD/EN50494 function to control devices of a satellite TV installation that supports this technology (see chapter "Connecting to External Devices").



► **SCD2/EN50607 (only available for satellite band)**

It enables or disables SCD2/EN50607 mode to control devices in a satellite TV installation which must be compatible with this technology (see chapter "Connecting to External Devices").

► **Polarization (only available for satellite band)**

It allows the user to select the signal polarization between Vertical/Right (vertical and circular clockwise) and Horizontal/Left (horizontal and circular anti-clockwise), or disable it (OFF). In tuning by channel mode this option can not be changed because is defined by the channel.

► **Sat Band (only available for satellite band)**

It allows the user to select the High or Low band frequency for satellite channel tuning. In channel tuning mode the Band Sat can not be changed. In tuning by channel mode this option can not be changed because is defined by the channel.

► **LNB Low Osc. (only available for satellite band)**

It defines the local oscillator frequency for the LNB low band. When a channel plan is selected but LNB oscillator values are not properly selected, a warning is issued.

► **LNB High Osc. (only available for satellite band)**

It defines the local oscillator frequency for the LNB high band (up to 25 GHz). When a channel plan is selected but LNB oscillator values are not properly selected, a warning is issued.



3.2 Video & Audio Settings

Press the Settings key  for one second to access the Video & Audio settings menu.

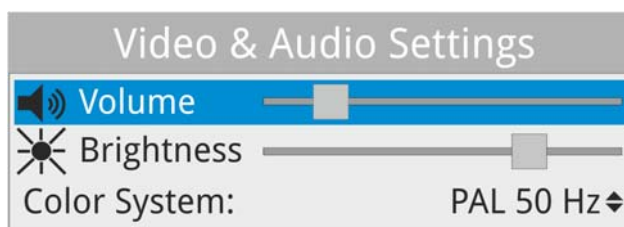

Figure 21.

A brief explanation of each option available on the menu:

► Volume

It increases or decreases the volume of the speaker audio output by moving the joystick to the right (+ volume) or left (- volume).

► Brightness

It increases or decreases the screen brightness by moving the joystick to the right (+ brightness) or left (- brightness).

► Colour System

The coding system used in analogue transmissions. Available options are: PAL 50 Hz, PAL 60 Hz, PAL-M, NTSC, SECAM.

3.3 Preferences Menu

Preferences menu is available by pressing the **Installations Management** key  for one second. The options are grouped in tabs as follows:

- **Equipment:** Equipment information.
- **Appearance:** Equipment customizing options.
- **Time & Date:** It allows the user to change date, time, date format and time zone (selecting continent and country/city).
- **Measurements:** It allows the user to choose between several units of measure among other parameters.



- **Tools:** It allows to edit some parameters for different tools.
- **StealthID:** It allows the user to select the set of signal types being used while auto identifying any modulation type.
- **Security:** It allows to edit the PIN code.

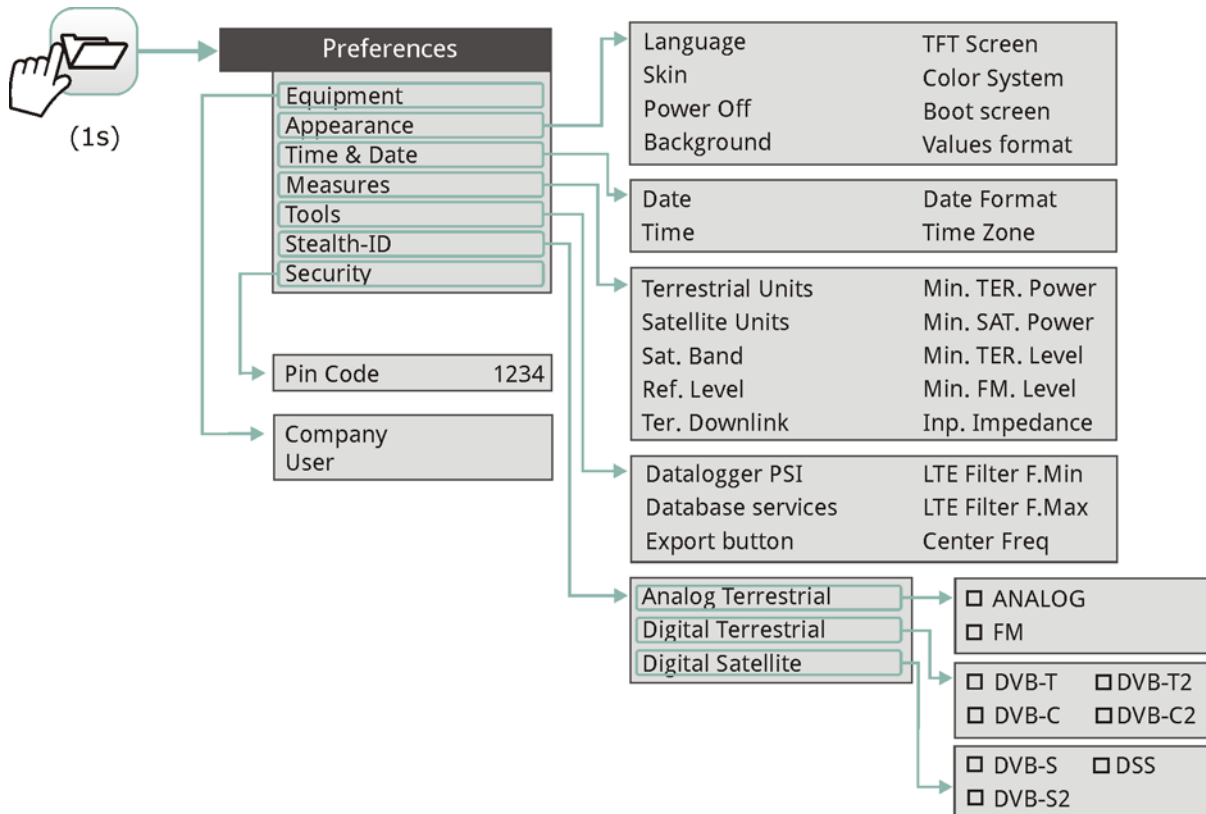

Figure 22.

To navigate between tabs move the joystick left or right. To navigate between options inside the tab move the joystick up or down.

Press **F1** Exit to exit Preferences.

Press **F2** Save to save changes.

A brief explanation of the options available in each tab:

► **Equipment Information**

- **Provider:** Provider's name.
- **Name:** Equipment's name.
- **Serial number:** Unique identification number for this equipment.
- **Release:** Version of software installed on the equipment.



- Date: Date of software installed on the equipment.
- Free system memory: Free size of the flash memory installed on the equipment / Size of the flash memory installed on the equipment for system (equipment software).
- Free data memory: Free size of the flash memory installed on the equipment / Size of the flash memory installed for data (dataloggers, screenshots, service recording and so on...).
- Company: Name of the company which owns the equipment (set by user; protected by PIN code). This field appears on the boot screen.
- User: Name of the equipment's user (set by user; protected by PIN code). This field appears on the boot screen.

► Appearance Options

- Language: Language used on menus, messages and screens. Available languages are: English, Spanish, Catalan, Czech, German, French, Italian, Norwegian, Polish, Portuguese, Greek, Russian, Slovak and Swedish. Once the new language is selected, the equipment shows a warning message and re-starts in order to load the new language.
- Skin: It is the theme and colours used on screen.
- Power Off: It allows the user to select the time to power off, which is the time after which the equipment shuts down automatically unless user press any key.
- Background: It allows the user to select the background colour on the display screen. Options available are: white, green, red, black and blue.
- Battery Time: It hides or shows the remaining battery time. Remaining battery time is displayed on the inside of the battery level icon.
- TFT Screen: User can select a time after which the TFT screen turns off, but the equipment is still running normally. The screen turns on by pressing any key. Time options are: off, 1, 5, 10 or 30 minutes.
- Color System: The coding system used in analogue transmissions. Available options are: PAL 50 Hz, PAL 60 Hz, PAL-M, NTSC and SECAM.
- Boot Screen: User can select the image that appears when the equipment is booting.
- Values Format: It allows the user to select the format to show on fields PID, NID, ONID, TSID and SID in TV mode screen 3/3. Available formats are decimal or hexadecimal.

► Time & Date Options

- Date: It allows the user to edit the date. Press the joystick for edit mode.
- Time: It allows the user to edit the time. Press the joystick for edit mode.



- **Date Format:** It allows the user to change the date format, which is the order in which is shown day (DD), month (MM) and year (YYYY or YY).

► **Measurement Options**

- **Terrestrial Units:** It allows the user to select the terrestrial measurement units for the signal level. Available options are: dBm dBmV and dB μ V.
- **Satellite Units:** It allows the user to select the satellite measurement units for the signal level. Available options are: dBm, dBmV and dB μ V.
- **Satellite Band:** It allows the user to select the type of satellite band used between Ku/Ka band and C band.
- **Reference Level:** It allows the user to select the type of reference level adjustment between manual (modified by the user) or automatic (selected by the equipment).
- **TER. Downlink:** If this option is enabled it allows you to set a local oscillator in terrestrial band from Settings  and it displays intermediate and downlink (DL) frequencies calculated from local oscillator. For example, it allows you to work with terrestrial radio-links or frequency converters.
- **Min. TER. Power:** It sets the minimum power for a terrestrial digital signal to be identified when channel exploring.
- **Min. SAT. Power:** It sets the minimum power for a satellite digital signal to be identified when channel exploring.
- **Min. TER. Level:** It sets the minimum level for a terrestrial analogue signal to be identified when channel exploring.
- **Min. FM Level:** It sets the minimum power for a FM signal to be identified when channel exploring.
- **Input Impedance:** It allows the user to select the impedance at the RF input between 50 Ω and 75 Ω .
- **Power Offset:** It adds this value to the power/level measurement. When this value is different to 0 dB, next to power/level measurement an asterisk (*) is shown as a warning that offset is been applied.

► **Tools Options**

- **Datalogger PSI:** If you select the option "**Capture**", when datalogger is working it captures the service list of each channel. This process slows the datalogger, but provides additional information that can be downloaded in XML files. To disable this option select "**Don't capture**".
- **Database Services:** When it is enabled, it saves all the services been detected in the current installation. There is a database for services in terrestrial band and another for services in satellite band. Services are included automatically when the signal is locked. If enabled, these



services will be displayed on the "**View all services**" option in the **Tuning**  menu.

- Export Button: It allows the user to select the data to be exported when pressing the export key among the following options: screen only, data only or both. More info in the "Export key" chapter.
- LTE Filter F. Min: Select the minimum frequency for the external LTE filter.
- LTE Filter F. Max: Select the maximum frequency for the external LTE filter.
- Center Frequency: User can set the center of frequency to **Manual or Auto mode**. In Manual mode the user sets the frequency center and the equipment does not change it never, so the main cursor can be moved out of screen. In Auto mode the equipment changes the center of frequency to display always the main cursor on screen.

► **Stealth-ID Options**

It allows the user to select the set of signal types being used while auto identifying any modulation type. More information in the "StealthID function" chapter.

► **Security Options**

It allows the user to change the PIN code that gives access to protected data fields. The default PIN code is "1234". To change the PIN, first enter the current PIN code, then enter the new PIN.



In case the user forgets the PIN, after the third attempt, a 12-digit code will appear on screen. Sending this 12 digit code to the PROMAX customer service, the user will recover the PIN.



4 RF SIGNAL TUNING

4.1 Introduction

On the panel left side, the equipment has three functions keys, which give direct access to three ways to display RF signal.

- MEASUREMENT : This mode shows main measures of RF signal and allows you to identify if any measure is above or below usual values.
- SPECTRUM ANALYZER : This mode shows spectrum and allows you to visually identify any anomalies over the RF signal.
- TV : This mode shows RF signal demodulated and allows you to check broadcasting quality for video and audio.

Pressing a key repeatedly provides access to a different view within the same mode displaying different windows. Each view combines several RF modes (demodulated, spectrum, measures) which is very convenient to identify problems.

The StealthID function is an auto-identification system which identifies type and characteristic parameters of the signal and then tries to tune and demodulate it with no need to enter any parameter by hand.





4.2 Operation

- 1 Connect the RF input signal to the equipment.
- 2 Press the "Settings" key  to access Settings menu. From Settings menu access the "Band" option and select "Terrestrial" to work on terrestrial band or "Satellite" to work on satellite band.
- 3 Select the display mode by pressing the MEASUREMENT, SPECTRUM ANALYZER or TV mode. Pressing a key repeatedly provides access to different views.
- 4 Enter frequency or channel using the "Tuning" (F1) menu or using the joystick to go left or right along the frequency / channel band.
- 5 Once you are placed on the channel or frequency, the StealthID function tries to identify and lock the signal and its characteristic parameters and will show results on screen.



4.3 General Menu Options

At the bottom of the screen four menus are accessible via the softkeys or function keys.

-  F1 It displays the channel where is pointing the cursor and gives access to the tuning menu.
-  F2 It displays the selected transmission standard and gives access to the signal parameters menu.
-  F3 It displays the Tools menu.
-  F4 It displays the Advanced menu.

In general, these options are the same for all modes (Measurement, Spectrum Analyzer and TV).

The specific options for a mode are placed in the menu "Advanced" pressing the key .

In next sections each one of these menus is described.

4.3.1 F1: Tuning - Selecting Channel / Frequency

Press  to access. It contains tuning options.

Tuning options are:

► Channel/Frequency

It displays the channel/frequency pointed by the cursor. Tuning type (channel/frequency) is selected by means of the Tune by option

► Channel Plan

This option allows the user to select a channel plan from the ones available for the current installation.



► Tune by

It allows the user to select between tuning by channel (selecting a channel or channel by channel with the joystick) and tuning by frequency (selecting a frequency or step by step with the joystick).

In case of tuning by channel:

- 1 Place over the **Channel** option and press the joystick.
- 2 A box appears with all channels of the active channel plan and its frequency.
- 3 Move the joystick on the box to select a channel.
- 4 After finished press the joystick to save the selected value or any function key to exit without saving.
- 5 The cursor will place on the selected channel and it will appear on the  option.
 - Channels can be changed directly with the joystick in CH mode.

NOTE: When using tune by channel on satellite, the polarity parameters (horizontal/vertical and left/right) and satellite band (high/low) are selected automatically by the equipment, according to the channel plan enabled and cannot be changed by the user. To change these parameters, the user may switch to frequency tuning. But the user can change the voltage output while in a channel plan, as long as none has been defined in that same channel plan. For instance, if a standard channel plan is being used like the CCIR, there is no need for switching to frequency tuning mode.

In case of tuning by frequency:

- 1 Place over the **Frequency** option and press the joystick.
- 2 The option is highlighted in yellow to indicate it is in edit mode.
- 3 Move the joystick left/right to move between the figures and up/down to change the figure.
- 4 After finished press the joystick to save the selected value or any function key to exit without saving.
 - The frequency can be changed directly with the joystick in FR mode in 50 kHz steps.



[Click here to watch this video: Manual input of frequencies](#)

► Center Frequency

This option is available only for the Spectrum Analyzer mode. It allows to edit the center frequency. The center frequency is the frequency at which the screen is centered.

► Reference Level

This option is available only for the Spectrum Analyzer mode. It allows you to edit the reference level. The reference level is the power range represented on the vertical axis.

The Reference Level can be changed directly pushing the joystick up or down.

► Span

This option is available only for the Spectrum Analyzer mode. It allows to edit the span, which is the frequency range displayed on screen on the horizontal axis. The current span value appears on screen at bottom right.

► Center Tuned Frequency

This option is only available for the Spectrum Analyzer mode. When selecting this option, the frequency tuning (where the main cursor is pointing) is placed at the center of the screen. This option does not work with FULL span or if main cursor is very close to terrestrial or satellite band boundaries.

► Downlink

This option shows up if "Terrestrial Downlink" option in Preferences is enabled and if it is selected tune by frequency. It displays downlink (DL) frequency calculated from local oscillator value. To set a local oscillator value press Settings  from terrestrial band.

► View all services

This option only appears if the Database services option is enabled in the Preferences menu.







This option displays a window with a list of services that have been detected in the current installation.

The list shows service name, provider, SID (stream identifier) and an icon that shows its type (radio, TV) and if it is scrambled. When hovering on the service for one second it displays a hint window with more information.

If user presses the joystick on a service, it will access that service. When disabling the Database services option, all services in the installation will be deleted from the list.

At the bottom of this option are shown the softkeys with these functions:

-  F1 Cancel: It exits the option.
-  F2 Filter List: It shows several options to filter the list of services:
 - By access (Free Only, Scrambled Only, All).
 - By type (All, TV, Radio).
 - Search by name (filtered by the name).
 - Reset list (it restarts the list as at first) Service filtering is persistent until resetting.
-  F3 Page Up: It jumps one page up.
-  F4 Page Down: It jumps one page down.

4.3.2 **F2: Signal Parameters**

Access by the  function key. It allows selecting the standard transmission and displays the parameters for signal transmission. It also allows you to enable / disable StealthID auto-identification function.

► **Signal Type**

It displays the selected standard. It allows selecting another standard in the same band (terrestrial or satellite):

- 1 Place over the **Signal Type** option and press the joystick.
- 2 It displays a menu with transmission standards.
- 3 Move the joystick up / down to select a standard.



- 4 Press joystick to select the standard or any function key to exit without selecting.

► View Advanced Parameters

It shows the TPS parameters (Transmission Parameters Signalling) for the locked signal according to the modulation standard. This option is available only when these parameters are detected. The remaining transmission parameters are detected demodulating the locked signal.

- In case of a DVB-S/S2 signal, the symbol-rate parameter can be set manually.
- In case of a Generic signal, the bandwidth of the channel can be set manually.

In case of a DVB-S2 signal, there will be some special settings for this type of signal. They are:

- Physical Layer Scrambling or PLS is used in DVB-S2 as a way to improve data integrity. A number called the "scrambling sequence index" is used by the modulator as a master key to generate the uplink signal. This same number must be known by the receiver so that demodulation is possible.



[Click here to watch this video: DVB-S2 multi stream decoding](#)

- Most satellite transponders use PLS 0 as a default value but there are some transponders that use other values.
- If it is a multistream signal (MIS), it will appear an option that enables filtering by the input stream identifier (ISI) and to select the stream to demodulate (by default it will randomly select one stream from the signal).



► Stealth-ID

The **StealthID** function is a RF signal identification function performed automatically by the equipment without any user intervention.





The equipment tries to identify the channel or frequency of the input signal it receives, and according to the band selected by the user (terrestrial or satellite), it applies identifying criteria according to the standards available on that band. When the equipment recognizes in the input signal the identification parameters of a specific standard, it decodes and identifies data of that signal.



Settings:

- 1 Press the **Preferences** key  for 1 second.
- 2 In the **StealthID** tab, select the signal types to auto-identify. By default all them are selected. Press the  key to save the changes made and the  key to exit the **Preferences** screen.

Operation:

- 1 Press the  key and check the StealthID option is ON.
- 2 Press the **Settings**  key.
- 3 Select the band (terrestrial or satellite).
- 4 Select a channel or frequency to identify.
- 5 The bottom of the screen shows the message "**Searching for signal**" and the standard transmission checking. The identification system tries to lock the first signal using the modulation defined in the channel plan for that signal. If after five seconds it fails to lock with that modulation, it starts the wheel for automatic detection. If then it locks in a modulation other than indicated, it generates an internal temporary channel plan to accelerate tuning the same channel later on.
- 6 Wait a few seconds for the equipment to identify the signal. User can force the auto-identification of a signal by pressing the  key and selecting the type of signal from the menu.
- 7 When the equipment identifies the signal it displays on screen its standard and type.
- 8 Press  **Signal Parameters** to see all signal parameters.
- 9 Once the signal has been identified, to disable auto-identification press  and on StealthID option select OFF. Doing this, if it unlocks the signal, the system will try to lock the same type of signal, without restarting the auto-identification.

Signals automatically detected

- Digital Terrestrial Television First Generation (DVB-T).
- Digital Terrestrial Television Second Generation (DVB-T2: T2-Base and T2-Lite profiles).
- Digital Satellite Television First Generation (DVB-S).
- Digital Satellite Television Second Generation (DVB-S2).







- Digital Satellite Television, exclusive for DirecTV (DSS).
- Digital Cable Television First Generation (DVB-C).
- Digital Cable Television Second Generation (DVB-C2)
- Analogue terrestrial TV.
- Analogue Cable TV.
- Analogue Terrestrial FM

4.3.3 F3: Tools

Access by the  key. It shows the Tools menu. If a specific tool is not available for the signal locked then the option is disabled. Tools are:

- **Select Service:** It displays the list of services available in the multiplex tuned, with the service name, icons that identify the service type, SID (stream identifier) and LCN (logic channel number). Icons that appear next to the service name identify the features of the service. The meaning is given in the following table:

	Digital TV service		High Definition TV service
	Digital radio		Data
	Scrambled service		

- **Explore Channel Plan:** It explores the selected channel plan. Tune by channel must be selected.
- **Field Strength:** This function allows the equipment to measure as a field strength meter.
- **Datalogger:** It creates a file in which are stored measurements. This file belongs to the selected current installation.
- **Echoes:** It detects the echoes that may appear due to the simultaneous reception of the same signal from several transmitters.
- **Constellation:** It displays the constellation of the locked signal.
- **LTE Ingress Test:** It enables the detection of signal interferences coming from mobile phones.
- **Attenuation Test:** This feature allows the user to easily check the response of the telecommunications installations before antennas and headers are working.
- **Task Planner:** This function allows the user to schedule specific tasks.



For more information about these features, see the "**Tools**" chapter.

4.4 Advanced Options

Press key , to access advanced options for the mode selected.

► Advanced Menu in Spectrum Analyzer mode

- **Average:** The user can select the amount of signal values to be used to set the average signal value to be displayed on screen. The larger the average value, the more stable the displayed signal appears.
- **Spectrum Line:** It defines the spectrum display. The Outline option displays the spectrum outline. The Solid option displays the contour of the spectrum with solid background. The Transparence option shows the outline in yellow and the background in a softer yellow.
- **Tone Level:** This option produces a tone that changes according to the input level of the signal so the tone is sharper if the level increases and deeper if the level decreases.
- **Marker:** It allows enabling/disabling the marker. This marker is displayed on screen with the shape of an arrowhead, showing on screen some information about the frequency and power level where it points. You can move left/right by the joystick in MK mode (press the joystick until the icon MK appears). When the Marker is ON at the top right corner a window pops up with the following data:
 - Freq: Frequency where is placed the marker.
 - Level: Power level at the frequency where is placed the marker.
 - ΔF: Difference of frequency between the marker and the main cursor.
 - ΔL: Difference of power level between the marker and the main cursor.
- **Marker Trace:** It allows the user to select the trace to place the marker on:
 - Normal: It places the marker on the spectrum trace in real time.
 - Reference: It places the marker on the spectrum reference trace. To make a spectrum reference use the Reference function.
 - Max. Hold: It places the marker on the max. hold trace. To make a maximum hold trace use the Max. Hold function.
 - Min. Hold: It places the marker on the min. hold trace. To make a minimum hold trace use the Min. Hold function.
- **Max. Hold:(Off/Permanent/Curtain).** It allows the user to display the current signal with the maximum values measured for each frequency. The OFF option disables this function. The Curtain option displays the maximum values in blue for a moment with the current signal. The Permanent option maintains maximum signal on the screen. This option is especially useful for detecting sporadic noises.
- **Min. Hold: (Off/Permanent/Curtain).** It allows the user to display the current signal with the minimum values measured for each frequency. The



OFF option disables this function. The Curtain option displays the minimum values in green for a moment with the current signal. The Permanent option maintains minimum signal on the screen. This option is useful for detecting interferences in TV cable or identify deterministic interference in analogue and digital channels.

- Persistence: When active, the signal is displayed on a coloured background. The signal prior to current signal persists for a while before disappearing so the user can see how the signal changes easily.
- Detector Type: (PEAK/RMS). It allows the user to select between maximum PEAK detector or RMS detector. The maximum peak detector is mainly used for analogue modulated signals, while the RMS option is the right choice for digital modulated signals. The max PEAK detector is mostly used for analogue modulated signals, while the RMS is the proper choice for digital modulations. The maximum peak detector causes the noise floor to rise, according to the RMS to peak ratio. That same effect causes digital signals to apparently grow in level when maximum peak detector is used.
- Vertical Range: It allows setting the vertical scale on screen. Available values are 1, 2, 5 and 10 dB per division.
- Dashed BW: When it is ON the channel bandwidth area is hatched by lines.
- Reference: (Set / Clear). It memorizes the current trace on screen, which can be used as a reference for further comparison. It may be also very helpful for visually measure the gain or attenuation in a TV distribution network. To delete the reference, select the "clear" option. The trace can be also captured by a short press on the export key  in the Spectrum Analyzer mode. Pressing short again on the export key it clears the reference.

► Advanced Menu in TV mode

- Analogue Signal: This option is available only if the detected or selected signal is ANALOGUE. Pressing the  key it allows you to select the source for the analogue signal between antenna (via RF connector) and external (via V/A input connector). To get an external analogue signal use the A/V input.
- Aspect Ratio: This option is available only if the detected or selected signal is ANALOGUE. It allows the user to select the image aspect ratio (4:3; 16:9). It remembers this selection even after switch off.
- Advanced: This option is available only if the detected or selected signal is DIGITAL. There are these options:
 - Audio: It allows the user to select among the audio tracks available.
 - TS Data: It shows the IRG data descriptor. If the signal contains this carrier identifier, this option will be enabled. If the signal does not contain



this identifier, the option will be disabled (for more information refer to section "IRG descriptor").

- Discovered URLs: If shows the URL related to the interactive service.

4.5 Screen Description

The information that appears on screens for each mode (Measurement mode, Spectrum mode and TV mode) is described below. To change the mode, press the corresponding mode key. To change the screen in the same mode, press the same mode key consecutively.

4.5.1 Measurement Mode Screens

► FULL MEASUREMENT (MEASUREMENT 1/3)

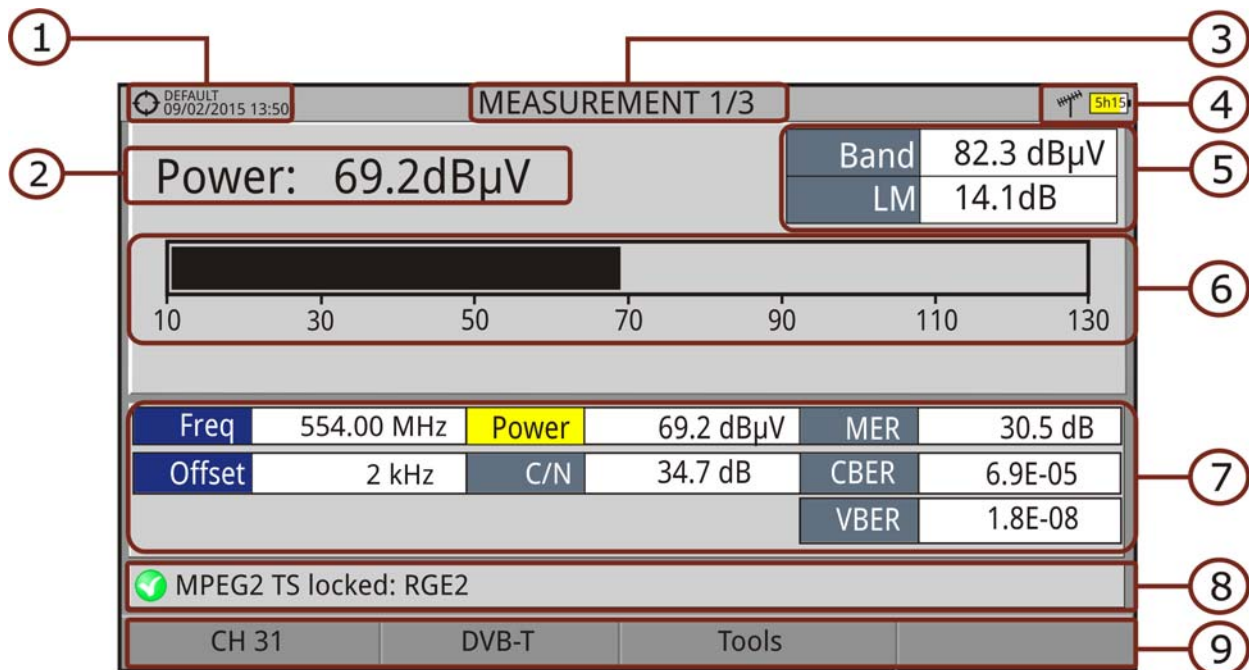

Figure 23.

- 1 Selected installation, date and time.
- 2 Main measurement and its numeric value. To select another main measurement move joystick up / down. It keeps main measurement selection even after changing screen or switching off.
- 3 Number of view/total views.
- 4 Selected band, battery level.



- 5 Total power detected over the whole selected band (terrestrial or satellite). The total power can be used to know when it is close to saturation. It also shows the link margin measurement. The link margin is the margin of safety remaining for a good reception.
- 6 Graphical measurement of the main measurement.
- 7 Measurement values for the type of locked signal.
- 8 Signal status (searching/locked/multiplex name).
- 9 Softkeys menus.
 - Joystick functions:
 - Joystick up/down: Change of main measurement on screen.
 - Joystick left/right: Change of channel/frequency.

► MEASUREMENT + TV + SPECTRUM (MEASUREMENT 2/3)

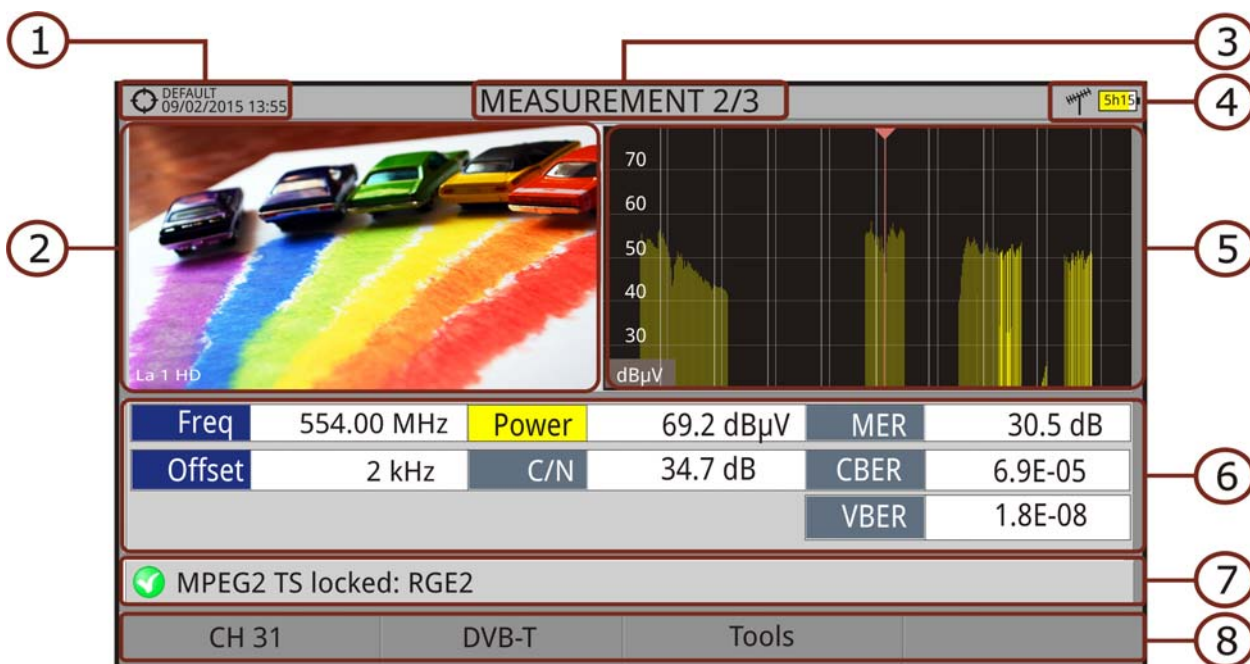

Figure 24.

- 1 Selected installation, date and time.
- 2 Image of locked signal.
- 3 Number of view/total views.
- 4 Selected band, battery level.
- 5 Spectrum of locked signal.
- 6 Measurement values for the type of locked signal.
- 7 Signal status (searching/locked/multiplex name).
- 8 Softkeys menus.



- Joystick functions:
 - Joystick left/right: It changes channel/frequency.

► MEASUREMENT + PARAMETERS (MEASUREMENT 3/3)

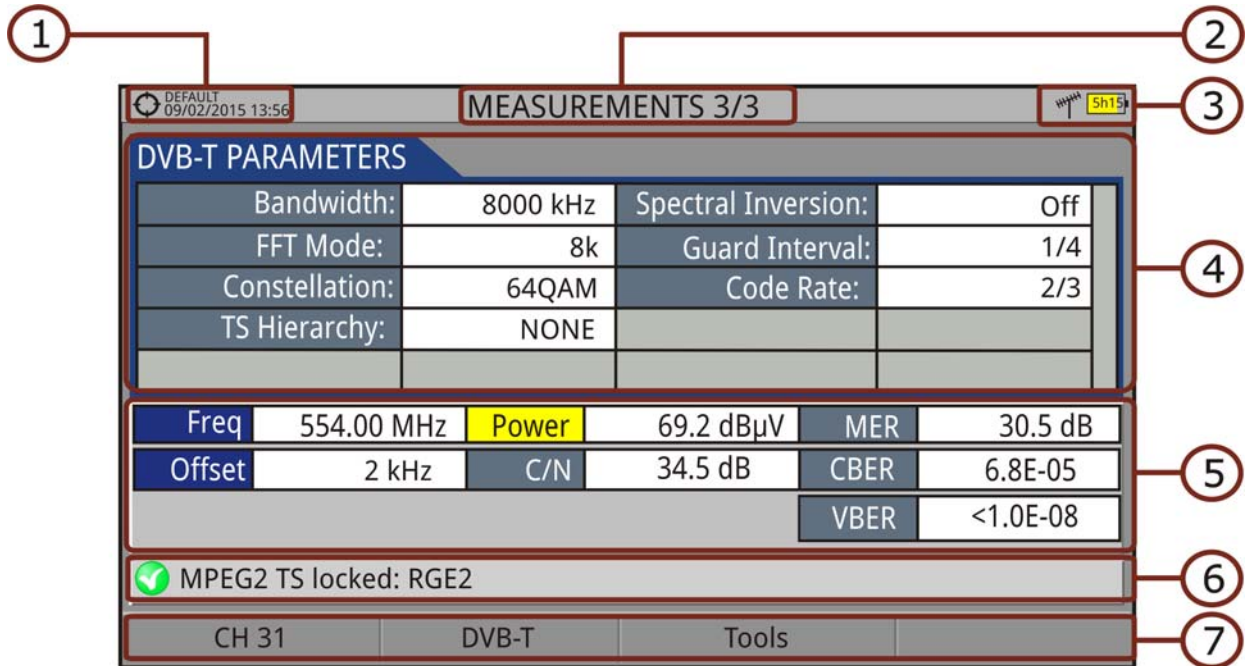

Figure 25.

- 1 Selected installation, date and time.
- 2 Number of view/total views.
- 3 Selected band, battery level.
- 4 Demodulation parameters for the locked signal.
- 5 Measurement values for the type of locked signal.
- 6 Signal status (searching/locked/multiplex name).
- 7 Softkeys menus.

- Joystick functions:
 - Joystick left/right: It changes channel/frequency.



4.5.2 Spectrum Analyzer Mode Screens

► SPECTRUM + MEASUREMENT (SPECTRUM 1/3)

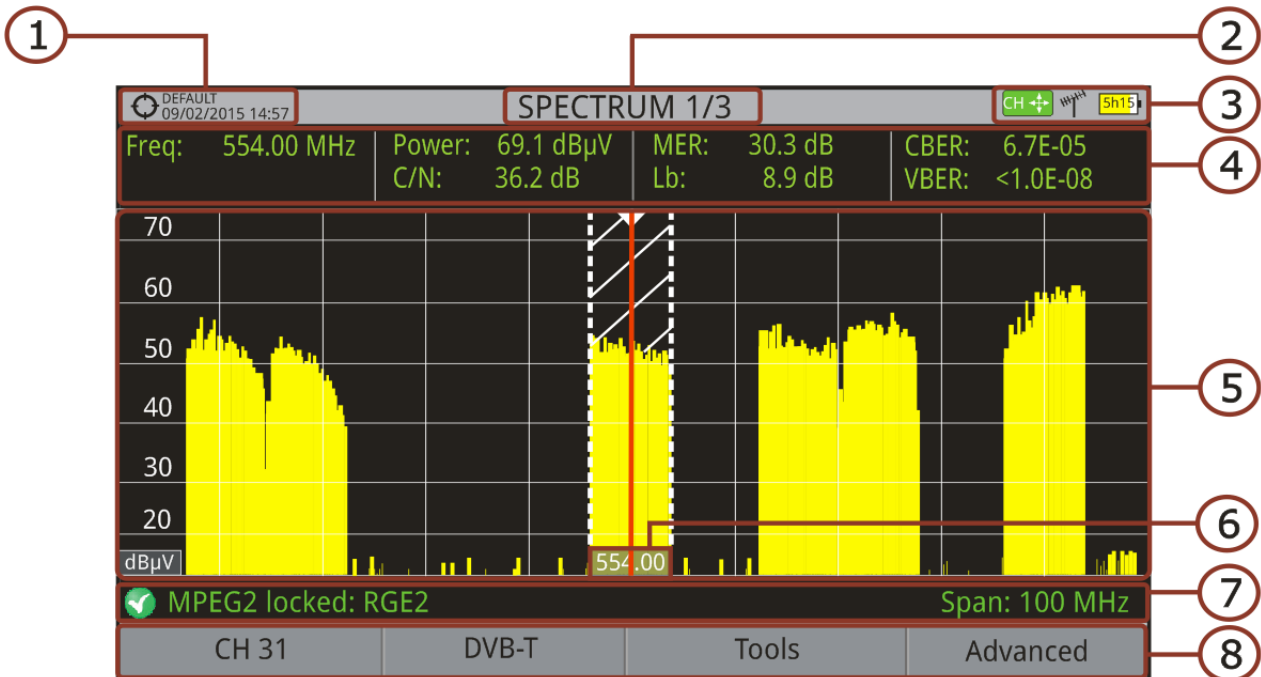

Figure 26.

- 1 Selected installation, date and time.
- 2 Number of view/total views.
- 3 Joystick active mode, selected band, battery level.
- 4 Measured values of the signal at the frequency/channel where is pointing the cursor.
- 5 Spectrum in the band with the selected span.
- 6 Centre frequency and cursor. It also shows the bandwidth of a digital locked signal.
- 7 Signal status (searching/locked/multiplex name/selected span).
- 8 Softkeys menus.
 - Joystick functions:
 - Joystick up/down: It changes reference level.
 - Joystick left/right (depending on the joystick active mode):
 - SP: Span change.
 - FR or CH: Frequency change or Channel change.
 - MK: Marker change (if marker is enabled).



► SPECTRUM + MEASUREMENT + TV (SPECTRUM 2/3)

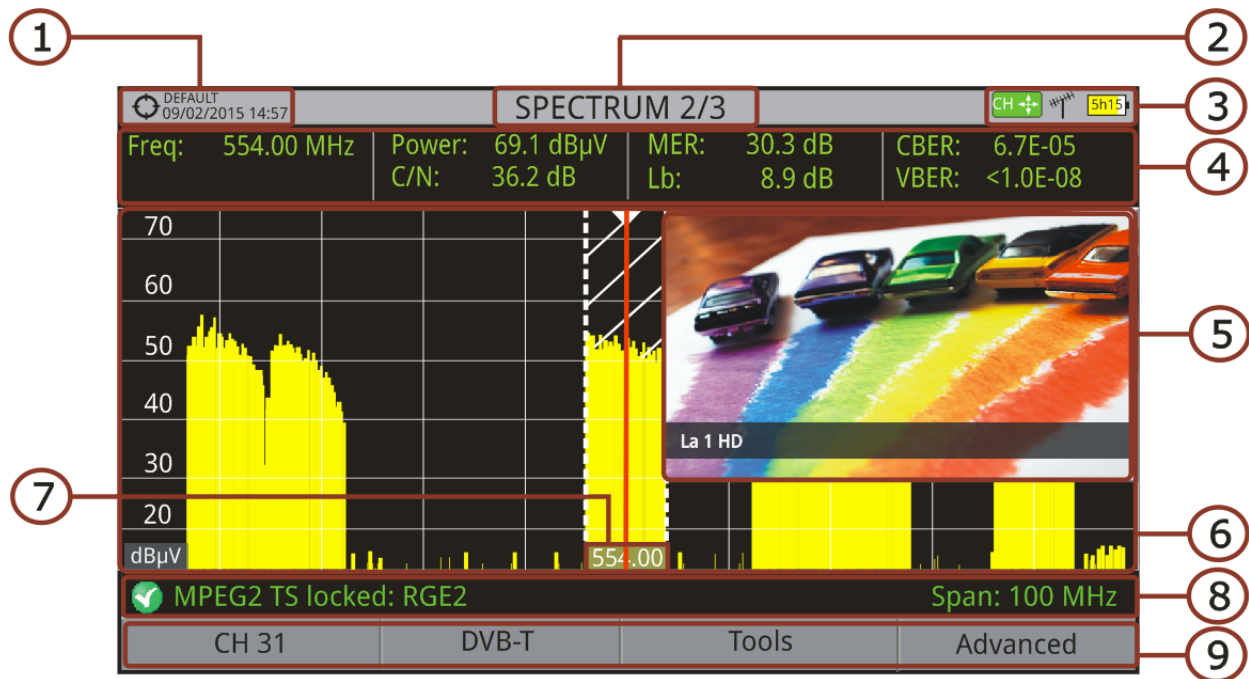

Figure 27.

- 1 Selected installation; date and time.
- 2 Number of view/total views.
- 3 Joystick active mode; selected band; battery level.
- 4 Measured values of the signal at the frequency/channel where is pointing the cursor.
- 5 Image of the tuned signal.
- 6 Spectrum in the band with the selected span.
- 7 Centre frequency and cursor. It also shows the bandwidth of the digital signal locked.
- 8 Signal status (searching/locked/multiplex name/selected span).
- 9 Softkeys menus.
 - Joystick functions:
 - Joystick up/down: It changes reference level.
 - Joystick left/right (depending on the joystick active mode):
 - SP: Span change.
 - FR or CH: Frequency change or Channel change.
 - MK: Marker change (if marker is enabled).



► FULL SPECTRUM (SPECTRUM 3/3)

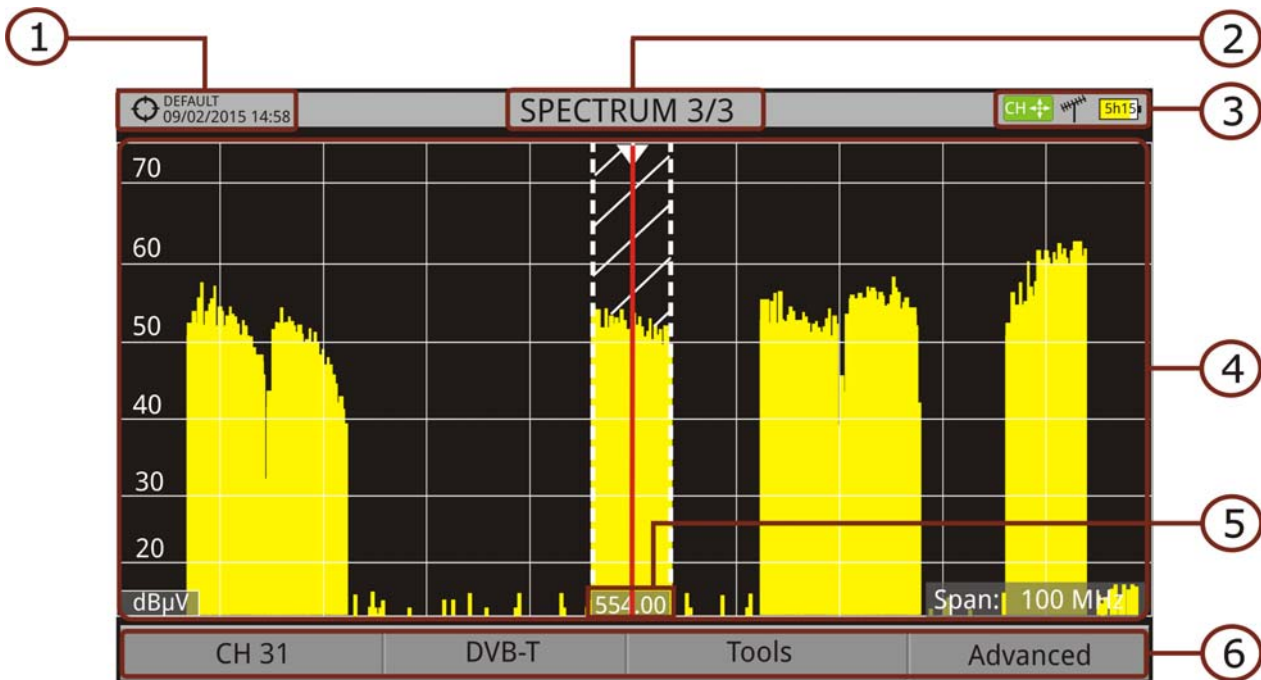

Figure 28.

- 1 Selected installation, date and time.
- 2 Number of view/total views.
- 3 Joystick active mode; selected band; battery level.
- 4 Spectrum in the band with the selected span.
- 5 Centre frequency and cursor. It also shows the bandwidth of a digital signal locked.
- 6 Softkeys menus.
 - Joystick functions:
 - Joystick up/down: It changes reference level.
 - Joystick left/right (depending on the joystick active mode):
 - SP: Span change.
 - FR or CH: Frequency change or Channel change.
 - MK: Marker change (if marker is enabled).

► FULL SPECTRUM (SPECTRUM 3/3) WITH MARKER

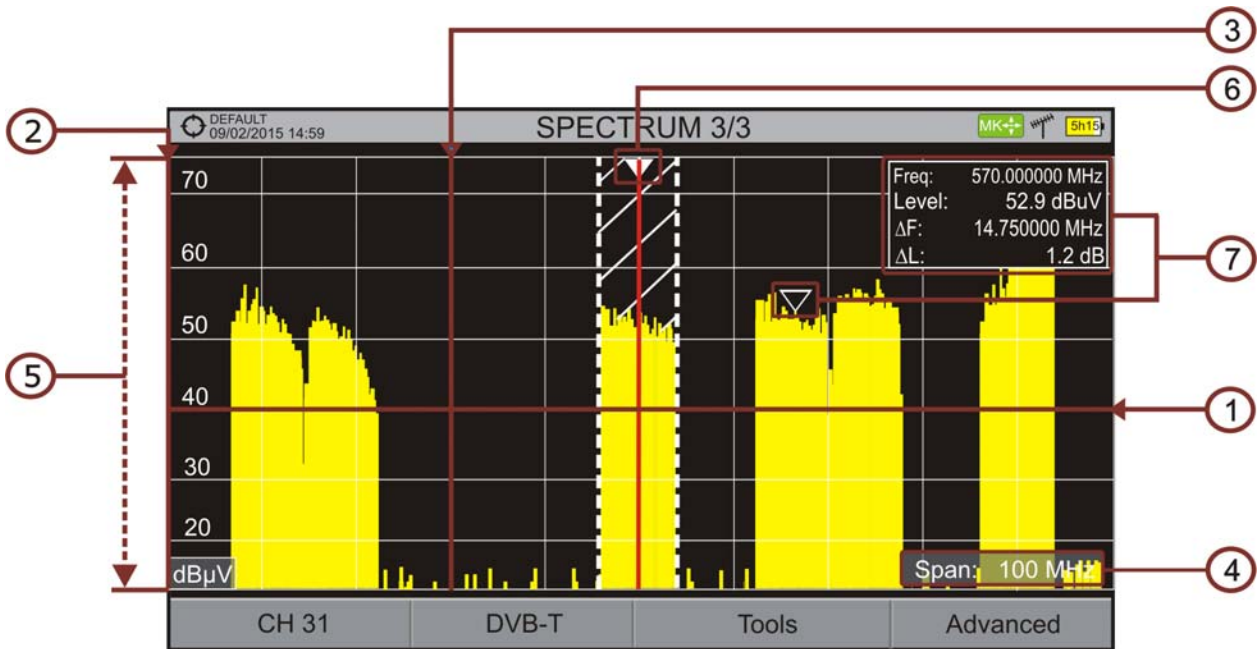

Figure 29.

- 1 Horizontal reference line: It shows level of signal.
- 2 Vertical axis: It indicates the signal level.
- 3 Vertical reference line: It indicates the frequency.
- 4 SPAN: It is the frequency range displayed on the horizontal axis. Span values available changes according to Resolution Bandwidth selected. The current span value appears at the bottom right of the screen. To switch among span default values use the joystick (left, right) in span mode (SP). For example, for RBW = 100 kHz default span values are Full (full band), 500 MHz, 200 MHz, 100 MHz, 50 MHz, 20 MHz and 10 MHz. To change to any other span value in that frequency range use the "span" option in the Tuning menu (F1 key).
- 5 Reference Level: It is the power range represented on the vertical axis. To change use the joystick (up, down; 5 dB steps). This equipment has an option to activate the automatic adjustment of the reference level, so it detects the optimal reference level for each situation. In automatic mode, it sets the optimum reference level each time it enters the spectrum mode. This option can be enabled or disabled through the **PREFERENCES** menu and **Measurements** tab.
- 6 Cursor: Red vertical line that indicates position during the channel or frequency tuning. When a digital signal is detected, there is a triple cursor that shows the frequency for the signal locked and two vertical lines that shows the bandwidth of the digital carrier. In the case of a GENERIC signal, the bandwidth shown is the one selected by the user on the "Signal Parameters" menu when pressing the F2 key. To change frequency/channel



use the joystick (left, right) in FR mode (tuning by frequency) or CH mode (tuning by channel).

7 Marker: It is a special cursor that can be placed on a given frequency to check the power in this point. This option can be enabled using the "Marker" option from the Advanced menu (F4 key). To change use the joystick (left, right) in MARKER (MK) mode. The window Marker shows the following data::

- Freq: Frequency where is placed the marker (MHz units; accurate to Hz).
- Level: Power level at the frequency where is placed the marker (in case of working with FSM tool, it shows FSM level).
- ΔF: Difference of frequency between the marker and the main cursor (MHz units; accurate to Hz).
- ΔL: Difference of power level between the marker and the main cursor.

8 Centre Frequency: Frequency at which the screen is centered. This frequency can be set through the **Tuning** key (F1). It also changes when moving the cursor out of screen.

4.5.3 TV Mode Screens

► FULL TV (TV 1/3)

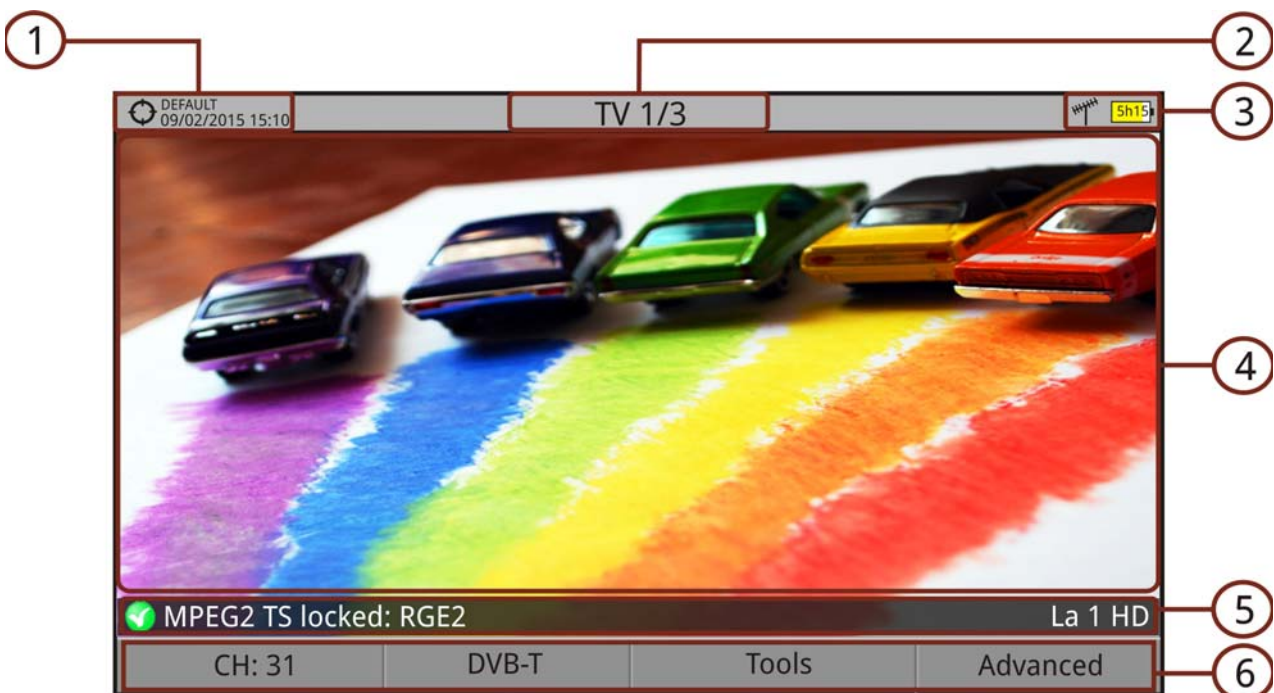

Figure 30.

- 1** Selected installation; date and time.
- 2** Number of view/total views.
- 3** Selected band, battery level.
- 4** Tuned service image.



- 5 Signal status (searching/locked/multiplex name) and name of the selected service.
- 6 Softkeys menus.
 - Joystick functions:
 - Joystick up/down: It changes service.
 - Joystick left/right: It changes channel/frequency (depending on the tuning mode).

► TV + SPECTRUM + MEASUREMENT (TV 2/3)

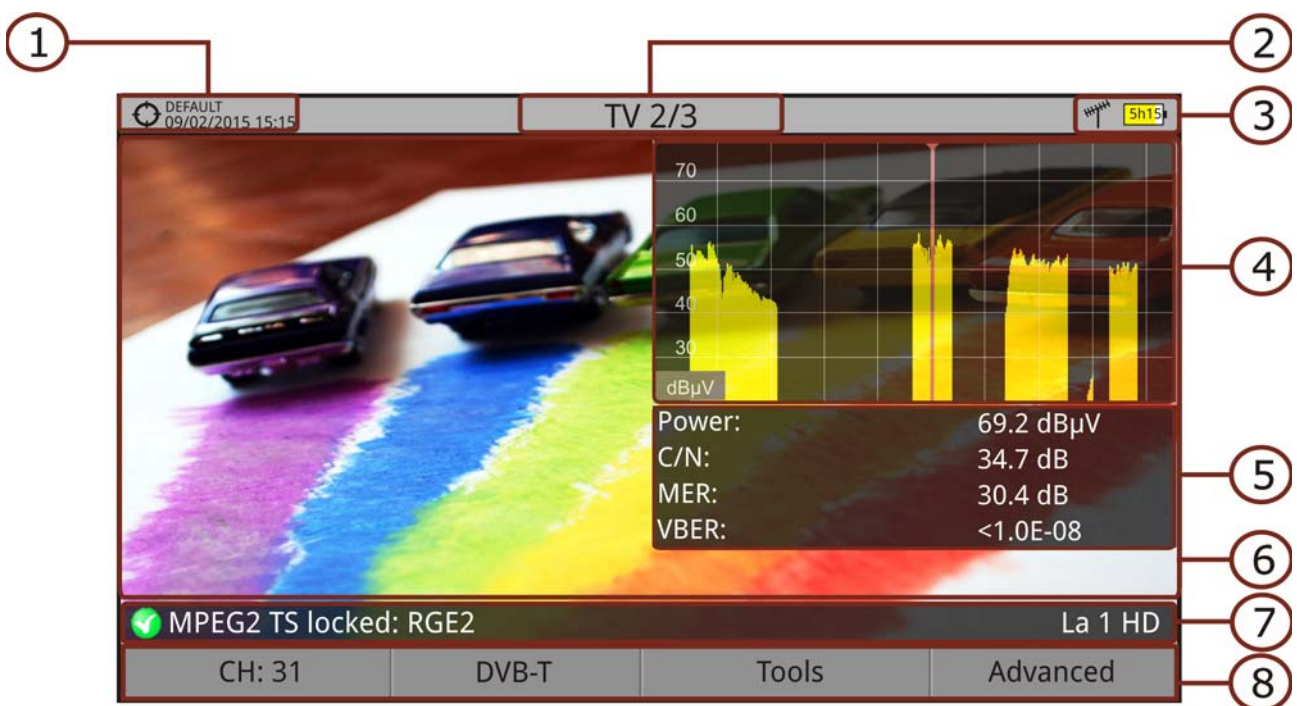

Figure 31.

- 1 Selected installation; date and time.
- 2 Number of view/total views.
- 3 Selected band, battery level.
- 4 Tuned service image.
- 5 Spectrum.
- 6 Measured values of the signal in the frequency/channel the cursor is pointing.
- 7 Signal status (searching/locked/multiplex name) and name of the selected service.
- 8 Softkeys menus.



- Joystick functions:
 - Joystick up/down: It changes service.
 - Joystick left/right: It changes channel/frequency (depending on the tuning mode).

► TV + SERVICE DATA (TV 3/3)

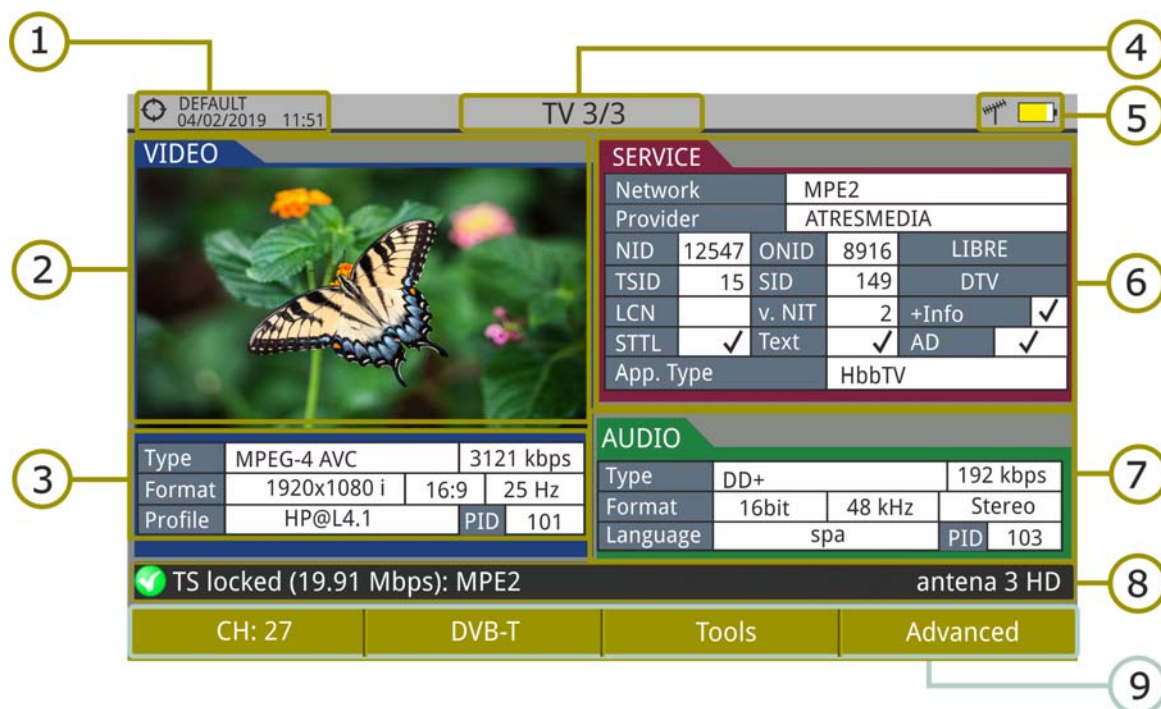

Figure 32.

- 1 Selected installation; date and time.
- 2 Tuned service image.
- 3 Tuned service information.
 - TYPE: Encoding type and video transmission rate.
 - FORMAT: Resolution (horizontal x vertical), aspect ratio and frequency.
 - PROFILE: Profile level.
 - PID: Video program identifier.
- 4 Number of view/total views.
- 5 Selected band; battery level.
- 6 Tuned service information.
 - NETWORK: Television distribution network (Terrestrial). Orbital position (Satellite).
 - PROVIDER: Program provider name.
 - NID: Network identifier where the signal is distributed.



- ONID: Identifier of the original network where the signal originates.
 - TSID: Transport stream identifier.
 - SID: Service Identifier.
 - App. Type: Type of detected interactive service such as HbbTV, MHP and MHEG-5. It also shows the URL related to the interactive service in F4: Advanced - Discovered URLs.
 - LCN: Logic Channel Number. It is the first logic number assigned to the first channel in the receiver.
 - +Info: Additional service information.
 - v. NIT: Network Information Table (NIT) version.
 - FREE/SCRAMBLED: Free/scrambled transmission.
 - DTV/DS: Standard type of transmission.
 - STTL: Subtitles available.
 - Text: Teletext available.
 - AD: Audio description available (for visually impaired).
- 7** Tuned Audio Information.
- TYPE: Type of audio encoding and transmission speed.
 - FORMAT: Service audio format. Bit depth; sampling frequency; sound reproduction.
 - LANGUAGE: Broadcasting language.
 - PID: ID of the audio program.
- 8** Signal status (searching/locked/multiplex name) and name of the selected service.
- 9** Softkeys menu.
- Joystick functions:
 - Joystick up/down: It changes service.
 - Joystick left/right: It changes channel/frequency (depending on the tuning mode).

NOTE: PID, NID, ONID, TSID and SID fields can be shown in decimal or hexadecimal format. To select this parameter go to "Values Format" in "Preferences" - "Appearance".



► **AUDIO RADIO (RADIO 1/3)**



Figure 33.

► **AUDIO RADIO + SPECTRUM + MEASUREMENT (RADIO 2/3)**

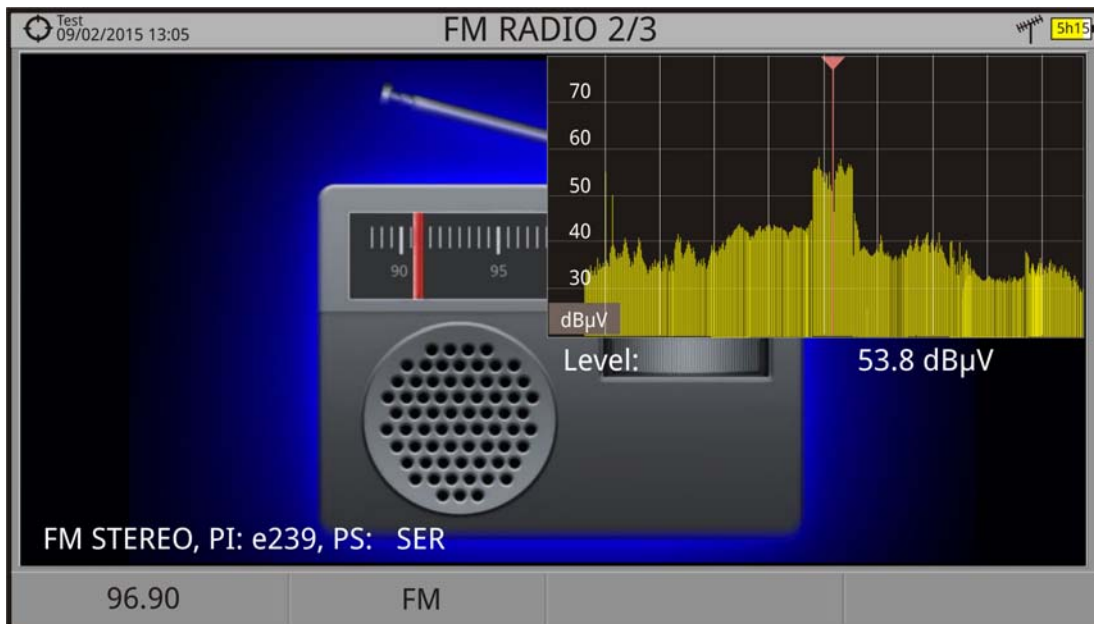

Figure 34.



► **AUDIO RADIO + RDS DATA (RADIO 3/3)**

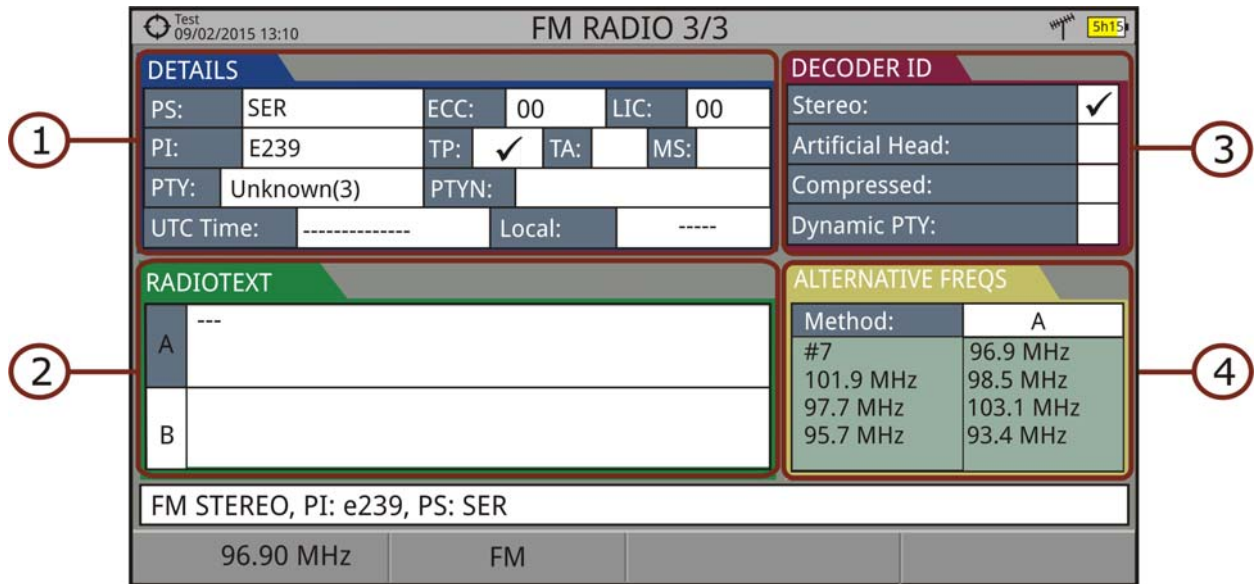

Figure 35.

- 1** RDS Data:
 - PS: Programme service.
 - PI: Programme Identification.
 - PTY: Program type.
 - UTC Time: Universal time.
 - Local: Local time.
 - ECC: Extended country code.
 - LIC: Language Identification Code.
 - TP: Traffic program.
 - TA: Traffic announcement.
 - MS: Music switcher.
- 2** Radiotext: Extra text information.
- 3** Decoder ID: It identifies different operation modes of the decoder.
- 4** Alternative Freqs: : It shows alternative frequencies and its total number.



4.6 Extra Information

4.6.1 Generic Signal

This is a special digital signal that the equipment does not demodulate. It can be used for special signals as DAB/DAB + or COFDM modulation with narrow BW.

In this type of signal the user can select the signal bandwidth by accessing the "Signal Parameters" menu on the  key.

The power measure and C/N ratio is calculated according to the bandwidth selected by the user. The triple cursor shows on screen the BW selected by the user.

4.6.2 Locking a Signal

- 1 Connect the cable with the input signal to the **RF** input connector.
- 2 Press  and enable StealthID function.
- 3 Press the **Spectrum** key. The spectrum of the signal is displayed.
- 4 Adjust the span (recommended value for a terrestrial signal 50 MHz and for a satellite signal 100 MHz). The current value of the span is at the right bottom of the screen.
- 5 Find the frequency of the signal by moving the joystick left or right.
- 6 If you know the channel number change the tuning by frequency to tuning by channel. The channel mode allows you to navigate from channel to channel, using the selected channel plan.
- 7 When the channel is locked information appears at the bottom left of the screen. A triple cursor shows the detected BW for a digital carrier.
- 8 The equipment automatically detects transmission parameters of the signal and makes the corresponding measurements.

4.6.3 Satellite Identification

The spectrum analyzer makes easier the fieldwork for engineers when working with SNG mobile units and VSAT communications, since it allows adjusting transmission-reception systems. It also has several functions to identify



satellites that avoid any possibility of error. When the signal is locked it identifies the satellite and shows on screen its name.

Often satellite operators request to look for the Beacon signal, as a method of satellite identification. This signal is easily identified by the meter, because it has high resolution, high sensitivity and short sweep times.

Below are two Beacon screen-shots signals, with a span of 10 MHz and a bandwidth of 100 kHz resolution, all with a sweep time of 90 ms.

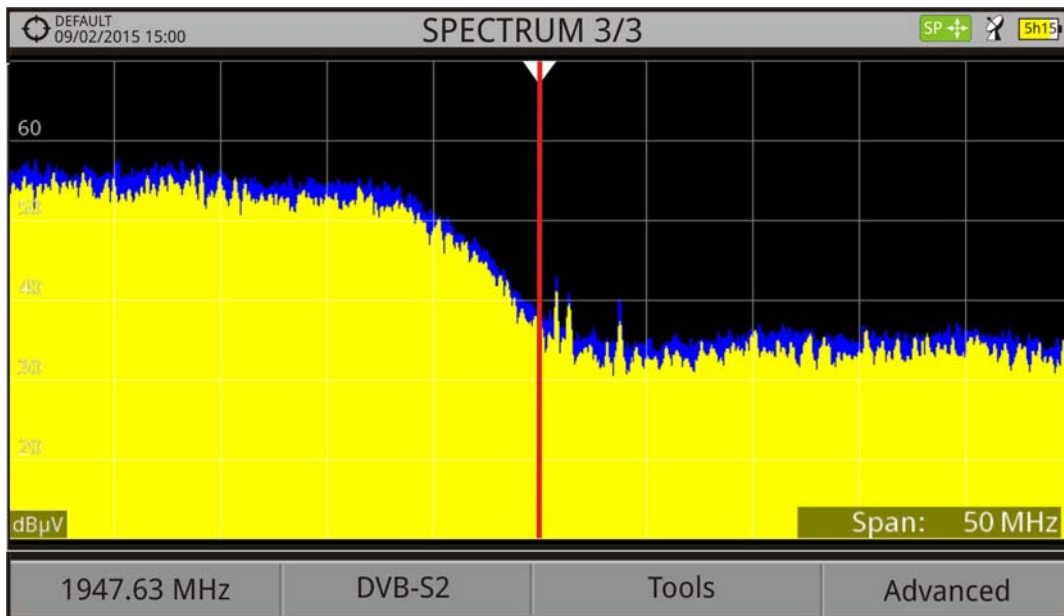

Figure 36.

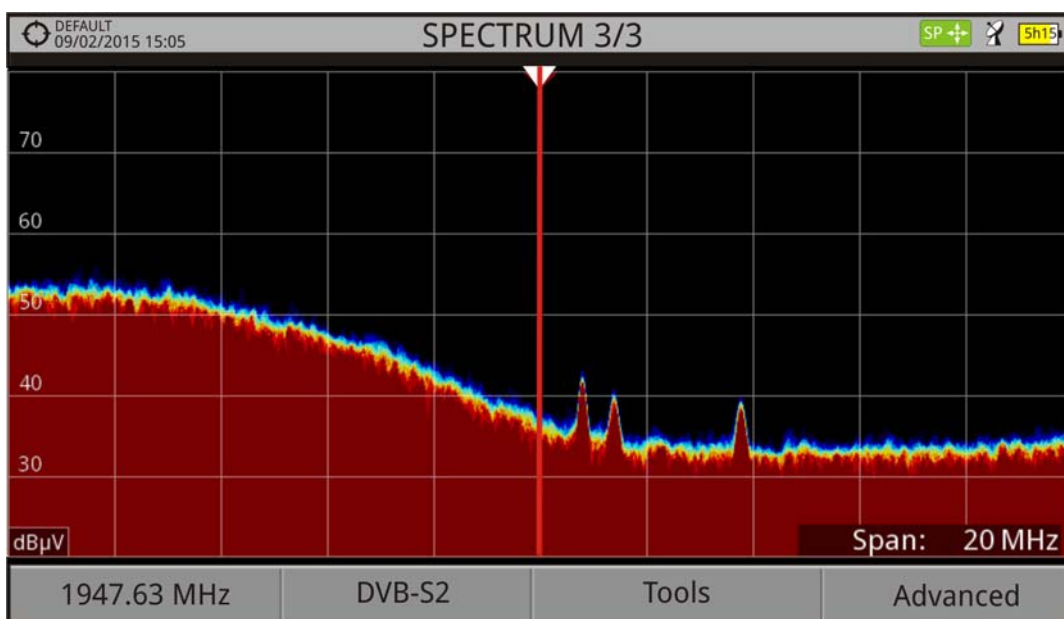

Figure 37.



More info about satellite signals in the application note "How to point a dish antenna" available on the PROMAX website.

4.6.4 IRG Descriptor

The analyzer is compatible with IRG recommendations and it can extract the Carrier ID information and display it conveniently showing all the details. This information is useful to identify the interference, thanks to the carrier ID. This identifier provides enough information to detect the interference source (customer name, contact data, geo coordinates, etc.) and allows the operators to communicate directly with the RFI source to resolve the incident.

IRG descriptor function is available only for signals containing the carrier identifier. To access this feature:

- 1 Connect the **RF** input signal to the equipment.
- 2 Tune the channel that produces interferences.
- 3 Access the **TV** mode.
- 4 Press the **Advanced** menu .
- 5 Select the **TS Data** option. If the signal has a carrier identifier, this option is enabled. If the signal does not contain this identifier, this option is disabled.
- 6 The **IRG descriptor** window is displayed with the data about the provider (see figure below).

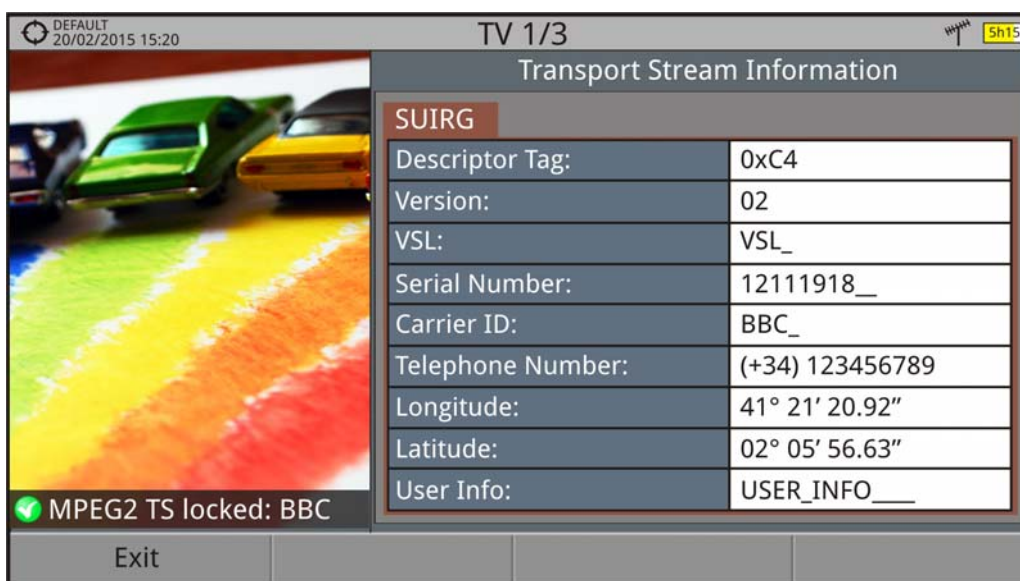



Figure 38.



5 TOOLS

5.1 Introduction

Tools are specific functions that complement the standard functions of the meter. These tools can help solve specific situations where the usual measurement is not enough. In this chapter, each of these tools is described in detail. It is advisable to know them to make the most of the meter potential.

Tools are accessible by pressing the key . Some tools may be disabled or unavailable when they are incompatible with the type of signal tuned.

The following lists shows all available tools and the type of signal they are compatible with:

Name	Type of Signal	Additional Data
Constellation	All digital signals	
LTE Ingress Test	All terrestrial digital signals	
Echoes	DVB-T, DVB-T2, DVB-C2	
Attenuation Test	All signals	
Datalogger	All signals	
Screen and Data Capture (Export key)	DVB-T, DVB-T2, DVB-S, DVB-S2, DSS, DVB-C, DVB-C2, analogue, FM, generic	
Explore Channel Plan	All signals	
Field Strength	All signals	
Task Planner	All signals	

5.2 Constellation

5.2.1 Description

The constellation diagram is a graphic representation of the digital symbols received over a period of time. There are different types of constellation diagrams according to the modulation type.

In the case of an ideal transmission channel without noise or interference, all symbols are recognized by the demodulator without errors. In this case, they are represented in the constellation diagram as well defined points hitting in the same area forming a very concentrated dot.

Noise and interferences cause the demodulator to not always read the symbols correctly. In this case hits are dispersed and create different forms which can visually determine the type of problem in the signal.



Each type of modulation is represented differently. A 16-QAM signal is shown on screen by a diagram of a total of 16 different zones and a 64-QAM signal is represented by a diagram of 64 different zones and so on.

The constellation diagram shows in different colours the density of hits and includes features to zoom, move and delete the display on screen.

5.2.2 Operation

The constellation is available to all **digital** signals, both **terrestrial** and **satellite**.

To access the **Constellation** tool:

- 1 Connect the **RF** input signal to the equipment.
- 2 Tune to a digital signal from satellite or terrestrial band.
- 3 Press the  key (Tools).
- 4 Select **Constellation**.
- 5 The **Constellation** of the tuned signal appears.



► Screen Description

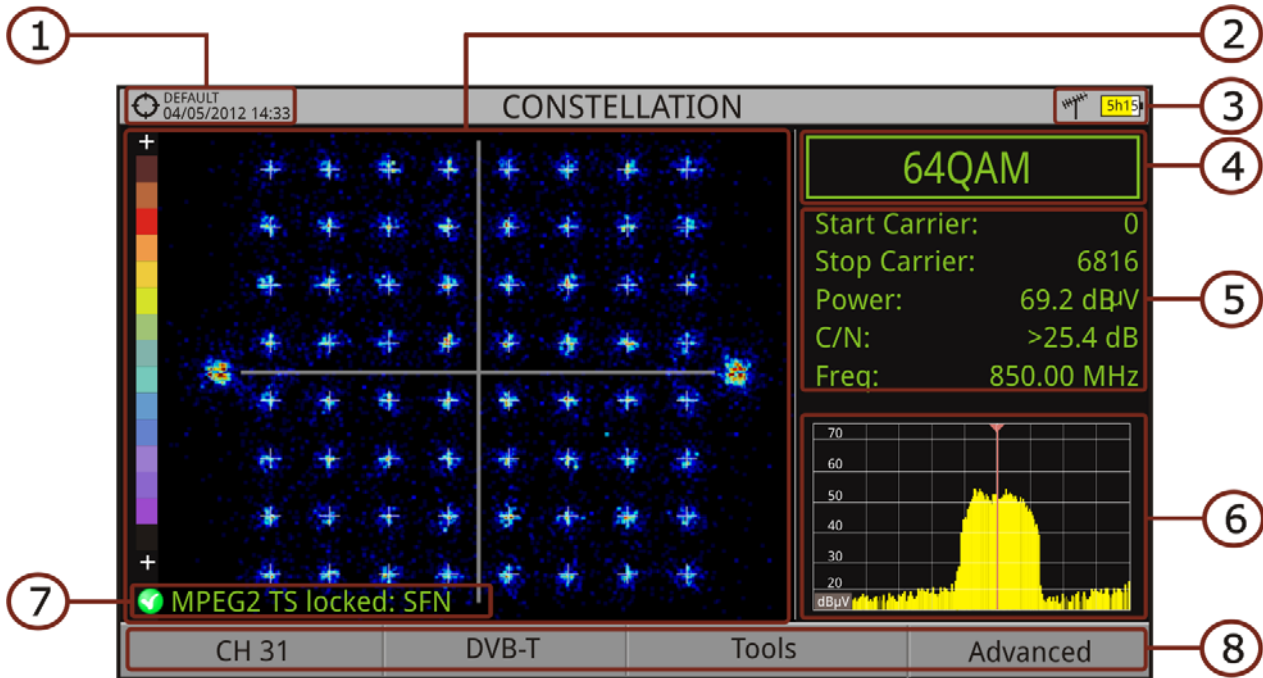

Figure 39.





- 1 Selected installation; date and time.
- 2 Constellation window. The colour scale placed at the left side indicates the signal quality in a qualitative way by a gradation of colours proportional to the density of symbols concentrated in a given area. The colour scale ranges from black (no symbols) to red (highest density). Greater dispersion of the symbols indicates higher noise level or worse signal quality signal. If there is symbols concentration with respect to the full grid (see advanced menu for types of grid) this is indicative of good ratio signal/noise or absence of problems.
- 3 Selected band; battery level.
- 4 Constellation modulation.
- 5 Data Window. Data shown are: Start Carrier, Stop Carrier, Power, C/N and frequency/channel.
- 6 Spectrum of the tuned signal. Spectrum is displayed with the span selected at the **Spectrum** mode.
- 7 Signal status (searching/locked/multiplex name).
- 8 Softkeys menus.



- Joystick functions:
 - Joystick left/right: Frequency/Channel change (depending on the tuning mode).

5.2.3 Menu Options

On the bottom of the screen there are four menus accessible via the function keys.

-  It displays the channel / frequency where is pointing the cursor, accesses the tuning menu and allows selecting the channel plan.
-  It displays the selected transmission standard menu and accesses the signal parameters.
-  It displays the Tools menu.
-  It displays the Advanced menu.

In the **Advanced** menu there are some options to set the constellation tool. They are:

- Grid type:
 - Full Grid: The grid where the constellation is displayed is a complete grid.
 - Cross Grid: The grid where the constellation is displayed is made of crosses.
- Persistence: It allows the user to set the level of persistence, which is the lapse of time the signal stays on the screen before disappearing. Available options according to the persistence level are: low, medium, high or permanent.
- Zoom: It allows the user to select a quarter (I, II, III or IV) where apply the zoom in. To come back to normal view select All.
- Start Carrier/Stop Carrier: This option allows selecting the range of carriers to be displayed between the first and last.
- Clear: This option clears all symbols in the whole constellation window.



5.3 LTE Ingress Test

5.3.1 Description

Long Term Evolution is a new standard for mobile networks. This mobile communication standard uses a frequency band close to the bands used by television. For this reason it can cause interferences.

The equipment allows you to use an LTE external filter to put on the RF input connector. This filter can be enabled to check if the quality of the TV signal reception improves, when much of the LTE band has been attenuated by the filter. With this tool you can measure the MER of a DTT channel, presumably affected by an LTE signal, and evaluate the effects of enabling an LTE filter.

To be clarified that these filters cannot completely remove the LTE band signals. Especially for the TV channels close to 790 MHz, where is the end for the current UHF. If we are close to a LTE station with low downlink channels, a filter cannot be a sufficient solution.



Other options to better mitigate the LTE signals can be considered, such as a change in the location of the TV antenna or a passive shield in the way between the two antennas (TV and LTE).

For more information, refer to application note "LTE Digital Dividend" available on the PROMAX website.

5.3.2 Operation







The **LTE Ingress Test** is available to all **Digital Terrestrial** signals.

► Settings

- 1 Press the "**Installation manager**" key for one second to access "**Preferences**" settings.
- 2 Go to "**Tools**" tab and edit the LTE filter settings:
 - LTE Filter F. Min.: Select the minimum frequency for the external LTE filter.
 - LTE Filter F. Max.: Select the maximum frequency for the external LTE filter.
- 3 Once selected, press  to save changes and  to exit "Preferences".



► Operation

- 1 Connect the external **LTE** filter between the signal and the **RF** input.
- 2 Tune the channel that is possibly affected by a LTE interference.
- 3 Press the key : Tools.
- 4 Select the **LTE Ingress Test** mode.
- 5 Screen shows a confirmation message. Press on  "Yes" if filter is connected or  "No" if filter is not connected.
- 6 It starts to measure.
- 7 To change filter status (ON / OFF), press again the  key and will appear a confirmation message. Connect / disconnect the LTE filter at the RF input and then press  key: Ok to start measuring.
- 8 The user can enable / disable the LTE measure by pressing the  : **ON/ OFF**. Remember to connect / disconnect the LTE filter to the RF input. Each time a LTE measure starts, the time counter will reset.
- 9 Check how to connect and disconnect the LTE filter affects the installation, by comparing the MER measure and the LTE band power.



[Click here to watch this video: What is LTE](#)



► Screen Description

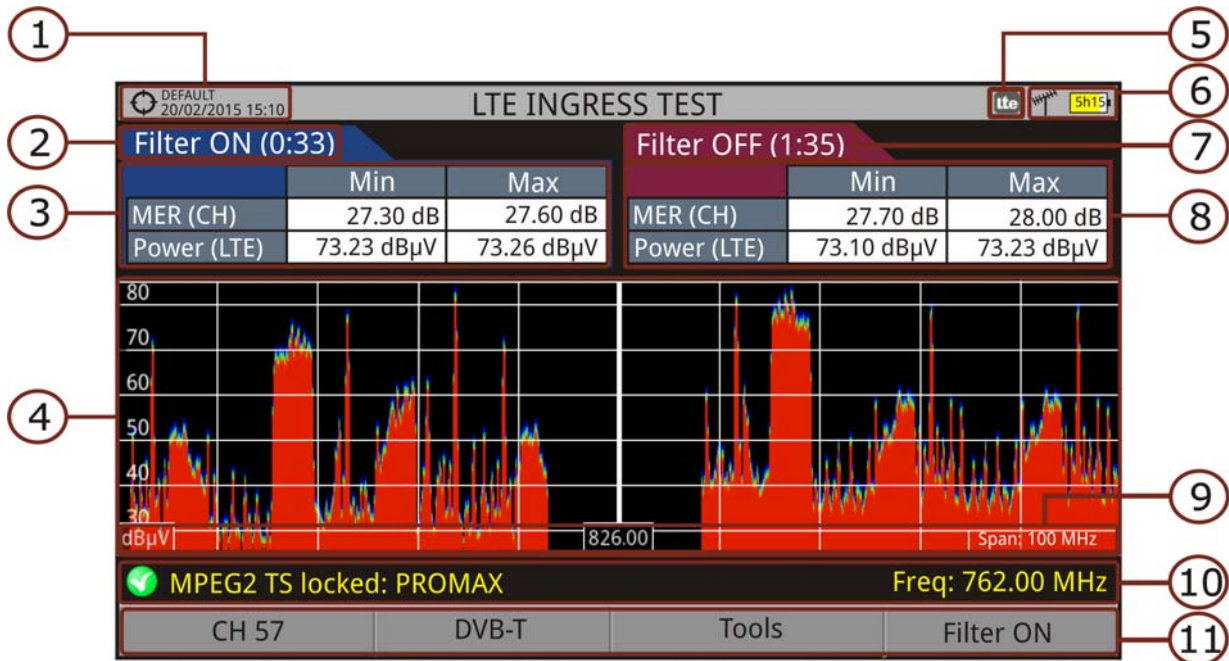

Figure 40.





- 1 Selected installation; date and time.
- 2 Elapsed time with filter enabled (ON).
- 3 Measurement with LTE filter enabled:
 - MER: Maximum and minimum MER for the TV channel tuned (the one probably affected by the LTE interference signal).
 - LTE Power: Maximum and minimum power for the complete band, between minimum and maximum filter frequencies.
- 4 Spectrum band, frequencies between minimum and maximum filter frequencies.
- 5 Identifier icon of the **LTE** filter ON (only when using internal LTE filter).
- 6 Selected band; battery level.
- 7 Time elapsed with filter disabled (OFF).
- 8 Measurement with LTE filter disabled:
 - MER: Maximum and minimum MER for the TV channel tuned (the one probably affected by the LTE interference signal).
 - LTE Power: Maximum and minimum power for the complete band, frequencies between minimum and maximum filter frequencies.
- 9 Measurement units/centre frequency/span (span: 10 MHz/division).
- 10 Signal status (searching/locked/multiplex name).



11 Softkeys menus.

5.3.3 Menu Options

On the bottom of the screen there are four menus accessible via the function keys.

-  F1 It displays channel/frequency and access the tuning menu. It allows selecting the channel plan and the channel where apply the LTE ingress test.
-  F2 It displays the selected transmission standard menu and accesses the signal parameters.
-  F3 It displays the Tools menu.
-  F4 It enables (ON) / disables (OFF) the LTE filter.

5.4 Echoes

5.4.1 Description

The **Echoes** function shows the response in time of a digital terrestrial channel and therefore it can detect echoes that can occur due to the simultaneous reception of the same signal from several transmitters with different delays and amplitudes.

Another cause that may cause echoes is reflection of the signal on large objects, as buildings or mountains. This may be the explanation that having a good C/N and a good signal, the BER does not reach the minimum value.

With the **Echoes** function is possible to know the distance from where the equipment is to the transmitter or the object that caused the echo. Thus, the installer can minimise the effect that the echo may cause on the installation, reorienting the antenna and reducing the effect of received echoes.

This function is only available for **DVB-T**, **DVB-T2** and **DVB-C2**. Therefore, previously have to configure the equipment for the reception of such signals.



5.4.2 Operation

Echoes function is available for **DVB-T**, **DVB-T2** and **DVB-C2** signals.

- 1 Connect the **RF** input signal to the equipment.
- 2 Tune a **DVB-T**, **DVB-T2** or **DVB-C2** digital signal at the terrestrial band.
- 3 Press the Tools (F3) key.
- 4 Select the Echoes option.
- 5 The **Echoes** function of the tuned signal appears on screen.

► Screen Description

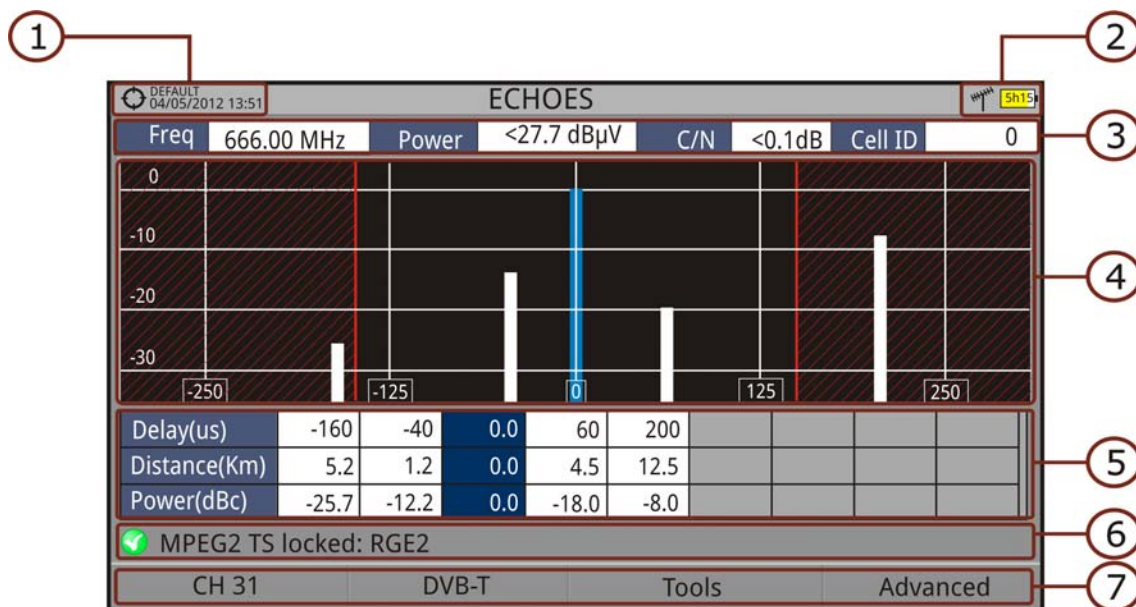

Figure 41.

- 1 Selected installation; date and time.
- 2 Selected band, battery level.
- 3 Main signal data: Frequency, Power, C/N and Cell ID (it shows the main signal transmitter, if available).
- 4 **Echoes** Diagram. The display shows a graphical representation of the echoes. The horizontal axis of the graph corresponds to the delay in receiving the echo on the main path (the stronger signal).The vertical axis represents the attenuation of the echo in dB on the main path.
- 5 Data box with main data regarding echoes. EIn the list of echoes it shows the power, the delay in microseconds and the distance in kilometres to the echoes.
- 6 Signal status (searching/locked/multiplex name).







7 Softkeys menus.

- Joystick functions:
 - Joystick left/right (**Channel/Frequency** active mode): It changes the channel/frequency (according to the tuning type selected).
 - Joystick up/down (Echoes mode): It changes zoom.

Remember to press the joystick to switch between the **Echoes** (EC) mode and the **Channel/Frequency** (CH/FR) mode.

5.4.3 Menu Options

At the bottom of the screen there are four menus available via the function keys.

-  F1 It displays the channel/frequency where is pointing the cursor, it allows the user to select a channel or frequency, a channel plan and access the tuning menu.
-  F2 It displays the selected transmission standard menu and accesses the signal parameters.
-  F3 It displays the Tools menu.
-  F4 It displays the Advanced menu. The ZOOM option changes the zoom on the echoes windows. Zooms are 1x, 2x, 4x and 8x.

5.5 Attenuation Test







5.5.1 Description

The Attenuation Test function allows the user to easily check the response of the telecommunications installations before antennas and headers are working. It allows the user to evaluate the response along the complete range of frequencies by measuring the losses (attenuation) in the distribution of TV signals, comparing reference levels at headend output and at each house antenna plugs.



5.5.2 Operation

Attenuation test function is available for all signals.

- 1 In **Settings**  select the terrestrial or satellite band.
- 2 Press the **Tools** key .
- 3 Select the **Attenuation Test** option.
- 4 The **Attenuation Test** function for the signal appears on screen.
- 5 First, set the parameters before the test, pressing the **Advanced**  key. Parameters to set are: Frequencies of pilot signals (pilot 0, pilot 1 and pilot 2), maximum attenuation and threshold attenuation (see more details in next section).
- 6 Then it is necessary to **Set References**. This requires a signal generator. We recommend to use of one of the PROMAX signal generators: **RP-050**, **RP-080**, **RP-110** or **RP-250** (depending on the frequency band).
- 7 Connect the generator and the meter where the origin of the signal distribution is in the installation (antenna, headend, etc.) or connect the generator directly to the RF input of the meter. If necessary, the meter can feed the generator using the **Supply Output** option from the **Settings** menu .
- 8 Active the signal generator and in the equipment, press the **Set Reference** key .
- 9 Once are set the references for the pilot signals, let the signal generator connected to the source point of the distribution system and take measurements in each user access point with the equipment.
- 10 In each measurement a message over each pilot signal indicates whether the measure "Pass" or "Fail" according to the parameters set.
- 11 The measurement data from the **Attenuation Test** can be saved through the **Datalogger** tool. To do this, when creating a new datalogger, in the option **Include Attenuation Tests**, select Terrestrial and/or Satellite. Then, the user must perform a datalogger from the test point where he is performing the attenuation test. Another quick option it is to select the "Test & Go" function in the "Datalogger" menu. This option creates automatically one channel plan (TER ICT or SAT ICT according to the current band) and starts to save measurements. The data will be saved and can be checked and transferred to a PC. For more information, see "Datalogger" section under the "Tools" chapter. Also measurement data or screen image can be exported by pressing the **Export**  key (see more details in section "Export key") and after that display the images or download the data files (in XML format).

NOTE: In both satellite and terrestrial band, the system saves the LNB state every time the user sets a reference and uses this value always that the equipment is working in this mode.



► Screen Description

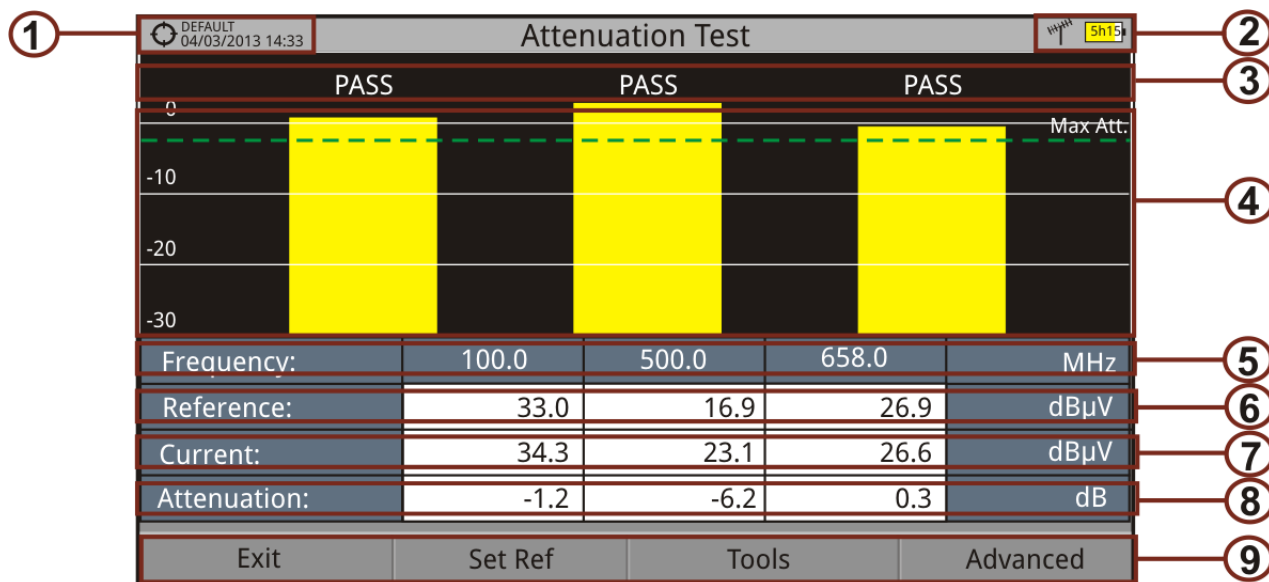

Figure 42.





- 1 Installation selected, date and time.
- 2 Selected band; battery level.
- 3 Status message depending on the attenuation level.
- 4 Power level of the signal.
- 5 Signal Frequency (MHz).
- 6 Power level of the reference signal obtained when setting the reference and used to calculate the attenuation level (dBµV).
- 7 Power level of the test signal at the user access point (dBµV).
- 8 Attenuation level (dB); Attenuation = Reference - Current.
- 9 Softkeys.

- Joystick functions:
 - No function for this tool.
- Axis description:
 - Axis X: Pilot signals.
 - Axis Y: Power.



5.5.3 Menu Options

In the bottom of the screen are four menu accessible via the softkeys.

-  Exits the tool.
-  Pressing this option the current power values are captured and they are assigned as reference values.
-  Access the Tools main menu.
-  Access the Advanced menu.

In the **Advanced** menu there are five parameters to set the attenuation test. They are:

- **Threshold Attenuation:** It defines the maximum difference that may exist between the pilot signal of higher level and the pilot signal of lower level. All pilot signals out of this range will be removed and not used as a pilot signal during the measurement process.
- **Maximum Attenuation:** It sets the attenuation level used by the equipment to show on screen if the signal passes or fails. When the attenuation level is below this value the message on screen is "**PASS**" and when it is above this value is "**FAIL**".
- **Pilot 0:** It defines the frequency of the pilot signal 0 (MHz).
- **Pilot 1:** It defines the frequency of the pilot signal 1 (MHz).
- **Pilot 2:** It defines the frequency of the pilot signal 2 (MHz).

5.6 Datalogger

5.6.1 Description

The Datalogger function stores automatically measurements in a file set by the user (name, channel plan). User can store for each datalogger measurements taken at different test points of the selected installation. Measurements are made for all channels in the active channel plan, both analogue and digital. Each installation has its own datalogger files.







As an example, you can picture the Installation folder as a folder that includes all the measurements of a building. Within the installation folder the datalogger



sub-folders would group the measurements for each apartment inside that building. Finally the test points would be the files with the measurements that would be taken in each one of the TV sockets inside the apartment.

5.6.2 Operation

► Creating a new datalogger

- 1 First select one installation of the list of installations  and load it pressing the "Load" key . An installation contains the channel plans and DiSEqC commands selected by the user and it stores dataloggers and screenshots when it is selected (more information in chapter "Installations management").
- 2 Check the installation is selected. The name of the installation should appear on the upper left corner of the screen.
- 3 Press the : Tools key.
- 4 Press on the "Datalogger" option.
- 5 It displays a menu with the "New ...", "Test & Go" option and a list of all dataloggers at the selected installation.
- 6 Select "New ..." to create a new datalogger, select "Test & Go" to create a quick datalogger (see next) or select the file name of an existing datalogger (if the user want to save data on a specific datalogger already existing).
- 7 If "New ..." is selected, a installation wizard shows how to create a new datalogger. Follow its instructions:
 -  Next: to move to the next screen.
 -  Previous: to move to the previous screen.
 -  Cancel: to cancel.
- 8 When creating a new datalogger through the wizard, the user can give a name to the datalogger.

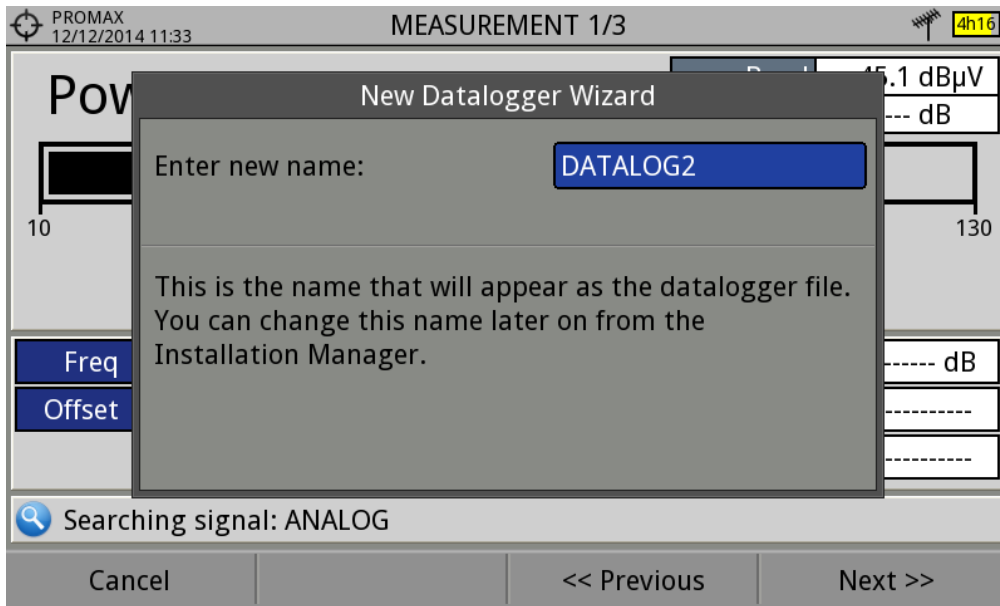

Figure 43.

- 9 Next, the user can select the terrestrial and/or satellite channel plan to use in the datalogger. The channel plans that are shown depends on the channel plans available for the current installation.

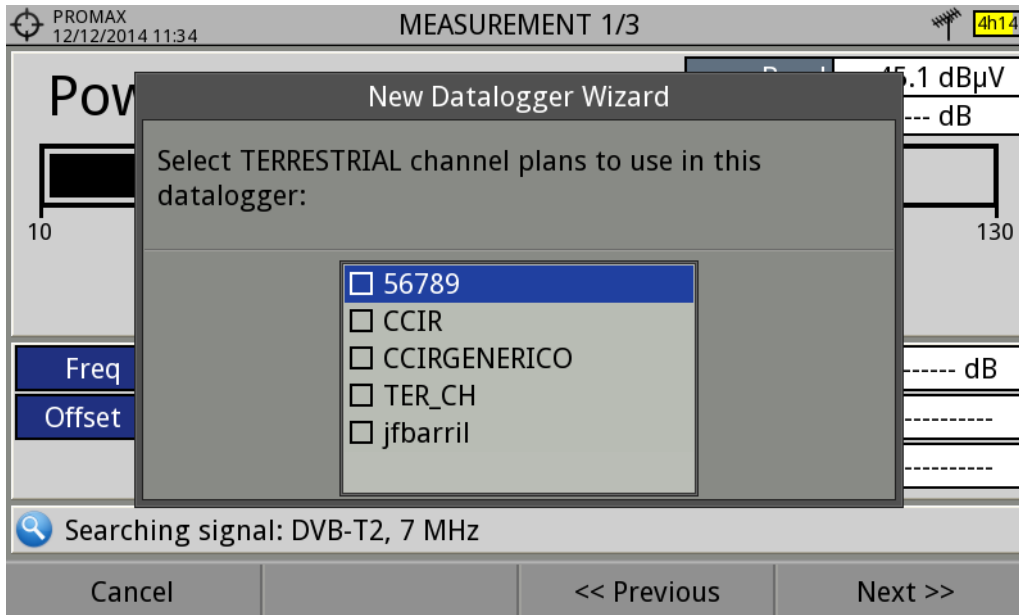

Figure 44.

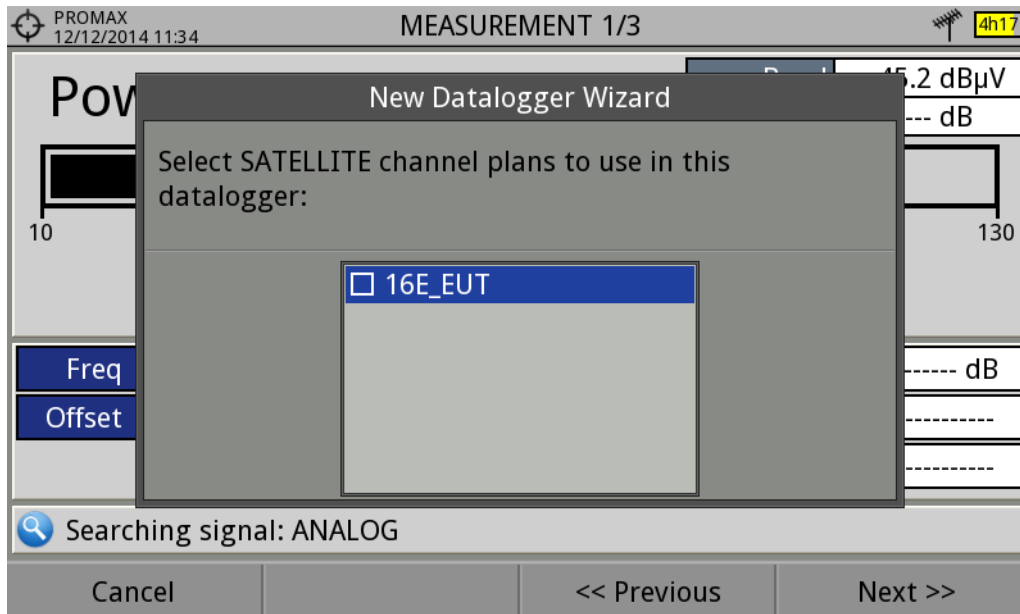

Figure 45.

- 10** In the next window, the user can select an option to capture de service list when performing the datalogger (this option slows down the process but provides more information). Another option allows the user to enable a pause between channel plans (the process stops until the user wants to carry on). There is also the option to perform a datalogger on the attenuation test, terrestrial or satellite (see section "Attenuation Test" under "Tools" for more information).

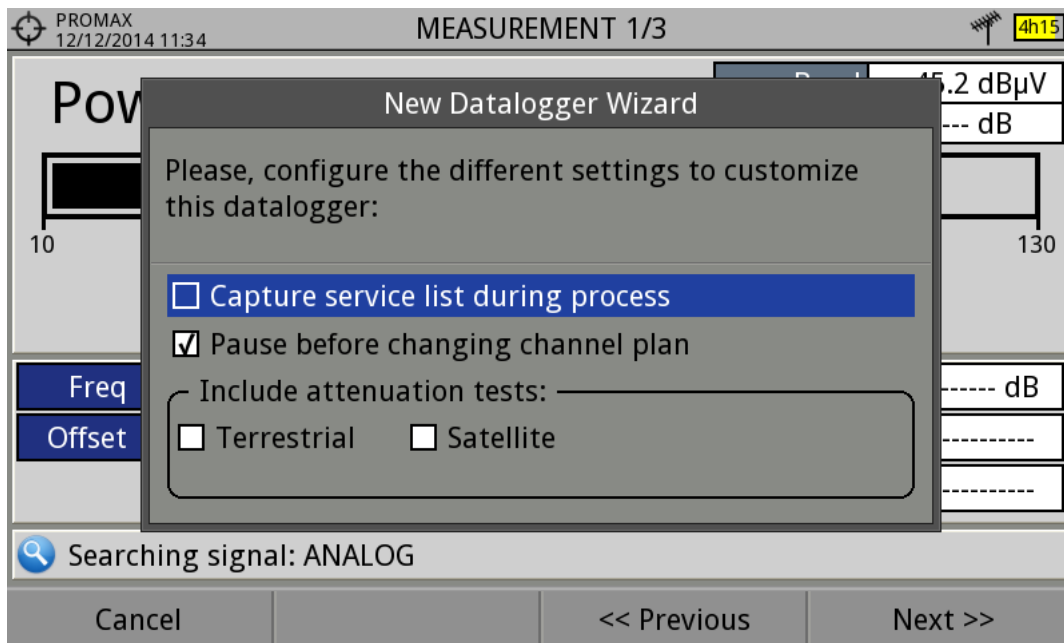

Figure 46.

- 11** At the last step, user can select to open the just created new datalogger (by default, this option is selected).



- 12 Once a new datalogger is created or selected an already existing one, it shows the datalogger viewer screen and measurements of test points can start.
- 13 If it is a new datalogger, in first place before starting the datalogger, the system will create a new test point (see next section). Test points represent a specific point such a TV antenna socket.

Click here to watch this video: Datalogger

► **Starting a datalogger**

- 1 After creating a new datalogger file or selecting an existing one, the user can start the datalogging process.
- 2 From the datalogger viewer screen, press the "Test point" key F4 and from the menu select an existing test point using the "Jump to..." option or "Create new..." to create a new test point. If a new test point is created, user has to give it a name.

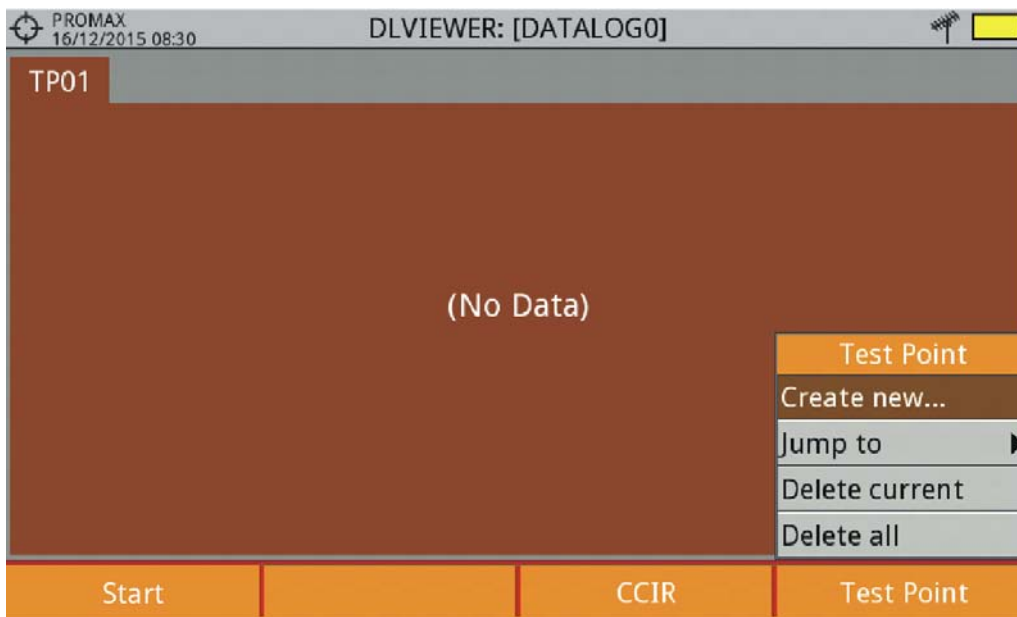

Figure 47.

- 3 Now datalogger is ready to start. Press the key F1 and "Start". The datalogger process starts, during which all the measurements of all channels that are part of the datalogger and also the attenuation test are saved.
- 4 During datalogger, it catches the list of available services of all channels in the channel plan that are part of the datalogger (if this option was selected when creating the datalogger or if the "Datalogger PSI" option is enabled in the Preferences menu). If there is a change of channel plan during datalogger there will be a pause (if this option was selected when creating



the datalogger). User can pause and resume the datalogger process at any time by pressing on the key "Pause" (F3). If the "Attenuation Test" option was included when creating the datalogger, these measures will also saved.

- 5 At the end it saves the data and allows watching the results on screen by channel plan/attenuation test. To change the view of channel plan or attenuation test data press on the (F3) key. Data about terrestrial and satellite attenuation will appear as the option TER ICT and SAT ICT respectively.
- 6 It is also possible to download Datalogger files to a PC by the NetUpdate software (free download on the PROMAX website). Once downloaded, the program can generate reports with these files. This is not possible with the datalogger files exported directly to a USB (without using NetUpdate). Information of Service lists is in the XML files downloaded to the PC.

NOTE: To make a datalogger with the Field Strength tool, in first place user has to enable the field strength tool, and then to create a new datalogger file. The field strength data will be stored in this datalogger.

► **Screen Description (Datalogger)**

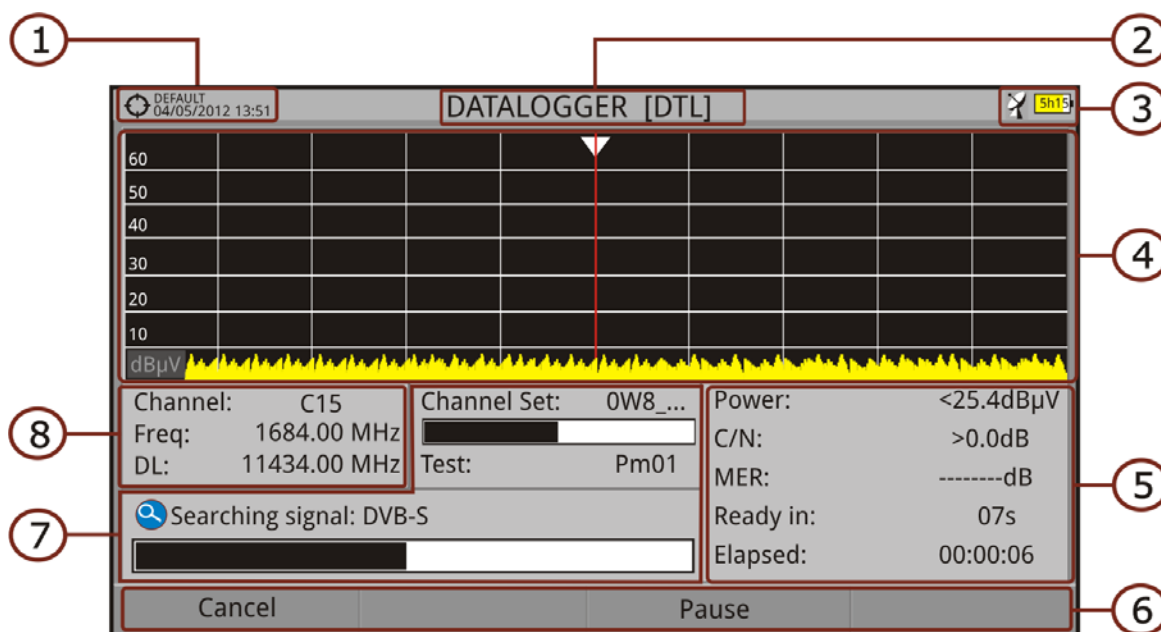

Figure 48.

- 1 Selected installation; date and time.
- 2 Current datalogger name.
- 3 Selected band; battery level.
- 4 Exploring the spectrum in real time.
- 5 Level/Power, C/N ratio, MER, time remaining to identify a channel, elapsed time since the start of the channel identification.



- 6 Softkey menus.
- 7 Current channel plan, progress bar in the current channel plan, selected test point.
- 8 Channel, frequency and Downlink.

► **Screen Description (Data Viewer)**

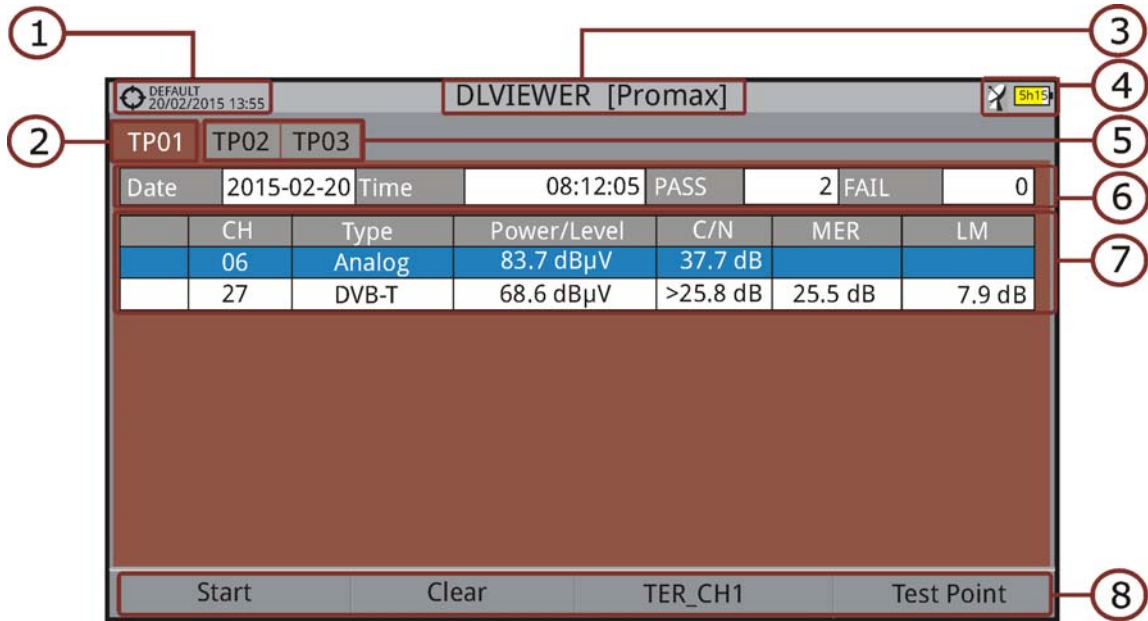

Figure 49. Channel Plan Data Viewer.

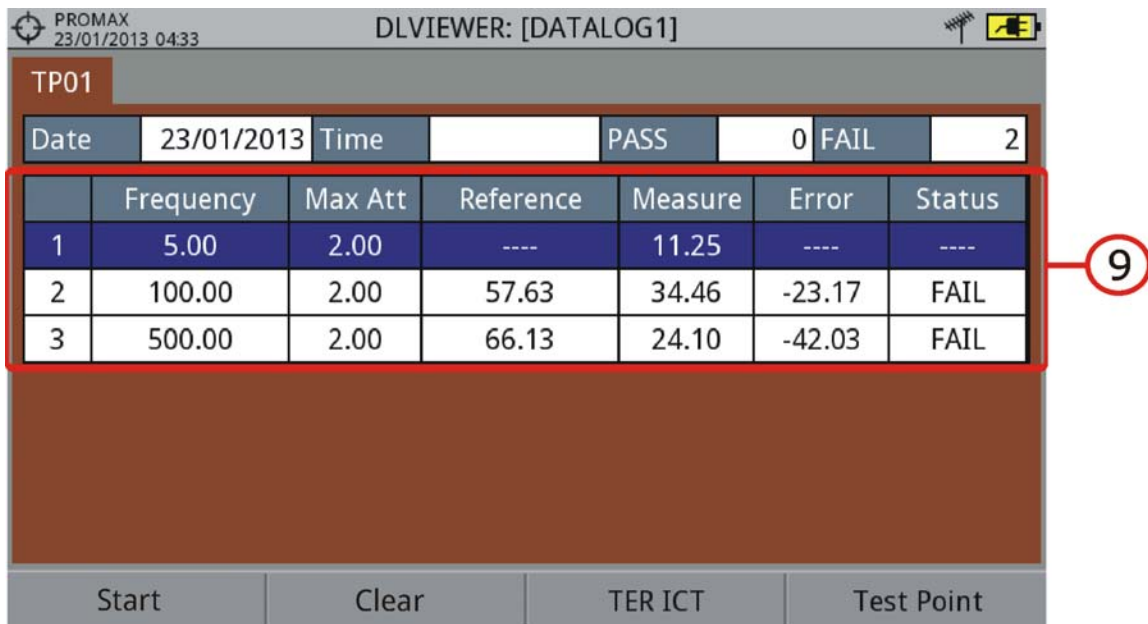

Figure 50. Attenuation Test Data Viewer.





- 1 Selected installation; date and time.



- 2 Tab identifying the displayed test point.
- 3 Current datalogger name.
- 4 Selected band; battery level.
- 5 Tab identifying each test point.
- 6 Date and time when the datalogger was created. Number of channels locked (PASS) or not locked (FAIL).
- 7 Data table with measurement data for each channel. In order from left to right: Colour identifying if the channel has been locked (WHITE) or not locked (RED) channel; signal type; power/level; Carrier/Noise (C/N) rate; MER; Link Margin. Move the joystick up or down to navigate along the measurement data. Press the joystick on a channel to display the signal parameters.
- 8 Softkey menus.
- 9 Table with the measurement data for each pilot signal in the attenuation test. In order from left to right: number of pilot signal, pilot signal frequency, maximum attenuation allowed, reference level value, level value at the test point, error and signal status.



5.6.3 Menu Options

► Data Viewer Menu

-  F1 It starts the datalogger in the selected test point.
-  F2 It clears all the acquired data.
-  F3 It displays a menu with the available channel plans to select the channel plan whose data want to be displayed. Channel plans available are those that have been selected during the creation of the datalogger.
-  F4 It contains four options:
 - Jump to:It allows selecting a test point.
 - Create New...:It creates a new test point.
 - Delete Current:It deletes the current test point.
 - Delete All:It deletes all test points of the datalogger.



► Datalogger Menu Options

-  It cancels the datalogger.
-  It pauses datalogger until the user resumes by pressing again.

5.6.4 Test & Go

"Test & Go" function inside the "Datalogger" tool allows the user to create a quick datalogger by creating automatically a new datalogger, a new test point and then starting it.

Datalogger parameters are set automatically based on:

- File name: DL [current band - terrestrial or satellite][consecutive number].
- Channel plan: Current channel plan selected in the equipment.
- Test point: PM01.
- No capture of services list.

If "Test & Go" is performed when using the "Attenuation test" tool, then the datalogger created will be specific to save attenuation test data.

5.7 Screen and Data Capture (Export key)

5.7.1 Description

The Screen and Data Capture function captures what is displaying on screen at the moment. The capture can be an image, measurement data or both. This is set through the **Preferences** menu ("Export button" option).



Data capture is saved in a XML file with all data, measurements and text, that is on screen at this time. The image is saved in a PNG file.

Captures can be displayed on the equipment or also can be downloaded and displayed through an external software.





5.7.2 Operation



► Settings

- 1 Press the "Management Installation"  key for one second to enter "Preferences" menu.
- 2 Go to the label " **Tools**" and select your option in "**Export button**". There are three options available: Screen Only, Data Only or Screen+Data. "Screen Only" saves the screen image in PNG format. "Data Only" saves measurement data on screen in a XML file format. "Screen + Data" saves both screen and data.
- 3 Once selected, press  to save changes and  to exit "Preferences".

► Capture

- 1 Press the **Export** key  for one second when on screen appears the screen to be captured. The LED next to key lights.
- 2 A progress bar shows the progress of the capture process. When finished, the screen is captured and the LED is OFF.
- 3 Then the virtual keyboard appears with the default name assigned to the file. The filename for the screen capture is automatically generated with the following code: capture mode (SP for Spectrum mode, TV for TV mode, ME for Measurement mode), capture channel (CHXX) and a consecutive number.
- 4 Edit the name if necessary (see section "Virtual keyboard"). Then press : OK to end the capture or : Cancel for cancellation.

► Display

- 1 To display the screen captured press on the **Installations Management** key .
- 2 Select the installation where the capture was done and press  **Manage**.
- 3 Press  **Filter by type**. Select "Screen Shots" or "Data Captures" option. This shortens the list to the selected option.
- 4 It appears a list of all the captures.
- 5 Move up or down to find the file to be displayed.
- 6 Leave the cursor on the file to be displayed. It appears a progress bar that lasts a few seconds, depending on the size. Then the capture appears.



- 7 To see the capture in full screen just press the F4: **Options** key and then on the menu press "View in Full Screen". To exit the full screen view press any **softkey**.
- 8 To delete or copy the capture to a USB stick, select the capture by pressing the joystick, and then select the appropriate option from the menu : **File**.
- 9 Captures can also be displayed on a PC, by downloading the whole installation file using the NetUpdate software (see the NetUpdate manual for more information).



5.8 Explore Channel Plan

5.8.1 Description

The Explore Channel Plan function performs a scan of the selected channel plan. It detects where active signals are in a channel plan and in which channels of the current channel plan signal is received. With this information it explores these channels with signal, looking for any broadcast and identifying them.

5.8.2 Operation

The Explore Channel plan function is available for all signals.

- 1 Connect the **RF** input signal to the equipment.
- 2 Access Preferences by pressing the Installations key  for 1s.
- 3 At the 'Measures' tab check the minimum values for the signal to be identified during the scan (for more information refer to section: Preferences -> Measures options).
- 4 Press the **Tools** key .
- 5 Select the **Explore Channel Plan** option.
- 6 The first screen of **Explore Channel Plan** appears.

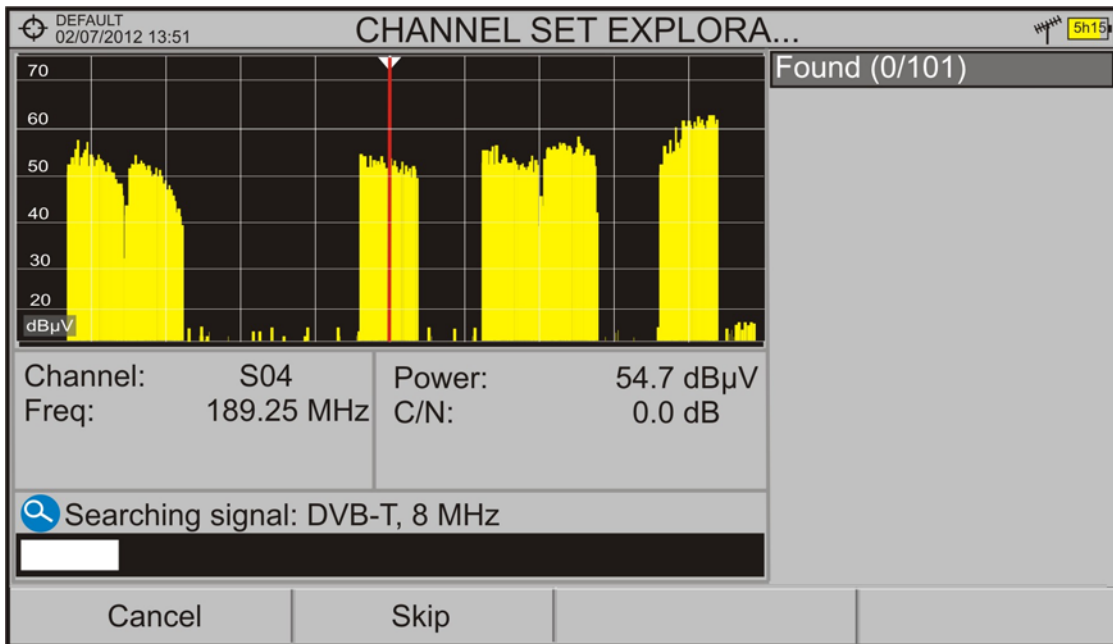

Figure 51.

7 After the exploration the following screen appears:

► Screen Description

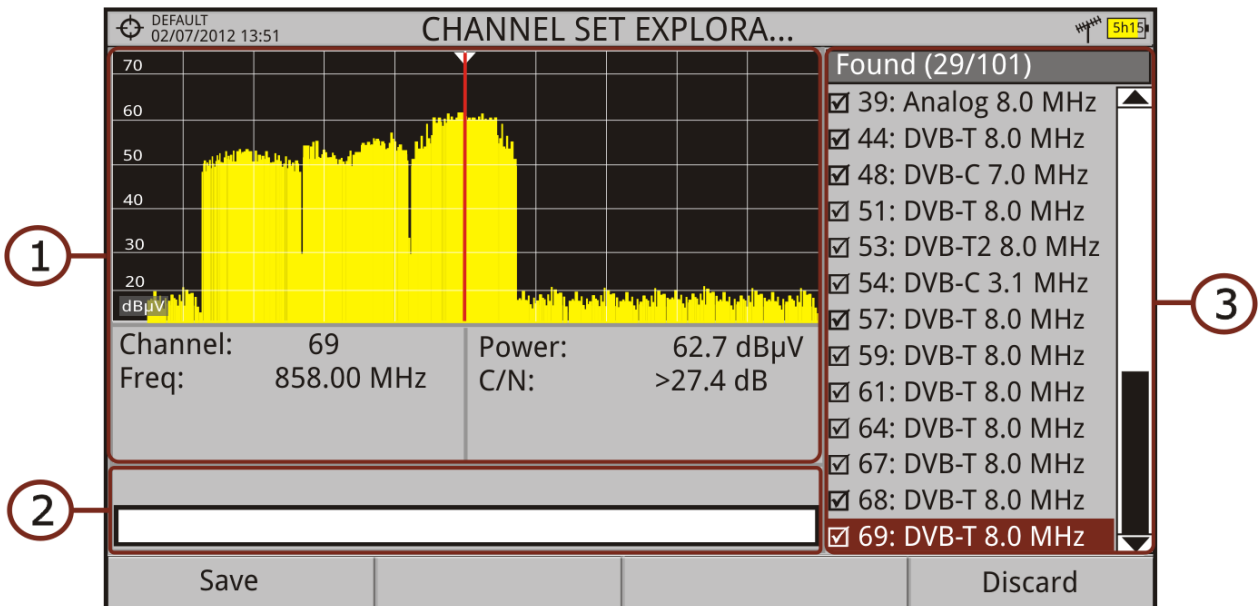

Figure 52.





1 **Spectrum and Measurement:** It shows the cursor scrolling through each of the channels of the channel plan. On the bottom of the screen the channel and frequency appears next to the Power/Level and the C/N ratio.



- 2 **Progress Bar:** It shows the signal type detected and the scan progress in real time. At the end a box shows a message informing the exploration process has finished.
- 3 **Channel plan:** At the end of the process it shows the channels that have been detected during the channel plan exploration. In parentheses shows the number of detected channels to total channels of the channel plan. When moving the cursor through the channels, the spectrum and measurement windows are dynamically updated for the selected channel. It allows you to select/unselect channels to save them as a new channel plan.

5.8.3 Menu Options

At the bottom are the function keys. They are detailed below.

-  **F1 Cancel** (during the process): This option appears only while performing the exploration process. It cancels the exploration before finish. When pressing, a confirmation message appears before cancelling.
-  **F1 Save** (at the end of the process): This option appears at the end of the exploration process. It saves the results obtained during the exploration as a new channel plan. The name of the original channel plan is assigned to the new one by default and the user can modify the name using the virtual keyboard that appears prior to saving. The new channel plan is now available in the list of channel plans in the installation and can be used as any other channel plan. After saving it becomes the selected channel plan to work with.
-  **F2 Skip** (during the process): This option allows skipping the current channel and explore the next one in the channel plan.
-  **F4 Discard** (at the end of the process): This option appears at the end of the exploration process. It discards the results obtained from the exploration.



[Click here to watch this video: Channel plan exploration](#)



5.9 Field Strength

5.9.1 Description

The Field Strength function allows the equipment to work as a field strength meter, measuring dB μ V per meter. To perform this type of measurement is needed to enter the calibration parameters of the antenna being used to receive the signal.

5.9.2 Operation

The Field Strength tool is available for all signals received by the RF input.

- 1 Connect the antenna to the **RF** input of the equipment.
- 2 Select a channel or frequency.
- 3 Press the **Tools** key.
- 4 Select the **Field Strength** option and in the drop down menu select **On**.
- 5 Select again the **Field Strength** option, now select the new option that appears, called **Configuration**.
- 6 In the configuration window enter the antenna calibration parameters, by hand or selecting one of the available antenna types (data of different antenna types should be imported by the user. Refer to the following section).
- 7 Now access the **Spectrum Analyzer** or **Measurement** mode to check the field strength measure shown as FSM (dB μ V/m). This measure replaces the power.

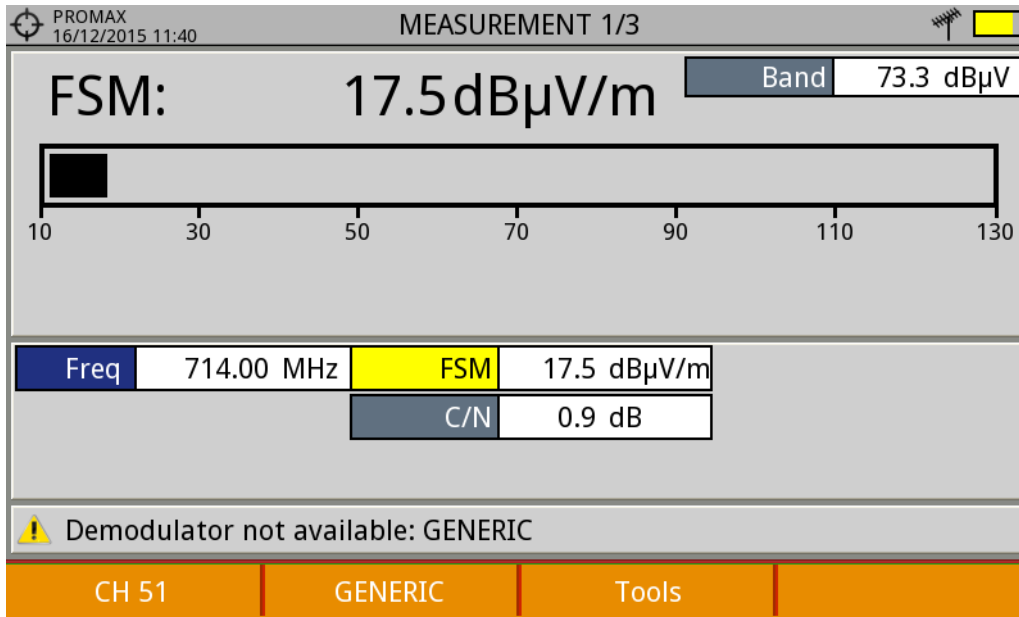

Figure 53.

- 8 To save FSM data, go to "Tools", select "Datalogger" and then "New" to create a new datalogger. Keep in mind that the "FSM" tool does not demodulate any signal, it only detects the transmitted energy, so it is identified as a GENERIC signal. For this reason only FSM data is saved for each channel (for more information refer to "Datalogger" chapter).
- 9 Once finished, return to the **Tools** menu and in the **Field Strength** option select **Off**.

NOTE: Some tools (Constellation, Echoes, MER by carrier, Merogram...) are disabled when the **Field Strength** option is enabled. Remember to turn off "FSM" option if you want to use these other tools.

5.9.3 Settings

The **Field Strength** configuration option allows the user to enter the correction factors for the antenna and cable used when measuring the field strength.



Field Strength Configuration

<p>Antenna</p> <p>Type: Manual</p> <p>Factor (dB/m): 0.0</p> <p>Detector Type: RMS</p>	<p>Cable</p> <p>Type: Manual</p> <p>Loss (dB): 0.2</p>
--	---

@794.00 MHz ==> 66.4(Level) + 0.0(k) + 0.2(loss) - 0.00(Z) = 66.6 dBμV/m

Figure 54.

Data fields to be filled are:

► **Antenna:**

- **Type:** In this box the user must select the type of antenna between manual and any other type of antenna available. If you select the manual antenna, you must enter the correction factor by hand. If you select an antenna type then the correction factors associated with each frequency are applied. These data are defined in the antenna file imported by the user (refer to next section to know how import antenna data).
- **Factor:** This is the correction factor (K) for the antenna at the measurement frequency.
- **Detector Type:** (PEAK/RMS). It allows the user to select between maximum PEAK detector or RMS detector. The maximum peak detector is mainly used for analogue modulated signals, while the RMS option is the right choice for digital modulated signals.

► **Cable**

- **Type:** In this box the user must select the type of antenna between manual and any other type of cable available. If you select the manual cable, you must enter cable loss by hand.
- **Loss (dB):** In this box the user must enter the estimated loss for the cable used to connect to the antenna.

At the bottom of the configuration window you can see the field strength in real time according to the current frequency and correction factors.

5.9.4 **Creating and Importing Calibration Tables**

The user can import the antenna calibration data obtained from the manufacturer. There is a template (available on the download area at PROMAX



website) that can be filled and imported into the equipment (this template has been created in an Excel file; the procedure explained below only works for the Excel 2007 version and above).



Figure 55.

Next are the steps to fill in the template data and import them to the equipment:







► **Antenna Generator**

- 1 Download the "Antenna XML Generator" template from the PROMAX website.
- 2 In the "Model" box enter the name by which the antenna will be identified (maximum 8 characters).
- 3 In the "Description" box, type a description to identify the antenna.
- 4 In the "Impedance" box select the impedance of the antenna between 50 and 75 ohms.
- 5 In the "Height" box enter the antenna height in meters.
- 6 Now fill the calibration table of the antenna with the K factor according to frequency.
- 7 Do not change units when filling the table.
- 8 Extend or contract the calibration table to the number of filled lines.
- 9 After filling the calibration table, go to option "Save As -> Other Formats.
- 10 In the window that appears, edit the file name in "File name".





- 11 In the drop down menu "Save as type" select the "XML Data" option. Then click "Save".
- 12 If a warning message shows up, click "Continue".
- 13 Now the file is already generated with the selected name and the extension "xml".
- 14 Now just import it to your equipment and load the calibration table of the antenna in the installation.

► Import

- 1 Copy the generated file on a flash drive and connect it to the meter's USB port.
- 2 Press the **Installation Manager** key .
- 3 Press the Tools key .
- 4 Select "Import from USB" option.
- 5 The Import Files window appears. Select the generated file and press the  "Import" key.
- 6 Press the **Installation Manager** key , select the installation to which you want to add the antenna calibration table and press the  "Manage" key.
- 7 Press  key: "Installation" and select the "Add Antenna" option.
- 8 Select the antenna to be added and OK.
- 9 The antenna calibration table is now added to the installation.
- 10 Now this antenna will be available in the type of antenna field in the configuration menu of the "Field Strength" tool.

► Remove

- 1 Press the Installation manager key .
- 2 Press  "Tools" key.
- 3 Select "Installed Antennas" option.
- 4 Check the antenna to remove.



5 Press **F2**: "Remove" key.

5.10 Task Planner

5.10.1 Description

The **Task Planner** function allows the user to set-up a task list, selecting when to start, a repetition rate and other parameters. The equipment can be switched off after setting all parameters and it will wake-up, at the required time, to perform the scheduled tasks.

5.10.2 Operation

The Task Planner tool is available to run screenshots and dataloggers.

- 1 Press the **Tools** key.
- 2 Select the **Task Planner** option to access the Task Planner window that shows a list of scheduled tasks. In the right column and next to each task there is its status: if the date of the next execution appears then the task is pending; if "finished" appears then the task has been executed; if nothing appears then the task has not been scheduled.

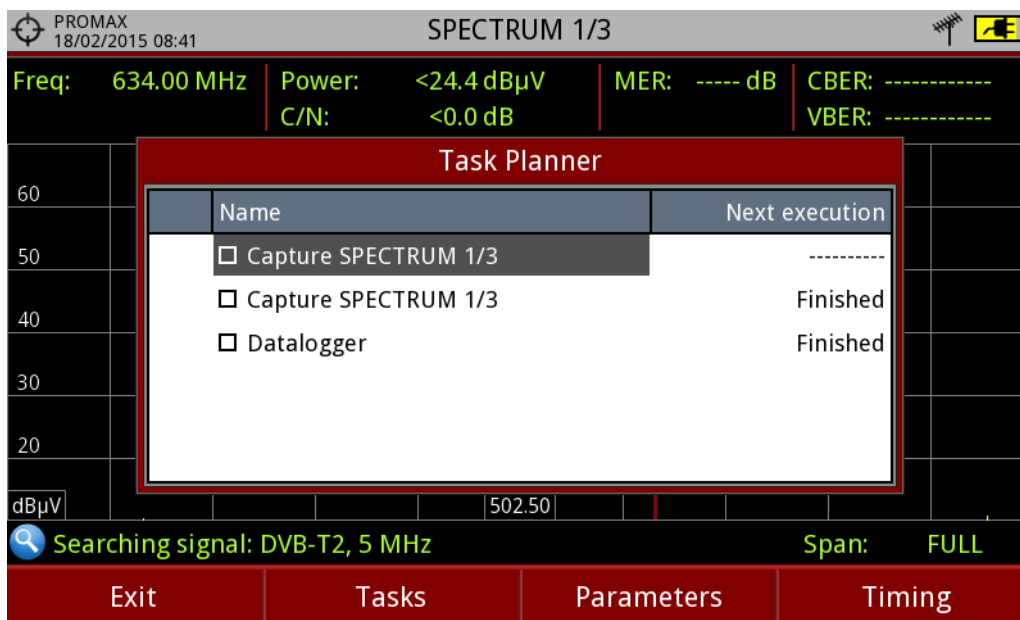

Figure 56.

- 3 To add a new task press **F2**: **Tasks** and select the "**Add**" option. It deploys a menu with two options: Capture and Datalogger.

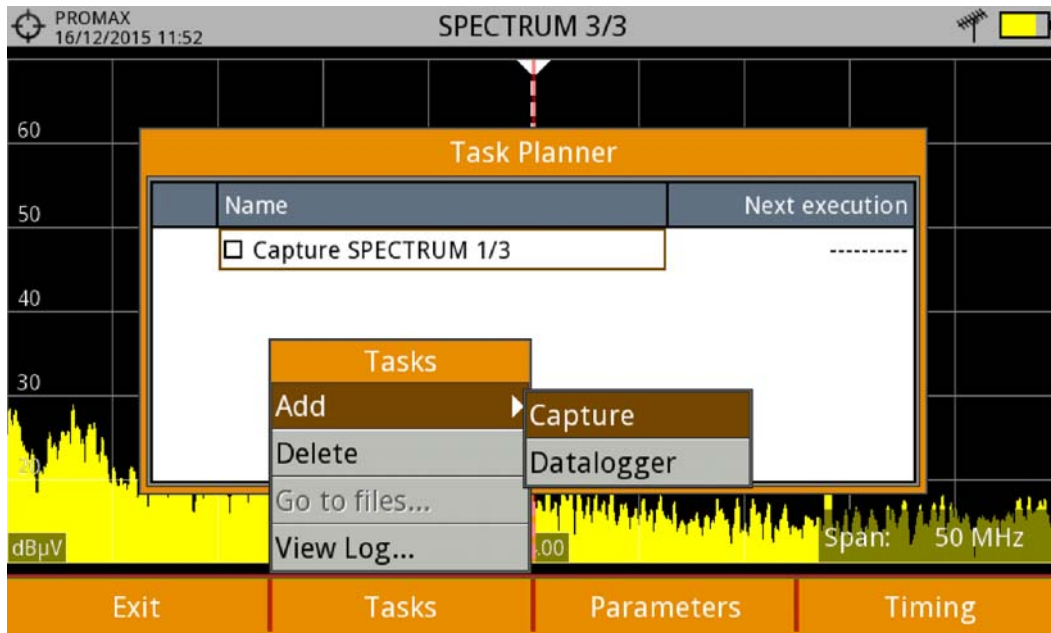

Figure 57.

- 4 The **"Capture"** option performs the capture task. The user can select the screen and type of capture. The screen options include any view in the three modes: Measurement, Spectrum or TV. The options for type of capture are: screen only, data only or screen+data (for details about capture refer to "Screen and data captures (Export button)" section).

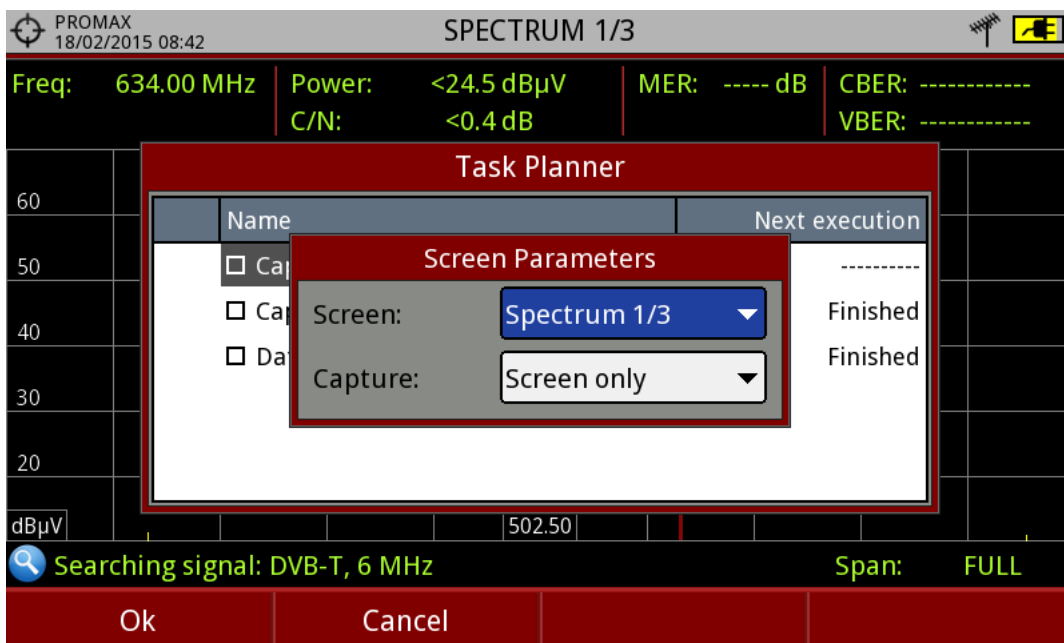



Figure 58.

- 5 The **"Datalogger"** option performs the datalogger task. The user must first select the datalogger from those available for the current installation (for details about datalogger read "Datalogger" section).



- 6 After selecting the type of task, check the box next to it and press **F4: Timer** to schedule the time to execute the task (see next section for details about the timer).
- 7 When saving the timer for the task, the upper right corner shows an icon of a clock  indicating that the equipment has tasks pending to execute.

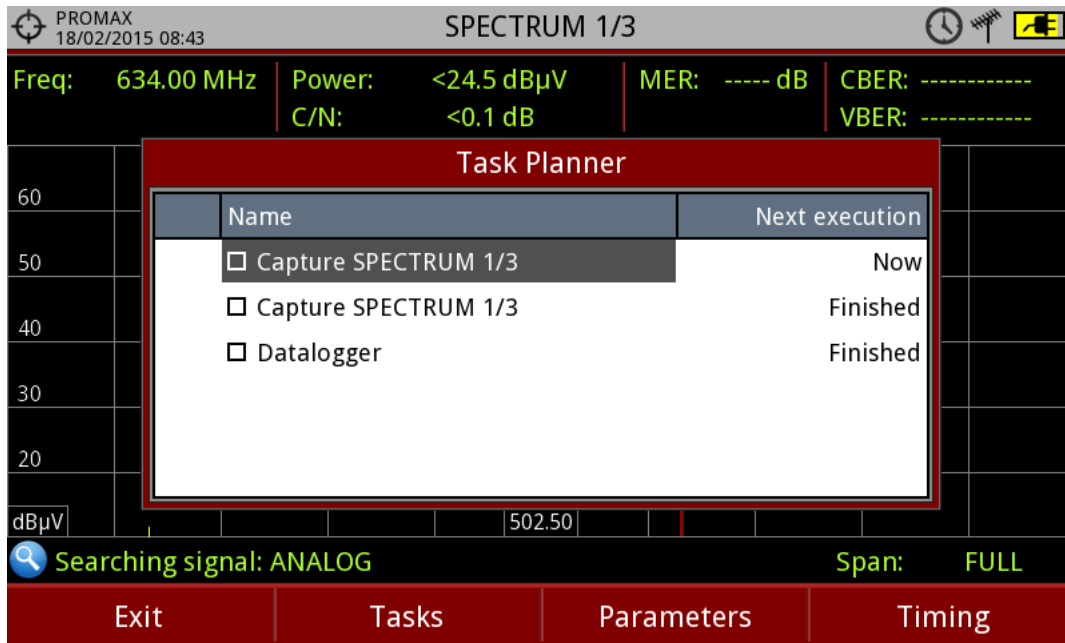

Figure 59.

- 8 To change any parameter of the task, check the box next to the task and press **F3: Parameters**.
- 9 To delete a task, check the box next to it and in **F2: Tasks**, press "Delete".
- 10 After setting up the tasks press **F1: Exit**. Since this moment the timer for task execution starts.
- 11 When the task is finished, the user can access the data through "Go to file ..." option in **F2: Tasks**. It will take you directly to the management installation window where the data for each installation are stored.
- 12 Once the task is completed, user can access a short log for each programmed task, just to know if each task has been successfully completed



or to indicate if something prevented its execution. To access this function, from **Task Manager**, press **F2: Task** and then "**View Log...**".

NOTE: The equipment can be turned off after task planning as it will automatically turn on when the time to task execution comes.

Two tasks cannot be executed simultaneously.

It is recommended that the datalogger selected have not enabled the option to pause between channel plans, since in that case the process would stop during the execution of the task.

The filename for the screen capture is automatically generated with the following code: capture mode (SP for Spectrum mode, TV for TV mode, ME for Measurement mode), capture channel (CHXX) and a consecutive number.

5.103 Timer

The timer window contains several options for task scheduling.



Figure 60.

■ **Start**

- **Start Now:** The task begins immediately after leaving the task planner.
- **On Date:** The user selects the start date for the task (day / month / year) and time (hour: minute).



- Repeat every: The task repeats each cycle of time (days, hours and minutes).
- Stop
 - Manual: The user finishes the task.
 - On date: The user selects the stop date for the task (day / month / year) and (hour: minute).
 - Repeat a number of times: The task execution ends after the number of times set.
- Turn off after execution: By checking this option, the equipment turns off after the execution of the task.





6 INSTALLATIONS MANAGEMENT

6.1 Introduction

The Installations Management is a program embedded in the equipment that allows the user to easily create a file (installation) to individually store and manage data for each installation. Measurements, channel plans, screenshots and any other data associated with the installation will be stored in the folder corresponding to that installation. These measures can then be displayed and downloaded to a PC.

If the user does not create any file installation, the equipment stores measurements in the installation file by default (named "DEFAULT").

6.2 Operation

- 1 To access the Installations menu press the key .
- 2 It shows up a window with a list of all available installations. On the softkeys appears the options to manage these installations.
- 3 To exit the list of installations press the key .

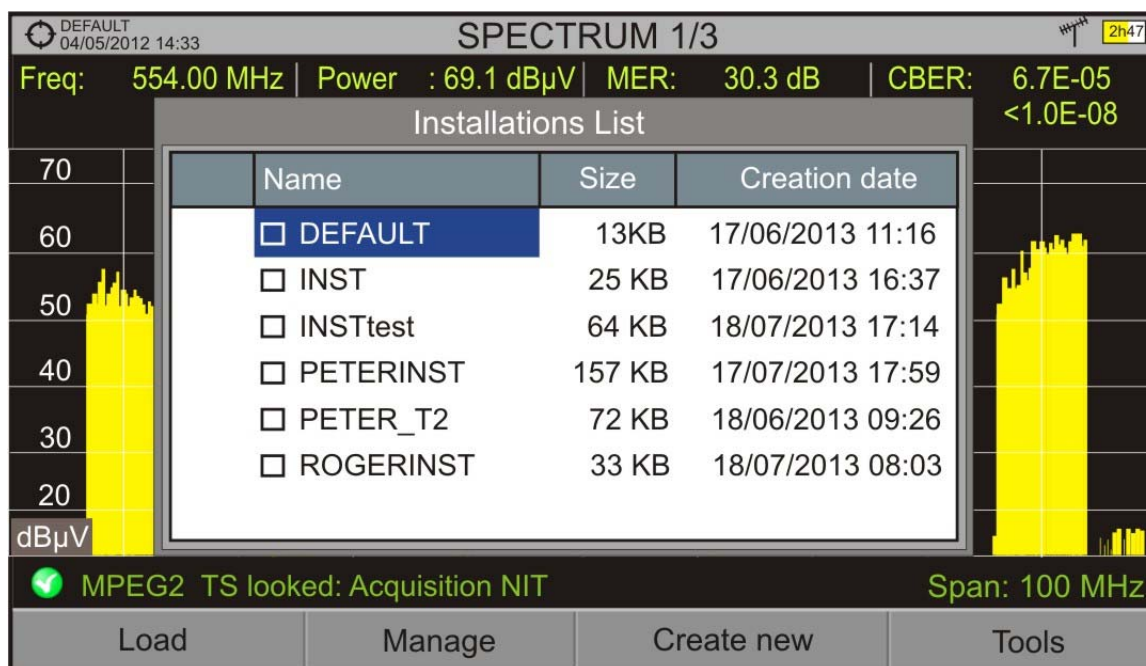









Figure 61.



There are the following options:

- Load : It loads the selected installation. To select a installation from the list, place the cursor on the installation and press the joystick, then press "Load"  to load it. Once loaded, the name of the installation appears on the upper left corner of the screen, accompanied by the symbol , that means that is the current installation. All measurements, screenshots, channel plans and other data since this moment will be stored in the current installation.
- Manage : It opens a window that displays all data of the current installation and from where they can be edited, changed or view (more details in "Installation Management" section).
- Create New : It creates a new installation with the data introduced by the user (more details in "New installation" section).
- Tools : It shows up a menu with some tools to use with the installations (see "Tools" section).

6.3 Installation Management

In the list of installations, press on the option Manage  to access to the Installation manager screen.

The DEFAULT installation is the installation preinstalled on the equipment. It is like any other installation and it can load channel plans, DiSEqC programs, etc. The DEFAULT installation can not be deleted or renamed.

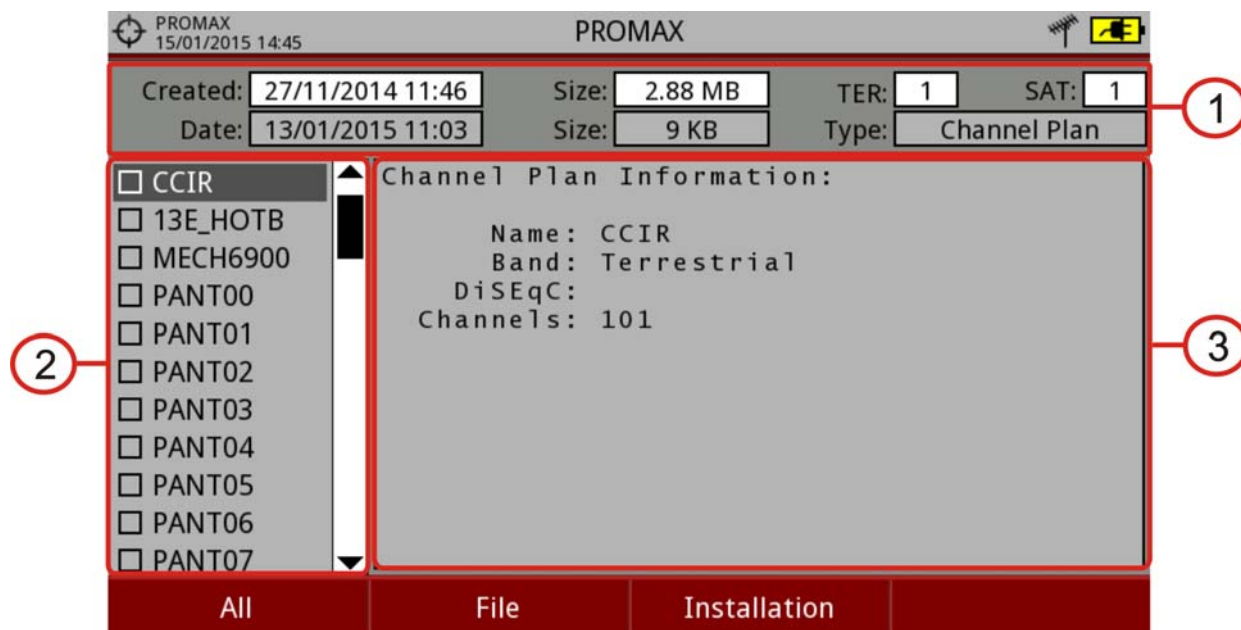

Figure 62.

The window is divided into three areas:

- 1** General Data: The first line shows general information about the installation. The second line shows information about the selected file. Data fields are:

 - Created: Date and time the current installation was created.
 - Size: Data size of the current installation.
 - TER: It shows the number of terrestrial channel plans in the installation.
 - SAT: It displays the number of satellite channel plans in the installation.
 - Date: Date and time when the selected file was created.
 - Size: Data size of the selected file.
 - Type: Data type of the selected file.
- 2** List of Files: It shows all types of data files in the selected installation. These can be: screenshots, channel plans, dataloggers, DiSeqC commands, data captures, signal monitoring, service databases and antennas. To move along this file list move the joystick up or down. Any of these files can be selected or deselected by pressing the joystick.
- 3** Display Area: It is the area where data file description is displayed. The file data is displayed only if the cursor is placed for a moment on the file name. For a screenshot, it displays a thumbnail of the full screen, as captured. In the remaining cases, it only shows some data description of the file type. If there is any extra option associated with the file, it will appear on the **F4** key.



► Menu Options

The installation manager menu has four options linked with the softkeys. They are described below:

- **F1** Filter by Type: It shows all available file types in the current installation and the amount of them between brackets. User can filter by file type. The selected file type will be the only one available in the list of files. Available file types are: screenshots, channel plans, dataloggers, DiSeqC commands, data captures, signal monitoring, service databases and antennas (or all).
- **F2** File
 - Mark All: It marks all files on the list of files area.
 - Unmark All: It deselects all files on the list of files area.
 - Delete: It deletes all selected files on the list of files area.
 - Copy to USB: It saves selected files on the list of files area to an USB stick connected to the equipment.If the name of the file to be copied is greater than 8 characters the system cuts it. If the file name is cut and matches with another one, then it is added a number to the name to make them different. For instance, 2 files with similar names, like FILENAME01 and FILENAME02 both files will be correctly copied with names FILENA~1 and FILENA~2. To keep the file names with more than 8 characters it is recommended to export the complete installation using the "Export to USB" option (see "Tools" section). The Datalogger files copied to the USB cannot be used to generate reports by the NetUpdate program. To do this the datalogger files must be exported directly through the NetUpdate program (see the NetUpdate user's manual for details).
- **F3** Installation
 - Add Channel Plan: It opens a window to add a channel plan, terrestrial or satellite and band (for optical option), to the current installation.
 - Add Antenna: It allows the user to add an specific antenna among the ones available. To import an antenna refer to "Field Strength" section in chapter "Tools".
 - Add DiSEqC program: It allows the user to select and add to the current installation any DiSEqC program available in the equipment.
- **F4** Options: This option appears if there is any extra option associated with the file type.
 - See Full Screen: This option only appears if user selects an image in the list of files. It displays the selected image full screen.
 - DiSEqC Program: This option only appears if a satellite channel plan is selected in the list of files area. It allows the user to add a Diseqc program



to the selected satellite channel plan from the list of diseqc programs available for the current installation.

- Open File: This options appears if the file type selected is datalogger, data capture or signal monitoring. In case of data capture (if the capture was done in the Spectrum Analyzer mode) shows the spectrum reference. In case of signal monitoring it opens the signal monitoring viewer.

To get out from the Installation manager press any key to access MEASUREMENT, SPECTRUM or TV mode.



[Click here to watch this video: Installation manager](#)

6.4 New Installation

In the list of installations, when selecting the option Create New  it runs the installation wizard that helps to create a new installation.

- 1 During the process, the user has the option to edit the default name assigned or import data from another installation.
- 2 The user can select the channel plans (terrestrial and satellite) that will be used in that installation. At least one for each band has to be selected.
- 3 For satellite channel plans the user can select the Diseqc commands associated to the installation and also the satellite band (Ku-Ka or C band) and the frequencies of the LNB Oscillator.
- 4 During the creation process the softkeys functions are: Next (it goes to the next step), Previous (it goes to the previous step) or Cancel (it cancels the process).
- 5 When finish, the new installation created will be the current installation.

6.5 Tools

In the list of installations, when pressing the Tools  option it shows a menu with some options to edit the installation files:

- Mark All: It selects all installations in the list of installations.
- Unmark All: It deselects all installations in the list of installations.



- Archive: It compresses (using the ZIP algorithm) the selected installations to save more space. A zipped installation shows a box icon  at the left side in the list of installations. A zipped installation can be loaded as anyone else, but the load time can be slightly higher because previously it is unzipped automatically. Once the installation is unzipped the user must re-zip it if necessary. To transfer an installation file from the equipment to a PC, it must have been previously zipped.
- Delete: It deletes the selected installations and all the files associated to them. The DEFAULT installation cannot be deleted.
- Rename: It edits the name of the installation selected in the list of installations. The installation by default DEFAULT cannot be renamed.
- Export to USB: It saves the installations files selected in the list of installations to an USB stick connected to the instrument. The installation file is exported in zip format.
- Import from USB: It imports installation files from a USB stick connected to the equipment. It has to use the same folder structure that is generated when exporting to USB (for more details see next section).
- Installed Antennas: It allows user to remove antenna files on the meter.



6.6 Importing Data from USB

The data import tool allows the user to import data files in a simple way from an USB flash drive to the equipment.

Data available to be imported are:

- Installations.
- Channel Plans.
- Antennas.

► Operation

- 1 Copy the file to be imported on a flash drive and plug it into USB port. The file must be in the proper format so the system can recognize it.
- 2 Press the Installation Management key .
- 3 Press the key  "Tools".
- 4 Select the "Import from USB" option.
- 5 The Import Files window appears. Select the file and press the  key: "Import".

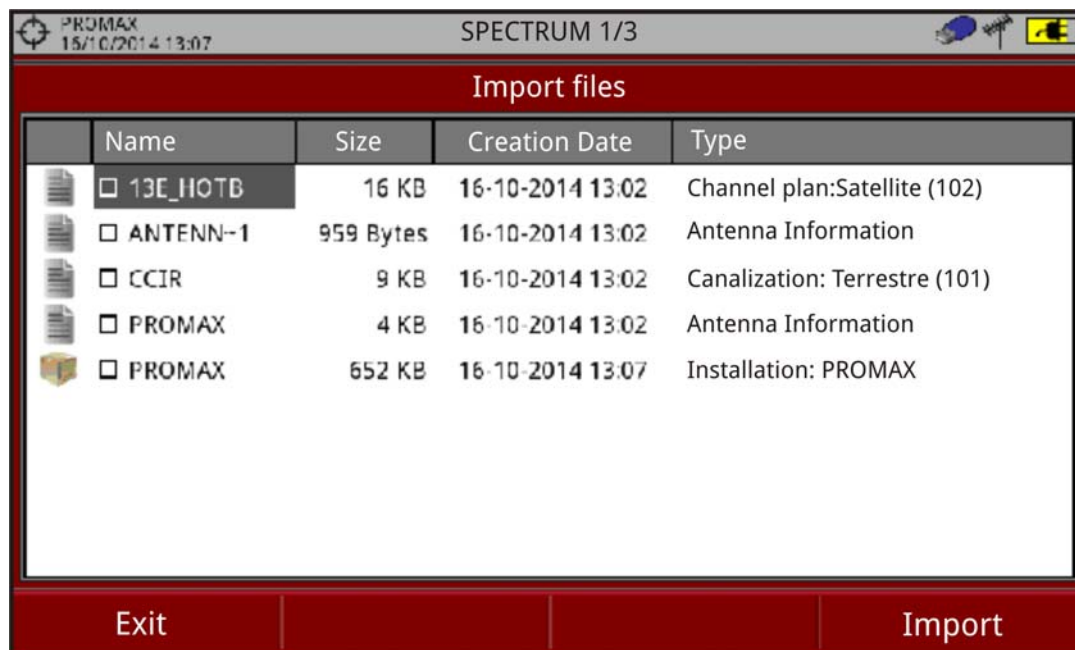

Figure 63. Import Files window

- 6 If the file import is successful then a window shows a confirmation message.



7 CONNECTING TO EXTERNAL DEVICES

7.1 Description

The meter can interact with external devices, sharing information through its interfaces. Connection types are:

- Input/output data via mini-USB port.
- Video/Audio analogue input via **V/A** port.
- DiSEqC, SCD/EN50494 standard (also known as SatCR) and SCD2/EN50607 standard (also known as JESS) interface via **RF** connector.

Next is described each of these interfaces and their interaction with external devices.

7.2 USB Port

The equipment has a female mini USB port that uses a USB media specific protocol called "On-the-Go" (OTG abbreviated).

This type of communication allows the equipment to work in two different ways depending on the device connected to the USB port: as a server (host) or device. More often, the meter will work as a host when connecting a USB memory and as device when connecting to a computer. This feature makes the equipment in a much more versatile tool.





7.2.1 USB Flash Drive

This connection allows the user to copy files (screenshots, channel plans, dataloggers, DiSEqC commands and others) and export/import installations from the equipment to the USB and vice versa.



► To copy some specific data from an installation

- 1 Connect the CC-045 (USB / mini-USB) cable to the mini-USB port.
- 2 Plug the USB stick into the cable.
- 3 USB icon should appear on the top right corner of the equipment. This icon indicates that an USB stick has been detected at the port.





- 4 Press the Installations key  and check the installation to download some of its data.
- 5 Press the key : Manage to access the data of the selected installation.
- 6 Press the key : Filter by type to select the type of list to view (list of all the files, only screenshots, only channel plans, only dataloggers or only DiSEqC commands).
- 7 Select the files from the list to be copied on the USB memory stick, by pressing the joystick or by pressing : File and selecting "Mark All" (it selects all files on the list displayed).
- 8 Once files are selected press : File and select the "Copy to USB" option. This option is enabled only if it detects that there is an USB connected to the equipment and if any file has been selected.
- 9 It shows a progress bar and a message informing that files are being copied to the USB.
- 10 When finish you can remove the cable with the USB stick memory directly from the equipment and connect it to a computer to view the files copied.
- 11 Default files are copied to the root directory of the USB memory. Screenshots appear with PNG extension and data with XML extension.

► **To export one or more complete installations**

- 1 Connect the CC-045 (USB / mini-USB) cable to the mini-USB port.
- 2 Plug the USB stick into the cable.
- 3 USB icon should appear on the top right corner of the equipment. This icon indicates that an USB stick has been detected at the port.
- 4 Press the Installations key  and check the installations to export.
- 5 Press the key : Tools and select Export to USB.
- 6 A progress bar and a message indicates that the files are being copied to the USB. The files are copied to the root directory of the USB in ZIP format.
- 7 When finished, the cable can be extracted directly with the USB stick and connect it to a computer to display the copied files.
- 8 Unzip the installation file to access the data.



► To import one installation

- 1 Connect the CC-045 (USB / mini-USB) cable to the mini-USB port.
- 2 Plug the USB stick into the cable.
- 3 USB icon should appear on the top right corner of the equipment. This icon indicates that an USB stick has been detected at the port.
- 4 Press the Installations key .
- 5 Press de key : Tools and select Import from USB.
- 6 A dropdown menu shows the installations identified in the USB memory. An installation can be imported if it has the same folder structure than when exporting. Select the installation to import from those available.
- 7 The import process starts. If the name of the installation matches with an existing one, it gives a warning before import.

7.2.2 NetUpdate Connection

► Description

The NetUpdate software is available for free on the download page at the PROMAX website.

NetUpdate has the following functions:

- Update the firmware of the meter.
- Open/Receive/Save/Print data files captured with the Datalogger function.
- Transmit/Receive/Edit/Save channel plans.
- Create/Edit channel plans.

For more information about the NetUpdate program, see the user's manual, which is available on the PROMAX website.



Click here to watch this video: [Creation of a channel plan](#)





Click here to watch this video: [Generating a measurement report](#)

► Operation

- 1 Install the NetUpdate program on the PC. Install the NetUpdate program on the PC. All permissions requested during the installation must be approved for a correct operation of the program.
- 2 Connect the equipment to your computer using the cable CC-041 (mini USB male – USB male) supplied with the equipment.
- 3 Run NetUpdate on your PC.
- 4 If connection is successful, a confirmation window will appear and you will be able to see the meter data in the main NetUpdate window (for details about NetUpdate program, download the manual from the PROMAX website).

7.3 Input Jack Connector

The V/A input connector allows connecting a video/audio analogue input signal. This connection allows the user to view an image on the meter screen coming from an external source by following these steps:

- 1 Connect the supplied jack 4V cable to the video/audio input connector, ensuring that the plug is fully inserted.
- 2 Connect the opposite end (RCA connector) to the source of video/audio.
- 3 Switch on the meter and select terrestrial band and analogue signal.
- 4 Select TV mode  and press key : Input.
- 5 From the menu, select "External". A message shows that the external input has been selected.
- 6 After a few seconds, the input image will be displayed on screen.





- 7 With the option : Aspect, you can select the aspect ratio of the image, between 4:3 and 16:9.

NOTE: If the equipment is displaying an external analogue video, it will not switch to internal video mode anymore when that external video is disconnected or lost.



7.4 RF Connector

7.4.1 DiSEqC Commands

The RF connector allows controlling an antenna using DiSEqC commands. DiSEqC (Digital Satellite Equipment Control) is a communication protocol between the satellite receiver and the installation accessories of satellite (switches, LNBs, etc.) proposed by Eutelsat, in order to standardize the diversity of switching protocols (13 to 18 V, 22 kHz) and meet the needs of the installations for the reception of digital TV.

- 1 Connect the RF cable to the RF connector for the input signal of the equipment.
- 2 Press the **Spectrum** key  to access the spectrum analyzer mode.
- 3 Press the **Settings** key  and select the satellite band.
- 4 From the **Settings** menu, select the polarization (horizontal/vertical) and the satellite band (high/low).
- 5 If necessary, enable the **Supply output** and select the supply voltage for the LNB.

NOTE: When tuning by channel is selected, polarization, satellite band and supply output cannot be changed, because these parameters are determined by the channel plan.



- 6 Select the option **DiSEqC mode**.
- 7 Two new functions appear on the softkeys: Command  and Software . DiSEqC programs appear classified in categories or folders.
- 8 Select the command or program and press the joystick to send it to the antenna. These commands or programs allow the user to control an antenna



(for more information about DiSEqC commands and programs download document from PROMAX website).

7.4.2 SCD / EN50494 (SatCR) Commands

By means of function SCD/EN50494 (international standard, also known as SatCR) it is possible to control the devices of a TV satellite installation that are compatible with this standard, which allows to concentrate downlink frequencies (slots) by an only cable. By this way each user using a slot can tune and decode any signal present in the satellite.

- 1 Connect the RF cable to the RF connector for the input signal of the equipment.
- 2 Press the **Spectrum** key  to access the Spectrum analyzer mode.
- 3 Press the **Settings** key  and select the satellite band.
- 4 Select the polarization (horizontal/vertical) and the satellite band (high/low).
- 5 If necessary, enable the **Supply output** and select the supply voltage for the LNB.

NOTE: When tuning by channel is selected, polarization, satellite band and supply output cannot be changed, because these parameters are determined by the channel plan.

- 6 In the option SCD/EN50494, select ON to enable it. It appears the  icon at the top right corner.
- 7 Also in the SCD/EN50494 option, select **Configuration** to access SCD/EN50494 parameters.



Figura 64.

The configuration window shows the options that user can modify: number of slots, slot selected, device address, pilot signal activation (when activating the SatCR device located in the headend, it emits a pilot signal with constant level for each downlink frequency to identify available channels), selected satellite and frequency step. For each type of slot number unit there is a list of independent frequencies to select. The user may have separate frequencies for 2, 4 or 8 slots units and these values are not lost when switching from one type to another.

- 8 Once SCD/EN50494 is configured, the user can select the slot by the "Tuning" key.

7.4.3 SCD2 / EN50607 (JESS) Commands

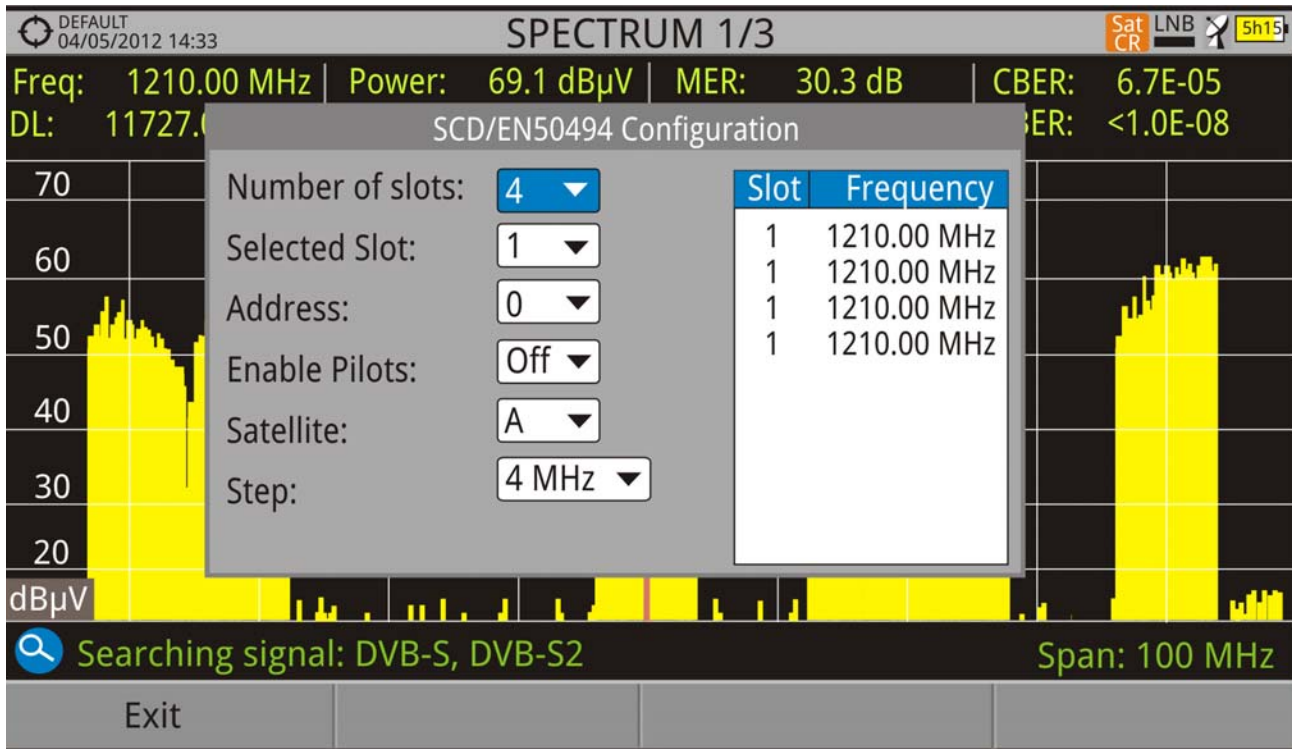
Through the SCD2/EN50607 (international standard, also known as JESS) function is possible to control the devices of a TV satellite installation that are compatible with this standard. This technology has two main functionalities: one for configuring headends, and another for configuring sockets. This technology requires bidirectional DiSEqC capabilities. Although this equipment does not have such capability, a simpler way to blind configure units has been implemented, without any confirmation other than spectrum reference. For information about JESS technology, developed by JULTEC, refer to its website (<http://jultec.de/>).

- 1 Connect the RF cable to the RF connector for the input signal of the equipment.



- 2 Press the Spectrum key to access the spectrum analyzer mode.
- 3 Press the Settings key and select the satellite band. From the Settings menu, select the polarization (horizontal/vertical) and the satellite band (high/low).
- 4 If necessary, enable the Supply output and select the supply voltage for the LNB.

NOTE: When tuning by channel is selected, polarization, satellite band and supply output cannot be changed, because these parameters are determined by the channel plan.

- 5 In the option SCD2/EN50607, select ON to enable it. It appears the JESS icon at the top right corner of the screen.
- 6 Now the SCD2/EN50607 option shows a new menu. Select Configuration to access the configuration parameters. The user can select the power, central frequency, tone beacon and satellite for each band. The user can also select the number of user bands and the available satellites through the option "Configuration" on key F2.

INSTAL55 05/09/2014 12:45		SCD2/EN50607 CONFIGURATION			JESS 13V	3h08
UB	Power	Central Frequency	Tone Beacon	Satellite		
UB_1	Enabled	1076 MHz	Off	A		
UB_2	Disabled	1178 MHz	Off	A		
UB_3	Disabled	1280 MHz	Off	A		
UB_4	Disabled	1382 MHz	Off	A		
UB_5	Disabled	1484 MHz	Off	A		
UB_6	Disabled	1586 MHz	Off	A		
UB_7	Disabled	1688 MHz	Off	A		
UB_8	Disabled	1790 MHz	Off	A		
Exit		Configuration		Send		

Figura 65.

- 7 Also from option SCD2/EN50607, select Socket to access the configuration of socket. The user can select the user bands that should be enabled for the socket and to send them to configure the socket.





Figura 66.

- 8 Once it is configured, the user, through the  key "Tuning" can select the user band.
- 9 User frequency tuned is stored for each User band (UB) and it is restored each time the multiswitch is being configured.

NOTE: When not detecting any SCD2 receiver, the function enters in a more basic mode, allowing sending configuration commands even with nothing connected. In that mode, the user can debug cable issues or even SCD2 units problems.

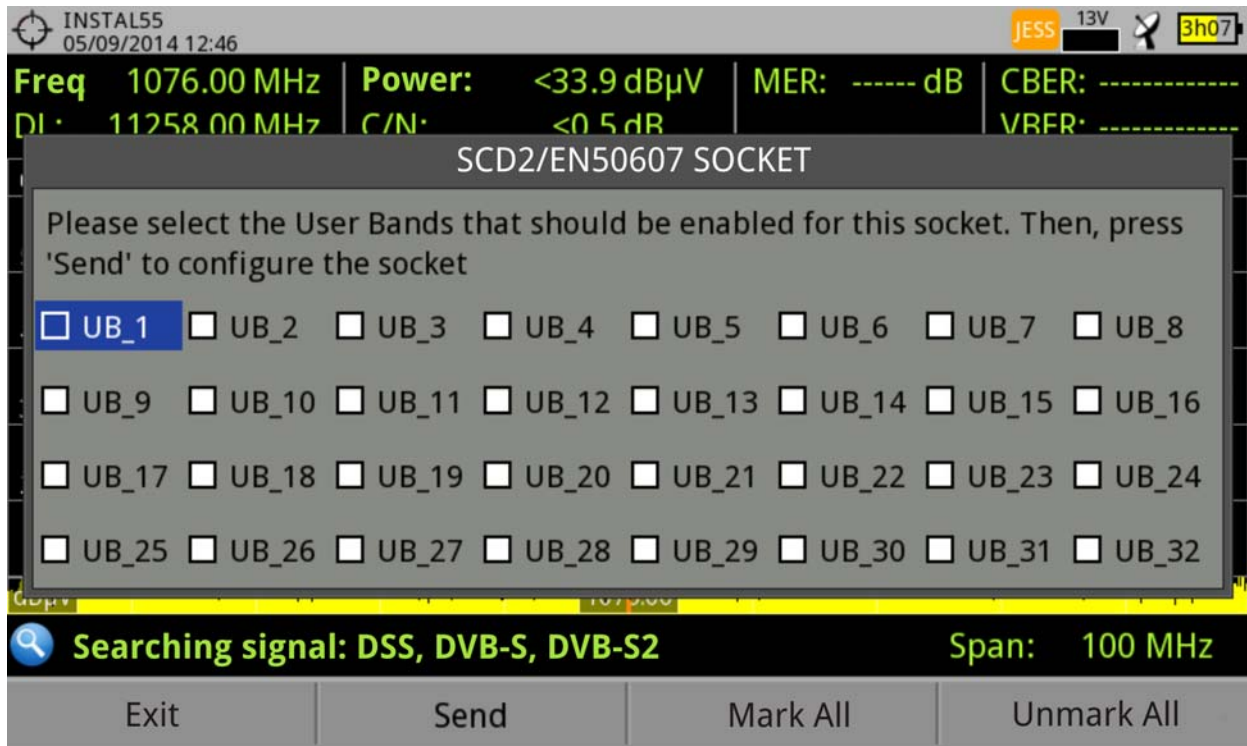
NOTE: For special devices that use non-standard commands, it has been added a channel bandwidth for every user band.



8 SPECIFICATIONS

8.1 General

► Inputs and Outputs

Parameter	Value	Additional Data
RF Input		
Input Connector	F male	75 Ω
Maximum Signal	130 dBμV	
Maximum Input Voltage	50 V rms	DC a 100 Hz; powered by the AL-103 power charger
	30 V rms	DC a 100 Hz; not powered by the AL-103 power charger
	140 dBμV	Protected up to 30 seconds
Analogue Video Input		
Input Connector	Multipole Jack	Zin=75 Ω
Sensibility	1 Vpp	75 Ω; positive video
Analogue Audio Input		
Input Connector	Multipole Jack	Zin=10k; same V/A input multipole jack
USB Interface		
Connector	mini-USB	
Features	OTG (on-the-go)	
	Mass Storage Host	Can read and write on a pendrive USB CDC
	Serial port emulation	
	USB CDC	CDC: Communication device class
Monitor Display		
Monitor	7" TFT	Transmissive colour dot matrix type
Aspect Ratio	16:9	
Format	800 x 480 dots	(R,G,B)(W) x (H)
Brightness	350 cd/m ²	
External Unit Power (through the RF input connector)		
Terrestrial Supply	External	
	5 V	Up to 500 mA
	12 V	Up to 500 mA
	24 V	Up to 250 mA
Satellite Supply	External	Up to 500 mA
	5 V	Up to 500 mA
	13 V	Up to 500 mA
	15 V	Up to 500 mA
	18 V	Up to 500 mA
22 kHz Signal Voltage	0.65 V ± 0.25 V	Selectable in Satellite band



Parameter	Value	Additional Data
22 kHz Signal Frequency	22 kHz ± 4 kHz	Selectable in Satellite band
DiSEqC Generator	According to DiSEqC 2.x (DiSEqC 1.2 commands implemented)	DiSEqC is a trademark of EUTELSAT
SATCR / SCD (EN50494)	Available	
dCSS / SCD2 (EN50607)	Available	Compatible with LNB SKY UK

► Mechanical Features

Parameter	Value	Additional Data
Dimensions	290x185x65 mm	(W) x (H) x (D)
Weight	1.5 kg	Without installed options
Size	3,487 cm ³	

► Power Supply

Parameter	Value	Additional Data
Internal Battery	7.2 V; 6,6 Ah	Li-Ion Intelligent battery
Battery Operation Time	> 2.5 hours in continuous mode	No EXTERNAL supply active
Recharging time	3 hours up to 80%	With meter off
External Voltage	12 V DC	Only using PROMAX supplied accessories
Consumption	40 W	
Auto Power Off	Programmable	After the selected amount of minutes without operating on any control (disabled by user)

► Operating Environmental Conditions

Parameter	Value	Additional Data
Altitude	Up to 2000 m	
Temperature Range	From 5 °C to 45 °C	Automatic disconnection by excess of temperature
Max. Relative Humidity	80%	Up to 31°C; decreasing lineally up to 50% at 40 °C.

NOTE: Equipment specifications are set in these environmental operating conditions. Operation outside these specifications is also possible. Please check with us if you have specific requirements.

► Included Accessories

Parameter	Value	Additional Data
1x CC-046	Jack 4V/RCA cable	
1x CC-041	USB on-the-go cable	USB A (female) - mini USB B (male)
1x CC-045	USB cable	USB A (male) - mini USB B (male)
1x AA-103	Car lighter charger	
1x AL-103	External DC charger	
1x AD-056	"F"/f-"DIN"/f adapter	



Parameter	Value	Additional Data
1x AD-057	"F"/f-"F"/f adapter	
1x CA-005	Mains cord	
1x CB-084	Rechargeable Li+ battery 7,2 V 13 Ah	Built-in
1x DC-300	Transport belt	
1x DC-302	Carrying bag	
1x DG0257	Quick Reference Guide	
1x MN-001	Monopod	

NOTE: It is recommended to keep all the packing material in order to return the equipment, if necessary, to the Technical Service.

8.2 Measurement Mode

► DVB-T

Parameter	Value	Additional Data
Modulation	COFDM	
Margin of power Measurement	35 dB μ V - 115 dB μ V	786 MHz, 8k, GI=1/4 64 QAM, CR=2/3 Sensitivity (QEF): 29 dB μ V
Measurement	Power, CBER, VBER, MER, C/N and Link Margin	VBER measurement can go down to <1E-10; CBER measurement can go down to <1E-7
Displayed Data	Numeric and level bar	
Carriers	2k, 8k	
Guard Interval	1/4, 1/8, 1/16, 1/32	
Code Rate	1/2, 2/3, 3/4, 5/6, 7/8	
Constellation	QPSK, 16-QAM, 64-QAM	
Bandwidth	6, 7 and 8 MHz	
Spectral inversion	ON, OFF	Auto
Hierarchy	Indicates hierarchy mode	
Cell ID	Detected from transmitter station	
TPS signalling	Time slicing, symbol interleaver and MPE-FEC	
Tuning Range	45 - 1000 MHz	

► DVB-T2

Parameter	Value	Additional Data
Profiles	T2-Base, T2-Lite	
Modulation	COFDM	
Margin of Power Measurement	35 dB μ V - 115 dB μ V	786 MHz, 32k, GI=1/32 256 QAM Rotated, CR=3/5 Sensitivity (QEF): 30 dB μ V
Measurement	Power, CBER, C/N, LBER, MER, Link Margin, BCH ESR, LDP Iterations and wrong packets	LBER measurement under 1E-10



Parameter	Value	Additional Data
Displayed Data	Numeric and level bar	
Carriers	1k, 2k, 4k, 8k, 8k+ EXT, 16k, 16k+ EXT, 32k, 32k+ EXT	
Guard Interval	1/4, 19/256, 1/8, 19/128, 1/16, 1/32, 1/128	
Bandwidth	5, 6, 7 and 8 MHz	
Spectral Inversion	ON, OFF	Auto
Pilot Pattern	PP1 - PP8	
PLP Code Rate	1/2, 3/5, 2/3, 3/4, 4/5, 5/6	
PLP Constellation	QPSK, 16QAM, 64QAM, 256QAM	
PLP Constellation Rotation	ON, OFF	Auto
PLP ID	0 - 256	
Cell ID	Detected from transmitter station	
Network ID	Detected from transmitter station	
T2 System ID	Detected from transmitter station	
Tuning Range	45 - 1000 MHz	

► DVB-C

Parameter	Value	Additional Data
Modulation	QAM	
Margin of Power Measurement	45 - 115 dB μ V	786 MHz 16 QAM Sensitivity (QEF): 30 dB μ V 32 QAM Sensitivity (QEF): 33 dB μ V 64 QAM Sensitivity (QEF): 36 dB μ V 128 QAM Sensitivity (QEF): 39 dB μ V 256 QAM Sensitivity (QEF): 42 dB μ V
Measurements	Power, BER, MER, C/N and Link Margin	
Displayed Data	Numeric and level bar	
Demodulation	16/32/64/128/256 QAM	
Symbol Rate	1000 - 7100 kbauds	
Roll-off (α) factor of Nyquist filter	0.15	
Spectral Inversion	ON, OFF	Auto
Tuning Range	45 - 1000 MHz	

► DVB-C2

Parameter	Value	Additional Data
Modulation	QAM	
Margin of Power Measurement	45 - 115 dB μ V	786 MHz, 32k, GI=1/128 1024 QAM Rotated, CR=9/10 Sensitivity (QEF): 48 dB μ V
Measurements	Power, CBER, MER, C/N, LBER, BCH ESR, LDP Iterations and wrong packets	
Displayed Data	Numeric and level bar	
Carriers	4k	
Guard Interval	1/64, 1/128	
Bandwidth	6, 8 MHz	
Spectral Inversion	ON, OFF	Auto
Pilot Pattern	PP1 - PP8	



Parameter	Value	Additional Data
Code Rate PLP	2/3, 3/4, 4/5, 5/6, 8/9, 9/10	
PLP Constellation	64 QAM, 256 QAM, 1k QAM, 4K QAM	
Dslice PLP	0 - 256	Auto
PLP ID	0 - 256	
Cell ID	Detected from transmitter station	
Network ID	Detected from transmitter station	
C2 System ID	Detected from transmitter station	
Tuning Range	45 - 1000 MHz	

► Analogue TV

Parameter	Value	Additional Data
Colour System	PAL, SECAM and NTSC	
Standard Supported	M, N, B, G, I, D, K and L	
Sensibility	40 dB μ V for a correct synchronism	

► FM

Parameter	Value	Additional Data
Tuning range	45 - 1000 MHz	
Tuning step size	10 kHz	
Sensitivity	5 dB μ V	150 MHz (S+N/N = 40 dB)
Selectivity (mono)	\pm 200 kHz 25 dB	

► DVB-S

Parameter	Value	Additional Data
Modulation	QPSK	
Margin of Power Measurement	35 dB μ V - 115 dB μ V	2150 MHz, 27500 kSps, CR=2/3 Sensitivity (QEF): 29 dB μ V 18 dB μ V a 2.15 GHz / 2 MSs; 30 dB μ V a 2.15 GHz / 27 MSs; 33 dB μ V a 2.15 GHz / 45 MSs
Measurements	Power, CBER, MER, C/N and Link Margin	
Displayed Data	Numeric and level bar	
Symbol Rate	1 - 45 Mbauds	
Roll-off (α) factor of Nyquist filter	0.35	Auto
Code rate	1/2, 2/3, 3/4, 5/6, 7/8	
Spectral Inversion	ON, OFF	
Tuning Range	950 - 2150 MHz	

► DVB-S2

Parameter	Value	Additional Data
Modulation	QPSK, 8PSK, 16APSK, 32APSK	



Parameter	Value	Additional Data
Margin of Power Measurement	35 dBμV - 115 dBμV	2150 MHz, 27500 kSps, CR=2/3 Roll-off: 0,20 QPSK Sensitivity (QEF): 26 dBμV 8PSK Sensitivity (QEF): 30 dBμV 8PSK: 24 dBμV a 2.15 GHz / 2 MSs; 34 dBμV a 2.15 GHz / 27 MSs
Measurements	Power, CBER, LBER, MER, C/N, BCH ESR, Wrong Packets and Link Margin	
Displayed Data	Numeric and level bar	
Symbol Rate	2 - 45 MSps	QPSK, 8PSK, 16APSK, 32APSK
Roll-off (α) factor of Nyquist filter	0.20, 0.25 and 0.35	
Code rate (8PSK)	1/2, 3/5, 2/3, 3/4, 4/5, 5/6, 8/9, 9/10	
Code rate (QPSK)	3/5, 2/3, 3/4, 5/6, 8/9, 9/10	
Spectral Inversion	ON, OFF	Auto
Pilots	Indicator	
TS clock	Available	Warning message when the TS clock is too high
Tuning Range	950 - 2150 MHz	

► DSS

Parameter	Value	Additional Data
Modulation	QPSK	
Margin of Power Measurement	35 dBμV - 115 dBμV	
Measurements	Power, CBER, VBER, MER, C/N and Noise Margin	
Displayed Data	Numeric and level bar	
Symbol Rate	20 Mbauds or variable	Auto detected
Roll-off (α) factor of Nyquist filter	0.2	
Code rate	1/2, 2/3, 6/7 and AUTO	
Spectral Inversion	ON, OFF	Auto
Tuning Range	950 - 2150	

► DCII

Parámetro	Valor	Datos Adicionales
DCII	It plays video and audio	TBD



8.3 Spectrum Analyzer Mode

► Digital Signal

Parameter	Value	Additional Data
General Parameters		
Markers	1	It displays frequency, level indication, level difference, frequency difference
Reference Level	60 dB μ V - 135 dB μ V	Adjustable in steps of 5 dB
Spectrum Range		Span, dynamic range and reference level are variable by means of arrow cursors
Terrestrial		
Tuning range	45 - 1000 MHz	Continuous tuning from 5 to 1000 MHz
Tuning mode	Channel or frequency	Channel plan configurable; tune step 50 kHz
Tuning Resolution	10 kHz	
Measurement Range	10 dB μ V - 130 dB μ V	3.16 μ V a 3.16 V
Span (min-max)	Full span-500-200-100-50-20-10 MHz	selection by joystick
Digital channels measures	Channel power, C/N, MER, BER, LM	According to modulation type
Satellite		
Tuning range	950 - 2150 MHz	
Tuning mode	Intermediate frequency or downlink	Channel plan configurable; tune step 50 kHz
Tuning Resolution	10 kHz	
Measurement range	10 - 130 dB μ V	35.5 μ V - 3.16 V
Span	Full span-500-200-100-50-20-10 MHz	selection by joystick
Digital Channel Measurements	Channel Power, C/N, MER, BER, LM	According to modulation type

► Analogue Signal

Parameter	Value	Additional Data
General Parameter		
Attenuation scale	Auto-range	
Numerical indication	Absolute value according to selected units	
Graphical indication	Analogue bar on screen	
Audible indicator	Pitch sound	Tone with pitch proportional to signal strength
Terrestrial		
Tuning Range	5 - 1000 MHz	
Tuning Mode	Manual	
Tuning Resolution	10 kHz	
Measurement Range	15 dB μ V - 130 dB μ V	3.16 μ V - 3.16 V
Analogue channels measures	Level, C/N, V/A	



Parameter	Value	Additional Data
Accuracy	±1,5 dB	20 dBμV - 130 dBμV @ 990 MHz 10 μV - 3.16 V 22 °C ± 5 °C
Out of range indication	<, >	
Satellite		
Tuning Range	950 - 2150 MHz	
Tuning Mode	Intermediate frequency or downlink	Channel plan configurable
Tuning Resolution	10 kHz	
Measurement Range	15 dBμV (250 - 1800 MHz) 20 dBμV (1800 - 2300 MHz) 24 dBμV (2300 - 2500 MHz)	31.6 μV - 3.16 V
Analogue channels measurements	Level, C/N	
Accuracy	±1,5 dB	35 dBμV - 100 dBμV; 950 - 2050 MHz 22 °C ± 5 °C
Out of range indication	<, >	

8.4 TV Mode

► Video

Parameter	Value	Additional Data
Codecs	MPEG-1	
	MPEG-2	MP@HL (Main profile high level)
	MPEG-4 AVC H.264	High Profile Level 4.1; maximum bitrate 40 Mbps
Maximum Image Size	1920x1080x60i; 1280x720x60p/50p	
Minimum Image Size	352x240x30p; 352x288x25p	
Bitrate	40 Mbps	
Aspect Ratio	16/9; 4/3	
SI/PSI Data	Service list and main PIDs	
HD Video Resolution	1080, 720 and 576	Progressive or interlaced

► Audio

Parameter	Value	Additional Data
Codecs	MPEG-1	
	MPEG-2	
	HE-AAC	
Demodulation	According to the TV standard	
De-emphasis	50 μs	75 μs (NTSC)
Sound subcarrier	Digital frequency synthesis according to the TV standard	

► Transport Stream

Parameter	Value	Additional Data
Communication Protocol	MPEG-2	



Parameter	Value	Additional Data
Packets	188 or 204 bytes	Automatic detection
Video Info	Type, bitrate, format, aspect ratio, frequency, profile, PID	
Service Info	Network, provider, NID, ONID, scrambled/free, TSID, SID, LCN	
Audio Info	Type, bitrate, format, frequency, mono/stereo, language, PID	

8.5 Tools

► Constellation

Parameter	Value	Additional Data
Type of Signal	DVB-T, DVB-T2, DVB-C, DVB-C2, DSS, DVB-S and DVB-S2	
Displayed Data	I-Q Graph	

► Echoes

Parameter	Value	Additional Data
Type of Signal	DVB-T, DVB-T2, DVB-C2	
Measurement range	Depends on the standard, carrier and guard interval	
Delay	0.1 - 224 us	Typical configuration (DVB-T 8K, GI = 1/4)
Distance	0.3 - 67,2 km	Typical configuration (DVB-T 8K, GI = 1/4)
Power Range	0 dBc - -30 dBc	Typical configuration (DVB-T 8K, GI = 1/4)
Time scale	1/3 Symbol Period	

► LTE Ingress Test

Parameter	Value	Additional Data
Type of signal	DVB-T, DVB-T2, DVB-C, DVB-C2	
Displayed Data	LTE band plus quality parameters for a selected TV channel	

► Atenuación Test

Parameter	Value	Additional Data
Test Frequencies	3 selectable pilots	



► **Datalogger**

Parameter	Value	Additional Data
Stored Data	Signal type, modulation parameters, all measures available for the detected signal type, and time stamp, PSI info for each measured channel	In case of DVB-T2 signal it stores all information from PLPs.
Timestamp	Date and time at each measured channel	



9 MAINTENANCE

9.1 Instructions for Returning by Mail

Instruments returned for repair or calibration, either within or out of the warranty period, should be sent with the following information: Name of the Company, name of the contact person, address, telephone number, receipt (in the case of coverage under warranty) and a description of the problem or the service required.

9.2 Considerations about the Screen

This paragraph offers key considerations regarding the use of the colour screen, taken from the specifications of the manufacturer.

In the TFT display, the user may find pixels that do not light up or pixels that are permanently lit. This should not be regarded as a defect in the TFT. In accordance with the manufacturer quality standard, 9 pixels with these characteristics are considered admissible.

Pixels which are not detected when the distance from the surface of the TFT screen to the human eye is greater than 35 cm, with a viewing angle of 90° between the eye and the screen should not be considered manufacturing defects either.

It is advisable a viewing angle of 15° in the 6.00 o'clock direction in order to obtain the optimum visualization of the screen.

9.3 Cleaning Recommendations

The equipment consists of a plastic case and a TFT screen. Each element has its specific cleaning treatment.

► Cleaning the Screen

The TFT screen surface is VERY DELICATE. It has to be cleaned with a soft fabric cloth (cotton or silk), always making the same move from left to right and from top to bottom, without putting pressure on the screen.

The TFT screen has to be dry-cleaned or with a product specifically designed for TFT screens, by slightly dampening the cloth. NEVER use tap or mineral water, alcohol or conventional cleaning products, because they contain components that can damage the screen.

Turn off the equipment to locate dirt on the screen. After cleaning, wait a few seconds before turning on.

**► Cleaning the Plastic Case**

The equipment has to be disconnected before cleaning the case.

The case must be cleaned with a solution of neutral soap and water, using a soft cloth dampened with this solution.

Before use, the equipment has to be completely dry.

Never clean with abrasive soaps, chlorinated solvents or aromatic hydrocarbons. These products may degrade the case.



i ADDITIONAL INFORMATION

i.1 Multimedia Content

On the PROMAX channel on Youtube you can find video tutorials and other audiovisual documents related to the field strength meter.

Name	Link
PROMAX channel on YOUTUBE	https://www.youtube.com/user/PROMAXElectronics
Playlist: Field Strength Meter Tutorials	https://www.youtube.com/watch?v=48klYEAR_ZU&list=PL3hht4WG655S6PXlzd3G9ltU2dBcamuQR
Playlist: NetUpdate4 Software	https://www.youtube.com/watch?v=akknHR3nhV8&list=PL3hht4WG655SqAUWkyMGuT9Ne6dnUOC4V

i.1 Additional Documents

On the PROMAX website you can find additional information to go deeper in some aspects related to the field strength meter.

Name	Description	Link
PROMAX Download Area	Documentation related to PROMAX equipment	http://www.promaxelectronics.com/ing/downloads/user-manuals
Signals Description	Brief definition of all signals and parameters detected by the meter	http://www.promaxelectronics.com/ing/downloads/user-manuals/ranger-neo-3/high-class-field-strength-meter-and-spectrum-analyzer
How to Point a Dish Antenna	Explanation about how to use the meter to install and point a satellite dish	http://www.promaxelectronics.com/ing/downloads/user-manuals/ranger-neo-3/high-class-field-strength-meter-and-spectrum-analyzer
DiSEqC Commands	Description of DiSEqC commands for remote control of antennas	http://www.promaxelectronics.com/ing/downloads/user-manuals/ranger-neo-3/high-class-field-strength-meter-and-spectrum-analyzer
Remote Control Commands	Description of remote commands for remote control of the meter	http://www.promaxelectronics.com/ing/downloads/user-manuals/ranger-neo-3/high-class-field-strength-meter-and-spectrum-analyzer
NetUpdate Manual	Instructions manual about the NetUpdate software to update firmware and manage data from the meter	http://www.promaxelectronics.com/ing/downloads/user-manuals/ranger-neo-3/high-class-field-strength-meter-and-spectrum-analyzer

i.2 Social Networks

Name	Link
Twitter	@PROMAX_news



Name	Link
Linkedin	https://www.linkedin.com/company/1493234/
Facebook	https://www.facebook.com/promaxelectronics/
Google	https://plus.google.com/+PromaxelectronicsGlobal



ii INDEX

- Analogue Signal 37
- Antenna remove 94
- Aspect Ratio 37
- Audio 37
- Audio Signal 36
- Audio Tone 36

- Band selection 20
- Battery Time 25
- Beacon signal 52
- Brightness 23, 25

- Centre Frequency 45
- Channel Plan Adding 92
- Colour System 23
- Cursor 44

- Dashed BW 37
- Detector Type 37
- Discovered URLs 38
- DiSEqC 21
- Downlink 31

- External Power Supply 20

- Generic Signal 51

- Importing data from USB 94
- Installation creation 93
- Installation data export 96
- Installation edition 93
- Installation export 97
- Installation export from USB 94
- Installation export to USB 94
- Installation import 98
- Installations 17
- IRG Descriptor 53

- Joystick 13

- Keyboard Shorcuts 17

- LNB Drain 21
- LNB High Oscillator 22
- LNB Low Oscillator 22



Locking a Signal 51

Marker 36, 45

Marker Trace 36

Max. Hold 36

Measurement Mode Screens 38

Min. Hold 36

Minimal FM Level 26

Minimal Satellital Power 26

Minimal Terrestrial Level 26

Minimal Terrestrial Power 26

Netupdate connection 98

NTSC 23

Offset 26

PAL 23

Persistence of Spectrum 37

Polarization 22

Power Off 25

Preferences 17

Preferences Menu 23

RDS Data 50

Reference Level 44

Reference of Spectrum 37

Reset 8

Satellite Identification 51

SCD/EN50494 21

SCD2/EN50607 22

SECAM 23

Service Selection 35

Settings 17

Skin 25

Span 31, 44

Supply voltages 21

Time & Date 25

Tone Level 36

Touchscreen Calibration 25

TS Data 37

Tuned Audio Information 48

Tuned service information 47

Tuning by Channel 30

TV / Radio Mode Screens 45



Vertical Range 37
Video & Audio Settings 23
Volume 23



PROMAX ELECTRONICA, S.L.

Francesc Moragas, 71-75
08907 L'HOSPITALET DE LLOBREGAT (Barcelona)
SPAIN
Tel: 93 184 77 00 * Tel. Intl.: (+34) 93 184 77 02
Fax: 93 338 11 26 * Fax Intl.: (+34) 93 338 11 26
<http://www.promaxelectronics.com>
e-mail: promax@promaxelectronics.com