

HD RANGER

UltraLite

TV & SATELLITE ANALYSER



- 0 MI2070 -



SAFETY NOTES

Read the user's manual before using the equipment, mainly "**SAFETY RULES**" paragraph.

The symbol  on the equipment means "**SEE USER'S MANUAL**". In this manual may also appear as a Caution or Warning symbol.

WARNING AND CAUTION statements may appear in this manual to avoid injury hazard or damage to this product or other property.

MULTIMEDIA CONTENT

You can access instantly to any chapter by clicking on the title of the chapter in the table of contents.

Click on the arrow  at the top right of the page to return to the table of contents.

Throughout this manual are boxes with the symbol . It identifies a direct access to an explanatory video related to the function where it is. User has to click on this icon to watch the video.

All videos are in the PROMAX channel on YouTube, which is accessible through the PROMAX website at: www.promaxelectronics.com

USER'S MANUAL VERSION

Version	Date	Software Version
2.0	June 2017	20.3

- Please update your equipment to the latest software version to maximize its capacity.















What's new in manual version 2.0

- New function "Test & Go".
- Added 200 kHz and 1 MHz resolution filter.
- New function "Service Recording".
- TV 3/3: parameters in decimal or hexadecimal format and NIT version.
- DVB-S2: warning when TS clock is too high.
- DVB-S/S2: symbol-rate parameter can be set manually.
- In "Preferences" shows the hardware version of the equipment.
- New option: Center frequency available in manual or auto mode.
- New section "Energy Saving".
- HbbTV related link displayed.
- SCD2/EN50607.
- Signal monitoring improved (parameters, audio and pause options).
- New option to work with LTE external filter.
- New option: Center tuned frequency.
- Link Margin (LM) measurement on SPECTRUM screen 1/3 and 2/3
- Datalogger for "FSM" tool.
- New option to work with radio link down converters (from 1 to 11GHz).
- More info about HEVC video
- PLS multistream automatic identification (non-zero PLS)
- New tab "Tools" in "Preferences"
- New logger for "Task Planner"
- Improvement in LBER, VBER, CBER measurements
- Several minor corrections.
- Screens updated to r20.3.
- Menus updated to r20.3.

SAFETY RULES

- * **The safety could not be assured if the instructions for use are not closely followed.**
- * Use this equipment **connected only to systems with their negative of measurement connected to ground potential.**
- * The **AL-103** external DC charger is a **Class I** equipment, for safety reasons plug it to a supply line with the corresponding **ground terminal**.
- * This equipment can be used in **Overvoltage Category I** installations and **Pollution Degree 2** environments.
External DC charger can be used in **Overvoltage Category II**, installation and **Pollution Degree 1** environments.
- * When using some of the following accessories use only the specified ones to ensure safety.:
 - Rechargeable battery
 - External DC charger
 - Car lighter charger cable
 - Power cord
- * Observe all **specified ratings** both of supply and measurement.
- * Remember that voltages higher than **70 V DC** or **33 V AC rms** are dangerous.
- * Use this instrument under the **specified environmental conditions**.
- * When using the power adaptor, the **negative of measurement** is at ground potential.
- * **Do not obstruct the ventilation system of the instrument.**
- * Use for the signal inputs/outputs, specially when working with high levels, appropriate low radiation cables.
- * Follow the cleaning instructions described in the Maintenance paragraph.

* Symbols related with safety:

	DIRECT CURRENT		ON (Supply)
	ALTERNATING CURRENT		OFF (Supply)
	DIRECT AND ALTERNATING		DOUBLE INSULATION (Class II protection)
	GROUND TERMINAL		CAUTION (Risk of electric shock)
	PROTECTIVE CONDUCTOR		CAUTION REFER TO MANUAL
	FRAME TERMINAL		FUSE
	EQUIPOTENTIALITY		EQUIPMENT OR COMPONENT TO BE RECYCLED
			

Descriptive Examples of Over-Voltage Categories



Cat I Low voltage installations isolated from the mains.

Cat II Portable domestic installations.



Cat III Fixed domestic installations.

Cat IV Industrial installations.

TABLE OF CONTENTS

1 INTRODUCTION	1-1
1.1 Description	1-1
2 SETTING UP	2-3
2.1 Package Content.....	2-3
2.2 Power.....	2-4
2.2.1 First charge.....	2-4
2.2.2 Charging the battery	2-4
2.2.3 Charge/discharge times	2-5
2.2.4 Energy saving.....	2-5
2.2.5 Usage Tips	2-6
2.3 Equipment Details.....	2-7
2.4 Switching On/Off the equipment	2-9
2.5 Screen Icons and Dialog boxes	2-10
2.6 Menu Tree	2-11
2.7 Controls.....	2-15
2.7.1 Control keys.....	2-15
2.7.2 Keyboard shortcuts	2-16
2.7.3 Softkeys	2-21
2.7.4 Virtual Keyboard	2-21
2.8 StealthID Function	2-22
2.9 Settings and Configuration.....	2-24
2.9.1 Settings Menu	2-24
2.9.2 Video & Audio settings.....	2-27
2.9.3 Preferences Menu.....	2-27
3 MEASUREMENT MODE 	3-32
3.1 Introduction	3-32
3.2 Operation	3-33
3.3 Screen Description	3-33
3.4 GENERIC Signal.....	3-35
4 SPECTRUM ANALYSER MODE 	4-36
4.1 Introduction	4-36
4.2 Mode of operation	4-36
4.3 Screen Description	4-37
4.4 Control keys Operation	4-41
4.5 Specific Options in the Spectrum Analyser Mode	4-43
4.6 Select and edit parameters	4-45
4.7 Locking a signal.....	4-45
4.8 Satellite Identifier	4-46
5 TV MODE 	5-47
5.1 Introduction	5-47
5.2 peration.....	5-47

5.3	Screen Description	5-48
5.3.1	TV MODE: TV views	5-48
5.3.2	TV MODE: Radio views	5-52
5.4	Specific Options	5-53
5.5	IRG Descriptor	5-53
6	GENERAL MENU OPTIONS	6-55
6.1	F1: Tuning	6-55
6.2	F2: Signal Parameters	6-59
6.3	F3: Tools	6-60
7	TOOLS	7-61
7.1	Constellation	7-61
7.1.1	Description	7-61
7.1.2	Operation	7-61
7.1.3	Menu options	7-63
7.2	Echoes	7-64
7.2.1	Description	7-64
7.2.2	Operation	7-64
7.2.3	Menu options	7-66
7.3	Attenuation Test	7-66
7.3.1	Description	7-66
7.3.2	Operation	7-67
7.3.3	Menu options	7-69
7.4	Datalogger	7-70
7.4.1	Description	7-70
7.4.2	Operation	7-70
7.4.3	Menu options	7-76
7.4.4	Test & Go	7-77
7.5	Screen and Data capture (Export key)	7-77
7.5.1	Description	7-77
7.5.2	Operation	7-78
7.6	Explore Channel Plan	7-80
7.6.1	Description	7-80
7.6.2	Operation	7-80
7.6.3	Menu options	7-82
7.7	LTE Ingress test	7-82
7.7.1	Description	7-82
7.7.2	Operation	7-83
7.7.3	Menu options	7-86
7.8	Field Strength	7-86
7.8.1	Description	7-86
7.8.2	Operation	7-86
7.8.3	Settings	7-88
7.8.4	Creating and importing calibration tables	7-89
7.9	Task Planner	7-91
7.9.1	Description	7-91
7.9.2	Operation	7-91
7.9.3	Timer	7-95
7.10	Service Recording	7-96

7.10.1 Description.....	7-96
7.10.2 Operation.....	7-96
8 INSTALLATIONS MANAGEMENT	8-98
8.1 Description	8-98
8.2 Operation	8-98
8.3 Installation Management	8-99
8.4 Create a new installation	8-103
8.5 Tools.....	8-103
8.6 Importing Data from USB	8-104
9 CONNECTING TO EXTERNAL DEVICES.....	9-106
9.1 Mini-USB connector.....	9-106
9.1.1 Connecting the <i>HD RANGER UltraLite</i> (host) to an USB memory (device) ...	9-106
9.1.2 Connecting a computer (host) to the <i>HD RANGER UltraLite</i> (device).....	9-108
9.2 RF Connector	9-109
9.2.1 DiSEqC commands	9-109
9.2.2 SCD/EN50494 (SatCR) commands	9-110
9.2.3 SCD2/EN50607 (JESS) commands	9-111
10 SPECIFICATIONS 	10-114
10.1 General Specifications	10-114
10.2 Measurement Mode.....	10-116
10.3 Spectrum Analyser Mode	10-119
10.4 TV Mode	10-121
10.5 Tools.....	10-122
11 MAINTENANCE 	11-123
11.1 Considerations about the Screen.....	11-123
11.2 Cleaning Recommendations	11-123
ANNEX 1 SIGNALS DESCRIPTION.....	1
ANNEX 2 HOW TO POINT A DISH ANTENNA	15
ANNEX 3 DiSEqC COMMANDS.....	23
ANNEX 4 REMOTE CONTROL COMMANDS.....	33
ANNEX 5 DIGITAL DIVIDEND (LTE)	56
Introduction	56
Why LTE is a problem for television installations?.....	56
Detection and correction of LTE interferences	57
Step by Step: Solving the case of a LTE interference with any HD RANGER field strength meter	57
LTE filter built-in the <i>HD RANGER+</i> and <i>HD RANGER 2</i> meters.....	61
ANNEX 6 TRANSPORT BELT INSTRUCTIONS	62
ANNEX 7 MULTIMEDIA CONTENT	63



TV & SATELLITE ANALYSER

HD RANGER UltraLite



1 INTRODUCTION

1.1 Description

The **HD RANGER UltraLite** is a super compact field strength meter and TV & Satellite analyser covering DVB-T2/C2/S2 and DVB-T/C/S standards with MPEG-2 as well as H.264 video demodulation.

Based on the widely known and distinguished **HD RANGER** platform it features new super compact form factor (25 x 18 x 4 cm) and light weight (1.4 kg). It is not missing any of the outstanding functions available in its predecessors such as 7" display, fast spectrum analyser, constellation diagram, dynamic echoes analysis, LTE ingress test and attenuation test, task planner, DiSEqC, SATCR, JESS, etc.

The new **HD RANGER UltraLite** has been created with the aim to make easy the user experience. From its ergonomic design and stylized lines to the reduction of keys and the easy use of its interface, everything has been designed so the user has a simple tool to use but powerful and useful.



Figure 1.



The **HD RANGER UltraLite** has an application to manage data generated at each installation. This feature helps the user to manage information generated so he can access it at any time or download it to a PC for further analysis.

The **HD RANGER UltraLite** has been designed and developed entirely in the European Union. A multidisciplinary team of highly qualified professionals has dedicated effort and commitment to the development of a powerful, efficient and reliable tool. During the manufacturing process, all used materials have been subjected to a strict quality control.

In an effort to facilitate its work to professionals, our long experience ensures an after sales quality service, which includes software updates and upgrades for free.



Figure 2.



[Click here to watch this video: Introducing the HD RANGER Series](#)



2 SETTING UP

2.1 Package Content

Check that your package contains the following elements:

- *HD RANGER UltraLite* Analyser.
- External DC charger.
- Mains cord for external DC charger.
- Car lighter charger.
- "F" Adapters (2 units).
 - "F" / H - DIN / H Adapter.
 - "F" / H - "F" / H Adapter.
- Support belt and carrying bag.
- USB On-the-go (OTG)(A) Male - Mini USB (B) Male cable.
- USB cable (A) Female - Mini USB (B) Male cable.
- Jack RCA cable.
- Quick Start Guide.

NOTE: Keep the original packaging, since it is specially designed to protect the equipment. You may need it in the future to send the analyser to be calibrated.



2.2 Power

The **HD RANGER UltraLite** is powered by a 7.4 V built-in rechargeable Li-Ion battery of high quality and long operation time.

This equipment can operate on battery or connected to the mains using a DC adapter. An adapter is also supplied to use with the power connector car (cigarette lighter).

2.2.1 First charge

The equipment comes with the battery half charged. Depending on the time elapsed from first charge and environmental conditions may have lost some of the charge. You should check the battery level. It is advisable a first full charge.

2.2.2 Charging the battery

Connect the DC power adapter to the equipment through the power connector on the left side panel (see figure 3).



Figure 3.

Then connect the DC power adapter to the mains via the mains cord. Ensure that your mains voltage is compatible with the adapter voltage.

For a **fast** charging of the battery is necessary to switch off the equipment.

If the equipment is ON, the battery charging will be slower, depending on the type of work you are doing. When connecting the equipment to the mains the mains connected symbol  appears inside the battery icon.



The CHARGER led indicator (red colour) shows the battery status:

- On:** Battery charging.
- Off:** Battery full charge.
- Blinking:** Battery failure or no battery.

When switching on the equipment, the battery voltage is checked. If the tension is too weak to start, the equipment does not start up. In this case please charge the battery immediately.

2.2.3 Charge/discharge times

Average charging time with the equipment off (fast charge):

- 90 minutes to achieve an 80% charge.
- 120 minutes to achieve a 100% charge.

With the equipment on (slow charge; depending on equipment consumption):

- 3 hours to achieve an 80% charge.
- 4 hours to achieve a 100% charge.

Average discharge time (with external supply disabled):

- With the battery full charge the average battery time is 3 hours.
- With the battery at 80% charge the average battery time is 2 hours.

2.2.4 Energy saving

These options are available in the **Preferences** menu, pressing the  key for 1 s.

Power Off: It allows the user to select the time to power off, which is the time after which the equipment shuts down automatically unless user press any key.

TFT Screen: User can select a time after which the TFT screen turns off, but the equipment is still running normally. The equipment can measure (for example, making a datalogger or channel exploration) and the battery will last longer, about 10% more. The screen turns on by pressing any key. Time options are: off, 1, 5, 10 or 30 minutes.



2.2.5 Usage Tips

The battery is losing storage capacity as you go through its life. Contact your **PROMAX** distributor when necessary to replace the battery.

To prolong battery life the user should follow these tips:

- In case of providing a long inactivity period of the equipment it is advisable to make every 3 months a charge / discharge cycle and a subsequent partial charge (40% aprox.).
- It is advisable to keep it in a cool place and away from heat.
- You should avoid keeping the battery for a long period of time at full load or fully discharged.
- There is not necessary to wait to fully discharge before a charge because these batteries have no memory effect.



2.3 Equipment Details

■ Front View



Figure 4.



■ **Right Side view**



Figure 5.

■ **Left Side view**



Figure 6.



2.4 Switching On/Off the equipment

There are two switching systems, according to the model version: the slide switch and the button. Both systems are explained below:

► Switching On:

- 1 Press the button / Slide for a while (approximately one second) the power slide switch located on the side of the equipment.
- 2 When all indicators light up at once release the button or the switch, which returns to its rest position.
- 3 The boot screen (user can select the boot screen from "Preferences" menu) appears and also a progress bar that indicates the system load. At the top left corner it shows the equipment model and the installed software release detected.
- 4 After the system load, the last screen before shutdown appears.

► Switching Off:

- 1 Press the button / Slide for a while the power slide switch located on the side of the equipment.
There are two options:
 - **Short press / slide (<1 s):** A menu on screen allows the user to select between power off or reboot.
 - **Long press / slide (>2 s):** The equipment turns off directly.
- 2 When the screen goes off release the switch, which returns to its rest position.
- 3 The starting display picture appears and the progress bar showing the system shutdown progress.
- 4 The equipment keeps its last status (mode and screen) which is recovered when power on.

► Reset:

- 1 Press the  key for 5 seconds. The equipment automatically turns off. Use only in case of system crash.

In the **PREFERENCES** menu  (press 1s), APPEARANCE tab, option "**Power Off**" the user can activate the automatic shutdown option, selecting a waiting time (time without pressing any key) after which the equipment turns off automatically.



2.5 Screen Icons and Dialog boxes

On the screen are some icons that provide useful information to the user about the current status of the instrument.

	Battery charging.		Warning.
	Battery not charging. Yellow level indicates charge left.		USB flash drive inserted.
	USB in serial port mode.		Current installation.
	Satellite band.		SATCR (SCD/EN50494) commands enabled.
	Current voltage, 22 kHz signal and LNB power level		JESS (SCD2/EN50607) commands enabled.
	Terrestrial band.		Task scheduled.
	Compressed installation.		Control keys enabled. Two-letter code indicates the exact function:
	OK.		FR Frequency tuning.
			CH Channel tuning.
			SP Span change.
			MK Marker moving.
	Searching.		EC Echo/zoom change.



2.6 Menu Tree



SPECTRUM ANALYSER MENU

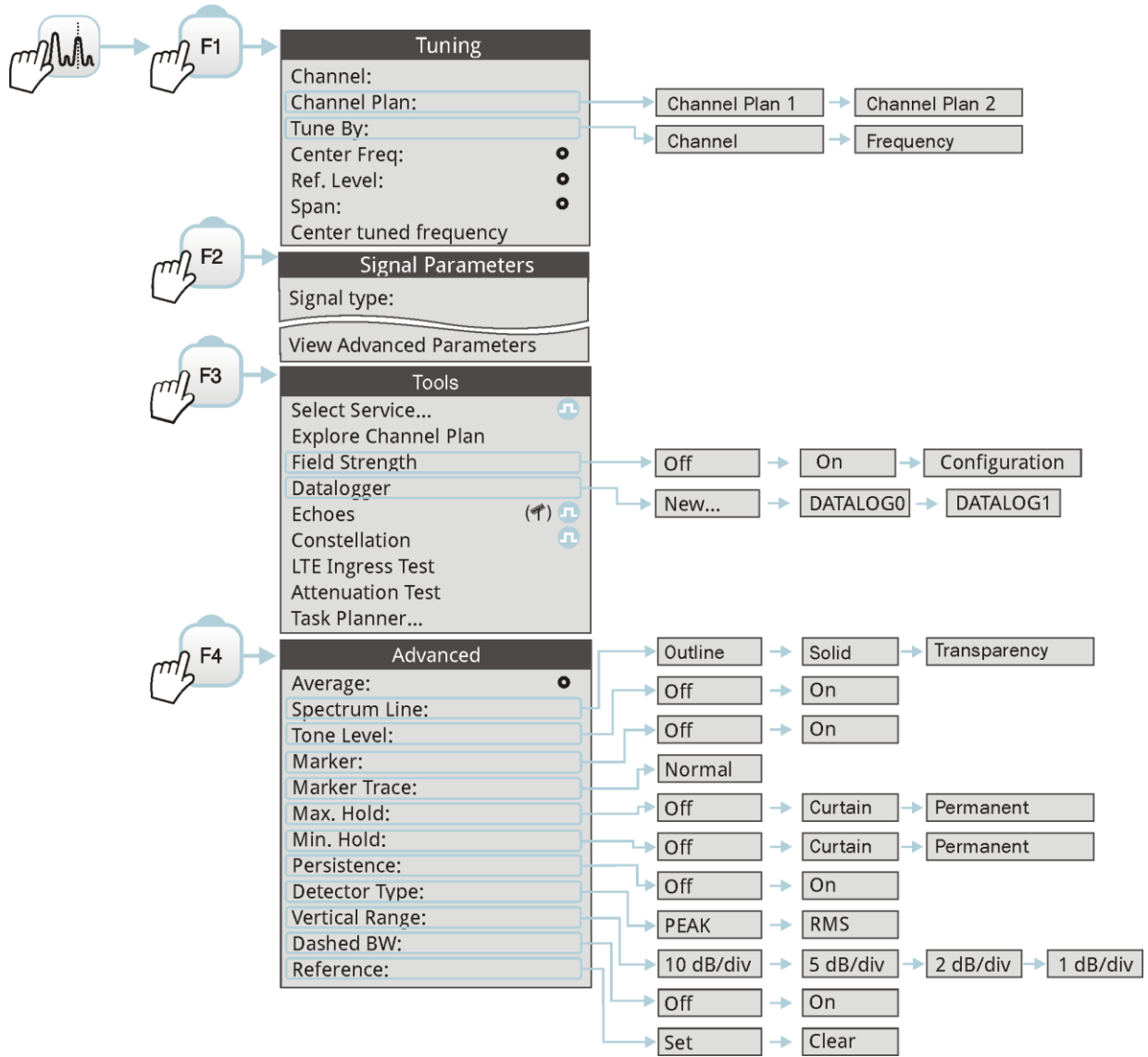

Only available for **digital channels**

Option available for **terrestrial band**

Option available for **satellite band**



TV MENU

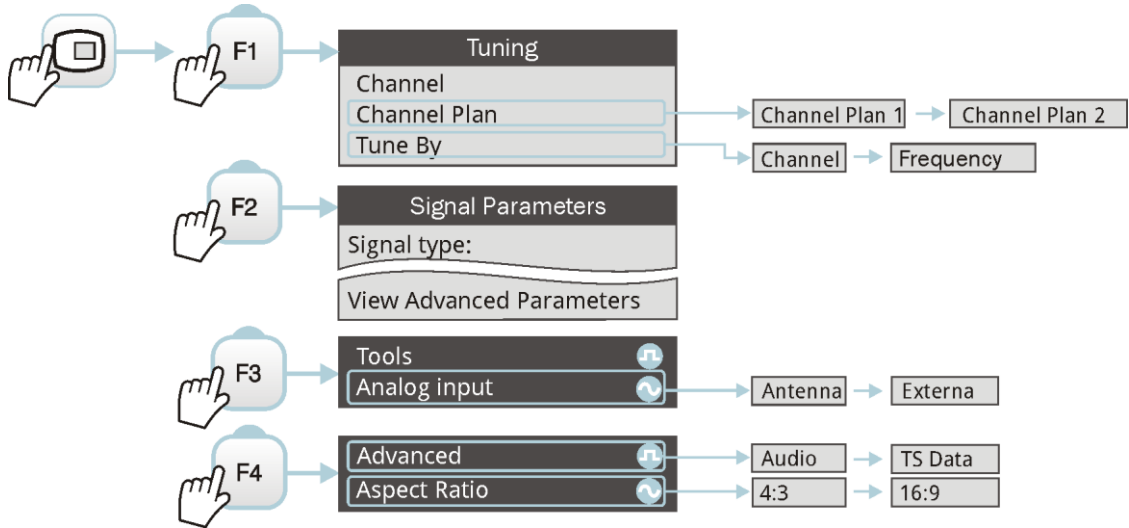

MEASUREMENT MENU

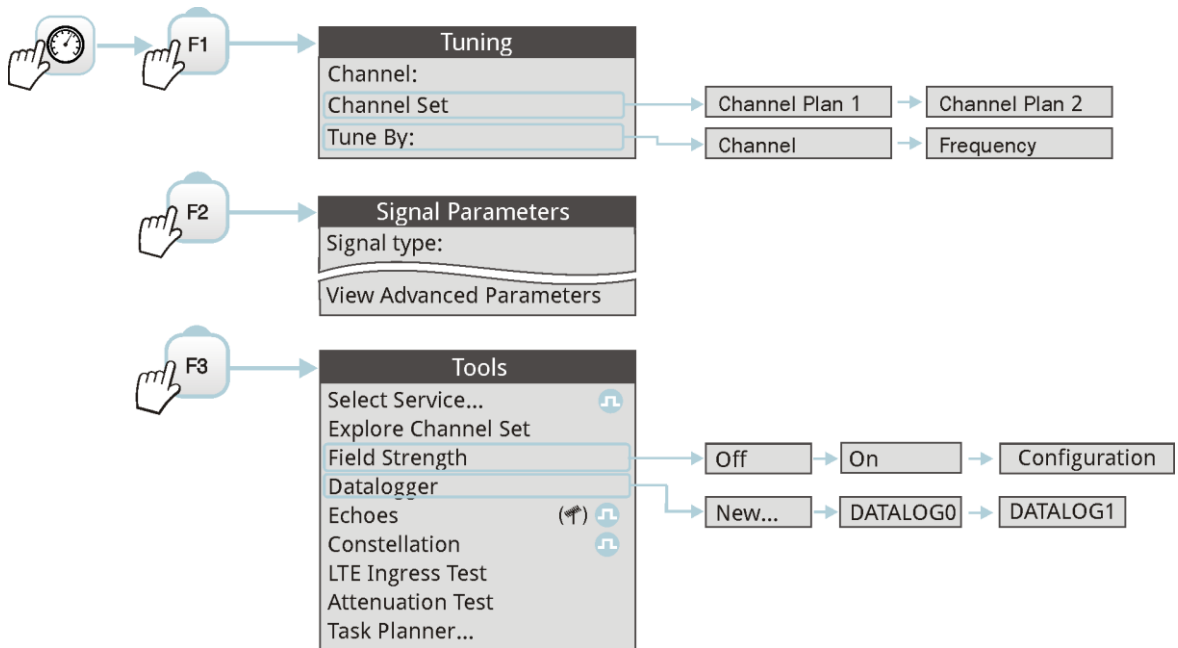

Only available for **digital channels**



Option available for **terrestrial band**



Only available for **analogue channels**



Option available for **satellite band**



SETTINGS MENU

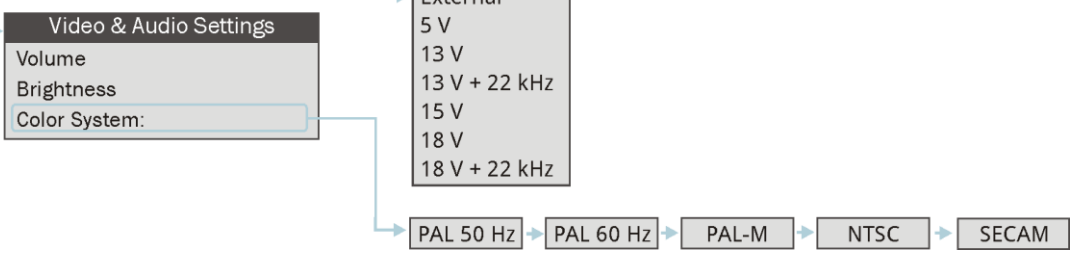
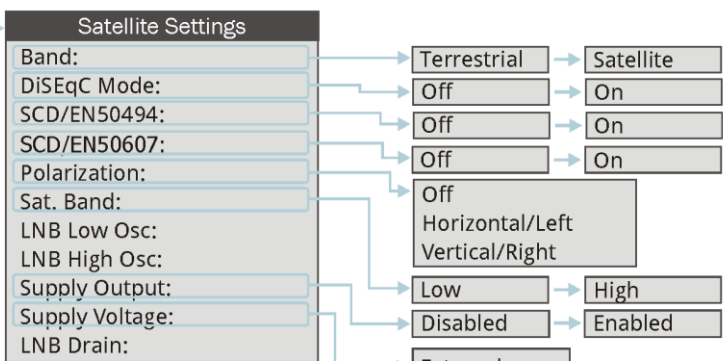
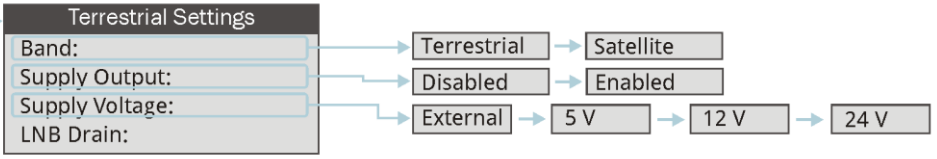

Option available for **terrestrial band**



Option available for **satellite band**



INSTALLATIONS MANAGEMENT

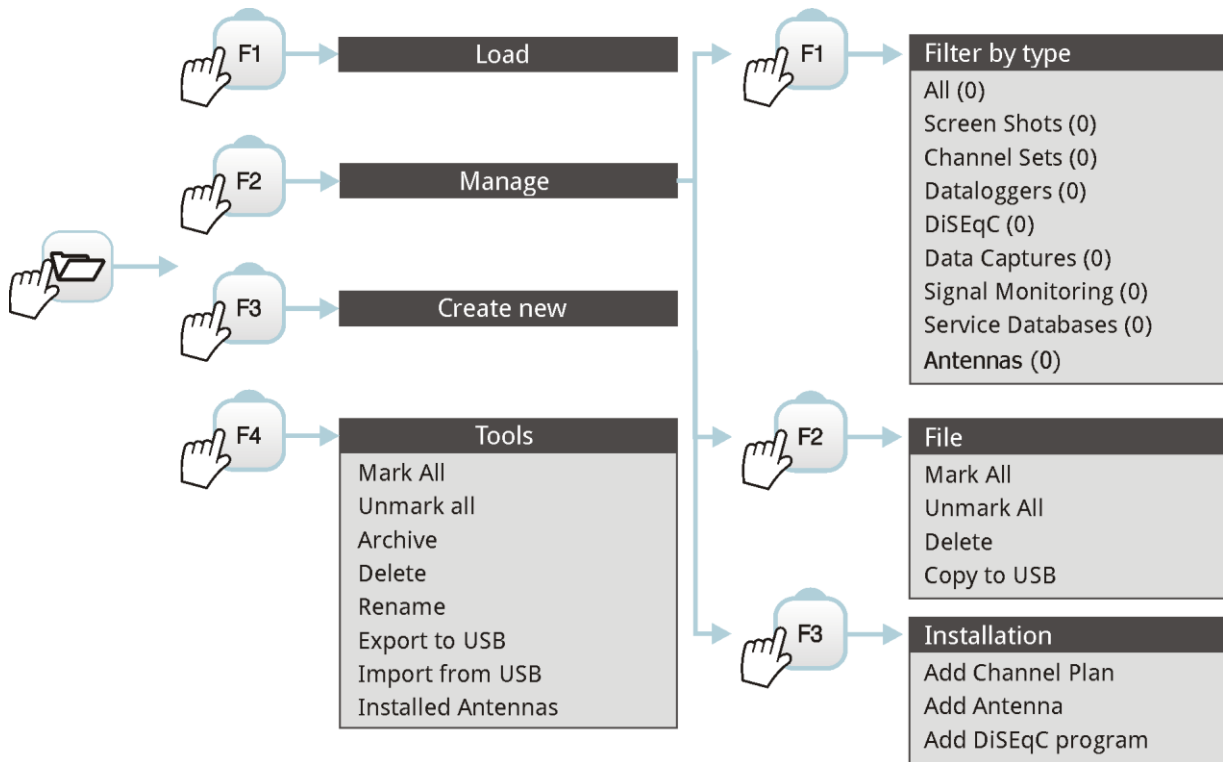

PREFERENCES MENU

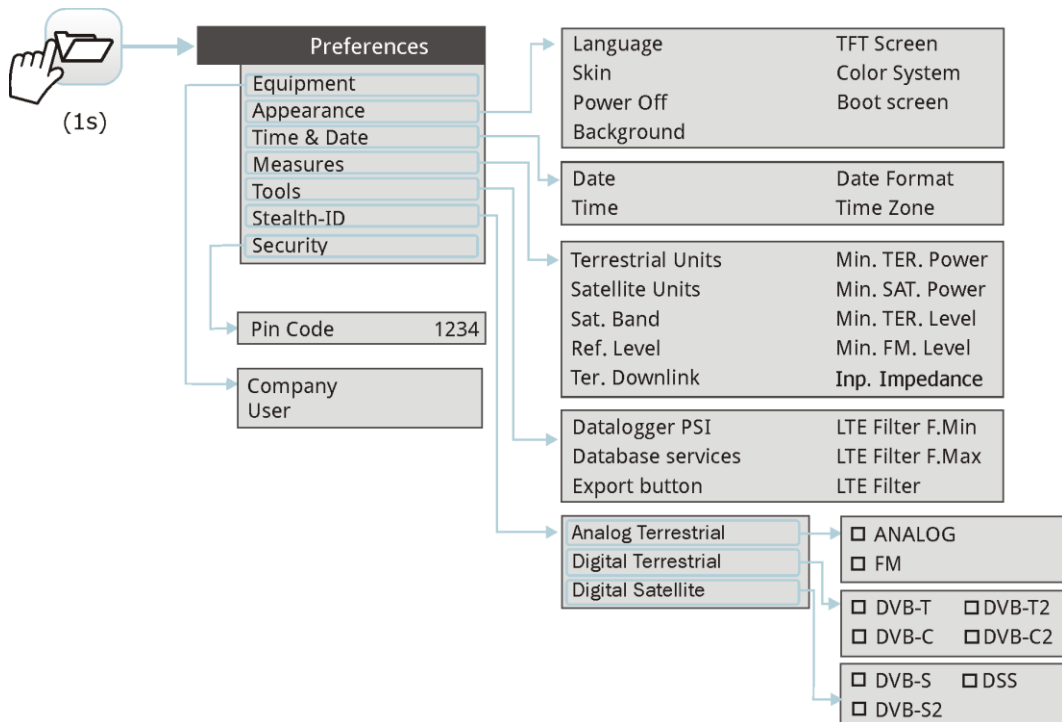

Figure 7.



2.7 Controls

The equipment has been designed to be an easy tool to use. For this reason the number of keys has been reduced and these are grouped by function.

The menu navigation includes hints that appear when the cursor is placed on an disabled (grayed) option for a while. This hints help the user to understand why an option is disabled and what to do to enable it.

For measurement and navigation through the menus, the equipment has a joystick, 4 programmable keys (softkeys) and 6 direct access keys (shortcut keys).

Next the use of each one of them is described:

2.7.1 Control keys

Control keys are five:

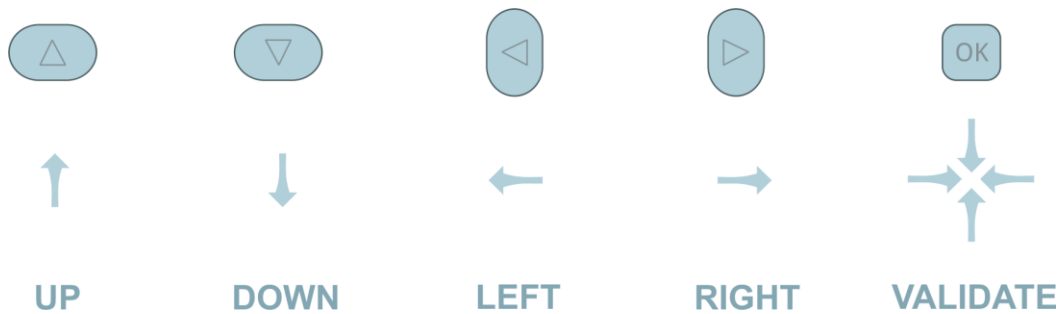

Figure 8.

Control keys are multifunctional, that is, each time you, validate its function changes. The user can see the active function according to the icon that is displayed at the upper right corner of the equipment, as shown in the image.

In the **SPECTRUM ANALYSER** mode, control keys have the following functions:



- ▶ **CH** or **FR**: Channel change (CH) or frequency (FR) change (according to the tune selected: tune by channel or tune by frequency).
- ▶ **SP**: Span change.
- ▶ **MK**: Marker moving (if marker is enabled).

Figure 9.



Using the **ECHOES** tool, control keys are also multifunctional:

- ▶ **CH** or **FR**: Channel (CH) change or frequency (FR) change (according to the tune selected: tune by channel or tune by frequency).
- ▶ **EC**: Echo change.

According to the selected function, control keys will do a specific action.



[Click here to watch this video: Navigating through the menus](#)

2.7.2 Keyboard shortcuts

▶ Management Keys

There are two Management keys. Each one has two different functions according to the pressing time:



Short press: It shows the list of installations and the menus to manage them.

Long press: It shows the preferences menu.



Short press: It shows the menu of terrestrial or satellite settings (according to the selected band).

Long press: It shows the Video & audio settings.



▶ Export / Reference key

Depending on how long you press this key, it has two different functions:

Short Press: Pressing this key for less than one second on the **Spectrum Analyser** mode, it holds on screen the current waveform as a reference. It is equivalent to go to the option "Reference - Set" from the "Advanced" menu. Pressing short again, it deletes the waveform reference. It is equivalent to go to the option "Reference - Clear" in the "Advanced" menu.

Long press: Pressing this key for one second it makes a capture of what it is shown on screen at the time.

The capture may be from the screen image, from the measurement data or from both.

The type of capture, either screen, data, or both can be set in the "**Export button**" option which is on the label "**Measures**" in the "**Preferences**" menu.

More information in the chapter "**Export key**".



► Function keys

On the left side there are 3 keys to access the most important functions of the equipment.



Measurement key.



Spectrum Analyser key.



TV Mode Key.

Pressing a key repeatedly provides access to a different view within the same function. For analogue signals only the first view of each function is available. Each view is shown at the top. When reaching the third view it returns to the first view.

Following there is an example of the views available for each function (examples extracted from a digital terrestrial signal):



Measurements



1/3

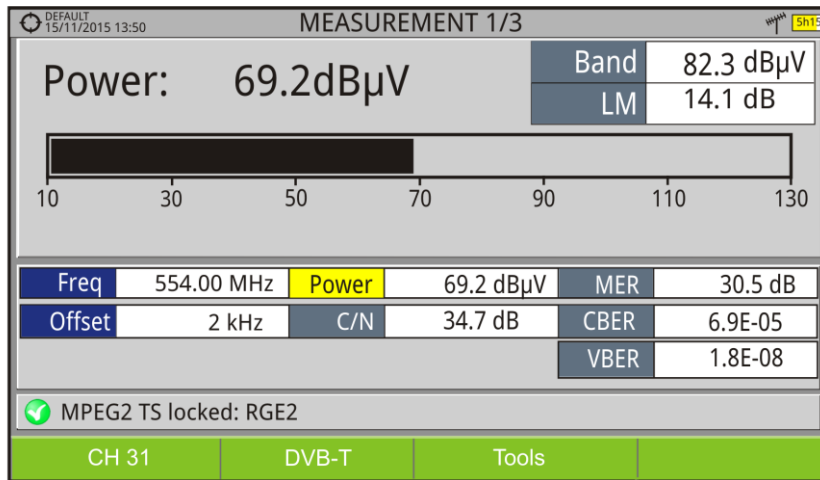

Figure 10. FULL MEASUREMENT



2/3

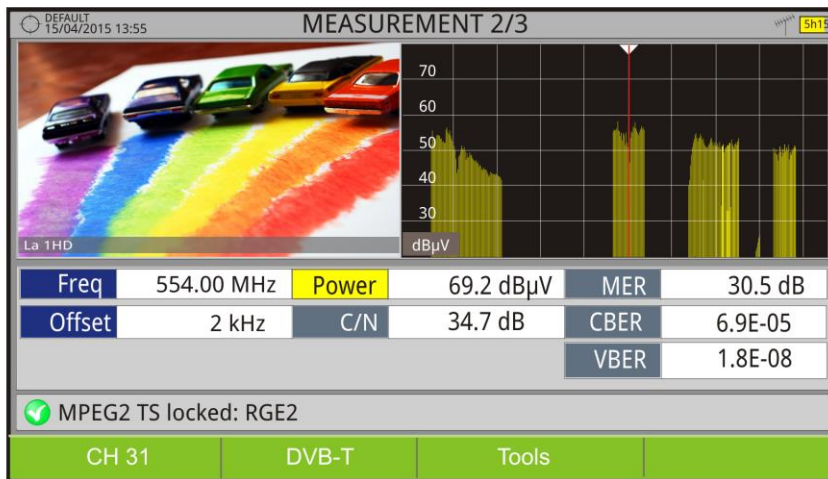

Figure 11. MEASUREMENT + TV + SPECTRUM



3/3

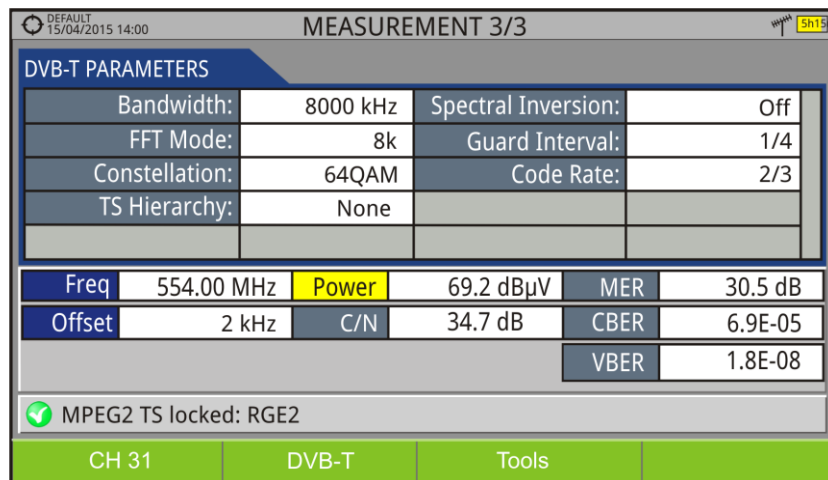

Figure 12. MEASUREMENT + PARAMETERS



Spectrum Analyser



1/3

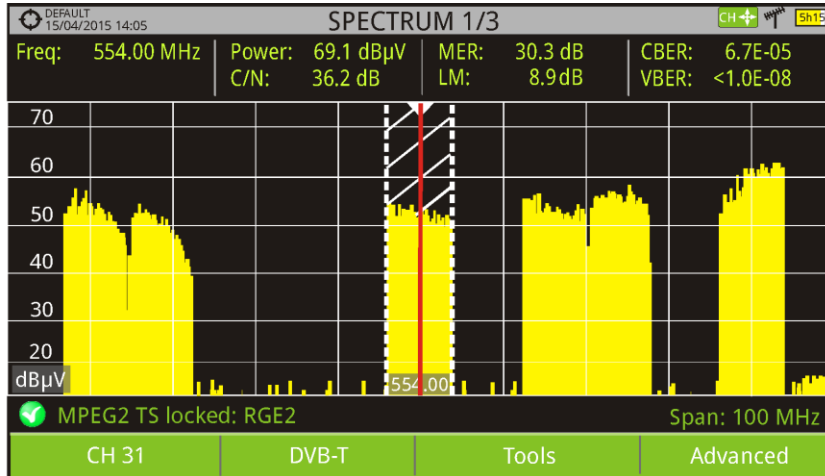

Figure 13. SPECTRUM + MEASUREMENT



2/3

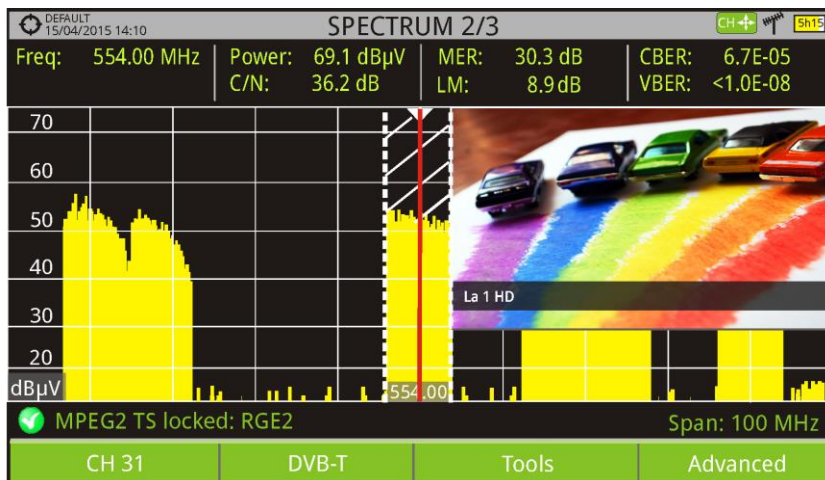

Figure 14. SPECTRUM + MEASUREMENT + TV



3/3

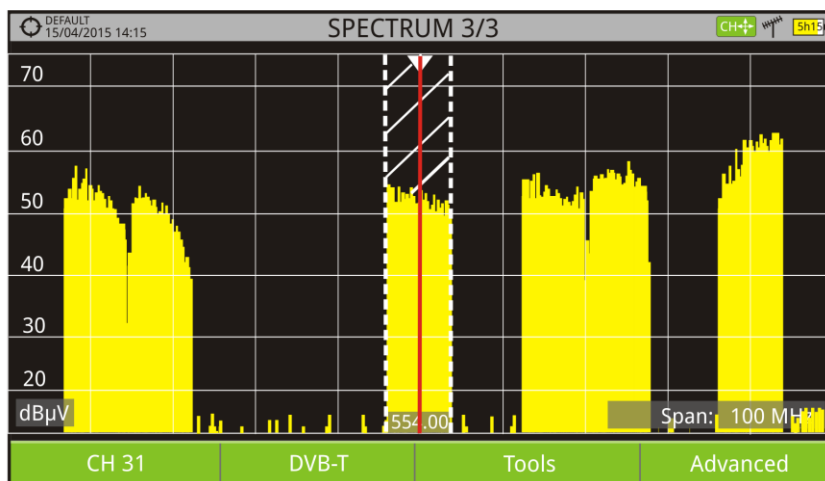

Figure 15. FULL SPECTRUM



TV Mode



1/3

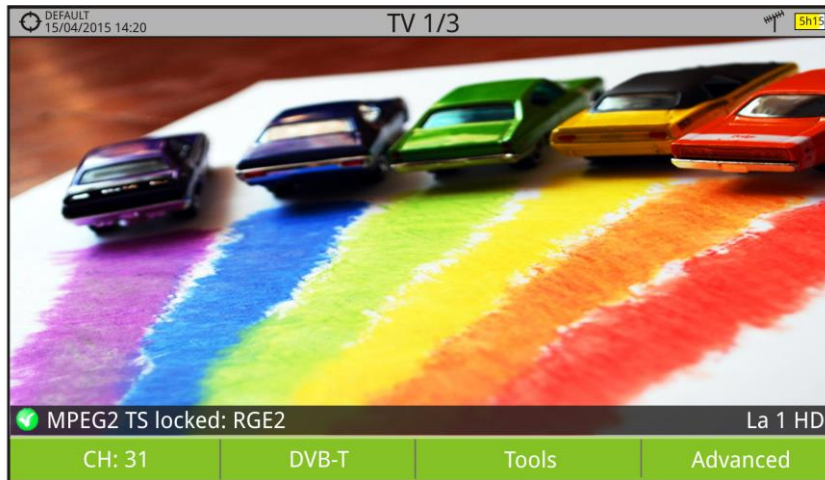

Figure 16. FULL TV



2/3

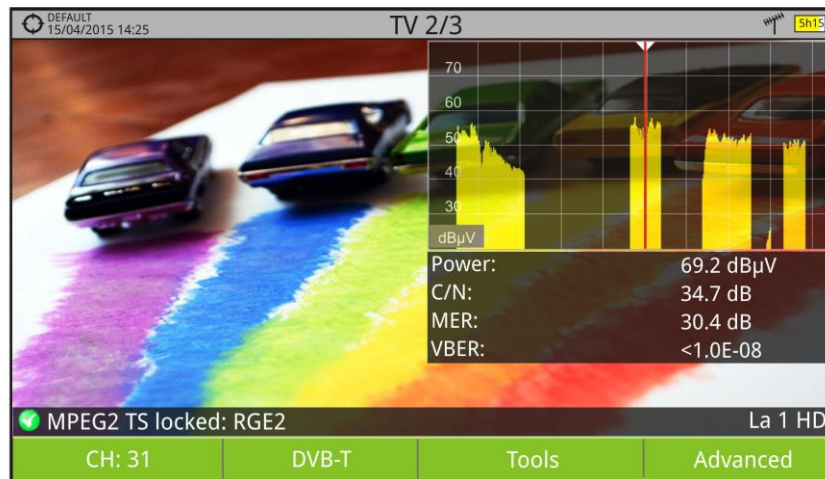

Figure 17. TV + SPECTRUM + MEASUREMENT



3/3

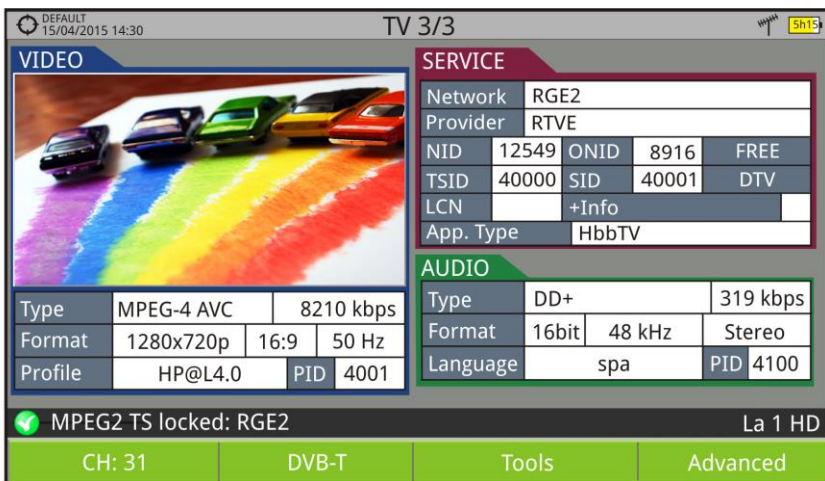

Figure 18. TV + SERVICE DATA



2.7.3 Softkeys

There are four programmable keys, also called softkeys, numbered from **F1** to **F4**.

Each key provides access to a menu. This menu varies depending on the function the user is working on the meter.

The menu is displayed on each softkey at the bottom of the screen.



Figure 19.

2.7.4 Virtual Keyboard

When a user needs to enter or edit a text (from an image, Channel Plan, etc.), a screen with a virtual keyboard appears as shown at the figure.









Figure 20.





To edit the file name user should follow these steps:

- 1 Using the control keys, place the cursor over the text box where the name appears.
- 2 Move the cursor to place it next to the letter that user wants to edit.
- 3 Use control keys on the virtual keyboard to edit.

To delete a letter, move the control keys to the right side of the letter and then press the **OK** on the Delete key  or press  (Del).

To enter an upper case letter press first  or press the control key on the  key. To block upper case press  or press the control key on the  key twice consecutively. To return to lower case press  or the key again.

Keys with a point at the top right corner give access to special characters, by keeping pressed the **OK** key for one second on the character key.

After editing press  (Ok) to validate the name and continue the process or  (Cancel) to cancel.

2.8 **StealthID Function**

► **Description**

The **StealthID** function of the **HD RANGER UltraLite** is a signal identification function performed automatically by the equipment without any user intervention.







The equipment tries to identify the channel or frequency of the input signal it receives, and according to the band selected by the user, it applies identifying criteria according to the standards of that band. When the equipment recognizes in the input signal the identification parameters of a standard, it decodes the signal and shows the data of that signal on the screen.

The identification system tries to lock the first signal using the modulation defined in the channel plan for that signal. If after five seconds it fails to lock with that modulation, it starts the wheel for automatic detection. If then it locks in a modulation other than indicated, it generates an internal temporary channel plan to accelerate tuning the same channel later on.



By this way, the user has to follow these steps to lock a signal:

► Operation

- 1 Press the **Preferences** key  for 1 second.
- 2 In the **StealthID** tab, select the signal types to auto-identify (see "Menu tree" [figure 7](#)). By default all them are selected. Press the  key to save the changes made and the  key to exit the **Preferences** screen.
- 3 Press the **Settings**  key.
- 4 Select the band (terrestrial or satellite).
- 5 Select a channel or frequency to identify.
- 6 The bottom of the screen shows the message "**Searching for signal**" and the standard transmission checking. Wait a few seconds for the equipment to identify the signal. User can force the auto-identification of a signal by pressing the  key and selecting the type of signal from the menu.
- 7 When the equipment identifies the signal a text shows the detected signal type.
- 8 Press  (Signal Parameters) to see the signal parameters.

► Signals automatically detected by the StealthID function

- Digital Terrestrial Television First Generation (DVB-T)
- Digital Terrestrial Television Second Generation (DVB-T2: T2-Base and T2-Lite profiles)
- Digital Satellite Television First Generation (DVB-S)
- Digital Satellite Television Second Generation (DVB-S2)
- Digital Satellite Television, exclusive for DirecTV (DSS)
- Digital Cable Television First Generation (DVB-C)*
- Digital Cable Television Second Generation (DVB-C2)
- Analogue terrestrial TV
- Analogue Cable TV

* User has to enter the symbol rate in order the equipment detects the DVB-C signal.



2.9 Settings and Configuration

2.9.1 Settings Menu

Press the **Settings** key  to access the settings menu.

Depending on the selected band, the menu may be different.

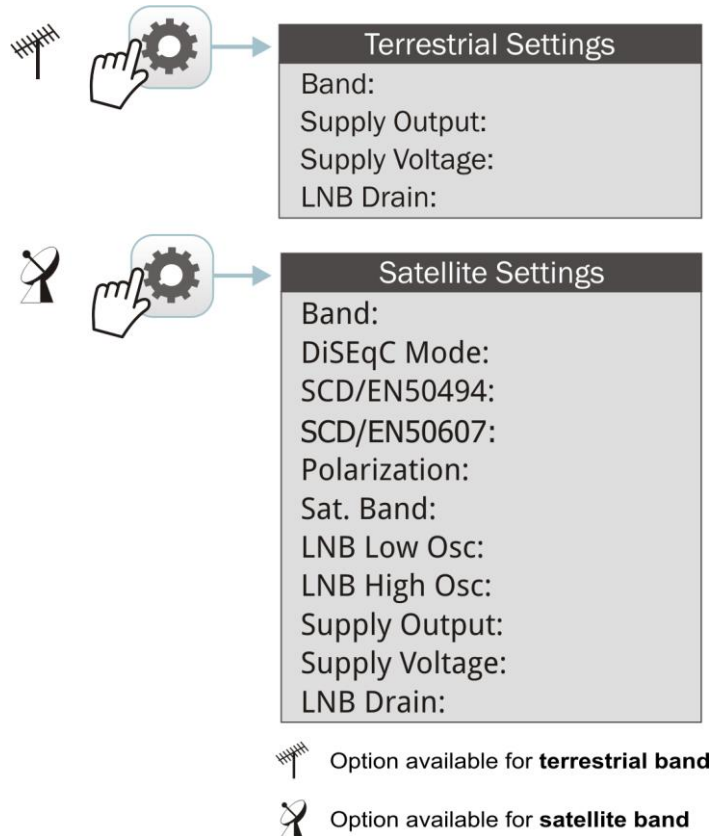

Figure 21.

A brief explanation of each option available on the menu:

► **Band** (available for satellite and terrestrial band)

It allows the user to select between terrestrial or satellite frequency band.



[Click here to watch this video: Switching satellite / terrestrial bands](#)



► **External power supply** (available for terrestrial and satellite band)

It enables or disables the power supplied to external units such as preamplifiers for antennas in terrestrial television or LNBs and FI simulators in the case of satellite TV.

When this option is enabled the equipment applies at the output the voltage selected by the user in the Supply Voltage option (see below). When this option is disabled the equipment does not apply the voltage to the output but it will behave as if it did.

► **Supply voltages** (available for terrestrial and satellite band)

It selects the voltage to be applied to an external unit.

Available voltage options change depending on the selected band.

Voltage available for terrestrial band is: External, 5 V, 12 V and 24 V.

Voltage available for satellite band is: External, 5 V (for devices working with 5 V such as GPS active antennas), 13 V, 13 V + 22 kHz, 15V, 18 V, 18 V + 22 kHz.

In the **External** supply voltage option the power supplier to the external units is the power supplier of the antenna preamplifiers (terrestrial television) or the satellite TV receiver (collective or domestic).

► **LNB Drain** (available for terrestrial and satellite band)

The LNB drain option shows the voltage and current flowing to the external unit. If there is any problems (e.g. short circuit), an error message appears on the screen ('SHORTCIRCUIT'), a warning beep sounds and the equipment will not supply power. The equipment does not return to its normal operating state until the problem is solved. During this time the equipment checks every three seconds if there still the problem, warning with an audible signal.

The DRAIN LNB light indicator is lit if current is flowing to the external unit.

► **DiSEqC Mode** (only available for satellite band)

It enables or disables DiSEqC mode. DiSEqC (Digital Satellite Equipment Control) is a communication protocol between the satellite receiver and accessories of the satellite system (see chapter "CONNECTING TO EXTERNAL DEVICES").



▶ **SCD/EN50494** (only available for satellite band)

It enables or disables the SCD/EN50494 function to control devices of a satellite TV installation that supports this technology (see chapter "CONNECTING TO EXTERNAL DEVICES").

▶ **SCD2/EN50607** (only available for satellite band)

It enables or disables SCD2/EN50607 mode to control devices in a satellite TV installation which must be compatible with this technology (see chapter "CONNECTING TO EXTERNAL DEVICES").

▶ **Polarization** (only available for satellite band)

It allows the user to select the signal polarization between Vertical/Right (vertical and circular clockwise) and Horizontal/Left (horizontal and circular anti-clockwise), or disable it (OFF). In tuning mode the Polarization option can not be changed.

▶ **Sat Band** (only available for satellite band)

It allows the user to select the High or Low band frequency for satellite channel tuning. In channel tuning mode the Band Sat can not be changed.

▶ **LNB Low Osc.** (only available for satellite band)

It defines the local oscillator frequency for the LNB low band. When a channel plan is selected but LNB oscillator values are not properly selected, a warning is issued.

▶ **LNB High Osc.** (only available for satellite band)

It defines the local oscillator frequency for the LNB high band (up to 25 GHz). When a channel plan is selected but LNB oscillator values are not properly selected, a warning is issued.



2.9.2 Video & Audio settings

Press the Settings key  for one second to access the Video & Audio settings menu.

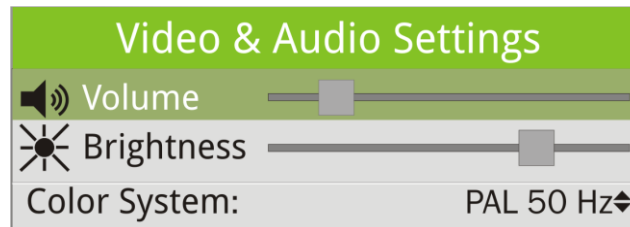

Figure 22.

A brief explanation of each option available on the menu:

► Volume

It increases or decreases the volume of the speaker audio output by moving control keys to the right (+ volume) or left (- volume).

► Brightness

It increases or decreases the screen brightness by moving control keys to the right (+ brightness) or left (- brightness).

► Colour System

The coding system used in analogue transmissions. Available options are: PAL 50 Hz, PAL 60 Hz, PAL-M, NTSC and SECAM.

2.9.3 Preferences Menu

You access the **Preferences** menu by pressing the **Installations Management** key  for one second. The options are grouped in tabs as follows:

- **Equipment:** Equipment information (only read).
- **Appearance:** Equipment customization options.
- **Date & Time:** It allows the user to change date and time zone.
- **Measures:** It allows the user to choose between several units of measure among other parameters.
- **Tools:** It allows to edit some parameters for different tools.



- ▶ **StealthID:** It allows the user to select the set of signal types being used while auto identifying any modulation type.
- ▶ **Security:** It allows to edit the PIN code.

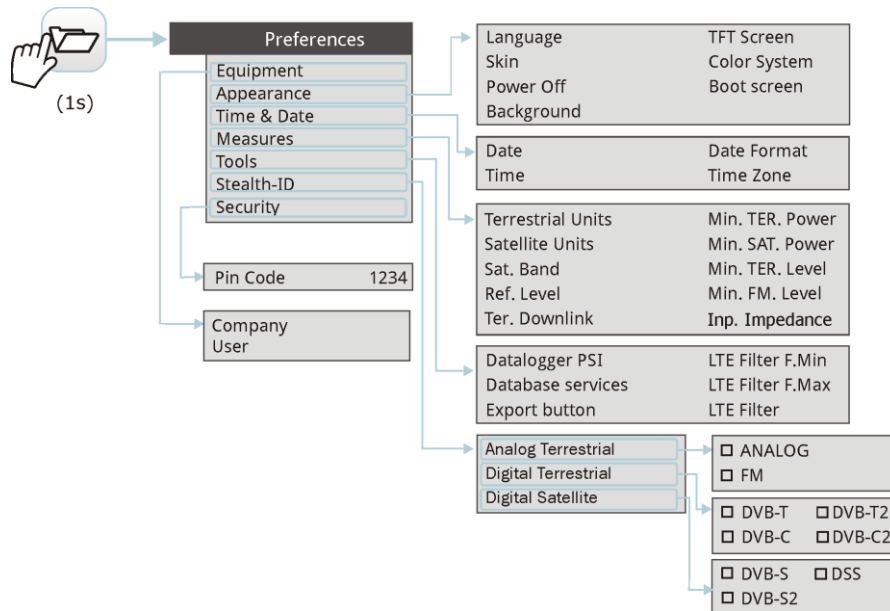

Figure 23.

To navigate between tabs move the control keys left or right. To navigate between the options within the tab move the control keys up or down.

Press **F1** **Exit** to exit Preferences.

Press **F2** **Save** to save changes.

A brief explanation of the options available in each tab:

▶ **Equipment information:**

- **Provider:** Provider's name.
- **Name:** Equipment's name.
- **Serial number:** Unique identification number for this equipment.
- **Release:** Version of the software installed on the equipment.
- **Date:** Date of the software and hardware installed on the equipment.
- **Free memory:** Free size of the flash memory installed on the equipment / Size of the flash memory installed on the equipment.



- **Company:** Name of the company which owns the equipment (editable by user; protected by PIN code). This field appears on the boot screen.
- **User:** Name of the equipment's user (editable by user; protected by PIN code). This field appears on the boot screen.

► **Appearance Options:**

- **Language:** Language used on menus, messages and screens. Available languages are: Spanish, Catalan, English, German, French, Czech, Italian, Norwegian, Polish, Russian and Slovak. Once the new language is selected, the equipment shows a warning message and re-starts in order to load the new language.
- **Skin:** Colours used on the screen.
- **Power Off:** It allows the user to select the time to power off, which is the time after which the equipment shuts down automatically unless user press any key.
- **Background:** It allows the user to select the background colour on the display screen. Options available are: white, green, red, black and blue.
- **TFT Screen:** User can select a time after which the TFT screen turns off, but the equipment is still running normally. The equipment can measure (for example, making a datalogger or channel exploration) and the battery will last longer, about 10% more. The screen turns on by pressing any key. Time options are: off, 1, 5, 10 or 30 minutes.
- **Color System:** The coding system used in analogue transmissions. Available options are: PAL 50 Hz, PAL 60 Hz, PAL-M, NTSC and SECAM.
- **Boot Screen:** User can select the image that appears when the equipment is booting.
- **Values Format:** It allows the user to select the format to show on fields PID, NID, ONID, TSID and SID in TV mode screen 3/3. Available formats are decimal or hexadecimal.

► **Time & Date Options:**

- **Date:** It allows the user to edit the date. Press the **OK** key for edit mode.
- **Time:** It allows the user to edit the time. Press the **OK** key for edit mode.



- **Date Format:** It allows the user to change the date format, which is the order in which is shown day (DD), month (MM) and year (YYYY or YY).
- **Time Zone:** It allows the user to select the time zone where he is.

► **Measures Options:**

- **Terrestrial Units:** It allows the user to select the terrestrial measurement units for the signal level. Available options are: dBm dBmV and dB μ V.
- **Satellite Units:** It allows the user to select the satellite measurement units for the signal level. Available options are: dBm, dBmV and dB μ V.
- **Satellite Band:** It allows the user to select the type of satellite band used between Ku/Ka band and C band.
- **Reference Level:** It allows the user to select the type of reference level adjustment between manual (modified by the user) or automatic (selected by the equipment).
- **Ter. Downlink:** If this option is enabled it allows to work in terrestrial band with radio link down converters external units (from 1 to 11 GHz) and tune using the link frequency.
- **Min. TER. Power:** It sets the minimum power for a terrestrial digital signal to be identified.
- **Min. SAT. Power:** It sets the minimum power for a satellite digital signal to be identified.
- **Min. TER. Level:** It sets the minimum level for a terrestrial analogue signal to be identified.
- **Min. FM. Level:** It sets the minimum power for a FM signal to be identified.
- **Inp. Impedance:** It allows the user to select the impedance at the RF input between 50 Ω and 75 Ω .



► **Tools Options:**

- **Datalogger PSI:** If you select the option "**Capture**", when datalogger is working it captures the service list of each channel. This process slows the datalogger, but provides additional information that can be downloaded in XML files. To disable this option select "**Don't capture**".

- **Database services:** When it is enabled, it saves all the services been detected in the current installation. There is a database for services in terrestrial band and another for services in satellital band. Services are included automatically when the signal is locked. If enabled, these services will be displayed on the "**View all services**" option in the **Tuning**  menu. When disabling the option all services in the database of the installation will be deleted.

- **Export button:** It allows the user to select the data to be exported when pressing the export key among the following options: screen only, data only or both. More info in the "Export key" chapter.

- **LTE Filter F. Min:** Select the minimum frequency for the external LTE filter.

- **LTE Filter F. Max:** Select the maximum frequency for the external LTE filter.

- **Center Freq:** User can set the center of frequency to **Manual** or **Auto** mode. In Manual mode the user sets the center of frequency and the equipment does not change it never, so the main cursor can be moved out of screen. In Auto mode the equipment changes the center of frequency to display always the main cursor on screen.

► **StealthID Options:**

It allows the user to select the set of signal types being used while auto identifying any modulation type. More information in the "StealthID function" chapter.

► **Security Options:**

It allows the user to change the PIN code that gives access to protected data fields. The default PIN code is "1234". To change the PIN, first enter the current PIN code, then enter the new PIN.

In case the user forgets the PIN, after the third attempt, a 12-digit code will appear on screen. Sending this 12 digit code to the PROMAX customer service, the user will recover the PIN.



3 MEASUREMENT MODE



3.1 Introduction

On the panel left side, the equipment has three functions keys, which give direct access to the three most important functions. One of them is the key **MEASUREMENT**  that measures the signal received through the RF input connector.

The user should connect a signal to the input and select the band, whether terrestrial or satellite. Then the auto-identification function (for more information refer to "StealthID function") locks the signal and demodulates it in real time, automatically detecting its characteristic parameters.

Having identified the signal, the equipment measures according to the signal type. All information about transponders or multiplex is automatically displayed without introducing any additional parameter identification.

Next there is a list of signals that the equipment can automatically detect. For more information about characteristics of each signal type refer to Annex 1: Signals description.



- Digital Terrestrial Television First Generation (DVB-T)
- Digital Terrestrial Television Second Generation (DVB-T2: T2-Base and T2-Lite profiles)
- Digital Satellite Television First Generation (DVB-S)
- Digital Satellite Television Second Generation (DVB-S2)
- Digital Satellite Television, exclusive for DirecTV (DSS)
- Digital Cable Television First Generation (DVB-C)*
- Digital Cable Television Second Generation (DVB-C2)
- Analogue terrestrial TV
- Analogue Cable TV

"Signals description" annex describes in detail the measurement parameters for each type of signal.

* User has to enter the symbol rate in order the equipment detects the DVB-C signal.



3.2 Operation

- 1 Connect the **RF** input signal to the equipment.
- 2 Select through the "Settings" menu  the frequency band (terrestrial or satellite).
- 3 Access the **MEASUREMENT** option by pressing the  key.
- 4 Press again  to display the next view.

3.3 Screen Description

Views for digital signals are:



MEASUREMENT 1/3: FULL MEASUREMENT

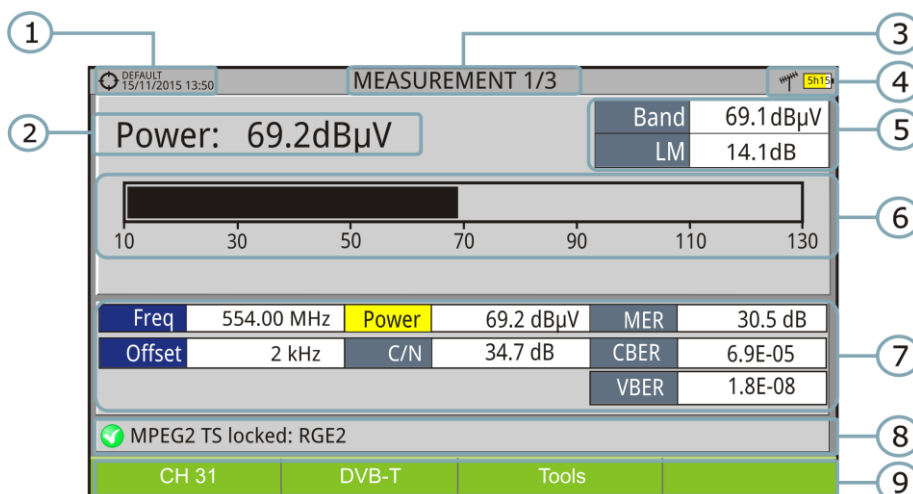

Figure 24.

- 1 Selected installation, date and time.
- 2 Measurement value of the selected parameter.
- 3 Number of view/total views.
- 4 Selected band, battery level.
- 5 Total power detected over the whole selected band (terrestrial or satellite). It also shows the link margin measurement. The total power can be used to know when it is close to saturation. The link margin is the margin of safety remaining for a good reception.
- 6 Graphical measurement of the selected parameter.
- 7 Measurement values for the type of locked signal.



- 8 Signal status (searching/locked/multiplex name).
- 9 Softkeys menus.
- ▶ **Keys up/down:** It changes selected parameter.
- ▶ **Keys left/right:** It changes channel/frequency.



MEASUREMENT 2/3: MEASUREMENT + TV + SPECTRUM

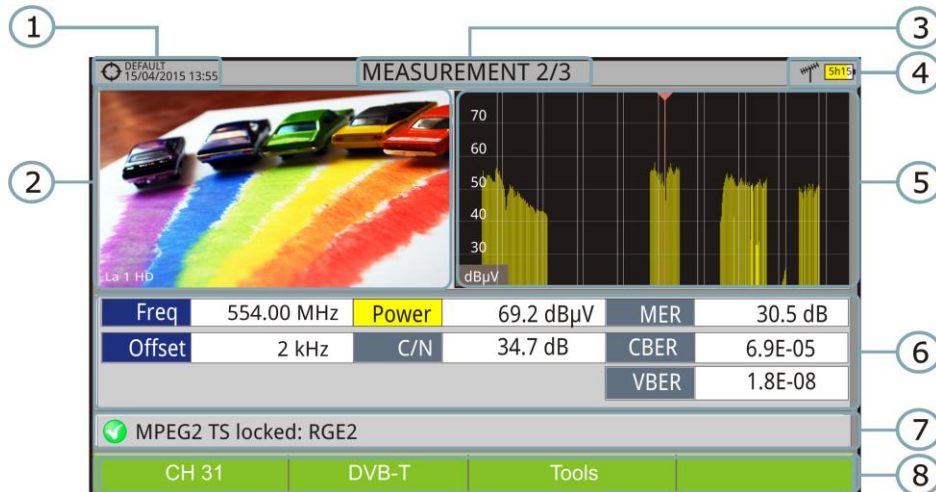

Figure 25.

- 1 Selected installation, date and time.
- 2 Image of the locked signal.
- 3 Number of view/total views.
- 4 Selected band, battery level.
- 5 Spectrum of the locked signal.
- 6 Measurement values for the type of locked signal.
- 7 Signal status (searching/locked/multiplex name).
- 8 Softkeys menus.

- ▶ **Keys right/left:** It changes the selected channel/frequency.



MEASUREMENT 3/3: MEASUREMENT + PARAMETERS

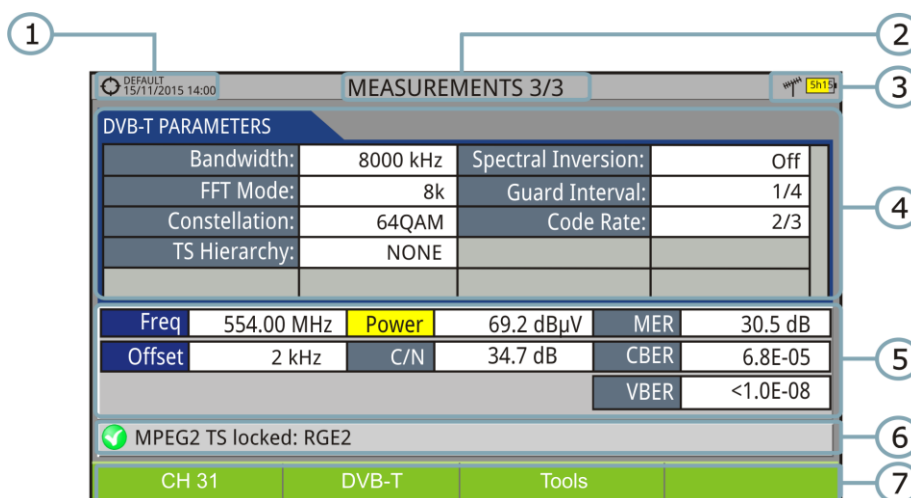

Figure 26.

- 1 Selected installation, date and time.
- 2 Number of view/total views.
- 3 Selected band, battery level.
- 4 Demodulation parameters of the locked signal.
- 5 Measurement values for the type of locked signal.
- 6 Signal status (searching/locked/multiplex name).
- 7 Softkeys menus.

► **Keys right/left:** It changes the selected channel/frequency.

3.4 GENERIC Signal

This is a special digital signal that the equipment does not demodulate. It can be used for special signals as DAB/DAB + or COFDM modulation with narrow BW.

In this type of signal the user can select the signal bandwidth by accessing the "Signal Parameters" menu on the **F2** key.

The power measure and C/N ratio is calculated according to the bandwidth selected by the user.

The triple cursor shows on screen the BW selected by the user.



4 SPECTRUM ANALYSER MODE



4.1 Introduction

On the left side, the equipment has three function keys, which give direct access to the three most important functions. One of them is the **SPECTRUM ANALYSER** key  that displays the signal spectrum received through the RF input connector.

The Spectrum Analyser mode allows checking the signals on the frequency band, to visually identify any anomalies and to measure the signal and display the image tuned.

Thanks to the auto-identification or StealthID function, the system is constantly identifying the signal it receives (for more information refer to "StealthID" function). When it detects the signal type, it locks it and displays the information.

4.2 Mode of operation

- 1 Connect the **RF** input signal to the equipment.
- 2 Select through the **Settings** menu  the frequency band (terrestrial or satellite).
- 3 Access the **SPECTRUM ANALYSER** option by pressing the  key.
- 4 Press again  to display the next view.



4.3 Screen Description

Available views are:



SPECTRUM 1/3: SPECTRUM + MEASUREMENT

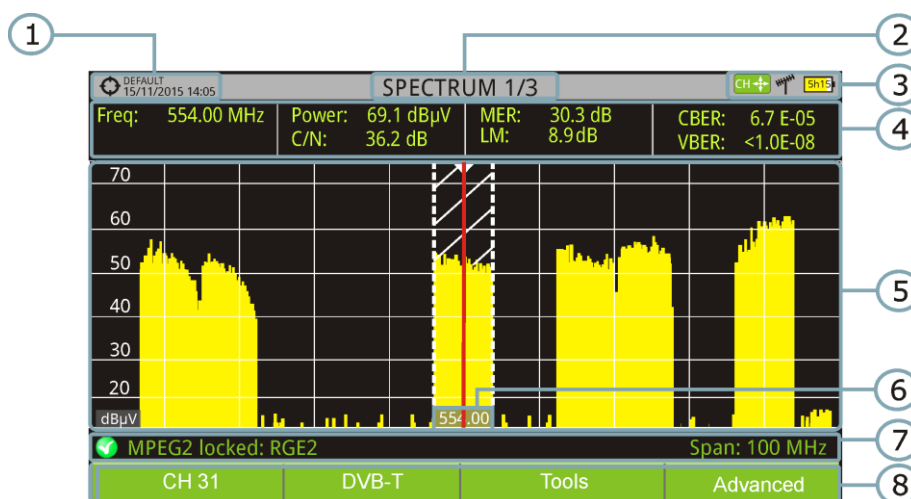

Figure 27.

- ① Selected installation, date and time.
- ② Number of view/total views.
- ③ Control keys active mode, selected band, battery level.
- ④ Measured values of the signal at the frequency/channel where is pointing the cursor.
- ⑤ Spectrum in the band with the selected span.
- ⑥ Centre frequency and cursor. It also shows the bandwidth of a digital locked signal.
- ⑦ Signal status (searching/locked/multiplex name/selected span).
- ⑧ Softkeys menus.

► **Keys up/down:** It changes the reference level.

► **Keys left/right** (depending on control keys active mode):

SP: SPAN change.

FR or **CH:** Frequency change or channel change.

MK: Marker change (if marker is ON).



SPECTRUM 2/3: SPECTRUM + MEASUREMENT + TV *

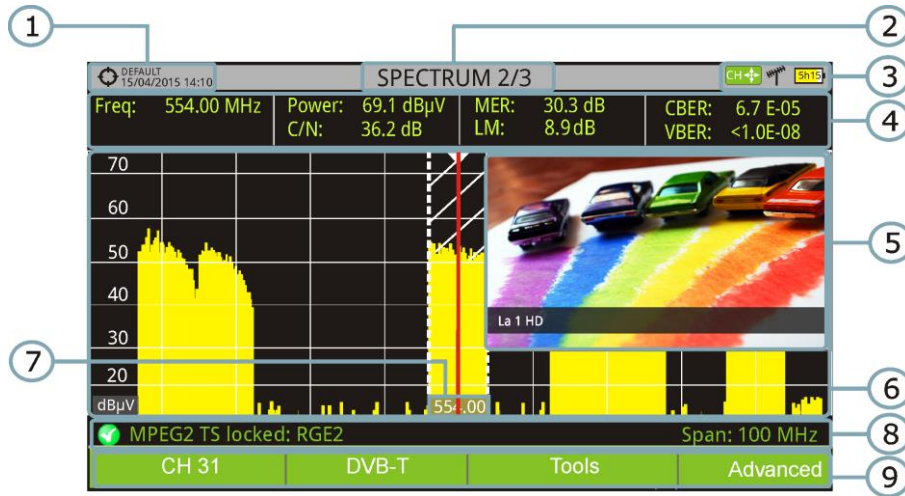

Figure 28.

- ① Selected installation, date and time.
- ② Number of view/total views.
- ③ Control keys active mode, selected band, battery level.
- ④ Measured values of the signal at the frequency/channel where is pointing the cursor.
- ⑤ Image of the tuned signal.
- ⑥ Spectrum in the band with the selected span.
- ⑦ Centre frequency and cursor. It also shows the bandwidth of a digital locked signal.
- ⑧ Signal status (searching/locked/multiplex name/selected span).
- ⑨ Softkeys menus.

► **Keys up/down:** It changes the reference level.

► **Keys left/right** (depending on the control keys active mode):

SP: SPAN change.

FR or CH: Frequency change or channel change.

MK: Marker change (if marker is ON).

* Only available for **digital channels**.



SPECTRUM 3/3: FULL SPECTRUM

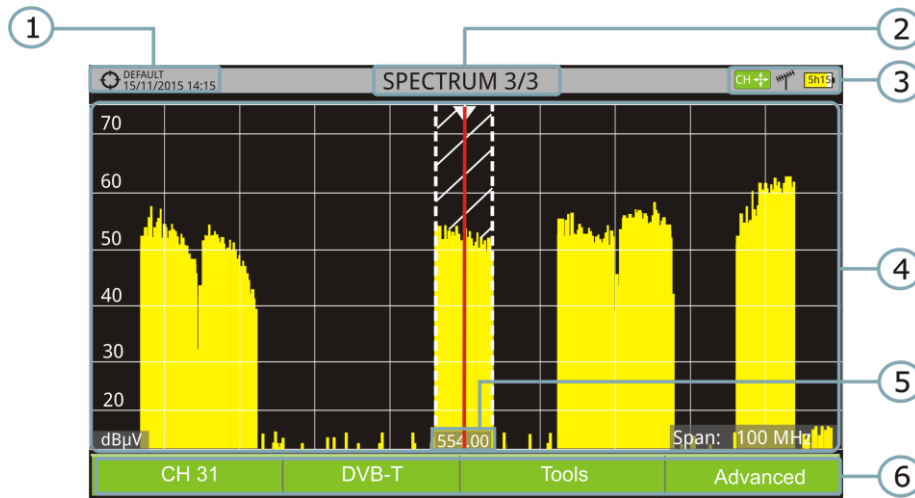

Figure 29.

- ① Selected installation, date and time.
- ② Number of view/total views.
- ③ Control keys active mode, selected band, battery level.
- ④ Spectrum in the band with the selected span.
- ⑤ Centre frequency and cursor. It also shows the bandwidth of a digital locked signal.
- ⑥ Softkeys menus.

► **Keys up/down:** It changes the reference level.

► **Keys left/right** (depending on control keys active mode):

SP: SPAN change.

FR or CH: Frequency change or channel change.

MK: Marker change (if marker is ON).



► **Description in detail of the Full Spectrum screen**

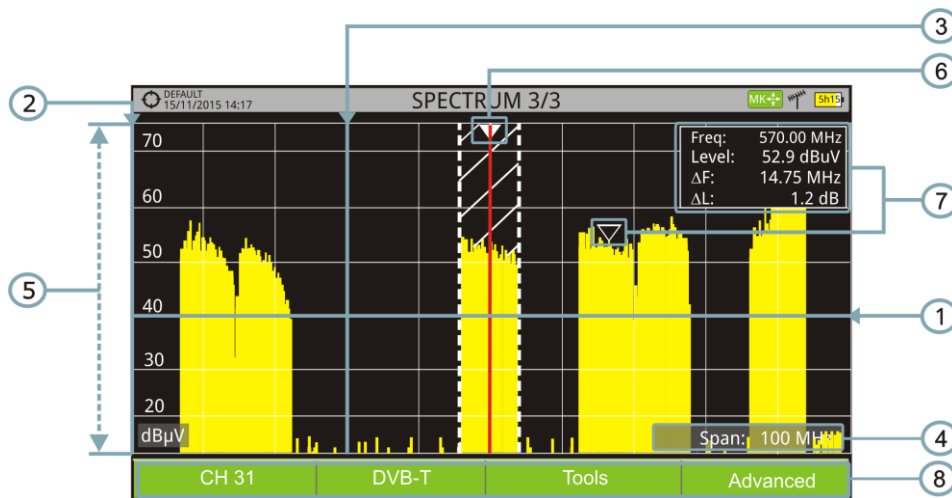

Figure 30.

① **Horizontal reference line**

It indicates the signal level.

② **Vertical axis**

It indicates the signal level.

③ **Vertical reference line**

It indicates the frequency.

④ **SPAN**

It is the frequency range displayed on the horizontal axis.

The current span value appears at the bottom right of the screen. To change use the control keys (left, right) in span mode (SP) or change it by the "span" option in the Tuning menu (F1 key).

Using the control keys, span values available are: Full (full band), 500 MHz, 200 MHz, 100 MHz, 50 MHz, 20 MHz and 10 MHz.

Using the "span" option in the tuning menu it is possible to use any span value between 10 Hz and FULL

Tune by frequency works in 50 kHz steps or by frequency selection.

⑤ **Reference Level**

It is the power range represented on the vertical axis.

To change use the control keys (up, down; 5 dB steps).

This equipment has an option to activate the automatic adjustment of the reference level, so it detects the optimal reference level for each situation. This option can be enabled or disabled through the **PREFERENCES** menu and **Measures** tab.



6 Cursor

Red vertical line that indicates position during the channel or frequency tuning.

When a digital signal is detected, there is a triple cursor that shows the frequency for the signal locked and two vertical lines that shows the bandwidth of the digital carrier.

In the case of a GENERIC signal, the bandwidth shown is the one selected by the user on the "Signal Parameters" menu when pressing the **F2** key.

To change frequency/channel use control keys (left, right) in FR mode (tuning by frequency) or CH mode (tuning by channel).

7 Marker

It is a special cursor that can be placed on a given frequency to check the power in this point.

This option can be enabled using the "**Marker**" option from the **Advanced** menu (**F4** key). To change use control keys (left, right) in **MARKER** (MK) mode.

The window Marker shows the following data:

Freq: Frequency where is placed the marker.

Level: Power level at the frequency where is placed the marker.

ΔF: Difference of frequency between the marker and the main cursor.

ΔL: Difference of power level between the marker and the main cursor.

8 Centre frequency

Frequency at which the screen is centered. This frequency can be set through the **Tuning** **F1** menu. It also changes when moving the cursor out of the screen.

4.4 Control keys Operation

In the **SPECTRUM ANALYSER** mode, the control keys can make different actions depending on its active mode.



The active mode of the joystick appears as an icon at the top right of the screen. Available modes are:

- ▶ **Frequency tuning.**
- ▶ **Channel tuning.**
- ▶ **SPAN change.**
- ▶ **Marker moving.**

To change the active mode press the **OK** key.

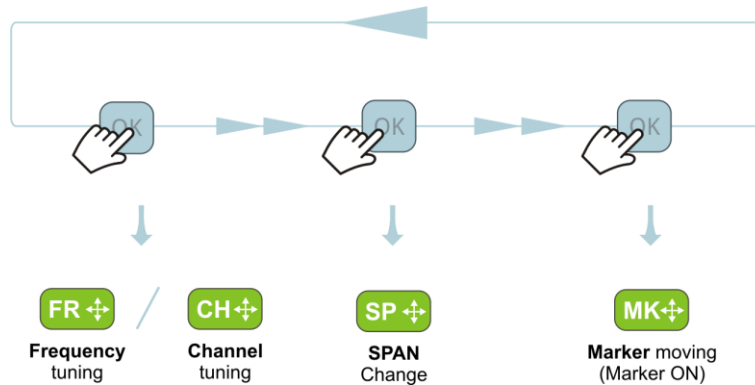

Figure 31.

Pressing left or right will take appropriate action according to the active mode.

Pressing up or down will change the reference level regardless the active mode.

The frequency or channel tuning mode will appear depending on the selected tuning type. Access the **TUNE BY** (F1) menu to select the type of tuning.

To show the **Marker** mode, it must be ON. Access the **ADVANCED** menu (F4) to activate the **Marker**.

Pressing the **OK** key for 1 second, a box appears explaining the control keys modes available. From here user can also select the active mode.

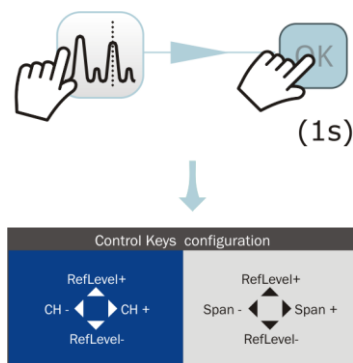



Figure 32.



4.5 Specific Options in the Spectrum Analyser Mode

Access by the  function key. It allows selecting among several parameters to display the spectrum.

The advanced menu consists of the following options:

- ▶ **Average:** The user can select the amount of signal values to be used to set the average signal value to be displayed on screen. The larger the average value, the more stable the displayed signal appears.
- ▶ **Spectrum Line:** It defines the spectrum display. **Outline** option displays the spectrum outline. The **Solid** option displays the contour of the spectrum with solid background. The **Transparence** option shows the outline in yellow and the background in a softer yellow.
- ▶ **Tone Level:** This option produces a tone that changes according to the input level of the signal so the tone is sharper if the level increases and deeper if the level decreases.
- ▶ **Marker:** It allows enabling/disabling the marker. This marker is displayed on screen with the shape of an arrowhead, showing on screen some information about the frequency and power level where it points. You can move left/right by the control keys in **MK** mode (press the **OK** key until the icon **MK** appears).
When the Marker is ON at the top right corner a window pops up with the following data:
 - Freq:** Frequency where is placed the marker.
 - Level:** Power level at the frequency where is placed the marker.
 - ΔF:** Difference of frequency between the marker and the main cursor.
 - ΔL:** Difference of power level between the marker and the main cursor.
- ▶ **Marker Trace:** It allows the user to select the trace to place the marker on:
 - Normal:** It places the marker on the spectrum trace in real time.
 - Reference:** It places the marker on the spectrum reference trace. To make a spectrum reference use the **Reference** function.
 - Max. Hold:** It places the marker on the max. hold trace. To make a maximum hold trace use the **Max. Hold** function.
 - Min. Hold:** It places the marker on the min. hold trace. To make a minimum hold trace use the **Min. Hold** function.



- ▶ **Max. Hold:** (Off/Permanent/Curtain). It allows the user to display the current signal with the maximum values measured for each frequency. The **OFF** option disables this function. The **Curtain** option displays the maximum values in blue for a moment with the current signal. The **Permanent** option maintains maximum signal on the screen. This option is especially useful for detecting sporadic noises.
- ▶ **Min. Hold:** (Off/Permanent/Curtain). It allows the user to display the current signal with the minimum values measured for each frequency. The **OFF** option disables this function. The **Curtain** option displays the minimum values in green for a moment with the current signal. The **Permanent** option maintains minimum signal on the screen. This option is useful for detecting interferences in TV cable or identify deterministic interference in analogue and digital channels.
- ▶ **Persistence:** When active, the signal is displayed on a coloured background. The signal prior to current signal persists for a while before disappearing so the user can see how the signal changes easily.
- ▶ **Detector Type:** (PEAK / RMS). It allows the user to select between maximum PEAK detector or RMS detector. The maximum peak detector is mainly used for analogue modulated signals, while the RMS option is the right choice for digital modulated signals. The max PEAK detector is mostly used for analogue modulated signals, while the RMS is the proper choice for digital modulations. The maximum peak detector causes the noise floor to rise, according to the RMS to peak ratio. That same effect causes digital signals to apparently grow in level when maximum peak detector is used.
- ▶ **Resolution bandwidth:**
Resolution filters available. For terrestrial and satellite: 100, 200 and 1000 kHz. According to the filter being selected, that maximum and minimum span allowed is modified.
- ▶ **Vertical Range:** It allows to adjust the vertical scale on screen. Available values are 1, 2, 5 and 10 dB per division.
- ▶ **Dashed BW:** When it is ON the channel bandwidth area is hatched by lines.
- ▶ **Reference:** (Set / Clear). It memorizes the current trace on screen, which can be used as a reference for further comparison. It can be also very helpful for visually measure the gain or attenuation in a TV distribution network. To delete the reference, select the "clear" option. It can also be activated by a short press on the export key in the Spectrum Analyzer mode. Pressing short again on the export key it clears the reference.



4.6 Select and edit parameters

To edit or select any parameters of these described above, follow these instructions:

- 1 Place over the option and press the **OK** key.
- 2 The data field gets into the edit mode, indicated by the yellow background.
- 3 A menu is displayed at the right with some options or if it is numeric, a number gets a black background.
- 4 Move the control keys up/down to select one option. To move between figures press right/left and to change it press up/down.
- 5 When finished press **OK** key or any function key to exit.

4.7 Locking a signal

- 1 Connect the cable with the input signal to the **RF** input connector.
- 2 Press the **SPECTRUM** key. The spectrum of the signal is displayed.
- 3 Adjust the span (recommended value for a terrestrial signal 50 MHz and for a satellite signal 100 MHz). The current value of the span is at the right bottom of the screen.
- 4 Find the frequency of the signal by moving the control keys left or right to move sweeping the entire band.
- 5 If you know the channel change the tuning by frequency to tuning by channel. The channel mode allows you to navigate from channel to channel, using the selected channel plan.
- 6 When the channel is locked information appears at the bottom left of the screen. A triple cursor shows the detected BW for a digital carrier.
- 7 The equipment automatically detects transmission parameters of the signal and makes the corresponding measurements.



4.8 Satellite Identifier

The spectrum analyser makes easier the fieldwork for engineers when working with SNG mobile units and VSAT communications, since it allows adjusting transmission-reception systems. It also has several functions to identify satellites that avoid any possibility of error. When the signal is locked it identifies the satellite and shows on screen its name.

Often satellite operators request to look for the "Beacon" signal, as a method of satellite identification. This signal is easily identified by the equipment, because it has high resolution, high sensitivity and short sweep times.

Below are two BEACON screenshots signals, with a span of 10 MHz and a bandwidth of 100 kHz resolution, all with a sweep time of 90 ms.

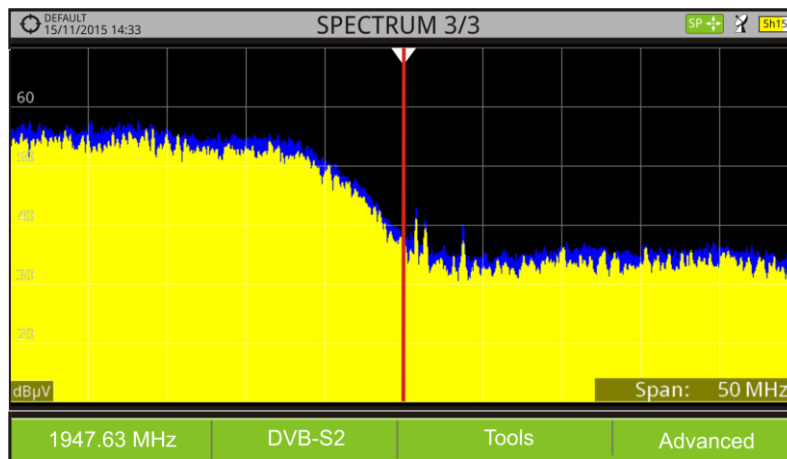

Figure 33.

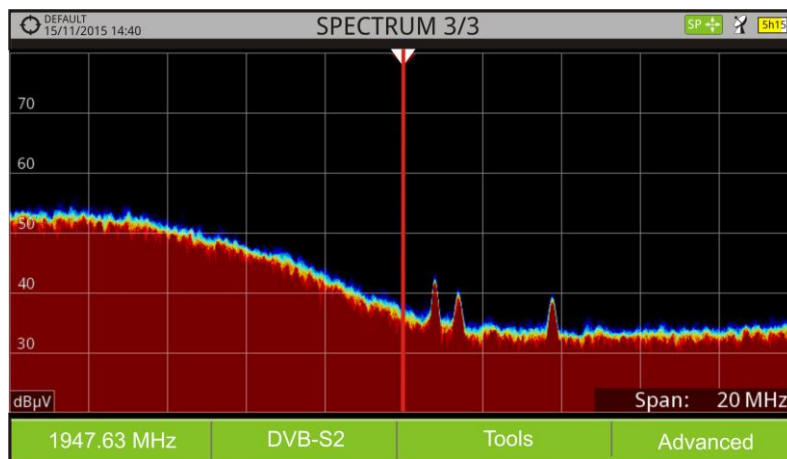

Figure 34.

More data for installations with satellite signals in annex "How to point a dish antenna."



5 TV MODE





5.1 Introduction

On the left side of the front panel there are three functions, which give direct access to the three most important functions. One is the **TV MODE** key  which displays the resulting image from decoding received RF signal.

TV MODE, thanks to the StealthID function of automatic identification, automatically identifies and demodulates the signal received by the RF input, so the user can check the signal on the screen. It shows information about the channel and its services.

5.2 Operation

- 1 To access the **TV MODE** option, press the  key.
- 2 If locks, the screen shows the tuned signal demodulated.
For digital carriers, the first service of the terrestrial multiplex or satellite transponder appears. In case the signal is scrambled the image will not appear and it shows the icon for scrambled signal.
In the case of an analogue signal, tuned signal will appear.
- 3 To access the next view (if digital signal) of the **TV MODE**, press the  again. At the last view it will return back to the first.



5.3 Screen Description

5.3.1 TV MODE: TV views

Views for TV mode are:



TV 1/3: FULL TV

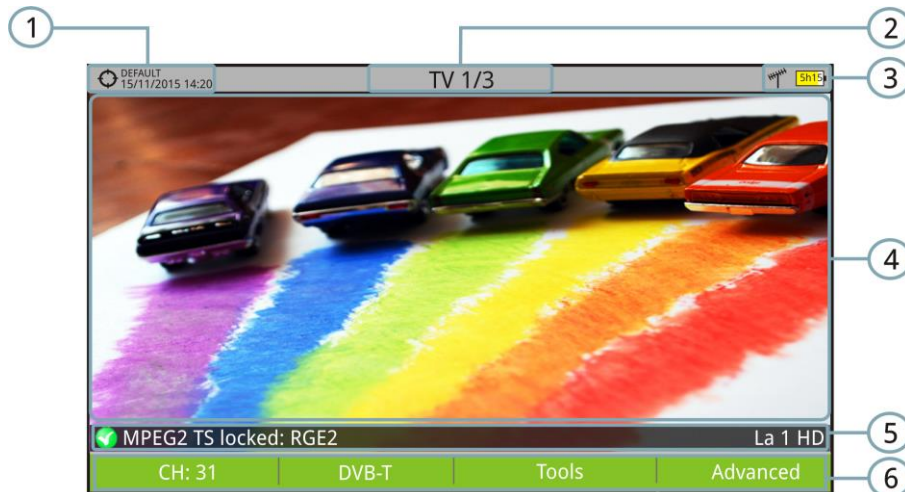

Figure 35.

- 1 Selected installation; date and time.
- 2 Number of view/total views.
- 3 Selected band, battery level.
- 4 Tuned service image.
- 5 Signal status (searching/locked/multiplex name) and name of the selected service.
- 6 Softkeys menus.

► **Keys up/down:** It changes service.

► **Keys left/right:** It changes channel/frequency (depending on the tuning mode).



TV 2/3: TV + SPECTRUM + MEASUREMENT *

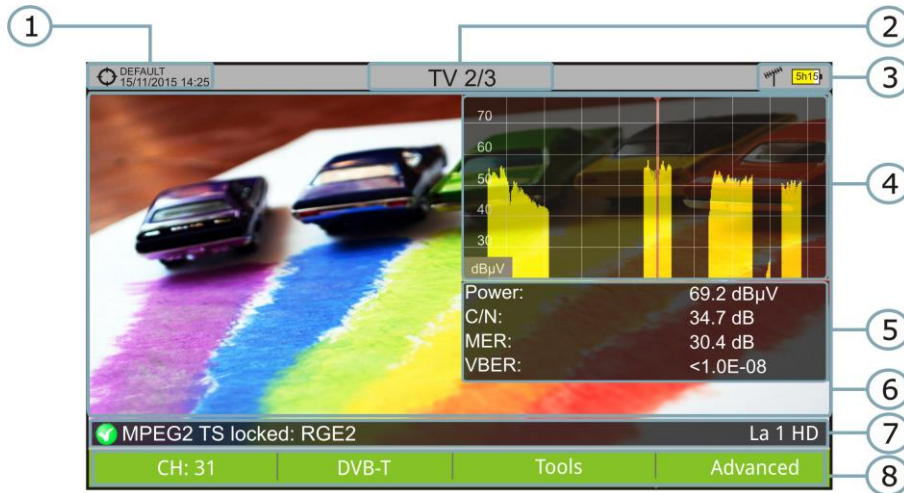

Figure 36.

- ① Selected installation; date and time.
- ② Number of view/total views.
- ③ Selected band, battery level.
- ④ Tuned service image.
- ⑤ Spectrum.
- ⑥ Measured values of the signal in the frequency/channel the cursor is pointing.
- ⑦ Signal status (searching/locked/multiplex name) and name of the selected service.
- ⑧ Softkeys menus.

▶ **Keys up/down:** It changes service.

▶ **Keys left/right:** It changes channel/frequency (depending on the tuning mode).

* Only available for digital channels.



TV 3/3: SCREEN TV + SERVICE DATA *

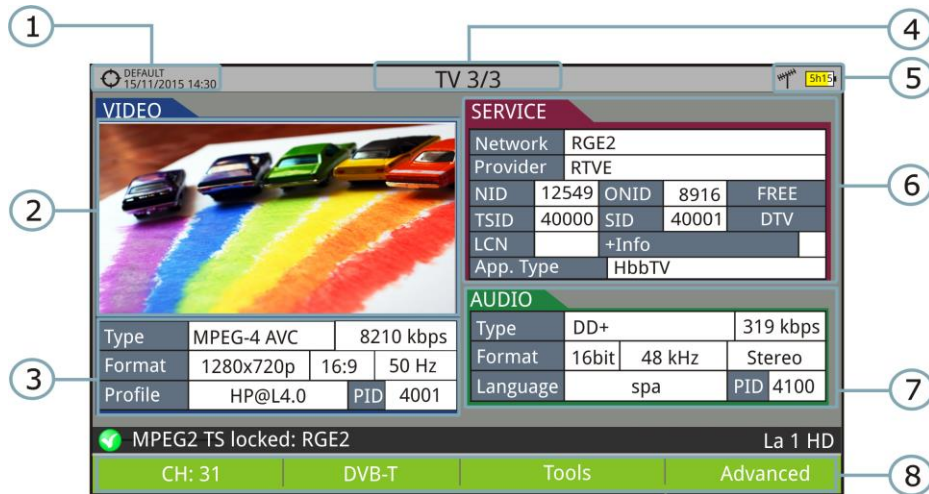

Figure 37.

- 1 Selected installation; date and time.
- 2 Tuned service image.
- 3 Tuned service information.
 - ▶ **TYPE:** Encoding type and video transmission rate.
 - ▶ **FORMAT:** Resolution (horizontal x vertical), aspect ratio and frequency.
 - ▶ **PROFILE:** Profile level.
 - ▶ **PID:** Video program identifier.
- 4 Number of view/total views.
- 5 Selected band; battery level.
- 6 Tuned service information.
 - ▶ **NETWORK:** Television distribution network (Terrestrial). Orbital position (Satellite).
 - ▶ **PROVIDER:** Program provider name.
 - ▶ **NID:** Network identifier where the signal is distributed.
 - ▶ **ONID:** Identifier of the original network where the signal originates.
 - ▶ **TSID:** Transport stream identifier.
 - ▶ **SID:** Service Identifier.
 - ▶ **App. Type:** Type of detected interactive service such as HbbTV, MHP and MHEG-5. It also shows the URL related to the interactive service in F4: Advanced -Discovered URLs.
 - ▶ **LCN:** Logic Channel Number. It is the first logic number assigned to the first channel in the receiver.

* Only available for digital channels.



- ▶ **+Info:** Additional service information.
 - ▶ **NIT v:** Network Information Table version.
 - ▶ **FREE/SCRAMBLED:** Free/scrambled transmission.
 - ▶ **DTV/DS:** Standard type of transmission.
- 7 Tuned audio information.
- ▶ **TYPE:** Type of audio encoding and transmission speed
 - ▶ **FORMAT:** Service audio format. Bit depth; sampling frequency; sound reproduction.
 - ▶ **LANGUAGE:** Broadcasting language.
 - ▶ **PID:** ID of the audio program.
- 8 Signal status (searching/locked/multiplex name) and name of the selected service.
- 9 Softkeys menu.
- ▶ **Keys up/down:** It changes service.
 - ▶ **Keys left/right:** It changes channel/frequency (depending on the tuning mode).

NOTE: The equipment can identify the HEVC (H.265) signaling and display its transmission data such as the video type, profile, format, aspect ratio and bit rate. However HEVC cannot be decoded so no image on screen will be displayed.

NOTE: PID, NID, ONID, TSID and SID fields can be shown in decimal or hexadecimal format. To select this parameter go to "Values Format" in "Preferences" - "Appearance"



5.3.2 TV MODE: Radio views

Radio views are:



RADIO 1/2: AUDIO RADIO



Figure 38.



RADIO 2/2: AUDIO RADIO + SPECTRUM + MEASUREMENTS



Figure 39.



5.4 Specific Options

► Analogue Signal

This option is available only if the detected or selected signal is ANALOGUE.

Pressing the  key it allows selecting the type of analogue input, between antenna (via RF connector) and external (this option is not in operation for this model).

► Aspect Ratio

This option is available only if the detected or selected signal is ANALOGUE.

It allows the user to select the image aspect ratio (4:3; 16:9). It remembers this selection even after switch off.

► Advanced

This option is available only if the detected or selected signal is DIGITAL.

It gives access to these options:

- **Audio:** It allows the user to select among the audio tracks available.
- **TS Data:** It shows the IRG data descriptor. If the signal contains this carrier identifier, this option will be enabled. If the signal does not contain this identifier, the option will be disabled (for more information refer to section "IRG descriptor").
- **Discovered URLs:**
If shows the URL related to the interactive service.

5.5 IRG Descriptor

The analyser is compatible with IRG recommendations and it can extract the Carrier ID information and display it conveniently showing all the details.

This information is useful to identify the interference, thanks to the carrier ID. This identifier provides enough information to detect the interference source (customer name, contact data, geo coordinates, etc.) and allows the operators to communicate directly with the RFI source to resolve the incident.



IRG descriptor function is available only for signals containing the carrier identifier. To access this feature:

- 1 Connect the **RF** input signal to the equipment.
- 2 Tune the channel that produces interferences.
- 3 Access to **TV** mode.
- 4 Press the **Advanced** menu .
- 5 Select the **TS Data** option. If the signal has a carrier identifier, this option is enabled. If the signal does not contain this identifier, this option is disabled.
- 6 The **IRG descriptor** window is displayed with the data about the provider (see figure below).







Figure 40.



6 GENERAL MENU OPTIONS

At the bottom of the screen four menus are accessible via the softkeys or programmable keys.

-  It displays the channel where is pointing the cursor and gives access to the tuning menu.
-  It displays the selected transmission standard and gives access to the signal parameters menu.
-  It displays the Tools menu.
-  It displays the Advanced menu.

In general, these options are the same for all modes (Measure, Spectrum Analyser and TV).

The specific options for a mode are placed in the menu "Advanced" pressing the  key. For more details about these options go to section "Specific Options" in the chapter.

Next each one of these menus is described.

6.1 **F1: Tuning**

Access by the function  key. It contains the options to tune a channel.

The tuning menu consists of the following options:

- ▶ **Channel/Frequency:** It displays the channel/frequency pointed by the cursor. Tuning type (channel/frequency) is selected by means of the "Tune by" option.
- ▶ **Channel Plan:** This option allows the user to select a channel plan from the ones available for the current installation.
- ▶ **Tune by:** It allows the user to select between tuning by channel (selecting a channel or channel by channel with the control keys) and tuning by frequency (selecting a frequency or step by step with the control keys).



- In case of **tuning by channel**, it allows selecting a channel from the active channel plan:
 - 1 Place over the **Channel** option and press the **OK** key.
 - 2 A box appears with all channels of the active channel plan and its frequency.
 - 3 Move the control keys on the box to select a channel.
 - 4 When finished press **OK** key to save the selected value or any function key to exit without saving.
 - 5 The cursor will place on the selected channel and it will appear on the  option.

- The channel can be changed directly with the joystick in **CH** mode.

NOTE: When using tune by channel on satellite, the polarity parameters (horizontal/vertical and left/right) and satellite band (high/low) are selected automatically by the equipment, according to the channel plan enabled and cannot be changed by the user. To change these parameters, the user may switch to frequency tuning. But the user can change the voltage output while in a channel plan, as long as none has been defined in that same channel plan. For instance, if a standard channel plan is being used like the CCIR, there is now need for switching to frequency tuning mode or make special channel plans for using active antennas.

- In case of **tuning by frequency**, the frequency can be edited:
 - 1 Place over the **Frequency** option and press the **OK** key.
 - 2 The option is highlighted in yellow to indicate it is in edit mode.
 - 3 Move the control keys left/right to move between the figures and up/down to change the figure.
 - 4 When finished press **OK** key to save the selected value or any function key to exit without saving.

- The frequency can be changed directly with the control keys in **FR** mode in 50 kHz steps.



[Click here to watch this video: Manual input of frequencies](#)



- ▶ **Center Frequency:** This option is available only for the Spectrum Analyser mode. It allows to edit the center frequency. The center frequency is the frequency at which the screen is centered. To edit:
 - 1 Place over the **Frequency option** and press the **OK** key.
 - 2 The option is highlighted in yellow to indicate it is in edit mode.
 - 3 Move the control keys left/right to move between the figures and up/down to change the figure.
 - 4 When finished press **OK** key to save the selected value or any function key to exit without saving.

- ▶ **Reference level:** This option is available only for the Spectrum Analyser mode. It allows to edit the reference level. The reference level is the power range represented on the vertical axis. To edit:
 - 1 Place over the **Reference Level** option and press the **OK** key.
 - 2 The option is highlighted in yellow to indicate it is in edit mode.
 - 3 Move the control keys left/right to move between the figures and up/down to change the figure.
 - 4 When finished press the **OK** key to save the selected value or any function key to exit without saving.

- The **Reference Level** can be changed directly pushing the keys up or down.

- ▶ **Span:** This option is available only for the Spectrum Analyser mode. It allows to edit the span, which is the frequency range displayed on screen. To edit:
 - 1 Place over the span option and press the **OK** key.
 - 2 The option is highlighted in yellow to indicate it is in edit mode.
 - 3 Move the control keys left/right to move between the figures and up/down to change the figure.
 - 4 When finished press the **OK** key to save the selected value or any function key to exit without saving.

- The span can be changed directly with the control keys in **SP** mode.



► **Center tuned frequency:**

This option is only available for the Spectrum Analyser mode. When selecting this option, the frequency tuning (where the cursor is pointing) is placed at the center of the screen. Even changing the span or mode (TV or measurements), this frequency is kept at this position. This option is not available for FULL span.

► **Downlink:**

This option is available only if the option **Ter. Downlink** in **Preferences** menu has been enabled. It allows user to work in terrestrial band with radio link down converters external units (from 1 to 11 GHz) and tune using the link frequency.

► **View all services:**

This option only appears if the **Database services** option is enabled in the **Preferences** menu.

This option displays a window with a list of services that have been detected in the current installation.

The list shows service name, provider, SID (stream identifier) and an icon that shows its type (radio, tv) and if it is scrambled. When hovering on the service for one second it displays a hint window with more information.

If user presses the **OK** key on a service, it will access that service.

When disabling the **Database services** option, all services in the installation will be deleted from the list. At the bottom of this option are shown the softkeys with these functions:



Cancel: It exits the option.



Filter List: It shows several options to filter the list of services: **By access** (Free Only, Scrambled Only, All); **By type** (All, TV, Radio); **Search by name** (filtered by the name); **Reset list** (it restarts the list as at first) Service filtering is persistent until resetting.



Page Up: It jumps one page up.



Page Down: It jumps one page down.

6.2 F2: Signal Parameters

Access by the  function key. It allows selecting the standard transmission and displays the parameters for signal transmission.

This menu allows selecting the transmission standard:

► **Type of signal:** It displays the selected standard. It allows selecting another standard in the same band (terrestrial or satellite):

- 1 Place over the **Signal Type** option and press the OK key.
- 2 It displays a menu at the right with the transmission standards.
- 3 Move the control keys up / down to select a standard.
- 4 Press the **OK** key to select the standard or any function key to exit without selecting.

► **View Advanced Parameters:**

It shows the TPS parameters (Transmission Parameters Signalling) for the locked signal according to the modulation standard. This option is available only when these parameters are detected.

- The remaining transmission parameters are detected demodulating the locked signal.
- In case of a DVB-S/S2 signal, the symbol-rate parameter can be set manually.
- In case of a DVB-S2 signal, there will be some special settings for this type of signal. They are:

Physical Layer Scrambling or PLS is used in DVB-S2 as a way to improve data integrity. A number called the "scrambling sequence index" is used by the modulator as a master key to generate the uplink signal. This same number must be known by the receiver so that demodulation is possible.

Most satellite transponders use PLS 0 as a default value but there are some transponders that use other values.

If it is a multistream (MSI) signal, it will appear an option that enables filtering by the input stream identifier (ISI) and to select the stream to demodulate.

When a satellite transponder is working with a non-zero PLS code plus MSI (multiple streams), system will lock that signal in a quite automatic way.



[Click here to watch this video: DVB-S2 multi stream decoding](#)

- In case of a Generic signal, the menu shows an option to select the signal bandwidth.







6.3

F3: Tools

Access by the  key. It shows the Tools menu. This menu can change depending on the type of selected standard. Tools are:

- ▶ **Select Service:** It displays the list of services available in the multiplex tuned, with the service name, icons that identify the service type, SID (stream identifier) and LCN (logic channel number).

Icons that appear next to the service name identify the features of the service. The meaning is given in the following table:

	Digital TV service		High Definition TV service
	Digital radio		Data
	Scrambled service		

- ▶ **Explore channel plan:** It explores the selected channel plan. Tune by channel must be selected.
- ▶ **Datalogger:** It creates a file in which are stored measurements. This file belongs to the selected current installation.
- ▶ **Service Recording:** The equipment records in real-time one digital service from the transport stream received that is shown on screen. This service is saved directly on the USB flash drive memory connected to the equipment.
- ▶ **Echoes:** It detects the echoes that may appear due to the simultaneous reception of the same signal from several transmitters.
- ▶ **Constellation:** It displays the constellation of the locked signal.
- ▶ **Attenuation test:** This feature allows the user to easily check the response of the telecommunications installations before antennas and headers are working.
- ▶ **LTE Ingress Test:** It enables the detection of signal interferences coming from mobile phones.
- ▶ **Field strength:** This tool allows the equipment to measure as a field strength meter.
- ▶ **Task Planer:** It allows the user to schedule specific tasks.

For more information about these features, see the "**Tools**" chapter.



7 TOOLS

7.1 Constellation

7.1.1 Description

The constellation diagram is a graphic representation of the digital symbols received over a period of time. There are different types of constellation diagrams according to the modulation type.

In the case of an ideal transmission channel without noise or interference, all symbols are recognized by the demodulator without errors. In this case, they are represented in the constellation diagram as well defined points hitting in the same area forming a very concentrated dot.

Noise and interferences cause the demodulator to not always read the symbols correctly. In this case hits are dispersed and create different forms which can visually determine the type of problem in the signal.

Each type of modulation is represented differently. A 16-QAM signal is shown on screen by a diagram of a total of 16 different zones and a 64-QAM signal is represented by a diagram of 64 different zones and so on.

The constellation diagram shows in different colours the density of hits and includes features to zoom, move and delete the display on screen.

7.1.2 Operation

The constellation is available to all **DIGITAL** signals, both **TERRESTRIAL** and **SATELLITE**.

To access the **CONSTELLATION** tool:

- 1 Connect the **RF** input signal to the equipment.
- 2 Tune to a digital signal from satellite or terrestrial band.
- 3 Press the  key (**Tools**).
- 4 Select **CONSTELLATION**.
- 5 The **CONSTELLATION** of the tuned signal appears.



► Screen Description

Constellation screen description:

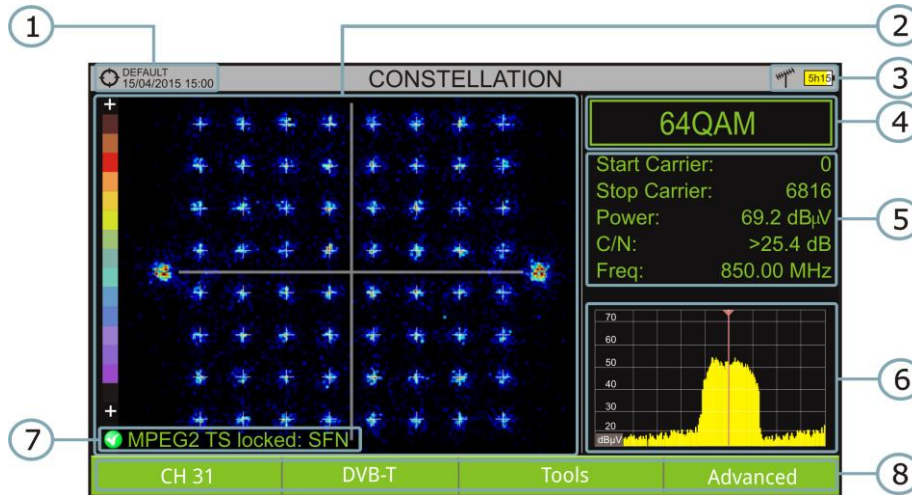

Figure 41.





- 1 Selected installation; date and time.
- 2 Constellation window.
The colour scale placed at the left side indicates the signal quality in a qualitative way by a gradation of colours proportional to the density of symbols concentrated in a given area. The colour scale ranges from black (no symbols) to red (highest density).
Greater dispersion of the symbols indicates higher noise level or worse signal quality signal. If there is symbols concentration with respect to the full grid (see advanced menu for types of grid) this is indicative of good ratio signal/noise or absence of problems.
- 3 Selected band, battery level.
- 4 Constellation modulation.
- 5 Data Window.
The data shown are: Start Carrier, Stop Carrier, Power, C/N and frequency/channel.
- 6 Spectrum of the tuned signal.
Spectrum is displayed with the span selected at the **SPECTRUM** mode.
- 7 Signal status (searching/locked/multiplex name).
- 8 Softkeys menus.

► **Keys Left/Right:** Frequency/Channel change (depending on the tuning mode).



7.1.3 Menu options

On the bottom of the screen there are four menus accessible via the function keys.

-  F1 It displays the channel / frequency where is pointing the cursor, accesses the tuning menu and allows selecting the channel plan.
-  F2 It displays the selected transmission standard menu and accesses the signal parameters.
-  F3 It displays the Tools menu.
-  F4 It displays the Advanced menu.

In the **Advanced** menu there are some options to set the constellation tool. They are:

► **Grid type:**

- **Full Grid:** The grid where the constellation is displayed is a complete grid.
- **Cross Grid:** The grid where the constellation is displayed is made of crosses.

► **Persistence:**

It allows the user to set the level of persistence, which is the lapse of time the signal stays on the screen before disappearing. Available options according to the persistence level are: low, medium, high or permanent.

► **Zoom:**

It allows the user to select a quarter (I, II, III or IV) where apply the zoom in. To come back to normal view select **All**.

► **Start Carrier/Stop Carrier:**

This option allows selecting the range of carriers to be displayed between the first and last.

► **Clear:**

This options clears all symbols in the whole constellation window.



7.2 Echoes

7.2.1 Description

The **Echoes** function shows the response in time of a digital terrestrial channel and therefore it can detect echoes that can occur due to the simultaneous reception of the same signal from several transmitters with different delays and amplitudes.

Another cause that may cause echoes is reflection of the signal on large objects, as buildings or mountains. This may be the explanation that having a good C/N and a good signal, the BER does not reach the minimum value.

With the **Echoes** function is possible to know the distance from where the equipment is to the transmitter or the object that caused the echo. Thus, the installer can minimise the effect that the echo may cause on the installation, reorienting the antenna and reducing the effect of received echoes.

This function is only available for **DVB-T**, **DVB-T2** and **DVB-C2**. Therefore, previously have to configure the equipment for the reception of such signals.

7.2.2 Operation

Echoes function is available for **DVB-T**, **DVB-T2** and **DVB-C2** signals.

- 1 Connect the **RF** input signal to the equipment.
- 2 Tune a **DVB-T**, **DVB-T2** or **DVB-C2** digital signal at the terrestrial band.
- 3 Press the  key (Tools).
- 4 Select **Echoes**.
- 5 The **Echoes** function of the tuned signal appears on screen.



► **Screen Description**

The following describes the **Echoes** screen:

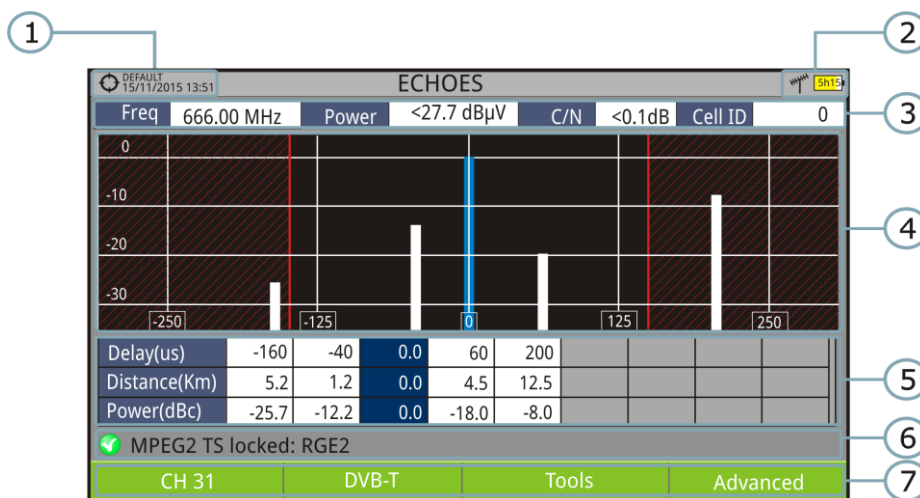

Figure 42.

- 1 Selected installation; date and time.
- 2 Selected band, battery level.
- 3 Main signal data: Frequency, Power, C/N and Cell ID (it shows the main signal transmitter, if available).
- 4 **Echoes** Diagram.
The display shows a graphical representation of the echoes. The horizontal axis of the graph corresponds to the delay in receiving the echo on the main path (the stronger signal).The vertical axis represents the attenuation of the echo in dB on the main path.
- 5 Data box with main data regarding echoes.
In the list of echoes it shows the power, the delay in microseconds and the distance in kilometres to the echoes.
- 6 Signal status (searching/locked/multiplex name).
- 7 Softkeys menus.

- **Keys left/right (CHANNEL/FREQUENCY active mode):** It changes the channel/frequency (according to the tuning type selected).
- **Keys up/down (ECHOES mode):** It changes Zoom.

Remember to press the **OK** key to change the **ECHOES** mode to **CHANNEL** mode.



7.2.3 Menu options

At the bottom of the screen there are four menus available via the function keys.



It displays the channel/frequency where is pointing the cursor, it allows the user to select a channel or frequency, a channel plan and access the tuning menu.



It displays the selected transmission standard menu and accesses the signal parameters.



It displays the Tools menu.



It displays the Advanced menu. The ZOOM option changes the zoom on the echoes windows. Zooms are 1x, 2x, 4x and 8x.







7.3 Attenuation Test

7.3.1 Description

This feature allows the user to easily check the response of the telecommunications installations before antennas and headers are working. It allows the user to evaluate the response along the complete range of frequencies by measuring the losses (attenuation) in the distribution of TV signals, comparing reference levels at headend output and at each house antenna plugs.

7.3.2 Operation

Attenuation test function is available for all signals.

- 1 In **Settings**  select the terrestrial or satellite band.
- 2 Press the **Tools** key .
- 3 Select the **Attenuation Test** option.
- 4 The **Attenuation Test** function for the signal appears on screen.
- 5 First, set the parameters before the test, pressing the **Advanced**  key: Frequencies of pilot signals (pilot 0, pilot 1 and pilot 2), maximum attenuation and threshold attenuation (see more details in the next section).
- 6 Then it is necessary to **Set References**. This requires a signal generator. We recommend to use of one of the PROMAX signal generators: **RP-050**, **RP-080**, **RP-110** or **RP-250** (depending on the frequency band).
- 7 Connect the generator and the equipment where the origin of the signal distribution is in the installation (antenna, headend, etc.) or connect the generator directly to the RF input of the equipment. If necessary, the equipment can feed the generator using the "**Supply Output**" option from the **Settings** menu .
- 8 Active the signal generator and in the equipment, press the **Set Reference** key .
- 9 Once are set the references for the pilot signals, let the signal generator connected to the source point of the distribution system and take measurements in each user access point with the equipment.
- 10 In each measurement a message over each pilot signal indicates whether the measure "Pass" or "Fail" according to the parameters set.
- 11 The measurement data from the **Attenuation Test** can be saved through the **Datalogger** tool. To do this, when creating a new datalogger, in the option "**Include Attenuation Tests**", select Terrestrial (TERR ICT) and/or Satellite (SAT ICT). Then, the user must perform a datalogger from the test point where he is performing the attenuation test. Another quick option it is to select the "Test & Go" function in the "Datalogger" menu. This option creates automatically one channel plan (TER ICT or SAT ICT according to the current band) and starts to save measurements. The data will be saved and can be checked and transferred to a PC. For more information, see "Datalogger" section under the "Tools" chapter. Also measurement data or screen image can be exported by pressing the **Export**  key (see more details in section "Export key") and after that display the images or download the data files (in XML format).

NOTE: In both satellite and terrestrial band, the system saves the LNB state every time the user sets a reference and uses this value always that the equipment is working in this mode.

► **Screen Description**

The following describes the **Attenuation Test** screen:

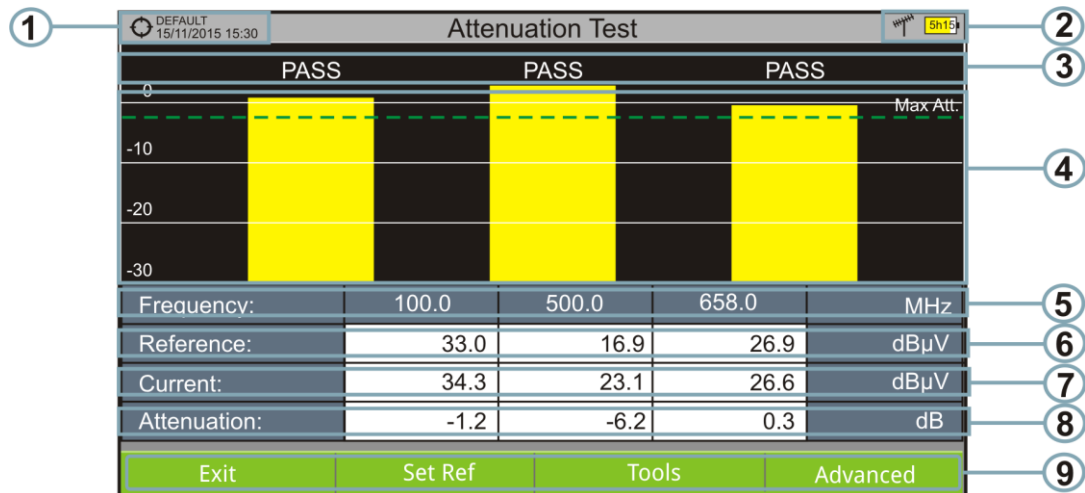

Figure 43.

- ① Installation selected, date and time.
- ② Selected band; battery level.
- ③ Status message depending on the attenuation level.
- ④ Power level of the signal.
- ⑤ Signal Frequency (MHz).
- ⑥ Power level of the reference signal obtained when setting the reference and used to calculate the attenuation level (dBμV).
- ⑦ Power level of the test signal at the user access point (dBμV).
- ⑧ Attenuation level (dB); $\text{Attenuation} = \text{Reference} - \text{Current}$.
- ⑨ Softkeys.

X-axis: Pilot signals

Y-axis: Power

► **Control Keys:** Control keys does not have any function in this tool.



7.3.3 Menu options

In the bottom of the screen are four menu accessible via the softkeys.



Exit: Exits the tool.



Set Reference: Pressing this option the current power values are captured and they are assigned as reference values.



Tools: It access the Tools main menu.



Advanced: It access the Advanced menu.

In the **Advanced** menu there are five parameters to set the attenuation test. They are:

► **Threshold Attenuation:**

It defines the maximum difference that may exist between the pilot signal of higher level and the pilot signal of lower level. All pilot signals out of this range will be removed and not used as a pilot signal during the measurement process.

► **Maximum Attenuation:**

It sets the attenuation level used by the equipment to show on screen if the signal passes or fails. When the attenuation level is below this value the message on screen is "**PASS**" and when it is above this value is "**FAIL**".

► **Pilot 0:**

It defines the frequency of the pilot signal 0 (MHz).

► **Pilot 1:**

It defines the frequency of the pilot signal 1 (MHz).

► **Pilot 2:**

It defines the frequency of the pilot signal 2 (MHz).









7.4 Datalogger

7.4.1 Description

The Datalogger function stores automatically measurements in a file set by the user (name, channel plan). User can store for each datalogger measurements taken at different test points of the selected installation. Measurements are made for all channels in the active channel plan, both analogue and digital. Each installation has its own datalogger files.

7.4.2 Operation

► To create a new datalogger:

- 1 First select one installation of the list of installations  and load it pressing the "Load" key . An installation contains the channel plans and DiSEqC commands selected by the user and it stores dataloggers and screenshots made while it is selected (more information in chapter "Installations management").
- 2 Check the installation is selected. The name of the installation should appear on the upper left corner of the screen.
- 3 Press the : **Tools** key.
- 4 Press on the "Datalogger" option.
- 5 It displays a menu with the "New ...", "Test & Go" option and a list of all dataloggers at the selected installation.
- 6 Select "New ..." to create a new datalogger, select "Test & Go" to create a quick datalogger (see next) or select the file name of an existing datalogger if the user want to save data on a specific datalogger already existing.
- 7 If "New ..." is selected, a installation wizard shows how to create a new datalogger. Follow its instructions (: Next to move to the next screen, : Previous to move to the previous screen or : Cancel to cancel).



- 8 When creating a new datalogger through the wizard, the user can give a name to the datalogger.

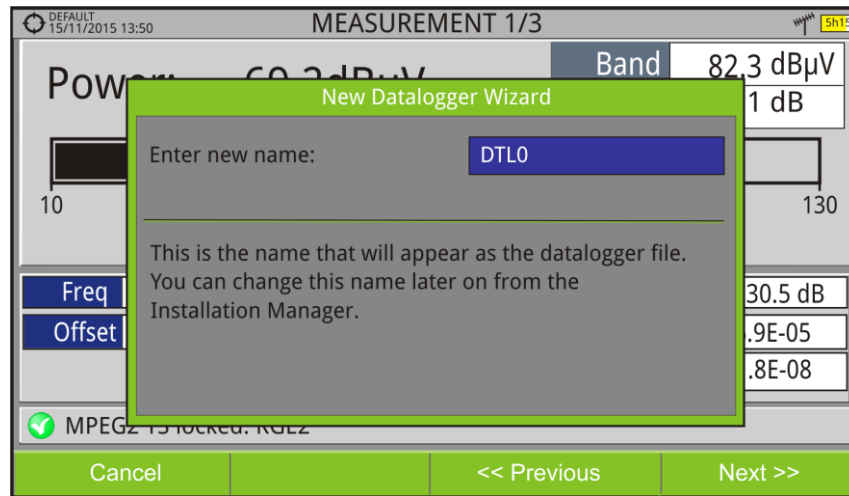

Figure 44.

- 9 Next, the user can select the terrestrial and/or satellite channel plan to use in the datalogger. The channel plans that are shown depends on the channel plans available for the current installation.

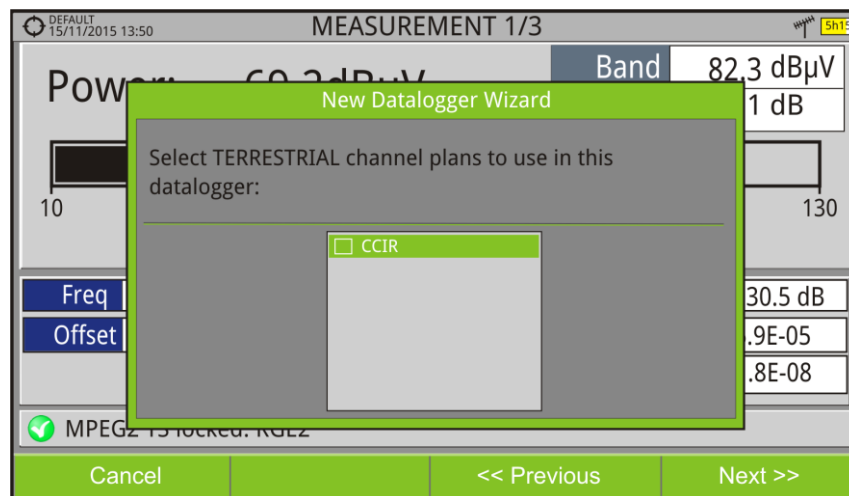

Figure 45.

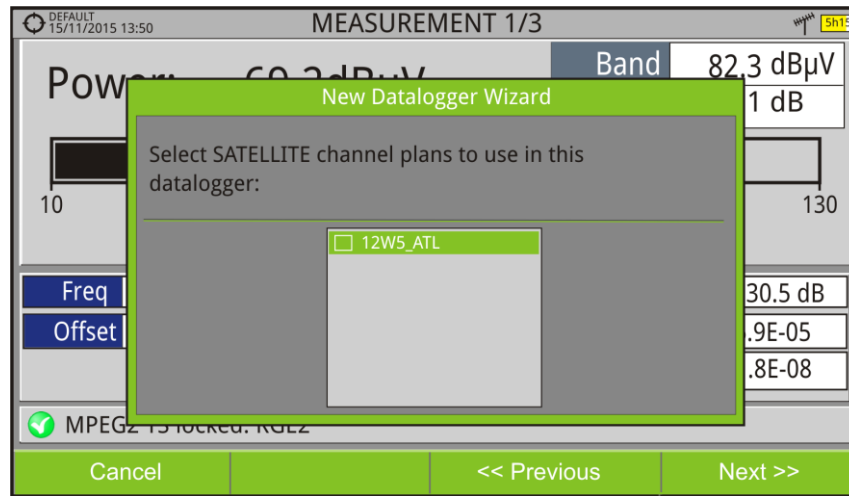

Figure 46.

- 10 In the next window, the user can select an option to capture de service list when performing the datalogger (this option slows down the process but provides more information). Another option allows the user to enable a pause between channel plans (the process stops until the user wants to carry on). There is also the option to perform a datalogger on the attenuation test, terrestrial or satellite (see section "Attenuation Test" under "Tools" for more information).

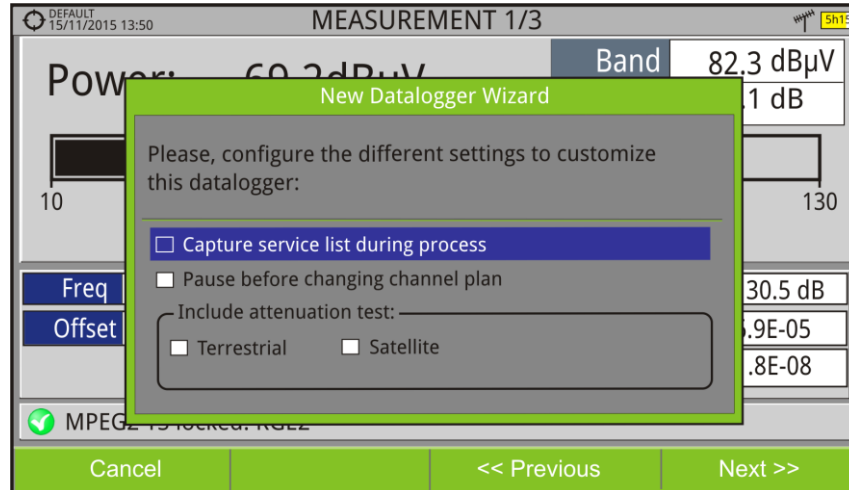

Figure 47.

- 11 At the last step, user can select to open the just created new datalogger (by default, this option is selected).
- 12 Once a new datalogger is created or selected an already existing one, it shows the datalogger viewer screen and measurements of test points can start.
- 13 If it is a new datalogger, in first place before starting the datalogger, the system will create a new test point (see next section).



Click here to watch this video: Datalogger

► **To start the datalogger:**

- 1 After creating a new datalogger file or selecting an existing one, the user can start the datalogging process.
- 2 From the datalogger viewer screen, press the "Test point" key **F4** and from the menu select an existing test point using the "Go to ..." option or "Create new ..." to create a new test point. If a new test point is created, user has to give it a name.

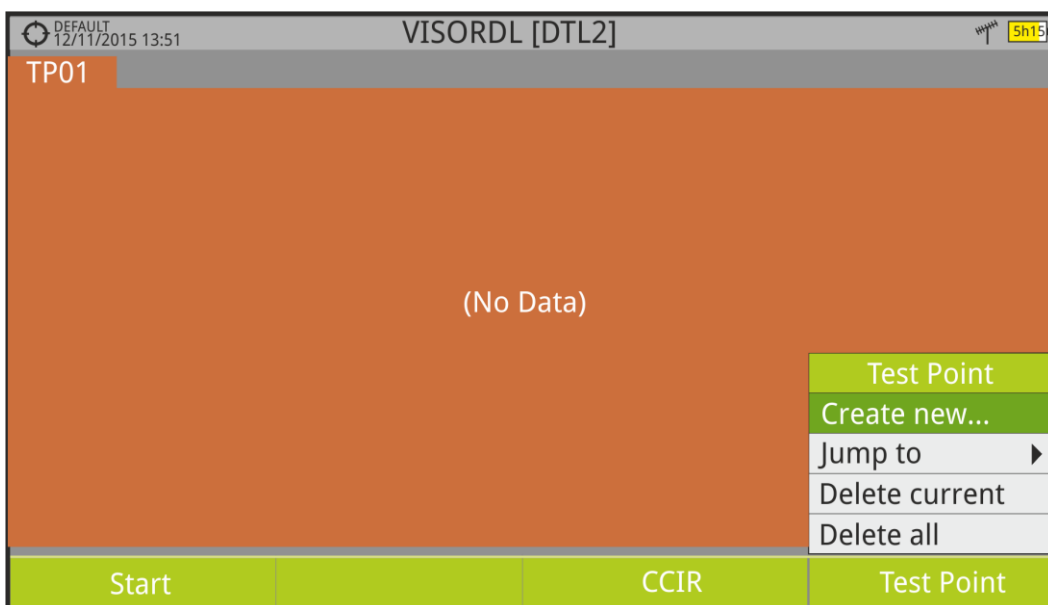

Figure 48.

- 3 Now datalogger is ready to start. Press the "Datalogger" key **F1** and select "Start". The datalogger process starts, during which all the measurements of all channels that are part of the datalogger and also the attenuation test are saved.
- 4 During datalogger, it catches the list of available services of all channels in the channel plan that are part of the datalogger (if this option was selected when creating the datalogger or if the "Datalogger PSI" option is enabled in the Preferences menu). If there is a change of channel plan during datalogger there will be a pause (if this option was selected when creating the datalogger). User can pause and resume the datalogger process at any time by pressing on the key "Pause" **F3**. If the "Attenuation Test" option was included when creating the datalogger, these measures will also saved.



- 5 At the end it saves the data and allows watching the results on screen by channel plan / attenuation test. To change the view of channel plan or attenuation test data press on the **F3** key. Data about terrestrial and satellite attenuation will appears as the option TER ICT and SAT ICT respectively.
- 6 It is also possible to download Datalogger files to a PC by the NetUpdate software (free download on the PROMAX website). Once downloaded, the program can generate reports with these files. This is not possible with the datalogger files exported directly to a USB (without using NetUpdate). Information of Service lists are in the XML files downloaded to the PC.

NOTE: To make a datalogger with the Field Strength tool, in first place user has to enable the field strength tool, and then to create a new datalogger file. The field strength data will be stored in this datalogger.

► **Description of Datalogger screen**

The following describes the datalogger screen:

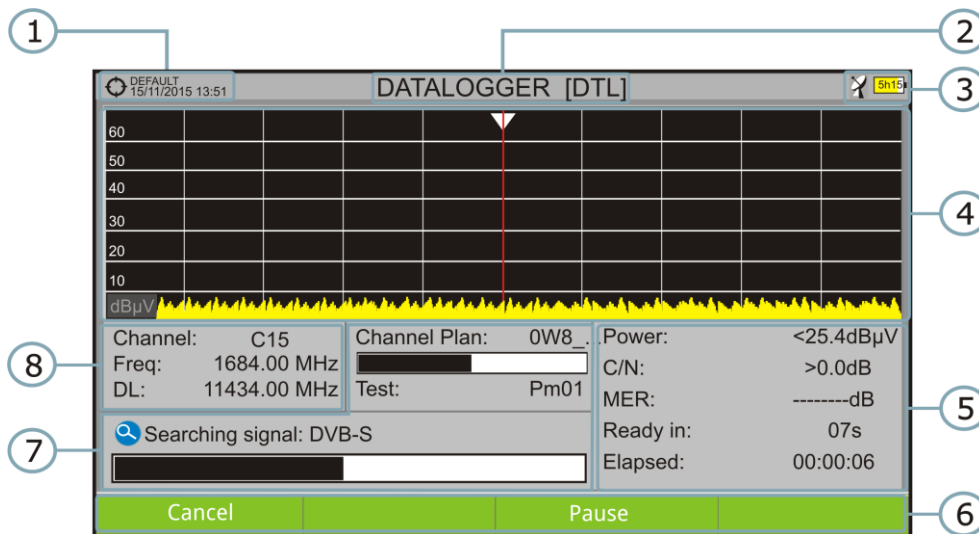

Figure 49.

- 1 Selected installation; date and time.
- 2 Current datalogger name.
- 3 Selected band; battery level.
- 4 Exploring the spectrum in real time.
- 5 Level/Power, C/N ratio, MER, time remaining to identify a channel, elapsed time since the start of the channel identification.
- 6 Softkey menus.



- 7 Current channel plan, progress bar in the current channel plan, selected test point.
- 8 Channel, frequency and Downlink.

► **Description of Datalogger viewer screen**

The following describes the display of data acquired:

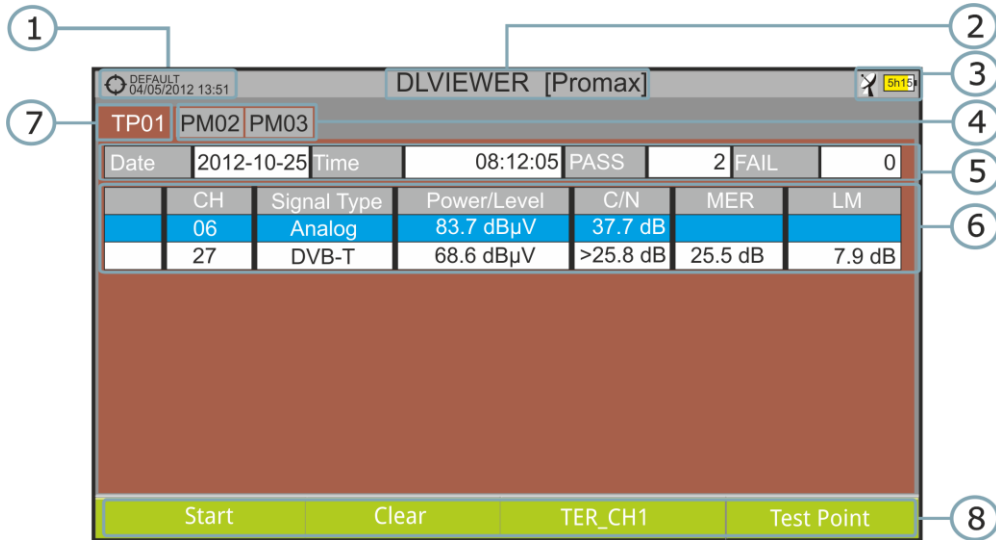

Figure 50. Channel Plan Datalogger viewer.

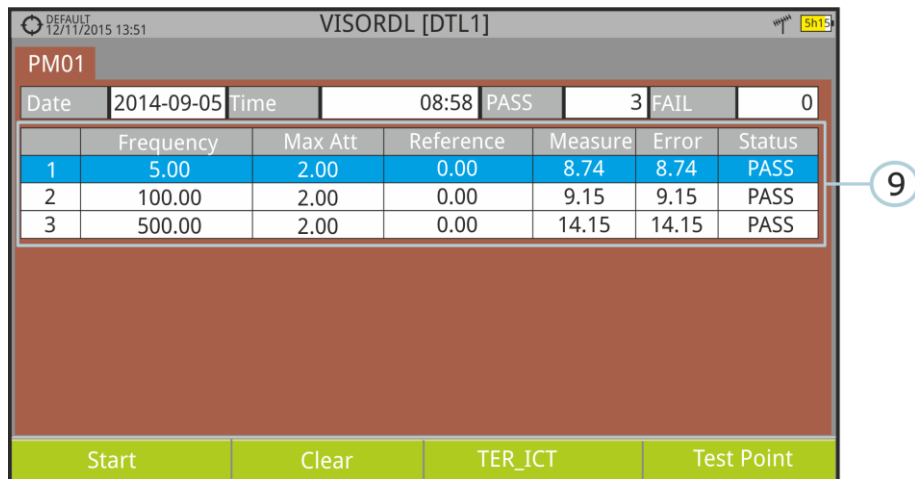

Figure 51. Attenuation test Datalogger viewer.

- 1 Selected installation; date and time.
- 2 Current datalogger name.
- 3 Selected band; battery level.



- 4 Tab identifying each test point.
- 5 Date and time when the datalogger was created. Number of channels locked (PASS) or not locked (FAIL).
- 6 Data table with measurement data for each channel. In order from left to right: Colour identifying if the channel has been locked (WHITE) or not locked (RED) channel; signal type; power/level; Carrier/Noise (C/N) rate; MER; Link Margin. Move the control key up or down to navigate along the measurement data. Press the **OK** key on a channel to display the signal parameters.
- 7 Tab identifying the displayed test point.
- 8 Softkey menus.
- 9 Table with the measurement data for each pilot signal in the attenuation test. In order from left to right: number of pilot signal, pilot signal frequency, maximum attenuation allowed, reference level value, level value at the test point, error and signal status.

7.4.3 Menu options

► Datalogger viewer menu options



Start: It starts the datalogger in the selected test point.



Clear: It deletes the data in the selected test point.



Channel plan

It displays a menu with the available channel plans to select the channel plan whose data want to be displayed. Channel plans available are those that have been selected during the creation of the datalogger.



Test Point

It contains four options:

Jump to: It allows selecting a test point.

Create New...: It creates a new test point.

Delete current: It deletes the current test point.

Delete all: It deletes all test points of the datalogger.



► **Datalogger menu options**



Cancel

It cancels the datalogger.



Pause

It pauses datalogger until the user resumes by pressing again.

7.4.4 Test & Go

"Test & Go" function inside the "Datalogger" tool allows the user to create a quick datalogger by creating automatically a new datalogger, a new test point and then starting it.

Datalogger parameters are set automatically based on:

- File name: DL [current band - terrestrial or satellite] [consecutive number]
- Channel plan: Current channel plan selected in the equipment.
- Test point: PM01
- No capture of services list.

If "Test & Go" is performed when using the "Attenuation test" tool, then the datalogger created will be specific to save attenuation test data.

7.5 Screen and Data capture (Export key)

7.5.1 Description

It captures what is displaying at time.



The capture can be an image, measurement data or both. This is set through the **Preferences** menu ("Export button" option).

Data capture is saved in a XML file with all data, measurements and text, that is on screen at this time. The image is saved in a PNG file.



Captures can be displayed on the equipment or also can be download and displayed through an external software.

7.5.2 Operation



► Settings

- 1 Press the "Management Installation"  key for one second to enter "Preferences" menu.
- 2 Go to the label "**Tools**" and select your option in "**Export button**". There are three options available: Screen Only, Data Only or Screen+Data. "Screen Only" saves the screen image in PNG format. "Data Only" saves measurement data on screen in a XML file format. "Screen + Data" saves both screen and data.
- 3 Once selected, press  to save changes and  to exit "Preferences".

► Capture

- 1 Press the **Export** key  for one second when on screen appears the screen to be captured.
- 2 A progress bar shows the progress of the capture process.
- 3 Then the virtual keyboard appears with the default name assigned to the file. The filename for the screen capture is automatically generated with the following code: capture mode (SP for Spectrum mode, TV for TV mode, ME for Measurement mode), capture channel (CHXX) and a consecutive number.
- 4 Edit the name if necessary (see section "Virtual keyboard"). Then press : **OK** to end the capture or : **Cancel** for cancellation.

► Display

- 1 To display the captured press on the **Installations Management** key .
- 2 Select the installation where the capture was done and press : **Manage**.
- 3 Press : **Filter by type**. Select the "Screen Shots" or "Data Captures" option. This will limit the list to the selected.
- 4 It appears a list of all the captures.
- 5 Move up or down to find the file to be displayed.
- 6 Leave the cursor on the file to be displayed. It appears a progress bar that lasts a few seconds, depending on the size. Then the capture appears.



- 7 To see the capture in full screen just press the **F4**: **Options** key and then on the menu press "View in Full Screen". To exit the full screen view press any softkey.
- 8 To delete or copy the capture to a USB stick, select the capture by pressing the **OK** key, and then select the appropriate option from the menu **F2**: **File**.
- 9 Captures can also be viewed on a PC, by downloading the whole installation file using the NetUpdate software (see the NetUpdate manual for more information).



7.6 Explore Channel Plan

7.6.1 Description

This option performs a scan of the selected channel plan. It detects where active signals are in a channel plan and in which channels of the current channel plan signal is received. With this information it explores these channels with signal, looking for any broadcast and identifying them.

7.6.2 Operation

Explore Channel plan tool is available for all signals.

- 1 Connect the **RF** input signal to the equipment.
- 2 Press the **Tools** key .
- 3 Select the **Explore Channel Plan** option.
- 4 The first screen of **Explore Channel Plan** appears.

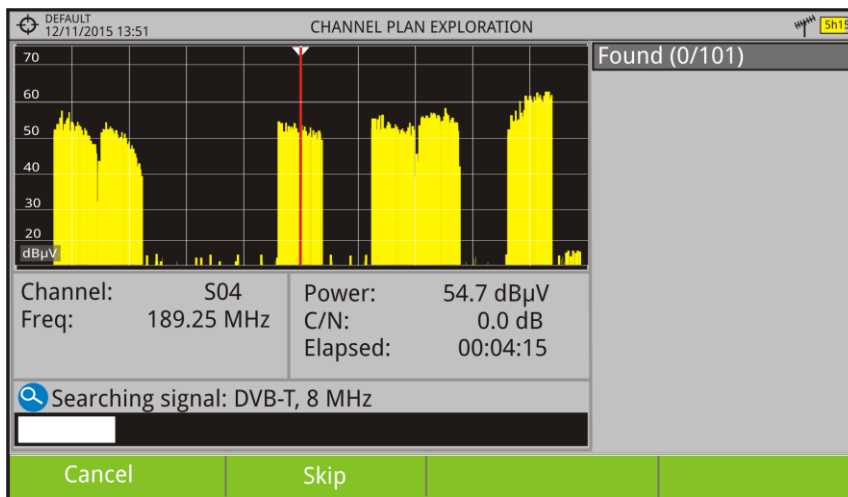

Figure 52.

- 5 After the exploration the following screen appears:.



► **Screen Description**

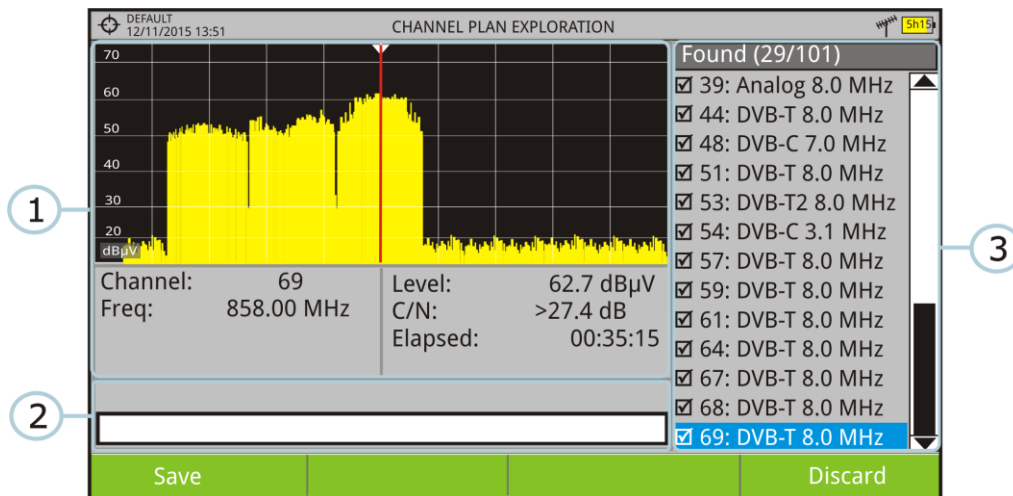

Figure 53.

The window is divided into three areas:

- 1 Spectrum and Measurement**

It shows the cursor scrolling through each of the channels of the channel plan. On the bottom of the screen the channel and frequency appears next to the Power/Level and the C/N ratio.
- 2 Progress Bar**

It shows the signal type detected and the scan progress in real time. At the end a box shows a message informing the exploration process has finished.
- 3 Channel plan**

At the end of the process it shows the channels that have been detected during the channel plan exploration. In parentheses shows the number of detected channels to total channels of the channel plan. When moving the cursor through the channels, the spectrum and measurement windows are dynamically updated for the selected channel.



7.6.3 Menu options

At the bottom are the function keys. They are detailed below.



Cancel (during the process):

This option appears only while performing the exploration process. It cancels the exploration before finish. When pressing, a confirmation message appears before cancelling.



Save (at the end of the process):

This option appears at the end of the exploration process. It saves the results obtained during the exploration. The name of the original channel plan is assigned to the new one by default and the user can modify the name using the virtual keyboard that appears prior to saving. The new channel plan is now available in the list of channel plans in the installation and can be used as any other channel plan. After saving it becomes the selected channel plan to work with.



Skip (during the process):

This option allows skipping the current channel and explore the next one in the channel plan.



Discard (at the end of the process):

This option appears at the end of the exploration process. It discards the results obtained from the exploration.



[Click here to watch this video: Channel plan exploration](#)

7.7 LTE Ingress test

7.7.1 Description

Long Term Evolution is a new standard for mobile networks. This mobile communication standard uses a frequency band close to the bands used by television. For this reason it can cause interferences.



This tool needs an external LTE filter that has to be placed in the RF input connector. By means this tool, this filter can be enabled to check if the quality of the TV signal reception improves, when much of the LTE band has been attenuated by the filter. With this tool you can measure the MER of a DTT channel, presumably affected by an LTE signal, and evaluate the effects of enabling an LTE filter.

To be clarified that these filters, internal or external, cannot completely remove the LTE band signals. Especially for the TV channels close to 790 MHz, where is the end for the current UHF. If we are close to a LTE station with low downlink channels, a filter cannot be a sufficient solution.



Other options to better mitigate the LTE signals can be considered, such as a change in the location of the TV antenna or a passive shield in the way between the two antennas (TV and LTE).

For more information, refer to annex "Digital Dividend".

7.7.2 **Operation**

The **LTE Ingress Test** input is available to all **DIGITAL TERRESTRIAL** signals.

► **Setting**

- 1 Press the "Installation manager" key for one second to access "Preferences" settings.
- 2 Go to "**Tools**" tab and edit the LTE filter settings.
 - **LTE Filter**
F.Min: Select the minimum frequency for the external LTE filter.
 - **LTE Filter**
F.Max: Select the maximum frequency for the external LTE filter.
- 3 Once selected, press  to save changes and  to exit "**Preferences**".



► Operation

- 1 Connect the external LTE filter between the signal and the RF input.
- 2 Tune the channel that is possibly affected by a LTE interference.
- 3 Press the **F3** key (Tools).
- 4 Select the **LTE Ingress Test** tool.
- 5 Screen shows a confirmation message. Press **F1** "Yes" if filter is connected or **F2** "No" if filter is not connected.
- 6 It starts to measure.
- 7 To change filter status (on/off) press again the key **F4** and on screen a message appears. Now connect/disconnect the LTE filter to the RF input and press again the **F1**:Ok key to start measuring.
- 8 The user can enable / disable the LTE measure by pressing the **F4**: **ON/OFF**. Remember to connect / disconnect the **LTE filter** to the RF input. Each time a LTE measure starts, the time counter will reset.
- 9 Check how to connect and disconnect the LTE filter affects the installation, by comparing the MER measure and the LTE band power.



[Click here to watch this video: What is LTE](#)



► **Screen description**

The following describes the **LTE** display:

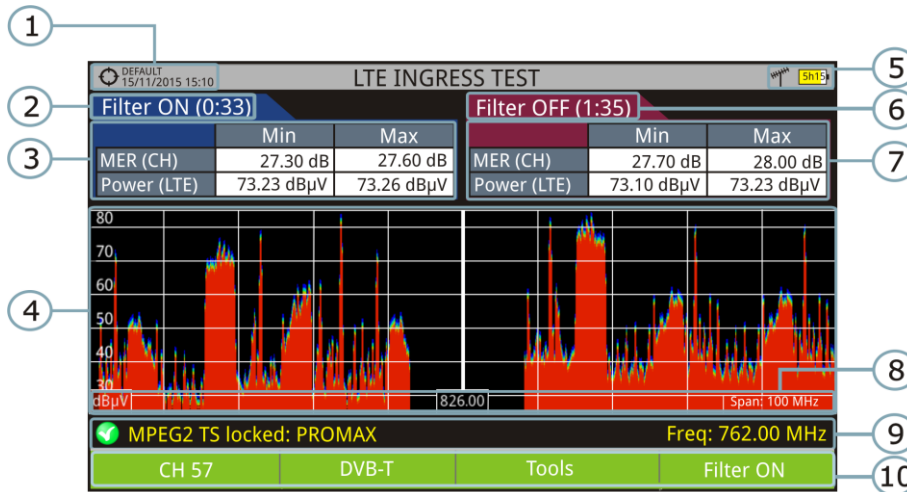





Figure 54.

- ① Selected installation; date and time.
- ② Elapsed time with filter enabled (ON).
- ③ Measurement with LTE filter enabled:
 - **MER:** Maximum and minimum MER for the TV channel tuned (the one probably affected by the LTE interference signal).
 - **LTE Power:** Maximum and minimum power for the LTE complete band, frequencies between minimum and maximum LTE filter frequencies.
- ④ LTE spectrum band, frequencies between minimum and maximum LTE filter frequencies.
- ⑤ Selected band; battery level.
- ⑥ Time elapsed with filter disabled (OFF).
- ⑦ Measurement with LTE filter disabled:
 - **MER:** Maximum and minimum MER for the TV channel tuned (the one probably affected by the LTE interference signal).
 - **LTE Power:** Maximum and minimum power for the LTE complete band, frequencies between minimum and maximum LTE filter frequencies.
- ⑧ Measurement units/centre frequency/Span.
- ⑨ Signal status (searching/locked/multiplex name).
- ⑩ Softkeys menus.



7.7.3 Menu options

On the bottom of the screen there are four menus accessible via the function keys.

- 
It displays channel/frequency and access the tuning menu. It allows selecting the channel plan and the channel where apply the LTE ingress test.
- 
It displays the selected transmission standard menu and accesses the signal parameters.
- 
It displays the Tools menu.
- 
It enables (ON) / disables (OFF) the LTE filter.

7.8 Field Strength

7.8.1 Description

This function allows the equipment to work as a field strength meter, measuring dB μ V per meter. To perform this type of measurement is needed to enter the calibration parameters of the antenna being used to receive the signal.

7.8.2 Operation

The **Field Strength** tool is available for all signals received by the **RF** input.

- 1 Connect the antenna to the **RF** input of the equipment.
- 2 Select a channel or frequency.
- 3 Press the **Tools** key.
- 4 Select the **Field Strength** option and in the drop down menu select **On**.
- 5 Select again the **Field Strength** option, now select the new option that appears, called **Configuration**.
- 6 In the configuration window enter the antenna calibration parameters, by hand or selecting one of the available antenna types (data of different antenna types should be imported by the user. Refer to the following section).



- 7 Now access the **Spectrum Analyser** or **Measurement** mode to check the field strength measure shown as FSM (dBµV/m). This measure replaces the power.

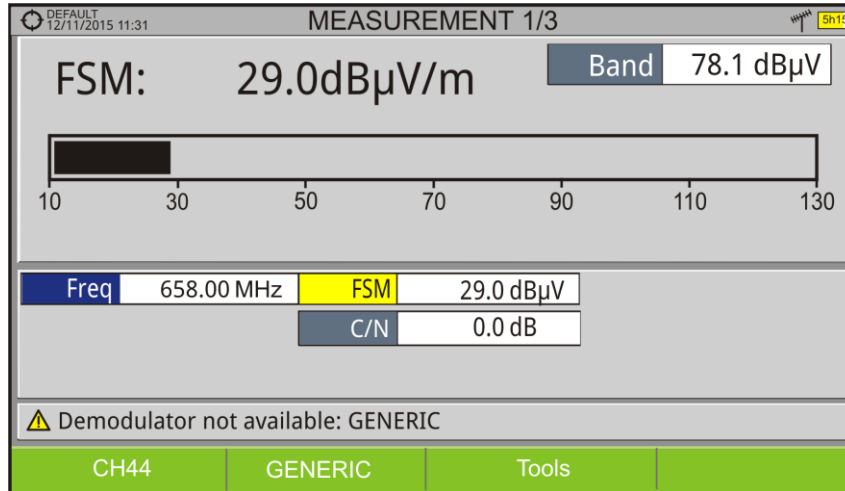

Figure 55.

- 8 To save FSM data, go to "Tools", select "Datalogger" and then "New" to create a new datalogger. Keep in mind that the "FSM" tool does not demodulate any signal, it only detects the transmitted energy, so it is identified as a GENERIC signal. For this reason only FSM data is saved for each channel (for more information refer to "Datalogger" chapter).
- 9 Once finished, return to the **Tools** menu and in the **Field Strength** option select **Off**.

WARNING: Some tools (Constellation, Echoes...) are disabled when the **Field Strength** option is enabled. Remember to turn off this option if you want to use these other tools.



7.8.3 Settings

The **Field Strength** configuration option allows the user to enter the correction factors for the antenna and cable used when measuring the field strength.

Field Strength Configuration

<div style="border: 1px solid gray; padding: 5px; margin-bottom: 5px;"> Antenna </div> <div style="margin-bottom: 5px;"> Type: Manual ▼ </div> <div style="margin-bottom: 5px;"> Factor (dB/m): 0.0 </div> <div> Detector Type: RMS ▼ </div>	<div style="border: 1px solid gray; padding: 5px; margin-bottom: 5px;"> Cable </div> <div style="margin-bottom: 5px;"> Type: Manual ▼ </div> <div> Loss (dB): 0.2 </div>
---	---

@762.00 MHz ==> -2.1(Level) + 0.0(k) + 0.2(loss) - 1.6(Z) = -3.5 dB μ V/m

Figure 56.

Data fields to be filled are:

► **Antenna:**

- **Type:** In this field the user can select the type of antenna between manual and any other type of antenna available. If you select the manual antenna, you must enter the correction factor by hand. If you select an antenna type then the correction factors associated with each frequency are applied. These data are defined in the antenna file imported by the user.
- **Factor:** This is the correction factor (K) for the antenna at the measurement frequency.
- **Detector Type:** (PEAK / RMS). It allows the user to select between maximum PEAK detector or RMS detector. The maximum peak detector is mainly used for analogue modulated signals, while the RMS option is the right choice for digital modulated signals.

► **Cable**

- **Type:** In this field contains the user can select the type of antenna between manual and any other type of cable available. If you select the manual cable, you must enter cable loss by hand.
- **Loss (dB):** In this field you must enter the estimated loss for the cable used to connect to the antenna.

In the bottom of the configuration window you can see the field strength in real time according to the current frequency and correction factors.



7.8.4 Creating and importing calibration tables

The user can import the antenna calibration data obtained from the manufacturer. There is a template (available on the download area at PROMAX website) that can be filled and imported into the equipment (this template has been created in an Excel file; the procedure explained below only works for the Excel 2007 version and above).

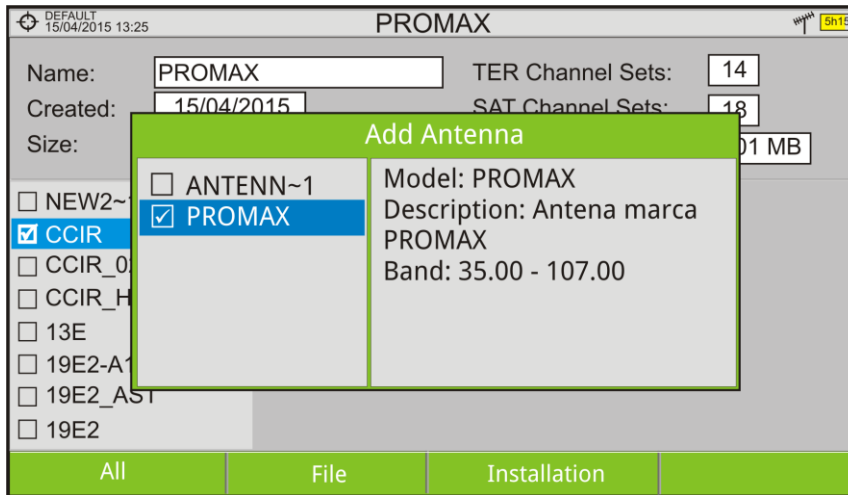

Figure 57.

Next are the steps to fill in the template data and import them to the equipment:







► **Generation**

- 1 Download the "Antenna XML Generator" template from the PROMAX website.
- 2 In the "Model" box enter the name by which the antenna will be identified (maximum 8 characters).
- 3 In the "Description" box, type a description to identify the antenna.
- 4 In the "Impedance" box select the impedance of the antenna between 50 and 75 ohms.
- 5 In the "Height" box enter the antenna height in meters.
- 6 Now fill the calibration table of the antenna with the K factor according to frequency.
- 7 When filling the table does not change the units.





- 8 Extend or contract the calibration table to the number of filled lines.
- 9 After filling the calibration table, go to option "Save As -> Other Formats."
- 10 In the window that appears, edit the file name in "File name".
- 11 In the drop down menu "Save as type" select the "XML Data" option. Then click "Save."
- 12 If a warning message shows up, click "Continue".
- 13 Now the file is already generated with the selected name and the extension ".xml".
- 14 Now just import it to your equipment and load the calibration table of the antenna in the installation.

► Import

- 1 Copy the generated file on a flash drive and connect it to the mini-USB port using the supplied cable.
- 2 Press the **Installation Manager** key .
- 3 Press the  "Tools" key.
- 4 Select "Import from USB" option.
- 5 The Import Files window appears. Select the generated file and press the  "Import" key.
- 6 Press the **Installation Manager** key , select the installation to which you want to add the antenna calibration table and press the  "Manage" key.
- 7 Press  key: "Installation" and select the "Add Antenna" option.
- 8 Select the antenna to be added and OK.
- 9 The antenna calibration table is now added to the installation.
- 10 Now this antenna will be available in the type of antenna field in the configuration menu of the "Field Strength" tool.



► Remove

- 1 Press the **Installation manager** key .
- 2 Press : **Tools** key.
- 3 Select "**Installed Antennas**" option.
- 4 Check the antenna to remove.
- 5 Press : **Remove** key.

7.9 Task Planner

7.9.1 Description

The **Task Planner** allows the user to set-up a task list, selecting when to start, a repetition rate and other parameters. The equipment can be switched off after setting all parameters and it will wake-up, at the required time, to perform the scheduled tasks.

7.9.2 Operation

The **Task Planner** tool is available to run screenshots and dataloggers.

- 1 Press the **Utility** key.
- 2 Select the **Task Planner** option to access the Task Planner window that shows a list of scheduled tasks. In the right column and next to each task there is its status: if the date of the next execution appears then the task is pending; if "finished" appears then the task has been executed; if nothing appears then the task has not been scheduled.

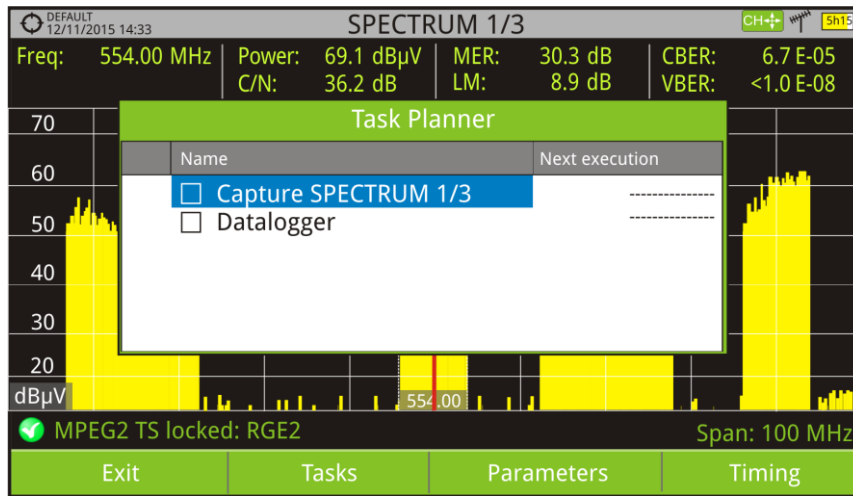

Figure 58.

- 3 To add a new task press **F2**: **Tasks** and select the **"Add"** option. It deploys a menu with two options: Capture and Datalogger.

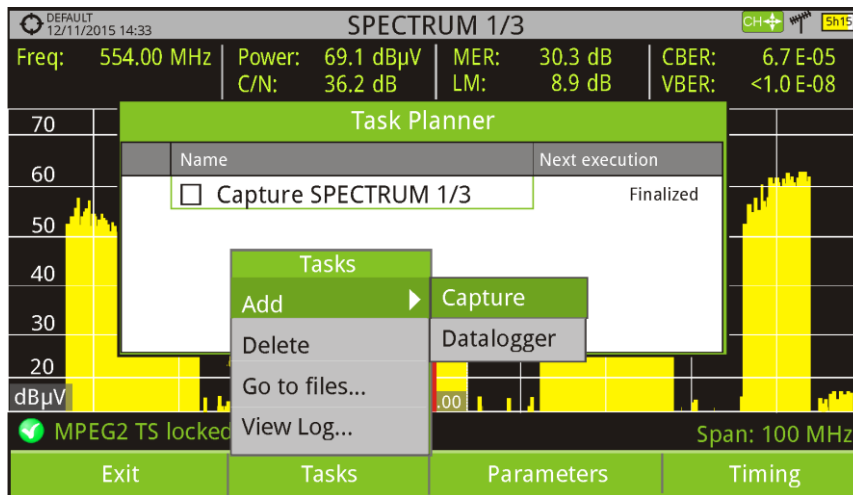

Figure 59.

- 4 The **"Capture"** option performs the capture task. The user can select the screen and type of capture. The screen options include any view in the three modes: Measurement, Spectrum or TV. The options for type of capture are: screen only, data only or screen+data (for details about capture refer to "Screen and data captures (Export button)" section).

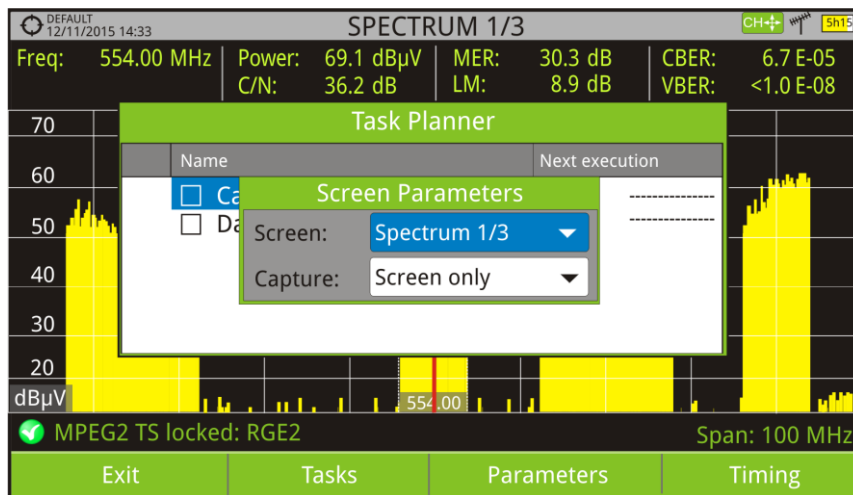



Figure 60.

- 5 The "**Datalogger**" option performs the datalogger task. The user must first select the datalogger from those available for the current installation (for details about datalogger read "Datalogger" section).
- 6 After selecting the type of task, check the box next to it and press **F4:Timer** to schedule the time to execute the task (see next section for details about the timer).
- 7 When saving the timer for the task, the upper right corner shows an icon of a clock  indicating that the equipment has tasks pending to execute.

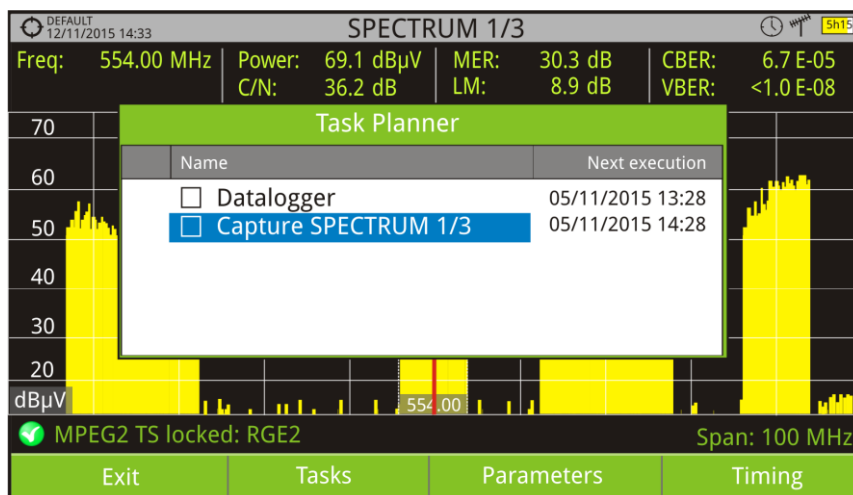





Figure 61.

- 8 To change any parameter of the task, check the box next to the task and press **F3: Parameters**.



- 9 To delete a task, check the box next to it and in : **Tasks**, press "**Delete**".
- 10 After setting up the tasks press : **Exit**. Since this moment the timer for task execution starts.
- 11 When the task is finished, the user can access the data through "**Go to file ...**" option in : **Tasks**. It will take you directly to the management installation window where the data for each installation are stored.
- 12 Once the task is completed, user can access a short log for each programmed task, just to know if each task has been successfully completed or to indicate if something prevented its execution. To access this function, from **Task Manager**, press : **Task** and then "**View Log...**".

NOTE:

- The equipment can be turned off after task planning as it will automatically turn on when the time to task execution comes.
- Two tasks cannot be executed simultaneously.
- It is recommended that the datalogger selected have not enabled the option to pause between channel plans, since in that case the process would stop during the execution of the task.
- The filename for the screen capture is automatically generated with the following code: capture mode (SP for Spectrum mode, TV for TV mode, ME for Measurement mode), capture channel (CHXX) and a consecutive number.



7.9.3 Timer

The timer window contains several options for task scheduling.

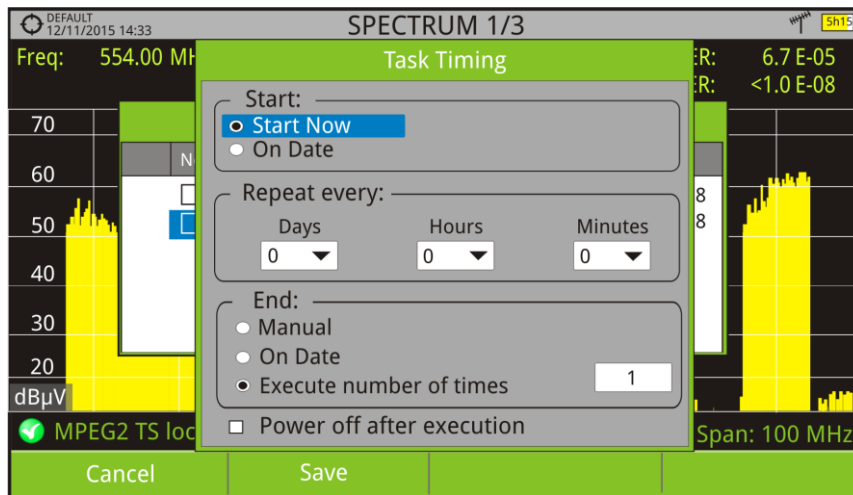

Figure 62.

► Start

- **Start Now:** The task begins immediately after leaving the task planner.
- **On date:** The user selects the start date of the task (day / month / year) and (hour: minute).

► Repeat every

The task repeats each time cycle (days, hours and minutes).

► Stop

- **Manual:** The user finishes the task.
- **On date:** The user selects the stop date for the task (day / month / year) and (hour: minute).
- **Repeat a number of times:** The task execution ends after the number of times set.

► Turn off after execution

By checking this option, the equipment turns off after the execution of the task.



7.10 Service Recording



7.10.1 Description

The equipment records in real-time one digital service from the transport-stream received that is shown on screen. This service is saved directly on the USB flash drive memory connected to the equipment. Afterwards that record can be played on a PC with a video player.

7.10.2 Operation

The **service recording** tool is available for all **DIGITAL** signals (except for DAB digital radio services).

To access this tool:





- 1 Connect the signal to the equipment input.
- 2 Tune the channel and select the service to record.
- 3 Connect the adapter cable to the mini-USB port on the equipment and then connect a USB memory.
- 4 Press the F3 key: Tools and select the PVR option.
- 5 The screen to record the service appears.
- 6 Start the recording by pressing the **RECORD**  key.
- 7 End the recording by pressing the **STOP**  key.
- 8 The recording file is saved in the PVR folder created by the equipment in the USB memory.
- 9 The file name is PVR plus a consecutive number and the file extension is TS.
- 10 The file can be played in a computer with a media player like VLC. This file cannot be played from the meter itself.



► **Screen description**



Figure 76.

- 1 Installation selected; date and time.
- 2 Icons from left to right: recording; USB connected; selected band; battery level.
- 3 Recording Service.
- 4 Window with information about the record file like size and date creation.
- 5 Bar graph showing free memory space.
- 6 Size of the recording service.
- 7 Window with information about the service being recorded: recording length, maximum bit rate, channel service recorded and free available memory.
- 8 Control Keys:
 -  : Recording
 -  : Stop
- 9 Menu options:
 -  : **Exit** Exits the tool.
 -  : **Delete** Deletes the selected record file.

► **Joystick left / right:** Navigation between the control keys.

If no tuned service, the record button will be disabled.





8 INSTALLATIONS MANAGEMENT

8.1 Description

The Installations Management is a program embedded in the equipment that allows the user to easily create a file (installation) to individually store and manage data for each installation. Measurements, channel plans, screenshots and any other data associated with the installation will be stored in the folder corresponding to that installation. These measures can then be displayed and downloaded to a PC.

If the user does not create any file installation, the equipment stores measurements in the installation file that is preinstalled by default (named "DEFAULT").

8.2 Operation

- 1 To access the Installations menu press the  key.
- 2 It shows up a window with a list of all available installations. On the softkeys appears the options to manage these installations.
- 3 To exit the list of installations press the key .

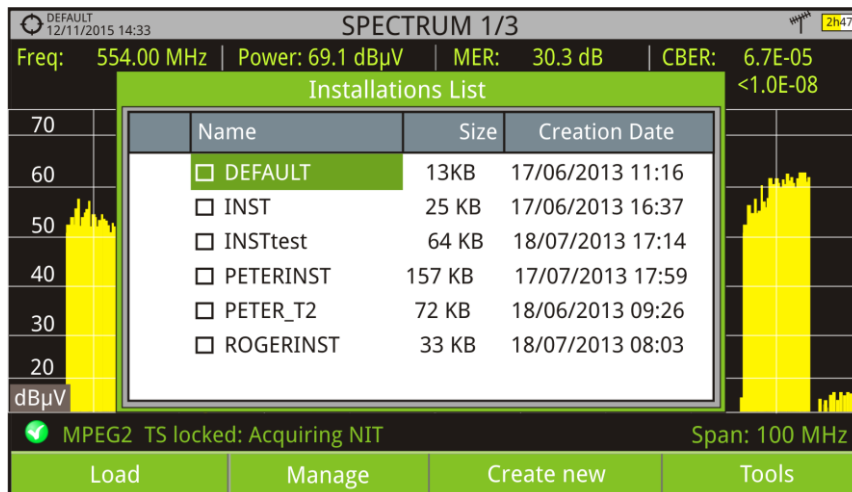

Figure 63.



There are the following options:

- **Load** F1: It loads the selected installation. To select a installation from the list, place the cursor on the installation and press the **OK** key, then press "Load" F1 to load it. Once loaded, the name of the installation appears on the upper left corner of the screen, accompanied by the symbol , that means that is the current installation. All measurements, screenshots, channel plans and other data since this moment will be stored in the current installation.
- **Manage** F2: It opens a window that displays all data of the current installation and from where they can be edited, changed or view (more details in "Installation Management" section).
- **Create new** F3: It creates a new installation with the data introduced by the user (more details in "New installation" section).
- **Tools** F4: It shows up a menu with some tools to use with the installations (see "Tools" section).

8.3 Installation Management

In the list of installations, press on the option **Manage** F2 to access to the **Installation manager** screen:

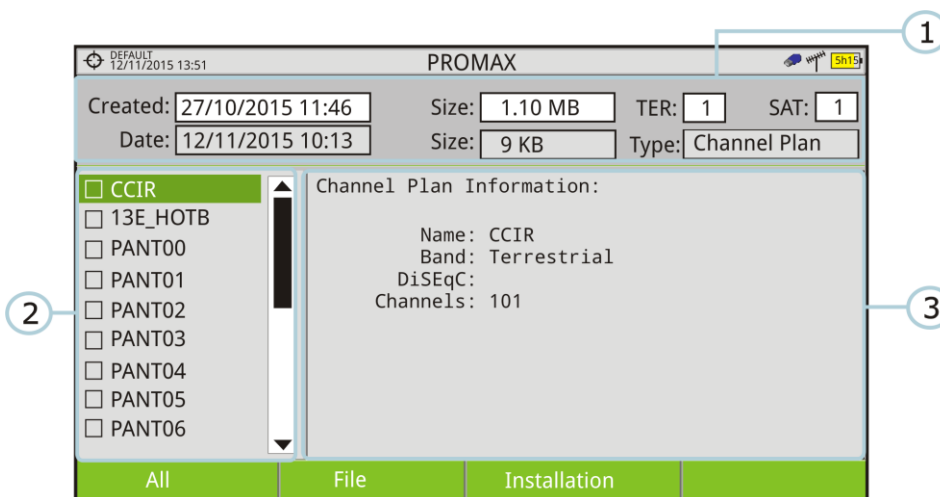

Figure 64.



The DEFAULT installation is the installation preinstalled on the equipment. It is like any other installation and it can load channel plans, DiSeqC programs, etc. The DEFAULT installation can not be deleted or renamed.

The window is divided into three areas:

1 General data

- The first line shows general information about the installation. The second line shows information about the selected file. Data fields are:
 - ▶ **Created:**
Date and time the current installation was created.
 - ▶ **Size:**
Data size of the current installation.
 - ▶ **TER:**
It shows the number of terrestrial channel plans in the installation.
 - ▶ **SAT:**
It displays the number of satellite channel plans in the installation.
 - ▶ **Date:**
Date and time when the selected file was created.
 - ▶ **Size:**
Data size of the selected file.
 - ▶ **Type:**
Data type of the selected file.

2 List of files area

It shows all types of data files in the selected installation. These can be: screenshots, channel plans, dataloggers, DiSeqC commands, data captures, service databases and antennas.

To move along this file list move the control keys up or down.

Any of these files can be selected or deselected by pressing the **OK** key.

3 Display area

It is the area where data file description is displayed. The file data is displayed only if the cursor is placed for a moment on the file name.

For a screenshot, it displays a thumbnail of the full screen, as captured.



In the remaining cases, it only shows some data description of the file type.

If there is any extra option associated with the file, it will appear on the  key.

► **Menu options**

The installation manager menu has four options linked with the softkeys. They are described below:



Filter by type

It shows all available file types in the current installation and the amount of them between brackets. User can filter by file type. The selected file type will be the only one available in the list of files. Available file types are: screenshots, channel plans, dataloggers, DiSeqC commands, data captures, service databases and antennas (or all).



File

- **Mark All:**
It marks all files on the list of files area.
- **Unmark All:**
It deselects all files on the list of files area.
- **Delete:**
It deletes all selected files on the list of files area.
- **Copy to USB:**
It saves selected files on the list of files area to an USB stick connected to the equipment.

If the name of the file to be copied is greater than 8 characters the system cuts it. If the file name is cut and matches with another one, then it is added a number to the name to make them different. For instance, 2 files with similar names, like FILENAME01 and FILENAME02 both files will be correctly copied with names FILENA~1 and FILENA~2.

To keep the file names with more than 8 characters it is recommended to export the complete installation using the "Export to USB" option (see "Tools" section).

The Datalogger files copied to the USB cannot be used to generate reports by the NetUpdate program. To do this the datalogger files must be exported directly through the NetUpdate program (see the NetUpdate user's manual for details).



F3

Installation

▶ **Add Channel Plan:**

It opens a window to add a channel plan, terrestrial or satellite, to the current installation.

▶ **Add Antenna:**

It allows the user to add an specific antenna among the ones available. To import an antenna refer to "Field Strength" section in chapter "Tools".

▶ **Add DiSEqC Program:**

It allows the user to select and add to the current installation any DiSEqC program available in the equipment.

F4

Options

This options appears if there is any extra option associated with the file type.

▶ **See full screen:**

This option only appears if user selects an image in the list of files. It displays the selected image full screen.

▶ **DiSEqC program:**

This option only appears if a satellite channel plan is selected in the list of files area. It allows the user to add a DiSEqC program to the selected satellite channel plan from the list of DiSEqC programs available for the current installation.

▶ **Open file**

This options appears if the file type selected is datalogger or data capture. In case of data capture (if the capture was done in the Spectrum Analyser mode) shows the spectrum reference.

To get out from the Installation manager press any key to access MEASUREMENT, SPECTRUM or TV mode.



[Click here to watch this video: Installation manager](#)





8.4 Create a new installation

In the list of installations, when selecting the option **Create New**  it runs the installation wizard that helps to create a new installation:

- 1 During the process, the user has the option to edit the default name assigned or import data from another installation.
- 2 The user can select the channel plans (terrestrial and satellite) that will be used in that installation. At least one for each band has to be selected.
- 3 For satellite channel plans the user can select the Diseqc commands associated to the installation and also the satellite band (Ku-Ka or C band) and the frequencies of the LNB Oscillator.
- 4 During the creation process the softkeys function are: Next (it goes to the next step), Previous (it goes to the previous step) or Cancel (it cancels the process).
- 5 When finish, the new installation created will be the current installation.

8.5 Tools

In the list of installations, when pressing the **Tools**  option it shows a menu with some options to edit the installation files:

- ▶ **Mark All:**
It selects all installations in the list of installations.
- ▶ **Unmark All:**
It deselects all installations in the list of installations.
- ▶ **Archive:**
It compresses (using the ZIP algorithm) the selected installations to save more space. A zipped installation shows a box icon  at the left side in the list of installations. A zipped installation can be loaded as anyone else, but the load time can be slightly higher because previously it is unzipped automatically. Once the installation is unzipped the user must re-zip it if necessary. To transfer an installation file from the equipment to a PC, it must have been previously zipped.



- ▶ **Delete:**
It deletes the selected installations and all the files associated to them. The DEFAULT installation cannot be deleted.
- ▶ **Rename:**
It edits the name of the installation selected in the list of installations. The installation by default DEFAULT cannot be renamed.
- ▶ **Export to USB:**
It saves the installations files selected in the list of installations to an USB stick connected to the instrument. The installation file is exported in zip format.
- ▶ **Import from USB:**
It imports installation files from a USB stick connected to the equipment. It has to use the same folder structure that is generated when exporting to USB.
- ▶ **Installed Antennas:**
It allows user to remove antennas in the installation.



8.6 Importing Data from USB

The data import tool allows the user to import data files from an USB flash drive to the equipment.

Data available to be imported are:

- **Installations.**
- **Channel Plans.**
- **Antennas.**

▶ **Operation:**

- 1 Copy the file to be imported on a flash drive and plug it into the mini-USB port using the supplied cable. The file must be in the proper format so the system can recognize it.
- 2 Press the **Installation Management** key .
- 3 Press the  key "**Tools**".
- 4 Select the "**Import from USB**" option.
- 5 The Import Files window appears. Select the file and press the  key: "**Import**".

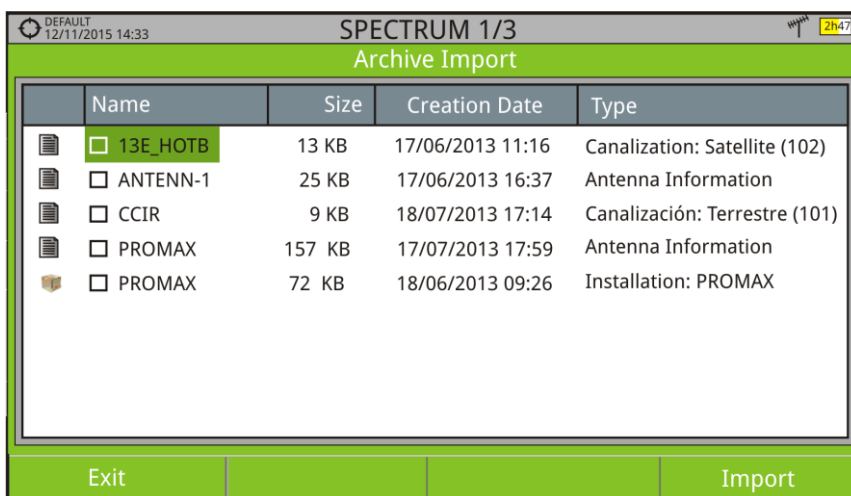

Figure 65.

- 6 If the file import is successful then a window shows a confirmation message.



9 CONNECTING TO EXTERNAL DEVICES

The **HD RANGER UltraLite** can interact with external devices, sharing information through its interfaces. Connection types are:

- 1 Input/output data interface via mini-USB connector to USB memory or PC.
- 2 DiSEqC, SCD/EN50494 standard (also known as SatCR) and SCD2/EN50607 standard (also known as JESS) interface via **RF** connector.

Next is described each of these interfaces and their interaction with external devices.

9.1 Mini-USB connector

The equipment has a female mini USB port that uses a USB media specific protocol called "On-the-Go" (OTG abbreviated). This type of communication allows the equipment to work in two different ways depending on the device connected to the USB port: as a server (host) or device. More often, the **HD RANGER UltraLite** will work as a host when connecting a USB memory and as device when connecting to a computer. This feature makes the equipment in a much more versatile tool.





9.1.1 Connecting the **HD RANGER UltraLite** (host) to an USB memory (device)

This connection allows the user to copy files (screenshots, channel plans, dataloggers, DiSEqC commands and others) and export/import installations from the equipment to the USB and vice versa.



► **To copy some select data from the installation:**

- 1 Connect the CC-045 cable (USB (A) Female - Mini USB (A) Male) to the mini-USB socket ([see figure 5](#)) of the equipment.
- 2 Connect the USB stick to the female port of the cable.
- 3 USB icon should appear on the top right corner of the equipment. This icon indicates that an USB stick has been detected at the port.
- 4 Press the Installations key  and select check the installation to download some of its data.





- 5 Press the key : Manage to access the data of the selected installation.
- 6 Press : Filter by type to select the type of list to view (list of all the files, only screenshots, only channel plans, only dataloggers or only DiSEqC commands).
- 7 Select the files from the list to be copied on the USB memory stick, by pressing the **OK** key or by pressing : File and selecting "Mark All" (it selects all files on the list displayed).
- 8 Once files are selected press : File and select the "Copy to USB" option. This option is enabled only if it detects that there is an USB connected to the equipment and if any file has been selected.
- 9 It shows a progress bar and a message informing that files are being copied to the USB.
- 10 When finish you can remove the cable with the USB stick memory directly from the equipment and connect it to a computer to view the files copied.
- 11 Default files are copied to the root directory of the USB memory. Screenshots appear with PNG extension and data with XML extension.

► **To export one or more complete installations:**

- 1 Connect the CC-045 cable (USB (A) Female - Mini USB (A) Male) to the mini-USB socket ([see figure 5](#)) of the equipment.
- 2 Connect the USB stick to the female port of the cable.
- 3 USB icon should appear on the top right corner of the equipment. This icon indicates that an USB stick has been detected at the port.
- 4 Press the **Installations** key  and check the installations to export.
- 5 Press the key : **Tools** and select **Export to USB**.
- 6 A progress bar and a message indicates that the files are being copied to the USB. The files are copied to the root directory of the USB in ZIP format.
- 7 When finished, the cable can be extracted directly with the USB stick and connect it to a computer to display the copied files.
- 8 Unzip the installation file to access the data.



► **To import one installation:**

- 1 Connect the CC-045 cable (USB (A) Female - Mini USB (A) Male) to the mini-USB socket ([see figure 5](#)) of the equipment.
- 2 Connect the USB stick to the female port of the cable.
- 3 USB icon should appear on the top right corner of the equipment. This icon indicates that an USB stick has been detected at the port.
- 4 Press the **Installations** key  and check the installation to export.
- 5 Press de key : **Tools** and select **Import from USB**.
- 6 A dropdown menu shows the installations identified in the USB memory. An installation can be imported if it has the same folder structure than when exporting. Select the installation to import from those available.
- 7 The import process starts. If the name of the installation matches with an existing one, it gives a warning before import.

9.1.2

Connecting a computer (host) to the *HD RANGER UltraLite* (device)

This connection allows the communication between the equipment and a computer via an USB cable or using the program NetUpdate of PROMAX.

NetUpdate program can be downloaded for free from the PROMAX website.

Connect the equipment to your computer using the cable CC-041 (mini USB male - USB male) supplied with the equipment.

For more information about the NetUpdate program, see the user's manual, which is available on the PROMAX website.



[Click here to watch this video: Generating a measurement report](#)





[Click here to watch this video: Creation of a channel plan](#)





9.2 RF Connector

9.2.1 DiSEqC commands

The RF connector allows controlling an antenna using DiSEqC commands. DiSEqC (Digital Satellite Equipment Control) is a communication protocol between the satellite receiver and the installation accessories of satellite (switches, LNBS, etc.) proposed by Eutelsat, in order to standardize the diversity of switching protocols (13 to 18 V, 22 kHz) and meet the needs of the installations for the reception of digital TV.

- 1 Connect the RF cable ([see Figure 6](#)) to the RF connector for the input signal of the equipment.
- 2 Press the **Spectrum** key  to access the spectrum analyser mode.
- 3 Press the **Settings** key  and select the satellite band.
- 4 From the **Settings** menu, select the polarization (horizontal/vertical) and the satellite band (high/low).
- 5 If necessary, enable the **Supply output** and select the supply voltage for the LNB.

NOTE: When tuning by channel is selected, polarization, satellite band and supply output cannot be changed, because these parameters are determined by the channel plan.

- 6 Select the option **DiSEqC mode**.
- 7 Two new functions appear on the softkeys: **Commands**  and **Programs** . DiSEqC programs appear classified in categories or folders.
- 8 Select the command or program and press the **OK** key to send it to the antenna. These commands or programs allow the user to control an antenna (for more information about DiSEqC commands and programs see [Annex 3](#)).



9.2.2 SCD/EN50494 (SatCR) commands

By means of function SCD/EN50494 (international standard, also known as SatCR) it is possible to control the devices of a TV satellite installation that are compatible with this standard, which allows to concentrate downlink frequencies (slots) by an only cable. By this way each user using a slot can tune and decode any signal present in the satellite.

- 1 Connect the RF cable (see [Figure 6](#)) to the RF connector for the input signal of the equipment.
- 2 Press the **Spectrum** key to access the Spectrum analyser mode.
- 3 Press the **Settings** key and select the satellite band.
- 4 Select the polarization (horizontal/vertical) and the satellite band (high/low).
- 5 If necessary, enable the **Supply output** and select the supply voltage for the LNB.
- 6 In the option SCD/EN50494, select ON to enable it. It appears the icon at the top right corner.
- 7 Also in the SCD/EN50494 option, select **Configuration** to access SCD/EN50494 parameters.

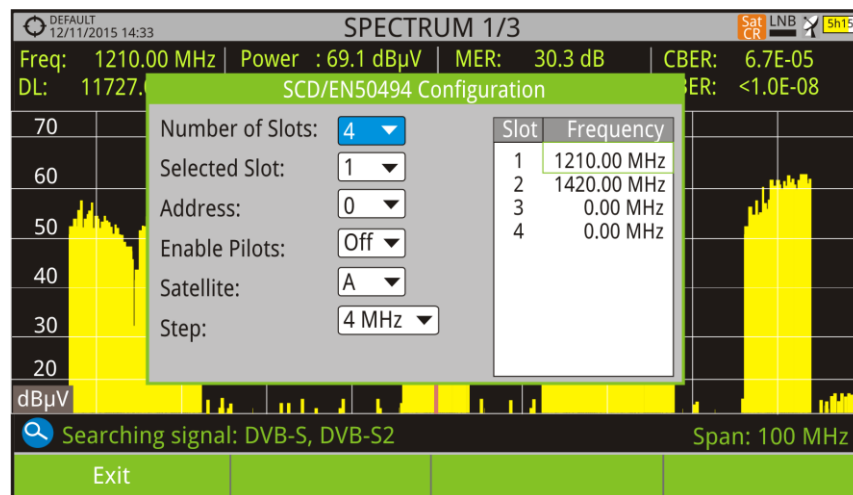

Figure 66. SCD/EN50494 command screen.



The configuration window shows the options that user can modify: number of slots, slot selected, device address, pilot signal activation (when activating the SatCR device located in the headend, it emits a pilot signal with constant level for each downlink frequency to identify available channels), selected satellite and frequency step. For each type of slot number unit there is a list of independent frequencies to select. The user may have separate frequencies for 2, 4 or 8 slots units and these values are not lost when switching from one type to another.

- 8 Once **SCD/EN50494** is configured, the user can select the slot by the "Tuning" key.

9.2.3 **SCD2/EN50607 (JESS) commands**

Through the SCD2/EN50607 (international standard, also known as JESS) function is possible to control the devices of a TV satellite installation that are compatible with this standard. This technology has two main functionalities: one for configuring headends, and another for configuring sockets. This technology requires bidirectional DiSEqC capabilities. Although this equipment does not have such capability, a simpler way to blind configure units has been implemented, without any confirmation other than spectrum reference. For information about JESS technology, developed by JULTEC, refer to its website (<http://jultec.de/>).

- 1 Connect the RF cable (see Figure 6) to the RF connector for the input signal of the equipment.
- 2 Press the **Spectrum** key to access the spectrum analyser mode.
- 3 Press the **Settings** key and select the satellite band. Again from the **Settings** menu, select the polarization (horizontal/vertical) and the satellite band (high/low).
- 4 If necessary, enable the **Supply output** and select the supply voltage for the LNB.

NOTE: When tuning by channel is selected, polarization, satellite band and supply output cannot be changed, because these parameters are determined by the channel plan.

- 5 In the option **SCD2/EN50607**, select ON to enable it. It appears the JESS icon at the top right corner of the screen.



- 6 Now the **SCD2/EN50607** option shows a new menu. Select **Configuration** to access the configuration parameters. The user can select the power, central frequency, tone beacon and satellite for each band. The user can also select the number of user bands and the available satellites through the option "Configuration" on key **F2**.

UB	PoWER	Central Frequency	Tone Beacon	Satellite
UB_1	Enabled	1076 MHz	Off	A
UB_2	Disabled	1178 MHz	Off	A
UB_3	Disabled	1280 MHz	Off	A
UB_4	Disabled	1382 MHz	Off	A
UB_5	Disabled	1484 MHz	Off	A
UB_6	Disabled	1586 MHz	Off	A
UB_7	Disabled	1688 MHz	Off	A
UB_8	Disabled	1790 MHz	Off	A

Figure 67.

- 7 Also from option **SCD2/EN50607**, select **Socket** to access the configuration of socket. The user can select the user bands that should be enabled for the socket and to send them to configure the socket.

SOCKET

Please select user bands should be activated for this socket.
Please press 'Send' to set the socket

UB_1 UB_2 UB_3 UB_4 UB_5 UB_6 UB_7 UB_8
 UB_9 UB_10 UB_11 UB_12 UB_13 UB_14 UB_15 UB_16
 UB_17 UB_18 UB_19 UB_20 UB_21 UB_22 UB_23 UB_24
 UB_25 UB_26 UB_27 UB_28 UB_29 UB_30 UB_31 UB_32

Searching signal: DVB-S, DVB-S2 Span: 100 MHz

Figure 68.

- 8 Once it is configured, the user, through the **F1** key "Tuning" can select the user band.

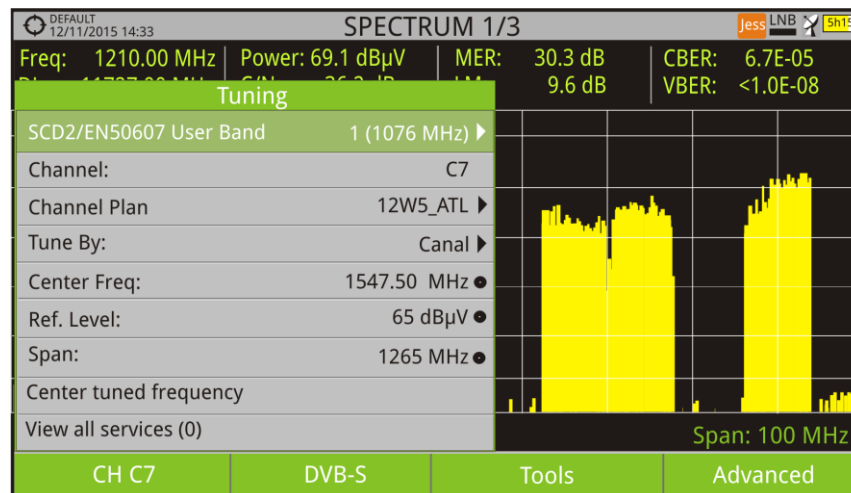

Figure 69.

- 9 User frequency tuned is stored for each User band (UB) and it is restored each time the multiswitch is being configured.

NOTE: When not detecting any SCD2 receiver, the function enters in a more basic mode, allowing sending configuration commands even with nothing connected. In that mode, the user can debug cable issues or even SCD2 units problems.

NOTE: For special devices that use non-standard commands, it has been added a channel bandwidth for every user band.



10 SPECIFICATIONS

10.1 General Specifications

► Inputs and Outputs

Parameter	Value	Additional data
RF Input		
Connector Input type	F male	75 Ω
Maximum Signal	130 dB μ V	
Maximum Input Voltage	50 V rms	DC to 100 Hz; powered by the AL-103 power charger
	30 V rms	DC to 100 Hz; not powered by the AL-103 power charger
	140 dB μ V	Protected up to 30 seconds
Sound Input/Output		
Outputs	Built-in speaker	
USB Interface		
Connector	mini-USB	
Characteristics	OTG (On-the-go)	
	Mass storage host	Can read/write on flash drives
	Serial port emulation	
	USB CDC	Communications Device Class
Monitor Display		
Monitor	7" TFT	Transmissive colour dot matrix type
Aspect ratio	16:9	
Dot Format	800 x 480 dots	(R,G,B)(W) x (H)
Brightness	350 cd/m ²	
External Unit Power (through the RF input connector)		
Terrestrial Supply	External, 5, 12 and 24 V	
Satellite Supply	External	Up to 500 mA
	13 V	Up to 500 mA
	15 V	Up to 500 mA
	18 V	Up to 500 mA
22 kHz signal Voltage	0.65 V \pm 0.25 V	Selectable in Satellite band
22 kHz signal Frequency	22 kHz \pm 4 kHz	Selectable in Satellite band
Maximum Power	At least 6 W for 13, 15, 18, 24 V	If you select 5V, the maximum power shall not exceed 2.25 W (450 mA)
DiSEqC Generator	According to DiSEqC 1.2 standard	DiSEqC is a trademark of EUTELSAT

► Mechanical Features

Parameter	Value	Additional data
Dimensions	245 x 177 x 39 mm	WxHxD
Weight	1.4 kg	1.6 kg (with carrying bag)
Size	1691 cm ³	



► **Power Supply**

Parameter	Value	Additional data
Internal battery	7.4 V; 6.6 Ah	Li-Ion battery
Battery Operation Time	> 2,5 hours in continuous mode	No EXTERNAL supply active
Recharging time	3 hours up to 80%	Instrument off
External Voltage	12 V DC	Using only PROMAX supplied accessories
Consumption	50 W	
Auto Power Off	Programmable	After the selected amount of minutes without operating on any control. Deactivable

► **Operating Environmental Conditions**

Parameter	Value	Additional data
Altitude	Up to 2000 m	
Temperature range	From 5 °C to 45 °C	Automatic disconnection by excess of temperature
Max. Relative humidity	80%	up to 31°C; decreasing lineally up to 50 % at 40 °C.

NOTE: Equipment specifications are set in these environmental operating conditions. Operation outside these specifications are also possible. Please check with us if you have specific requirements.

► **Included Accessories**

Parameter	Value	Additional data
1x CC-046	Jack 4V/RCA cable	
1x CC-041	Connection USB Cable On-the-go (A) Male - Mini USB (B) Male	
1x CC-045	USB Cable (A) Female - Mini USB (A) Male	
1x AA-103	Car lighter charger	
1x AL-103	External DC charger	
1x AD-056	"F"/H-"DIN"/H adapter	
1x AD-057	"F"/H-"F"/H adapter	
1x CA-005	Mains cord	
1x CB-087	Rechargeable Li-ion 7,4 V 6,6 Ah	Built-in
1x DC-304	Carrying bag	
1x DC-289	Transport belt	
1x DG00207	Quick Reference Guide	

RECOMMENDATIONS ABOUT THE PACKING

It is recommended to keep all the packing material in order to return the equipment, if necessary, to the Technical Service.



10.2 Measurement Mode

► DVB-T

Parameter	Value	Additional data
Modulation	COFDM	
Margin of power measurement	From 35 dB μ V to 115 dB μ V	
Measures	Power, CBER, VBER, MER, C/N and Link margin	VBER measure can go down to <1E-10; CBER measure can go down to <1E-7
Displayed data	Numeric and level bar	
Carriers	2k, 8k	
Guard Interval	1/4, 1/8, 1/16, 1/32	
Code Rate	1/2, 2/3, 3/4, 5/6, 7/8	
Constellation	QPSK, 16-QAM, 64-QAM	
Bandwidth	6, 7 and 8 MHz.	
Spectral inversion	ON, OFF	Auto
Hierarchy	Indicates hierarchy mode.	
Cell ID	Detected from transmitter station.	
TPS signalling	Time slicing, symbol interleaver and MPE-FEC.	

► DVB-T2

Parameter	Value	Additional data
Profiles	T2-Base, T2-Lite	
Modulation	COFDM	
Margin of power measurement	From 35 dB μ V to 115 dB μ V	
Measures	Power, CBER, C/N, LBER, MER, Link Margin, BCH ESR, LDP Iterations and wrong packets	LBER measure can go down to <1E-10.
Displayed data	Numeric and level bar	
Carriers	1k, 2k, 4k, 8k, 8k+ EXT, 16k, 16k+ EXT, 32k, 32k+ EXT.	
Guard Interval	1/4, 19/256, 1/8, 19/128, 1/16, 1/32, 1/128.	
Bandwidth	5, 6, 7 and 8 MHz.	
Spectral Inversion	ON, OFF	Auto
Pilot Pattern	PP1 - PP8	
PLP Code Rate	1/2, 3/5, 2/3, 3/4, 4/5, 5/6	
PLP Constellation	QPSK, 16QAM, 64QAM, 256QAM.	
PLP Constellation Rotation	ON, OFF	Auto
PLP ID	0 - 256	
Cell ID	Detected from transmitter station	
Network ID	Detected from transmitter station	
C2 System ID	Detected from transmitter station	

► DVB-C

Parameter	Value	Additional data
Modulation	QAM	
Margin of power measurement	From 45 dB μ V to 115 dB μ V	256QAM: 42 dB μ V; 128QAM: 39 dB μ V; 64QAM: 36 dB μ V; 32QAM: 33 dB μ V; 16QAM: 30dB μ V
Measures	Power, BER, MER, C/N and Link margin	
Displayed data	Numeric and level bar	
Demodulation	16/32/64/128/256 QAM	
Symbol rate	1800 to 7200 kbauds	
Roll-off (α) factor of Nyquist filter	0.15	
Spectral inversion	ON, OFF	Auto

► DVB-C2

Parameter	Value	Additional data
Modulation	COFDM	
Margin of power measurement	From 45 dB μ V to 115 dB μ V	TBD
Measures	Power, CBER, MER, C/N, LBER, BCH ESR, LDP Iterations and wrong packets	
Displayed data	Numeric and level bar	
Carriers	4k	
Guard Interval	1/64, 1/128	
Bandwidth	6 and 8 MHz	
Spectral Inversion	ON, OFF	Auto
PLP Code Rate	2/3, 3/4, 4/5, 5/6, 8/9, 9/10	
PLP Constellation	64QAM, 256QAM, 1kQAM, 4kQAM	
Dslice ID	0-256	
PLP ID	0 - 256	
Cell ID	Detected from transmitter station	
Network ID	Detected from transmitter station	
C2 System ID	Detected from transmitter station	

► Analogue TV

Parameter	Value	Additional data
Colour System	PAL, SECAM and NTSC	
Standard supported	M, N, B, G, I, D, K and L	
Sensibility	40 dBuV for a correct synchronism	

► FM

Parameter	Value	Additional data
Tuning range	45 to 1000 MHz	
Tuning step size	10 kHz	
Sensitivity	5 dBuV	150 MHz (S+N/N = 40 dB)
Selectivity	\pm 200 kHz 25 dB	

► DVB-S

Parameter	Value	Additional data
Modulation	QPSK	
Margin of power measurement	From 35 dB μ V to 115 dB μ V	18 dB μ V@2.15 GHz / 2 MSs; 30 dB μ V@2.15 GHz / 27 MSs; 33 dB μ V@2.15 GHz / 45 MSs
Measures	Power, CBER, MER, C/N and Link Margin	
Displayed data	Numeric and level bar	
Symbol rate	2 to 45 Mbauds	
Roll-off (α) factor of Nyquist filter	0.35	
Code rate	1/2, 2/3, 3/4, 5/6, 7/8	
Spectral inversion	ON, OFF	Auto



► **DVB-S2**

Parameter	Value	Additional data
Modulation	QPSK, 8PSK, 16APSK, 32APSK	
Margin of power measurement	From 35 dB μ V to 115 dB μ V	8PSK: 24 dBuV@2.15 GHz / 2 MSs; 34 dBuV@2.15 GHz / 27 MSs;
Measures	Power, CBER, LBER, MER, C/N, BCH ESR, Wrong Packets and Link Margin	
Displayed data	Numeric and level bar	
Symbol rate	2 to 45 MSps	QPSK, 8PSK, 16APSK, 32APSK
Roll-off (α) factor of Nyquist filter	0.20, 0.25 and 0.35	
Code Rate (8PSK)	1/2, 3/5, 2/3, 3/4, 4/5, 5/6, 8/9, 9/10	
Code Rate (QPSK)	3/5, 2/3, 3/4, 5/6, 8/9, 9/10	
Spectral inversion	ON, OFF	Auto
Pilots	Presence Indication	
TS clock		Warning message when the TS clock is too high

► **DSS**

Parameter	Value	Additional data
Modulation	QPSK	
Margin of power measurement	From 35 dB μ V to 115 dB μ V	
Measures	Power, CBER, VBER, MER, C/N and Noise Margin	
Displayed data	Numeric and level bar	
Symbol rate	20 Mbauds or variable	Auto detected
Roll-off (α) factor of Nyquist filter	0.20	
Code Rate	1/2, 2/3, 6/7 and AUTO	
Spectral Inversion	ON, OFF	Auto



10.3 Spectrum Analyser Mode

► Digital Signal

Parameter	Value	Additional data
General Parameters		
Resolution filter	100 kHz, 200 kHz, 1 MHz	
Markers	1	It displays frequency, level indication, level difference, frequency difference
Reference Level	65 dB μ V to 135 dB μ V	Adjustable in steps of 5 dB
Spectrum range		Span, dynamic range and reference level are variable by means of arrow cursors
Terrestrial		
Tuning range	45 to 1000 MHz	Continuous tuning from 5 to 1000 MHz
Tuning mode	Channel or frequency	Channel plan configurable; tune step 50 kHz
Resolution	10 kHz	
Measurement range	10 dB μ V to 130 dB μ V	3.16 μ V to 3.16 V
Measurement bandwidth	100 kHz	
Span	Full span-500-200-100-50-20-10 MHz	Full span (full band); selectable by control keys
Digital channels measures	Channel power, C/N	According to modulation type
Satellite		
Tuning range	950 to 2150 MHz	
Tuning mode	Intermediate frequency or downlink	Channel plan configurable; tune step 50 kHz
Resolution	10 kHz	
Measurement range	10 dB μ V to 130 dB μ V	3.16 μ V to 3.16 V
Measurement bandwidth	100 kHz	
Span	Full span-500-200-100-50-20-10 MHz	Full span (full band); selectable by control keys
Digital channels measures	Channel power, C/N, MER, CBER	According to modulation type



► **Analogue Signal**

Parameter	Value	Additional data
General Parameters		
Attenuation scale	Auto-range	
Numerical indication	Absolute value according to selected units	
Graphical indication	Analogue bar on screen	
Audible indicator	Pitch sound	Tone with pitch proportional to signal strength
Terrestrial		
Tuning range	5 to 1000 MHz	
Tuning mode	Manual	
Resolution	10 kHz	
Measurement range	15 dB μ V to 130 dB μ V	3.16 μ V to 3.16 V
Measurement bandwidth	100 kHz	
Analogue channels measures	Level, C/N, V/A	
Accuracy	± 1.5 dB	25-120 dB μ V; 45-1000 MHz; 22 °C \pm 5 °C
Out of range indication	<, >	
Satellite		
Tuning range	950 to 2150 MHz	
Tuning mode	Intermediate frequency or downlink	Channel plan configurable
Resolution	10 kHz	
Measurement range	20 dB μ V to 130 dB μ V	31.6 μ V to 3.16 V
Measurement bandwidth	100 kHz	
Analogue channels measures	Level, C/N	
Accuracy	± 1.5 dB	35-100 dB μ V; 950-2050 MHz; 22 °C \pm 5 °C
Out of range indication	<, >	



10.4 TV Mode

▶ Video

Parameter	Value	Additional data
Codecs	MPEG-1	
	MPEG-2	MP@HL (Main profile high level)
	MPEG-4 AVC H.264	High Profile Level 4.1; maximum bitrate 40 Mbps
Maximum Image Size	1920x1080x60i; 1280x720x60p/50p	
Minimum Image Size	352x240x30p; 352x288x25p	
Bitrate	40 Mbps	
Aspect Ratio	16/9; 4/3	
SI/PSI data	Service list and main PIDs	
HD Video Resolution	1080, 720 and 576	Progressive or interlaced

▶ Audio

Parameter	Value	Additional data
Codecs	MPEG-1	
	MPEG-2	
	HE-AAC	
Demodulation	According to the TV standard	
De-emphasis	50 µs	75 µs (NTSC)
Sound subcarrier	Digital frequency synthesis according to the TV standard	

▶ Transport Stream

Parameter	Value	Additional data
Communication protocol	UDP or RTP/UDP	
Packets	188 or 204 bytes	Automatic detection
Transmission	Packet or burst mode	
Methode	MULTICAST / IGMP version 2	
Payload	From 1 to 7 packets MPEG-2	
Video Info	Type, bitrate, format, aspect ratio, frequency, profile, PID	
Service Info	Network, provider, NID, ONID, scrambled/free, TSID, SID, LCN	
Audio Info	Type, bitrate, format, frequency, mono/stereo, language, PID	



10.5 Tools

► Constellation

Parameter	Value	Additional data
Type of Signal	DVB-T, DVB-T2, DVB-C, DVB-C2, DSS, DVB-S y DVB-S2	
Displayed data	Gráfico I-Q	

► Echoes

Parameter	Value	Additional data
Type of Signal	DVB-T, DVB-T2, DVB-C2	
Measurement range	Depends on the standard, carrier and guard interval	
Delay	0.1 μ s to 224 μ s	Typical configuration (DVB-T 8K, GI = 1/4)
Distance	0.3 km to 67.2 km.	Typical configuration (DVB-T 8K, GI = 1/4)
Power range	0 dBc to -30 dBc	Typical configuration (DVB-T 8K, GI = 1/4)
Time scale	1/3 symbol period	

► Test de Atenuación

Parameter	Value	Additional data
Test frequencies	3 selectable pilots	

► Adquisición de datos

Parameter	Value	Additional data
Stored data	Signal type, modulation parameters, all measures available for the detected signal type, and time stamp	
Timestamp	Date and time at each measured channel	



11 MAINTENANCE

11.1 Considerations about the Screen

This paragraph offers key considerations regarding the use of the colour screen, taken from the specifications of the manufacturer.

In the TFT display, the user may find pixels that do not light up or pixels that are permanently lit. This should not be regarded as a defect in the TFT. In accordance with the manufacturer quality standard, 9 pixels with these characteristics are considered admissible.

Pixels which are not detected when the distance from the surface of the TFT screen to the human eye is greater than 35 cm, with a viewing angle of 90° between the eye and the screen should not be considered manufacturing defects either.

It is advisable a viewing angle of 15° in the 6.00 o'clock direction in order to obtain the optimum visualization of the screen.

11.2 Cleaning Recommendations

The equipment consists of a plastic case and a TFT screen. Each element has its specific cleaning treatment.

■ Cleaning the TFT screen

The TFT screen surface is VERY DELICATE. It has to be cleaned with a soft fabric cloth (cotton or silk), always making the same move from left to right and from top to bottom, without putting pressure on the screen.

The TFT screen has to be dry-cleaned or with a product specifically designed for TFT screens, by slightly dampening the cloth. NEVER use tap or mineral water, alcohol or conventional cleaning products, because they contain components that can damage the screen.

Turn off the equipment to locate dirt on the screen. After cleaning, wait a few seconds before turning on.



- **Cleaning the plastic case**

The equipment has to be disconnected before cleaning the case.

The case must be cleaned with a solution of neutral soap and water, using a soft cloth dampened with this solution.

Before use, the equipment has to be completely dry.

Never clean with abrasive soaps, chlorinated solvents or aromatic hydrocarbons. These products may degrade the case.



ANNEX 1 SIGNALS DESCRIPTION

A1.1 DIGITAL signals

A1.1.1 Digital TERRESTRIAL Television FIRST Generation (DVB-T standard/COFDM modulation)

DVB-T Parameters

- ▶ **Channel Bandwidth**
This parameter affects the frequency separation of the carriers. Its value is 6 MHz, 7 MHz or 8 MHz.
- ▶ **Spectral inversion**
It detects if the input signal has been inverted.
- ▶ **FFT Mode**
It defines the number of modulation carriers between values 2k, 4k and 8k.
- ▶ **Guard Interval**
This parameter is the dead time between symbols; its purpose is to detect problems due to multipath echoes. This parameter is expressed in terms of the symbol duration: 1/4, 1/8, 1/16, 1/32.
- ▶ **Constellation**
Modulation used by the carriers. It also defines the noise immunity of the system (QPSK, 16-QAM and 64-QAM).
- ▶ **Code rate**
Also known as Viterbi ratio. It defines the ratio between the number of data bits and the total number of bits transmitted (the difference corresponds to the number of control bits for the detection and recovery of errors).
- ▶ **TS Hierarchy**
The DVB-T standard gives the possibility of TDT transmissions with hierarchical levels, that is, the simultaneous transmission of the same program with different image qualities and levels of protection to different noises, so the receiver can switch to a signal of lesser quality when reception conditions are not optimal.



DVB-T Measurements

- **Power**

Measured power over the entire bandwidth of the channel.

- **C/N**

Carrier/Noise ratio, where C is the received power of the modulated carrier signal and N is the received noise power. To measure it correctly the channel should be tuned at its centre frequency.

- **MER**

Modulation error ratio with link margin (LM). The link margin indicates the safety margin respect to the MER level, measured for the degradation of the signal up to the QEF (Quasi Error Free) value. MER represents the ratio between the average power of the DVB signal and the average noise power of the signal constellation.

- **BER (VBER/CBER)**

It is the system error rate. In a system of digital terrestrial signal reception, after the COFDM decoder two methods of error correction are applied. Each time an error correction is applied on the digital signal, the error rate changes, so if the error rate is measured at the demodulator output or after Viterbi or at the Reed-Solomon decoder output, different error rates are obtained.

- **CBER**

BER measurement for digital signal before the error correction (BER before FEC).

- **VBER**

BER measurement for digital signal after error correction (BER after Viterbi).

In order to have a reference about the image quality, it is considered that a system has good quality when it produces less than one un correctable error per hour of transmission. This border is called QEF (Quasi-English Error-Free,) and corresponds to one error rate after Viterbi equal to 2×10^{-4} , or 2 bit errors per 10.000.

This value is marked on the BER measurement bar after Viterbi. This the BER for acceptable signals should be to the left of this mark.

- **PER**

Measurement associated to VBER. It is an errored packet counter, plus a total time counter, accounting for total packets lost over a given period of time.



A1.1.2

**Digital TERRESTRIAL Television SECOND Generation
(DVB-T2 standard/COFDM modulation)**

The **DVB-T2** demodulator version allows working with Base (standard version) and Lite (mobile devices version) profiles.

DVB-T2 Parameters

- ▶ **Channel Bandwidth**
This parameter affects the frequency separation of the carriers. Its value is 6 MHz, 7 MHz or 8 MHz.
- ▶ **Spectral inversion**
It detects if the input signal has been inverted.
- ▶ **FFT Mode**
It defines the number of modulation carriers between values 1k, 2k, 4k, 8k, 8k + EXT, 16k, 16k + EXT, 32k, 32k + EXT.
- ▶ **Pilot Pattern**
There are several pilot patterns available from PP1 to PP8, which offer different features depending on the type of channel. Each pattern supports time and frequency variations up to the Nyquist limit. Limits depend on certain characteristics such as the receiver operation, if the interpolation is in frequency and time or just in time, and so on.
- ▶ **Guard Interval**
This parameter is the dead time between symbols; its purpose is to detect problems due to multipath echoes. This parameter is expressed in terms of the symbol duration: 1/4, 19/256, 1/8, 19/128, 1/16, 1/32, 1/128.
- ▶ **Constellation**
COFDM modulation with constellations QPSK, 16QAM, 64QAM, 256QAM.
- ▶ **Constellation rotation**
It detects if the constellation is rotated (ON) or not (OFF).
- ▶ **Code rate**
It defines the ratio between the number of data bits and the total number of bits transmitted (the difference corresponds to the number of control bits for the detection and recovery of errors).
- ▶ **PLP id**
It is the PLP identifier. In the case of PLP Single mode identifies the input stream (0-255). In the case of PLP Multiple mode clients can choose the PLP ID to view.



DVB-T2 Measurements

■ Power

Measured power over the entire bandwidth of the channel.

■ C/N

(Carrier/Noise) where C is the received power of the modulated carrier signal and N is the noise power received. To measure it correctly the channel should be tuned at its centre frequency.

■ PLP id

It is the PLP identifier. In the case of PLP Single mode identifies the input stream (0-255). In the case of PLP Multiple mode clients can choose the PLP ID to view.

■ MER

Modulation Error ratio with indication of Link Margin (LM). The link margin indicates the safety margin respect to the MER level, measured for the degradation of the signal up to the QEF (Quasi Error Free) value. MER represents the ratio between the average power of the DVB signal and the average noise power of the signal constellation.

■ BER (CBER/LBER)

It is the bit error rate. There are two measurements related to BER:

■ **CBER** (Channel Bit Error Rate):

BER of the signal after the COFDM demodulator and before applying the error correction or FEC (Forward Error Correction).

■ **LBER** (LDPC Bit Error Rate):

BER after been applied the LDPC (Low-density parity-check) error correction.

In a digital signal reception (DVB-T2), after the COFDM decoder two methods of error correction are applied. DVB-T2 uses two codes to correct errors that are the LDPC (Low Density Parity Check) combined with the BCH (Bose-Chaudhuri - Hocquengham) to protect against high levels of signal noise and interferences. Next to the measurement LBER is shown the number of iterations LDPC, that is, the number of times the LDPC error correction decoder has to pass through the signal and the ESR (Error Second Ratio) after 20 seconds of the BCH decoder. This measure indicates the percentage of time with errors after the BCH. Error correction is internal with BCH and external with LDPC. The internal gives basic error correction with minimum load while the external gives error correction with a correction additional charge.



A1.1.3

**Digital SATELLITE Television FIRST Generation
(DVB-S standard/QPSK modulation)****DVB-S Parameters**

- ▶ **Channel Bandwidth**
It displays the channel bandwidth from 1.3 MHz to 60.75 MHz.
- ▶ **Spectral inversion**
It detects if the input signal has been inverted.
- ▶ **Symbol Rate**
It represents the number of times that the signal status changes in a period of time. The bandwidth is related to this parameter.
- ▶ **Roll-Off Factor**
Roll-off factor of Nyquist filter. It indicates the excess of bandwidth over the ideal bandwidth
- ▶ **Constellation**
QPSK modulation for constellations with DVB-S signals.
- ▶ **Code rate**
Also known as Viterbi ratio. It defines the ratio between the number of data bits and the total number of bits transmitted (the difference corresponds to the number of control bits for the error detection and recovery). This value should be between 1/2, 2/3, 3/4, 5/6 and 7/8.



DVB-S Measurements

■ **Power**

Measured power over the entire bandwidth of the channel.

■ **C/N**

Carrier/Noise ratio where C is the received power of the modulated carrier signal and N is the noise power received. To measure it correctly the channel should be tuned at its centre frequency.

■ **MER**

Modulation Error ratio with indication of Link Margin (LM). The link margin indicates the safety margin respect to the MER level, measured for the degradation of the signal up to the QEF (Quasi Error Free) value. MER represents the ratio between the average power of the DVB signal and the average noise power of the signal constellation.

■ **BER (CBER/VBER)**

It is the error rate. There are two measurements related to BER:

■ **CBER** (Channel Bit Error Rate):

BER of the signal after the QPSK demodulator and before applying the error correction or FEC (Forward Error Correction).

■ **VBER** (Viterbi Bit Error Rate):

Measurement of the BER for the digital signal after error correction (BER after Viterbi).

In a system for receiving digital satellite signals (DVB-S) after the QPSK decoder two methods of error correction are applied. Each time an error correction is applied on a digital signal its error rate changes, so if we measure the error rate at the output of the QPSK demodulator or after Viterbi or after the Reed-Solomon output decoder, the error rates obtained are different.

■ **PER**

Measurement associated to VBER. It is an errored packet counter, plus a total time counter, accounting for total packets lost over a given period of time. In DVB-S, CBER is not to measure when PER is evaluated.



A1.1.4

**Digital SATELLITE television signal of SECOND generation
(DVB-S2 standard/QPSK/8PSK modulation)****DVB-S2 Parameters**

- ▶ **Channel Bandwidth**
It displays the channel bandwidth from 1.3 MHz to 60.75 MHz.
- ▶ **Spectral inversion**
It detects if the input signal has been inverted.
- ▶ **Symbol Rate**
It represents the number of times the signal status changes in a period of time. The bandwidth is related to this parameter. The symbol-rate can be set manually
- ▶ **Roll-Off Factor**
Roll-off factor of Nyquist filter. It indicates the excess of bandwidth over the ideal bandwidth.
- ▶ **Constellation**
QPSK or 8PSK modulation for DVB-S2 signal constellation.
- ▶ **Code rate**
It defines the ratio between the number of data bits and the total number of bits transmitted (the difference corresponds to the number of control bits for the error detection and recovery).
- ▶ **PLP id**
It is the PLP identifier. In the case of PLP Single mode identifies the input stream (0-255). In the case of PLP Multiple mode clients can choose the PLP ID to view.
- ▶ **TS clock**
The symbol-rate can be set manually.

DVB-S2 Measurements

- **Power**
Measured power over the entire bandwidth of the channel.
- **C/N**
Carrier/Noise ratio where C is the received power of the modulated carrier signal and N is the noise power received. To measure it correctly the channel should be tuned at its centre frequency.



■ **MER**

Modulation Error ratio. MER represents the ratio between the average power of the DVB signal and the average noise power of the signal constellation.

Next to the MER appears the Link Margin (LM) measurement. The LM is equivalent to the noise margin (NM) and indicates the distance to the QEF (usually defined as a one lost packet per hour). The LM is measured in dB and its value corresponds to the safety margin that separates from the QEF. The greater is the LM better the quality signal. LM of negative values implies no reception or that video errors are starting to appear in the video or audio so clear. LM of 0 (zero) value will display a service and occasionally some artefact.

■ **BER (CBER/LBER)**

It is the bit error rate. There are two measurements related to BER:

■ **CBER** (Channel Bit Error Rate):

BER of the signal after the QPSK/8PSK demodulator and before applying the error correction or FEC (Forward Error Correction).

■ **LBER** (LDPC Bit Error Rate):

BER after applying LDPC error correction (Low-density parity-check).

This standard makes use of two codes to correct errors that are the LDPC (Low Density Parity Check) codes combined with BCH (Bose-Chaudhuri - Hocquengham) to protect against high levels of signal noise and interference. Each time you apply an error correction to the digital signal, the error rate changes, so if we measure the error rate at the output of the QPSK/8PSK demodulator or after LDPC (Low Density Parity Check) decoder or at the BCH decoder output, error rates obtained are different.

Next to the LBER measure appears ESR (Error Second Ratio). This measures indicates the percentage of time with errors after BCH. The error correction is internal with BCH or external with LDPC. The internal error correction provides basic minimum load while the outer error correction is an additional correction with load. It also measures the PER, which is the number of erroneous packets, that is packets received during the measurement time not correctable by the demodulator.



A1.1.5

**Digital CABLE television signal of FIRST generation
(DVB-C standard/QAM modulation)****DVB-C Parameters**

- ▶ **Bandwidth channel**
It displays the channel bandwidth up to 9.2 MHz.
- ▶ **Spectral inversion**
It detects if the input signal has been inverted.
- ▶ **Symbol Rate**
It represents the number of times the signal status changes in a period of time. The bandwidth is related to this parameter.
- ▶ **Roll-Off Factor**
Roll-off factor of Nyquist filter. It indicates the bandwidth excess over the ideal bandwidth.
- ▶ **Constellation**
Modulation used by the carriers. It also defines immunity to the system noise (16QAM, 32QAM, 64QAM, 128QAM and 256QAM).



DVB-C Measurements

- **Power**
Measured power over the entire bandwidth of the channel.
- **C/N**
Carrier/Noise ratio where C is the received power of the modulated carrier signal and N is the noise power received. To measure it correctly the channel should be tuned at its centre frequency.
- **MER**
Modulation Error ratio with indication of Link Margin(LM).The link margin indicates the safety margin respect to the MER level , measured for the degradation of the signal up to the QEF (Quasi Error Free) value. MER represents the ratio between the average power of the DVB signal and the average noise power of the signal constellation.
- **BER (CBER)**
It is the system error rate. In a digital signal reception via cable, after the QAM demodulator an error correction method is applied, called Reed-Solomon. The error rate after correction is less than the error rate at the output of the QAM demodulator. For this reason the BER is given prior to error correction.
- **CBER**
BER measurement for digital signal before the error correction (BER before FEC)
- **PER**
Measurement associated to VBER. It is an errored packet counter, plus a total time counter, accounting for total packets lost over a given period of time. In DVB-S, CBER is not to measure when PER is evaluated.



A1.1.6

**Digital CABLE television signal of SECOND generation
(DVB-C2 standard/COFDM modulation)****DVB-C2 Parameters**

- ▶ **Channel Bandwidth**
It is the channel bandwidth between 6 MHz, 7 MHz and 8 MHz.
- ▶ **Spectral inversion**
It detects if the input signal has been inverted.
- ▶ **Guard Interval**
It corresponds to the dead time between symbols; its purpose is to detect echoes due to multi-paths. This parameter is expressed in terms of the symbol duration: 1/64 or 1/128.
- ▶ **Constellation**
COFDM modulation with constellations QPSK, 16QAM, 64QAM, 256QAM, 1024QAM, 4096QAM. The constellation refers to all the selected PLP data.
- ▶ **Code rate**
It defines the ratio between the number of data bits and the total number of bits transmitted (the difference corresponds to the number of control bits for the error detection and recovery): 2/3, 3/4, 4/5, 5/6, 8/9, 9/10.
- ▶ **DSLICE id**
DSLICE identifier. A DSLICE is a data packet containing a group of several PLPs.
- ▶ **PLP id**
PLP (Physical Layer Pipes) identifier. Layers are used by the system to transmit compressed data such audio, video and more.



DVB-C2 Measurements

- **Power**
Measured power over the entire bandwidth of the channel.
- **C/N**
Carrier/Noise ratio where C is the received power of the modulated carrier signal and N is the noise power received. To measure it correctly the channel should be tuned at its centre frequency.
- **MER**
Modulation Error ratio with indication of Link Margin(LM).The link margin indicates the safety margin respect to the MER level , measured for the degradation of the signal up to the QEF (Quasi Error Free) value. MER represents the ratio between the average power of the DVB signal and the average noise power of the signal constellation.
- **BER (CBER/LBER)**
System error rate. In DVB-C2 makes use of two codes to correct errors that are the LDPC (Low Density Parity Check) codes combined with BCH (Bose - Chaudhuri - Hocquengham) to protect against high levels of signal noise and interferences. On screen, under LBER measurement the number of iterations LDPC is shown, that is, the number of times the LDPC decoder for error correction has to pass through the signal and the ESR (Error Second Ratio) that indicates the percentage of time with errors after the BCH. Error correction is internal with BCH or external with LDPC. The internal error correction provides basic minimum load while the outer error correction is a correction with additional load. Also the PER measurement is displayed, which is the number of erroneous packets, that is, packets received during the measurement time and not correctable by the demodulator.
- **CBER (Channel Bit Error Rate)**
BER of the signal after passing through the COFDM demodulator and before applying the error correction or FEC (Forward Error Correction).
- **LBER (LDPC Bit Error Rate)**
BER of the signal after applying the correction errors LDPC (Low-density parity-check).



A1.2 ANALOGUE signals

A1.2.1 Terrestrial band

Analogue TV

In the measurement of analogue signals in terrestrial band, measurements available are:

- ▶ **LEVEL**
Indication of the carrier level of the tuned video.
- ▶ **C/N**
Ratio between the modulated signal power and noise power for the same bandwidth (depending on TV standard). The modulation error ratio (MER), used in digital systems is analogue to the Signal-Noise (S/N) ratio in analogue systems. The Carrier level is measured by a quasi-peak detector (100 kHz BW). The noise level is measured with an average detector and corrected to refer it to the bandwidth equivalent to channel noise (according to its definition for the TV selected standard).
- ▶ **Video/Audio**
Ratio between levels of the video carrier to audio carrier.

Analogue FM

In the analogue FM measurement mode signal, the display acts as an analogue indicator of signal representing the signal at the input. The equipment also demodulates the FM carrier (radio) and can be listened through the speaker.

**A1.2.2** **Satellite band****Analogue TV**

In the measurement mode of analogue signals in the satellite band, measures available are:

- ▶ **Level**
Measurement of the tuned carrier level.

- ▶ **C/N**
Ratio between the modulated signal power and noise power equivalent to the same bandwidth (as TV standard). The modulation error ratio (MER), used in digital systems is analogue to the Signal-Noise (S/N) ratio in analogue systems. The carrier level is measured by a quasi-peak detector. The noise level is measured with an average value detector and corrected to refer it to the channel bandwidth.



ANNEX 2 HOW TO POINT A DISH ANTENNA

A2.1 INSTALLING A SATELLITE DISH USING HD RANGER UltraLite

A2.1.1 A bit of history

That's it, a bit of history. First artificial satellite "Sputnik I" was launched 4th of May of 1957 by former Soviet Union. It was about the size of a basketball with a weight below 100 Kgrs but went down in history as the start point for the space age. For three weeks it was transmitting radio signals to the excited scientist on the ground that were gathering fundamental data for the launches to come.

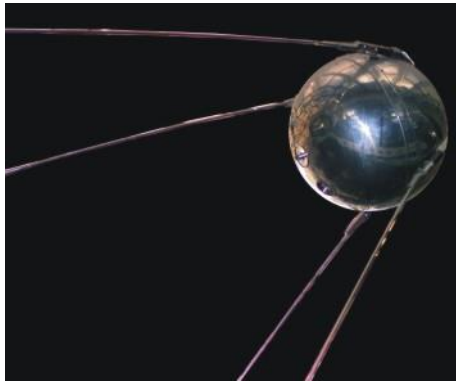

Figure A2.1.

The first telecommunications satellite was Telstar I launched in 1962. Some people refers to Echo I as the World's first in 1960 but it was a passive signal reflector as opposite to Telstar that carried electronics on board like today's satellites. It was also the first to use the modern transponder concept where the satellite "transposes" the up-link frequency (6,390 GHz in Telstar) to another down-link frequency (4,170 GHz in this case). Telstar I trans-mitter power was 3 Watts and the antenna was omnidirectional.



Figure A2.2.



The antenna used to receive the test transmission from Telstar *I* was a huge horn inside a bubble radome 48 metres high. Only four decades later we have broken all records and we have high power DBS geostationary satellites carrying a lot of digital transponders on board and we start to worry about space junk having thousands of satellites in orbit, plenty of them beyond its useful life. Satellites use highly efficient directional antennas and very high transmitters power, digital transponders, meaning in plain words that we can receive hundreds of TV channels with a small, fix, cheap, 60 cm dish.



Figure A2.3.

Modern broadcast satellites use geostationary orbits. This simply means that they could be seen from the ground hanging in the sky at the same exact position all the time and therefore receiving signals from them does not require complex steering systems. A piece of cake.

All we need to do to receive their signals with the enormous amount of programs they carry is to set up the satellite receiving antenna properly and to ensure that the signals are received with the proper quality levels...and here is where the **HD RANGER UltraLite** comes into action.

A2.1.2 The basics

A professional installer will instantly tell us from the top of his head what to have in the to-do-list if we want to install a satellite dish properly. Surely the list will require us to select the proper mount kit and dish size from the numerous options available in the market, pick a good location for the dish, free of obstacles to the south (in the north hemisphere) or to the north (in the south hemisphere), etc.

Other than the mechanical bits and pieces the dish is made of two clearly differentiated parts, the reflector and the LNB.

The reflector is passive and simply reflects signals from the satellite in such a way that the beam is collimated to the LNB's mounting point.



Figure A2.4.

The LNB (Low Noise Block-converter) is an active device fruit of the great evolution of RF circuit manufacturing and includes amplifiers, oscillators and frequency converters in a small low cost package. The first section is made of a device called *polarisation shifter* that receives one polarisation or the other depending on the supply voltage given to the LNB. This voltage is necessary to supply the active devices inside the LNB.

Signals broadcast from the satellites use two polarisations simultaneously. These can be LINEAR VERTICAL/HORIZONTAL or CIRCULAR LEFT/RIGHT depending on the type of transmitting antenna used in the satellite. The transponder frequencies for each polarisation are carefully selected to avoid interference to the other polarisation commonly referred to as the crossed polarisation. In general they are imbricate or in other words frequencies used in one polarisation are free in the crossed polarisation and viceversa.

	13 VDC	VERTICAL	CIRCULAR RIGHT
	18 VDC	HORIZONTAL	CIRCULAR LEFT

Modern universal LNB's use mostly linear polarisation and have also the capability to select a different input frequency range depending on a control signal called 22 kHz switching tone which is overlapped with the supply voltage.

SUPPLY VOLTAGE	POLARISATION	BAND
13 VDC	VERTICAL	LOW
18 VDC	HORIZONTAL	LOW
13 VDC + 22 kHz	VERTICAL	HIGH
18 VDC + 22 kHz	HORIZONTAL	HIGH

In other words our LNB will output a different set of satellite transponders depending on which supply voltage we use.

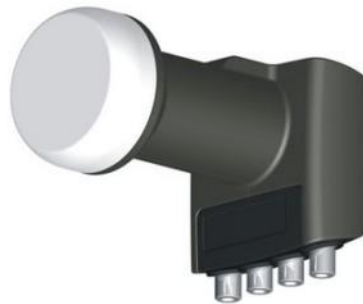

Figure A2.5. An example of LNB(Low Noise Block-converter)

A2.1.3 Coarse dish alignment

We can use different techniques to find out where in the sky the satellite we want is located. They can be anything from a pure guessing game to a sophisticated procedure.

The satellites we are interested in are all positioned in a geostationary orbit above the earth's equator. Each of them has a fix given position in that orbit, something like a street number, that we can know from various sources. Orbital position is an important datum so it is commonly part of the name as well.

Websites like <http://www.lyngsat.com/> or <http://www.satcodx.com/> offer plenty of useful information about the satellites we are talking about.

For example ASTRA 19E refers to ASTRA satellite which is positioned at 19 degrees East in the orbit.

Knowing where we are in terms of latitude and longitude is also easy. We can read that information from a map or even from our car's navigation system if we have one.

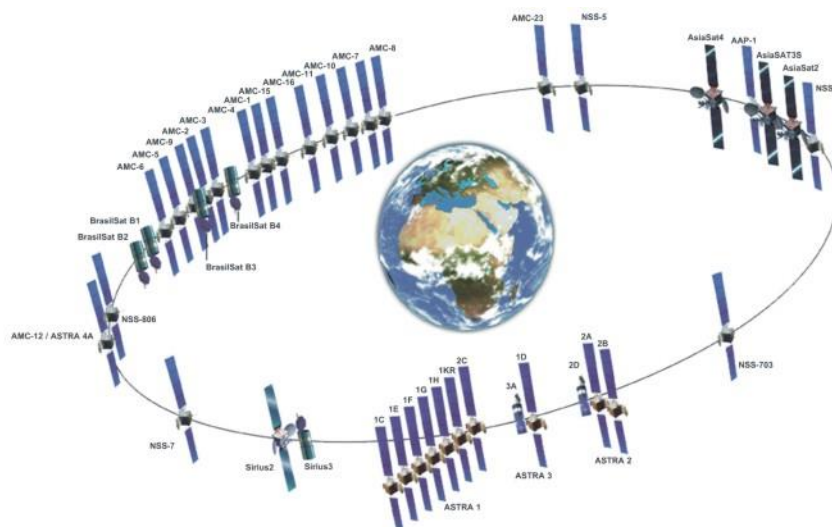



With this information in hand we can calculate the elevation and azimuth we should put on the dish to begin our coarse antenna alignment. There are formulas to do that but some websites are again quite useful. There are also free mobile applications, as Dish Aligner, which calculates the elevation and azimuth and also your current location determined by the GPS of the mobile phone. This one is especially interesting for you can select the satellite you want and then position yourself on a graphical map:

<http://science.nasa.gov/realtime/jtrack/3d/JTrack3D.html/>

For example if we take ASTRA (19E position) and select a location somewhere in Germany:

- Latitude: 50 degrees North
- Longitude: 12 degrees East

The required elevation and azimuth for the dish are:

- Azimuth: 170 degrees
- Elevation: 31 degrees

Elevation must be measured from the horizontal level (may be using an inclinometer) and azimuth from magnetic north (with a compass) there are some applications for smartphones, as mentioned above, that include compass and inclinometer, although it should be noted that the measurements made by mobile phone may be affected by interferences from the antenna itself. It is normally more practical to start with azimuth moving the dish horizontally and then look for the elevation.

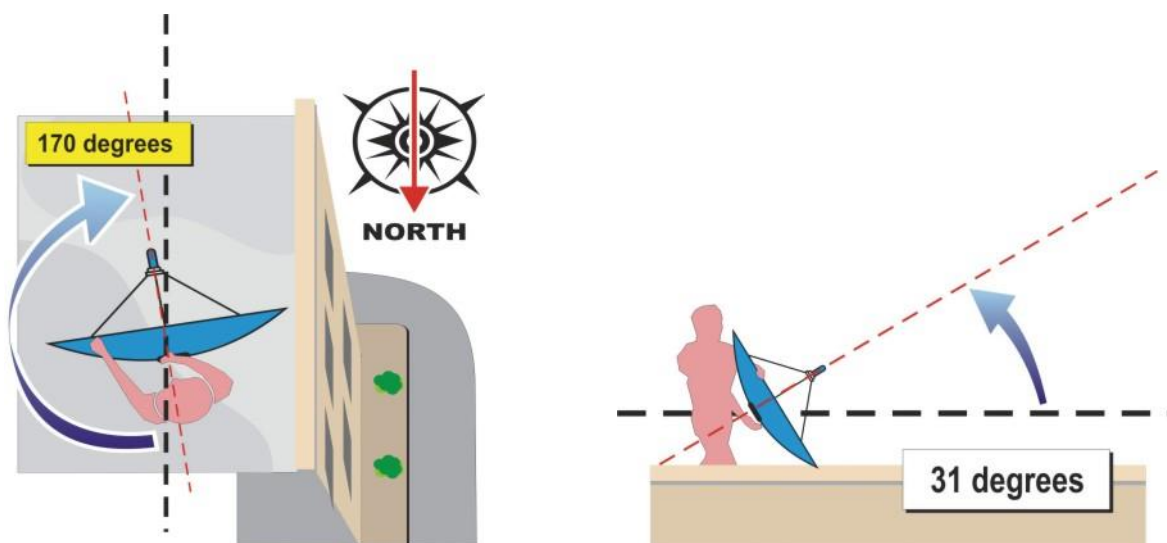

Figure A2.7.



A2.1.4 Knowing what satellite we are on

And the **HD RANGER UltraLite** comes into action. Our dish is now more or less "looking" in the direction where we presume our "bird" is parked. With the **HD RANGER UltraLite** connected to the output of the LNB we select satellite frequency range, antenna alignment mode, span of 200 MHz and set the power supply voltage to one of the possible values. We will take for example 13 VDC, which will take us to the VERTICAL polarisation and LOW band. We can use 80 dB μ V for the reference level for we can change that at pleasure depending on the amount of signal we get.

Something will come up on the **HD RANGER UltraLite** screen. It will normally be a weak signal that may come from the desired satellite or from the neighbour ones for the dish is not properly tuned up yet. Swing the dish slightly horizontally and vertically until a decent signal is shown on the screen.

There we have a satellite but which one is it? Most probably the signals we are looking at are digital transponders from the unknown satellite. The **HD RANGER UltraLite** can be operated in frequency or channel modes.

Tune any of those digital channels in frequency mode using the control keys and the markers shown on the screen. The **HD RANGER UltraLite** will tell you what satellite and/or orbital position you are on in a matter of seconds !

If we are unlucky and this is not the satellite we want then we only need to move the dish slightly to pick the signal from the next satellite and repeat the process.

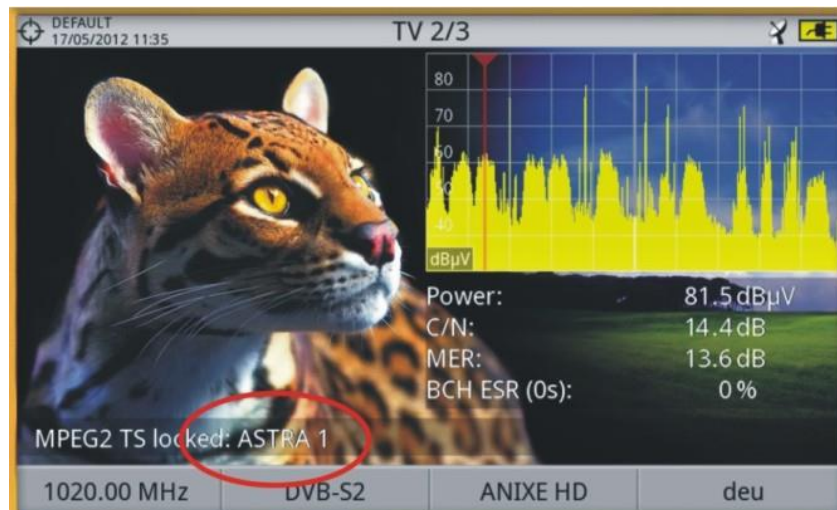

Figure A2. 8.



A2.1.5 Fine tuning the dish

Once we know for certain that we are on *ASTRA 19E* it is time to make fine adjustments to the dish to optimise the alignment. There are two goals to achieve. On the one hand we want to receive the maximum amount of power possible and on the other hand we need to make sure we minimise the interference from the crossed polarisation.

In order to maximise the received signal power we need only to move the dish's azimuth and elevation very carefully ensuring that the display of the spectrum analyser show us the highest values possible.

As you move the dish's position you will see the signal change on the spectrum analyser. Cross-polarisation is adjusted by rotating the LNB on its axis. As you do so you will see on the *HD RANGER UltraLite* screen how the channels interfering from the opposite polarisation go up and down the objective being to leave the LNB in such a position that those channels are as low as possible.

A2.1.6 Testing signal quality

The *HD RANGER UltraLite* is the ideal instrument for quick and effective checks of signal quality not only because it shows all measurements in one single screen but also because the meter doesn't require bothering configuration processes.

► Option 1: Frequency mode

I can tune in frequency mode all channels coming up in the screen, all of them or the most representative ones only. We can move our cursor in frequency mode, in spectrum, through out the band. When we stop on a channel, the meter will acquire all the settings needed to measure the channel without bothering us. Then pressing the measurement button and voilà.

► Option 2: Channel mode

I can select channel mode and a satellite channel table from the list. The *HD RANGER UltraLite* has several of them preloaded but this can be changed using software application.

Once we select the desired table, *ASTRA 19E* in this case, we can browse the channels at once. There are channel tables grouped by polarisation or band or those with all channels in the satellite.



A2.1.7 **Look what we've got**

The **HD RANGER UltraLite** can also display the free to air programs available in the satellite. That is very practical not so much for the picture itself but for amount of interesting data related to the transponders we can display as well. This includes:

Tuned video information.

- ▶ **TYPE:** Encoding type and video transmission rate.
- ▶ **FORMAT:** Resolution (horizontal x vertical), aspect ratio and frequency.
- ▶ **PROFILE:** Profile level.
- ▶ **PID:** Video program identifier.

Tuned service information.

- ▶ **NETWORK:** Television distribution network (Terrestrial). Orbital position (Satellite).
- ▶ **PROVIDER:** Program provider name.
- ▶ **NID:** Network identifier where the signal is distributed.
- ▶ **ONID:** Identifier of the original network where the signal originates.
- ▶ **TSID:** Transport stream identifier.
- ▶ **SID:** Service Identifier.
- ▶ **MHP:** Interactive service.
- ▶ **LCN:** Logic Channel Number. It is the first logic number assigned to the first channel in the receiver.
- ▶ **+Info:** Additional service information.
- ▶ **FREE/SCRAMBLED:** Free/scrambled transmission.
- ▶ **DTV/DS:** Standard type of transmission.

Tuned audio information.

- ▶ **TYPE:** Type of audio encoding and transmission speed
- ▶ **FORMAT:** Service audio format. Bit depth; sampling frequency; sound reproduction.
- ▶ **LANGUAGE:** Broadcasting language.
- ▶ **PID:** ID of the audio program.

At any time it is possible to display the SERVICE LIST pressing the **F3** key and show all the programs and services available within the tuned channel. Selecting one particular channel or service becomes very intuitive.



ANNEX 3 DiSEqC COMMANDS

A3.1 DiSEqC introduction

The **DiSEqC™** (Digital Satellite Equipment Control) is an open protocol created by Eutelsat in 1997 as a communication standard between satellite TV receivers and external peripherals. The **DiSEqC™** communications are based on the control commands, which travel combined with power voltage through the coaxial cable that leads the TV signal. The compatible peripherals and receivers detect these commands and react in agreement with such.

A **DiSEqC™** command is a digital command represented by a succession of binary messages: "0" and "1" obtained when modulating the 22 kHz signal.





The **DiSEqC™** usually is used in the satellite TV facilities in order to use different types of switchers, through the coaxial cable that leads the TV signal.

A3.2 To begin: The Universal LNB

The Universal LNB is the simplest and most used LNB. This allows the signal reception coming from one single satellite.

TWIN (2 independent outputs), QUAD (4 independent outputs) and OCTO (8 independent outputs) versions exist in the market. Each output is independent from others and can be connected to a different receiver.

An universal LNB is controlled by means of a power voltage and a 22kHz signal, sent through the RF cable, which allows us to switch between the different bands and polarities, according to the following table:

'Standard'	'TWIN'	'QUAD'*	'OCTO'
			
1 satellite only 1 receiver	1 satellite only 2 receivers	1 satellite only 4 receivers	1 satellite only 8 receivers

Power	Band	Polarization(linear / circular)
13 V	Low	Vertical / Right
18 V	Low	Horizontal / Left
13 V + 22 kHz	High	Vertical / Right
18 V + 22 kHz	High	Horizontal / Left

* Not to confuse with LNB Quattro used in collective facilities.



Note: The LNB accept a very wide range of values for these voltages, usually 10-14.5V (for 13V) and 15.5-20V (for 18V).

In the **HD RANGER UltraLite** the band and the polarisation selection can be done from different menus (all the different ways indicate dare equivalent):

Menu	Line
External units power supply	13 V, 18 V, 13 V+22kHz, 18 V+22kHz
Configuration	Band: High / Low Polarization: Vertical / Horizontal
DiSEqC	Band: High / Low Polarization: Vertical / Horizontal

A3.3 DiSEqC™ around the world

The use of **DiSEqC™** devices requires to know previously which commands are acknowledged by these ones, since it will determine the wiring diagram of the different elements, as well as the way as they can be controlled. This information must be provided by the device manufacturer.

Following appear the **DiSEqC™** devices more usually installed in the individual and collective facilities.

A3.4 In the individual facilities

A3.4.1 Tone-burst switcher (2 inputs – 1 output)

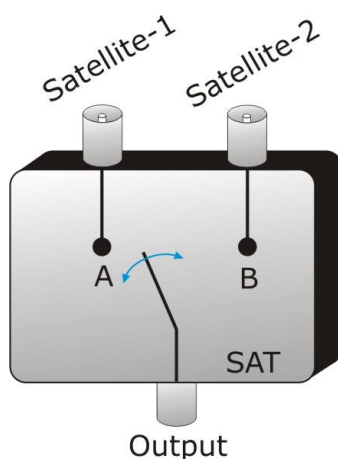

Figure A3. 1.

It is the simpler **DiSEqC™** switcher. This one uses the « SAT A/B » commands and allows to switch between two different Universal LNB:



Command	Selected input
SAT A	Satellite 1
SAT B	Satellite 2

These switchers are transparent to the LNB's (13V, 18V, 22 kHz) commutation commands. Then, once chosen the satellite with the SAT command, the corresponding LNB can be used in a normal way. (see Universal LNB).

Note: There are switchers of 2 inputs and 1 output in which other **DiSEqC™** commands are used, such as POSITION or OPTION, to allow more complex assemblies. Refer to the manufacturer technical information to make sure which are the commands to use.

A3.4.2 Monobloc LNB

A Monobloc LNB is a module composed by 2 Universal LNB connected by a Toneburst switcher (2 inputs – 1 output). So, it can be managed in the same way.

Also TWIN (2 independent outputs), QUAD (4 independent outputs) and OCTO versions exist (8 independent outputs). In this case, each output is controlled in a different way from the rest.

Important: If it is desired to use Monobloc LNB with **DiSEqC™** switchers, is necessary to make sure that these are compatible.



Figure A3. 2.



A3.4.3 DiSEqC™ Switcher with 4 inputs and 1 output

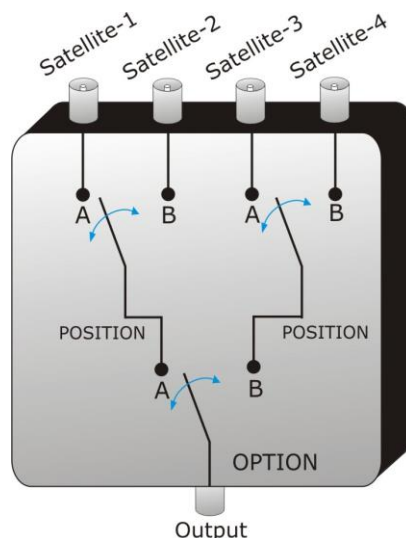

Figure A3. 3.

This switcher allows the signal reception from four independent Universal LNBs (coming from 4 different satellites) on a single receiver.

As it is possible to observe in the attached scheme, there are "OPTION" and "POSITION" switchers in cascade. In order to switch it, will be necessary to send an OPTION command and later a POSITION command that yields, therefore, a total of 4 possibilities.

Note: the manufacturers usually assure the compatibility with the Tone-burst commands (SAT A/B) so that the second stage can be switched as much using a «POSITION A/B» command as using a «SAT A/B» command. This allows us then to use the switcher like a Tone-burst type with 2 inputs and 1 output.

With the *HD RANGER UltraLite*, it is very easy to use this type of switcher, because it incorporates a specific «OPT / POS»command:

<i>HD RANGER UltraLite</i> Command	Combination of DiSEqC™ Commands send	Selected input
OPT/POS A-A	Option A + Position A	Satellite 1
OPT/POS A-B	Option A + Position B	Satellite 2
OPT/POS B-A	Option B + Position A	Satellite 3
OPT/POS B-B	Option B + Position B	Satellite 4

These switchers are transparent to the LNB's (13V, 18V, 22 kHz) switching commands. Then, once the satellite is chosen by means of the SAT command, the corresponding LNB can be used in a normal way. (see Universal LNB).



A3.5 In the collective facilities

The most frequent satellite signal distribution system in the small collective facilities is the "BIS-switched". This technology implies to use the "Quattro" type LNBs (not to confuse with the "QUAD" type) and also supports specific multiswitches for this type of facilities.

A Quattro-LNB is a LNB with 4 outputs that provides in a separated way the four frequency bands (vertical low, vertical high, horizontal low and horizontal high). These four signal scan then be distributed in the building through multiswitches.



Figure A3. 4.

The signal is distributed in the network by means of **multi-outlet multiswitches**. The number of inputs and outputs is variable. The number of inputs depends on the number of satellites (LNB). Usually a multiswitch includes also an input for the TV terrestrial signal. The number of outputs depends on the number of terminals (receivers) that can be connected to the multiswitch. In addition, **multiswitch in cascade** incorporate pass connectors to be able to distribute the signal and thus to connect several multiswitch in cascade mode and therefore to give access to more users.

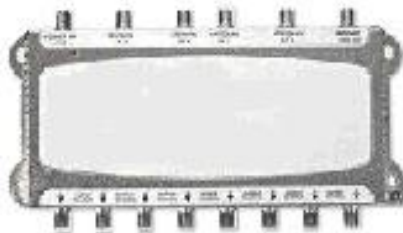

Figure A3. 5.



► **Examples of multiswitch**

	SAT Inputs	TER Inputs	Satellites	Terminals
Multiswitch 9/4	8	1	2	4
Multiswitch 5/16	4	1	1	16
Multiswitch 17/16	16	1	4	16
...

We will not consider the input of terrestrial TV, since this does not take part in the satellite signal. Also the following indicated examples do not show more than a single output. In the case of several outputs, the own operation scheme is reproduced for each one of them, because they are independent of the others.

A3.5.1 Multiswitch (1 satellite)

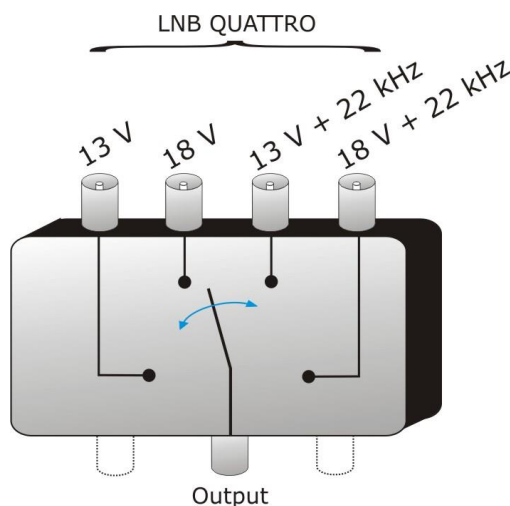

Figure A3. 6.

In the **DiSEqC™** menu of the **HD RANGER UltraLite** select the band and the polarisations desired and send the SAT A command, as it is indicated in the following table:

Band	Polarization	Command
Low	Horizontal	SAT A
Low	Vertical	SAT A
High	Horizontal	SAT A
High	Vertical	SAT A

Very important: Whenever you wish to change of band or polarisation, it is necessary to send the SAT A command at the same time, since multiswitch does not respond to the habitual switching commands for a LNB (13V/18V/+22kHz): it is necessary the complete **DiSEqC™** sequence to cause the commutation.



A3.5.2 Multiswitch (2 Satellites)

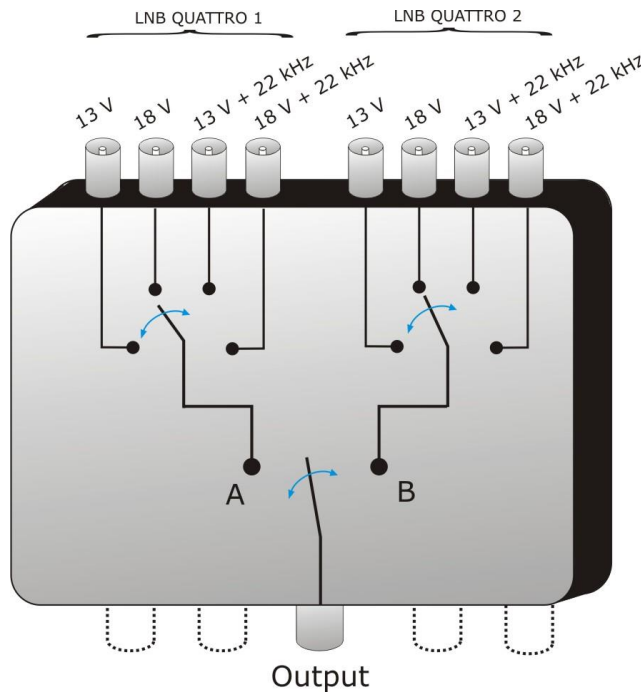
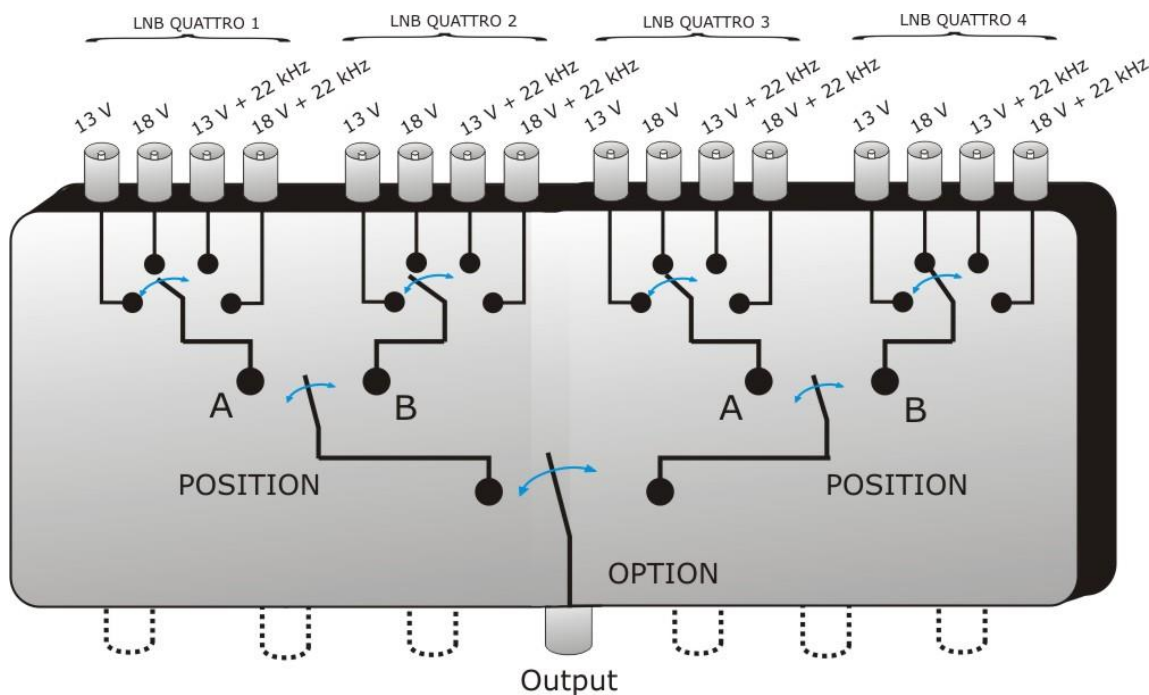

Figure A3. 7.

This type of multiswitch is used usually to switch the Astra 19° and Hotbird 13° satellites.

As in the previous case, if for a certain satellite it is desired to change of band or polarisation, it is not sufficient with changing the corresponding parameter, but in addition it is necessary to send the command SAT A/B corresponding to cause the switching (even if one does not change of satellite).

Band	Polarization	Command	Output
Low	Horizontal	SAT A	Satellite-1
Low	Vertical	SAT A	Satellite-1
High	Horizontal	SAT A	Satellite-1
High	Vertical	SAT A	Satellite-1
Low	Horizontal	SAT B	Satellite-2
Low	Vertical	SAT B	Satellite-2
High	Horizontal	SAT B	Satellite-2
High	Vertical	SAT B	Satellite-2

A3.5.3 Multiswitch (4 Satellites)

Figure A3. 8.

This type of multiswitch allows to distribute the signal coming from 4 different satellites. It uses a combination of OPTION, POSITION, Polarisation and Band commands. The equipment allows to use easily this type of multiswitch thanks to the « OPT/POS » command, which sends the OPTION et POSITION commands in the necessary order. Like in the others multiswitch, if it's wanted to change of band or polarisation, if the satellite is even he himself, is necessary to send OPT/POS command to cause the commutation again.

Band	Polarization	Command	Satellite
Low	Horizontal	OPT/POS A-A	Satellite-1
Low	Vertical	OPT/POS A-A	Satellite-1
High	Horizontal	OPT/POS A-A	Satellite-1
High	Vertical	OPT/POS A-A	Satellite-1
Low	Horizontal	OPT/POS A-B	Satellite-2
Low	Vertical	OPT/POS A-B	Satellite-2
High	Horizontal	OPT/POS A-B	Satellite-2
High	Vertical	OPT/POS A-B	Satellite-2



Band	Polarization	Command	Satellite
Low	Horizontal	OPT/POS B-A	Satellite-3
Low	Vertical	OPT/POS B-A	Satellite-3
High	Horizontal	OPT/POS B-A	Satellite-3
High	Vertical	OPT/POS B-A	Satellite-3
Low	Horizontal	OPT/POS B-B	Satellite-4
Low	Vertical	OPT/POS B-B	Satellite-4
High	Horizontal	OPT/POS B-B	Satellite-4
High	Vertical	OPT/POS B-B	Satellite-4

A3.6 DiSEqC programs and commands in the HD RANGER UltraLite

► **Commands**

The **Commands** option allows executing any of the following commands:

COMMAND
SAT AB-A
SAT AB-B
SWITCH OPTION AB-A
SWITCH OPTION AB-B
DISABLE LIMITS
LIMIT EAST
LIMIT WEST
DRIVE ROTOR
GOTO
HALT
STORE
RECALCULATE
SWITCH 1A
SWITCH 1B
SWITCH 2A
SWITCH 2B
SWITCH 3A
SWITCH 3B
SWITCH 4A
SWITCH 4B
POWER
RESET
STANDBY



► **Programs**

There are eight predefined programs that execute basic functions to control an universal switch with two or four inputs. It also has more programs that control installations with 8 or 16 satellite antennas using SPAUN devices or switches Committed/Uncommitted. Whenever a **DiSEqC™** program is sent, the commands that correspond to the equipment status in relation to the Horizontal or Vertical polarization and High or Low frequency band are also sent. This allows assuring that the installation status is the one indicated by the equipment.

DiSEqC Programs		
16x1	LNB01	U1A2A/OpA_PoA
16x1	LNB02	U1A2A/OpA_PoB
16x1	LNB03	U1A2A/OpB_PoA
16x1	LNB04	U1A2A/OpB_PoB
16x1	LNB05	U1B2A/OpA_PoA
16x1	LNB06	U1B2A/OpA_PoB
16x1	LNB07	U1B2A/OpB_PoA
16x1	LNB08	U1B2A/OpB_PoB
16x1	LNB09	U1A2B/OpA_PoA
16x1	LNB10	U1A2B/OpA_PoB
16x1	LNB11	U1A2B/OpB_PoA
16x1	LNB12	U1A2B/OpB_PoB
16x1	LNB13	U1B2B/OpA_PoA
16x1	LNB14	U1B2B/OpA_PoB
16x1	LNB15	U1B2B/OpB_PoA
16x1	LNB16	U1B2B/OpB_PoB
8x1	LNB1	U1A/OptA_PosA
8x1	LNB2	U1A/OptA_PosB
8x1	LNB3	U1A/OptB_PosA
8x1	LNB4	U1A/OptB_PosB
8x1	LNB5	U1B/OptA_PosA
8x1	LNB6	U1B/OptA_PosB
8x1	LNB7	U1B/OptB_PosA
8x1	LNB8	U1B/OptB_PosB
	LNB4	(Sw1A-OptB-PosB)
	LNB8	(Sw1B-OptB-PosB)
		Position AB-A
		Position AB-A
		Sat A (Toneburst)
		Sat B (Toneburst)
		Switch Uncom.1/AA
		Switch Uncom.1/AB
		Switch Uncom.1/BA
		Switch Uncom.1/BB
		Switch Uncom.2/AA
		Switch Uncom.2/AB
		Switch Uncom.2/BA
		Switch Uncom.2/BB



ANNEX 4 REMOTE CONTROL COMMANDS

A4.1 Introduction

The design of *HD RANGER UltraLite* based on a microprocessor, allows data to be exchanged between the equipment and a remote controller (usually a personal computer) via USB. By this way, data can be obtained from the equipment and also control it remotely. These data can be stored and subsequently processed for use in maintenance work. Furthermore, the remote control allows tracking and monitoring installations.

A4.2 Protocol for communication between the *HD RANGER UltraLite* and a PC

This protocol is controlled by software and is using a virtual serial port over an USB interface. Data and information are exchanged using messages consisting of ASCII alphanumerical characters. This method ensures easy carrying between different types of personal computers.

To activate the virtual serial port, a special driver must be installed. The driver is included with the purchased instrument.

► Connections

The cable between the *HD RANGER UltraLite* and the PC is supplied with the equipment.

You need at least **Windows XP** to work with *HD RANGER UltraLite*. Drivers only work for Windows operative systems. What drivers do is to create a virtual COM port, so the software application can "see" the equipment.



A4.3 **Operation Mode**

The **HD RANGER UltraLite** accepts remote commands at any time, which the instrument is on. That is, it is not necessary to put the instrument in special remote control mode; rather, this mode is selected immediately when it detects a complete command during the time necessary for its execution. The protocol communication is as follows:

- 1.- **HD RANGER UltraLite** transmits a XON code (11H) every second. The aim is to indicate to any possible remote device that the equipment is ready to receive data.
- 2.- At this moment, data streams can be sent it. Each data stream is composed by:
 - a. Stream beginning: `*` (code 2AH).
 - b. Set of characters that describe data message.
 - c. CR (carriage return, code 0DH).
- 3.- Once a data stream has been sent, will be received a XOFF (code 13H) indicating that the transmission is stopped.
- 4.- Next, in case of correct message an ACK (acknowledge, code 06H) is expected or a NAK (not acknowledge, code 15H) in the opposite case.
- 5.- If the sent message requires answers it will be sent at this moment.
- 6.- Once completed the data stream transmission, the **HD RANGER UltraLite** will send a XON (code 11H) indicating that already it is prepared to receive a new data stream.

A typical communication chronogram would be as follows:

PC (REMOTE CONTROLLER)		HD RANGER UltraLite
1)		<----- XON
2)	*?TV<CR>	----->
3)		<----- XOFF
4)		<----- ACK 5
5)		<----- *TV0<CR>
6)	wait...	
7)		<----- XON

(all characters are transmitted in ASCII code).



Commands should always be sent in capital letter and cannot be edited online, i.e., once a character is received it is stored in the *HD RANGER UltraLite* buffer and cannot be rectified by sending an erase code.

Commands in remote control are divided into two groups, orders and interrogations. Orders modify a variable or the equipment status. Interrogations respond with information concerning equipment status or the value of a variable. For interrogative command, it is necessary to add the character '?' after the character '*'.

A4.4 **Virtual Serial Port Configuration**

In order to ensure error-free communication between the computer and the *HD RANGER UltraLite* you must programme following communication parameters into the control console via USB:

Rate:	115200 bits/s
Data bits:	8 bits
Parity:	No
Stop Bits:	1



A4.5 Remote commands table

Remote Commands	Short Description
BATTERY	It provides information about the battery actual status
CAPTURE	It builds a file with the current screen data in xml/png format
CAPTURE READ	It reads a file with the current screen capture
DISEQC	It gets a list of available diseqc programs and can send a specific one
EQUIPMENT POWER OFF	It shutdowns the equipment
EQUIPMENT SN	It provides the serial number of the equipment
INSTALLATION	It provides information about all the installations
INSTALLATION CURRENT	It provides information about the current installation
INSTALLATION CURRENT CLEAR	It removes all files of the current installation. The installation itself is not remove, only its contents
INSTALLATION CURRENT REMOVE	It removes the files of the same type in the current installation
INSTALLATION FILE	It reads an "xml" file of the current installation and sends it to a PC
INSTALLATION FILE ZIP	It reads an "xml" file of the current installation and sends all the installation files zipped to a PC
INSTALLATION PC FILE	It sends a file of the current installation to the PC
INSTALLATION PC ZIP	It sends a file from a PC to the equipment zipped with all files of the installation
INSTALLATION REMOVE	It removes an installation
IP CONFIG	It sets IPTV parameters
LNB	It provides / configures the LNB output
LTE	It provides / configures the LTE filter status
MEASURE	It provides information of all active measurements
MODE	It provides / sets the operation mode of the equipment
NAM	It provides the program name
PRINT SCREEN	It makes a screenshot in PNG format
PSI	It provides / configures services
PSI SERVICE	It provides / configures services
RTC	It provides / sets date and time
SIGNAL	It provides / configures the signal type
SPECTRUM	It configures the span and/or the reference level
TS	It selects the input and output transport stream
TUNE	It provides / configures the frequency
TUNE CH	It provides / configures the channel
TUNE PLAN	It configures a channel set
VER	It provides the version of the main software application
VIDEO	It configures the video source



Name	BATTERY		
Description:	It provides information about the battery current status.		
Question:	*?BATTERY <i>parameter</i>		
Response:	*BATTERY <i>parameter_resp</i>		
	<i>parameter</i>	<i>parameter_resp</i>	Description <i>parameter_resp</i>
	<empty>	LEVEL, PERCENT, TIME, SMART BATTERY, CHARGER	It provides a complete set of information about the battery current status (see the following parameters for an explanation).
	LEVEL	XXXXmV	It provides the voltage level in mV.
	PERCENT	XX	It provides the charge remaining as a percentage.
	TIME	XXmin	Provides an estimation of the remaining time of functioning. The time is given in minutes. Message CHARGER_CONNECTED will be the answer if the charger is connected.
	SMART_BATTERY	XXX	It answers YES or NO depending if there is a smart battery or not.
	CHARGER	XXX	It answers ON or OFF depending if charger is connected or not.

Name	CAPTURE	
Description	It builds a file with the current screen data in xml or png format.	
Configuration	*CAPTURE FORMAT= <i>format</i>	
	<i>format</i>	Description <i>format</i>
	PNG	It makes a screen capture in PNG format.
	XML	It makes a screen capture in xml format.
Note:	Before saving the file, this command deletes the previous made capture.	



Name	CAPTURE READ	
Description:	It reads a file with the current screen capture (see command CAPTURE)	
Question:	*?CAPTURE BLOCK= <i>bbbb</i> <CR>	
Response:	*CAPTURE SIZE= <i>size</i>	
	<i>bbbb</i>	Description <i>bbbb</i>
	<i>nnn</i>	<i>bbbb</i> is the number of bytes sent in each data block. The file data is sent in blocks, every block is confirmed with an ACK. The value 'bbbb' can be a decimal one (if starts by 0 to 9, like 1234) or in hex format, if started by "0x" followed by hex characters (like in 0x3FF).
	<i>size</i>	Description <i>size</i>
	<i>nnn</i>	Size in bytes (<i>nnn</i>) of file. Decimal value.
Protocol:	<p>PC→*?CAPTURE BLOCK=<i>bbbb</i> <cr> RANGER→ Xoff It checks if file exists then it sends ACK, otherwise it sends NACK + Xon and aborts the command. RANGER→*CAPTURE SIZE=<i>size</i>. RANGER→Xon. PC→ ACK. RANGER→Xoff. RANGER→block1 + crc (1 byte) + Xon. PC→ It Calculates the block crc if correct send ACK. RANGER→ If detect ACK then send Xoff. RANGER→block2 + crc2 (1 byte) + Xon. PC→ It Calculates the block crc if correct send ACK. Until last block.</p>	

Name	DISEQC	
Description:	It gets a list of available diseqc programs and can send a specific one.	
Question:	*?DISEQC PROGRAMS<CR>	
Response:	*DISEQC PROGRAMS= PROGRAMS= <i>nn</i> <i>program_name</i>	
	Response	Description <i>Inb_resp</i>
	PROGRAMS= <i>nn</i>	<i>nn</i> is the number of available programs
	<i>program_name</i>	the name description of the available programs
Configuration:	*DISEQC PROGRAM= <i>program_name</i>	
	Program_name	Description <i>program_name</i>
	POS_AB_A POS_AB_B etc...	It sends the diseqc program name. This program must exist in the current installation. Check the available programs with *?DISEQC PROGRAMS



Name	EQUIPMENT POWER OFF
Description	It shutdowns the equipment
Order	*EQUIPMENT POWEROFF

Name	EQUIPMENT SN
Description	It provides the serial number of the equipment
Question	*?EQUIPMENT SN
Response	*EQUIPMENT SN = <i>equipment_resp</i>
	<i>equipment_resp</i> Description <i>equipment_resp</i>
	nnn Unique numeric code that identifies the equipment

Name	INSTALLATION		
Description	It provides information about all the installations		
Question	*?INSTALLATION <i>install</i>		
Response	*INSTALLATION <i>install_resp</i>		
	<i>install</i>	<i>install_resp</i>	Description <i>install_resp</i>
	<empty>	NUMBER=nn	Number (nn) of installations
	CURRENT	NAME=name	Name (name) of current installation
		TER-CH=nn	Number (nn) of terrestrial channel plans in the current installation
		SAT-CH=nn	Number (nn) of satellite channel plans in the current installation
		DISEQC=nn	Number (nn) of DISEQC programs in the current installation
		SCREEN=nn	Number (nn) of print screens in the current installation
		DATALOGGER=nn	Number (nn) of dataloggers in the current installation
		SP=nn	Number (nn) of spectrum captures in the current installation
		MER=nn	Number (nn) of captures MERxcarrier in the current installation
		ECHOES=nn	Number (nn) of echo captures in the current installation
		CONSTELLATION=nn	Number (nn) of constellation captures in the current installation
	NUMBER=nn	NAME=name	Name of the installation with index "nn"



Name	INSTALLATION CURRENT		
Description	It provides information about the current installation		
Question	*?INSTALLATION CURRENT <i>current=nn</i>		
Response	*INSTALLATION NAME= <i>current_resp</i>		
	<i>current</i>	Description <i>nn</i> (decimal value)	Description <i>current_resp</i>
	<empty>	<empty>	Available data from the current installation
	TER-CH	Terrest. channel plan index	Terrestrial channel plan name with "nn" index
	SAT-CH	Sat. channel plan index	Satellite channel plan name with "nn" index
	DISEQC_PROGRAM	DISEQC program index	DISEQC program name with "nn" index
	PNG	Print screen file index	Print screen file name with "nn" index
	DATALOGGER	Datalogger index	Datalogger name with "nn" index
	SPECTRUM	Capture index	Spectrum capture name with "nn" index
	CONSTELLATION	Constellation index	Constellation capture name with "nn" index
	ECHOES	Capture index	Echo capture name with "nn" index
	MER	Capture index	MER capture name with "nn" index
	NUMBER	Installation index	Installation name with "nn" index

Name	INSTALLATION CURRENT CLEAR
Description	It removes all files of the current installation. The installation itself is not remove, only its contents
Order	*INSTALLATION CURRENT CLEAR



Name	INSTALLATION CURRENT REMOVE	
Description	It removes the files of the same type in the current installation	
Order	*INSTALLATION CURRENT REMOVE <i>tag=name</i>	
	<i>tag</i>	Description <i>tag</i>
	SPECTRUM	Spectrum capture file
	TER-CH	Terrestrial channel plan file
	SAT-CH	Satellite channel plan file
	DISEQC_PROGRAM	DISEQC program file
	PNG	Print screens file
	CONSTELLATION	Constellation capture file
	ECHOES	Echo capture file
	MER	MER x carrier capture file
	DATALOGGER	Datalogger file
	SPECTROGRAM	Spectrogram file
	MEROGRAM	Merogram file
	TS	Transport stream file
	<i>name</i>	Description <i>name</i>
	<empty>	It removes all files belonging to the same type, which is determined by the <i>tag</i>
	abcd	It removes the file with name ("abcd") of the type indicated by the <i>tag</i>



Name	INSTALLATION FILE	
Description	It reads an "xml" file of the current installation and sends it to a PC	
Question	*?INSTALLATION CURRENT <i>tag=name</i> BLOCK= <i>bbbb</i>	
Response	*INSTALLATION SIZE= <i>size</i>	
	<i>tag</i>	Description <i>tag</i>
	SPECTRUM	It reads spectrum captures in the current installation
	TER-CH	It reads terrestrial channel plans in the current install
	SAT-CH	It reads satellite channel plans in the current install
	DISEQC_PROGRAM	It reads DISEQC programs in the current installation
	PNG	It reads print screens in the current installation
	CONSTELLATION	It reads constellation captures in the current install
	ECHOES	It reads echo captures in the current installation
	MER	It reads MER x carrier captures in the current install
	DATALOGGER	It reads datalogger in the current installation
	SPECTROGRAM	It reads spectrograms in the current installation
	MEROGRAM	It reads merograms in the current installation
	TS	It reads transport stream in the current installation
	<i>name</i>	Description <i>name</i>
	abcd	Name ("abcd") of the capture.
	<i>bbbb</i>	Description <i>bb</i>
	nnn	Byte (nnn decimal) size to which the file will be divided to be send
	<i>size</i>	Description <i>size</i>
	nnn	File byte (nnn decimal) size when send



Name	INSTALLATION FILE ZIP	
Description	It reads an "xml" file of the current installation and sends all the installation files zipped to a PC	
Question	*?INSTALLATION CURRENT ZIP BLOCK= <i>bbbb</i>	
Response	*INSTALLATION SIZE= <i>size</i>	
	<i>bbbb</i>	Description <i>bb</i>
	<i>nnn</i>	Byte (<i>nnn</i> decimal) size to which the file will be divided to be send
	<i>size</i>	Description <i>size</i>
	<i>nnn</i>	File byte (<i>nnn</i> decimal) size when send

Name	INSTALLATION PC FILE	
Description	It sends a file of the current installation to the PC.	
Order	*INSTALLATION CURRENT tag= <i>name</i> SIZE= <i>size</i> BLOCK= <i>bbbb</i>	
	<i>tag</i>	Description <i>tag</i>
	SPECTRUM	Spectrum captures files to the current installation
	TER-CH	Terrestrial channel plans files to the current install
	SAT-CH	Satellite channel plans files to the current instal.
	DISEQC_PROGRAM	DISEQC programs files to the current installation
	PNG	Print screens files to the current installation
	CONSTELLATION	Constellation captures files to the current install
	ECHOES	Echo captures files to the current installation
	MER	MER x carrier captures files to the current install
	DATALOGGER	Datalogger files to the current installation
	SPECTROGRAM	Spectrograms files to the current installation
	MEROGRAM	Merograms files to the current installation
	TS	Transport stream files to the current installation
	<i>name</i>	Description <i>name</i>
	<i>abcd</i>	Capture name ("abcd").
	<i>size</i>	Description <i>size</i>
	<i>nnn</i>	File byte (<i>nnn</i> decimal) size when send
	<i>bbbb</i>	Description <i>bbbb</i>
	<i>nnn</i>	Byte (<i>nnn</i> decimal) size to which the file will be divided to be send



Name	INSTALLATION PC ZIP	
Description	It sends a file from a PC to the equipment zipped with all files of the installation	
Order	*INSTALLATION ZIP NAME= <i>name</i> SIZE= <i>size</i> BLOCK= <i>bbbb</i>	
	<i>name</i>	Description <i>name</i>
	abcd	Name ("abcd") of the installation
	<i>size</i>	Description <i>size</i>
	nnn	Byte (nnn decimal) size of the file when send
	<i>bbbb</i>	Description <i>bbbb</i>
	nnn	Byte size (nnn decimal) of blocks that will be send from the ZIP file

Name	INSTALLATION REMOVE	
Description	It removes a installation	
Order	*INSTALLATION NAME= <i>name</i> REMOVE	
	<i>name</i>	Description <i>name</i>
	abcd	Installation name ("abcd")

Name	IP CONFIG		
Description:	It provides / configures the IP parameters such as: DHCP option, MAC address, IP address and subnet MASK.		
Question:	*?IP <i>ip_option</i>		
Response:	*IP <i>ip_option=ip_resp</i>		
	<i>ip_option</i>	<i>ip_response</i>	
	<empty>	MAC, DHCP, IP and MASK	
	MAC	MAC address	
	DHCP	DHCP protocol enabled / disabled	
	ADDRESS	IP address	
	MASK	Subnet MASK	
Configuration:	*IP <i>ip_option=ip_config</i>		
	<i>ip_option</i>	<i>ip_config</i>	Description <i>lte_conf</i>
	DHCP	ON	It enables DHCP protocol
		OFF	It disables DHCP protocol
	ADDRESS	www.xxx.yyy.zzz	It sets IP address
	MASK	www.xxx.yyy.zzz	It sets Subnet mask



Name	LNB		
Description	It provides / configures the LNB output		
Question	*?LNB <i>Inb</i>		
Response	*LNB <i>Inb</i> = <i>Inb_resp</i>		
	<i>Inb</i>	Description <i>Inb_resp</i>	
	OUTPUT	Current selected output	
	ENABLE	LNB enable (ON) or disabled (OFF)	
	VOLTAGE	Last measurement of the LNB output voltage	
	CURRENT	Last measurement of the LNB output current	
	AVAILABLE	Available output with the current configuration	
	UNDERVOLTAGE	Under voltage alarm	
	OVERCURRENT	Overvoltage alarm	
	SHORTCIRCUIT	Short circuit alarm	
	DRAINLED	LED DRAIN lit (ON) or not (OFF)	
Configuration	*LNB <i>Inb</i> = <i>Inb_conf</i>		
	<i>Inb</i>	<i>Inb_conf</i>	Description <i>Inb_conf</i>
	ENABLE	ON	Enables the LNB.
	ENABLE	OFF	Disables the LNB.
	OUTPUT	nnn	LNB output voltage (<i>nnn</i> must be one of the available options seen on the command *?LNB AVAILABLE)



Name	LTE	
Description	It provides/configures the LTE filter status	
Question	*?LTE	
Response	*LTE <i>lte_resp</i>	
	<i>lte_resp</i>	Description <i>lte_resp</i>
	ON	LTE filter enabled
	OFF	LTE filter disabled
Configuration	*LTE <i>lte_conf</i>	
	<i>lte_conf</i>	Description <i>lte_conf</i>
	ON	It enables the LTE filter
	OFF	It disables the LTE filter

Name	MEASURE	
Description	It provides information of all active measurements	
Question	*?MEASURE <i>measure</i>	
Response	*MEASURE <i>measure=measure_resp units</i>	
	<i>measure</i>	Description <i>measure_resp</i>
	<empty>	All the active measures
	POWER	Digital channel power
	LEVEL	Analogue channel level
	C/N	C/N of the measured channel (dB)
	V/A	Video/Audio carrier ratio
	MER	MER measurement value
	CBER	CBER measurement value
	VBER	VBER measurement value
	LBER	LBER measurement value
	LM	Link Margin value
	=	Measurement within scale
	<	Measurement under the value shown
	>	Measurement over the value shown
	<i>units</i>	Description <i>units</i>
	dB	Measurement units for C/N, V/A, MER
	dBm/dBuV/dBmV	Measurement units for POWER, LEVEL



Name	MODE	
Description	It provides/sets the operation mode of the equipment	
Question	*?MODE	
Response	*MODE <i>mode_resp</i>	
	<i>mode_resp</i>	Description <i>mode_resp</i>
	TV	TV mode
	TV+SP+MEASURE	TV mode with spectrum and measurements
	TV+PARAMETERS	TV mode with TS parameters
	SP	Spectrum mode
	SP+MEASURE	Spectrum mode with measurement
	SP+MEASURE+TV	Spectrum mode with TV and measurement
	MEASURE	Measurement mode.
	MEASURE+TV+SP	Measurement mode with TV and spectrum
	MEASURE+PARAMETERS	Measurement mode with demodulator parameters
	ECHOES	Echoes tool
	CONSTELLATION	Constellation tool
Configuration	*MODE <i>mode_conf</i>	
	<i>mode_conf</i>	Description <i>mode_conf</i>
	TV	TV mode
	TV+SP+MEASURE	TV mode with spectrum and measurements
	TV+PARAMETERS	TV mode with TS parameters
	SP	Spectrum mode
	SP+MEASURE	Spectrum mode with measurement
	SP+MEASURE+TV	Spectrum mode with TV and measurement
	MEASURE	Measurement mode
	MEASURE+TV+SP	Measurement mode with TV and spectrum
	MEASURE+PARAMETERS	Meas. mode with demodulator parameters
	ECHOES	Echoes tool
	CONSTELLATION	Constellation tool

Name	NAM	
Description	It provides the program name	
Question	*?NAM	
Response	*NAM <i>nam_resp</i>	
	<i>nam_resp</i>	Description <i>nam_resp</i>
	abc	It provides the program name "abc"



Name	PRINT SCREEN	
Description	It makes a screenshot in PNG format	
Configuration	*PRINT SCREEN= <i>printscreen_conf</i>	
	<i>=printscreen_conf</i>	Description <i>=printscreen_conf</i>
	<empty>	It gives a name by default
	=abc	It gives the name "abc"

Name	PSI	
Description	It provides / sets services	
Question	*?PSI	
Response	*PSI STATUS= <i>status_resp</i> NUMBER= <i>number_resp</i> ONID= <i>onid</i> NID= <i>nid</i> TSID= <i>tsid</i> NETWORK= <i>name</i>	
	<i>status_resp</i>	Description <i>status_resp</i>
	ACQUIRED	Acquired services of channel (in this case, service information is not shown).
	IN_PROGRESS	Acquiring services of channel (in progress).
	FAIL	Acquisition failed.
	STOPPED	Acquisition stopped.
	<i>number_resp</i>	Description <i>number_resp</i>
	<i>nn</i>	Number of services
	<i>Services information</i>	Description <i>service information</i>
	ONID	Original Network id
	NID	Network id
	TSID	Transport Stream id
	NETWORK	Name of service network
Configuration:	*PSI SERVICE= <i>index_conf</i> [AUDIO= <i>index_audio</i>]	
	<i>index_conf</i>	Description <i>index_conf</i>
	<i>nn</i>	Index of service. Selecting service from the index service.
	<i>index_audio</i>	Description <i>index_audio</i>
	<i>nn</i>	Index of audio. OPTIONAL: [AUDIO=xx].
Configuration:	*PSI SID= <i>service_id_conf</i> [AUDIO= <i>index_audio</i>]	
	<i>service_id_conf</i>	Description <i>service_id_conf</i>
	<i>nn</i>	Service id. Selecting service from the service id.
	<i>index_audio</i>	Description <i>index_audio</i>
	<i>nn</i>	Index of audio. OPTIONAL: [AUDIO=xx].



Name	PSI SERVICE	
Description	It provides / configures services	
Question	*?PSI SERVICE= <i>service</i>	
	<i>service</i>	Description <i>service</i>
	CURRENT	Current service
	<i>nn</i>	Index of service
Response	*PSI SERVICE= <i>ss</i> NAME= <i>name</i> PROVIDER= <i>provider</i> SID= <i>sid</i> TYPE= <i>type</i> SCRAMBLED= <i>lcn</i>	
	<i>response</i>	Description <i>response</i>
	<i>ss</i>	CURRENT for current service or index of service.
	<i>name</i>	Service name
	<i>provider</i>	Service provider
	<i>sid</i>	Service id
	<i>type</i>	Type of service (radio/tv/data)
	<i>scrambled</i>	Service (service scrambled) or No (service free)
	<i>LCN</i>	Logical channel number
Question	*?PSI SERVICE=CURRENT AUDIO	
Response	*PSI NUMBER= <i>nn</i> AUDIO= <i>aa</i> PID= <i>pid</i> BITRATE= <i>bitrate</i> TYPE= <i>type</i> FORMAT= <i>format</i> LANGUAGE= <i>language</i>	
	<i>response</i>	Description <i>response</i>
	<i>nn</i>	Audios number
	<i>aa</i>	Index of audio
	<i>pid</i>	PID number
	<i>bitrate</i>	Bitrate in kbps
	<i>type</i>	Type of audio (MPEG-1, DD, DD+...)
	<i>format</i>	Format of audio (Stereo/Mono...)
	<i>language</i>	Language of audio
Question	*?PSI SERVICE= <i>service</i> AUDIO	
Response	*PSI NUMBER= <i>nn</i>	
	<i>response</i>	Description <i>response</i>
	<i>nn</i>	Audios number
Question	*?PSI SERVICE= <i>service</i> AUDIO= <i>aa</i>	
Response	*PSI NUMBER= <i>nn</i> AUDIO= <i>aa</i> PID= <i>pid</i> TYPE= <i>type</i> LANGUAGE= <i>language</i>	
	<i>response</i>	Description <i>response</i>
	<i>nn</i>	Audios number
	<i>aa</i>	Index of audio
	<i>pid</i>	PID number
	<i>type</i>	Type of audio (MPEG-1, DD, DD+...)
	<i>language</i>	Language of audio



Question	*?PSI SERVICE=CURRENT VIDEO	
Response	*PSI PID= <i>pid</i> BITRATE= <i>bitrate</i> TYPE= <i>type</i> RESOLUTION= <i>resolution</i> FORMAT= <i>format</i> FRAME= <i>frame</i> PROFILE= <i>profile</i>	
	<i>response</i>	Description <i>response</i>
	<i>pid</i> <i>bitrate</i> <i>type</i> <i>resolution</i> <i>format</i> <i>frame</i> <i>profile</i>	PID number Bitrate in kbps Type of video (MPEG-2,H264,...). Resolution of video. Format of video (16:9/4:3...) Freq Profile level
Question	*?PSI SERVICE=xx VIDEO	
Response	*PSI PID= <i>pid</i> TYPE= <i>type</i>	
	<i>response</i>	Description <i>response</i>
	<i>pid</i> <i>type</i>	PID number Type of audio (MPEG-2, H264,...)
Question	*?PSI SERVICE= <i>service</i> DATA	
Response	*PSI NUMBER= <i>nn</i>	
	<i>response</i>	Description <i>response</i>
	<i>nn</i>	Number of datas
Question	*?PSI SERVICE= <i>service</i> DATA= <i>dd</i>	
Response	*PSI NUMBER= <i>nn</i> DATA= <i>dd</i> PID= <i>pid</i> TYPE= <i>type</i>	
	<i>response</i>	Description <i>response</i>
	<i>nn</i> <i>dd</i> <i>pid</i> <i>type</i>	Number of datas Index of data PID number Type of data (txt, subtitles, data...)



Name	RTC		
Description	It provides/sets date and time		
Question	*?RTC <i>rtc</i>		
Response	*RTC <i>rtc=rtc_resp</i>		
	<i>rtc</i>	<i>rtc_resp</i>	Description <i>rtc_resp</i>
	TIME DATE FORMAT	DATE=date TIME=time FORMAT=format hh:mm:ss DD/MM/YYYY DD/MM/YY MM/DD/YYYY YYYY/MM/DD	It shows current date, time and date format Hours:minutes:seconds day/month/year day/month/year (last two digits) month/day/year year/month/day Selected format
Configuration	*RTC <i>rtc= rtc_conf</i>		
	<i>rtc</i>	<i>rtc_conf</i>	Description <i>rtc_conf</i>
	TIME DATE FORMAT	hh:mm:ss DD/MM/YYYY DD/MM/YY MM/DD/YYYY YYYY/MM/DD	Hours:minutes:seconds Date according to the selected format day/month/year day/month/year (last two digits) month/day/year year/month/day



Name	SIGNAL		
Description	It provides/configures the signal type		
Question	*?SIGNAL <i>signal</i>		
Response	*SIGNAL <i>signal=signal_resp</i>		
	<i>signal</i>	Description <i>signal_resp</i>	
	TYPE	Signal standard type	
	CR	Current code rate	
	BANDWIDTH	Signal bandwidth	
	SR	Signal symbol rate	
	SP	Spectral inversion enabled (ON) or disabled (OFF)	
	MODE	Measurement of the FFT in a COFDM modulation	
	GI	Measurement of the guard interval	
	CONSTELLATION	Constellation type	
	HIERARCHY	DVB-T hierarchy	
	COLOR	Type of colour coding	
	STANDARD	Analogue standard type	
	RATE	Field frequency	
Configuration	*SIGNAL <i>signal=signal_config</i>		
	<i>signal</i>	<i>signal_config</i>	Description <i>signal_config</i>
	TYPE	DVB-T	Terrestrial signal standard
		DVB-C	Cable signal standard
		ANALOG	Analogue signal standard
		DVB-S	Satellite signal standard
		DVB-S2	Satellite signal standard (2d generation)
	COLOR	PAL	PAL coding colour
		NTSC	NTSC coding colour
		SECAM	SECAM coding colour
	STANDARD	BG	Analogue standard type BG
		DK	Analogue standard type DK
		I	Analogue standard type I
		N	Analogue standard type N
		M	Analogue standard type M
		L	Analogue standard type L



Name	SPECTRUM		
Description	It configures the <i>span</i> and/or the reference level		
Configuration	*SPECTRUM <i>spectrum=spectrum_config</i>		
	<i>spectrum</i>	<i>spectrum_config</i>	Description <i>spectrum_config</i>
	REF	nn.n	Value (nn.n) of the reference level in units of the current band
	SPAN	nnnF	nnn= span value number F= Order of magnitude for the span. F values: <empty> = 1 K= 1 x 10 E3 M=1 x 10 E6 G=1 x 10 E9

Name	TS MUX CONTROL	
Description:	It selects the input and output transport stream	
Configuration:	*TSMUX, DECODER= <i>decoder_input</i> , OUT= <i>asi_out</i>	
	<i>decoder_input</i>	Description <i>decoder_input</i>
	DEMOD	Input from demodulators.
	ASI_IN	Input from ASI_IN.
	IPTV	Input from IPTV (when equipment is on a IPTV mode I.E. IPTV+TV).
	<i>asi_out</i>	Description <i>asi_out</i>
	OFF	No ASI output signal.
	DEMOD	Output from demodulators.
	ASI_IN	Output from ASI_IN.
	IPTV	Output from IPTV (when equipment is on a IPTV mode I.E. IPTV+TV).



Name	TUNE	
Description	It provides/configures the frequency	
Question	*?TUNE	
Response	*TUNE BAND= <i>band_resp</i> FREQ= <i>freq_resp</i>	
	<i>band_resp</i>	Description <i>band_resp</i>
	TER	Terrestrial band
	SAT	Satellite band
	<i>freq_resp</i>	Description <i>freq_resp</i>
	nnnK	nnn=Number value for the frequency; K= (kHz)
Configuration	*TUNE BAND= <i>band_conf</i> FREQ= <i>freq_conf</i>	
	<i>band_conf</i>	Description <i>band_conf</i>
	TER	Terrestrial band
	SAT	Satellite band
	<i>freq_conf</i>	Description <i>freq_conf</i>
	nnnF	nnn= Number value for the frequency F= Order of magnitude for the frequency F values: <empty> = 1 K= 1 x 10 E3 M=1 x 10 E6 G=1 x 10 E9



Name	TUNE CH		
Description	It provides/configures the channel		
Question	*?TUNE CH		
Response	*TUNE BAND= <i>band_resp</i> PLAN= <i>plan_resp</i> CH= <i>ch_resp</i>		
	<i>band_resp</i>	Description <i>band_resp</i>	
	TER	It means that channel belongs to the terrestrial band	
	SAT	It means that channel belongs to the satellite band	
	<i>plan_resp</i>	Description <i>plan_resp</i>	
	xyz	Alphanumeric code that identifies the channel plan	
	<i>ch_resp</i>	Description <i>ch_resp</i>	
	xyz	Alphanumeric code that identifies the channel	
Configuration	*TUNE <i>ch_conf</i>		
	<i>ch_conf</i>	Description <i>ch_conf</i>	
	CH=xyz	"xyz" is an alphanumeric code that identifies a channel	
	CH NEXT	It increases +one channel	
	CH PREV	It decreases -one channel	

Name	TUNE PLAN		
Description	It configures a channel plan		
Configuration	*TUNE PLAN= <i>plan_conf</i>		
	<i>plan_conf</i>	Description <i>plan_conf</i>	
	xyz	Alphanumeric code that identifies a channel plan	

Name	VER		
Description	It provides the version of the main software application		
Question	*?VER		
Response	*VER <i>ver_resp</i>		
	<i>ver_resp</i>	Description <i>ver_resp</i>	
	x.yy.zzz	Alphanumeric code that identifies a version	

Name	VIDEO		
Description	It configures the video source		
Configuration	*VIDEO <i>video</i> = <i>video_conf</i>		
	<i>video</i>	<i>video_conf</i>	Description <i>video_conf</i>
	SOURCE	INTERNAL	It enables internal video source
		EXTERNAL	It enables external video source
	SYSTEM	PAL_50 Hz	It enables the video system selected
		PAL_60 Hz	It enables the video system selected
		NTSC	It enables the video system selected
		SECAM	It enables the video system selected



ANNEX 5 DIGITAL DIVIDEND (LTE)

5.1 Introduction

LTE (Long Term Evolution) is a standard for mobile data connection, commonly called 4G, with up to 44 frequency bands assigned. These bands are located in the radio spectrum between the frequencies 698 MHz and 3600 MHz.

Although LTE standard is applied virtually worldwide, each country and each operator chooses the bands and the individual technological aspects of its implementation.

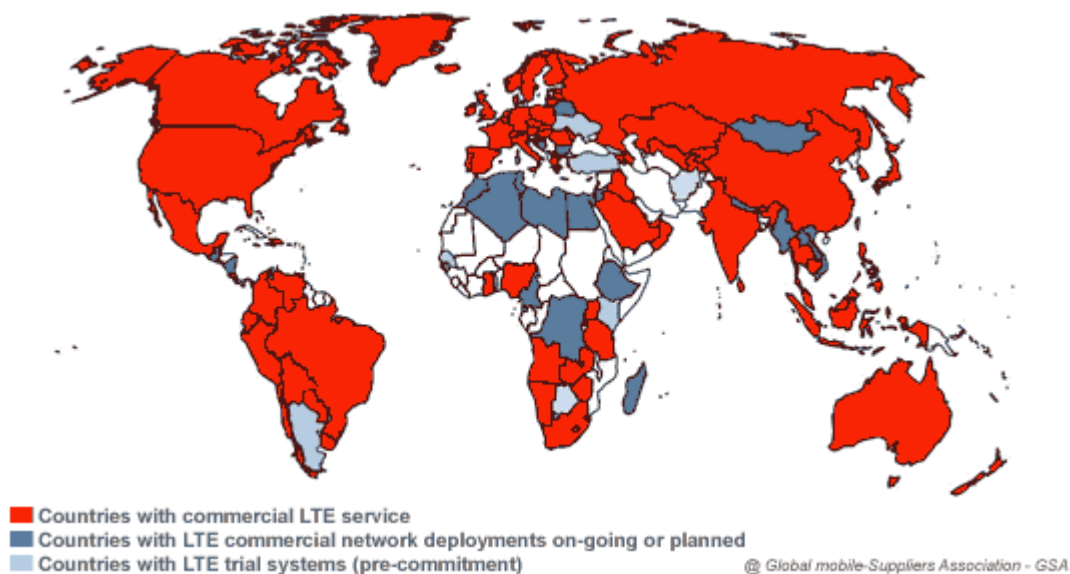

Figure A5.1. Map of 4G-LTE deployment in late 2014.
© Global mobile-Suppliers Association - GSA.

5.2 Why LTE is a problem for television installations?

As TV installers, LTE worries us because of its ability to generate interferences over the TV signals, especially in those cases where an LTE repeater is located in the surroundings of our receiving antenna. Specifically, the band 20 in the LTE (also called LTE-800) corresponds to frequencies between 791 MHz and 862 MHz, and it is one of the bands that will be used in Europe.



Currently, TV operators are restructuring some UHF channels in order to release the frequencies corresponding to the band LTE-800. These channels are those between 61 and 69 inclusive. This process is called "Digital Dividend". After migration of frequencies has been completed, the mobile operators, which own the concession, will begin to transmit LTE signals.

5.3 **Detection and correction of LTE interferences**

Fortunately, all the PROMAX field strength meters in the **HD RANGER** series have tools to detect and correct any interference caused by LTE / 4G mobile phone signals.

The interference caused over DTT signals by LTE can be produced because of near 4G mobile telephony base stations, as well as the proximity of mobile devices that use this band. The TV reception installations, especially in the channels near to LTE-800 band, can be protected from interference with the installation of a filter to reject the LTE band. Such filters are easily found in shops, are easy to install and have a reasonably high attenuation for such interfering signals.

5.4 **Step by Step: Solving the case of a LTE interference with any HD RANGER field strength meter**

Now we are going to simulate a case of interference and how it can be solved with a field strength meter of the HD RANGER series.

The best option is to start measuring the highest power of LTE signals in the band between 791 MHz and 862 MHz. This frequency band comprises a first block for downlink with 6 channels of 5 MHz bandwidth each, and a second block for uplink with the same distribution. See this spectrum in the following figure:

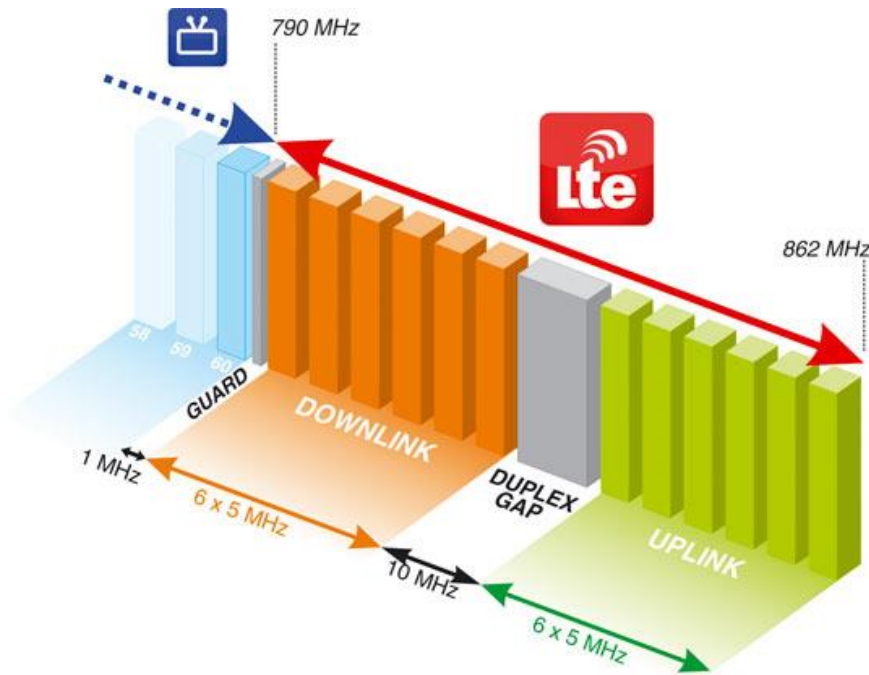

Figure A5.2 Picture of the terrestrial band occupied by LTE frequencies.

We will use the **Spectrum Analyser** mode with the **Max Hold** and **Marker option**. Now the step by step explanation.

- 1 First tune the channel 60 in the 786 MHz frequency. This is the last channel currently available for DTT (or highest frequency channel in the UHF band, in our case).DT (o el canal de frecuencia más alta en la banda de UHF, en nuestro caso).

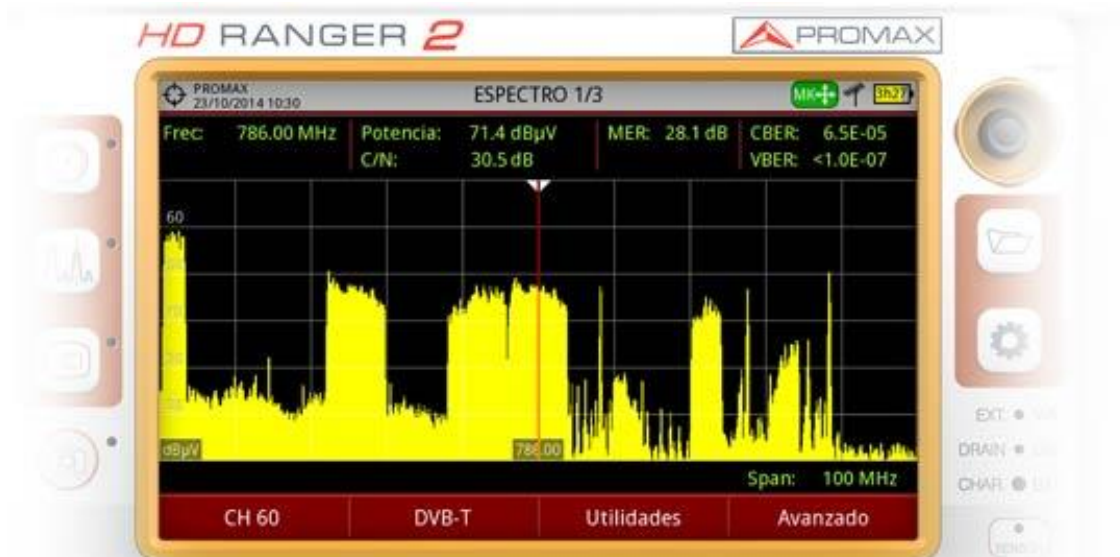

Figure A5.3 Pointer over the spectrum at channel 60 in the terrestrial band. The spectrum band reserved for LTE is visible on the right.

- 2 In the **Spectrum Analyser** mode, drop down the **Advanced** menu and select the **Max Hold** option in Permanent mode. Keep in mind that the LTE signal changes continuously its power, according to the instant traffic data. With this option, we can view on screen not only the signals in real time but also the peak values. A trace in blue shows the peaks.

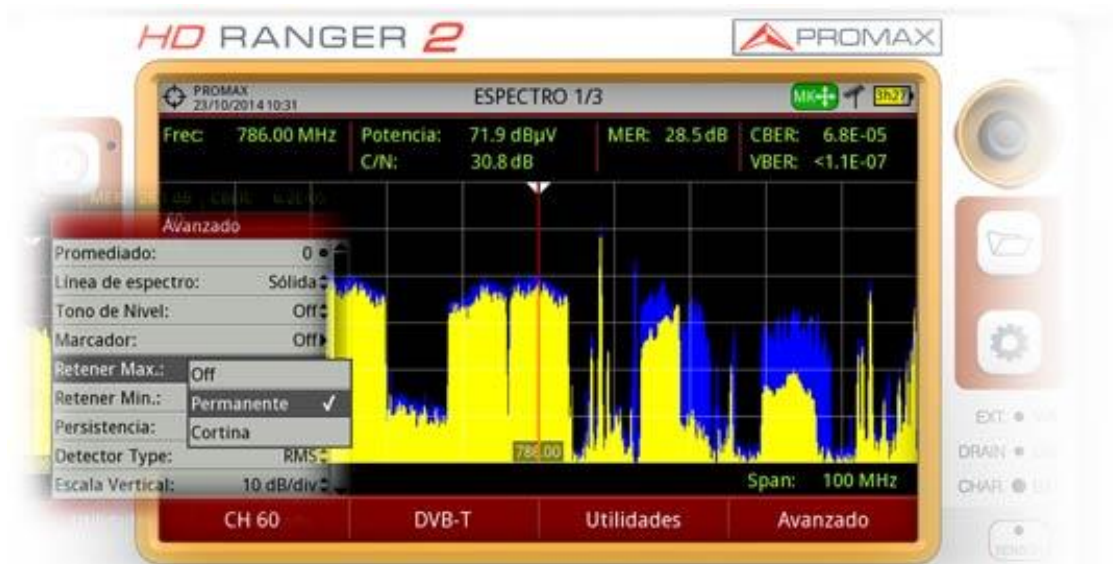

Figure A5.4 Max hold on the signal. The maximum power of the spectrum is traced in blue, behind the real-time spectrum (yellow).

- 3 Then, drop down again the **Advanced** menu and switch the **Marker** option to ON. With the joystick move the marker to the LTE channel at the lowest frequency. In our case, we assume that this frequency is 793.5 MHz, the first data multiplex at the downlink area. With these settings we can quantify in real time the difference between real-time DTT levels and the LTE signal.
- 4 The experience, to observe pixelations in the image or artefacts in the sound, as well as measurements of the TV signal quality, especially the MER, will tell us if we are in a risk situation.

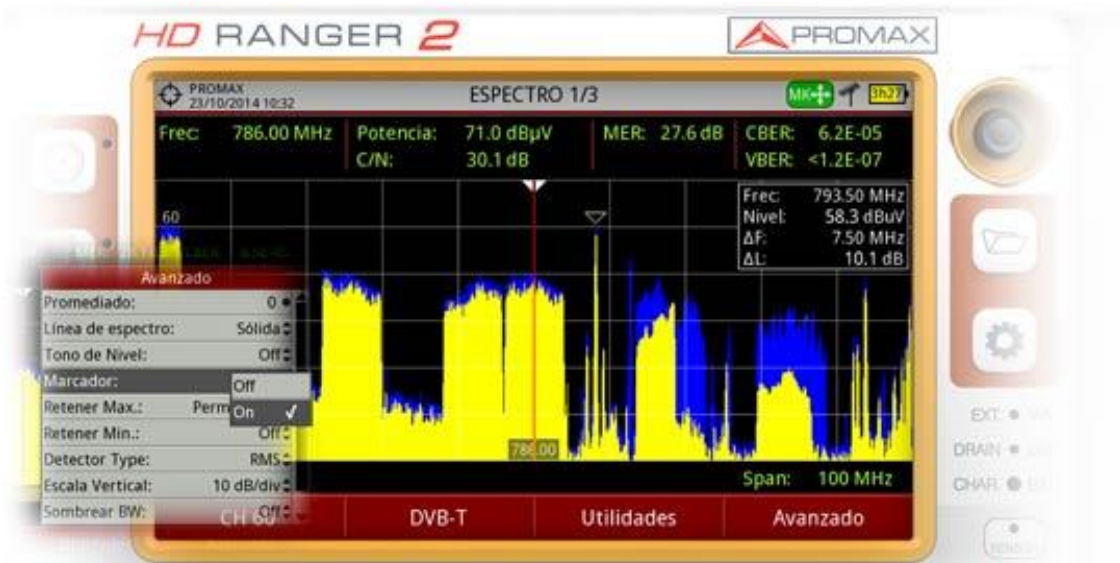

Figure A5.5 Marker enabled and placed in one of the LTE channels, at the frequency 793.5 MHz.

- 5 In case of anomalies on the DTT signal, the procedure to follow would be to connect a filter in the RF signal to determine if the presence of LTE signals is the cause of our interferences.

In the **HD RANGER UltraLite**, this filter should be external to the equipment and can be easily connected, by screwing it in the proper input connector (see photo).



Figure A5.6 LTE filter coupled to a **HD RANGER Lite** field strength meter.



5.4 LTE filter built-in the **HD RANGER+** and **HD RANGER 2** meters

The most advanced equipment such as the **HD RANGER +** and the **HD RANGER 2**, have a built-in rejection filter for the LTE band. This filter can be enabled to check if the quality of the TV signal reception improves, when much of the LTE band has been attenuated by the filter.

To be clarified that these filters, internal or external, cannot completely remove the LTE band signals. Especially for the TV channels close to 790 MHz, where is the end for the current UHF. If we are close to a LTE station with low downlink channels, (as in the example) a filter cannot be a sufficient solution.

Other options to better mitigate the LTE signals can be considered, such as a change in the location of the TV antenna or a passive shield in the way between the two antennas (TV and LTE).

As an additional feature, the **HD RANGER +** and the **HD RANGER 2** equipment have a specific tool for LTE, called LTE Ingress Test. With this tool you can measure the MER of a DTT channel, presumably affected by an LTE signal, and evaluate the effects of enabling an LTE filter.

Specifically, in the screen of this tool you can view the spectrum of the LTE-800 band between frequencies 776 and 876 MHz. In the measurement window is shown the minimum and maximum MER for the tuned TV channel (the one we suspect may be affected by a possible interference of a LTE signal) and the minimum and maximum power in the LTE bandwidth. The measurement can be done with the filter on and off.

By this way, the installer will check if the installation of a filter will absorb the effects of the LTE signal and if it affects in a positive way the quality of reception for the television signals.

With these options, the **HD RANGER** field strength meters are the ones better prepared to deal with interference problems that may arise with the beginning of the LTE emissions.



ANNEX 6 TRANSPORT BELT INSTRUCTIONS

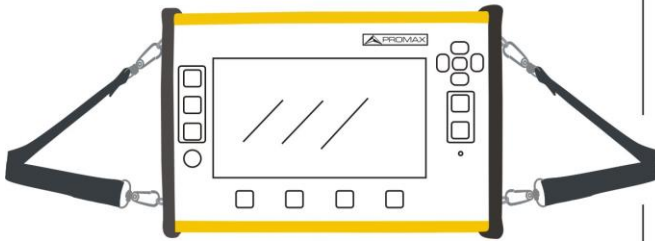



ANNEX 7 MULTIMEDIA CONTENT

Next it is the list with all the links of the multimedia content in the user's manual:

TITLE	LINK
Introducing the <i>HD</i> RANGER Series	http://youtu.be/XpNxlOSfkf0
Navigating through the menus	http://youtu.be/Zm_QT-qtY4
Switching satellite/terrestrial bands	http://youtu.be/ecv1P0Cf_fI
Manual input of frequencies	http://youtu.be/81I5ezO4cgg
DVB-S2 multi stream decoding	http://youtu.be/xuv9ESed_Ak
What is LTE?	http://youtu.be/ZNPeDC4K-YI
Datalogger	http://youtu.be/TUuHJBX0BQI?t=3m55s
Channel plan exploration	http://youtu.be/TUuHJBX0BQI?t=2m54s
Installation manager	http://youtu.be/TUuHJBX0BQI
Generating a measurement report	http://youtu.be/fQP8n-59pHc
Creation of a channel plan	http://youtu.be/YwbpfRNGJYI



PROMAX ELECTRONICA, S. L.

Francesc Moragas, 71-75
08907 L'HOSPITALET DE LLOBREGAT (Barcelona)
SPAIN
Tel. : 93 184 77 00 * Tel. Intl. : (+34) 93 184 77 02
Fax : 93 338 11 26 * Fax Intl. : (+34) 93 338 11 26
<http://www.promaxelectronics.com>
e-mail: promax@promaxelectronics.com