

SEKONIC

Light Meter

**SPEEDMASTER
L-858D**

L-858D-U

Startup Guide

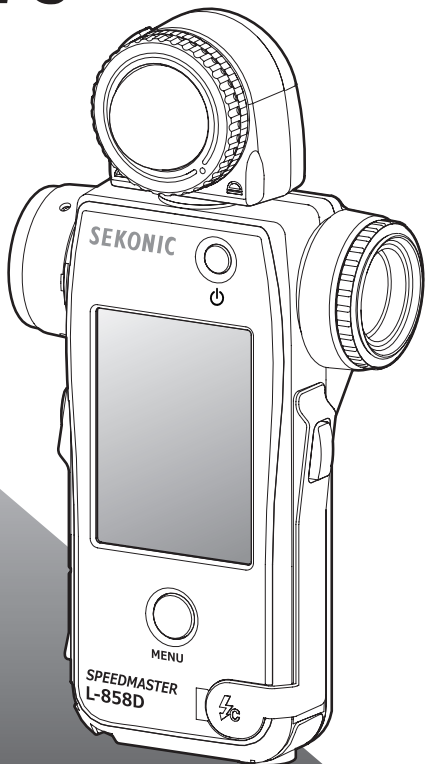

Thank you for purchasing SPEEDMASTER L-858D.

Please read the "Operating Manual" and "Safety Precaution" so that you will fully understand the features and operation of this product.

Keep the Operating Manual in a safe place for future use.

This Startup Guide introduces the basic operations of this light meter.







For details about how to use this light meter, please see the Operating Manual.

For information on how to download the Operating Manual, please see "10. Download".

1. Check Included Items

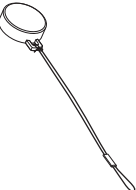
The following items are included with the meter in the package. Please be sure to check that all noted items are included.

- * If any items are missing, please contact the distributor or the reseller you purchased the meter from.
- * The USB cable (that has the A connector and Micro-B connector) is not included in the package. Please obtain this separately.
- * Batteries (two AA, Alkaline and manganese batteries are recommended) are not included in the package. Please obtain these separately.

Meter	Startup Guide (this document)	Strap	Lens Cap (Installed on the meter)
			
Soft Case	Anti-glare Sheet for LCD Screen	Safety Precaution	
			

2. Names of Parts

The following is a list of names of buttons and parts on the meter.

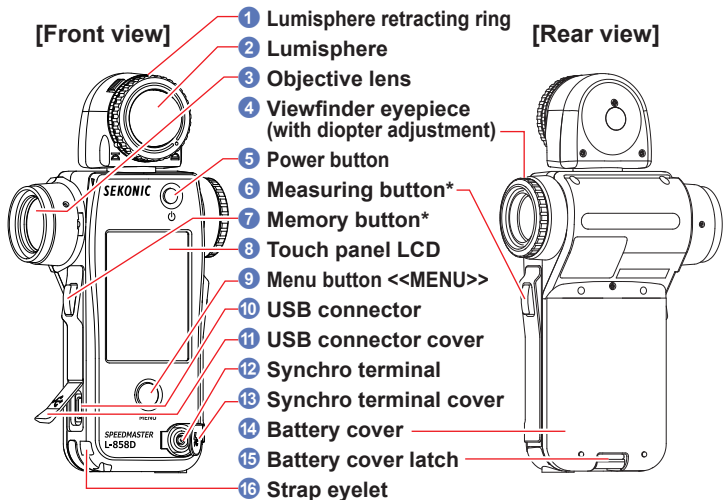

[Bottom (rear) view, battery cover]

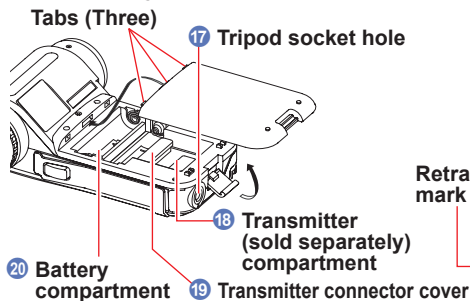

[Lumisphere (Switchover between Extended/Retracted)]

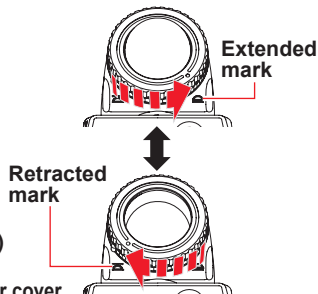

* The function of the Measuring button **6** and Memory button **7** can be interchanged using the Custom Setting function.

3. Turn the Power ON/OFF

After installing batteries, press the power button ⑤ to start up the meter. The Startup screen appears on the LCD for 1 second.

Then the settings for the Measuring button (MEASURE) and Memory button (MEMORY) are displayed on the Measuring screen for 2 seconds.

To turn the power off, press and hold down the Power button for at least 1 second.

The meter power turns off after the display disappears.

Please wait 3 seconds between repeated power on and power off sessions.

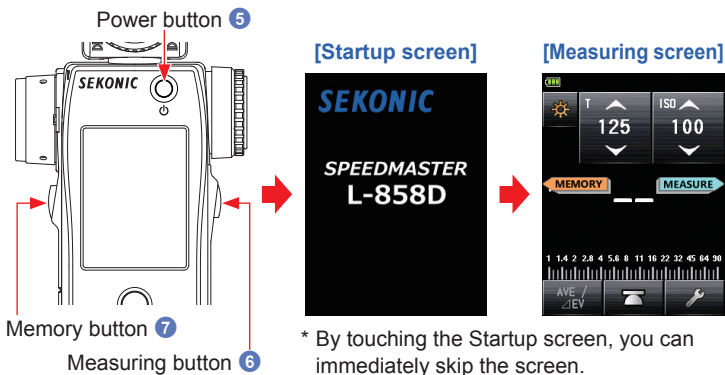

NOTICE

- The blue lettered "SEKONIC" logo screen is displayed after battery replacement and 24 hours after power OFF.
- Movement of the blue status bar indicates that the meter is checking its memory and preparing to operate. Do not turn the power OFF. Otherwise, the meter may be damaged.



4. Screen Operations

This section explains how to operate the touch panel on the meter.

Touch an icon with your finger to select a desired menu or item.

[Measuring screen]

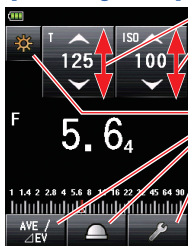



Slide operations

Slide a finger up or down on the setting value areas at any time to change setting values.

Touch operations

Touch each icon to change the display to a desired screen.

Setting value increases when  is touched.
Setting value decreases when  is touched.

Scroll bars

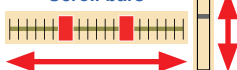

Scroll bars

Slide the vertical or horizontal scroll bars to view a different part of the screen.

Radio button operations

Radio buttons are displayed when you can only select one item. Touch a desired item to select.

Check box operations

Check boxes are displayed when multiple selections are available. Touch a desired item(s) to select.

[Screen For Selecting LCD Backlight Brightness]

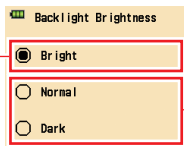

Item selected

Items not selected

[Flash Mode screen]

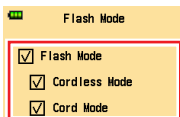

Items selected

[Ambient Mode screen]

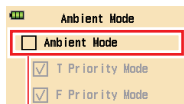

Item not selected

5. Input Numbers or Characters

[Numeric Value Input screen]

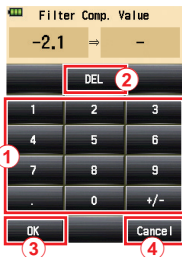

How to input a numerical value
(Numeric Number Input screen)

No.	Key	Description
①	0-9, Decimal point, Sign (+/-)	Inputs a numerical value. When touched, the input value is displayed at the top of screen.
②	DEL	Deletes the input value.
③	OK	Applies the input value, and returns to the previous screen.
④	Cancel	Cancels the input value, and returns to the previous screen.

[Upper Case Input screen]

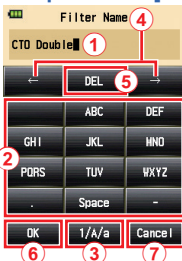

How to input characters and numbers
(Character Input screen)

No.	Key	Description
①	█	The cursor indicates the position at which to enter a character.
②	ABC, abc, 0-9, Decimal point, Space, Hyphen	When touched, the input value is displayed at the top of screen. Repeated touching of the same button for alphabet (ABC/abc) will change the alphabet character in order.
③	1/A/a	Switches between numbers, upper-case characters, and lower-case characters.
④	← →	Moves the input position.
⑤	DEL	Deletes the input value.
⑥	OK	Applies the input value, and returns to the previous screen.
⑦	Cancel	Cancels the input value, and returns to the previous screen.

[Lower Case Input screen]



6. Measuring Preparations

The mode and other settings required to make a measurement can be selected from the Measuring screen. For information on how to switch the display to each screen, see the relevant item.

[Measuring Mode Selection screen]

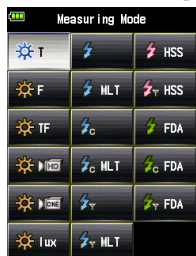

[Meter] (Measuring screen)

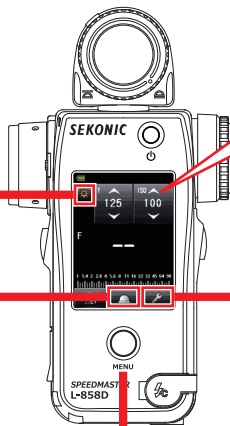

Settings



[Select Incident/Spot screen]



[Tool Box screen]

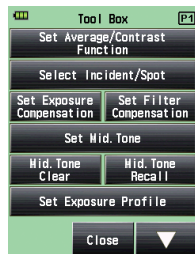

[Menu screen]

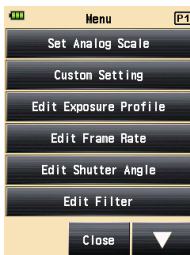

* When another function has been assigned by using the custom setting, select Incident/Spot from Tool Box.

7. Select Measuring Mode

Different measuring modes can be selected to meet various requirements.

* In the custom setting, you can select whether to display or hide the measuring modes. Content to be displayed differs depending on which transmitter (sold separately) is installed.

[Measuring Mode Selection screen]



① [Ambient Light T Priority Mode Measuring screen]

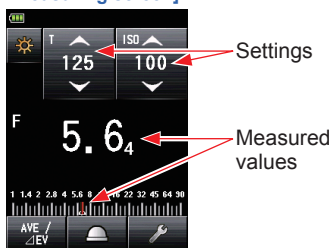

<Ambient Mode>

No.	Description of mode
①	Ambient light T (shutter speed) priority mode Displays F-stop value (aperture) for input shutter speed and ISO values.
②	Ambient light F-stop (aperture) priority mode Displays shutter speed value for input F-stop and ISO values.
③	Ambient light TF (shutter speed and F-stop) priority mode Displays ISO sensitivity for input shutter speed and F-stop values.
④	Ambient light HD CINE mode Displays F-stop value for input shutter speed, frame rate and ISO values.
⑤	Ambient light CINE mode Displays F-stop value for input frame rate, ISO and shutter angle values.
⑥	Ambient light Illuminance (lux or fc) mode (Incident light measurement) Displays brightness value in lux or foot-candle unit.
	Ambient light Luminance (cd/m² or fl) mode (Reflected light measurement) Displays brightness value in cd/m ² or foot-lambert unit.

② [Ambient Light F-stop Priority Mode Measuring screen]

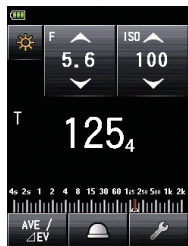

③ [Ambient Light TF Priority Mode Measuring screen]

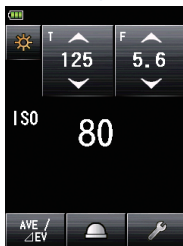

④ [Ambient Light HD Cine Mode Measuring screen]

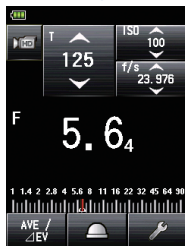

⑤ [Ambient Light Cine Mode Measuring screen]



⑥ [Ambient Light Illuminance Mode Measuring screen]

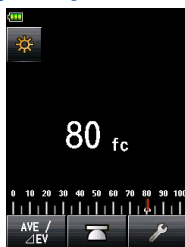
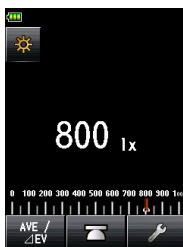

* In incident light mode

⑥ [Ambient Light Luminance Mode Measuring screen]

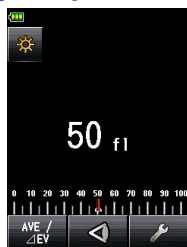
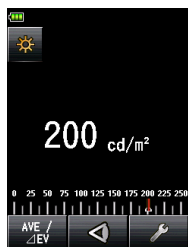

* In reflected light mode

<Flash Mode>

[Measuring Mode Selection screen]

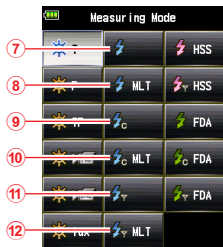

For Flash analyzing display

Ambient light (Orange)

Flash light (Blue)

⑦ [Cordless Flash Mode Measuring screen]

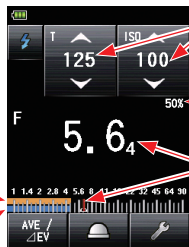

Settings

Percentage of flash

Measured values (F-stop values)

No.	Description of mode
⑦	Cordless flash mode Detects flash brightness without meter-flash connection after Measuring button pressed to arm meter for 90 seconds and flash fired separately, and displays F-stop value.
⑧	Cordless multiple (cumulative) flash mode Detects and accumulates flash brightness without meter-flash connection after Measuring button pressed to arm meter for 90 seconds and flash fired separately, and displays F-stop value.
⑨	Cord flash mode Detects flash brightness with synchro cord meter-flash connection, and displays F-stop value.
⑩	Cord multiple (cumulative) flash mode Detects and accumulates flash brightness with synchro cord meter-flash connection, and displays F-stop value.
⑪	Radio triggering flash mode Detects flash brightness after Measuring button is pressed to send radio transmitted signal to radio receiver connected to flash. Displays F-stop value (When a transmitter sold separately is installed).
⑫	Radio triggering multiple (cumulative) flash mode Detects and accumulates flash brightness after Measuring button is pressed to send radio transmitted signal to radio receiver connected to flash. Displays F-stop value (When a transmitter sold separately is installed).

⑧ [Cordless Multiple (Cumulative) Flash Mode Measuring screen]

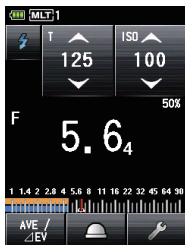

⑨ [Cord Flash Mode Measuring screen]

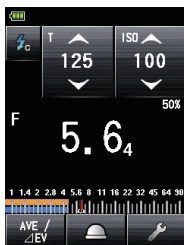

⑩ [Cord Multiple (Cumulative) Flash Mode Measuring screen]

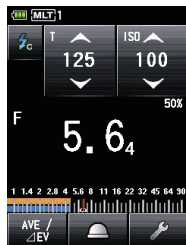

⑪ [Radio Triggering Flash Mode Measuring screen]

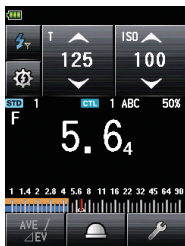

⑫ [Radio Triggering Multiple (Cumulative) Flash Mode Measuring screen]

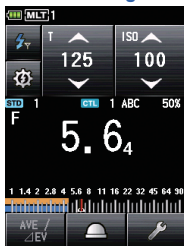

* Switching analog scales in Flash mode

[When Flash analyzing analog scale is Off (Mid. tone is not set)]

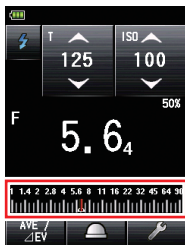

[When Flash analyzing analog scale is On]

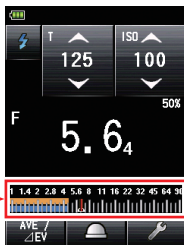

[When Flash analyzing analog scale is Off (Mid. tone is set)]

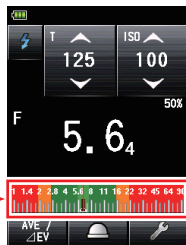

Touching the scale changes the display.

<HSS Flash Mode/Flash Duration Analysis Mode>

[Measuring Mode Selection screen]

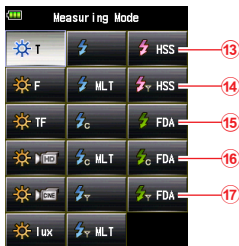

⑬ [HSS Flash Cordless Mode Measuring screen]

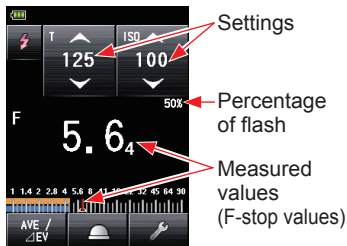

No.	Description of mode
⑬	<p>HSS (High Speed Synchro) flash cordless mode Select this mode to measure the brightness of a flash activated in HSS (High Speed Synchro) mode. Detects flash brightness without meter-flash connection after Measuring button pressed to arm meter for 90 seconds and flash fired separately, and displays F-stop value.</p>
⑭	<p>HSS (High Speed Synchro) flash radio triggering mode (for RT-GX only) Select this mode to measure the brightness of a flash activated in HSS (High Speed Synchro) mode. Detects flash brightness after Measuring button is pressed to send radio transmitted signal to radio receiver connected to flash. Displays F-Stop value (When a transmitter sold separately is installed).</p>
⑮	<p>Flash duration analysis cordless mode Detects flash brightness without meter-flash connection after Measuring button pressed to arm meter for 90 seconds and flash fired separately, and displays flash duration time, graph of flash wave form and F-stop value.</p>
⑯	<p>Flash duration analysis cord mode Detects flash brightness with synchro cord meter-flash connection, and displays flash duration time, graph of flash wave form and F-stop value.</p>
⑰	<p>Flash duration analysis radio triggering mode Detects flash brightness after Measuring button is pressed to send radio transmitted signal to radio receiver connected to flash. Displays flash duration time, graph of flash wave form and F-stop value (When a transmitter sold separately is installed).</p>

⑮ [HSS Flash Radio Triggering Mode Measuring Screen] (for RT-GX only)



⑮ [Flash Duration Analysis Cordless Mode Measuring screen]

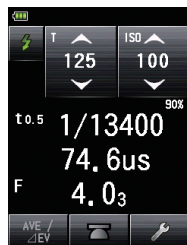

⑯ [Flash Duration Analysis Cord Mode Measuring screen]

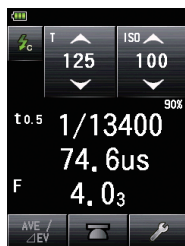

⑰ [Flash Duration Analysis Radio Triggering Mode Measuring screen]



Switching between measured value screens (numeric value ↔ graph) in Flash duration analysis mode

[Flash Duration Analysis Cordless Mode Measuring screen]



[Flash Duration Analysis Cordless Mode Optical Waveform Graph screen]

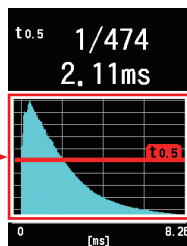

Touching the Measured value area changes the display.

8. Tool Box

Touch the [Tool Box] icon () on the Measuring screen to display settings of functions frequently used.

[Tool Box screen]
Page 1

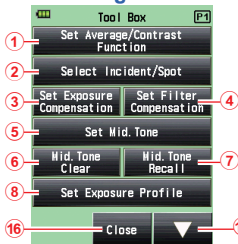

[Tool Box screen]
Page 2

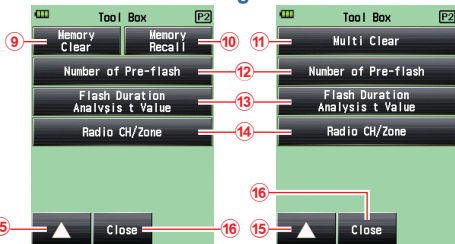

No.	Item name	Description
①	Set Average/Contrast Function	Selects On/Off.
②	Select Incident/Spot	Selects the light receiving method (Incident/Spot).
③	Set Exposure Compensation	Inputs a Exposure compensation value.
④	Set Filter Compensation	Inputs a filter compensation value or select a filter.
⑤	Set Mid. Tone	Sets or edits the Mid. Tone from the measurement or memorized value.
⑥	Mid. Tone Clear	Deletes Mid. tone value.
⑦	Mid. Tone Recall	Recalls Mid. tone value.
⑧	Set Exposure Profile	Selects an exposure profile.
⑨	Memory Clear	Deletes measurements stored in the memory. (Not displayed in multiple flash mode.)
⑩	Memory Recall	Redisplays data stored in the memory. (Not displayed in multiple flash mode.)
⑪	Multi Clear	Deletes accumulated data. (Displayed in multiple flash mode only.)
⑫	Number of Pre-flash	Selects the number of times before pre-flashing is canceled.
⑬	Flash Duration Analysis t Value	Inputs t value of Flash duration analysis.
⑭	Radio CH/Zone *1	Selects a radio channel/zone.
⑮	▼/▲	Moves to the previous or next page.
⑯	Close	Closes Tool Box and returns to the Measuring screen.

*1 Content to be displayed differs depending on which transmitter (sold separately) is installed.

9. Menu Screen and Custom Settings

The Menu screen enables you to previously customize or edit the function or display settings.

Press the Menu button **9** on the meter to display the screen.

[Menu screen]
Page 1

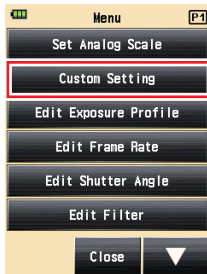

[Custom Setting screen]
Page 1

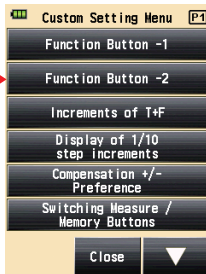

[Custom Setting screen]
Page 2

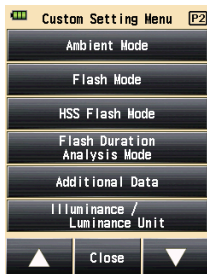

[Menu screen]
Page 2

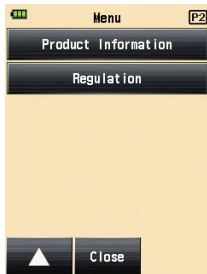

[Custom Setting screen]
Page 3



[Custom Setting screen]
Page 4

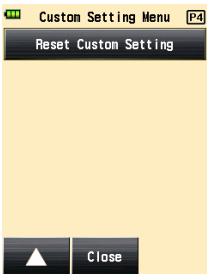

* The "Radio System Preference" in the Custom Setting is only displayed when a transmitter (sold separately) is installed.

10. Download

■ Operating Manual ■ Data Transfer Software (DTS)

Please visit www.sekonic.com to download the latest version of DTS software and the operating manual as follows:

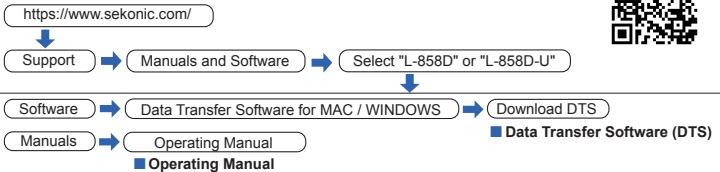

You can also use the URLs below for direct access to both DTS and the operating manual.

<https://www.sekonic.com/support/downloads>

11. Optional Radio Transmitters

Sekonic makes five radio transmitters for use with the L-858D that can be purchased separately.

When purchasing and/or installing a radio transmitter, make sure that the meter, transmitter and radio receiver are designed for use in your location and have the proper frequency to comply with local broadcast regulations.

L-858D Serial #	Transmitter Model #	Operating Frequency
JY11-XXXXXX (Canada IC) JY1L-XXXXXX (FCC)	RT-20PW	PocketWizard (FCC & Canada IC): 344.0 to 354.00 MHz
JY11-XXXXXX (CE) JY1G-XXXXXX (NCC)	RT-3PW	PocketWizard (CE & NCC): 433.42 to 434.42MHz
JY10-XXXXXX (Japan) JY11-XXXXXX (CE) JY1G-XXXXXX (SRR, NCC) JY1L-XXXXXX (FCC)	RT-BR	brncolor (FCC, Canada IC, CE, SRR, Japan): 2.4GHz
	RT-EL/PX	Elinchrom and Phottix (FCC, Canada IC, CE, NCC, SRR, Japan): 2.4GHz
	RT-GX	Godox (FCC, Canada IC, CE, SRR, Japan): 2.4GHz



RT-20PW
RT-3PW
RT-BR
RT-EL/PX
RT-GX

* PocketWizard® is the registered trademark of LPA Design.

* brncolor® is the registered trademark of Bron Elektronik AG.

* Elinchrom is the registered trademark of Elinchrom SA.

* Phottix® is the registered trademark of Phottix Hong Kong Ltd.

* Godox® is the registered trademark of Godox Photo Equipment Co. Ltd.

* The contents of this manual may be subject to change for the product's specification modifications and other reasons without prior notice.

SEKONIC CORPORATION

7-24-14, Oizumi-Gakuen-cho, Nerima-ku Tokyo 178-8686 JAPAN

TEL +81-3-3978-2335 FAX +81-3-3978-5229

<https://www.sekonic.com>

JY1L97622

September 2020

Printed in Philippines