

Model SDHmini

Dewpoint Meter

Instruction Manual

3006 - SDHmini User Manual - Iss 1.1

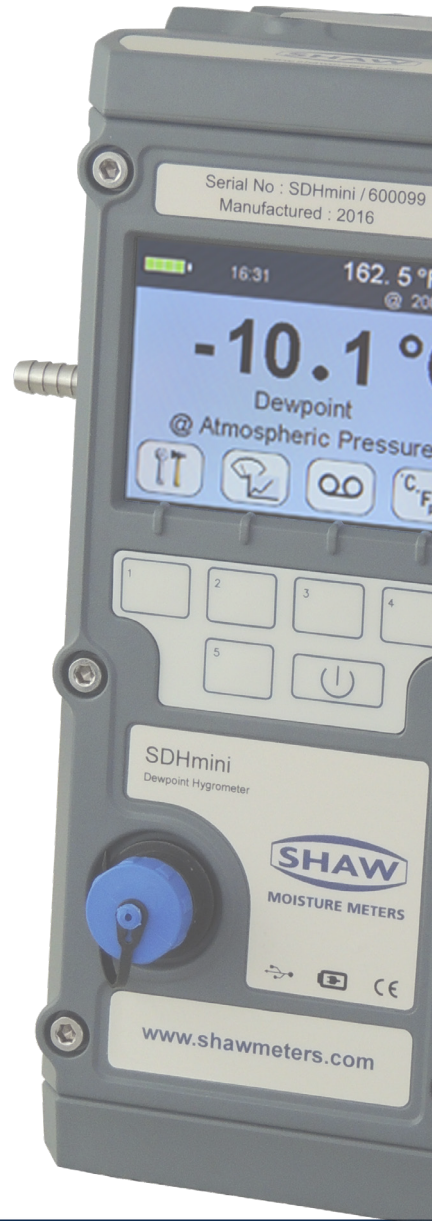

EU Declaration of Conformity

We
Of
Declare that
Model Name:

Shaw Moisture Meters
Len Shaw Building, Bolton Lane, Bradford, England, BD2 1AF
Dewpoint Hygrometer SDHmini

Description: Battery powered moisture analyser comprising a sensor contained within a drying chamber mounted on a transportable instrument casing.

Conforms to the following directives:
2014/30/EU The Electromagnetic Compatibility Directive

I hereby declare that the aforementioned equipment has been designed to comply with the relevant sections of the above referenced specifications.

10th February 2021



Andrew Coulton
Calibration & QA Manager

CP12A Issue 8

Contents

1	Introduction	5
	1.1 Unpacking Your Shaw Moisture Meters SDHmini	5
	1.2 General Description	5
2	Important Information	6
	2.1 Symbols Table	6
	2.2 Lithium-ion Cell - Battery	6
	2.3 Pressure Exposure	7
3	Installation	7
	3.1 Gases to Avoid	7
	3.2 Installing the Air/Gas Sampling System	7
	3.3 Piping Installation Schematic	8
	3.4 Piping Schematic Component Index	9
	3.5 Purging the Sample Connection	9
	3.6 Using the SDHmini to Take a Moisture Reading	10
	3.7 Desiccant Dry-Down Technology	11
	3.8 Sample Connections	11
	3.9 Pressure and Flow Control	12
	3.10 Particulate Contamination	12
	3.11 Liquid Contamination	12
4	Normal Operations	13
	4.1 Powering On/Off	13
	4.2 Graphical Viewing Options	13
	4.3 Display Options	13
	4.4 Choice of Units	14
5	Calibration	15
	5.1 Auto Calibration (AutoCal)	15
	5.2 Calibration Setpoint (CalSet)	16
	5.3 Calibration Procedure Error Messages	17
6	Sensor Related Settings	17
	6.1 Sensor Type	17
	6.2 Selecting Gas Types	17
	6.3 Selecting Gas Molecular Weights	18
	6.4 Pressure	18

Contents

7	Non Measurement Related Configuration Functions	19
	7.1 Changing the Date	19
	7.2 Changing the Time	19
	7.3 Changing International Settings	19
	7.4 Hotkeys	20
8	Installing the SDHmini User Tool	21
	8.1 Extracting the SDHmini User Tool Software from the USB Flash Drive (Memory Stick)	21
	8.2 Extracting the SDHmini User Tool Software from the Instrument	22
9	Connecting the SDHmini and SDHmini User Tool	24
10	Using the SDHmini User Tool	25
	10.1 Menu items	25
	10.1.1 File - SDHmini Report	25
	10.1.2 Language	25
	10.1.3 Help	26
	10.2 Instrument Live Reading	26
	10.3 Instrument Static Information	26
	10.4 Utilities	27
	10.5 Settings	28
	10.6 Firmware Update	29
	10.7 Factory Reset	30
11	Additional Information	31
	11.1 Desiccant and Head Seal Replacement	31
	11.2 Temperature	32
	11.3 Response Time	32
	11.4 Guarantee	32
	11.5 Basic Definitions	32
	11.6 Problem Guide	33
12	SDHmini Specifications	34
13	SDHmini General Assembly Diagram	35

1 Introduction

1.1 Unpacking Your Shaw Moisture Meters SDHmini

Please examine the SDHmini package for any damage or mishandling. If any damage is evident please notify the carrier and the Shaw Moisture Meters representative from where this unit was purchased.

You should have received (if ordered):

- 1 model SDHmini instrument
- 1 carry case
- 1 Allen key
- 1 two metre length of PTFE tubing
- 1 USB charging cable
- 1 Fir Tree fitting plus 1 x fittings as ordered
- 1 AC/DC adaptor
- 1 pressure dewpoint circular calculator
- 1 USB flash drive with SHAW SDHmini User Tool software
- 1 instruction manual

If anything is missing please contact your distributor immediately.

1.2 General Description

The SDHmini is a micro-controller based battery operated dewpoint hygrometer with state of the art features and enhancements with support of USB for communicating with PC.

It is a fully, self-contained unit incorporating the moisture sensor, signal conditioning circuitry, memory management, graphics display, membrane keyboard, real time clock, on-board battery and charger circuit.

The graphical user interface features three main viewing screens, digital, graphical (historical readings in a scrolling strip chart) and a meter (a traditional moving coil). There is also a secondary display in the top right which allows display of readings in alternative units of measurement.

The unit operates with the following 10 language options: English, German, French, Spanish, Portuguese, Russian, Italian, Chinese, Japanese and Korean.

A full colour graphics LCD display with 320 x 240 resolution landscape and a 6 key input including an on/off key.

The displayed units can be changed on both the primary and secondary displays for the selectable moisture unit e.g. °C, °F, g/m³, ppm(v), ppm(w) and lb/MMSCF.

The SDHmini settings can be adjusted by a user-friendly software interface incorporating multiple menus, hot key combinations, information displays and control functions.

Use the supplied USB cable, attach between the PC and the instrument, an automatic connection over USB is established.

The USB port allows:

- Charging of the battery (Li-ion) when connected to PC or dedicated power supply
- Downloading of new firmware to the unit
- Downloading of setup data from dedicated PC software

The view panel allows access to many of the features, settings and information pages within the instrument.

A micro SD card is fitted to the instrument, the contents of which can be explored by clicking the SD card icon in the bottom left of the view panel. The contents may include user manuals, service notes, calibration data sheets, firmware backups etc.

2 Important Information

2.1 Symbols Table



2.2 Lithium-ion Cell - Battery

The SDHmini is powered by a single lithium-ion cell. The cell is not field replaceable by the user as it is completely enclosed within the instrument. However, the cell may be exchanged by an authorised agent who has received the necessary training, support systems and accreditation. It is recommended to only use the USB power supply supplied with the instrument.

It is recommended that the SDHmini be put on charge overnight when the unit is first received.

To attain maximum cell life, the SDHmini should always be charged at room temperature. The discharging cell life (hours of use from a fully charged cell) will reduce when used in cold conditions. Switch on the instrument to check if fully charged.

The symbol indicates that the device contains a battery which may be charged via the USB connector.

Rating of instrument is less than 1 W in operation. Charging voltage is 5 V nominal.



2.3 Pressure Exposure

The maximum pressure to which the telescopic measuring head is exposed should not be more than

0.3 bar, 4 psi

Exposing the measuring head to higher pressures may damage the instrument and result in injury to the operator or other personnel in the area.

3 Installation

3.1 Gases to Avoid

The SHAW moisture sensors are suitable for many different industrial and research applications. Most gases can be checked for their moisture content with no need for the calibration to be altered when changing between different gases, as the sensor operates only with reference to the water vapour content.

There are however, some gases that must be avoided as they are not compatible with the material of construction of the sensor. Ammonia (NH_3), Ozone (O_3) and Chlorine (Cl_2) must be avoided at all times, even in small quantities. Hydrogen Chloride (HCl) also attacks the sensors very quickly. Some, less aggressive acidic gases such as Sulphur Dioxide (SO_2) can be monitored as long as the moisture content is low, generally less than 100ppm(v). If in doubt, please ask your supplier.

Sulphur Hexafluoride (SF_6) has no effect on the sensor. If the gas has been exposed to arcing, however, it is possible that various acidic species will have been formed that will corrode the sensor. When testing SF_6 that may have been arced, therefore, an acidity test should be carried out first; if the gas proves to be acidic then the moisture test should not be carried out.

3.2 Installing the Air/Gas Sampling System

The *Piping Installation Schematic* diagram (see section 3.3) shows all components, which could be used in a dry gas measurement application. Although not all the items shown will be required for every installation.

The main principle when considering the presentation of the gas sample to the SDHmini dewpoint meter is to keep the sample system as simple as possible and of minimum swept volume, so that it has the least possible influence on the gas sample.

The SDHmini should be placed on a stable surface prior to connecting to the sample pipework. Care should be taken to ensure that the sample presented to the SDHmini is not contaminated with any component that will damage, contaminate or affect in a way that will impair the unit's accuracy.

The flow rate, although not critical to the sensor measurement, should be low enough to avoid abrasion to the sensor surface without being so low as to extend the SDHmini response time to an unacceptable level. In general, a flow rate of between 2 and 5 litres/min at normal temperature and pressure will give the right balance.

The SDHmini is designed to operate at atmospheric pressure with a maximum of 0.3 bar.

3.3 Piping Installation Schematic

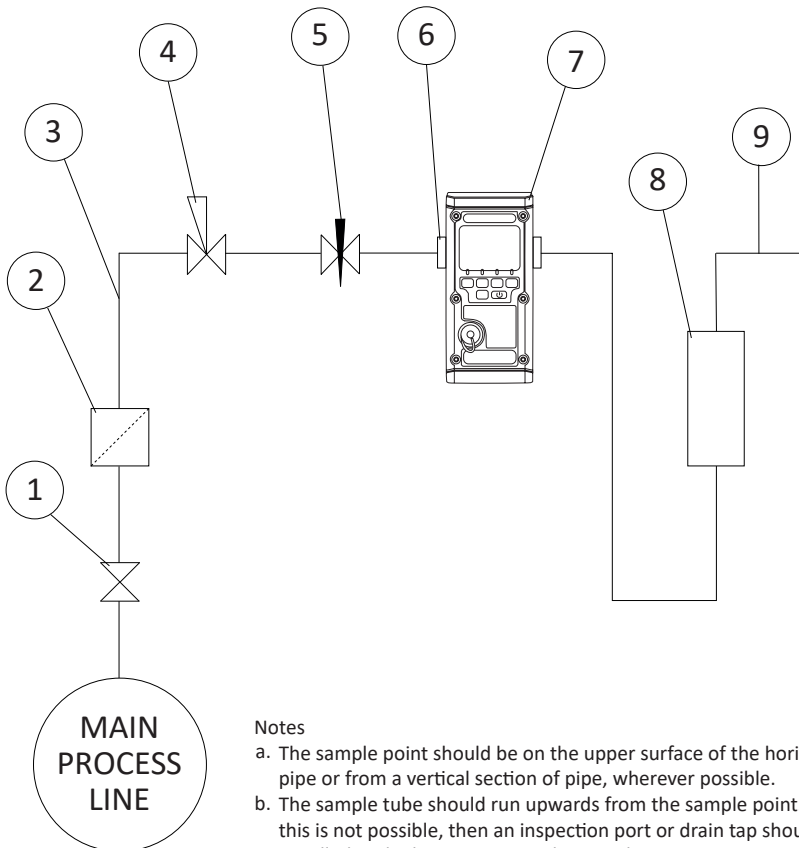

Notes

- The sample point should be on the upper surface of the horizontal pipe or from a vertical section of pipe, wherever possible.
- The sample tube should run upwards from the sample point. If this is not possible, then an inspection port or drain tap should be installed at the lowest point in the sample system.

3.4 Piping Schematic Component Index

1. **Sample Isolation Valve** - This is a recommended item as it allows access to the sample system without interrupting the main process line.
2. **Filter Unit** – A filter unit is recommended when the samples are likely to contain particulate matter. If the air/gas sample contains heavy hydrocarbon condensate, the filter must be of the coalescing type with a drain. The filter unit should be positioned as close to the sample point as practical.
3. **Sample Tube** – This should be stainless steel for dry air or gas applications but copper or carbon steel can be used where wetter gases are to be measured. If any section of the sample tube must be flexible then PTFE should be used. In most cases, 3 mm OD ($\frac{1}{8}$ ") is sufficient as it provides good system response time with minimum flow. 6 mm OD ($\frac{1}{4}$ ") tube can be used where pressure drops across the 3 mm tube are too high.
4. **Pressure Reduction Valve or Pressure Regulator** – the sample is measured at atmospheric pressure requiring that valve 4 is fitted to the system.
5. **Flow Control Valve.**
6. **Sample Connection.**
7. **SDHmini.**
8. **Flow Indicator** – The recommended sample flow is 2 to 5 L/min.
9. **Sample Exhaust** – The exhaust is vented to atmosphere or returned to an atmospheric pressure line.

3.5 Purging the Sample Connection

Refer to the *Piping Installation Schematic* in section 3.3.

It is advisable to carry out an initial purge of the sample loop without connecting the instrument, in order to avoid the possibility of sensor damage on start-up.

Open the sample isolation valve (1) slowly, until there is a small flow of air/gas at atmospheric pressure from the pressure reduction valve (4). Allow the air/gas to exhaust through the sample connection (9).

Continue this for two minutes to remove any residual moisture from the sample pipe work and components. Check that no liquid or particulate contamination, which could damage the sensor, is passing through the sample pipe. Directing the sample onto a piece of white paper (such as a filter paper) will make it easier to see any dust or oil mist in the sample.

Connect the SDHmini. The SDHmini is not flow sensitive, however, the sample flow needs to be enough to fill the sensor head with gas effectively, so anything less than 1 litre/min would mean that the instrument would take too long to settle to a stable reading. The flow should not be so high that the gas velocity could physically damage the sensor or cause back-pressure in the sensor head, so should not exceed approximately 10 litres/min.

3.6 Using the SDHmini to Take a Moisture Reading

The first purpose of the SDHmini is to provide a rapid, easy and reliable means of carrying out moisture content measurement of gases. To ensure rapid response the sensor is kept dry by surrounding the sensor with desiccant in the head assembly when it is not in use.

After purging the system to be monitored fit the SDHmini sample pipe to the sample connection (6). Allow the gas to purge for a further two minutes with the head down. Restrict the outlet of the SDHmini (7) by placing a finger over the sample exhaust (9), so that the pressure of the sample lifts the telescopic head. As soon as the head is fully extended remove the finger, to prevent pressure build up. Pull gently on the head to make sure it is fully extended. If there is not enough pressure to lift the head assembly, assist it by pulling it up, do this very slowly so that ambient air is not drawn in through the outlet.

The sensor will respond to the moisture level present in the sampled gas. The displayed moisture value will continue to change until the sensor reaches equilibrium at which point the displayed value is representative of the moisture level in the sampled gas. When a reading has been taken and the test is finished, push down the telescopic head fully, carefully turn off the sample flow and disconnect the sample pipe. With the head in the down position the desiccant will dry the sensor, ready for the next test.

Note: It is important that the head assembly is either fully up or fully down to keep the desiccant isolated from the ambient air so avoiding wetting it. When the instrument is not in use it should be stored with the head in the down position.

3.7 Desiccant Dry-Down Technology

The unique design allows purging of the gas in the “Dry-Down Position” which will bring all surfaces and voids to equilibrium.

Sensor surrounded by desiccant ensuring it is dry, ready for the next measurement.

The desiccant and sensor are always isolated from atmospheric air to ensure an accurate reading.

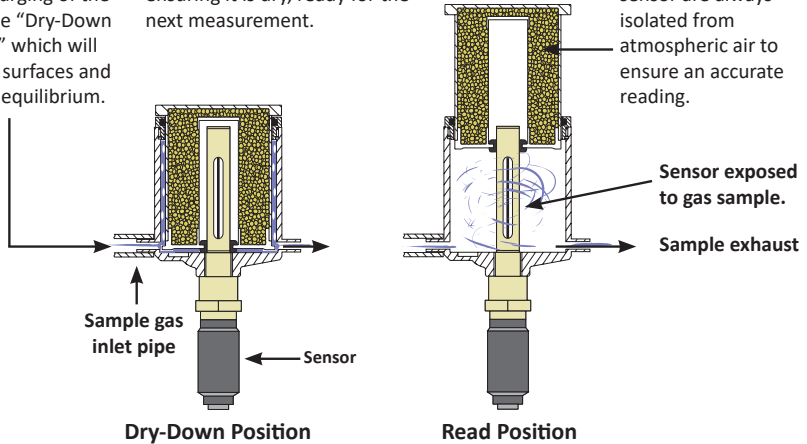

Keeping the sensor dry between tests ensures that the SDHmini is ready to carry out rapid spot checks. The unique design of the desiccant head achieves this by surrounding the sensor with desiccant, keeping the sensor dry. The head is then lifted for sampling, exposing the sensor to the sample gas.

Between tests the sensor is not allowed to come into contact with ambient air. The chamber is designed so that the void space and chamber wall surfaces are purged with sample gas before exposure of the sensor, giving faster, more accurate and reliable results.

3.8 Sample Connections

The SDHmini is supplied with two connections: a Fir Tree on one side and a Swagelok compression fitting for ¼", ⅜", 6 mm OD pipe or another Fir Tree fitting (as specified on your order) on the other. Either can be used as the inlet connection (6).

PTFE and stainless steel are recommended materials for sample pipes. Some specialist flexible tubing may be suitable as sample pipe but common flexible tubing such as PVC, nylon, polythene or rubber, should not be used, as they are permeable and water vapour from the atmosphere will diffuse through them into the sample gas.

A 2 m PTFE sample pipe is supplied for use with the Fir Tree connection. The first time this is used it is advisable to warm the end that will go over the Fir Tree for a few seconds with a heat source to soften it slightly, which helps to get a gas tight seal.

3.9 Pressure and Flow Control

In most cases the gas to be sampled will be at a positive pressure, which will need to be reduced to atmospheric pressure. At low pressures, up to around 8 barg, this can be done by including a simple needle valve (5) to control the flow and thereby the pressure dropping across it. Ideally this would be the isolation valve (1) on the sample point, thus keeping the number of joints and glands, which are points of potential moisture ingress to a minimum.

At higher pressures it is advisable to reduce the pressure across a pressure regulator (4). Any regulator used should be stainless steel and of a low swept volume. Typical laboratory or welding type regulators are not suitable because they have elastomeric diaphragms which are permeable to water vapour and the high swept volume will be slow to purge.

3.10 Particulate Contamination

If the sample gas is likely to contain particulate material this should be kept away from the sensor by including a small inline particle filter (2) in the sample system.

If the surface of the sensor becomes partly coated with particles it will not affect the calibration of the sensor but will restrict the movement of water molecules across the surface so increasing the time it takes for the sensor to come to equilibrium with the water vapour concentration around it. If the solid material is hygroscopic, such as desiccant dust, whenever there is a change in the moisture concentration in the sample, this material must come to equilibrium with the moisture content before the sensor can respond to the change, which will cause delays in obtaining accurate results.

3.11 Liquid Contamination

If the sample gas may contain liquid contamination, such as oil mist, this should be kept away from the sensor by including a coalescing filter or an appropriate membrane filter (2) in the sample system.

If the surface of the sensor becomes partly coated with liquid, again, it will not affect the calibration of the sensor. It will restrict the movement of water molecules across the surface so increasing the time it takes for the sensor to come to equilibrium with the water vapour concentration around it. If the liquid is hygroscopic, such as glycol, the buffering effect described for desiccant dust may be so great that the sensor becomes too slow to use.

4 Normal Operations

4.1 Powering On/Off

To switch on (and off), press , the SDHmini briefly displays a splash screen showing instrument status, error information and firmware version number.



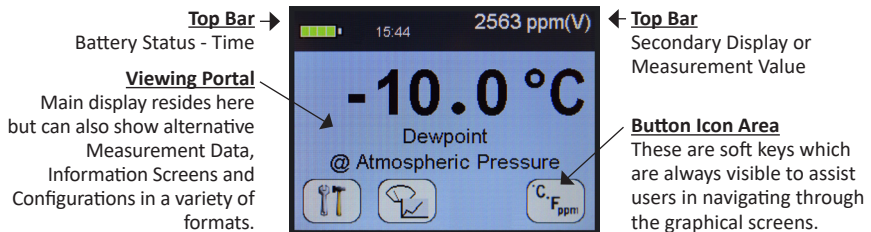

4.2 Graphical Viewing Options

The start up screen is soon replaced by the normal measurement mode screen (see below) displaying the current moisture measurement in a variety of views. The last used or last selected mode will be utilised automatically.



4.3 Display Options

The display can be changed by pressing the following keys   to cycle through all of the graphical views and  will take you to the home screen.

Here is a view starting as a digital number followed by simulated strip chart and moving coil instruments.

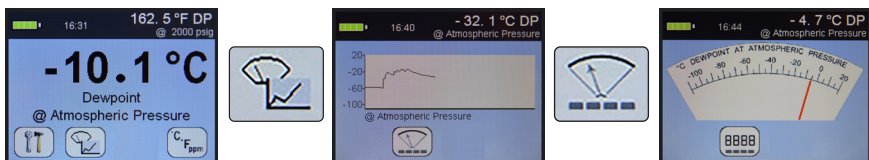

The digital display mode has the benefit of showing the moisture measurement in main choice of engineering units but also a secondary display with perhaps alternative engineering units. This mode also allows application of pressure dewpoint to evaluate the measurement in other samples pressures.

4.4 Choice of Units

In normal measurement mode. The secondary display is the measurement displayed in the top bar on the right hand side (A). It allows alternative engineering units or concentrations to be displayed alongside those chosen in the main display.

To choose the engineering units to be displayed, select the units key $C_{F_{ppm}}$ from the main digital view.



You will be presented with the following screen to select engineering units for the main and secondary displays. You may toggle between adjusting the main and secondary displays by pressing the key 3.

Use the $\uparrow\downarrow$ key to move to the desired measurement type and press \checkmark to select it. Pressing \leftarrow will exit the current screen without making any further changes.

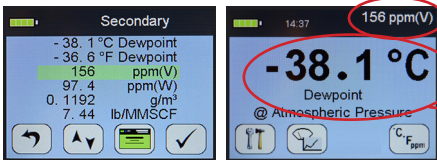
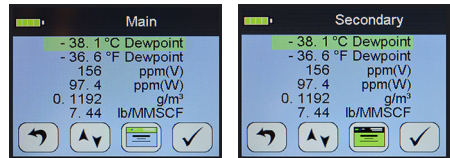

Here the secondary display is being changed to ppm(v) engineering units (B).

Please note: when you change the display to either the moving coil meter or the strip chart the secondary engineering units display is replaced with the primary units (C).

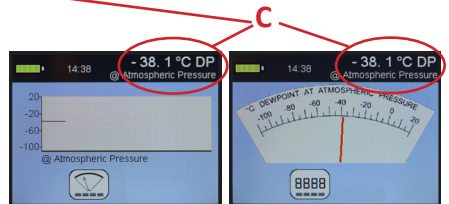

This continues to allow high precision measurement whilst having the benefit of the graphical display.

5 Calibration

Field calibrations of the SDHmini may be performed periodically, every two to three months, to ensure accuracy between laboratory calibrations by checking the span of the instrument and correcting for any deviation. These functions can be used to verify operation of the SDHmini if confirmation of an unexpected result is required.

This may be accomplished by two similar in built calibration functions, namely *AutoCal* and *CalSet*.

5.1 Auto Calibration (AutoCal)

The *AutoCal* facility uses the fact that each sensor is designed and manufactured to give no further increase in response when it reaches its maximum moisture level. **For example** a SDHmini with a full scale value of 0 °C dewpoint will read 0 °C dewpoint when exposed to a gas with this moisture concentration and will continue to read 0 °C dewpoint as the moisture concentration rises above 0 °C dewpoint.

The SDHmini can therefore be adjusted to read 0 °C dewpoint on any gas with a moisture concentration wetter than 0 °C dewpoint, ambient air for instance, thus setting the span to match the original calibration.

NOTE: For instruments with a dewpoint range above 0 °C, e.g. the Blue range, -80 to +20 °C, please refer to section 5.2 *Calibration Setpoint (CalSet)*.

Select *AutoCal* from the *Configuration Menu*.

Please ensure that the inlet and outlet valves are open to atmosphere.

Extend the desiccant head on the instrument (as illustrated on the instrument screen) noticing that the value of the full scale moisture level has already been automatically preselected as a target of 0 °C. You may need to lift the head two to three times to allow ambient air through to the chamber, ensuring inlet and outlet are unrestricted. Press .

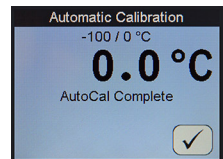
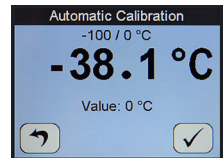
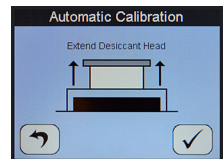
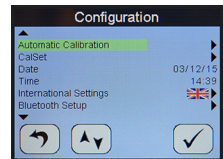
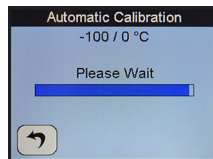
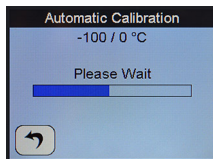
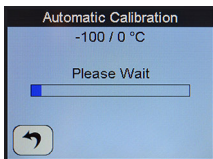

The SDHmini will display a moving bar until it assesses that the sensor has stabilised (please allow up to ten minutes for this to occur).

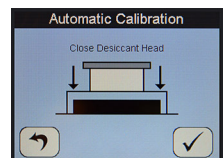

The SDHmini will now display the full scale value of the unit, either -20 °C or 0 °C depending on the sensor range.

Close the desiccant head when instructed to do so and press .



Pressing  during the *AutoCal* aborts the process.
Press  to accept.

The value present at the start of the aborted *AutoCal* process is reinserted.

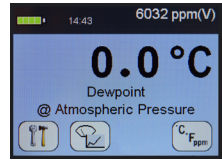

The SDHmini will return the instrument to normal measurement mode.

Note: Avoid carrying out the *AutoCal* procedure on a SDHmini with a full scale value of 0 °C dewpoint on days when the ambient may be below this value, for example a dry day when the ambient temperature is below approximately 12 °C.

The entered *AutoCal* value must not be pressure compensated.



5.2 Calibration Setpoint (*CalSet*)

The function *CalSet* is suitable for sensors with an upper range limit of +20 °C dewpoint, for example the Blue range -80 to +20 °C dewpoint, where this upper range limit will exceed typical ambient conditions.

The unit may be checked against a known moisture level, for example from a moisture generator or other reference standard, such as a chilled mirror hygrometer or a psychrometer using the function *CalSet*.

Select *CalSet* from the *Configuration Menu*.

Extend the desiccant head and press .

Whether the instrument is being checked against the measured ambient level or against a known calibration standard from a moisture generator,  and  are used to set the value accordingly.

Selecting +10 °C for instance involves changing the sign and number by use of both keys.

The entered *CalSet* value must not be a pressure compensated one and must be within the range of the sensor.

Press  when done.

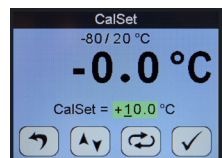
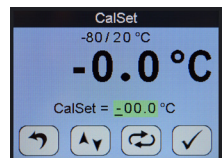
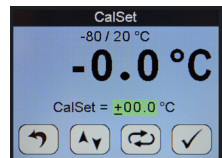
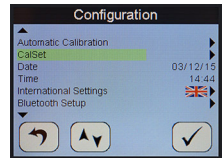



The SDHmini will display a moving bar until it assesses that the sensor has stabilised (up to 10 minutes).

The full scale value, 10 °C dewpoint, is now displayed.

Press  when complete.

Close the desiccant head when instructed and press .

Pressing  during *CalSet* aborts the process and the value present at the start of the aborted *CalSet* process is reinserted.

Press  to continue/accept changes.

The SDHmini will return to the normal operational mode.

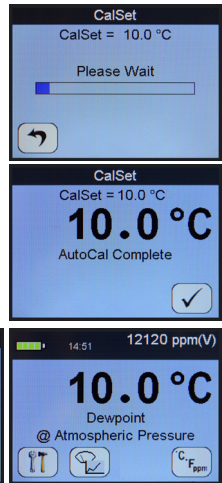

5.3 Calibration Procedure Error Messages

If the instrument fails calibration, a message will be displayed on the screen until acknowledged by the user, e.g.

AutoCal Failed
Sensor Open Circuit
or
AutoCal Failed
Sensor Short Circuit

This will mean replacing the sensor or its interconnecting cable in some cases.

6 Sensor Related Settings

On the *Configuration* screens there exists a collection of measurement settings associated with the sensors and its environment.

6.1 Sensor Type

Here you may view the type of sensor installed in the SDHmini and its range.

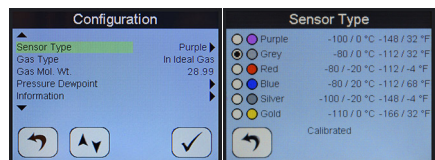

6.2 Selecting Gas Types

The SDHmini default setting is for ideal gas behaviour, however, there is an option to change the setting to natural gas which uses the appropriate calculation.

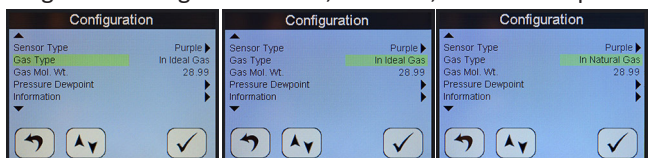

6.3 Selecting Gas Molecular Weights

The SDHmini default setting is for air (molecular weight 28.99), however, this function allows the molecular weight to be set appropriately for other sample gases, for example 18.99.

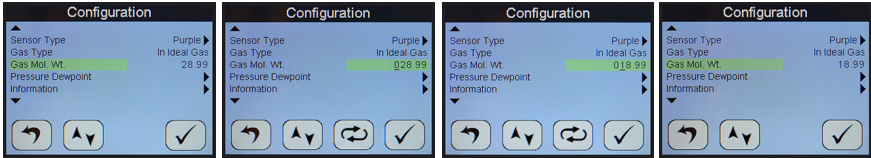

6.4 Pressure

This sub-menu has, for both the primary and secondary displays, five options allowing the user to select either *atmospheric pressure* or one of four *pressure engineering units* and *applied pressure*.

When this function is selected, the main and secondary display screens will display the pressure at which the dewpoint reading is calculated.



The SDHmini requires that a numerical pressure value be entered in the selected units at the bottom of the units selection section, for example selecting pressure dewpoint of 2,000 psig on secondary display.



Warning: This function is purely an internal calculation and **DOES NOT** allow an elevated pressure to be applied to the measuring head.

7 Non Measurement Related Configuration Functions

7.1 Changing the Date

In order to change the present date press the arrow  key to select the *Date* function from the *Configuration* menu. Press .



Use  and  to change the date.

Here for example the date is changing from 06/03/15 to 06/04/15.

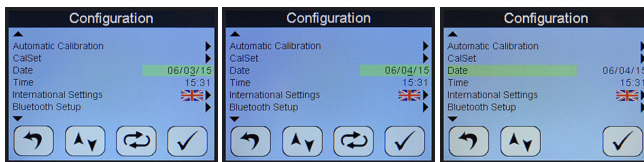

Press  to enter new date or  to abort changes.

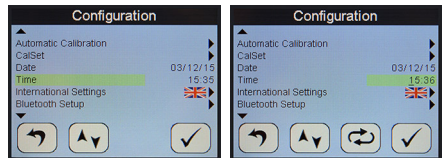

7.2 Changing the Time

In order to change the present time press  to select the *Time* function from the *Configuration* menu.



To change the time use  and .

Here for example the time is changing from 10:48 to 11:48.

Press  to enter new time or  to abort changes.

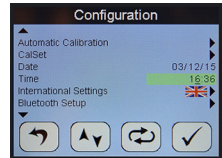

7.3 Changing International Settings

Use the selection cursor  to select options to change the settings for *Language*, *Date Format* and *Numerical Delimiter*.

Select *International Settings* from the *Configuration* Menu.

To change the *Language* option select .

The language choice area is highlighted. A flag of a country most associated with one of the pre-installed languages indicates which language is currently selected. The

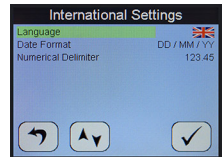

SDHmini operates with the following 10 language options:
 English, German, French, Spanish, Portuguese, Russian,
 Italian, Chinese, Japanese and Korean.

Use the  to select the flag required.

And  to accept the choice.

The *Date Format* i.e. DD/MM/YY or MM/DD/YY is also chosen from within the *International Settings* menu.

And finally, numbers can be presented 123.45 or 123,45.

Note: These settings are carried through to any data files and printer outputs where appropriate.

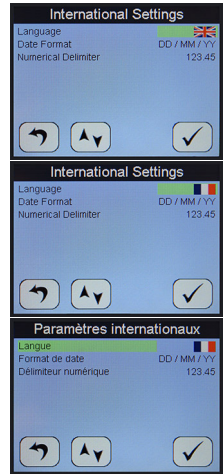

7.4 Hotkeys

To access the hotkeys from the main screen, press key 5 on the keypad.

The four soft keys are replaced by a new set of hotkeys for a short while. These are available for rapid access to certain areas of the menu structures or functions.

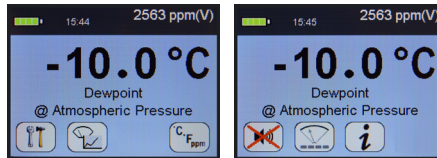

Turns ON and OFF the inbuilt sounder



Accesses the alternative moving coil graphical viewing screen



Takes the user to the *Information* screen



If the SDHmini is connected to a PC then the second hotkey is replaced by an SD card symbol

8 Installing the *SDHmini User Tool*

The SDHmini User Tool software allows the instrument to be connected to a PC, enabling easy configuration of the SDHmini settings and functions.

Please note: For the best visual appearance it is recommended that the PC display text and icons option is set to default rather than medium or larger.

In order to install the software the user must ensure that they have the permissions to do so from their respective manager or IT systems manager.

Users with limited permissions in the Windows environment also may find that they might not be able to install software until administrative privileges are set.

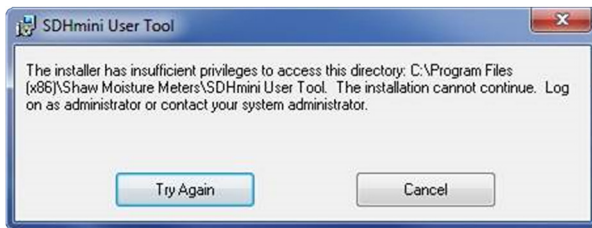

On installation the software will only work on Windows version XP (SP3), Vista, 7, 8 and 10 and requires *Microsoft .NET 3.5*. Once installed this software is warranted not to need any access to the internet or any other sort of network activities. However there are two links on the Help/About Menu item which if used on a non-connected PC will not function. If you have a more up-to-date version of *Microsoft .NET* you may need to enable v3.5 via the Windows features/control panel.

There are two ways to install the *SDHmini User Tool* software.

- From the supplied USB flash drive (memory stick)
- From the instrument's memory card

8.1 Extracting the *SDHmini User Tool* Software from the USB Flash Drive (Memory Stick)

To install

- Insert the USB flash drive in to the PC.
- On your PC open the "my computer" or "computer" folder (the folder title will depend on which Windows Operating System you are running).

- Click on the folder or removable disk. The instrument serial number e.g. 123456 and folder title should match.

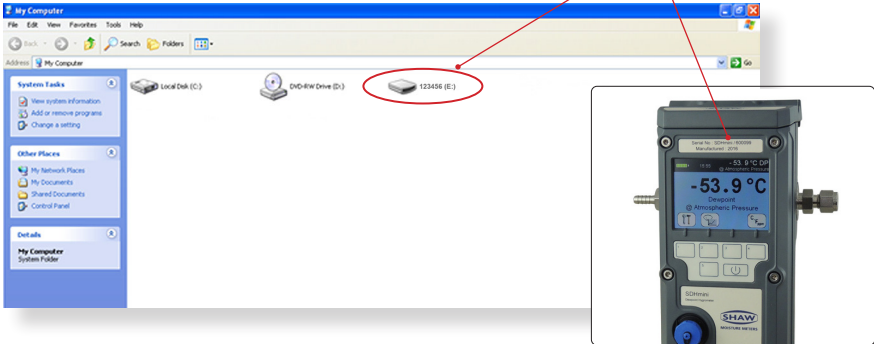

- This saves the User Tool Setup to the PC.
- Open the folder for the *SHAW SDHmini User Tool Setup* software.
- Double click the *SHAW SDHmini User Tool Setup* icon and install via the Windows wizard.
- Select installation folder to save your software download in your chosen folder on the PC.
- Once the installation is complete a dialogue box will appear saying “Installation Complete”. A shortcut icon will appear on the desktop. Close the dialogue box.
- Safely remove the USB flash drive from your PC.

8.2 Extracting the *SDHmini User Tool* Software from the Instrument

To install

- Connect the USB cable provided to the instrument and PC.
- Switch on the instrument.
- Press key 5 on the instrument to access the hotkeys and you will see the SD card symbol (key 2).
- Press key 2 on the instrument and the SD card symbol screen will appear.
- On your PC open the “my computer” or “computer” folder (the folder title will depend on which Windows Operating System you are running).
- Click on the folder or removable disk. The instrument number, e.g. 123456, and folder title should match.

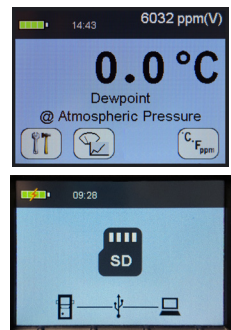

- This saves the *SHAW SDHmini User Tool Setup* to the PC.
- Open the folder for the *SHAW SDHmini User Tool Setup* software.

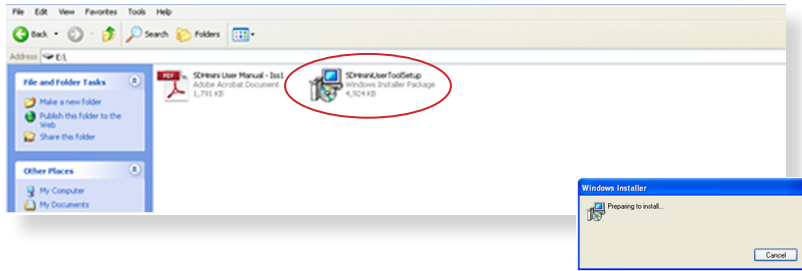

- Double click the *SHAW SDHmini User Tool Setup* icon and install via the Windows wizard.
- Select “Installation Folder” to save your software download in your chosen folder on the PC.

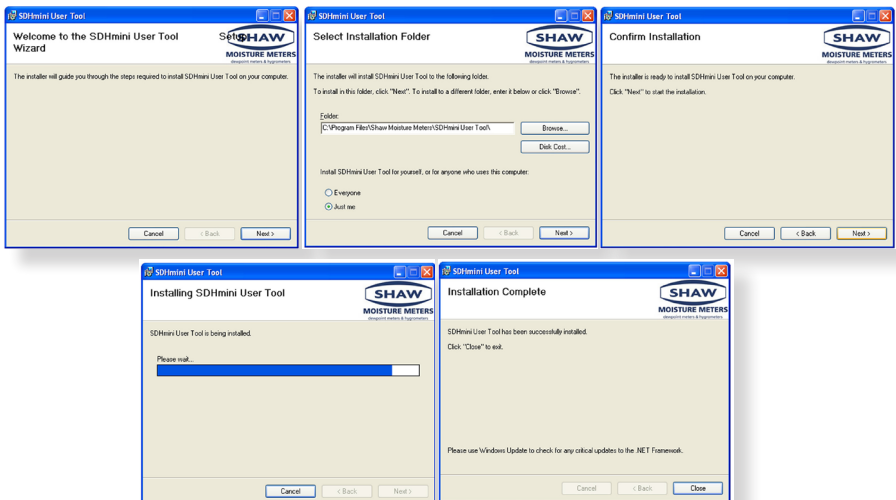

- Once the installation is complete a dialogue box will appear saying “Installation Complete”. A shortcut icon will appear on the desktop. Close the dialogue box.
- Safely remove the hardware by disconnecting the USB cable from the unit. You will need to disconnect the USB cable from the unit to disable the SD card mode on the unit.



9 Connecting the SDHmini and *SDHmini User Tool*

Always ensure the USB cable is connected to the instrument and PC when working in the *SDHmini User Tool* software. If you have not connected the unit to the PC and attempt to start using the *SDHmini User Tool* software it will show a “Not Connected” message.

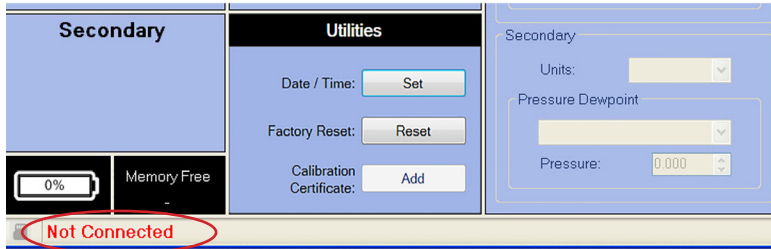

Please note: Once connected to the *SDHmini User Tool* software, all keys on the instrument keyboard are unusable, all changes are made through the *User Tool*.

Double click the desktop icon to get started.



Switch on the instrument and connect the USB cable from the unit to the PC. A splash screen appears on the PC.

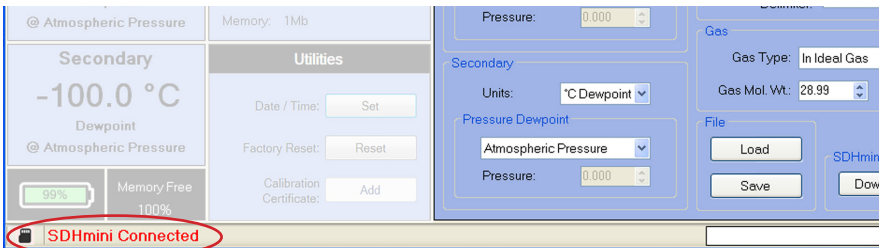

On your PC open the *SDHmini User Tool*. The view panel appears on the PC saying “SDHmini Connected”.

The instrument will display the following screen to show that the instrument is connected to the PC.

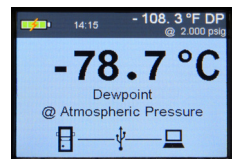

10 Using the SDHmini User Tool

10.1 Menu items

The menu strip contains the following options: *file*, *language* and *help*.

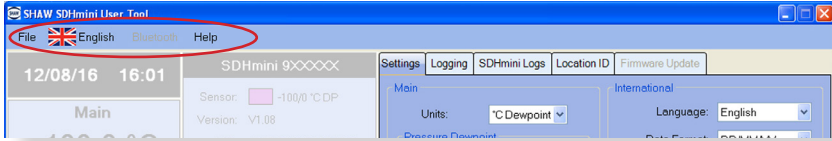

10.1.1 File - SDHmini Report

The opportunity for reports to show the current status and error flags. A report at the current time can only be printed or saved but not amended.

If there are any errors, the unit should be returned to the distributor or you may perform a factory reset. Please contact your distributor for advice before proceeding with a factory reset.

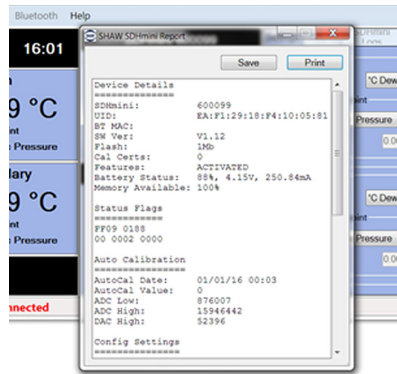

10.1.2 Language

The *flag/language* menu item shows the ten languages available which can be reset/amended on the *SDHmini User Tool* software screen. **Note:** This does not change the language on the instrument. To change the language on the instrument please follow the instructions *Changing International Settings* in section 7.3.

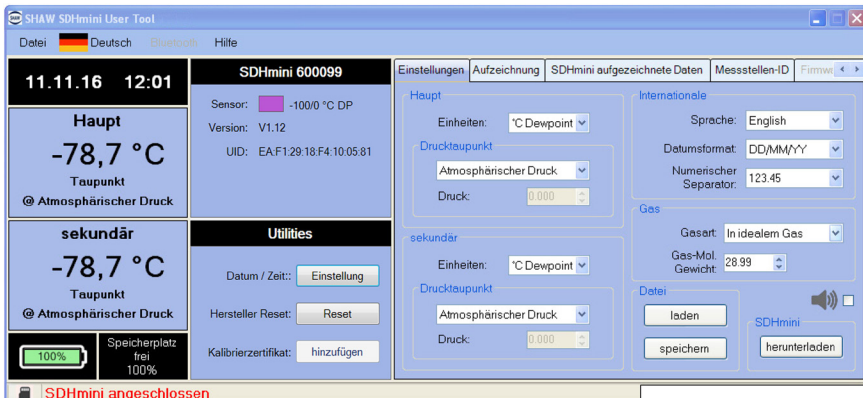

10.1.3 Help

The *help* menu item displays the manufacturer’s contact details and version number of the software.

10.2 Instrument Live Reading

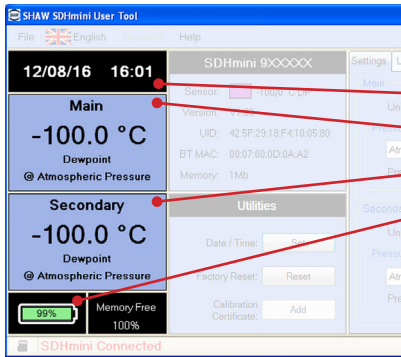

Displays information regarding:

- Date and time
- Live reading in main units
- Live reading in secondary units
- Battery status

10.3 Instrument Static Information

Displays information regarding:

Instrument serial number

Sensor

Sensor range – moisture sensor colour and dewpoint range in °C

Version

Firmware version name or number

UID

Unique instrument number – an electronic serial number unique to each instrument

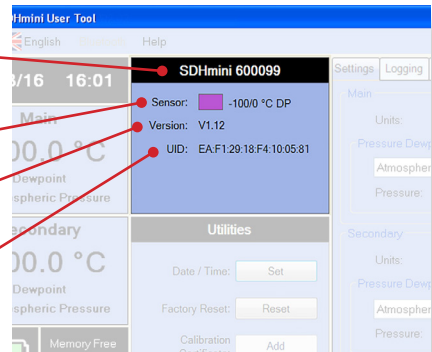

10.4 Utilities

Date/Time – Set

The date and time can be set via the PC.

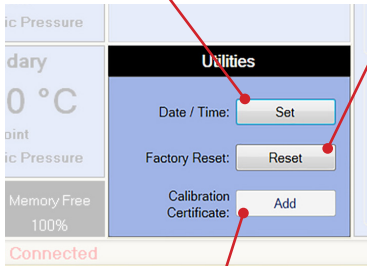

Calibration Certificate – Add

Useful for users to enter the last calibration check date after a factory calibration.

Factory Reset – Reset

Warning: Performing a factory reset will erase all saved settings and data. If continuing with the *Factory Reset* option, a dialogue box “Auto Calibration Required” will appear. Please refer to section 5.2 *Auto Calibration (AutoCal)* of the instrument’s instruction manual.

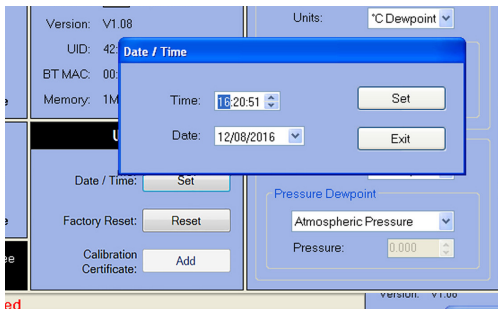

Date/Time: Click on Set in the Utilities panel to reset the date and time.

The time and date can be selected manually or automatically synchronised with your PC. To save the new settings, click “Set”.

Once you have selected “Set” a dialogue box will appear, “Downloaded OK”. Click OK to complete.

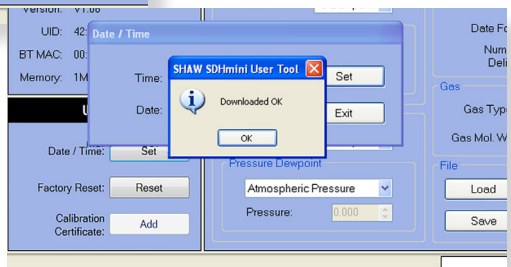

10.5 Settings

The Instrument Settings panel allows changes to the following features, which are explained further in the relevant instruction manual:

International

- Language (on the instrument)
- Date format
- Numerical delimiter – from “.” to “,”

Main and Secondary Displays

- Engineering units
- Pressure dewpoint
- Pressure

Gas

- Gas type
- Gas molecular weight

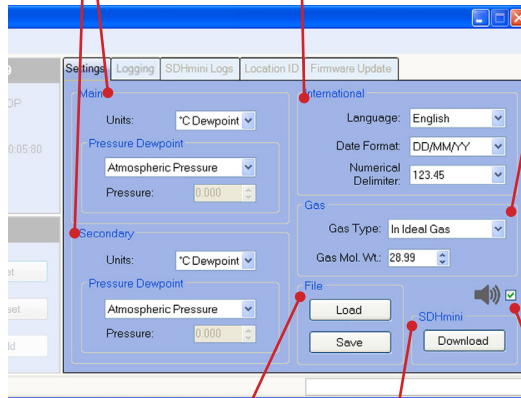

File

- Loads files to the instrument that contain already set parameters and is particularly useful for the multiple setup of instruments
- Save – save settings to a PC file to enable uploading for future use

Sounder/buzzer

Can be selected and deselected for the instrument.

SDHmini

Click download to apply all/any changes to the instrument that are made in this screen.

10.6 Firmware Update

From time to time in the life cycle of the instrument, a number of product improvements or updates in the firmware will be made available. The facility exists for the user to update their instrument without having to return to the manufacturer.

The firmware update file will be sent via email. Please save the firmware update file (*.hex) from the email in a location on your PC.

- Please ensure the instrument is switched on.
- Press the power button and key 4 for 2-3 seconds. The Program Loader will time out after 30 seconds if not used.
- Plug in the USB cable. **Please Note:** On first time use, Windows will load a driver for this *Program Loader* facility.

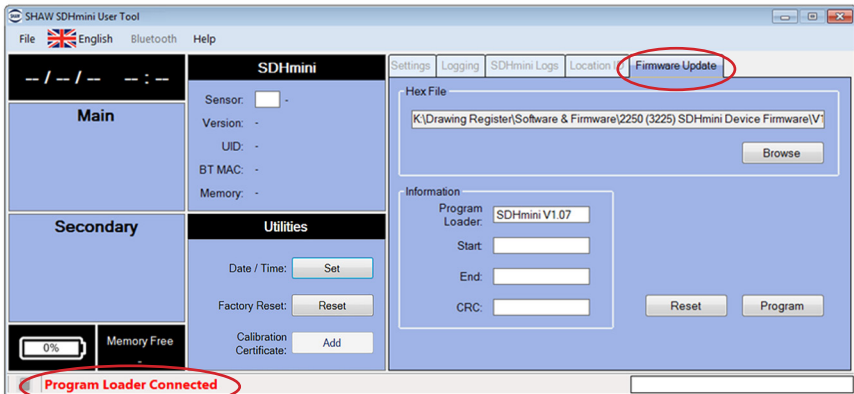

- Note: the *Firmware Update* tab is now accessible and there is a “Program Loader Connected” message in the bottom strip.
- Click *Browse* for the previously saved firmware update (*.hex) file.
- Click *Program*. **Do not unplug the USB cable throughout this process.**

The progress bar will show the following messages:

- “Erasing Memory”
 - “Programming Memory”
 - “CRC OK”
- Click *Reset* to return to the instrument main screen and you will see the message “Program Loader Reset” in the progress bar.
 - Reset the time and date - see *section 10.4 Utilities*



10.7 Factory Reset

A factory reset can be performed using the *Reset* button within the *Utilities* panel in the *SDHmini User Tool* software.

Click *Reset* and you will see the following messages.

- “Formatting memory”
- “Creating file system”
- “AutoCal required”

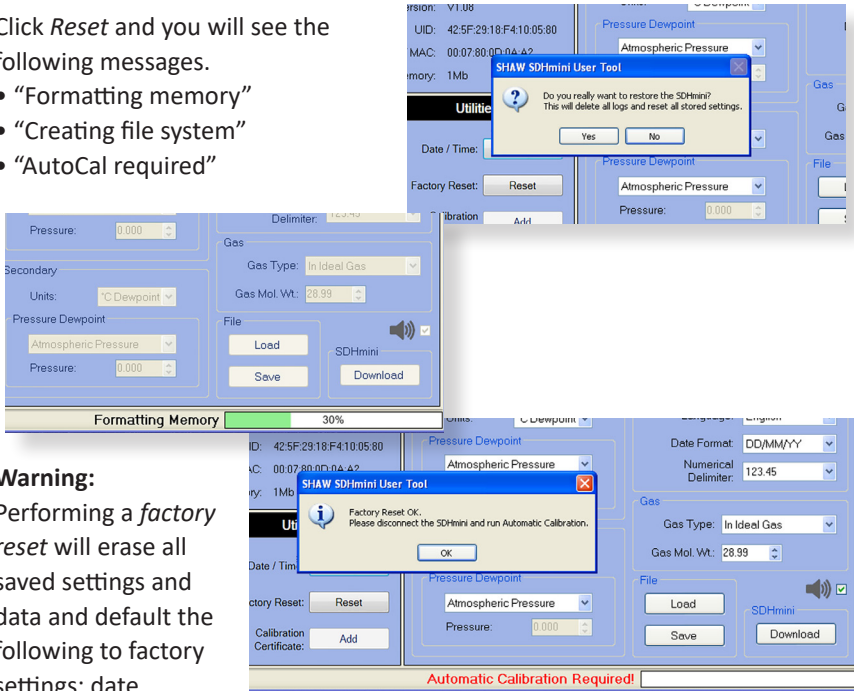

Warning:

Performing a *factory reset* will erase all saved settings and data and default the following to factory settings: date

format, language, main display units, secondary display, gas weight, gas type, AutoCal value and numerical delimiter.

Please contact your distributor for advice before proceeding with a factory reset. If continuing with the *factory reset* option, a dialogue box “Auto Calibration Required” will appear. Please refer to section 5.2 *Auto Calibration (AutoCal)*.

11 Additional Information

11.1 Desiccant and Head Seal Replacement

- Unscrew the four handle retaining screws using a hex socket drive.
- Unscrew the four posidrive countersunk screws which hold the retaining ring to the SDHmini.
- The desiccant filled desiccant chamber can now be removed from the sample chamber by fully retracting the desiccant chamber. Gently pulling on the desiccant chamber a little more, will pull the retaining ring out of the sample chamber. The sample chamber is still retained within the body of the SDHmini.
- Carefully place the knurled section of the desiccant chamber top section with the desiccant base assembly uppermost.
- Fully unscrew the desiccant head base assembly turning it anticlockwise. The desiccant head base may require slight loosening by placing in a soft jaw vice before this step is carried out. Do not fully unscrew with desiccant chamber base section at the bottom, as this will spill desiccant.

Only use soft jaws. Do not use tools or vice with hard jaws.

- There is no need to remove the retaining ring from the desiccant chamber top section except perhaps to change an O-ring.
- Dispose of used desiccant and refill with new, up to a level of 3 mm from the bottom of the screw thread.
- Insert the desiccant chamber base assembly back into the refilled desiccant chamber top section. Remember to ensure that the retaining ring is in place and in the correct orientation prior to reassembly by re-tightening the threaded parts.

Only use soft jaws. Do not use tools or vice with hard jaws.

- Insert desiccant head and retaining ring back into the sample chamber pushing down squarely and firmly to push past the resistance of the O-ring at the top of the sample chamber.
- Push the desiccant chamber back into the sample chamber.
- Align the countersunk holes in the retaining ring to the holes in the housing and sample chamber within.
- Reattach and tighten the four countersunk screws using the posidrive screwdriver.
- Reattach the handle using the four cap head M4 screws and the hex drive.

11.2 Temperature

Typical ambient variations experienced throughout the world are quite acceptable but avoid placing the instrument in direct sunlight or near a source of radiant or convected heat. In countries that experience extremes of temperature, always carry out the automatic calibration with the instrument at its operating temperature.

11.3 Response Time

The response time of any water vapour pressure detector will naturally be very much quicker from dry to wet, than from wet to dry. This is the reason that the SDHmini is so successful. The sensor is kept in a dry condition when it is not in use and therefore results are obtained in the quickest possible time.

To check whether a particular instrument is within specification, carry out the automatic calibration procedure, close the instrument head and note the reading ten minutes later. If the unit has not dried down to -40°C after this ten minute period, the instrument should be returned to your supplier/authorised distributor for examination.

11.4 Guarantee

All products are guaranteed for two years from the date of purchase, some exclusions are as follows:

Removing protective guard from any sensor, subjecting sensor to shock or black list gases e.g. caustic and acidic gases like ammonia and chlorine, tampering with any internal electronics, subjecting to excessive flow rate, contaminants and general misuse.

If you suspect a fault which you feel needs to be attended to under guarantee please contact us for assistance hopefully to help fault find and effect a remedy and if this is not successful, to give precise instructions for the return for inspection.

No equipment will be replaced or repaired without having been returned for inspection either to ourselves or an authorised distributor.

11.5 Basic Definitions

Water Vapour Pressure

The pressure exerted by the water vapour contained in any mixture of gases. The total pressure exerted by the gas mixture is the sum of the pressures exerted by its components – including the water vapour. Water Vapour Pressure varies in direct proportion to the total gas.

Dewpoint Temperature

The temperature to which the gas must be cooled in order that it should be saturated with water vapour (i.e. 100% relative humidity). For practical reasons it is referred to dewpoint above 0 °C and frostpoint below 0 °C.

Parts Per Million by Volume

ppm(v) is the ratio of the water vapour pressure to the total gas pressure.

Parts Per Million by Weight

ppm(w) is the ratio of the molecular weight of water vapour to the molecular weight of the carrier gas mixture.

11.6 Problem Guide

Fault	Explanation	Required Action	Notes
Unit does not turn on. Screen remains blank and back light off.	Battery low level.	Connect a battery charger unit for a minimum of 12 hours charging.	
AutoCal failure.	Sensor sensitivity too low.	Repeat AutoCal.	If AutoCal fails, contact supplier to replace sensor.
Unit always reads lower limit.	Sensor cable broken.	Repair cable.	
Unit will not dry down to lower limit.	Sieve wet.	Perform service on unit using Service Kit.	Service Kit available from supplier.
'O' ring failure.		Perform service on unit using Service Kit.	Service Kit available from supplier.
Battery has short life between charges.	Battery reaching end of life.	Return to supplier/ authorised distributor for battery replacement/ exchange.	Order from supplier.
Keypad damaged.	Check function of keypad electrically.	Contact supplier.	

12.0 SDHmini Specifications

Accuracy:	±2 °C (±3.6 °F) dewpoint
Type:	Battery powered hygrometer complete with carrying case. For use with desiccant chamber for rapid readings.
Dimensions:	97 mm (w) x 211 mm (h (259 mm head extended)) x 147 mm (d) 3.8 in (w) x 8.3 in (h (10.2 in head extended)) x 5.8 in (d)
Weight:	1.75 kg (3.8 lbs)
Display:	Full colour graphics LCD. 320 x 240 resolution. Three main viewing - digital, graphical and a traditional moving coil. Secondary display in the top right for display of readings in alternative units of measurement.
Sensor Connection:	Internal
Power Supply:	Single lithium-ion cell.
Sampling:	Pressure: Atmospheric with flow rate of 2 - 5 litres/minute.
Operating Temperature:	-20 °C to +50 °C (-4 °F to +122 °F)
Storage Temperature:	-30 °C to +70 °C (-22 °F to +158 °F)
Operating Humidity:	95% RH non-condensing
Calibration:	AutoCal on all (but Blue range)
Accessories/Options:	Sample System, Service Kit
Sensor Type (r):	Sensor Range
Purple (P):	-100 °C to 0 °C dewpoint, 0 - 6000 ppm(v)
Red (R):	-80 °C to -20 °C dewpoint, 0 - 1000 ppm(v)
Grey (G):	-80 °C to 0 °C dewpoint, 0 - 6000 ppm(v)
Blue (B):	-80 °C to +20 °C dewpoint, 0 - 23000 ppm(v)
Silver (S):	-100 °C to -20 °C dewpoint, 0 - 1000 ppm(v)
Gold (Gl):	-110 °C to 0 °C dewpoint, 0 - 6000 ppm(v)
Sensor:	Operating Principle: SHAW Ultra High Capacitance Aluminium Oxide Sensor

13.0 SDHmini General Assembly Diagram

FRONT VIEW

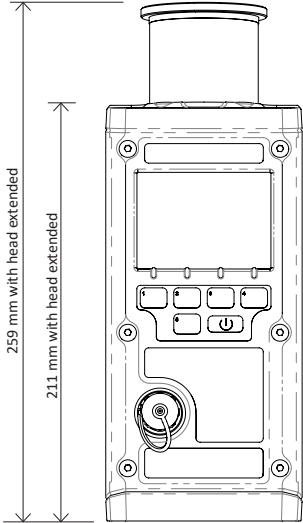

REAR VIEW

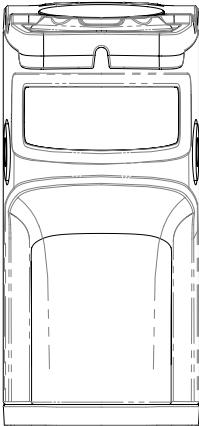

SIDE VIEW

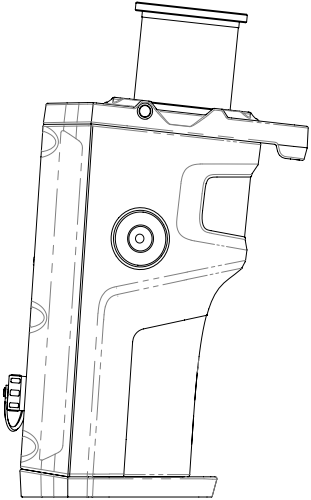

TOP VIEW

