

SNA5000A Series

Vector Network Analyzer

User Manual

UM09050-E03B



Content

Content	1
1 Copyright	7
2 Safety Requirement	8
2.1 Safety terms and symbols	8
2.2 Operating environment	9
2.3 Cooling requirement	10
2.4 AC power supply	10
2.5 Power supply and grounding	10
2.6 Calibration	11
2.7 Cleaning	11
2.8 Exceptional conditions	11
3 Product Introduction	12
3.1 General Description	12
3.2 Features	12
4 User Manual Overview	14
5 Quick Start	16
5.1 Dimensions	16
5.2 Power supply	17
5.3 Front panel	18
5.3.1 Functional keyboard	19
5.3.2 Digital keyboard	21
5.3.3 Power switch	22
5.3.4 RF connectors	22
5.4 Rear panel	23
5.5 OCXO option installation guide	25
5.6 User interface	26
5.6.1 Active entry	27
5.6.2 Value of marker	27
5.6.3 Trace State	27
5.6.4 Channel State	28
5.6.5 Hardkeys	28
5.6.6 Function Keys	28
5.6.7 Label Page	29
5.6.8 Window State	30
5.6.9 Stimulus Range	30
5.6.10 Status Bar	30
5.6.11 Message Bar	31

5.6.12	Graffiti Function	31
5.7	Touch Screen.....	34
5.8	Help Information	34
6	Set Up a Measurement	35
6.1	Measurement parameters	35
6.1.1	S parameters.....	35
6.1.2	Balanced Measurement	36
6.1.3	Receiver Measurement.....	43
6.1.4	Wave (Receivers notation).....	44
6.2	Frequency range	45
6.2.1	Set the frequency range.....	45
6.2.2	CW time sweep or power sweep	46
6.2.3	Frequency resolution.....	46
6.3	Power level	47
6.4	Sweep.....	50
6.4.1	Points	50
6.4.2	Sweep type	51
6.5	Trigger.....	54
6.5.1	Trigger Settings.....	54
6.5.2	Trigger source	54
6.5.3	Trigger Range	55
6.5.4	Channel Settings.....	55
6.5.5	Trigger mode	56
6.5.6	External and auxiliary triggers.....	57
6.6	Data format.....	61
6.6.1	Display format	61
6.6.2	LF Cartesian coordinates display format	61
6.6.3	Polar coordinates	63
6.6.4	Smith circle diagram.....	64
6.7	Scale.....	66
6.7.1	Scale/reference level and position	66
6.7.2	Scaling coupling	67
6.7.3	Electrical delay	68
6.7.4	Amplitude offset and amplitude slope	69
6.7.5	Phase deviation.....	69
6.7.6	Divisions.....	70
6.7.7	Scale type	70
6.8	Avg BW.....	71
6.8.1	Overview	71

6.8.2	Averaging	71
6.8.3	IF Bandwidth	72
6.8.4	Smoothing	73
6.9	Preset instructions	74
7	Measurement Calibration	76
7.1	Overview	76
7.2	Calibration type	77
7.3	Checking Calibration Status	81
7.3.1	Execution Status of Error Correction for Each Channel	81
7.3.2	Execution Status of Error Correction for Each Trace	82
7.3.3	Acquisition Status of Calibration Coefficient for Each Channel	82
7.3.4	Procedure to turn on/off calibration property display	83
7.4	S parameter calibration	84
7.4.1	S parameter calibration Kit management	84
7.4.2	S Parameter calibration wizard	96
7.4.3	Open Response Calibration	98
7.4.4	Short circuit response calibration	99
7.4.5	Full 1 port OSL calibration	99
7.4.6	Transmission response calibration (two ports)	100
7.4.7	Enhanced response calibration (two ports)	101
7.4.8	SOLT calibration (two ports)	102
7.4.9	SOLR unknown through calibration (two ports)	103
7.4.10	TRL Direct Reflection Transmission Line Calibration (Two Ports)	104
7.5	Internal source power calibration	105
7.6	Receiver calibration	107
7.7	Port extension	108
7.8	Fixture measurement function	111
7.9	Adapter removal / insertion function	117
7.10	Ecal	119
7.10.1	ECal Overview	119
7.10.2	ECal Config	120
7.10.3	Confidence Check	121
7.10.4	Orientation	122
7.10.5	Characterization	123
8	Data Analysis	124
8.1	Marker	124
8.1.1	Ordinary marker:	124
8.1.2	Reference marker:	124
8.1.3	Marker setting:	124

8.1.4	Marker function:	127
8.1.5	Marker search function:.....	128
8.2	Mathematical operation	133
8.3	Conversion.....	135
8.4	Equation editor	137
8.5	Trace statistics	146
8.6	Limit test	146
8.7	Ripple limit test	149
8.8	Bandwidth limit test.....	151
8.9	Time domain	152
8.9.1	Transform	152
8.9.2	Gating.....	154
8.9.3	Window.....	155
8.9.4	Coupling	157
8.9.5	Marker	158
9	Guide For the TDR Option.....	160
9.1	Overview	160
9.2	Open/Close/Preset TDR Option	161
9.3	TDR Setup Wizard.....	162
9.4	Calibration for TDR Option	163
9.4.1	Deskew.....	163
9.4.2	Deskew & Loss Compensation	164
9.5	TDR Channel Setup	165
9.5.1	DUT Topology.....	165
9.5.2	DUT Length	165
9.5.3	Stimulus Magnitude in Time Domain	166
9.5.4	Port Impedance.....	167
9.5.5	Velocity Factor & Dielectric Constant.....	167
9.5.6	Power Level	167
9.5.7	Average	167
9.5.8	IF Bandwidth	168
9.5.9	Trigger Mode	168
9.6	TDR Trace Setup.....	169
9.6.1	Select a Trace	169
9.6.2	Scale Management	169
9.6.3	Memory Trace Management	170
9.6.4	Measure Parameter & Format	170
9.6.5	Stimulus in Time Domain	172
9.6.6	Smoothing	172

9.6.7	Trace Allocation	172
9.6.8	Trace Setup Coupling	173
9.6.9	Time Domain Gating	173
9.7	TDR Data Analysis & Output	174
9.7.1	Marker Setup	174
9.7.2	Rise Time Search	174
9.7.3	Delta Time Search	175
9.7.4	Peeling	175
9.7.5	File & Data Output	176
9.8	Eye Diagram Simulation	177
9.8.1	Overview	177
9.8.2	Stimulus Bit Pattern	177
9.8.3	Stimulus Signal Setup	179
9.8.4	Eye Diagram Analysis	180
9.8.5	Eye Diagram Scale Management	180
9.8.6	Mask Test for Eye Diagram	181
9.8.7	Jitter & Statistical Eye Diagram	181
9.9	TDR Advanced Waveform Function	183
9.9.1	View point	183
9.9.2	Emphasis/De-emphasis	183
9.9.3	Equalization	184
10	Guide For the SA Option	186
10.1	Overview	186
10.2	User Interface	186
10.3	Create a Spectrum Analysis Channel	187
10.4	Spectrum Analyzer Settings	189
10.4.1	SA Tab Setting	189
10.4.2	SA Tab Processing setup	192
10.4.3	Source Tab	195
10.4.4	Advanced Tab	197
10.4.5	Trace setup	199
10.5	Spectrum Analysis measurement	202
10.5.1	Marker→SA	202
10.5.2	Channel Power	203
10.5.3	ACPR	205
10.5.4	Occupied BW	206
11	The Frequency Offset Mode	208
11.1	Overview	208
11.2	Frequency Offset Mode	208

11.2.1	Frequency Offset settings	209
11.2.2	Setup Examples	212
12	Scalar Mixer Measurements(SMM Option).....	213
12.1	Create an SMM measurement	213
12.2	Configure the Scalar mixer setup	215
12.2.1	Sweep Tab – Mixer Measure Setup box	216
12.2.2	Power Tab - Mixer Measure Setup box.....	217
12.2.3	Mixer Frequency Tab- Mixer Measure Setup box	218
12.2.4	Mixer Setup Tab- Mixer Measure Setup box.....	221
12.3	Do the Source Power Cal of the SMM mode (optional).....	224
12.4	Do the Receiver Cal of the SMM mode (optional)	224
12.5	Do the SMM Calibration	224
12.5.1	Overview	224
12.5.2	Procedure Using Mechanical Calibration Kit	225
12.5.3	Checking Calibration Status.....	225
13	Save and Recall.....	226
14	System setting.....	229
14.1	Communication interface setting	229
14.2	Firmware upgrade	230
14.3	Date/Time setting.....	230
14.4	Screenshot setting.....	231
14.5	Preset	231
14.6	Factory Reset	231
14.7	Help information	232
14.8	Buzzer.....	232
14.9	Self-Test.....	233
14.9.1	Key and touch screen test	233
14.9.2	Performance test.....	233
14.10	System language.....	237
15	Service and Support	237
15.1	Ordering and activating the options	237
15.2	Warranty overview	239

1 Copyright







- ◆ **SIGLENT TECHNOLOGIES CO., LTD** All Rights Reserved.
- ◆ **SIGLENT** is the registered trademark of **SIGLENT TECHNOLOGIES CO., LTD.**
- ◆ Information in this publication replaces all previously corresponding material.
- ◆ **SIGLENT** reserves the right to modify or change parts of or all the specifications or pricing policies at the company's sole decision.
- ◆ Any method of copying, extracting, or translating the contents of this manual is not allowed without the permission of **SIGLENT.**

2 Safety Requirement

This section contains information and warnings that must be observed to keep the instrument operating under the corresponding safety conditions. In addition to the safety precautions specified in this section, you also have to follow common safe operating procedures.

2.1 Safety terms and symbols

When the following terms or symbols appear on the front panel, rear panel, or this manual, it indicates particular attention should be paid.

	Indicates potential injuries or hazards that may happen.
	Indicates electric shock that may happen.
	Indicates measurement grounding
	Indicates safety grounding.
	This is a start/standby switch. Press the switch, the VNA will switch between the working state and the standby state. The switch could not power off the device, to completely power off the VNA, the power cord must be removed from the AC socket.
	Indicates "AC".
CAUTION	Indicates potential damages to the instrument or other property that may happen.
WARNING	Indicates potential injuries or hazards that may happen.

2.2 Operating environment

Use in a clean and dry indoor environment with an ambient temperature range from 0°C to 40°C.

Note: Direct sunlight, electric heaters, and other direct heat sources, should be considered when evaluating the ambient temperature.

	WARNING: Do not operate the VNA in an explosive, dusty or humid environment.
---	---

This instrument meets the EN 61010-1 standard, and has the following restrictions:

Installation (overvoltage) category: Class II (electric supply connector) and Class I (measure terminal)

Pollution level: Class II

Protection level: Class I

Note:

Installation (overvoltage) category Class II indicates the local supply level is suitable for equipment connected to the AC power supply.

Installation (overvoltage) category Class I indicates the signal levels suitable for terminals connected to the RF source.

Pollution level Class II indicates it only occurs in a dry and non-conductive environment, sometimes we should consider the temporary conductivity caused by concentration.

Protection level Class I indicates grounding equipment, it prevents electric shock by connecting the equipment to the ground wire.

	CAUTION: Do not apply excessive pressure or strike the surface of the touch screen.
---	--

	CAUTION: Do not exceed the maximum voltage marked on the front panel connectors.
---	---

2.3 Cooling requirement

This instrument is cooled through a built-in fan. To keep adequate ventilation, a gap of at least 15 cm should be left on both sides, as well as the front and rear panels of the instrument.

	CAUTION: Do not block the vents located along the side and rear panel of the instrument.
---	---

	CAUTION: Do not let any external objects enter the instrument through the vents.
---	---

2.4 AC power supply

The instrument accepts 100-240V, 50/60/400Hz AC power. The maximum power consumption is 90W with complete options.

Note: The instrument can operate within the following input ranges:

Voltage range:	90 - 264 Vrms	90 - 132 Vrms
Frequency range:	47 - 63 Hz	380 - 420 Hz

2.5 Power supply and grounding

The instrument has a three-terminal plug and an IEC320 (Type C13) standard connector for the input power and grounding connections. The grounding terminal on the socket is directly connected to the instrument shell. To prevent electric shock, the plug must be inserted into a well-grounded socket. Please use the power cord provided to connect the instrument to the power source.

	WARNING: Danger of electric shock! Disconnected or broken internal or external grounding wires will increase the risk of electric shock. It is strictly forbidden to destroy the protective grounding wire or safety grounding terminals.
---	---

The location of the instrument should be convenient to access the power supply. To completely power off the instrument, the power cord should be removed from the power socket of the instrument. When the instrument is idle for long durations, it is recommended to unplug the power cord from the AC socket.



CAUTION: The RF connector's shell on the front panel is connected to the instrument's shell, and then connected to the earth ground.

2.6 Calibration

The recommended calibration cycle is one year. Calibration should only be performed by qualified personnel.

2.7 Cleaning

Only a soft damp cloth without any chemical/corrosive substances can be used to clean the instrument. Do not clean or use the product in wet environments. To avoid electric shock, unplug the power cord from the AC socket before cleaning.



WARNING: Danger of electric shock!

Do not disassemble the instrument. Maintenance must be carried out by qualified personnel only.

2.8 Exceptional conditions

Use the instrument only for the purpose specified by the manufacturer. Do not use if the instrument has visible damage or has endured severe transportation vibration. If the device is suspected to be damaged, please disconnect the power cord and contact your local SIGLENT office. To operate the instrument correctly, all instructions and marks should be read carefully.



WARNING: Use of the instrument for purposes unspecified by the manufacturer may damage the instrument.

3 Product Introduction

3.1 General Description

The SIGLENT SNA5000A series of vector network analyzers have a frequency range of 9 kHz to 8.5 GHz, which support 2/4-port scattering, differential, and time-domain parameter measurements. The SNA5000A series are ideal for determining the Q-factor, bandwidth, and insertion loss of a filter. They feature impedance conversion, movement of measurement plane, limit testing, ripple test, fixture simulation, and adapter removal / insertion adjustments. The VNAs have five sweep types: Linear-Frequency mode, Log-Frequency mode, Power-Sweep mode, CW-Time mode, and Segment-Sweep mode. They also support scattering-parameter correction of SOLT, SOLR, TRL, Response, and Enhanced Response for increased flexibility in R&D and manufacturing applications.

3.2 Features

- ◆ Frequency range : 9 kHz-8.5 GHz
- ◆ Ports : 2/4
- ◆ Frequency resolution : 1 Hz
- ◆ Level resolution : 0.05 dB
- ◆ Range of IFBW : 10 Hz-3 MHz
- ◆ Setting range of output level : -55 dBm ~ +10 dBm
- ◆ Dynamic range : 125 dB
- ◆ Trace noise: 0.003 dBrms , 0.05 rms
- ◆ Types of calibration :
Response calibration, Enhanced Response calibration, Full-one port calibration, Full-two port calibration, Full-three port calibration, Full-four port calibration, TRL calibration
- ◆ Types of measurement :
Scattering-parameter measurement, differential-parameter measurement, receiver measurement, time-domain parameter analysis, limit test, ripple test, impedance conversion, fixture simulation, adapter removal/insertion
- ◆ Optional Bias-Tees
- ◆ Interface: LAN, USB Device, USB Host (USB-GPIB)

- ◆ Remote control:
SCPI / Labview / IVI based on USB-TMC / VXI-11 / Socket / Telnet / Webserver.
- ◆ 12.1-inch touch screen
- ◆ Video output: HDMI

4 User Manual Overview

Main Contents

Chapter1. Copyright

Chapter2. Safety Requirement

Chapter3. Product Introduction

This chapter introduces the characteristic index and function of vector network analysis.

Chapter4. User Manual Overview

This chapter introduces the chapters of the user manual.

Chapter5. Quick Start

This chapter introduces the appearance and size of the vector network analyzer, the basic operation of the front and rear panels, user interface, buttons, and touch screen.

Chapter6. Set Up a Measurement

This chapter describes the measurement function, sweeping trigger setting, and other functions of the vector network analyzer, and introduces the functions under each menu in detail.

Chapter7. Measurement Calibration

This chapter introduces the different calibration methods of S parameters, power calibration methods, test fixture, and other functions of vector network analyzer in detail.

Chapter8. Data Analysis

This chapter introduces the mathematical analysis function, including time-domain analysis, windows, coupling, markers, and other functions.

Chapter9. Guide For the TDR Option

This chapter introduces how to use the TDR option.

Chapter10. Guide For the SA Option

This chapter introduces how to use the SA option.

Chapter11. The Frequency Offset Mode

This chapter introduces the function of SNA Sources tune to frequencies that are different (offset) from the VNA Receivers.

Chapter12. Scalar Mixer Measurements(SMM Option)

This chapter introduces how to do the Scalar Mixer Measurement.

Chapter13. Save and Recall

This chapter introduces the data save and recall processes.

Chapter14. System Setting

This chapter provides information about the system settings.

Chapter15. Service and Support

This chapter provides information about service and support.

5 Quick Start

5.1 Dimensions

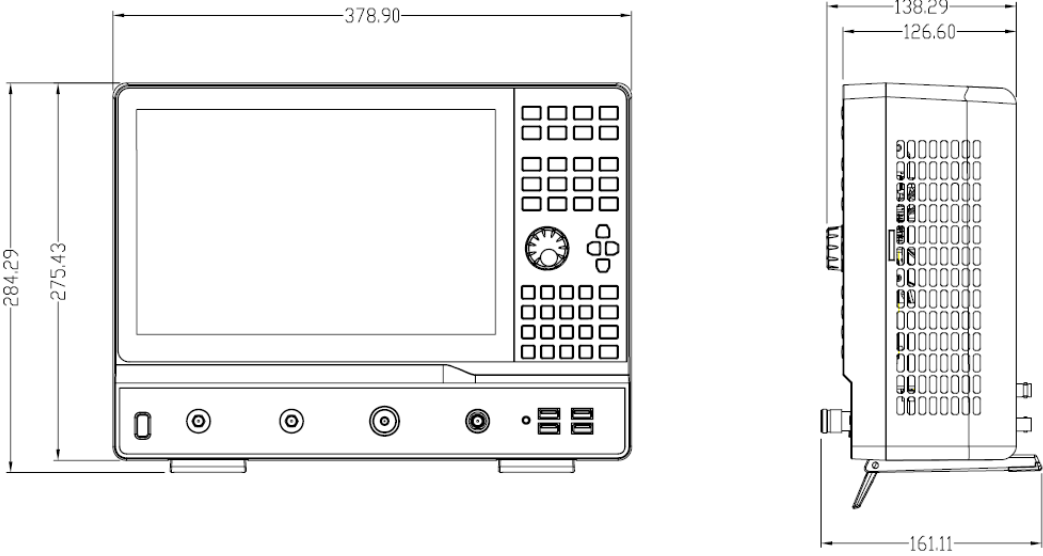

Figure 5-1 Front view and side view

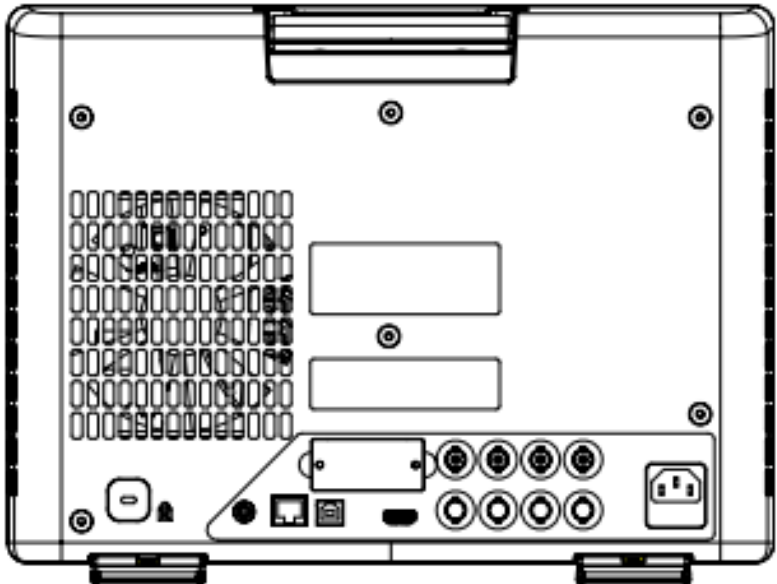

Figure 5-2 Rear panel view

5.2 Power supply

The equipment accepts 100-240V, 50/60/400Hz AC power supplies. Please use the power cord provided to connect the instrument to the power source as shown in the figure below.



Figure 5-3 Power interface

5.3 Front panel

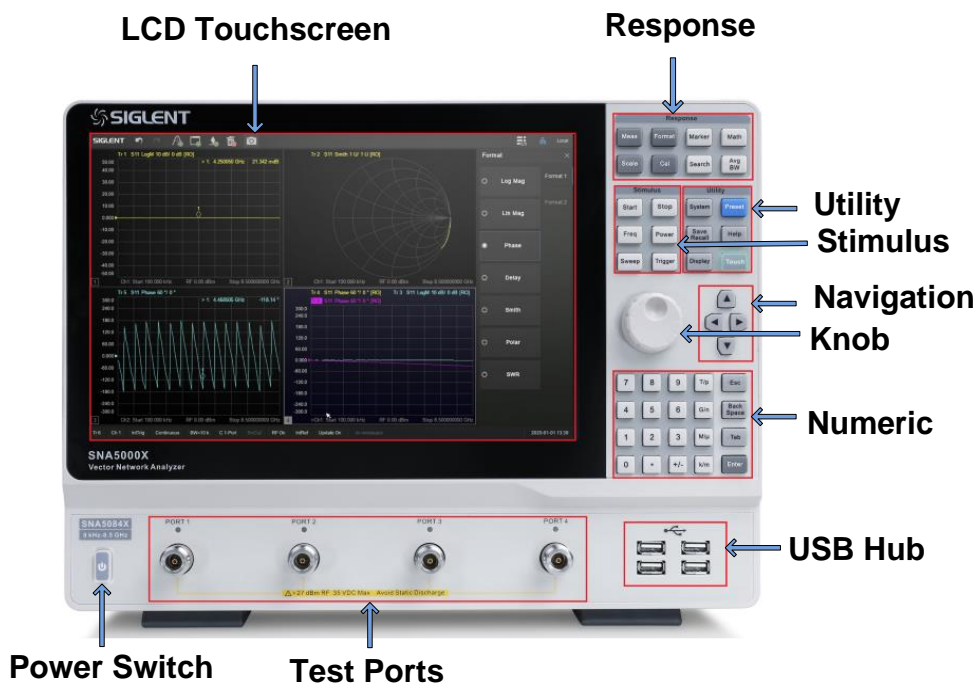

Figure 5-4 Front panel

Table 5-1 Front panel area description:

Number	Items	Description
1	LCD Touchscreen	12.1 inch TFT color capacitive LCD touchscreen. Notes: Avoid touching the LCD touchscreen with sharp objects. The effective pixel ratio of the screen is more than 99.998%, so it doesn't mean a fault when the screen has some black / blue / green / red fixed points less than 0.002%. Screen savers are not recommended. The LCD screen is unlikely to suffer from image burn-in.
2	Response	Includes the setting of measurement parameters, parameter format, markers, calibration, and so on.
3	Utility	Includes the function keys of the system, help, display, and so on.
4	Stimulus	Includes the setting of measurement frequency, sweep time, sweep points, trigger, and so on.

5	Navigation	Press the up, down, left, and right buttons to select the desired operation.
6	Knob	Rotate the button left or right to move the cursor or change the parameter value, the effect of pressing the button is the same as “Enter”.
7	Numeric	Includes the parameter numbers and units.
8	USB Hub	Includes four USB ports for data exchange and power supply with peripherals. The total current of four USB ports is less than 2A.
9	Test ports	Connect to the DUT for signal transmission and reception.
10	Power Switch	Power on/off the equipment.

5.3.1 Functional keyboard









Table 5-2 Front panel functional keyboard description:

Keys	Description
Meas	Set the single-ended/ differential S parameter measurement, reference/ measurement receivers power measurement, and so on.
Format	Set the measurement parameter's display format, such as Log Mag, Lin Mag, Smith Chart, Polar Chart, SWR, Phase, and so on.
Marker	Set markers to obtain the value of measurement parameters.
Math	Contains storing measurement data in memory, comparing current data with previous data, time-domain analysis of measurement results, and so on.
Scale	Set the scale of parameter levels.
Cal	Include the setting of S parameter calibration and power calibration.
Search	Press this button to get the measurement parameter's maximum/minimum value, bandwidth, Q-factor, and so on.
Avg BW	Press this button to smooth/average measurement data, set the receiver's IF bandwidth, and so on.
Start	Set start frequency.

<input type="button" value="Stop"/>	Set stop frequency.
<input type="button" value="Freq"/>	Set start frequency, stop frequency, center frequency, frequency span, measurement point.
<input type="button" value="Power"/>	Set the RF power level, turn on/off RF power, and so on.
<input type="button" value="Sweep"/>	Set sweep mode, sweep point, sweep time, log/lin frequency sweep mode, and so on.
<input type="button" value="Trigger"/>	Press this button to choose the trigger source, set the trigger mode, and so on.
<input type="button" value="System"/>	Set IP address, system time, language, and so on.
<input type="button" value="Preset"/>	Press this button to revert to the default parameters.
<input type="button" value="Save"/> <input type="button" value="Recall"/>	Save and recall the measurement data, status, calibration data.
<input type="button" value="Help"/>	Open the help file.
<input type="button" value="Display"/>	Set measurement window, measurement channel, measurement trace, and so on.
<input type="button" value="Touch"/>	Press this button to turn on/off the screen's touch function.

5.3.2 Digital keyboard

Table 5-3 Front panel digital keyboard description:

Keys	Description
	When setting the frequency, press this key to set the unit as THz. if the input is time-related, press this key to set the unit as ps.
	When setting the frequency, press this key to set the unit as GHz. if the input is time-related, press this key to set the unit as ns.
	When setting the frequency, press this key to set the unit as MHz. if the input is time-related, press this key to set the unit as us.
	When setting the frequency, press this key to set the unit as kHz. if the input is time-related, press this key to set the unit as ms.
	During the parameter editing process, pressing this button will clear the input of the active function area and exit the parameter input state. Press this button to return to local control if previously controlling the instrument remotely.
	During the parameter editing process, pressing this button will clear the input of the active function area from right to left.
	Pressing this button will activate every sub-function area from top to bottom in turn.
	In the parameter input process, pressing this button will end the parameter input process and add the currently set units for the parameter.

5.3.3 Power switch

Stand-by is indicated by a constant orange-colored power switch.

A single button press will cause the light to turn white which indicates the instrument is operating.

Continuous white indicates the instrument is operating.

A short press of this button (one second) causes the light to turn orange which indicates the instrument is in the stand-by state after saving the settings.

A long press of this button (three seconds) will cause the light to turn orange which indicates the instrument is in the stand-by state immediately without saving the settings.

5.3.4 RF connectors



Figure 5-5 Front panel RF connectors (2-port VNA)



Figure 5-6 Front panel RF connectors (4-port VNA)

- ◆ The number of RF connectors is two or four, depending on the instrument configuration.
- ◆ When an RF connector is transmitting an RF signal, the corresponding orange light above the RF connector will be lit.
- ◆ To avoid damage to the instrument, the RF connector input signal must meet the following: The DC voltage and the maximum continuous RF power cannot exceed 35 V and 27 dBm respectively.

5.4 Rear panel

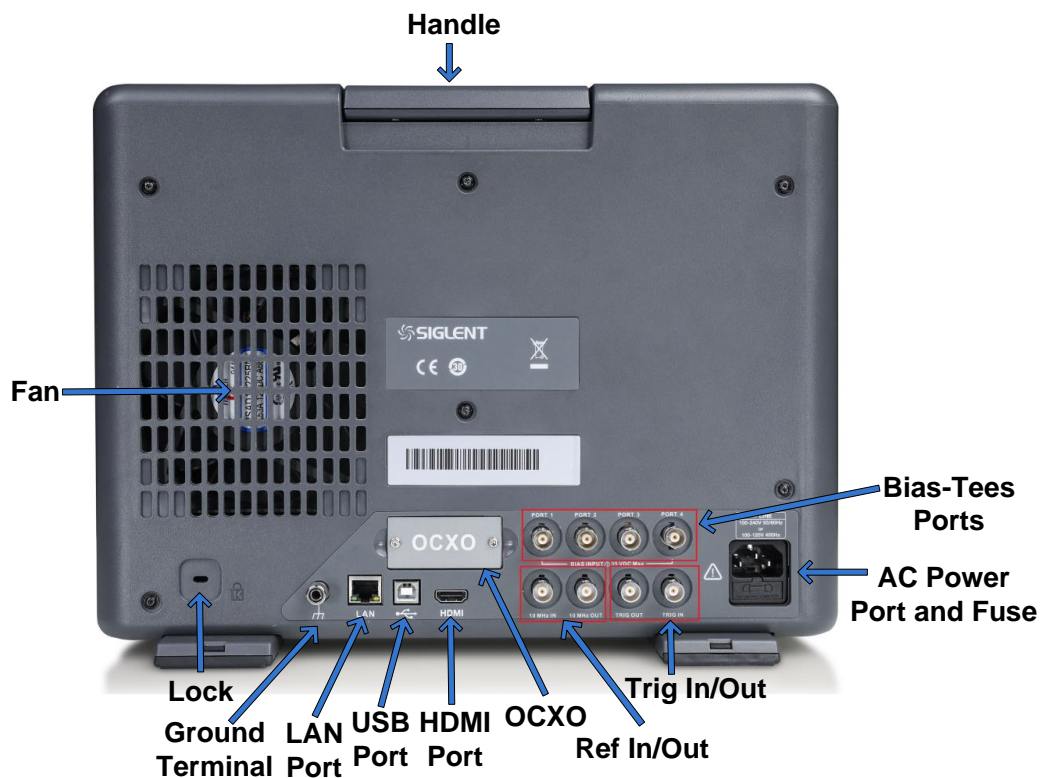

Figure 5-7 Rear panel

Table 5-4 Rear panel area description:

Items	Description
Handle	Portable handle to carry the instrument.
Fan	Used to cool down internal components of the instrument.
Lock	Used to fix the instrument on the fixed object such as a table to help prevent theft.
Ground Terminal	Connect the instrument with earth ground. Electrically connects the metallic shell and connectors of the instrument to earth ground.
LAN Port	Used to connect the instrument to a LAN for data exchange with peripherals such as PCs.
USB Port	Include one USB port for data exchange with peripherals.

HDMI Port	Connect the port to a compatible external monitor.
OCXO	Install the OCXO option to use the high-performance reference source.
10MHz Ref Signal Input	The characteristic impedance of this port is 50 Ω . The detectable input frequency and power range are 10 MHz \pm 10 ppm, -3 dBm to +10 dBm respectively. When there is a 10 MHz external reference signal on the port, the VNA's transmitting signal will be locked into this 10 MHz external reference signal. Otherwise, the VNA's transmitting signal will be locked into the internal 10 MHz reference signal.
10MHz Ref Signal Output	This port can output a 10 MHz reference signal so that it can be used by other equipment. The characteristic impedance, output frequency, and power range are 50 Ω , 10 MHz \pm 10 ppm, -3 dBm to +10 dBm respectively.
Trigger In	When there is an external trigger signal at the port, the VNA will use this external trigger signal instead of the internal trigger signal. Input level: Low threshold voltage: 1.1 V High threshold voltage: 2.5 V Input level range: 0 to + 5 V Pulse width: $\geq 2 \mu s$ Polarity: Positive or negative
Trigger Out	This port can output a trigger signal so that it can be used by other equipment. Max output current: 20 mA Output level: Low-level voltage : 0 V High-level voltage : 3.3 V Pulse width : 1 μs Polarity : Positive or negative
Bias-Tees Ports	Connect an external DC voltage source to this port to provide DC power for the DUT such as a power amplifier. The DC voltage and current cannot exceed 35V. This is the rated current of the fuse.
AC Power Port and Fuse	The equipment accepts 100-240 V, 50/60/400 Hz AC power supply. please connect the VNA to the AC power supply with the supplied power cord. Make sure the current does not exceed the rated current of the fuse.

5.5 OCXO option installation guide

Power off the instrument, use a screwdriver to remove the cover where the OCXO option is located on the rear panel.

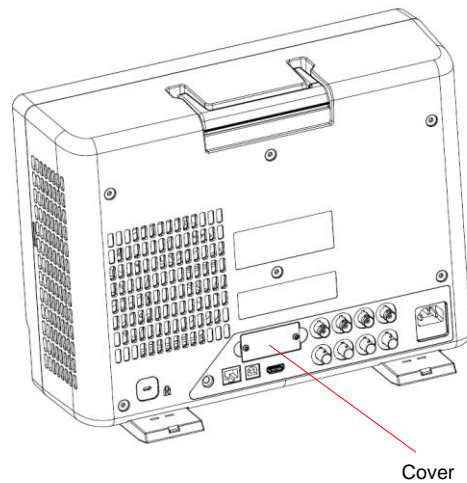

Figure 5-8 OCXO option installation guide

Insert the fixed OCXO module into the instrument's slot, then tighten the screws.

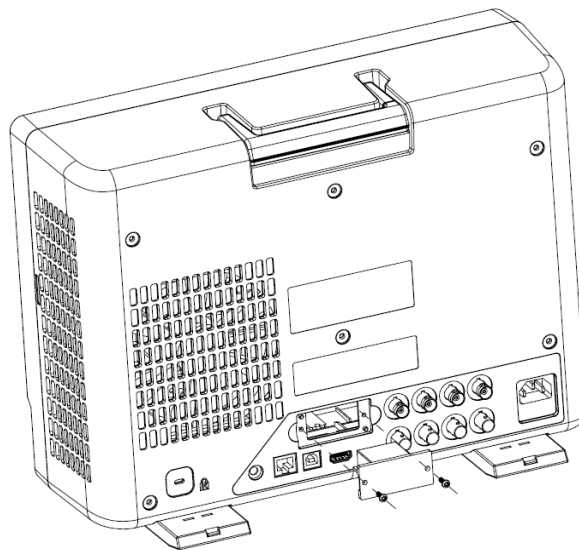

Figure 5-9 OCXO option installation guide

Power on the instrument and install the OCXO option's license activation code for permanent installation.

5.6 User interface

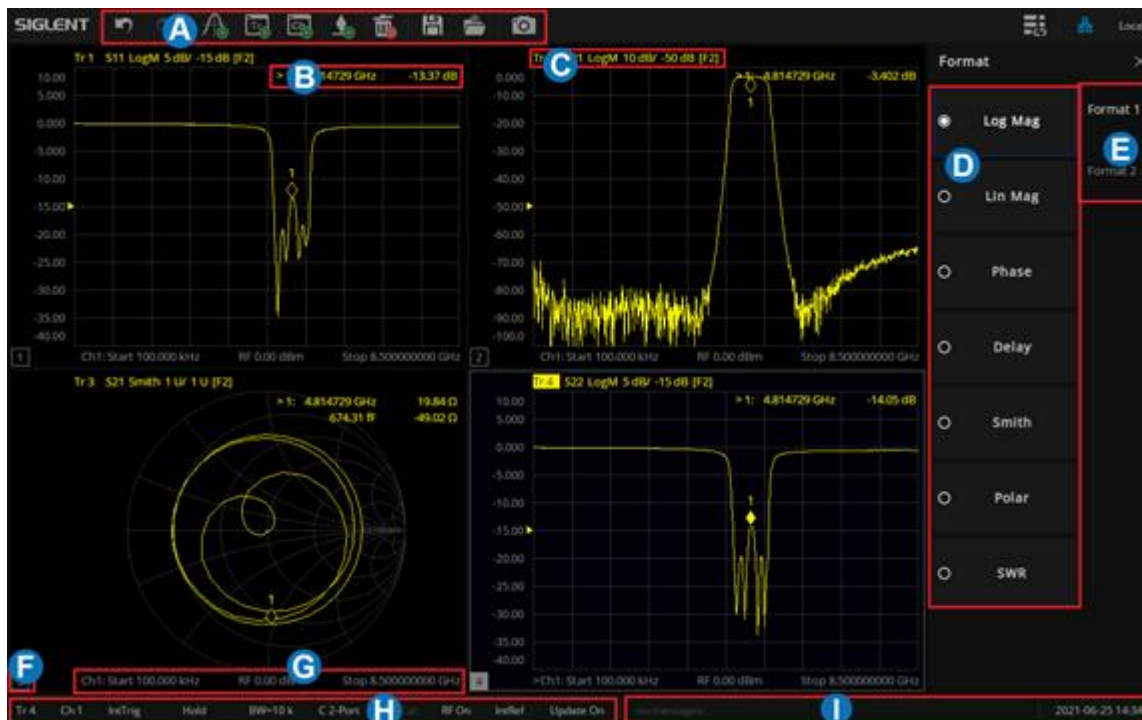









Figure 5-10 User interface

- A. Active Entry
- B. Marker Readout
- C. Trace Status
- D. SoftKeys
- E. Softtabs
- F. Window number
- G. Stimulus Range
- H. Status Bar
- I. Message Bar

5.6.1 Active entry

Table 5-5 Active entry description:

Functions	Functions Description
	Recall the previous step.
	Recovering the withdrawn operation.
	Add a measurement trace.
	Add a measurement window.
	Add a marker.
	Delete active window or trace. Note: Keep at least one trace on the interface.
	Screenshot (Ctrl+P)

5.6.2 Value of marker

Display the frequency and reading of the marker.

5.6.3 Trace State

- ◆ A trace is a series of measured data points. Up to 256 traces can be created. In addition, one historical memory trace for each active trace can be stored and displayed. Mathematical operations can be performed on the current trace data and the historical memory trace.
- ◆ Press the **Display** button in the front panel, and the **Trace Setup** menu pops up on the right side of the screen to manage the operation Trace, such as adding a trace, deleting a trace, maximizing the trace window, moving traces between Windows, keeping the trace to the maximum or minimum value without displaying the current value, etc.
- ◆ Select a trace line and press the **Scale** button to change the reference electric equalization operation.

5.6.4 Channel State

- ◆ Channels contain traces. Up to 256 channels can be created. The channel setting determines how trace data is measured, and all traces assigned to a channel share the same channel setting.
- ◆ Press the **Display** button in the front panel, and the **Channel Setup** menu pops up on the right side of the screen. This can be used to manage operation channels, such as adding channels, copying channels, and deleting channels.

5.6.5 Hardkeys

Using Display Setup in the Display submenu, you can set Hardkeys and open the virtual keypad on the right side of the screen to operate the vector network analyzer without operating the function keys on the front panel.

5.6.6 Function Keys

Table 5-6 Function Keys Interface Description

Functions	Functions Description
Log Mag	Parameters are displayed in logarithmic amplitude mode.
Lin Mag	The parameters are displayed in amplitude linear fashion.
Phase	Displays the phase of the parameter.
Delay	Displays the delay of the parameter.
Smith	The parameters are shown in the form of a Smith chart.
Polar	The parameters are displayed in polar coordinates.
SWR	The parameters are shown in SWR.

5.6.7 Label Page

Displays all parameter display formats supported by the vector network analyzer.

5.6.8 Window State

- ◆ Windows can be used to view trace data and up to 100 windows can be created.
- ◆ Press the button of **Display** in the front panel and the **Window Setup** menu pops up on the right side of the screen. It can be used to manage operation windows, such as selecting a window, adding a window, deleting a window, maximizing a window, layout, and so on.

5.6.9 Stimulus Range

Displays the excitation signal set in the current window, including starting frequency, ending frequency, internal source output power, etc.

5.6.10 Status Bar

Table 5-7 Status Bar Interface Description

Functions	Functions Description
IntTrig	Displays the current trigger mode.
Continuous	Continuous trigger, single trigger, and other trigger mode displays.
BW=10 k	Display of the current IF bandwidth.
C 1-Port	S parameter calibration data state loading display.
SrcCal	Display whether the internal source power calibration data state is loaded or not. A Gray dark shaded label represents an unavailable selection/option.
RF On	Internal source output power ON and off, RF ON stands for ON.
IntRef	A display that currently uses an internal or external reference signal.
Update On	UI waveform update or not.

5.6.11 Message Bar

Displays the current date information and error information during testing.

5.6.12 Graffiti Function

This product provides a basic graffiti function, which is used to draw graphics and mark information on the main interface. This feature is great for annotating screenshots and adding important details before saving.

- **Graffiti function menu bar**

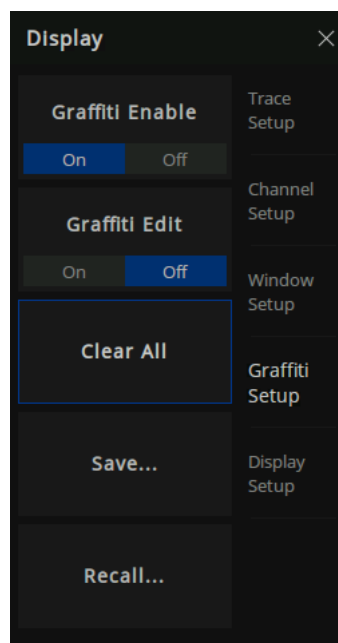

Figure 5-11 graffiti function menu bar

As shown in Figure 1-11, the graffiti menu contains functions of enable, edit, clear, save and call.

● Graffiti Editing Interface

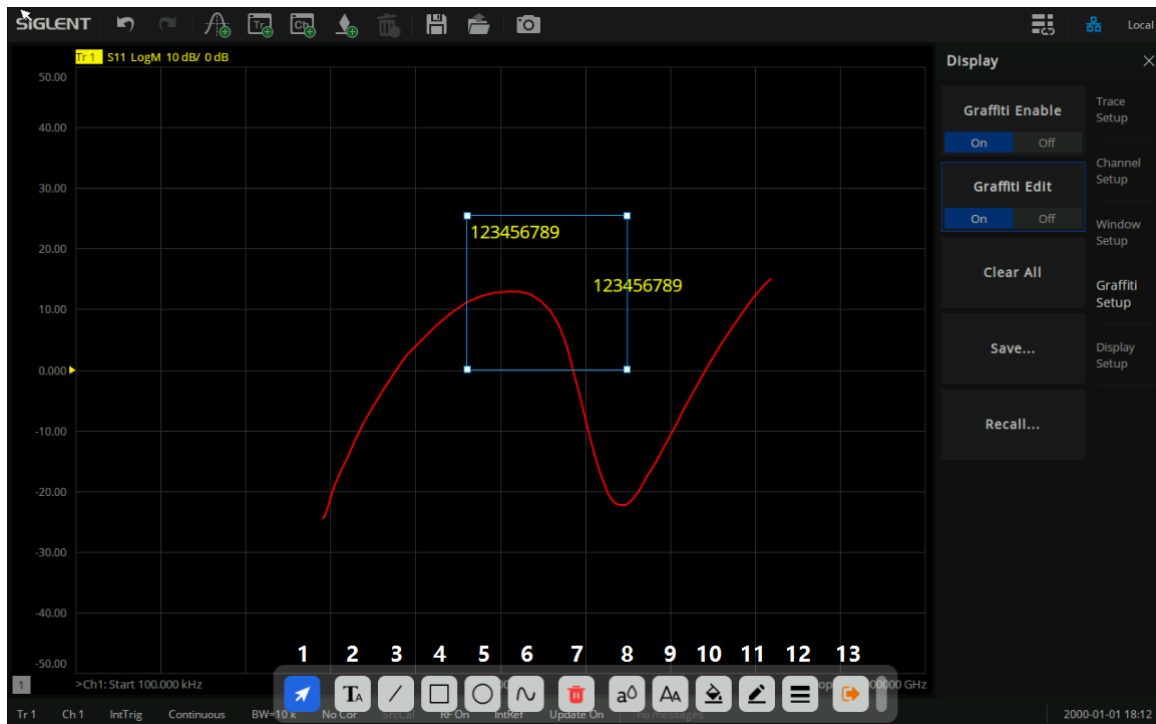

Figure 5-12 graffiti editing interface

As shown in Figure 1-12, the toolbar at the bottom of the interface displays a series of tools for graphic editing:

1. Selection tool: A series of editing can be carried out after the drawing is selected
2. Text tool: Add text notes in the interface
3. Line tool: Add a line in the interface
4. Rectangle tool: Add a rectangle to the interface
5. Ellipse tool: Add an ellipse to the interface
6. Curve tool: Draw a series of lines arbitrarily in the interface (double click the mouse/ double click the finger on the screen to finish drawing)
7. Delete tool: Delete the currently selected drawing
8. Text color tool: Set text color (support graphics: text)
9. Text size tool: Set text size (support graphics: text)
10. Background filling tool: Fill graphics background color (support graphics: text, rectangle, ellipse)
11. Border color tool: Set the border color of graphics (support graphics: text, line, rectangle, ellipse, curve)

12. Border line tool: Adjust the border line thickness of graphics (support graphics: text, line segment, rectangle, ellipse, curve)
13. Exit editing tool: Exit the current editing state

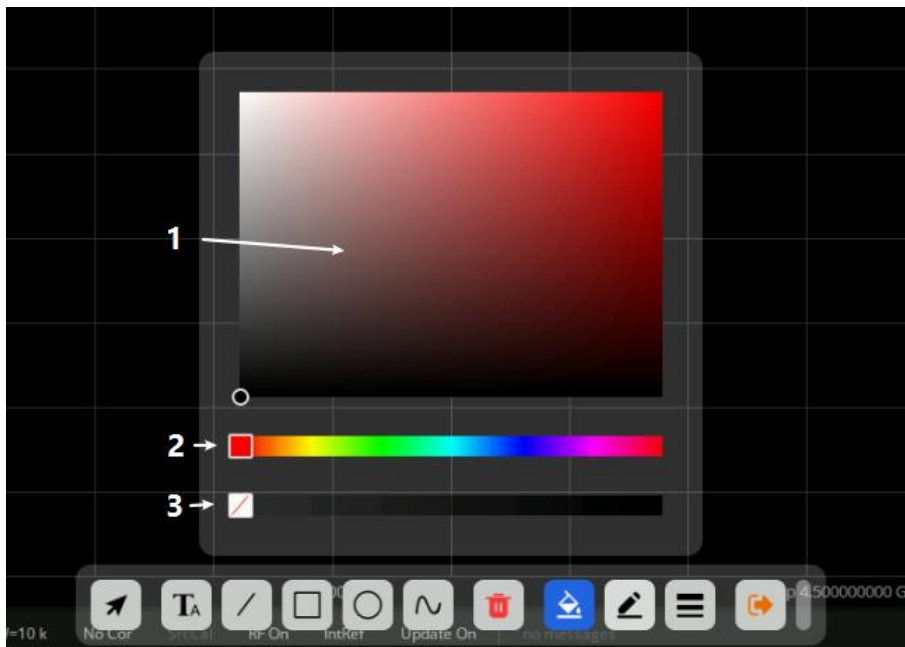

Figure 5-13 Color selection interface

As shown in Figure 1-13, after calling out this interface, you can adjust the corresponding colors of the graphics:

1. Color shade selection tool: Mouse/ finger click to select the appropriate brightness of the color
2. Color selection tool: Select a specific color
3. Color transparency tool: Adjust color transparency (the more right, the lower color transparency)

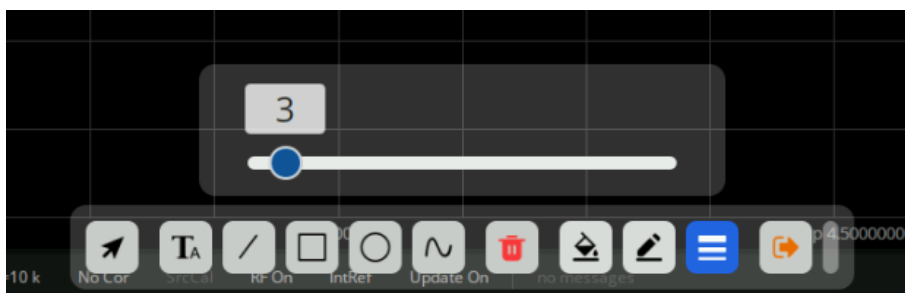

Figure 5-14 Line thickness adjustment interface

As shown in Figure 1-14, you can adjust the line thickness at the edge of the graph by calling out this interface. The larger the value is, the thicker the line will be.

- **Save/Recall**

Click the save menu button to save the current graffiti content as a file with *.GFT as the file extension.

5.7 Touch Screen

The vector network analyzer is equipped with a 12.1-inch high-resolution color touch LCD screen for trace, function keys, and other measurement-related information. With the help of the touch screen, the LCD screen can be directly touched by a finger to select measurement and parameter setting operations.

- ◆ When the **Touch** button display light is on, the touch screen function is on.
- ◆ When the **Touch** button display light is off, the touch screen function is off.
- ◆ Sliding the screen up and down to display the coordinates of the vertical axis can continuously change the parameters of the vertical axis.

5.8 Help Information

The Help system of the vector network analyzer can provide the Help information of the function keys and menu options on the front panel. Press the Help button on the front panel to enter the **Utility** menu, click **Help** to open the **Help** document, click into the corresponding directory to view the information.

6 Set Up a Measurement

This chapter introduces in detail each function button on the front panel of SNA5000A series vector network analyzers and the following menu functions.

6.1 Measurement parameters

6.1.1 S parameters

S parameters are used to describe the degree of a transmitted or reflected signal through an impedance discontinuity. S parameters are relative measurements, defined as the ratio of two complex voltages. They contain the amplitude and phase information of the relevant signals. For the 2-port vector network analyzer, there are 4 S parameters (S11, S21, S12, S22).

The specific meaning of each S parameter can be described by the following items:

S_{xy} $x,y \in (1,2)$:

- x: The response port is also known as the receiving port of the vector network analyzer. The transmitted signal enters the port after passing through the DUT.
- y: The excitation port is also known as the transmitting port of the vector network analyzer. The output signal of this port is provided to the DUT.

Here is a list of common Measurements with S-Parameters:

Reflection Measurements	Transmission Measurements
<ul style="list-style-type: none"> • Return loss • SWR • Reflection coefficient • Input impedance • S11, S22 	<ul style="list-style-type: none"> • Insertion loss • Transmission coefficient • Gain/ loss insertion • group delay • Linear phase shift • electrical delay • S21, S12

6.1.2 Balanced Measurement

6.1.2.1 Balanced Devices

Standard Single-ended devices generally have one input port and one output port. Signals on the input and output ports are referenced to ground. As Fig2.1 Balanced devices have two pins on either the input, the output, or both. The signal of interest is the difference and average of the two input or output lines, not referenced to ground, as Fig2.2.

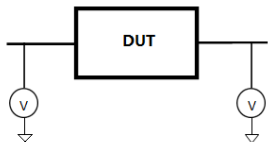

Fig 2-1 Single-ended devices

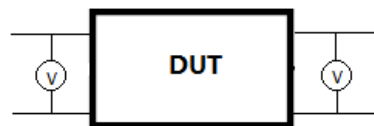

Fig 2-2 Balanced devices

Differential and Common Modes Model

On balanced devices, the signal of interest is the **difference** and **average** of the two input or output lines. In balanced device terminology, these signals are known as the Differential and Common modes.

- Signal A is fixed at 1V peak
- Signal B is selectable
- Differential is calculated as A minus B
- Common is calculated as the average of A and B

Input Signal A and B, A =1V, B=2V

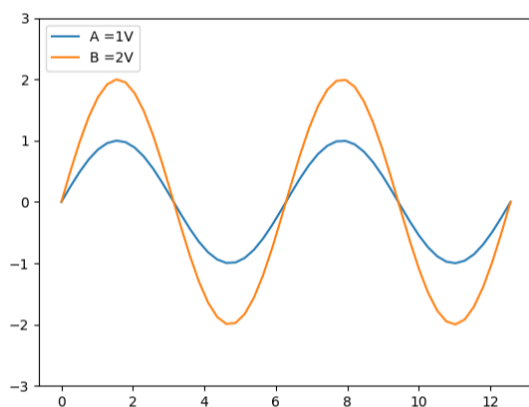

Differential=(A-B), Common=(A+B)/2

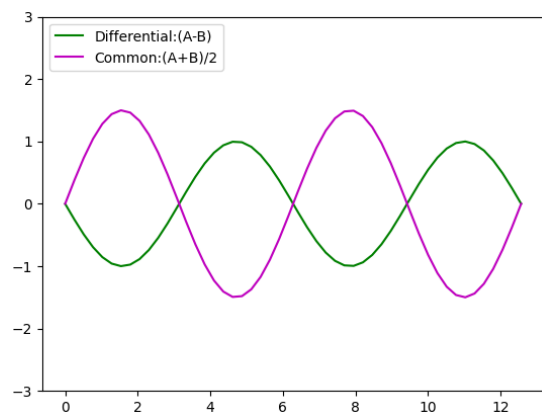

Input Signal A and B, A =1V, B= reverse phase 2V

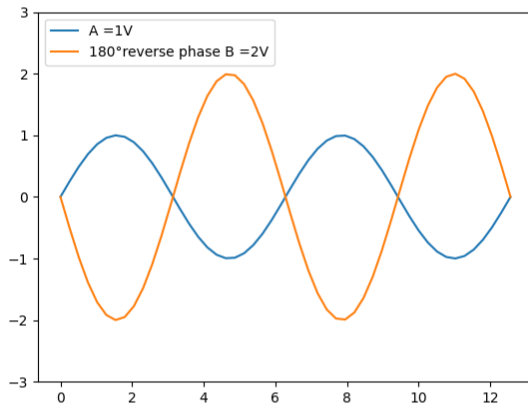

Differential=(A-B), Common=(A+B)/2

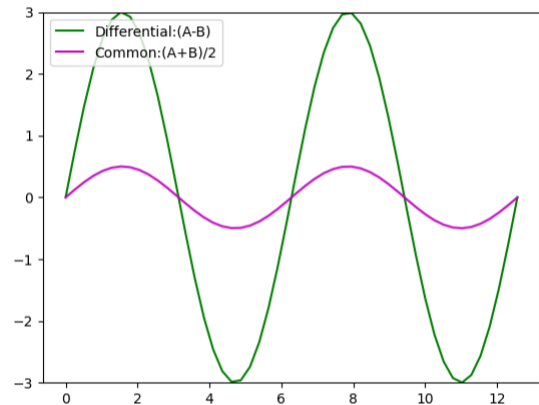

6.1.2.2 Measuring Mixed Mode(Balanced) S-Parameters

The mixed mode S parameter is an extension of the conventional S parameter for balance measurement. If the measuring device is a balanced device, its mixed mode parameters can be measured by the VNA. Some balanced devices are designed to amplify the differential component and reject the common component. This allows noise that is common to both inputs to be virtually eliminated from the output. For example, a balanced device may amplify the differential signal by a factor of 5, and attenuate the common signal by a factor of 5. Using traditional S-parameter notation, an S21 is a ratio measurement of the device **Output**/device **Input**. Mixing this with balanced terminology, we could view the amplifier's Differential Output signal/ Differential Input signal. To see this parameter on the analyzer, we would select an Sdd21 measurement using the following balanced notation:

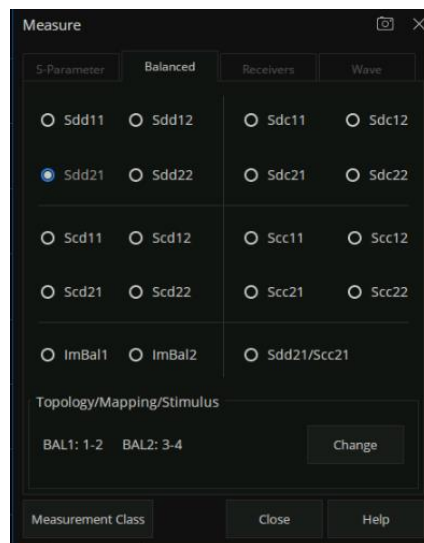

The general notation for the mixed S parameter is Sabxy, where:

- 1) a - Represents the output mode of the device
- 2) b - Represents the input mode of the device
 choose from the following for both a and b
 - s – single ended (unbalanced port)
 - d – differential (balanced port)
 - c – common (balanced port)
- 3) x – device output “logical” port number
- 4) y - device input “logical” port number

6.1.2.3 Measuring Imbalance Parameters

Imbalanc is a measure of how well two physical ports that make up a balanced port are matched. With a perfectly balanced port, the same amount of energy flows to both ports and the magnitude of the ratio of these ports is 1. The notation is similar to traditional S-parameters. In the following diagrams, the letters a, b, c, and d are used because any analyzer port can be assigned to any logical port using the port mapping process.

For example, in the following single-ended - balanced formula, Sba indicates the device output port is logical port b and the input port is logical port a.

- (1) Imbalance parameter when measuring a single -balanced device. $ImBal = -\frac{S_{ba}}{S_{ca}}$

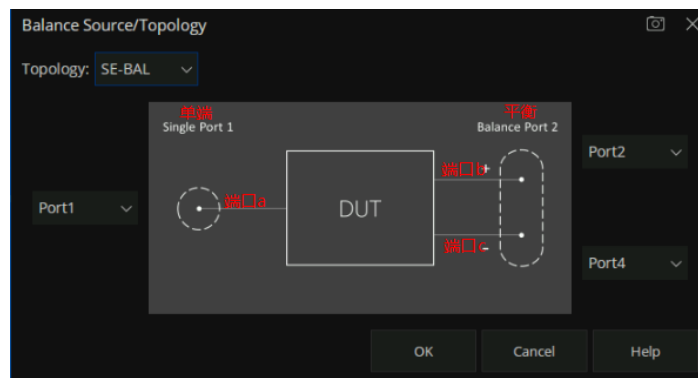
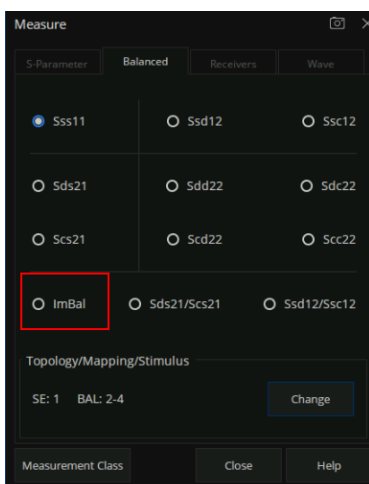

- (2) Imbalance parameter of ImBal1 and ImBal2 when measuring a balanced -balanced device.

$$\text{ImBal1} = -\frac{S_{ac}-S_{ad}}{S_{bc}-S_{bd}}, \text{ImBal2} = -\frac{S_{ca}-S_{cb}}{S_{da}-S_{db}}$$

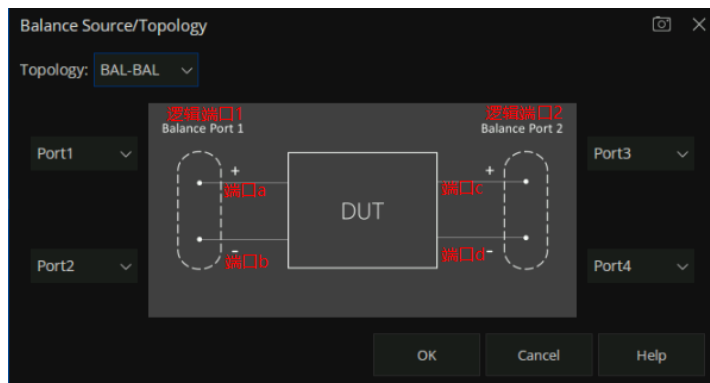
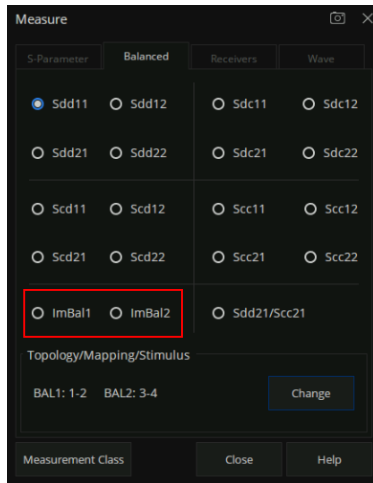

(3) Imbalance parameter of ImBal1 to ImBal4 when measuring a single- single -balanced device.

$$\text{ImBal1} = -\frac{S_{ac}-S_{ad}}{S_{bc}-S_{bd}}, \text{ImBal2} = -\frac{S_{ca}-S_{cb}}{S_{da}-S_{db}}, \text{ImBal3} = -\frac{S_{ca}}{S_{da}}, \text{ImBal4} = -\frac{S_{cb}}{S_{db}}$$

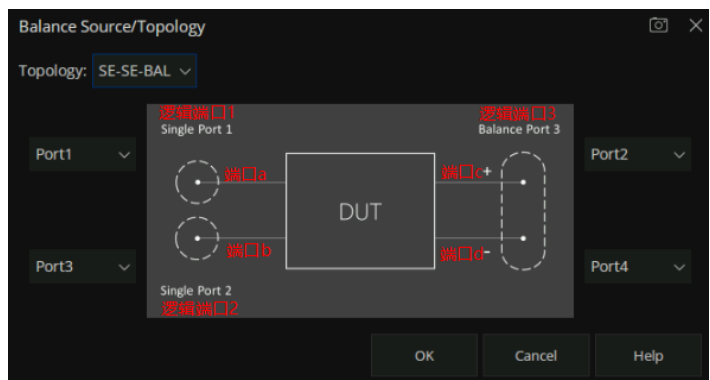
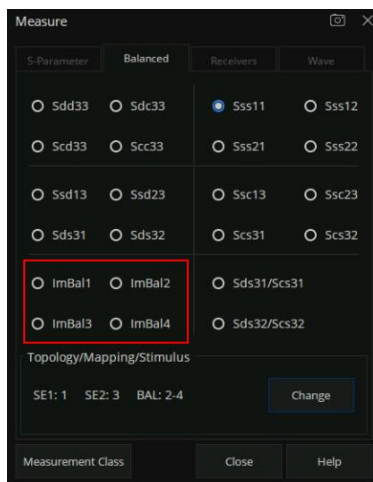

6.1.2.4 Measuring CMRR

CMRR is a ratio of the transmission characteristic in differential mode over the transmission characteristic in the common mode of the balanced port as the measurement parameter. A high value indicates more rejection of common mode, which is desirable in a device that transmits information in the differential portion of the signal. On the measurement balanced parameter TAB interface, click “Change” to set the DUT topology and port mapping relationship. Different DUT topologies lead to different CMRR parameters.

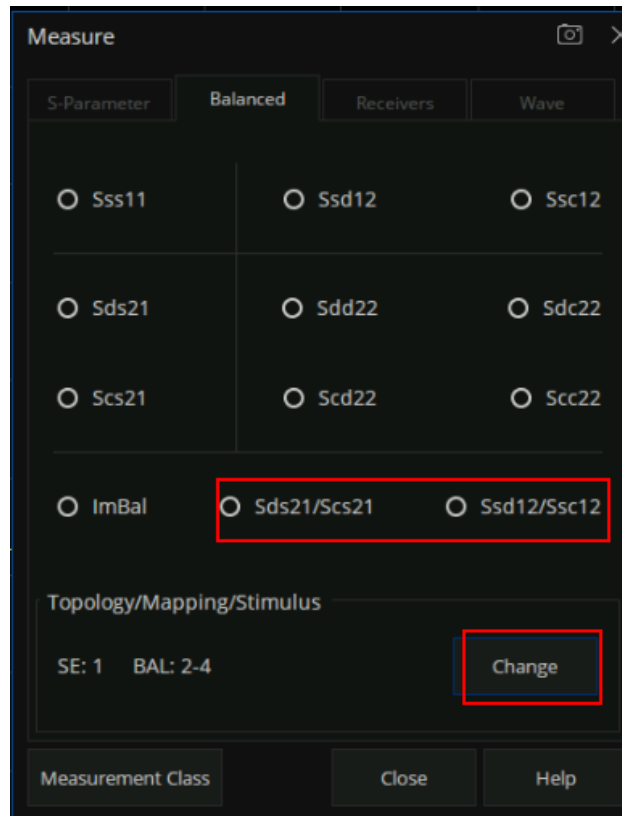

The table below shows the CMRR parameters available when measuring different balanced device.

balanced device.	CMRR parameters
Single- balanced device	Sds21/Scs21 , Ssd12/Scs12
Balanced - balanced device	Sdd21/Scs21
Single- single- balanced device	Sds31/Scs31 , Sds32/Scs32

6.1.2.5 DUT Topology Port Mapping

In the balanced measurement, the signal of interest is the difference or average of two BALANCED input or BALANCED output lines. It is also possible to have single-ended ports AND balanced ports on the same device.

Press the “Meas” button on the front panel → Balanced → Topology... , Create or edit DUT Topology and Logical Port Mapping. The port Topology / Logical port Mapping setting dialog box is as below:

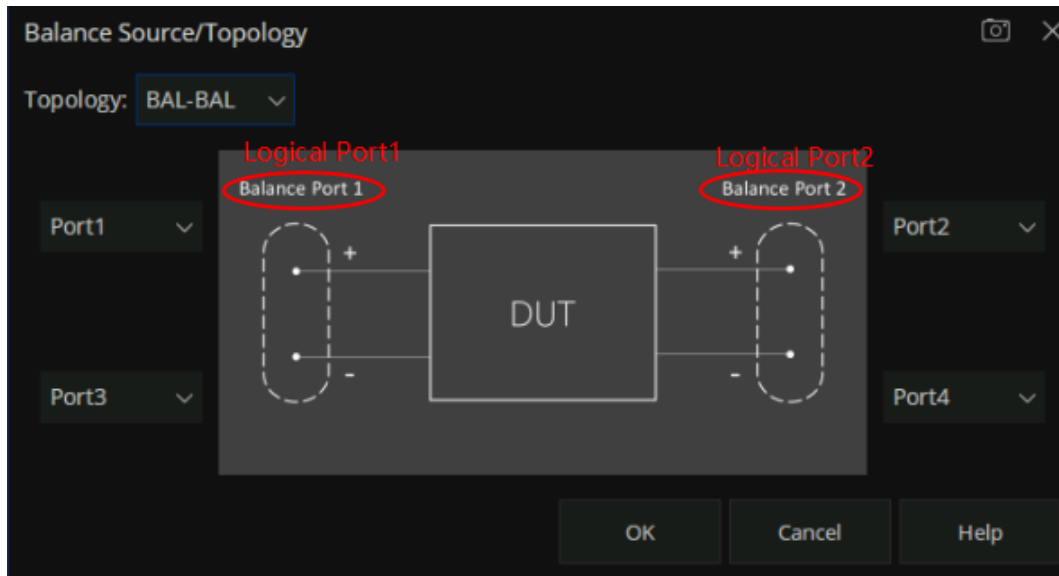

“Logical Port” is used to describe a physical analyzer test port that has been remapped to a new port number.

1. Map any two physical ports of the vector network analyzer to a balanced logical port.
2. Map any physical port of the vector network Analyzer to a single-ended logical port.

These selections apply to ALL measurements in the channel. If the device topology is changed, any existing measurements in the channel that are incompatible with the new topology will be automatically changed to one that is compatible.

The following are the topological relationships of several common differential devices. A multi-port vector network analyzer can be used to measure the following topological relationships for differential devices. When the vector network analyzer has only 2 test ports, then only the first balanced device under test can be tested. When the vector network analyzer has four test ports, then all the devices under test with the following four topological relationships can be tested.

1) **Balanced**

- 1 Logical port (Balance Port 1) - 2 physical ports (Port1, Port2)

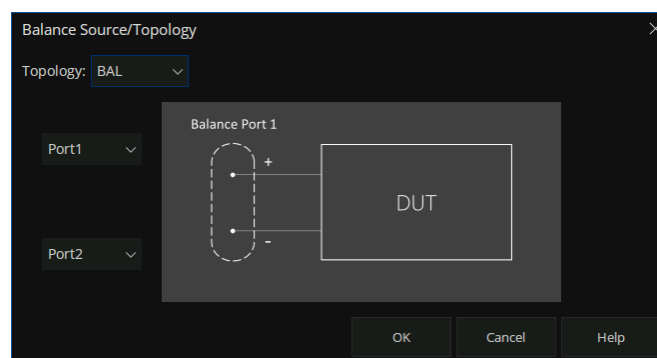

2) Balanced-Balanced

2 Logical port (Balance Port 1, Balance Port 2) - 4 physical ports (Port1, Port2, Port3, Port4)

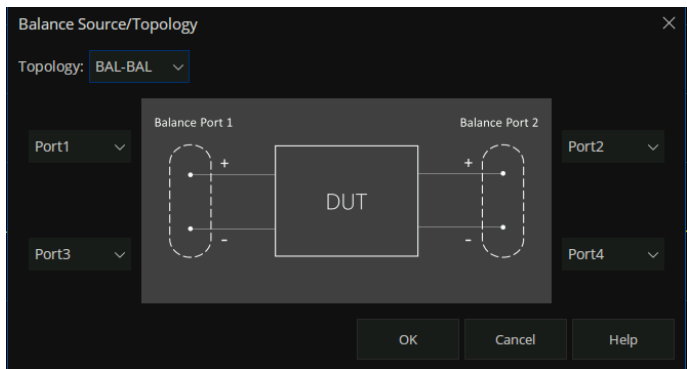

3) Single - Balanced

2 Logical port (Balance Port 1, Balance Port 2) - 3 physical ports (Port1, Port2, Port4)

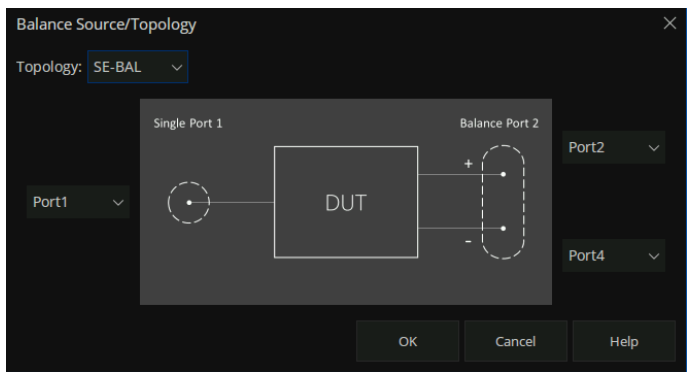

4) Single-Single-Balanced

3 Logical port (Balance Port 1, Balance Port 2) - 4 physical ports (Port1, Port2, Port4)

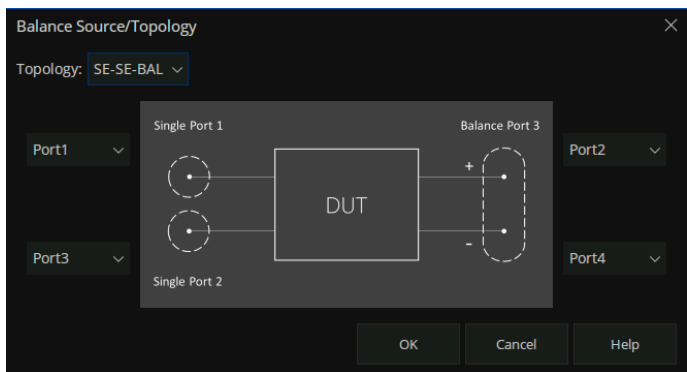

6.1.3 Receiver Measurement

Each port of the vector network analyzer contains 1 reference receiver and 1 measurement reference receiver. For the 4-port vector network analyzer, there are a total of 4 reference receivers and 4 measurement reference receivers. The power measured by these receivers can be compared to obtain all the S parameter indices.

R1, R2, R3, and R4 are the reference receivers used to measure the signal emitted from the vector network analyzer, It is equal to the transmitted power at the port after power calibration.

- R1: Measures the output power of port 1
- R2: Measures the output power of port 2
- R3: Measures the output power of port 3
- R4: Measures the output power of port 4

A, B, C, and D are test receivers used to measure the reflected or transmitted signal power after passing through the device under test.

- A: Measures the signal power entering port 1
- B: Measures the signal power entering port 2
- C: Measures the signal power entering port 3
- D: Measures the signal power entering port 4

6.1.4 Wave (Receivers notation)

Receivers can be also selected using logical receiver notation

Press the “Meas” button on the front panel → Wave → Other... to enter the Wave TAB interface.

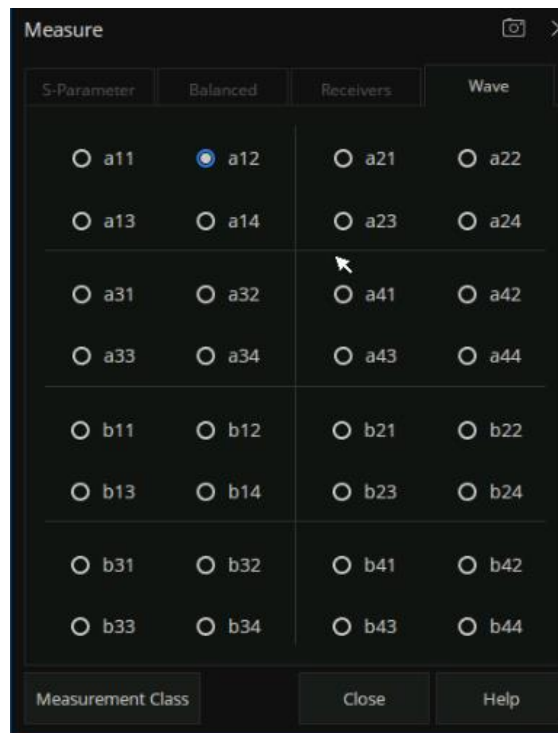

Logical receivers are generally represented by aN, M and bN, M forms.

- aN - Represents Reference receiver for logical port N
- bN - Represents the test port receiver for logical port N
- M – Represents the Physical port number of the output power

For example:

- 1) **a1,1** Represents Physical port 1 outputs power when the reference receiver of logical port 1 is measured. When logical port 1 is mapped to physical port 1, it is equivalent to R1,1;
- 2) **a2,1** Represents Physical port 1 outputs power when the reference receiver of logical port 2 is measured. When logical port 2 is mapped to physical port 2, it is equivalent to R1,2;
- 3) **b1,1** Represents Physical port 1 outputs power when the test port receiver of logical port 1 is measured. When logical port 1 is mapped to physical port 1, it is equivalent to A,1;
- 4) **b2,3** Represents Physical port 3 outputs power when the test port receiver of logical port 2 is measured. When logical port 2 is mapped to physical port 2, it is equivalent to B,3;

6.2 Frequency range

Frequency range is the span of frequencies you specify for making a device measurement.

6.2.1 Set the frequency range

Set the range of RF frequencies.

Operating steps:

Press **Freq** on the front panel to open the frequency setting interface, parameter change mode:

1. Use the numeric keypad to input the value of the frequency and press the unit button to select the desired unit. The optional units are GHz, MHz, KHz, and Hz. Press Enter to select the current unit by default.
2. Press **ENTER** or the multifunction knob to enter the state of parameter editing. Move the cursor to the specified position by the left and right arrow keys. Modify the value by pressing the up and down key, rotating the knob, or pressing the numeric keypad. Press **ENTER**, the knob, or **ESC** to exit the editing mode.

Note:

- Start: Specify the starting frequency of the swept measurement range
- Stop: Specify the end frequency of the swept measurement range
- Center: Specify a center frequency of the swept measurement range
- Span: Specify the swept measurement frequency range
- Step: Specifies the frequency step size between data points
- Points: Specify the number of measurement points per sweep

6.2.2 CW time sweep or power sweep

Measurements using a CW time sweep or power sweep will be performed on a single frequency rather than the entire frequency range

Operating steps:

Press **Sweep**, use the knob or arrow keys to focus on the **Sweep** → **Sweep type**. Parameter change mode:

1. Press **ENTER** or the knob to enter the parameter editing state and then move the cursor to the specified position by up and down arrow keys or the knob to set the **Sweep type** to **CW Time** or **Power Sweep**. Press **ENTER** or the knob to select the current option.
2. Press **Freq** , use the knob or arrow keys to focus on the **Freq** → **CW** parameter entry. Select the edit box to enter the edit mode and change the value by pressing the up and down key, rotating the knob, or pressing the numeric keypad. Press **ENTER**, the knob, or **ESC** to exit editing mode.

6.2.3 Frequency resolution

Set the frequency resolution to 1Hz.

6.3 Power level

Power level refers to the output power at the port of the vector network analyzer.

Here are the keys to operation:

1. Press **Power** , use the knob or arrow keys to focus on the **Power** → **Power Level** parameter item. Input the required power level. Press **ENTER** to exit editing mode. The default unit is dBm.
2. Press **Power** , use the knob or arrow keys to focus on the **Power** → **RF Power** parameter item. Turn on or off RF power.
3. Press **Power** , use the knob or arrow keys to focus on the **Port Power** parameter item, Configure start and stop power. Start and stop power are only available in power sweep mode.
4. Press **Power** , use the knob or arrow keys to focus on the **Port Power** → **Select** parameter item, Press **ENTER** or the knob to select the corresponding power port.
5. Press **Power** , use the knob or arrow keys to focus on the **Port Power** → **Coupling** parameter item, Press **ENTER** or the knob to choose to turn coupling off or on.
6. Press **Power** , use the knob or arrow keys to focus on the **Leveling & Offsets** → **Slope Enable** parameter item, Press **ENTER** or the Knob to turn on the Slope switch, Press **Leveling & Offsets** → **Slope** to set the Slope.

Coupled port power:

- Coupling (selected):
The power level of each test port is the same. If the power of any test port is set, the power of all test ports will change accordingly.
- Decoupling (clearing):
Set the power level for each test port separately and decouple the Power. For example, if you want to measure the gain and reverse isolation of a high gain amplifier, the input port of the amplifier requires much less power than the output port. Power sweep can also be performed using uncoupled power

Power Leveling&Offsets

Power Limits controls the source power at each test port for ALL channels. Use this feature to protect DUTs that are sensitive to overpowering at the input. Source Power levels that exceed the Limit at the specified port are clipped at the limit, and an error message is displayed on the screen.

Power Offset provides a method of compensating port power for added attenuation or amplification in the source path. The result is that power at the specified port, all dialogs, and annotations reflect the added components. For amplification use a positive offset, and for attenuation use a negative offset.

Using the Softkey for setting: Press the “ Power ” key, “ Power ” > Leveling & Offsets then enter the menu.

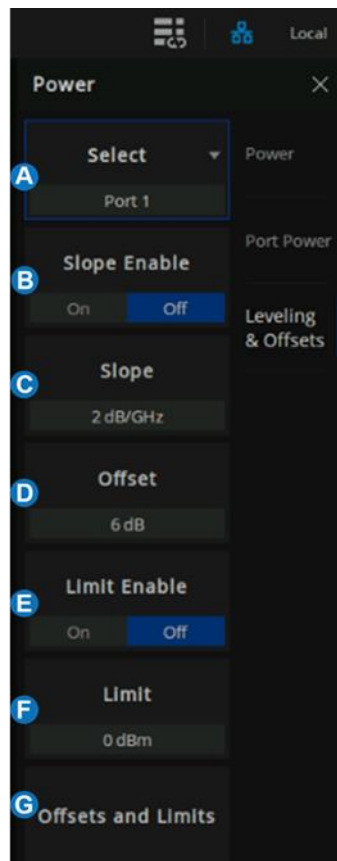

- A. Select the Port.
- B. Slope Enable. Helps compensate for cable and test fixture power losses at increased frequency. With power slope enabled, the port output power increases (positive input) or decreases (negative input) with the sweep frequency.
- C. Set the slope value
- D. Set the power offset value
- E. Power Limit Enable
- F. Set the power limit value
- G. Power Offsets and limits

Power Offsets and Limits setting

Using the Softkey for setting: Press the “Power” key, “Power” > Leveling & Offsets > Offsets and Limits to enter the menu. You can change the cell value in one of the following two ways:

1. On the UI interface, click the cell twice in succession and then enter the value in the pop-up virtual numeric keyboard.
2. Press the Tab key on the front panel to make the focus fall on the cell you want to change, press the number key +Enter on the front panel to set the value, or turn the knob to change the value.



- A. Global Power Limit. This sets a maximum source power level for individual test ports. This value limits port power for all channels and all applications. Power levels that attempt to exceed the power limit are clipped at the limit.
- B. Power Limit Enable. Selects On indicate that power is limited to the adjacent value at the specified source port and selects Off indicate that power is not limited to this value, but the maximum power of the source.
- C. Set the Source Power value.
- D. Set the Power Offset value.
- E. Set the Port Power value. The formula among Source Power, Power Offset, and Port Power is: $\text{Source Power} + \text{Power Offset} = \text{Port Power}$

6.4 Sweep

Sweeping refers to the measurement of a series of consecutive data points against a series of specified excitation values.

6.4.1 Points

Data points are the number of data samples representing the measured values at a single excitation value. You can specify the number of data points that the vector network analyzer measures in a sweep. The sweeping time of the vector network analyzer varies proportionally with the number of points.

Operating steps:

Press **Sweep** , use the knob or arrow keys to focus on the **Sweep** → **Number of Points** parameter item, Enter the number of points required, Press **ENTER** to exit editing mode.

The number of data points collected by the vector network analyzer during the measurement sweep can be set to any number between 1 and 100001.

Note: Maximum point limits may differ for some measurement classes.

- For maximum trace resolution , use the maximum data points.
- For faster throughput , use a minimum number of data points to provide an acceptable resolution.
- To get the best number of points , look for values that do not differ significantly in the measurement as you add points.
- To ensure accurate measurement calibration , ensure that the user uses the same number of points for calibration and measurement.
- Points are the number of data items collected in one sweep. This number can be set separately for each channel.
- To obtain high trace resolution for excitation values , select a larger point value.
- For high throughput , keep the smaller point value within the allowable trace resolution range.
- For high measurement accuracy after calibration , use the same number of points as the actual measurement.

6.4.2 Sweep type

Key operation:

Press **Sweep**, use the knob or arrow keys to focus on the **Sweep** → **Sweep Type** parameter item. Press **ENTER** or Knob to enter the editing state, then move the cursor to the specified position by up and down direction keys or Knob, set the sweep type to the required measurement type, press **ENTER** or Knob to select the current option.

Sweep type:

- Linear Frequency
- Log Frequency
- Power Sweep
- CW Time
- Segment Sweep

Linear Frequency: Set the measured abscissa frequency scale as a linear scale, and keep the full frequency scale at equal intervals.

Log Frequency: Set the measured abscissa frequency scale to log scale, To observe a wider frequency range, the calibration interval in the full frequency band is not uniform and presents periodic changes.

Power Sweep: The power sweep will increase or decrease the power of the source according to the walk length. Power sweeping is used to characterize power-sensitive circuits through measurements such as gain compression. In the Sweep Type dialog box, you can specify “ Start Power”, “ Stop Power”, “CW Frequency”, “Points”.

Segment Sweep: “Segment Sweep” activates a sweep consisting of frequency sub sweep (called segmentation). For each segment, you can define a separate power level, IF bandwidth, IF bandwidth for each port, sweep time, delay, sweep mode. After the measurement calibration has been performed on the entire sweep or all segments, the measurement values of one or more segments can be calibrated.

In the Segment Sweep type, the vector network analyzer performs the following operations.

- Sort all defined segments in order of increasing frequency.
- Measurements were made at each point.

- Display a trace containing all retrieved data.

Limitations on segmented sweeping:

- The frequency range of one segment may not overlap with the frequency range of any other segment.
- The number of segments is limited only by the combined data points of all segments in the sweep.
- The frequency range of one segment may not overlap with the frequency range of any other segment.
- The number of segments is limited only by the combined data points of all segments in the sweep.

Operating steps:

Press **Sweep**, Use the knob or arrow keys to focus on the **Sweep** → **Sweep Type** parameter item.

Parameter change mode:

1. Press **ENTER** or Knob to enter the state of parameter editing, then move the cursor to the specified position by up and down arrow keys or Knob, set the sweep type as **Segment Sweep**, and press **ENTER** or Knob to select the current option.
2. Press **Sweep**, use the knob or arrow keys to focus on the **Segment Table** parameter item. Move the cursor to the specified position by up and down arrow keys or knobs, set Add Segment, Insert Segment, Delete Segment and Delete All Segments to perform segment operation. Select the segment table for segment setting and tick the corresponding menu to display the corresponding contents in the following segment.

+	State	Start	Stop	Points	Power Level	Sweep Time	Delay	IF Bandwidth
1	On	9.000 kHz	1.000000000 GHz	201	0 dBm	182.30700 ms	0.00000 s	1.000 kHz
> 2	Off	1.000000000 GHz	4.500000000 GHz	801	5 dBm	71.08475 s	0.00000 s	10 Hz

Figure 6-1 Segment table

X-Axis Point Spacing: In segment sweep mode, this feature will affect how the segment trace is drawn on the screen. This function is in the sub-sweep table menu.

- When X-axis point spacing is not used, multi-segment sweeping traces may sometimes result in many measurement points being squeezed into a narrower portion of the X-axis

- When X-axis point spacing is used, the X-axis position of each point needs to be selected so that all measurement points are evenly distributed along the X-axis.

For example, suppose you have the following two sections:

	+	State	Start	Stop	Points
>	1	On	870.000000 MHz	970.000000 MHz	201
	2	On	970.000000 MHz	1.07000000 GHz	801

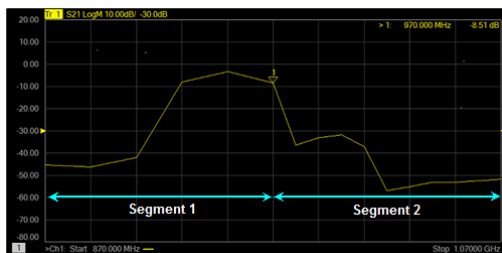

Figure 6-2 X-point spacing is not used

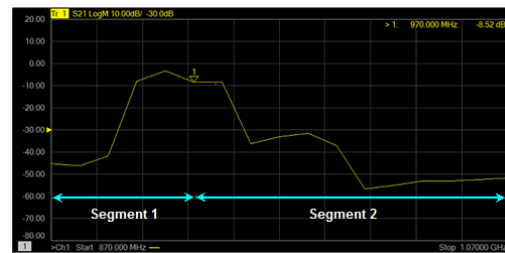

Figure 6-3 Use X-axis point spacing

6.5 Trigger

The trigger is the signal that causes the vector network analyzer to carry out the measurement sweep. The vector network analyzer is flexible in the configuration of the trigger function.

6.5.1 Trigger Settings

Operating steps:

Press **Trigger**, use the knob or arrow keys to focus on the **Trigger** parameter item.

6.5.2 Trigger source

Operating steps:

Press **Trigger**, Use the knob or arrow keys to focus on the **Trigger Source** parameter item. Press **ENTER** or the Knob to enter the parameter editing state, then move the cursor to the specified position by the up and down arrow keys or the knob, and press **ENTER** or the knob to select the current option.

Trigger source:

These Settings determine the source of the trigger signal for all existing channels. A valid trigger is generated only if the vector network analyzer is not sweeping.

- Internal triggers: After the previous measurement is completed, the vector network analyzer will immediately send a continuous trigger signal.
- Bus trigger: The vector network analyzer waits for the SCPI trigger instructions issued by an external controller (PC).
- External trigger: Trigger signals generated by external devices received through the BNC Connector on the rear panel.
- Manual trigger: Manually send a trigger signal to the vector network analyzer. Available Only when you select "Manual" to trigger.

6.5.3 Trigger Range

Operating steps:

Press **Trigger**, Use the knob or arrow keys to focus on the **Trigger Scope** parameter item. Press **ENTER** or the Knob to enter the parameter editing state, then move the cursor to the specified position by the up and down arrow keys or the knob, and press **ENTER** or the knob to select the current option.

- All channels:

Triggers are sent to all triggerable channels. A trigger will sweep all channels that can be triggered. (Default setting)

- Current channel:

Triggers are sent to the current channel but after the current channel completes, the channel increments to the next triggerable channel.

6.5.4 Channel Settings

Operating steps:

Press **Trigger**, use the knob or arrow keys to focus on the **Trigger** parameter item. Press **ENTER** or the Knob to enter the parameter editing state, then move the cursor to the specified position by the up and down arrow keys or the knob, and press **ENTER** or the knob to select the current option.

These settings determine the number of trigger signals that the channel will receive.

- Hold trigger: The channel does not accept any trigger signals.

- Single trigger:

The channel receives a trigger signal and then enters the “hold” state. Another way to trigger a single measurement: Set the trigger source to “manual” and send a manual trigger. At this point, however, all channels are set to single trigger.

- Continuous trigger: Channels accept an unlimited number of trigger signals.
- Hold all channels: All channels enter the hold state and do not accept any trigger signals.
- Restart:

(Accessible only from the Trigger menu.) Channels that are in the Hold state are set to be triggered once (The channel accepts a single trigger signal). All other Settings are unaffected.

- A single trigger:

The channel receives a trigger signal and then enters the “hold” state. Another way to trigger a single measurement is to set the trigger source to “manual” and send a manual trigger. At this point, however, all channels are single.

- Restart:

(Accessible only from the Trigger menu.) Channels that are in the “Hold” state are set to be a single trigger (This channel receives a single trigger signal). All other settings are unaffected.

6.5.5 Trigger mode

Operating steps:

Press **Trigger**, use the knob or arrow keys to focus on the **Trigger** → **Trigger Setup** parameter item. Press **ENTER** or the Knob to enter the parameter editing state. Then move the cursor to the specified position by the up and down arrow keys or the knob, and press **ENTER** or the knob to select the current option.

These settings determine the number of trigger signals that the channel will receive.

- Sweep trigger:

Each “manual” or “external” trigger causes all traces of the shared source port to be swept in the order specified below. In the case of a “single” trigger, the count decrements by 1 after sweeping all traces in all directions.

- Point trigger:

Each “manual” or “external” trigger results in a measurement of a data point. Subsequent triggers go to the same trace until it completes, The other traces in the same channel are then swept in the order specified below. If it is a "single" trigger, the count decreases by 1 after measuring all data points on all trace lines in the channel.

When multi-port calibration is on (requires multi-direction sweeping), the trace on the screen will not be updated until all relevant directions have been swept. For example, when all four 2-port S parameters are displayed:

- a) If full 2-port calibration is on, triggering 1 will cause no trace to be updated.
- b) When the calibration is off, triggering 1 will cause S11 and S21 updates. Trigger 2 will cause updates to S22 and S12.

Trace sweep order:

For all trigger modes, the trigger signal remains in the same channel until all traces in this channel have been swept, and then continue to trigger the next channel that is not in the "hold" state.

The traces within each channel are always swept in the following order:

The trace on the screen will not be updated when the multi-port calibration is turned on (requiring multi-direction sweeping) until all relevant directions have been swept.

For example, when all four 2-port S parameters are displayed:

- a) If full 2-port calibration is on, triggering 1 will cause no trace to be updated; Triggering 2 causes all S parameters to be updated.
- b) When the calibration is off, triggering 1 will cause S11 and S21 to be updated; Triggering 2 will cause S22 and S12 to be updated.

6.5.6 External and auxiliary triggers

Both external and auxiliary triggers are used to synchronize the triggers of the vector network analyzer with those of other devices.

Overview:

Ready signal and trigger signal:

Ready signals are different from trigger signals. The ready signal is used to indicate that the transmitting instrument is ready for measurement. The instrument receiving the ready signal then sends a trigger signal indicating that the measurement will be made or that the measurement has been completed. Usually, the slower instrument sends the trigger signal.

- Measurement trigger input: This signal is easy to use, but has limited configuration capabilities.
- Auxiliary trigger outputs: Connectors and signals are highly configurable and can be used to synchronize with any number of devices.

Measurement trigger input

The trigger input connector is located on the back panel of the vector network analyzer. These signals can be used when the vector network analyzer communicates with slower instruments.

Operating Steps:

- The vector network analyzer sends a “ready” signal when it is ready for measurement
- The external device sends a trigger signal to the vector network analyzer when it is ready for measurement
- Additional signals are provided on the vector network analyzer processor I/O to indicate that the vector network analyzer sweep has been completed and the processor can be set for the next measurement.

To make the vector network analyzer respond to measured trigger inputs or processor I/O signals, select External on the “Trigger Settings” tab on the “Source” Settings. Also, on the Trigger Settings tab, on the Range Settings, select whether an external trigger applies to all channels (global) or one channel (local). The appropriate settings to apply are as follows:

Main trigger input:

Global/ channel trigger delay - after receiving an external trigger, the start time of the sweep will be delayed by the specified amount of time plus any inherent delay.

- When the trigger scope is “channel” , the delay value is applied to the specified channel.
- When the Trigger Range is Global, the same delay value is applied to all channels.

The vector network analyzer receives the trigger input signal through the following connectors:

- Measure trigger input BNC connector: Trigger input on the rear panel.
- Processor I/O Pin 18 (needs to be changed).

Polarity:

High level: When the vector network analyzer is ready (trigger ready) and the TTL signal on the selected input is “high”, It triggers the vector network analyzer.

Low level: When the vector network analyzer is ready (trigger ready) and the TTL signal on the selected input is “low”, it triggers the vector network analyzer.

Positive edge: When the vector network analyzer is ready, it will trigger on the next positive edge. When set to accept a trigger before ready, if a positive edge has been received since the last data acquisition, the vector network analyzer will trigger immediately after ready

Negative edge: When the vector network analyzer is ready, it will trigger on the next negative edge. When set to accept the trigger before ready, if a negative edge has been received since the last data acquisition, the vector network analyzer will trigger immediately after ready.

After receiving the trigger selection before being ready, the vector network analyzer will move to the ready state (trigger ready), if any triggers have been received since the last data fetch, the vector network analyzer will trigger immediately and the vector network analyzer will remember only one trigger signal. All other signals will be ignored.

- If this check box is cleared, any trigger signals received by the vector network analyzer before it is ready will be ignored.
- This feature is only available when a positive or negative edge trigger is selected.

Auxiliary trigger

The auxiliary trigger connector is located on the back panel of the vector network analyzer. When the external source is configured as an external device, the vector network analyzer will automatically control all trigger settings. Do not set other trigger settings. The vector network analyzer will start measuring when it receives a valid trigger signal from the specified trigger source:

- Inside: Measurements begin immediately.
- Manual: Press the vector network analyzer “Trigger” button to start the measurement.
- External: The measurement starts when the measurement trigger input signal is received from the external device. This must be configured separately.

The “Auxiliary Trigger Output” signal can be configured to be sent just before the measurement is performed or just after the measurement is completed. When communicating with an external source, the “Auxiliary Trigger Output” signal should be sent after the measurement is completed to indicate that the external source can be set for the next measurement.

Enable: When checked, the signal can be output to external devices using auxiliary connectors.

- Channel: This setting is controlled by the vector network analyzer “Preferences” setting.
- Global: All secondary trigger settings apply to all channels. On the Trigger Settings tab, set the “Each Point” setting, which also applies to all channels.

Channels: All secondary trigger settings will be applied to the specified channel and each channel can be configured individually.

Auxiliary channel output (to device):

The following settings control the properties of the signal emitted from the “Auxiliary Trigger Output ” connector on the back panel:

Polarity:

Positive pulse: the output pulse is positive.

Negative pulse: The output pulse is negative.

Location:

Before acquisition: Send pulses just before data collection begins.

After the acquisition: Pulses are sent immediately after data collection is completed.

Each point: When checked, trigger output can be sent for each data point, and when cleared, trigger output can be sent for each sweep.

Select “Auxiliary Trigger” - “Global” vector network analyzer preferences, On the “Trigger Settings” tab, the “Dot” Settings are set. After that, this setting applies to all channels. When multiple channels exist, the channel settings set last are used.

Pulse Duration: Specify the duration of a positive or negative output trigger pulse.

6.6 Data format

The data format is the method by which the vector network analyzer displays the measured data graphically. Select the data format that corresponds to the information you want to know about the test device.

6.6.1 Display format

Operating steps:

Press **Format**, Use the knob or arrow keys to focus on the **Format** parameter item. Press **ENTER** or the Knob to enter the parameter editing state, then move the cursor to the specified position by the up and down arrow keys or the knob, and press **ENTER** or the knob to select the current option.

6.6.2 LF Cartesian coordinates display format

Nine of the twelve available data formats use rectangular displays to present measurement data. This display is also known as Cartesian, XY, or linear coordinates. The Cartesian coordinate display is especially suitable for clearly displaying the frequency response information of the device-under-test (DUT).

- The excitation data (frequency, power, or time) is linearly scaled and displayed on the X-axis
- The measured response data is displayed on the Y-axis

Log amplitude scheme:

- Display amplitude (no phase)
- Y: dB
- Typical measurements: Return loss, insertion loss, or gain
- Display phase (no amplitude)

Phase format:

The phase of the signal is measured relative to the calibration reference plane, within a range of ± 180 degrees.

- Y: Phase (degrees)

- Each 180-degree trace is “wrapped” for easy scaling
- Typical measurement: Linear phase shift.

A phase:

- Same phase, but no 180-degree entanglement.

Note: Phase unwrapping is accomplished by comparing the phases of two adjacent data points. If the phase difference between the two points is greater than 180 degrees, or the DC offset phase of the first data point is greater than 180 degrees, then the phase measurement may not be accurate.

Group delay format:

- Displays the transmission (propagation) time of signal in the device
- Y: Time (s)
- Typical measurement: Group delay

Linear amplitude scheme:

- Only positive values are displayed
- Y: No Unit (U, suitable for proportional measurements)
Watts (W, suitable for disproportionate measurements)
- Typical measurements:
Reflection and transmission coefficients (amplitude), time domain transformation

SWR format:

- Displays the reflection measurements calculated from the formula $(1 + R) / (1 - R)$, where R is the reflection coefficient
- Valid for reflection measurements only
- Y: No units
- Typical measurements: SWR

Real number format:

- Show only the real part of the measured complex data
- Can display both positive and negative values
- Y: No units
- Typical measurements: Time domain, auxiliary input voltage signals for maintenance purposes

Imaginary number format:

- Only imaginary parts of the measured data are displayed
- Y: No units
- Typical measurement: Network impedance matching

6.6.3 Polar coordinates

The polar coordinate format is used to view the amplitude and phase of the reflection coefficients in S11 or S22 measurements.

You can use a cursor to display the following items:

- Linear or log amplitude (in dB)
- Phase (in degrees)

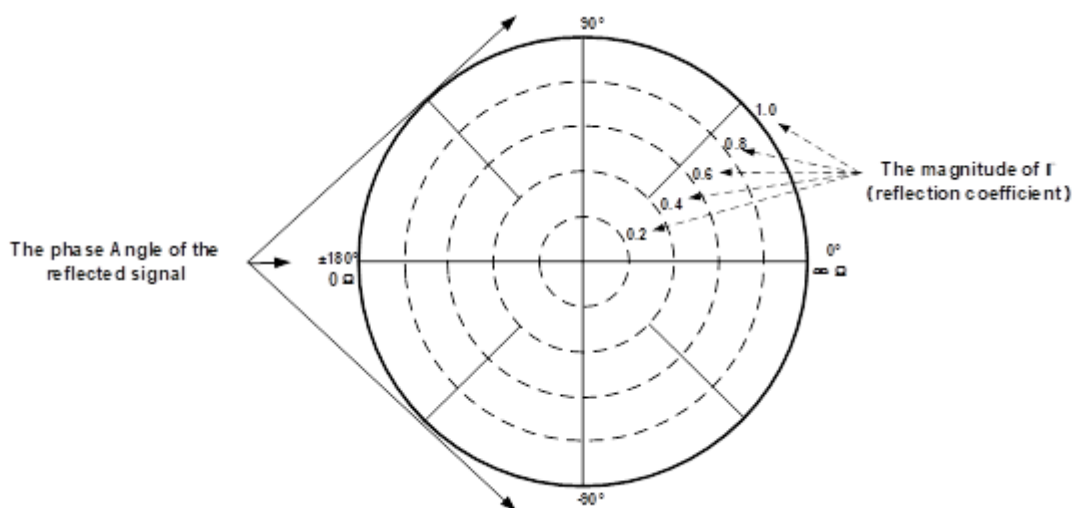

Figure 6-4 Polar diagram

- The dotted circle indicates the reflection coefficient. The outermost circle represents the

reflection coefficient with a value of 1. The center of the circle represents the reflection coefficient with a value of 0.

- The radial line shows the phase angle of the reflected signal. The right-most position corresponds to the zero-phase angle (that is, the reflected signal has the same phase as the incident signal). The phase differences of 90° , $\pm 180^\circ$, and -90° correspond to the top, leftmost, and bottom of the polar display, respectively.

6.6.4 Smith circle diagram

Smith diagrams are a tool for mapping complex reflectance coefficients to test the impedance of equipment. In the Smith chart, the linear impedance plane is reshaped to form a cyclic grid from which the resistance and reactance ($R + jX$) can be read.

You can use a cursor to display the following items:

- Resistance (in Ohms)
- Reactance as equivalent capacitance (in Ephraeras) or inductance (in Henrys)

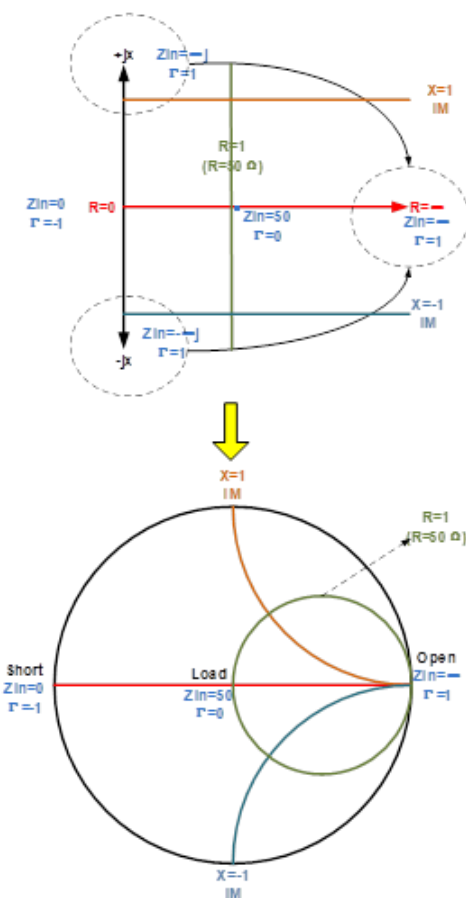

Figure 6-5 Schematic diagram of Smith circle

There is also a Reverse Smith circle diagram (also called an Admittance Smith Chart):

Same as the standard Smith circle, with the following exceptions:

- The polar grid is reversed from right to left.
- Admittance (in Siemens) instead of resistance.

Smith diagram interpretation:

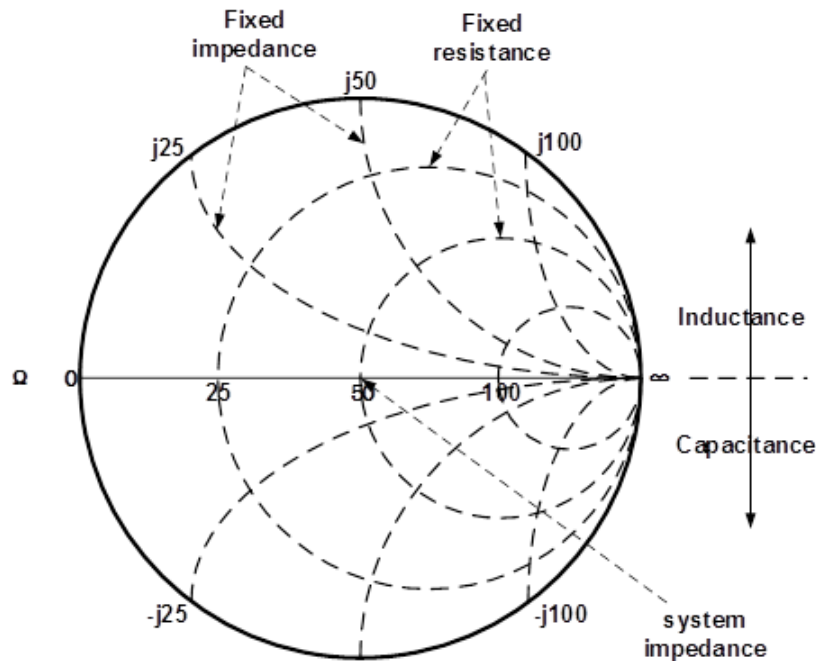

Figure 6-6 Schematic diagram of the Admittance Smith chart

- Each point on the Smith chart represents a complex impedance ($r \pm jx$) consisting of a real resistance (r) and an imaginary reactance (x).
- The horizontal axis (solid line) shows the real part of the difference between impedance and resistance. The horizontal axis always represents the system impedance. The rightmost value is infinite ohms (open path). The leftmost value is zero ohms (short circuit).
- The dotted circle intersecting the horizontal axis represents a constant reactance.
- A dashed arc tangent to the horizontal axis represents a constant impedance.
- The top half of Smith's circle is the region where the reactance component is positive and hence inductance is generated.
- The lower half is the region where the reactance component is negative and therefore generates capacitance.

6.7 Scale

6.7.1 Scale/reference level and position

The “Scale”, “Reference Level”, and “Reference Position” Settings (as well as the format) determine how the data trace will appear on the vector network analyzer screen.

Operating steps:

Press **Scale**, Use the knob or arrow keys to focus on the reference level and reference position parameter items under the **Scale** menu bar. Press **ENTER** or the knob to enter the parameter editing state, then move the cursor to the specified position by the up and down arrow keys or the knob, and press **ENTER** or the knob to select the current option.

Scale:

Sets the vertical indexing value of the rectangular coordinate display format. In polar coordinates and Smith chart formats, the scale sets the value of the outer perimeter. Range: 0.001 dB/div to 1000 dB/div. Scale do not apply in logarithmic scale type.

Automatic scaling:

Automatically sets the vertical indexing value and reference value to fit the working data trace in the screen grid area. The excitation value and reference position are not affected. The vector network analyzer determines the minimum possible scaling factor that will allow all display data to appear on the 80% vertical grid. The selected reference values center the trace on the screen.

All autoscaling:

Automatically scales all data traces in the working window to fit vertically into the grid area of the screen.

Reference level:

Sets the value of the guide in rectangular format. Range: -1000 dB to 1000 dB. In polar coordinates and Smith's circle chart formats, and logarithmic scale type, the reference level does not apply.

Reference position:

Sets the position of the guide in Rectangular coordinate format. Zero is the bottom line and 10 is the top line. The default position is 5 (middle of the screen). Reference positions do not apply in polar coordinates, Smith chart formats and logarithmic scale type.

6.7.2 Scaling coupling

When “Scale Coupling” is enabled, tracks of the same format will have the same “Scale”, “Reference Level”, and “Reference Position”. You can choose to couple the scales for traces in the same window, for all traces in all Windows, or uncouple them.

Operating steps:

Press **Scale**, use the knob or arrow keys to focus on the **Scale** → **Scale Coupling** parameter item. Press **ENTER** or Knob to enter the editing state, select **Off / Window / All**, then move the cursor to the specified position by up and down arrow keys or Knob, press **ENTER** or Knob to select the current option

Note: Traces of the same format have the same scale, reference level, and reference position.

Coupling Method:

Close: No coupling. Each trace is scaled individually. This is the default setting.

Window: All traces of the same format in each selected window share the same scale settings

All: Coupled between all selected windows, all traces of the same format in all selected windows share the same scale settings.

- When window or full coupling is enabled, the scale settings for the working trace will be adopted by other coupling traces of the same format
- If traces of a different format exist, all traces of that format will be set as the least numbered trace in that format
- Once enabled, the scale settings for all coupling traces of the same format can be changed with any coupling trace in the working state

Selected Windows:

Available when selecting a window or all methods. The selected window participates in scaling coupling. By default, all windows are selected. Cancel the check box to disable zoom coupling for this window.

About “Auto Scaling” and “Scaling Coupling”:

Automatic scaling using the coupling method affects the work trace in the work window. All traces coupled to this trace will be set with the new scale of the working trace. This will cause some traces to not appear on the screen.

Full automatic scaling using the coupled method

- Close: All traces in the working window are automatically scaled separately.
- Window: All traces in each selected window are automatically scaled to conform to a common set of scaling factors.
- All: All traces in all selected Windows are automatically scaled to conform to a common set of scaling factors.

6.7.3 Electrical delay

Electrical delay is a mathematical function that simulates the variable length of a lossless transmission line. Linear phase shifts through the device can be compensated using the electrical delay function. Use this feature to determine only the linear phase deviation of the device. Electrical delay can be set separately for each measuring trace.

Operating steps:

Press **Scale**, use the knob or arrow key to bring focus to the **Electrical Delay** parameter item. Press **ENTER** or Knob to enter the editing state. After the editing is completed, move the cursor to the specified position by up and down direction keys or Knob. Press **ENTER** or Knob to select the current option.

Delay time: Specifies the value of the delay added or removed, expressed in time or distance. This compensates for the linear phase shift through the device. Electrical delay can be set separately for each measuring trace.

Speed coefficient: Specify the velocity factor applied to the device media inserted after measurement calibration. The value is 0.66 for polyethylene insulated cables and 0.7 for PTFE insulators. 1 corresponds to the speed of light in a vacuum.

Distance unit: Select meters, inches, or feet. When you change this value, the step size does not change automatically.

6.7.4 Amplitude offset and amplitude slope

The “amplitude offset” allows the amplitude (rather than phase) data to be offset by a fixed or slope value in Db. The amplitude offset setting affects only the work trace. If the display format is “Linear Amplitude” or “Real Number” (unitless), the dB is converted and the correct offset is implemented.

Operating steps:

Press **Scale**, use the knob or arrow keys to bring focus to the **Constants** → **Mag Offset / Mag Slope** parameter item.

Press **ENTER** or Knob to enter the editing state. After the editing is completed, move the cursor to the specified position by up and down direction keys or Knob. Press **ENTER** or Knob to select the current option.

Amplitude deviation: Offset the entire data trace at the specified value.

Margin slope: Offset the data trace by some value that changes with frequency. The offset slope starts at 0 Hz.

6.7.5 Phase deviation

Phase offset mathematically adjusts the phase measurement to a specified degree (up to 360°). This feature can be used in the following ways:

- Improved display of phase measurements. This is the same way as changing the reference level in the amplitude measurement. Change the phase response to the center or align the response on the screen.
- Simulate Projection phase shift in measurements. For example, if you know that you need to add a cable and that the length of the cable will add a certain phase shift to the measurement, you can use a phase shift to increase the length and simulate the entire device measurement.

Key operation:

Press **Scale**, use the knob or arrow keys to bring focus to the **Constants** → **Phase Offset** parameter item. Press **ENTER** or Knob to enter the editing state. After the editing is completed, move the cursor to the specified position by up and down direction keys or Knob. Press **ENTER** or Knob to select the current option.

6.7.6 Divisions

Sets the number of divisions on the Y axis. An even number from 4 to 30 must be used. Once set, it is commonly applied to all the traces displayed in the linear scale type on the Y axis within that window.

Operating steps:

Press **Scale**, use the knob or arrow keys to focus on the **Advanced** → **Divisions** parameter item. Press **ENTER** or Knob to enter the editing state. Set the value of the Y-axis divisions in the Cartesian coordinate format. After the editing is completed, move the cursor to the specified position by up and down direction keys or Knob. Press **ENTER** or Knob to select the current option. Range: even numbers from 4 to 30. Divisions do not apply in polar coordinates, Smith chart formats and logarithmic scale type.

6.7.7 Scale type

The scale types include linear scale and logarithmic scale, which are expressed as the scale distribution of the Y axis in the coordinate system. In a logarithmic scale type, the upper and lower limits of the Y-axis determine how the data trace is displayed on the VNA screen. The scale type can be set separately for each measuring trace.

Operating steps:

Press **Scale**, use the knob or arrow keys to focus on the **Advanced** → **Scale Type** parameter item. Press **ENTER** or Knob to enter the editing state. After the editing is completed, move the cursor to the specified position by up and down direction keys or Knob. Press **ENTER** or Knob to select the current option.

Note: The logarithmic scale type can only be selected when the display format is linear magnitude scheme, real number format or imaginary number format. Other formats are linear scale type.

Scale type:

- Linear Scale Type
- Log Scale Type

Linear: Y-axis scale linear distribution. The display mode can be set by setting scale, reference level and position.

Log: The Y-axis scale is logarithmic. The display range can be set by setting the maximum and minimum values of the Y axis.

Max Value: Set the upper limit of the Y-axis in the logarithmic scale type.

Min Value: Set the lower limit of the Y-axis in the logarithmic scale type.

6.8 Avg BW

6.8.1 Overview

The dynamic range is the finite difference between the maximum input power level and the minimum measurement power level (noise floor) of the analyzer. In evaluating a characteristic accompanied by a large change in the amplitude (the start and stop band of a filter for example), it is important to increase the dynamic range. The noise floor can be reduced by narrowing the IF bandwidth or turning on Sweep Averaging.

For minimizing very low noise, Averaging is more effective than reducing IF bandwidth. Generally, Averaging takes slightly longer than IF bandwidth reduction to lower noise, especially if many averages are required. Also, changing the IF bandwidth after calibration results in uncertain accuracy.

6.8.2 Averaging

Averaging is a feature that the VNA averaging on each data point before stepping to the next data point. You determine the number of measurements by setting the averaging factor. The higher the averaging factor, the greater the amount of noise reduction.

Averaging setting:

Press the “Avg BW” key, then enter the Averaging and Bandwidth menu.

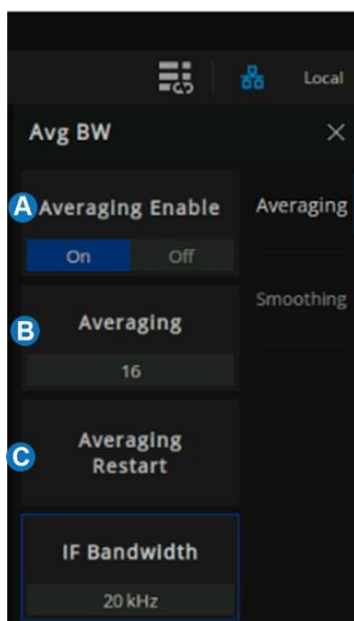

- A. Averaging Enable.
- B. Sweep Averaging factor. (an integer between 1 and 999)
- C. Averaging Restart. Restart the Sweep Averaging from 1.

Figure 6-7 Avg BW menu

6.8.3 IF Bandwidth

The received signal of VNA is converted from its source frequency to a lower intermediate frequency (IF). Reducing the IF receiver bandwidth reduces the effect of random noise on a measurement. Each tenfold reduction in IF bandwidth lowers the noise floor by 10 dB. However, narrower IF bandwidths cause longer sweep times.

IF Bandwidth setting:

1. Using the Softkey for setting: Press the “Avg BW” key, Press “Avg BW” > Averaging > IF Bandwidth > Enter the IF Bandwidth value.

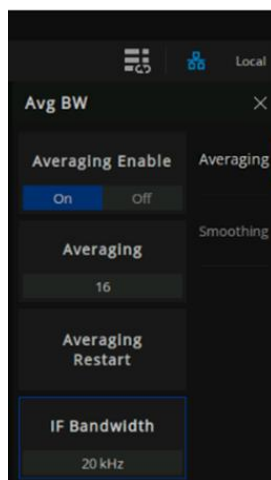

Figure 6-8 Set the IF from the menu bar

2. Using a mouse for setting: Click the “BW=xx” icon on the menu bar and select IF Bandwidth.

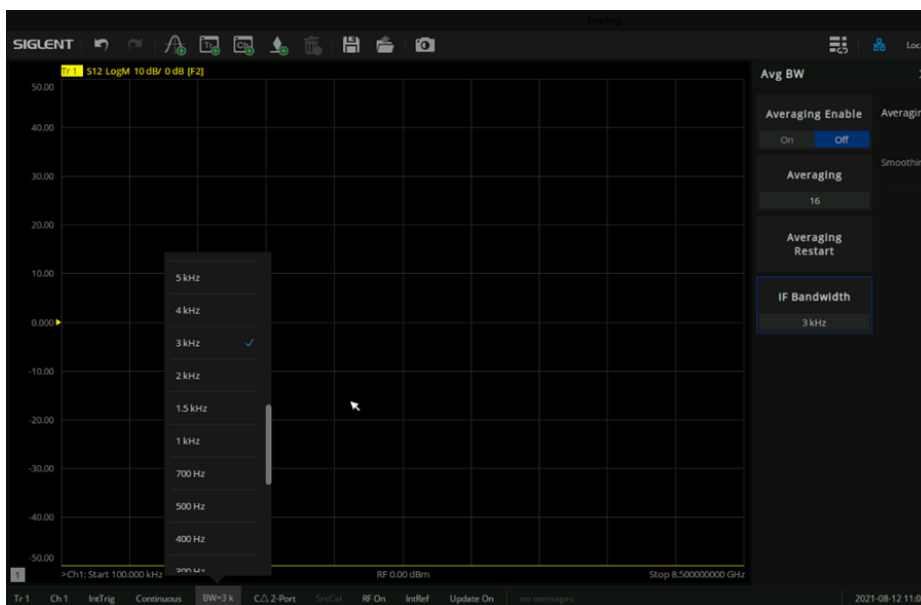

Figure 6-9 Set the IF from the status bar

6.8.4 Smoothing

Trace smoothing averages several adjacent data points to smooth the displayed trace. The number of adjacent data points that get averaged together is also known as the smoothing aperture. You can specify the aperture as either the number of data points or the percentage of the x-axis span.

Trace Smoothing reduces the peak-to-peak noise values on broadband measured data. It smooths trace noise and does not increase measurement time significantly.

Smoothing setting:

Using the Softkey for setting: Press the “Avg BW” key, “Avg BW” > Smoothing then enter the Smoothing menu.

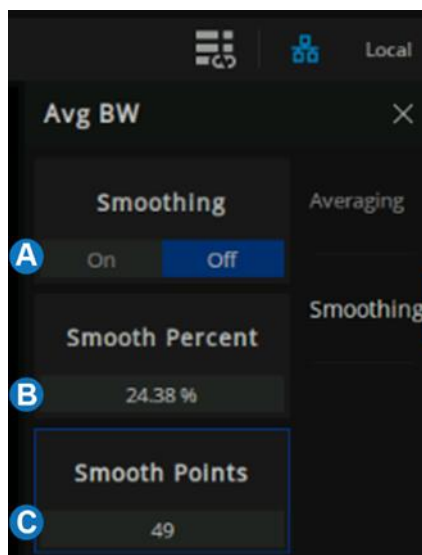

Figure 6-10 Smoothing menu

- A. Smooth On|Off When is On, applies smoothing to the displayed trace.
- B. Percent of Smooth: Specify the percent of the swept stimulus span to smooth. For example, for a trace that contains 100 data points, and a smoothing percent of span = 11%, then the number of data points that are averaged is 11.
- C. Smooth Points: Specify the number of adjacent data points to average.

Tips:

Start with a high number of display points and reduce until you are confident that the trace is not giving misleading results.

Do not use smoothing for high-resonance devices, or devices with wide trace variations. It may Smoothing is set independently for each trace.

6.9 Preset instructions

Invokes preset Settings to restore system Settings to the specified just started state.

Operating instructions:

- Preset types are available through **Preset** → **Preset Option**, Select **“Default”**, **“Last”**, or **“User”**.
- Press the **Preset** key, and the device invokes either default Settings or user Settings.

Table 6-1 Some default setting values

Parameter name	Parameter value
RF Power	
RF state	ON
RF level	0 dBm
Signal output port	Port 1
Port coupling	ON
Frequency	
Frequency range	100 kHz-8.5 GHz
Frequency step size	42.4995 MHz
Frequency points	201
Sweeping	
Sweeping points	201
Sweeping type	Linear frequency
Sweeping time delay	0 s
Sweeping mode	automatic
Trigger	
Trigger mode	continuous
Trigger source	internal
Measurement	

S parameter	S11
Display format	
Data display format	Log Mag
Scale	
Scale	10 dB
Reference level	0 dB
reference position	5
Scale coupling	OFF
Delay time	0 s
Delay distance	0 m
Distance unit	meter
Speed coefficient	1
System impedance	50 Ω
Phase deviation	0°
Amplitude deviation	0 dB
Average	
Average state	OFF
Smooth state	OFF
Calibration	
Calibration state	unloaded calibration data

7 Measurement Calibration

7.1 Overview

Usually, DUTs can't be measured directly and accurately due to cabling, adapters, probes, and more. Calibration, compensation, and fixture simulation are introduced to help achieve higher accuracy. These functions meet different measurement requirements, but they all can be expressed as a matrix multiplication of the scattering parameter matrix and a specific compensation matrix. The order of the matrix multiplication has a large influence on the result. So it's important to understand the order of applying these functions and to design a suitable physical connection to the DUT and expected measurement network.

Internal source power calibration and receiver calibration are applied before the scattering parameter calculation, and the S parameter calibration is applied to the calculation results. This provides the highest measurement accuracy at the calibration reference plane.

From the reference plane, the order of applying functions is as follow:

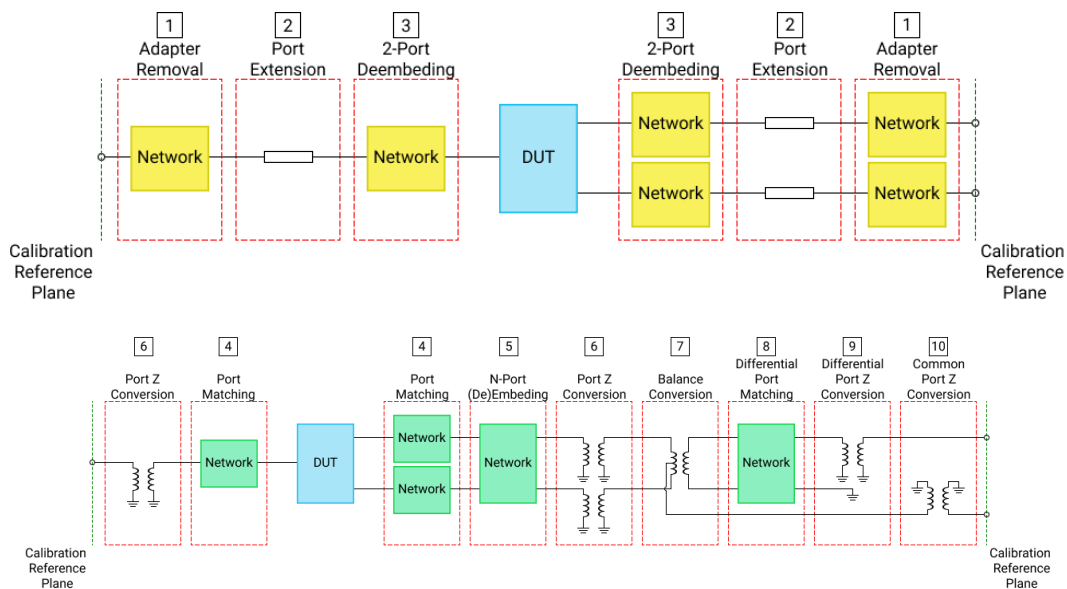

Figure 7-1 The order of applying functions

At first, adapter removal/ insertion, port extension, 2-port de-embedding are applied to remove the needless networks in the physical connections of the DUT and move the measurement plane to the DUT. Then, Port match, N-port embedding/ de-embedding, port impedance conversion are used to embed or de-embed expected virtual networks. If balance scattering parameters are measured, balance conversion, differential port match, differential port impedance conversion, common port impedance conversion can be helpful if needed.

7.2 Calibration type

The following table is a comparison of some common S-parameter calibration types:

Table 7-1 S-parameter calibration types

Calibration type	precision	Allow pass-through methods
TRL	Very high	All, except the unknown direct
SOLT	high	All
Enhanced Response	high	Defined through or flush through (zero-length through)
Port 1 (reflection)	high	Not Applicable
Open Circuit Response/ Short Circuit Response	low	Not Applicable
Direct Response	low	Known through or flush through (zero-length through)

The following are the actual S-parameter calibration types used by this vector network analyzer.

Table 7-2 The vector network analyzer S parameter calibration types

Port number	Calibration type	Calibration item
Port 1	Response (Open)	Open, Load (optional)
	Response (Short)	Short, Load (optional)
	OSL	Open, Short, Load
Port 2	Response (Thru) 1 → 2	Thru, Isolation (optional)
	Response (Thru) 2 → 1	Thru, Isolation (optional)
	Enhanced Response (Thru) 1 → 2	Port1:Open, Short, Load Thru, Isolation (optional)
	Enhanced Response (Thru) 2 → 1	Port2:Open, Short, Load Thru, Isolation (optional)

	SOLT	Port1: Open, Short, Load Port2: Open, Short, Load Thru, Isolation (optional)
	SOLR	Port1: Open, Short, Load Port2: Open, Short, Load Unknown Thru, Isolation (optional)
	TRL	Port1: Reflect (Open or Short) Port2: Reflect (Open or Short) Thru, Line

TRL:

Application: Used to precisely calibrate any pair of ports when no calibration kits are readily Available.

Note: Difference matching calibration may be required (**Delta Match Cal**)

Overall accuracy: Very high

Calibration kits required: Straight, reflection, line, or similar combination

Corrected system error:

- Directivity
- Isolation
- Frequency response transmission tracking
- Source match
- Load match
- Frequency response reflection tracking

SOLT :

Application: Used to accurately calibrate any number of ports

Overall accuracy: High

Required calibration kits: short circuit, open circuit, load, through) or ECAL electronic calibration parts module

- Directivity
- Isolation
- Frequency response transmission tracking
- Source match
- Load match
- Frequency response reflection tracking

Enhanced Response:

Application: Calibrate two ports when only one direction (forward or reverse) is needed for measurement. Because no secondary sweep is required, the measurement is faster.

- The reflection calibration element (open, short circuit, or load) is connected to the source port to be calibrated.
- The defined through-through or flush through-through calibrator kits are connected between port pairs.
- The mechanical calibration kit is much faster than the SOLT. You can also use ECAL.

To select an enhanced response, do the following:

Keys operation: Press **Cal**, using the knob or arrow keys, to focus on the **Cal** → **Basic Cal** parameter item. Select **port1 & port2** from the interface menu, Select **Enhanced Response 1** → **2 or Enhanced Response 2** → **1** in the **Cal Type**, Press **ENTER** or the knob to select the current option.

Overall accuracy: High

Required calibration kits: Short circuit, open circuit, load, defined through or flush through

Corrected system error:

- Directivity (Source port)
- Isolation
- Frequency response transmission tracking (receiver port)
- Source match (source port)
- Load matching (receiver port) is used only to generate transmission trace items
- Frequency response reflection tracking (source port)

One port (reflection):

Application: Used to accurately calibrate any test port suitable for reflection measurement only

Overall accuracy: High

Required calibration kits: Short circuit, open circuit, and load or ECAL module

Corrected system error:

- Directivity
- Frequency response reflection tracking
- Source match

Open circuit response / short circuit response:

Application: Quick calibration of any test port suitable for reflection measurement only

Overall accuracy: Low

Calibration kits required: Open circuit or short circuit.

Corrected system error:

- Frequency response reflection tracking

Direct / Transport Tracking (isolation optional):

Application: Quick calibration of any pair of test ports suitable for transmission measurements only.

Isolation calibration is generally not recommended.

Overall accuracy: Low

Required calibration kit: Through

Isolation: Each load corresponds to a vector network analyzer test port.

Corrected system error:

- Isolation
- Frequency response transmission tracking

Power calibration types: Transmitter calibration (internal source power calibration) and receiver calibration.

7.3 Checking Calibration Status

7.3.1 Execution Status of Error Correction for Each Channel

User can check the execution status of error correction for each channel with the error correction status.

The error correction status is indicated in the channel status bar in the lower part of the window by the symbols in the below table.

Symbol	Execution Status of Error Correction	Accuracy
No Cor	Error correction: On (No Correction)	Lowest
C N-Port	Error correction: On (Full N Port Correction)	Highest
C* N-Port	Error correction: On (Interpolation is being executed)	Uncertain
CΔ N-Port	Error correction: On (Extrapolation is being executed)	Uncertain

No Cor

It indicates there is no Correction. The following will cause the VNA to turn Error Correction OFF for the channel:

- Decrease the start frequency.
- Increase the stop frequency.
- Increase number of points
- Change sweep type.

C N-Port

Full N Port correction, where N is the number of fully calibrated ports. This correction is applied to SParameters.

C* N-Port

"C* " appears in the status bar when a measurement is being interpolated. Interpolation occurs when you change any of the following settings:

- Start frequency increased
- Stop frequency decreased
- Number of points

Note: Decreasing the start frequency, or increasing the stop frequency will always turn correction OFF.

CA N-Port

"CA" appears in the status bar when one or more of the following stimulus settings change. The resulting measurement accuracy depends on which parameter has changed and how much it has changed. For optimum accuracy, recalibrate using the new settings.

- Sweep time
- IF Bandwidth
- Port power

7.3.2 Execution Status of Error Correction for Each Trace

User can check the status of the error correction actually executed for each trace with the trace status area.

For a trace for which error correction is executed, the applied calibration type is indicated in the trace status area by the symbols in the table below.

Symbol	Calibration type
RO	Open response calibration
RS	Short response calibration
RT	Thru response calibration
ER	Enhanced response calibration
F1	1-port calibration
F2	Full 2-port calibration/2-port TRL calibration
F3	Full 3-port calibration/3-port TRL calibration
F4	Full 4-port calibration/4-port TRL calibration

Note: If none of the symbols described above is displayed, error correction is not executed for the trace.

7.3.3 Acquisition Status of Calibration Coefficient for Each Channel

User can check the acquisition status of the calibration coefficient for each channel with the calibration property.

The calibration property displays the acquisition status of the calibration coefficient between test ports for each channel in matrix format. The following figure shows an example of when the calibration coefficients have been acquired for the full 2-port calibration between test ports 1 and 2,

the response calibration for test port 3, and the response calibration (THRU) between test ports 4 and 3.

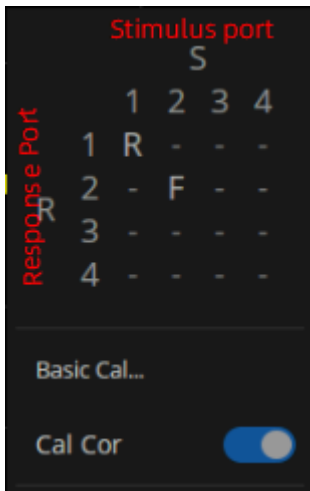

F : Full Port Calibration

R : Response Calibration

-- : Nothing

7.3.4 Procedure to turn on/off calibration property display

There are two methods to turn on/off the display of calibration property.

Method 1: Click the channel error correction execution status symbol in the channel status bar to open and close, as shown in the left figure below.

Method 2: Press "Cal" on the front panel > Cal > Correction, as shown in the right figure below.

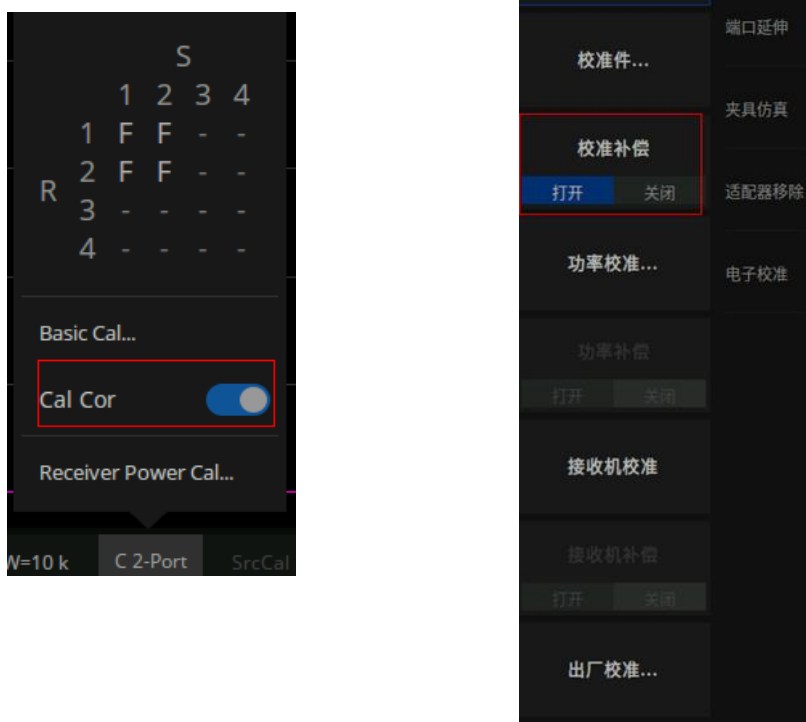

7.4 S parameter calibration

7.4.1 S parameter calibration Kit management

7.4.1.1 Overview

For most applications, the default calibration kit models provide sufficient accuracy for your calibration. However, several situations may exist that would require you to create a custom calibration kit:

- Using a connector interface different from those used in the predefined calibration kit models.
- Using standards (or combinations of standards) that are different from the predefined calibration kits. For example, using three offset SHORTs instead of an OPEN, SHORT, and LOAD to perform a 1-port calibration.
- Improving the accuracy of the models for predefined kits. When the model describes the actual performance of the standard, the calibration is more accurate. For example, A 7 mm LOAD is determined to be 50.4 Ω instead of 50.0 Ω .
- Modifying the THRU definition when performing a calibration for a non-insertable device.

- Performing a TRL calibration.

Operation instructions:

Press “Cal” on the front panel, Cal > Cal >Cal Kit to enter the Manage Cal Kits page. You can edit, import, and create or delete calibration kits.

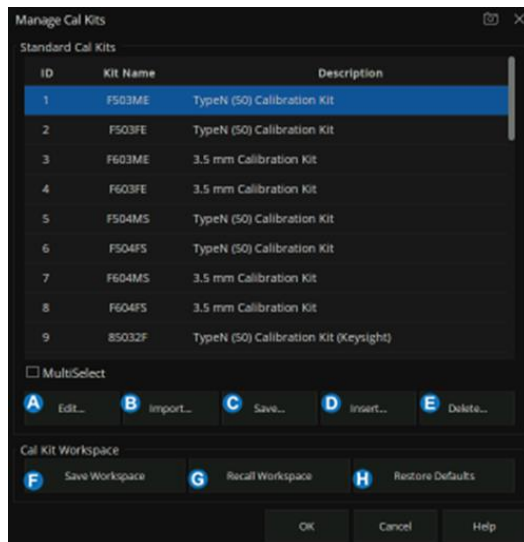

- Edit the Existing Cal Kit.
- Import the customized Cal Kit.
- Save the existing Cal kits and change the file name.
- Create a new custom Cal Kit.
- Select the Cal Kit.
- Save the current Cal kits (both factory and custom).
- Recall the Cal Kits.
- Restore the default factory Cal kits.

Figure 7-2 Manage Cal Kits

7.4.1.2 Connector Tab

At the bottom of each Tab, 'OK' is used to save the edited file, and 'Cancel' is used to close the calibration suite edit session and the file will not be saved. “Help” is used to view the Help documents.

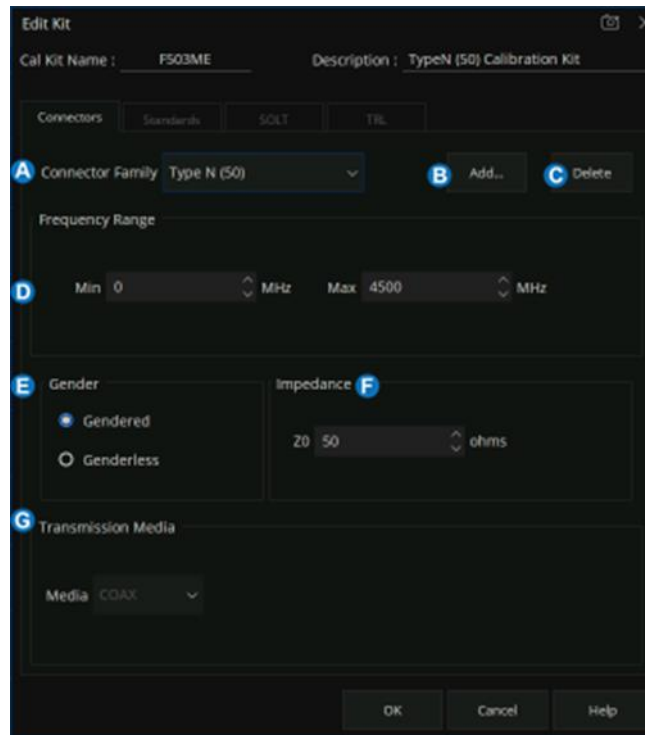

Figure 7-3 The Connectors Tab interface

- A. Connector Family:** Click the down arrow to select the connector family associated with the Cal Kit.
- B. Add:** Starts the Add Connector dialog box which allows you to add a new connector type to the calibration kit.
- C. Select:** The selected connector family .
- D. Frequency Range:** Define the lowest and the highest frequency at which the standard is used for calibration.
- E. Gender:** Gendered or Genderless
- F. Impedance:** Specify the impedance of the standard.
- G. Transmission Media:** The medium of the connector, COAX or WAVEGUIDE

7.4.1.3 Standards Tab

Allows you to Add, Edit, or Delete cal standards in a cal kit.

- 1) In the “Standard” tab, click “Add” to add the Standard sample.

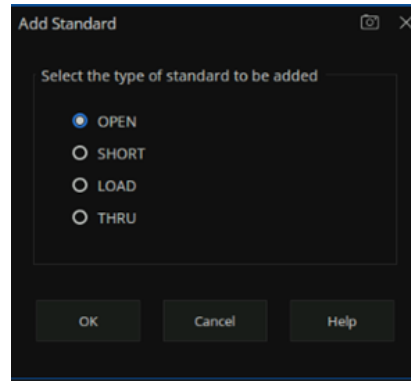

Figure 7-4 add standard interface

- 2) Standards dialog box help, the following fields apply to ALL standard types.

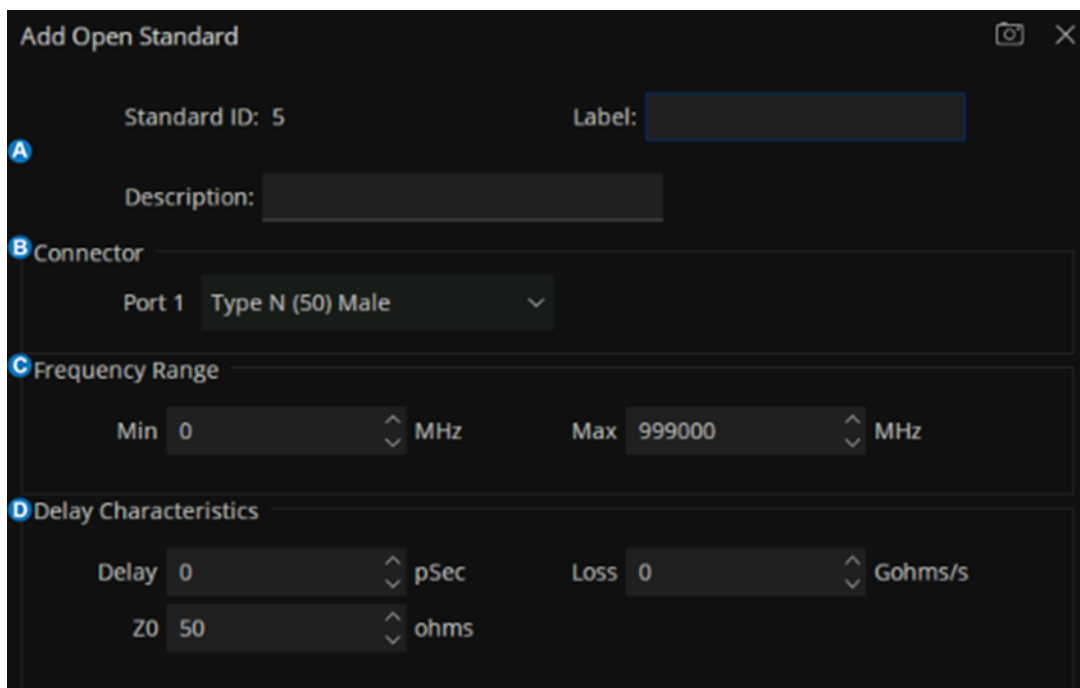

Figure 7-5 The help dialog of the Standard

A. Identification

Standard ID: Number in list of standards

Label: Type of standard. This usually appears in prompts for standards.

Description: Description of standard.

B. connector

Indicates the type and gender (Male, Female, None) of the standard.

Thru and Isolation standards have two connectors.

C. Frequency Range

Min: Defines the lowest frequency at which the standard is used for calibration.

Max: Defines the highest frequency at which the standard is used for calibration.

D. Delay Characteristics

Delay: Defines the one-way travel time from the calibration plane to the standard in seconds.

Z0: Defines the impedance of the standard.

Loss: Defines energy loss in Gohms, due to skin effect, along a one-way length of coaxial cable.

Open Standard

C0, C1, C2, C3: Specify the fringing capacitance.

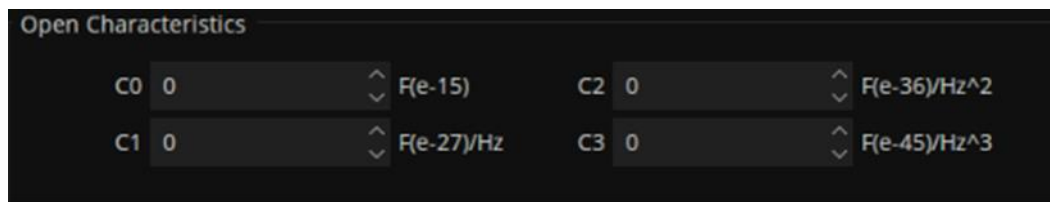

Figure 7-6 Open Characteristics

Short Standard

L0, L1, L2, L3: Specify the residual inductance.

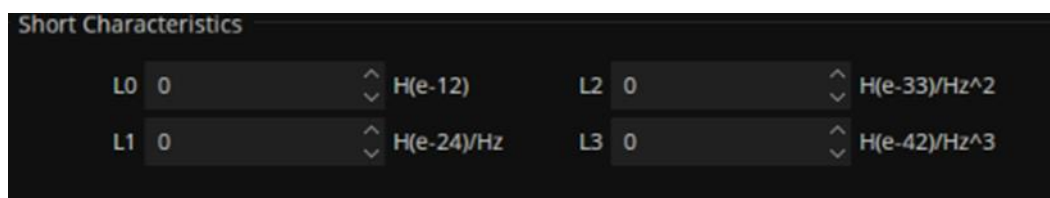

Figure 7-7 Short Characteristics

Load Standard

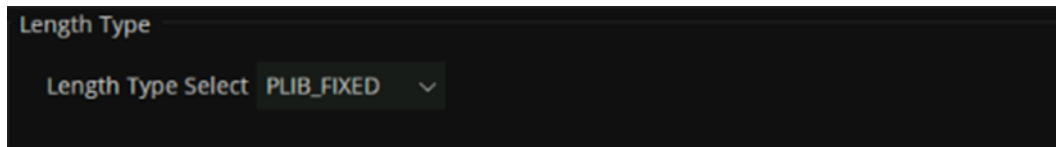

Figure 7-8 load Characteristics

THRU Standard

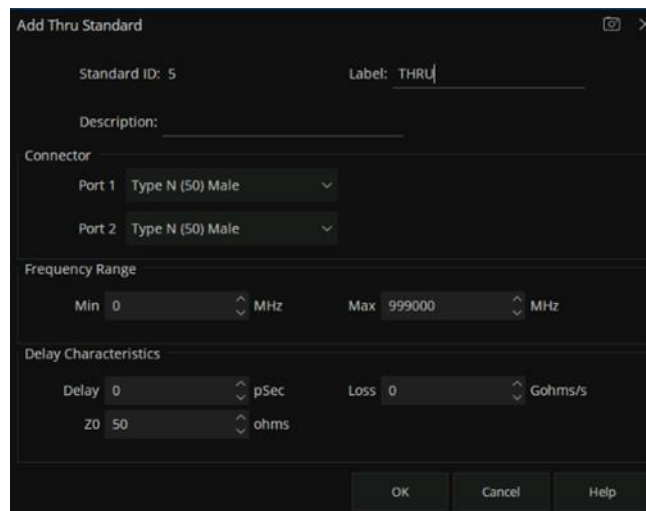

Figure 7-9 THRU Characteristics

7.4.1.4 SOLT Tab

Allows you to assign single or multiple standards to SOLT Calibration Classes.

- 1) For each Cal Kit Class, select Available Standards from the left list, then click >> to copy the standard to the Cal Kit
- 2) Use Move Up and Move Down to change the ORDER of the standards.

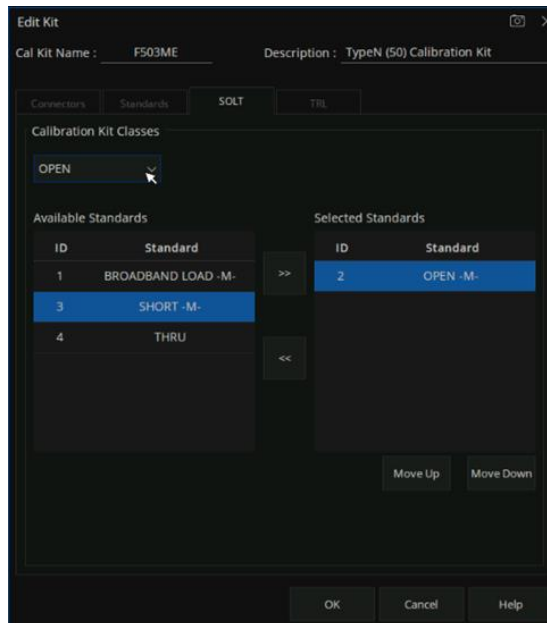

Figure 7-10 SOLT Tab dialog box

7.4.1.5 TRL Tab

Allows you to assign single or multiple standards to Calibration Classes.

- 1) For each Cal Kit Class, select Available Standards from the left list, then click >> to copy the standard to the Cal kit.
- 2) Use Move Up and Move Down to change the ORDER of the standards.

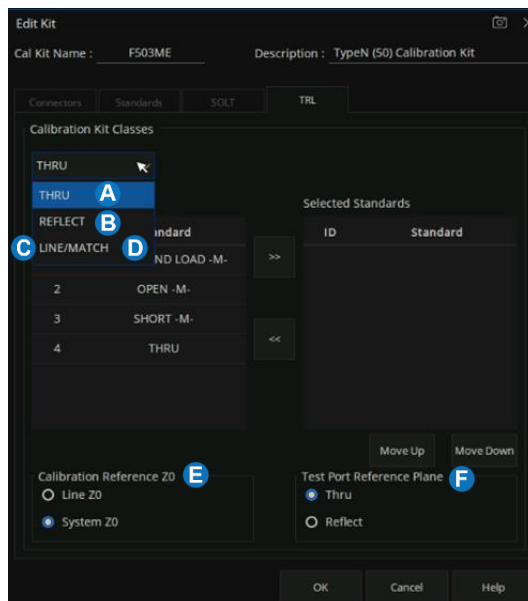

Figure 7-11 TRL dialog box

A. TRL THRU

All THRU calibration methods are supported in a TRL Cal EXCEPT Unknown Thru.

- The THRU standard can be either a zero-length or non-zero length. However, a zero-length THRU is more accurate because it has zero loss and no reflections, by definition.
- The THRU standard cannot be the same electrical length as the LINE standard.
- If the insertion phase and electrical length are well-defined, the THRU standard may be used to set the reference plane.
- The THRU standard and LINE standard have the same characteristic impedance and are perfectly matched. They define the reference impedance of the calibration.
- If a THRU standard with the correct connectors is NOT available, an adapter removal cal can be performed.

B. TRL REFLECT

- The REFLECT standard can be anything with a high reflection, as long as it is the same when connected to one or more VNA ports.
- The REFLECT standard on each port is identical.
- The actual magnitude of the reflection need not be known.
- The phase of the reflection standard must be known within 1/4 wavelength.
- If the magnitude and phase of the reflection standard are well-defined, the standard may be used to set the reference plane

C. TRL LINE

The LINE and THRU standards establish the reference impedance for the measurement after the calibration is completed. TRL calibration is limited by the following restrictions of the LINE standard

- Must be of the same impedance and propagation constant as the THRU standard.
- The electrical length need only be specified within 1/4 wavelength.
- Cannot be the same length as the THRU standard.
- A TRL cal with broad frequency coverage requires multiple LINE standards. For example, a span from 2 GHz to 26 GHz requires two line standards.
- Must be an appropriate electrical length for the frequency range

D. TRL MATCH

If the LINE standard of appropriate length or loss cannot be fabricated, a MATCH standard may be used instead of the LINE.

- The MATCH standard is a low-reflection termination connected to both Port 1 and Port 2.
- The MATCH standard may be defined as an infinite length transmission line OR as a 1-port low reflect termination, such as a load.
- When defined as an infinite length transmission line, both test ports must be terminated by a MATCH standard at the same time. When defined as a 1-port load standard, the loads are measured separately. The loads are assumed to have the same characteristics.
- The impedance of the MATCH standard becomes the reference impedance for the measurement. For best results, use the same load on both ports. The load may be defined using the data-based definition, the arbitrary impedance definition, or the fixed load definition.

E. Calibration Reference Z0

- System Z0: The system impedance is used as the reference impedance. Choose when the desired test port impedance differs from the impedance of the LINE standard. Also, choose when skin effect impedance correction is desired for coax lines.
- Line Z0: The impedance of the line standard is used as the reference impedance or center of the Smith Chart. Any reflection from the line standard is assumed to be part of the directivity error.

F. Test Port Reference Plane

- Thru Standard: The THRU standard definition is used to establish the measurement reference plane. Select if the THRU standard is zero-length or very short.
- Reflect Standard: The REFLECT standard definition is used to establish the position of the measurement reference plane. Select if the THRU standard is not appropriate AND the delay of the REFLECT standard is well defined.

7.4.1.6 Create a custom Cal Kit

There are two methods to create a custom Cal Kit:

Method 1: Create custom Cal Kit based on existing Cal kits

1. Press “Cal” > Cal > Cal Kit > F503ME > Save . Select the existing F503ME Cal Kit then save it to a local file named “F503ME123.xkt”.

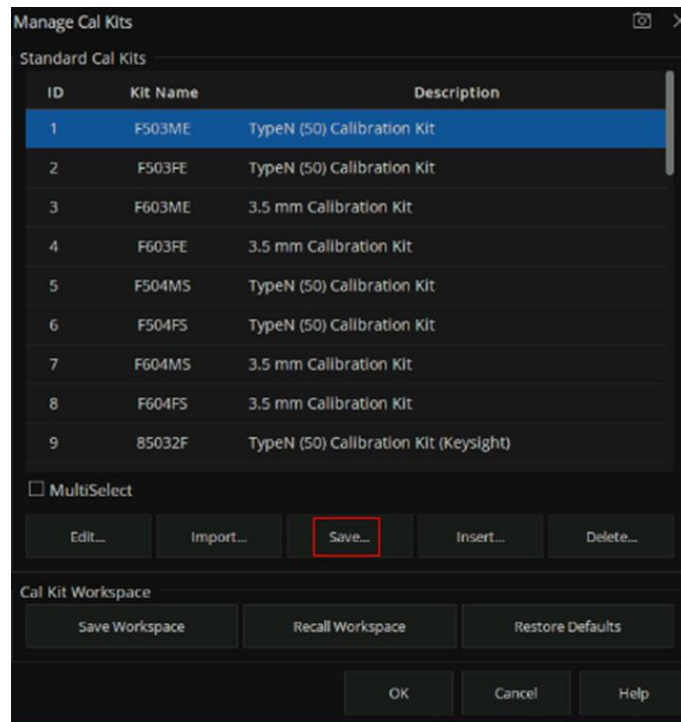

Figure 7-12 Creating a Custom Cal Kit dialog box

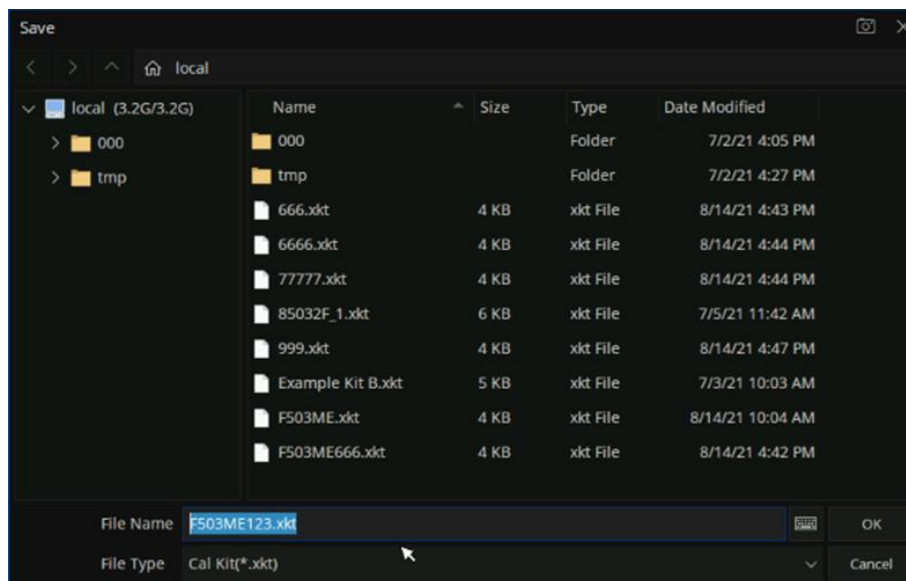

Figure 7-13 Save the ECal Kit

- In the Manage Cal Kits dialog box, click “Import” to Import the new calibration “F503ME123.xkt”.

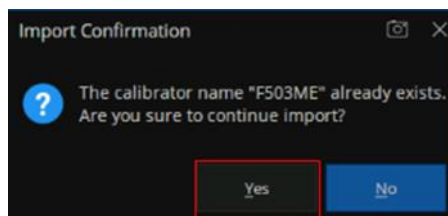
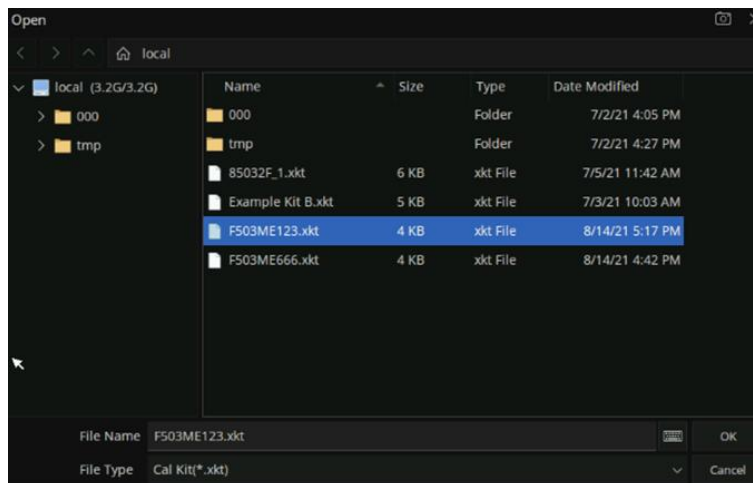

Figure 7-14 Import the new ECal Kit

- Select the newly imported calibration, click “Edit” to enter the calibration editing interface, and modify the calibration name as “F530ME-ABC”.

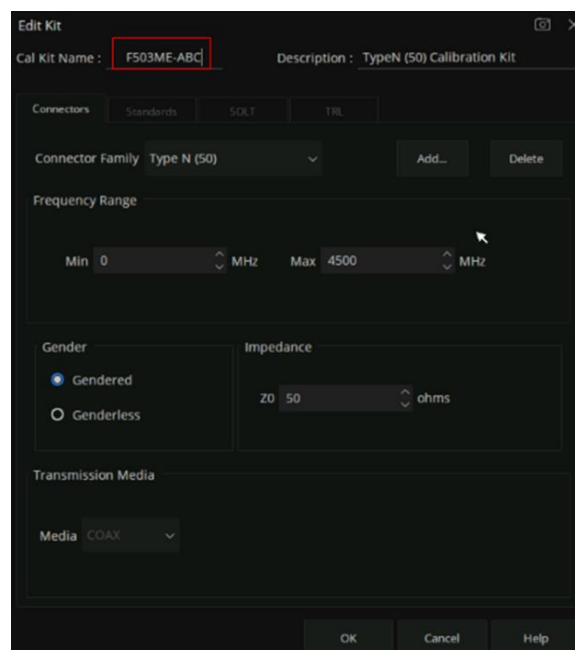

Figure 7-15 Edit the new import ECal Kit

4. Click the Connectors, Standards, SOLT, and TRL Tabs to modify the corresponding parameters as you need .
5. Click “OK” for the changed Cal Kit to take effect.

Method 2: Create a custom Cal Kit directly for new connector types.

1. Press “Cal” > Cal > Cal Kit > Insert...
2. Enter the name and description of the custom Cal Kit.
3. Refer to Method 1, click the Connectors, Standards, SOLT, TRL tab to modify the corresponding parameters.
4. Click “OK” to make the created calibration effective.

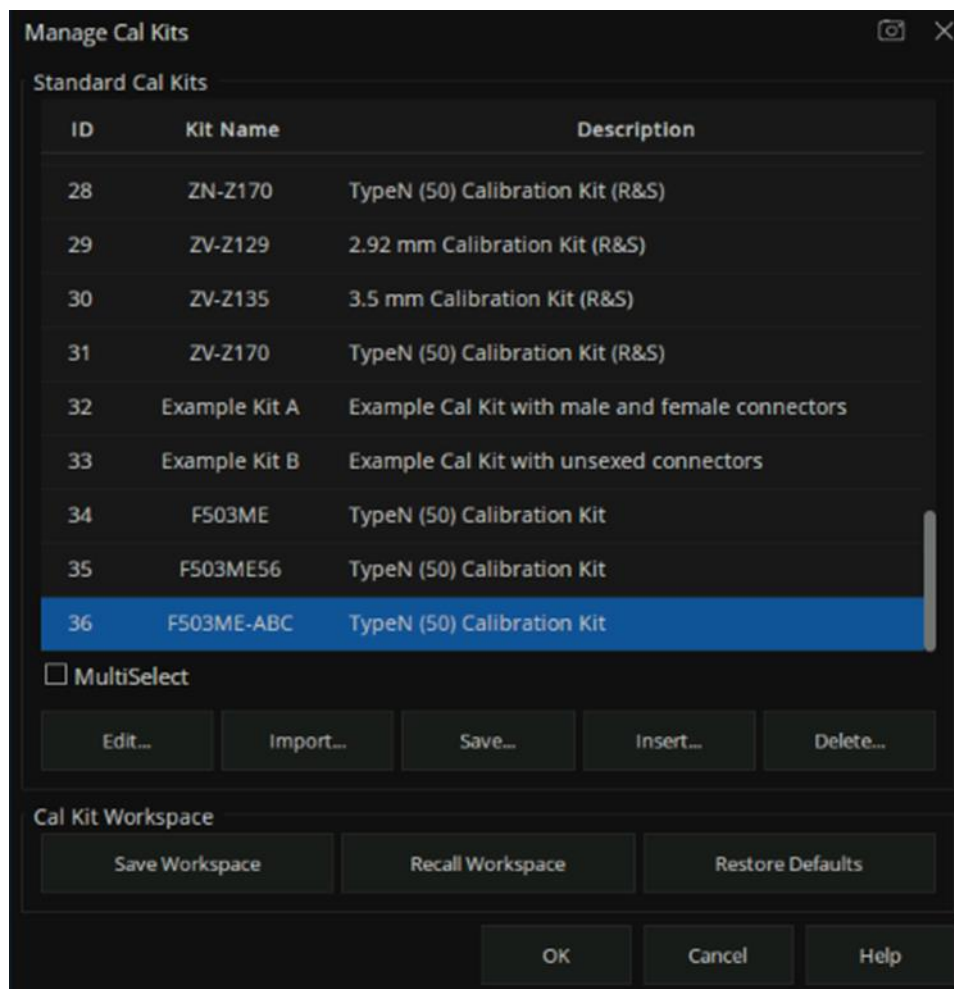

Figure 7-16 View the newly created Cal Kit

7.4.2 S Parameter calibration wizard

S parameter user calibration can be started after selecting the required S parameter calibration type in the calibration wizard and setting the corresponding parameters.

Operating instructions:

Press the **Cal** key, use the knob or the arrow key to make the focus fall on **Basic Cal**, and press **Enter** to enter the setting interface of the calibration kit:

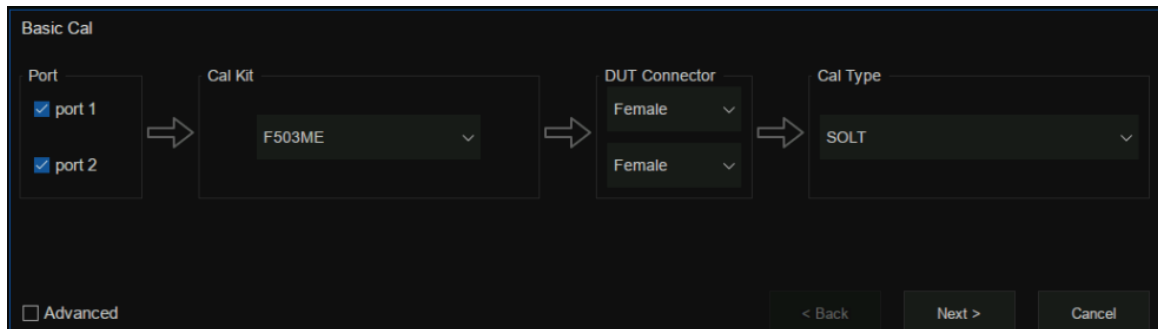

Figure 7-17 Calibration wizard interface

Select the number of ports to be calibrated from the port menu in the calibration wizard interface, and select the corresponding calibration kit model in the Cal Kit pull-down option. Select the gender properties of the calibration connector from the DUT Connector drop-down option, and select the corresponding calibration method from the Cal Type drop-down option, as shown in the figure below:

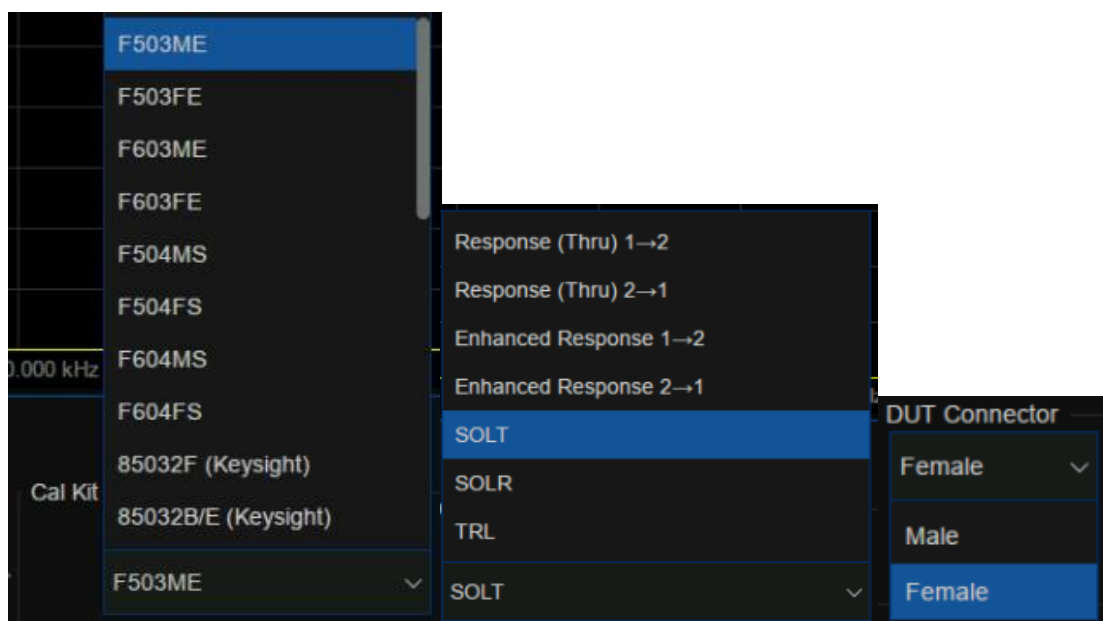

Figure 7-18 Calibration wizard interface

After the calibration is set, a specific calibration item interface will appear as shown in the figure below. Here, taking the two-port SOLT calibration method as an example, it includes several calibration items: OPEN, SHORT, LOAD, THRU, ISOLATION, among which the ISOLATION calibration item may not be calibrated. There is no sequence relation between these calibration terms. Simply select the corresponding calibration kit and click the corresponding calibration item menu on the interface.

After completion of the corresponding calibration item, the percentage of calibration progress will be displayed in the lower-left corner of the interface. When all the calibration steps are completed, the calibration progress bar will show 100%. Click Finish to exit the calibration interface, calibration results are automatically loaded in the current screen.

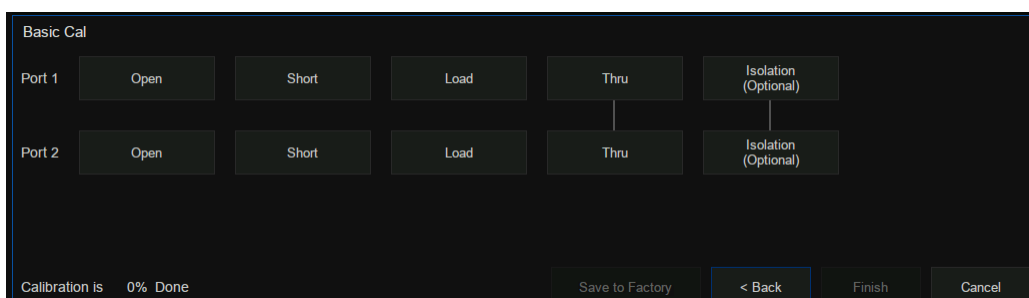

Figure 7-19 Calibration wizard interface

To Save the current calibration data for future use, press the **Save Recall** button and use the knob or arrow keys to bring the focus to the **Save State** menu bar. Select **State+Cal Data** from the **Save Type** drop-down option, click **Save State As** and enter the file name, and click **OK** to Save the current calibration Data and the current setting State.

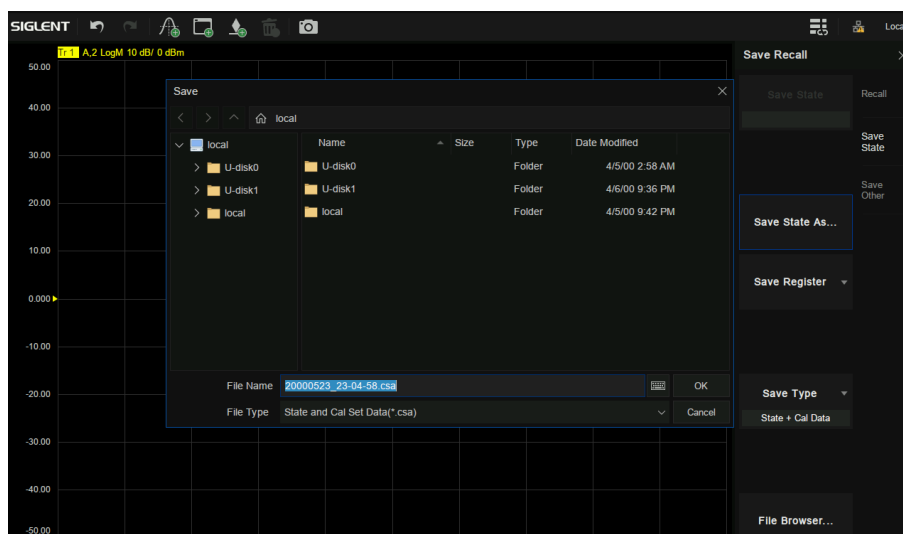

Figure 7-20 Calibration wizard interface

7.4.3 Open Response Calibration

When a single port is used for open-circuit response calibration, the reflection tracking error in the error model of the test device can be calculated by only connecting the OPEN calibration element to the test port. If the LOAD calibration element is used for isolation calibration at the same time, the directional error can be calculated.

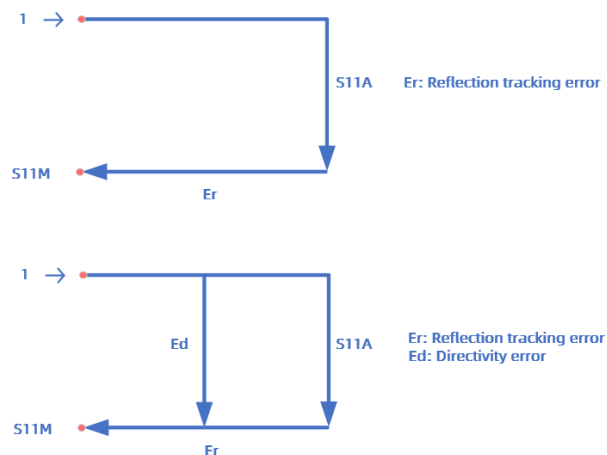

Figure 7-21 Schematic diagram

Operating steps:

1. **Preset** vector network analyzer.
2. Set internal source output power, IF bandwidth, sweep points, test frequency band and other parameters.
3. Select **Cal** → **Basic Cal** to enter the Settings screen.
4. Select only **Port1** or **Port2**, select the required calibration kit in the **Cal Kit**, select the Type of calibration element connector, **Female** or **Male**, in the **DUT Connector**, select **Response(Open)** in the **Cal Type**, and click **Next** to proceed to the next step.
5. Connect the OPEN calibration element to the test port according to the interface prompts, click **Open** for calibration, and click **Finish** to exit the calibration interface after calibration, complete the calibration, and save the calibration data.

7.4.4 Short circuit response calibration

Like the open-circuit response calibration, the single-port short-circuit response is connected to the port with the SHORT calibration element, and the reflection tracking error can be calculated. If the LOAD calibration element is used for isolation calibration at the same time, the directional error can also be calculated.

Operating steps:

1. **Preset** Vector network analyzer.
2. Set internal source output power, IF bandwidth, sweep points, test frequency band and other parameters.
3. Select **Cal** → **Basic Cal** to enter the setting interface.
4. Select only **Port1** or **Port2**, select the required calibration kit in the **Cal Kit**, select the Type of connector, **Female** or **Male**, in the **DUT Connector**, select **Response(Short)** in the **Cal Type**, and click **Next** to proceed to the next step.
5. Connect the Short calibration element to the test port according to the interface prompts, click **Short** for calibration, and click **Finish** to exit the calibration interface, complete the calibration, and save the calibration data.

7.4.5 Full 1 port OSL calibration

All 1-port OSL calibration connects the OPEN, SHORT, and LOAD calibration elements to the test ports in turn to calculate the reflection tracking error, directional error, and source matching error in the error model of the test device.

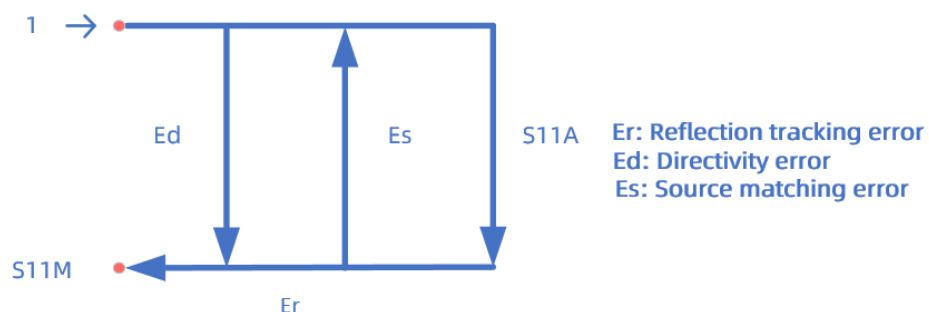

Figure 7-22 Schematic diagram

Operating steps:

1. **Preset** Vector network analyzer.
2. Set internal source output power, IF bandwidth, sweep points, test frequency band, and other parameters.
3. Select **Cal** → **Basic Cal** to enter the setting interface.
4. Select only **Port1** or **Port2**, select the desired calibration kit in the **Cal Kit**, select the Type of calibration connector, **Female** or **Male**, in the **DUT Connector**, select **OSL (Open, Short, Load)** in the **Cal Type**, and click **Next** to proceed to the next step.
 - Connect the OPEN calibration element to the test port according to the interface prompts.
 - Click **Open** for calibration
 - Then connect the SHORT calibration element to the test port, click **Short** for Calibration.
 - Finally, connect the LOAD calibration element to the test port, click the **Load** for Calibration.
 - After the calibration, click **Finish** to exit the calibration interface, complete the calibration, and save the calibration data.

7.4.6 Transmission response calibration (two ports)

Two-port transmission response calibration is to connect the THRU calibration kit between two ports to calculate the transmission tracking error in the test device error model. If the LOAD calibration kit is used for isolation calibration at the same time, isolation error (crosstalk error) can also be calculated.

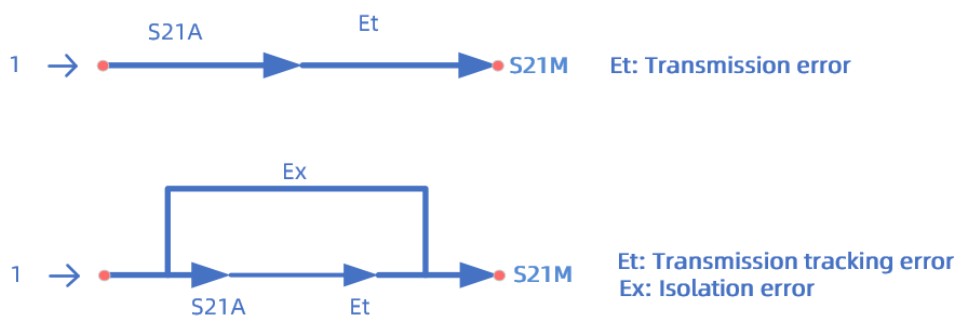

Figure 7-23 Schematic diagram

Operating steps:

1. **Preset** Vector network analyzer.
2. Set internal source output power, IF bandwidth, sweep points, test frequency band, and other parameters.
3. Select **Cal** → **Basic Cal** to enter the setting interface.
4. Select both **Port1** and **Port2**, select the desired calibration kit in the **Cal Kit**, select the Type of calibration connector, **Female** or **Male**, in the **DUT Connector**, Select **Response (Thru) 1 → 2** or **Response(Thru) 2 → 1** in the **Cal Type** (the difference is to test S21 or S12), and click **Next** to proceed to the next step.
5. Connect the **Thru** calibration element between the test ports according to the interface prompts, click **Thru** for calibration, and click **Finish** to exit the calibration interface, complete the calibration, and save the calibration data.

7.4.7 Enhanced response calibration (two ports)

Two-port enhanced response calibration connects the Thru calibration element between two ports, and only connects the Open, Short, and Load on one port for calibration, or connects the LOAD element to both ports for isolation calibration.

Operating steps:

1. **Preset** Vector network analyzer.
2. Set internal source output power, IF bandwidth, sweep points, test frequency band, and other parameters.
3. Select **Cal** → **Basic Cal** to enter the setting interface.
4. Select both **Port 1** and **Port 2**, select the desired calibration kit in the **Cal Kit**, select the type of calibration connector, **Female** or **Male**, in the **DUT Connector**, Select **Enhanced Response 1 → 2** or **Enhanced Response(Thru) 2 → 1** in the **Cal Type** (the difference is that S21 or S12 is tested during THRU calibration), and click **Next** to proceed to the next step.
5. According to the interface prompts, connect Open, Short, and Load on a test port to complete the calibration successively, and then connect the THRU calibration kit between the two ports to perform the **Thru** calibration. After the calibration is completed, click **Finish** to exit the calibration interface, complete the calibration and save the calibration data.

7.4.8 SOLT calibration (two ports)

Two-port SOLT calibration connects the Open, Short, and Load calibration elements to each test port in turn and the THRU calibration kit between the two test ports. All 12 error parameters of the two ports can be calculated, including 6 forward and 6 reverse errors, including directional, source matching, reflection tracking, transmission tracking, isolation (crosstalk), and load matching errors. It is also possible to connect the LOAD element to both ports for isolation calibration.

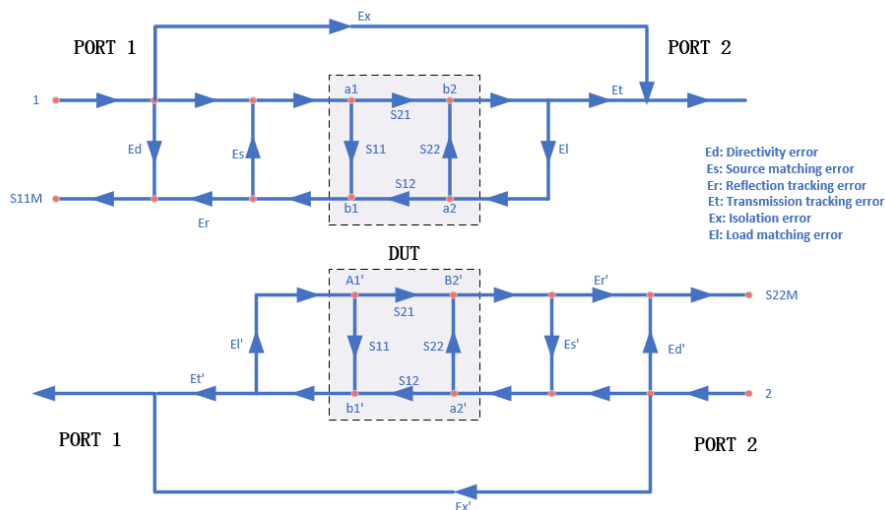

Figure 7-24 Error model diagram

Operating steps:

1. **Preset** vector network analyzer.
2. Set internal source output power, IF bandwidth, sweep points, test frequency band, and other parameters.
3. Select **Cal** → **Basic Cal** to enter the Settings screen.
4. Select both **Port 1** and **Port 2**, select the desired calibration kit in the **Cal Kit**, select the type of calibration connector, **Female** or **Male**, in the **DUT Connector**, select **SOLT** in the **Cal Type**, and click **Next** to proceed to the next step.
5. According to the interface prompts, connect the Open, Short, and Load calibration elements to Port 1 successively, and click the corresponding **Open**, **Short**, and **Load** items successively to complete the Port 1 calibration.
6. According to the interface prompts, connect the Open, Short, and Load calibration elements to Port2 successively, and click the corresponding **Open**, **Short**, and **Load** items successively to complete the Port 2 calibration.

7. According to the interface prompts, connect the THRU calibration kit between the two ports to perform the **Thru** calibration.
8. After the calibration, click **Finish** to exit the calibration interface, complete the calibration, and save the calibration data.

7.4.9 SOLR unknown through calibration (two ports)

In contrast to the two-port SOLT calibration, the error term in the test unit can be calculated without knowing the S-parameter of the THRU straight-through calibration. The calibration method is similar to that of SOLT in that it is possible to connect the LOAD to both ports for isolated calibration.

Operating steps:

1. **Preset** vector network analyzer.
2. Set internal source output power, IF bandwidth, sweep points, test frequency band, and other parameters.
3. Select **Cal** → **Basic Cal** to enter the Settings screen.
4. Select both **Port 1** and **Port 2**, select the desired calibration kit in the **Cal Kit**, select the Type of calibration Connector, **Female** or **Male**, in the **DUT Connector**, select **SOLR** in the **Cal Type**, and click **Next** to proceed to the next step.
5. According to the interface prompts, connect the Open, Short, and Load calibration elements to Port 1 successively, and click the corresponding **Open**, **Short**, and **Load** items successively to complete the Port 1 calibration.
6. According to the interface prompts, connect the Open, Short, and Load calibration elements to Port 2 successively, and click the corresponding **Open**, **Short**, and **Load** items successively to complete the Port 2 calibration.
7. Connect the THRU calibration kit between the two ports according to the interface prompts. The parameters of the THRU do not have to be known. Carry out unknown through **Thru** calibration.
8. After the calibration, click **Finish** to exit the calibration interface, complete the calibration, and save the calibration data.

7.4.10 TRL Direct Reflection Transmission Line Calibration (Two Ports)

The two-port TRL calibration method does not need to know the index parameters of the calibration kit, and all the error items in the error model of the test device can be figured out through three simple connection methods. TRL calibration scheme will use the THRU straight through calibration element, reflection calibration kit (Open or Short), and a small section of transmission line.

Operating steps:

1. **Preset** vector network analyzer.
2. Set internal source output power, IF bandwidth, sweep points, test frequency band, and other parameters.
3. Select **Cal** → **Basic Cal** to enter the Settings screen.
4. Select both **Port 1** and **Port 2**, select the desired calibration kit in the **Cal Kit**, select the Type of calibration kit Connector, **Female** or **Male**, in the **DUT Connector**, select **TRL** in the Cal Type, and click **Next** to proceed to the next step.
5. According to the interface prompts, connect the THRU calibration kit, Reflect (Open or Short) calibration element, and Line on a Port 1 in turn, and click the corresponding **Thru**, **Reflect**, and **Line** items in turn to complete the Port 1 calibration.
6. According to the interface prompts, connect the THRU calibration element, Reflect (Open or Short) calibration element, and transmission line on a Port 2 in turn, and click the corresponding **Thru**, **Reflect**, and **Line** items to complete the Port 2 calibration.
7. After the calibration, click **Finish** to exit the calibration interface, complete the calibration, and save the calibration data.

7.5 Internal source power calibration

The vector network analyzer has been calibrated for the output power of the transmitter before it leaves the factory, but the factory calibration may not guarantee sufficient accuracy in all cases. To improve the accuracy, the user can conduct an internal source power calibration before performing any tests.

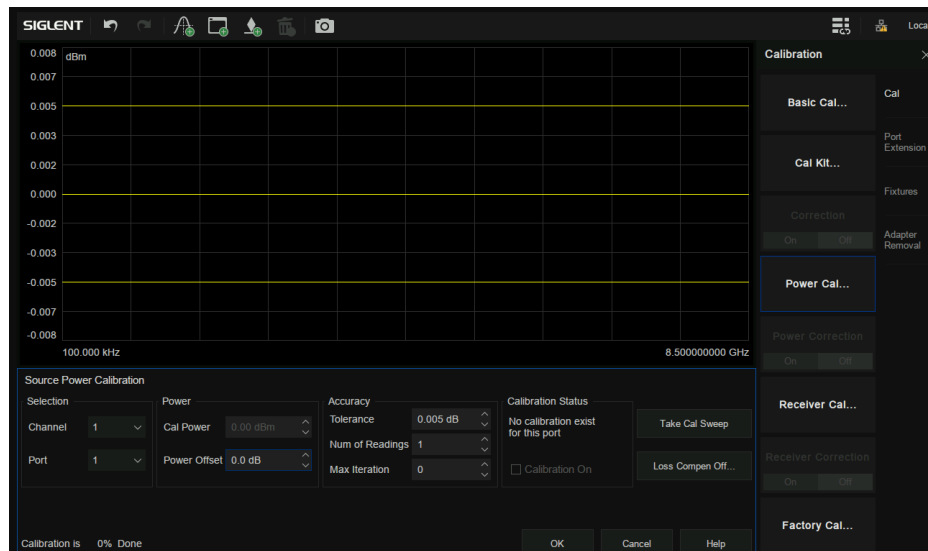

Figure 7-25 Transmitter power calibration

Before attempting power calibration, power loss compensation at different frequency points can be set as shown in the figure below. Click “+” successively to add corresponding frequency and loss values. After setting, click OK to save the data.

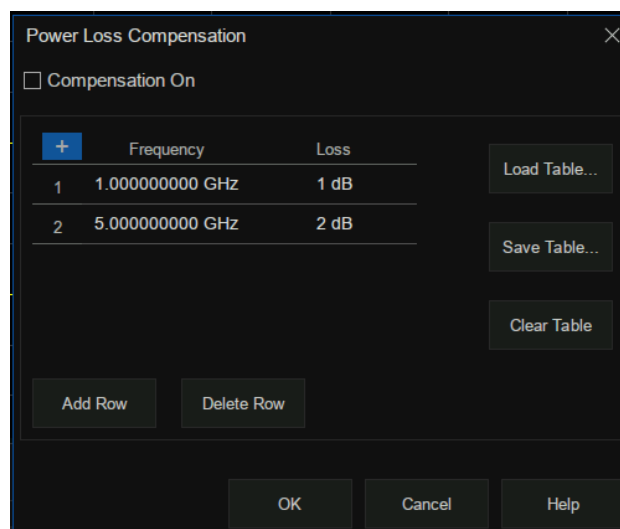

Figure 7-26 Set the interface

Power calibration operation steps:

1. Connect the port-under-test to a compatible power meter (Keysight U2000 series, R&S NRP series, etc..) and probe to ensure normal communication between the vector network analyzer and the power meter.
2. **Preset** vector network analyzer.
3. Set internal source output power, IF bandwidth, sweep points, test frequency band and other parameters.
4. Select **Cal** → **Power Cal** to enter the Settings screen.
5. Select the test channel and select the power output port.
6. Set parameters such as power offset, capacity limit, reading times, maximum iteration times, etc.
7. Click **Take Cal Sweep** to start the power output measurement.
8. Click **OK** to complete the calibration and exit the power calibration interface after the measurement is completed.

7.6 Receiver calibration

The vector network analyzer receiver power has been factory calibrated, but the factory calibration may not guarantee sufficient accuracy in every situation. The user can conduct a receiver power calibration before the test to improve the test accuracy. To ensure the calibration accuracy of the receiver, it is better to calibrate the power of the internal source before the calibration of the receiver.

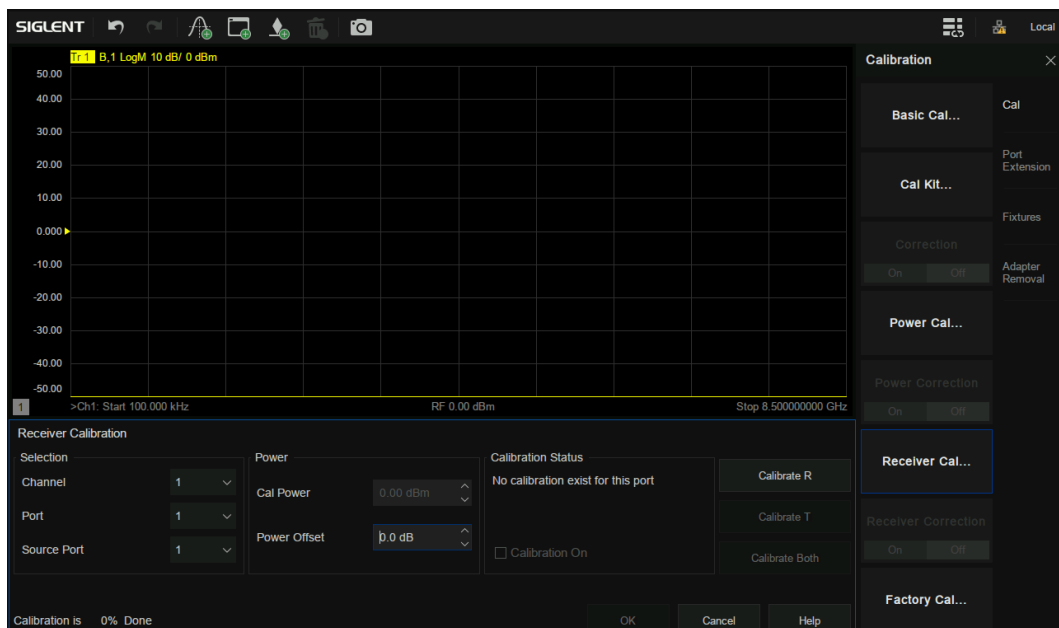

Figure 7-27 Receiver calibration setting interface

Operating steps:

1. **Preset** vector network analyzer.
2. Set internal source output power, IF bandwidth, sweep points, test frequency band, and other parameters.
3. Select **Cal** → **Receiver Cal** to enter the Settings screen.
4. Select the test channel, select the internal source output port, select the receiver port
5. Connect the two ports using an appropriate specification RF cable.
6. Set parameters such as power offset.
7. **Calibrate R** or **Calibrate T** or **Calibrate Both** can be clicked to begin receiver calibration.
8. Click **OK** to complete the calibration and exit the receiver calibration interface.

7.7 Port extension

Eliminating the errors of test fixturing can be a difficult task. The port extension function of a vector network analyzer is a good method to eliminate the error of test fixtures. The calibration of S parameters is usually carried out by the user at the plane where the RF cable is connected to the test fixture, typically a connector (SMA, N-type, etc..). The actual device to be tested is located in the test fixture. The device to be tested and the test fixture are generally connected by a microstrip line. As a result, the actual measurement plane of the device to be tested does not coincide with the calibration reference plane (the connector, as mentioned previously) which will introduce calibration errors.

After the S parameter calibration is performed, the reference plane can be extended to the specified measurement plane by simply adding the added microstrip line length, speed factor, loss, and other parameters in the setting interface, to carry out more accurate testing.

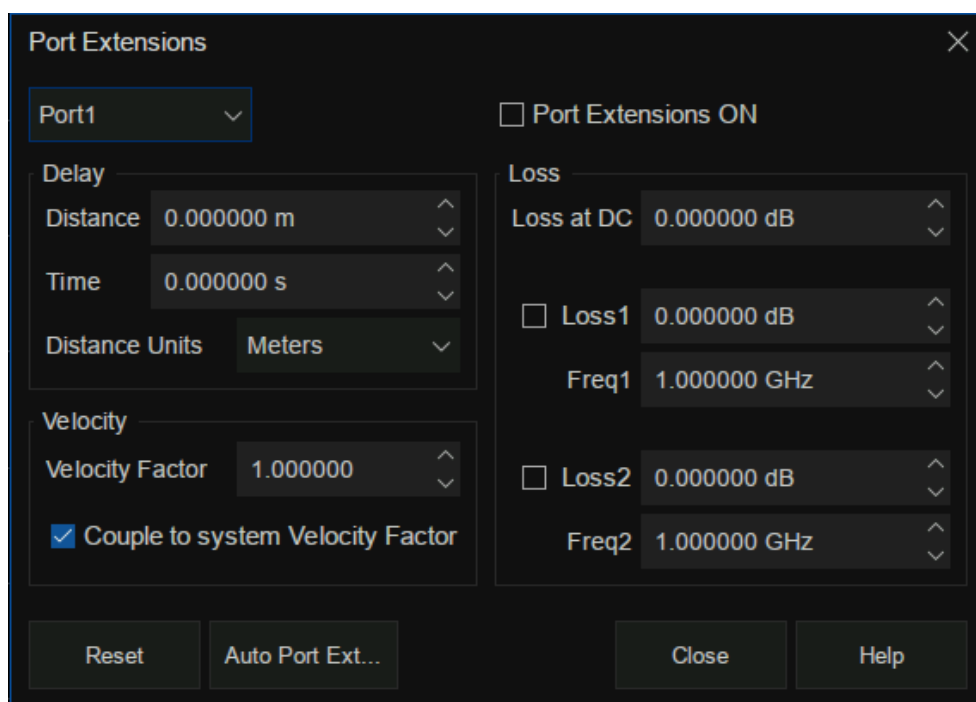

Figure 7-28 Port extension setting interface

Manual port extension operation steps:

1. Perform the appropriate calibration type (SOLT, etc..) on the associated cabling before entering Port Extensions.
2. Select **Cal** → **Port Extension** → **Port Extension** to enter the Settings screen.
3. Select the port that needs to be extended, the unit of length, and input the velocity coefficient.

The velocity coefficient is different, and the propagation time of electromagnetic waves on the transmission line is different. Input the length of the extended transmission line and the time will be calculated automatically.

If the transmission line has loss, the loss of the transmission line can be added, including DC and AC loss.

The AC loss can be selected as LOSS1 at the single-frequency point or LOSS1 and LOSS2 at the dual-frequency point.

Among them, the fitting algorithm for two forms of AC loss are:

Single-frequency point loss Loss1:

$$\text{Loss}(f) = \text{Loss1} * (f/\text{Freq1}) ^ 0.5$$

Dual-frequency point loss Loss1, Loss2:

Set the low frequency point to LOSS1 and the high frequency point to LOSS2,

$$\text{Loss}(f) = \text{Loss1} * (f/\text{Freq1}) ^ n, n = \lg [\text{abs}(\text{Loss1}/\text{Loss2})] / \lg (\text{Freq1}/\text{Freq2}).$$

4. Select whether to coupling to the system speed factor. If unchecked, the speed factor is set only for the specified port, and when checked, for all ports.
5. Check the **Port Extensions ON** button and the Port extension will take effect.

Manual port extensions require the user to manually enter the parameters of the extended transmission line, while automatic port extension does not require prior knowledge of the transmission line parameters. The calibration plane can be automatically extended to the actual reference plane by simply performing an open or short circuit calibration on the actual reference plane of the DUT. The automatic port extension function is not available in the following cases:

1. The sweep type is set to power sweep.
2. The frequency offset is set to on.
3. Waveguide transmission line port extension.

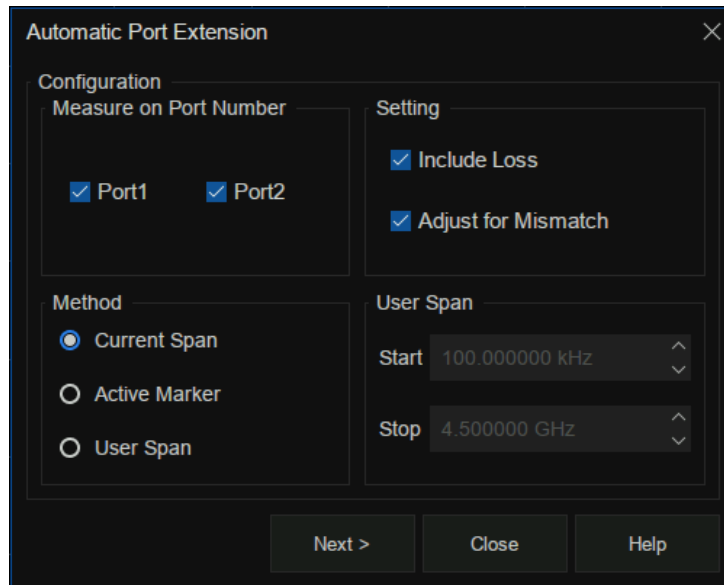

Figure 7-29 Automatic port extension setting interface

Automatic port extension operation steps:

1. Perform the appropriate calibration type (SOLT, etc..) on the associated cabling before entering Port Extensions.
2. Select **Cal** → **Port Extension** → **Auto Port Extension** to enter the Settings screen.
3. Select the port you want to extend. Refer to practical application scenarios, select **Port 1** or **Port 2**, or both ports.
4. Select the frequency span of the test.

There are three frequency spans to choose:

Current Span: The frequency span of the current interface setting.

Active Marker: The frequency point currently marked, In this case, **Loss2** can be ignored when +setting loss, only **Loss1** can be set.

User Span: Use the start and end frequencies set by the user.

5. Set whether the loss should be included or not. Select this box to automatically measure the loss in the transmission line and apply it to the calibration.
6. The mismatch adjustment option is only available when the inclusion loss item is selected. The mismatch increases the ripple on the trace lines of S11 and S22. If the ripple is large, the trace display of S11 and S22 will be greater than 0 dB, resulting in unstable values when S parameters are used. Selecting the adjustment mismatch item can increase the loss of the fixture so that the peak value of the ripple is below 0 dB. Although this will increase the error, it can prevent the numerical instability of S parameters from appearing when it is used.

7. Click **Next** to enter the measurement interface. Before the measurement, make sure that the device has been removed from the test fixture. In this way, the open-circuit measurement can be performed. Of course, the test fixture can also refer to the plane Short circuit to conduct the Short measurement. It can carry out one of the Open or Short measurements or simultaneously carry out the Open and Short measurements. When two measurements are used, the result will be the average of the two measurements, and the accuracy will be improved

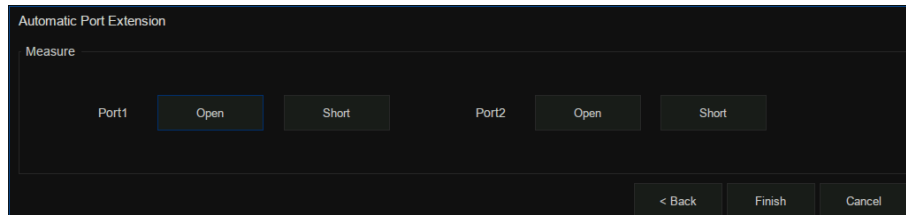

Figure 7-30 Automatic port extension calibration interface

7.8 Fixture measurement function

In addition to the port extension function, the vector network analyzer also provides several other functions for test fixtures:

1. Port match (2-port embedding)
2. Port impedance conversion
3. 2-port de-embedding
4. N port embed/ de-embed (port 4/6/8)
5. Differential port match
6. Differential port impedance conversion
7. Common port impedance conversion

Port match operation steps:

1. Ensure that the user has completed the S parameter calibration and obtained the S parameters of the DUT.
2. Select **Cal** → **Fixtures** → **Fixture Setup** → **Port Match** to enter the Settings screen.
3. By selecting the port and the parameter representation form of the matching module, the S2P file (AKA Touchstone file) of the matching module can be directly exported or the circuit model

of the matching module can be used. It supports 9 topologies which are combined by L, R, G, and C. It is necessary to manually set the parameter values of L, R, G, and C components. Checking the **Enable Port Matching On All Ports** tab means that all ports are matched. When the frequency range in the S2P file of the imported matching module is less than the frequency range set by the current interface, such as the **Enable Extrapolation** item is not checked, the system will extrapolate the S2P file by default. In other words, all the uncovered low-frequency parameters are replaced by the first point in the S2P file and all the uncovered high-frequency parameters are replaced by the last point in S2P file making the frequency range of the S2P file the same as the frequency range of the current interface. If you check the **Enable Extrapolation** tab, the system will interpolate the frequency points not covered by S2P so that the frequency range of the S2P file is the same as that of the current interface.

4. Click **Close** to complete the setting and click **Apply Fixtures** to ON to take effect.

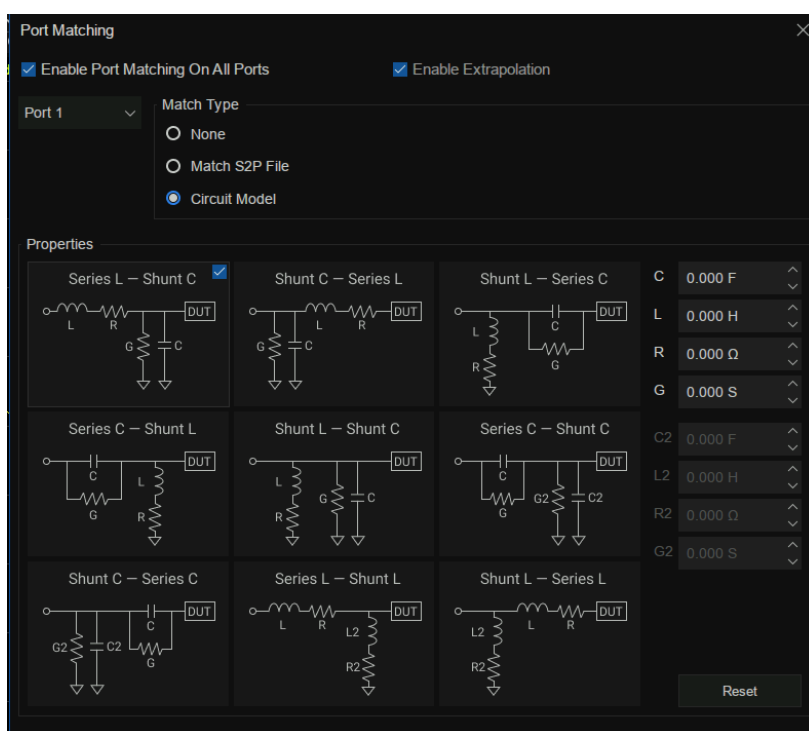

Figure 7-31 Port match

Port impedance conversion operation steps:

1. Ensure that the user has completed the S parameter calibration and obtained the S parameters of the DUT.
2. Select **Cal** → **Fixtures** → **Fixture Setup** → **Port Z** to enter the Settings screen.
3. Choose the port, the default system port characteristic impedance is 50 Ω, you can fill in the required resistance values in the R and JX columns, Then the S parameter displayed will be

automatically converted to the S parameter corresponding to the new characteristic impedance. Checking the **Enable Port Z Conversion On All Ports** tab means port matching is performed on all ports.

4. Click **Close** to complete the setting and click **Apply Fixtures** to ON to take effect.

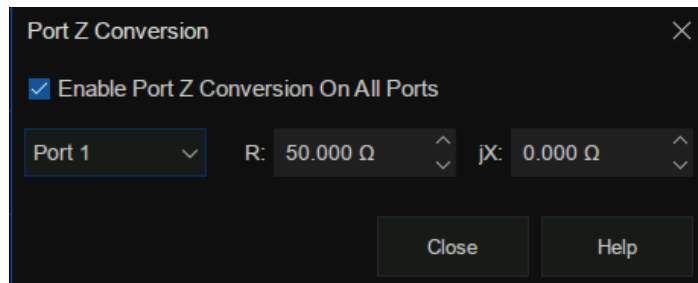

Figure 7-32-port impedance conversion

2-port de-embed operation steps:

1. Ensure that the user has completed the S parameter calibration and obtained the S parameters of the DUT.
2. Select **Cal** → **Fixtures** → **Fixture Setup** → **2-Port DeEmbed** to enter the Settings screen.
3. Select the port and select the form of de-embedding to import an S2P File. Click **User S2P File** to import the S parameter of the fixture part that needs to be removed.

Checking the **Enable De-Embedding On All Ports** tab means that all ports are de-embeddable.

When the frequency range in the S2P file of the imported matching module is smaller than the frequency range set by the current interface, if the **Enable Extrapolation** item is not checked, the system will extrapolate the S2P file by default. All the low-frequency parameters not covered are replaced by the first point in the S2P file, and all the high-frequency parameters not covered are replaced by the last point in the S2P file, making the frequency range of the S2P file the same as that of the current interface.

If you check the **Enable Extrapolation** tab, the system will interpolate the frequency points not covered by the S2P so that the frequency range of the S2P file is the same as that of the current interface.

4. Checking the **Reverse Adapter Ports** entry represents the part of the reverse connection that will need to be de-embedding. By default, the system reverses the imported S2P file.
5. Click **Close** to complete the setting and click **Apply Fixtures** to ON to take effect.

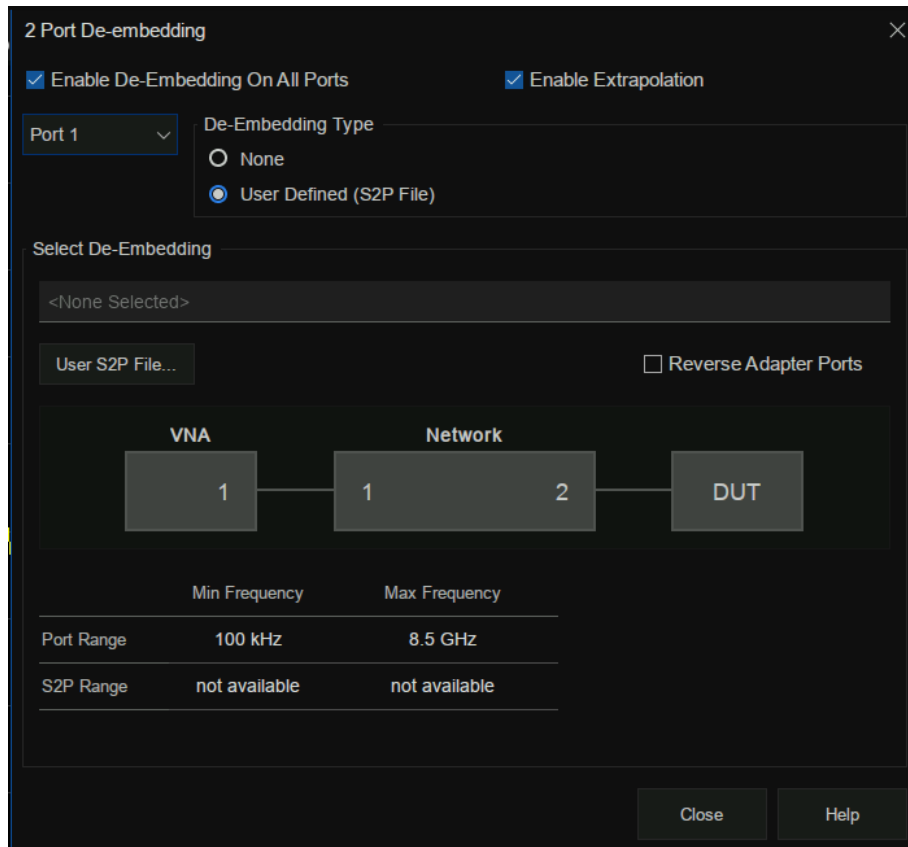

Figure 7-33 de-embedding interface

N-port embedding / de-embedding operation steps:

1. Ensure that the user has completed the S parameter calibration and obtained the S parameters of the DUT.
2. Select **Cal** → **Fixtures** → **Fixture Setup** → **N-Port DeEmbed** to enter the Settings screen.
3. Select the topology type.

There are 3 topology types:

A (using network 1)

B (using network 1 and 3)

C (using network 1, 2 and 4)

Select the port of the vector network analyzer in the VNA item, select the Network port configuration that needs to be embedded or de-embedded in the **Network**, and select the **Embed** operation or **De-embed** operation under each Network. Finally, load the S2P file corresponding to the operating network. Checking the **Enable 4/ 6/ 8-Port Embed / De-embed On All Ports** tab means that all ports are matched.

When the frequency range in the S2P file of the imported matching module is less than the frequency range set by the current interface, such as when the **Enable Extrapolation** item is not checked, the system will extrapolate the S2P file by default.

In other words, all the uncovered low-frequency parameters are replaced by the first point in the S2P file, and all the uncovered high-frequency parameters are replaced by the last point in the S2P file, making the frequency range of the S2P file the same as the frequency range of the current interface.

If you check the **Enable Extrapolation** tab, the system will interpolate the frequency points not covered by S2P so that the frequency range of the S2P file is the same as that of the current interface.

4. Click **Close** to complete the setting and click **Apply Fixtures** to ON to take effect.

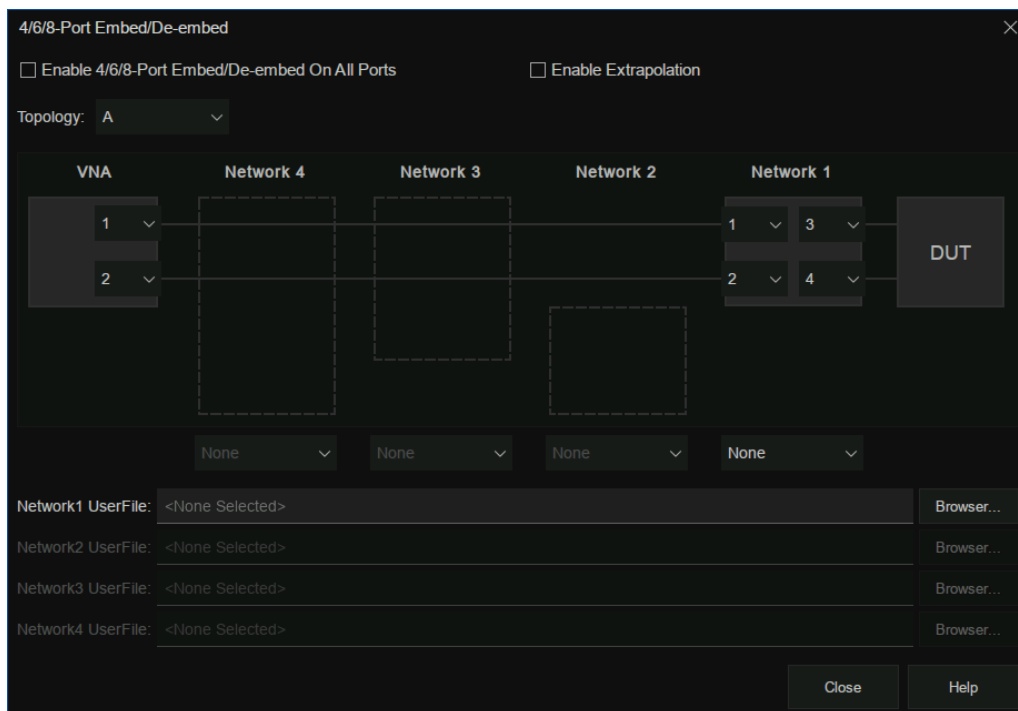

Figure 7-34 De-embedding interface

Differential port match operation steps:

1. Ensure that the user has completed the S parameter calibration and obtained the balance S parameters of the DUT.
2. Select **Cal** → **Fixtures** → **Fixture Setup** → **Differential Port Match** to enter the Settings screen.
3. By selecting the port and the parameter representation form of the matching module, the S2P file of the matching module can be directly imported or the circuit model of the matching module

can be used.

It is necessary to manually set the parameter values of L, R, G, and C components if the circuit model is used.

Checking the **Enable Differential Port Matching** tab means that all ports are matched.

When the frequency range in the S2P file of the imported matching module is less than the frequency range set by the current interface, the system will extrapolate the S2P file by default. In other words, all the uncovered low-frequency parameters are replaced by the first point in the S2P file and all the uncovered high-frequency parameters are replaced by the last point in the S2P file making the frequency range of the S2P file the same as the frequency range of the current interface.

4. Click **Close** to complete the setting and click **Apply Fixtures** to ON to take effect.

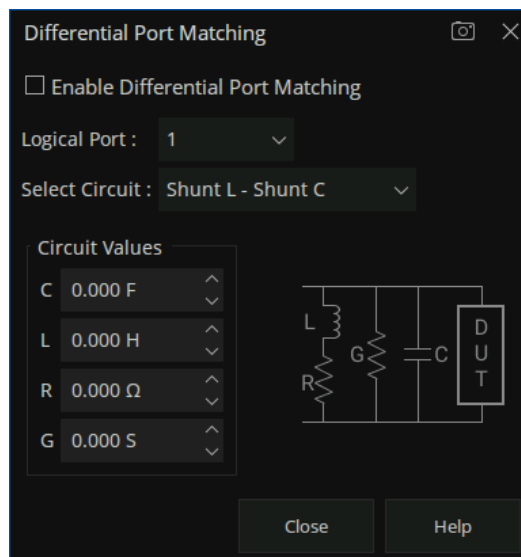

Figure 7-35 Differential port match

Differential and common port impedance conversion operation steps:

The operation of differential port impedance conversion and common port impedance conversion is similar to that of port impedance conversion, please refer to the instructions of the latter.

7.9 Adapter removal / insertion function

Adapters are often used when the network analyzer is used to test the DUT. The vector network analyzer provides the function of removing and inserting adapters. Before the function of removing and inserting adapters is enabled, the vector network analyzer needs to carry out full 2-port calibration.

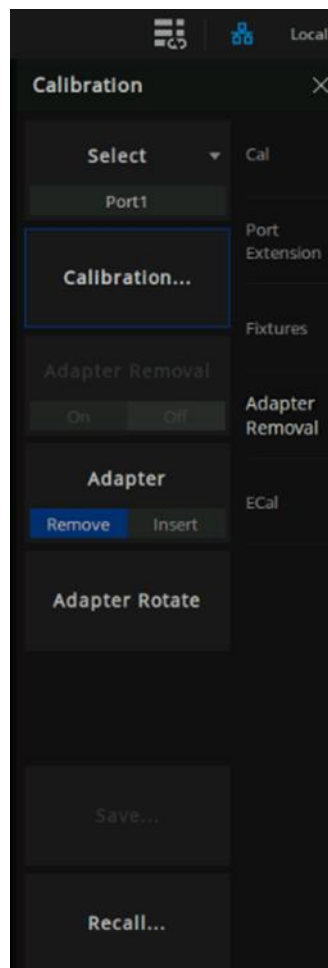

Figure 7-36 Adapter removal and insertion functions

Adapter removal operation steps:

1. Connect the test cable of the vector network analyzer to the adapter, and configure the parameters of the network analyzer. First, perform the full 2-port calibration.
2. Select **Cal** → **Adapter Removal** to go to the Settings screen and select **Remove** in the **Adapter** tab.
3. Remove the adaptor from the test cable, Select **Cal** → **Adapter Removal** → **Calibration** to enter the **Adapter Removal** configuration screen. Select the port connected to the adaptor to

be removed, select the calibration kit type, and select the polarity of the calibration kit. Click **Next** to connect the Open, Short and Load calibration elements in turn for full 1 port calibration.

4. Click **Finish** to complete the calibration and click Adapter Removal to ON to complete the Adapter Removal operation.

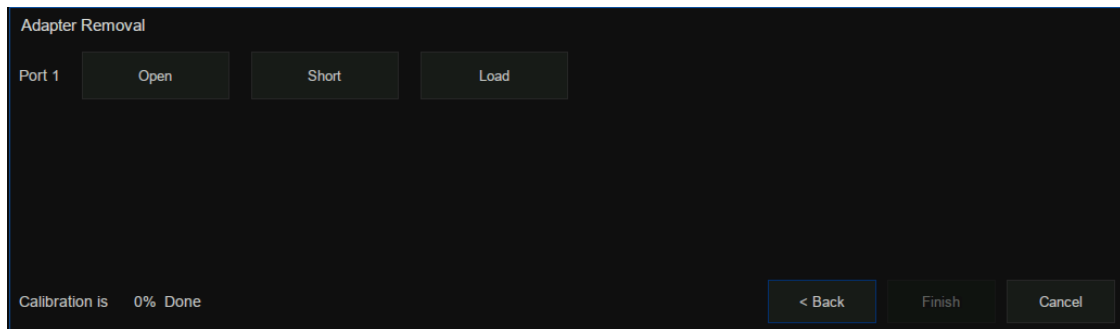

Figure 7-37 Adapter removal and insertion function calibration interface

Adapter insertion operation Steps:

1. Remove any test cables from the ports of the analyzer and perform a full 2-port calibration.
2. Select **Cal** → **Adapter Removal** to go to the Settings screen and select **Insert** in the **Adapter** tab.
3. Connect the adapter on the test cable, select **Cal** → **Adapter Removal** → **Calibration** to enter the **Adapter Removal** configuration screen. Select the port connected with the adaptor to be inserted, select the calibration kit model, select the polarity of the calibration kit, and click **Next** to connect the Open, Short, and Load calibration elements in turn for full 1 port calibration.
4. Click **Finish** to complete the calibration and click **Adapter Removal** to ON to complete the Adapter insertion operation.

“Adapter Rotate” is also known as the “equal exchange adapter and equal length adapter” calibration method. Before the unknown pass-through method was introduced, the switching adapter method was often used as a faster alternative to the more tedious adapter removal method.

7.10 ECal

7.10.1 ECal Overview

ECal is a new automatic calibration technology for vector network analyzers. Every ECal module contains electronic standards that are automatically switched into position during a measurement calibration. These electronic standards have been measured at the factory and the data stored within the memory of the ECal module. The analyzer uses this stored data, along with the measured data, to calculate the error terms for a measurement calibration. ECal offers the following advantages:

- The calibration process is simple. The electronic calibrator only needs to be connected to the VNA once to complete the test items required by the dual-port calibration, without the need for multiple calibration connections.
- A shorter time is required for calibration.
- There are fewer uncertain factors in the calibration process, and the probability of electronic calibration being affected by misoperation is reduced because there is no need for multiple connection processes.

Use ECal to perform calibration

1. Connect the USB port on the ECal module with the USB port on the front panel of VNA via a USB cable. the module indicates "READY". When you connect the module, the type of module, frequency range, and connector type are automatically recognized.
2. Connect a port on the ECal module to the test port to be calibrated.
3. Press Cal > ECal on the front panel to enter the ECal menu interface.

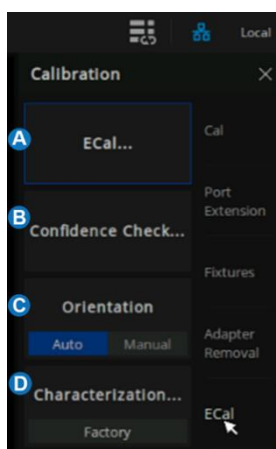

Figure 7-38 ECal menu

- A. ECal Config. Select the number of ports to calibrate. Then select the port number configuration.
- B. Confidence Check. Check the validity of Ecal calibration.
- C. Orientation. Select "Auto" (the default setting) the VNA automatically senses the model and direction in which an ECal module port is connected to the VNA ports. Select "Manual" to manually set the specified port.
- D. Characterization. View the characterization information stored in the ECal module

7.10.2 ECal Config

Press “Cal” on the front panel , Press Cal > ECal > ECal to enter the menu interface of ECal setting.

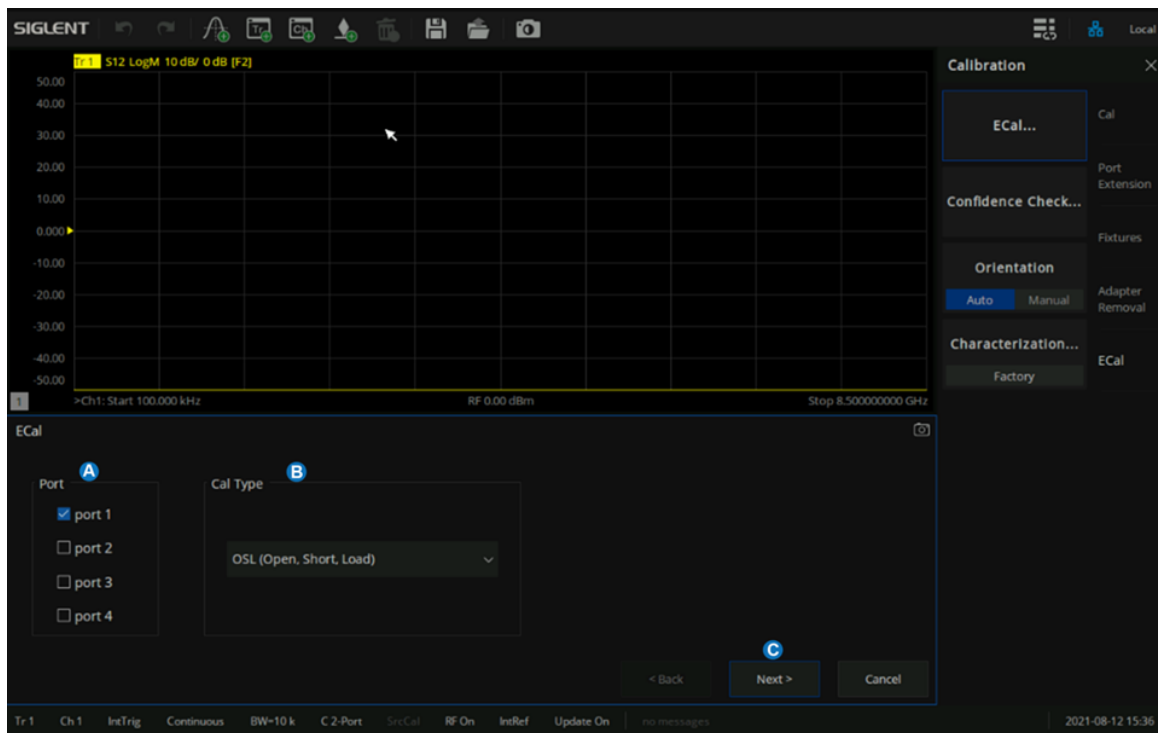

Figure 7-39 ECal config menu

- A. Select the number of ports to calibrate and configure the port number. Using ECal, you can perform 1-Port Reflection calibration, Full 2-Port calibration, Full 3-Port calibration, and Full 4-Port calibration.
- B. Select the Cal Type
- C. When “Orientation” is Auto, click “Next” to enter the automatic alignment directly. When “Orientation” is Manual, click “Next” to specify the calibration port and go to auto-calibration.

7.10.3 Confidence Check

1. Press “Cal” on the front panel, press Cal > ECal > Confidence Check to enter the menu interface of Confidence Check.

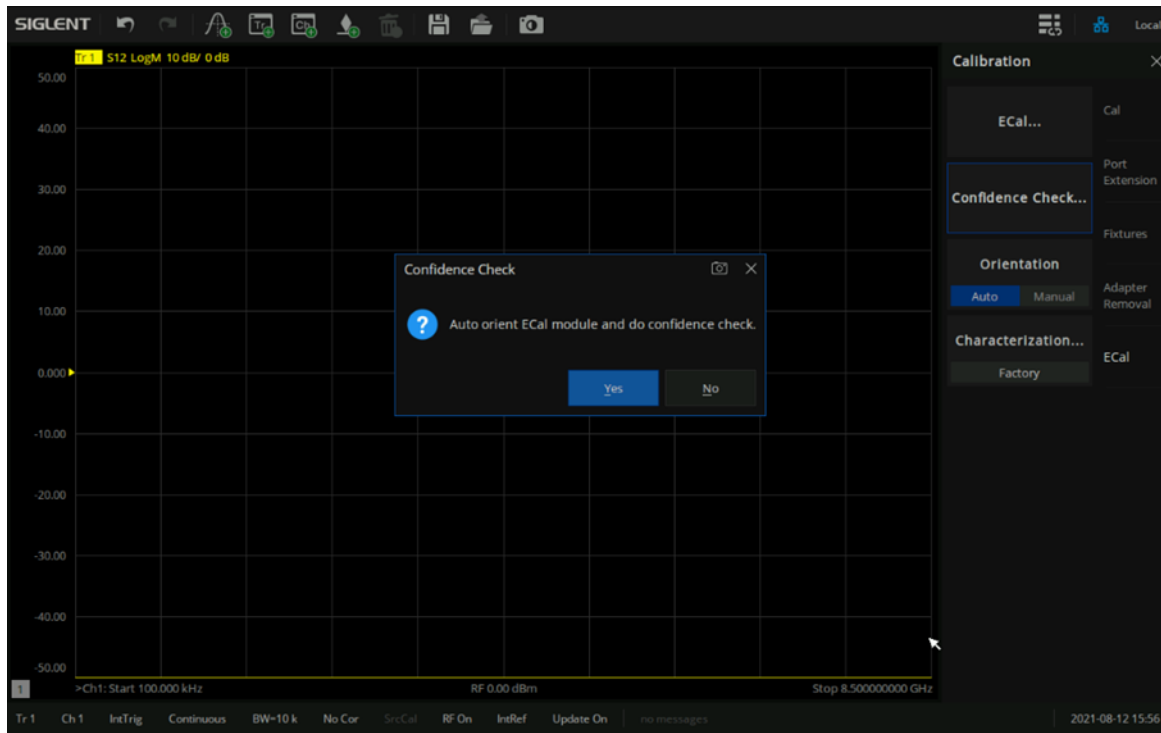

Figure 7-40 Confidence Check

2. Compare the data-trace with the memory trace and verify that the measurement is correct.
3. The steps to compare when both data and memory traces are displayed are as below:
 - a) Press “Math” on the front panel, Press “Math” > Memory > Math > Data + Memory.
 - b) Press “Scale” on the front panel, Press “Scale” > Scale > Auto Scale.
 - c) Determine if the differences between trace lines are acceptable.

7.10.4 Orientation

The ECal module automatically detects the connection between SNA's test ports and ECal module's ports. You can turn off this function to set ports manually.

Manual port setting procedure for Full 2-Port calibration

- Press "Cal" on the front panel, Press "Cal" > ECal > Orientation > Manual.
- Specify a test port of the VNA.
- Specify an ECal port for the port of the VNA you specified.

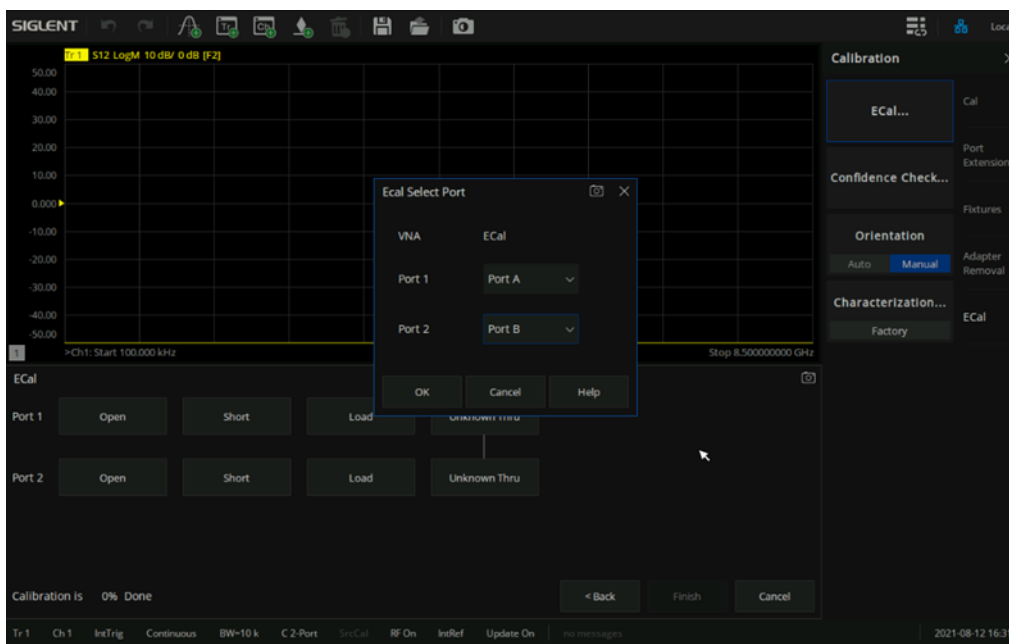

Figure 7-41 Manual port setting

7.10.5 Characterization

Press “Cal” on the front panel, press “Cal” > Cal > Characterization > Factory to view all the parameters of the stored Characterization in the ECal module.

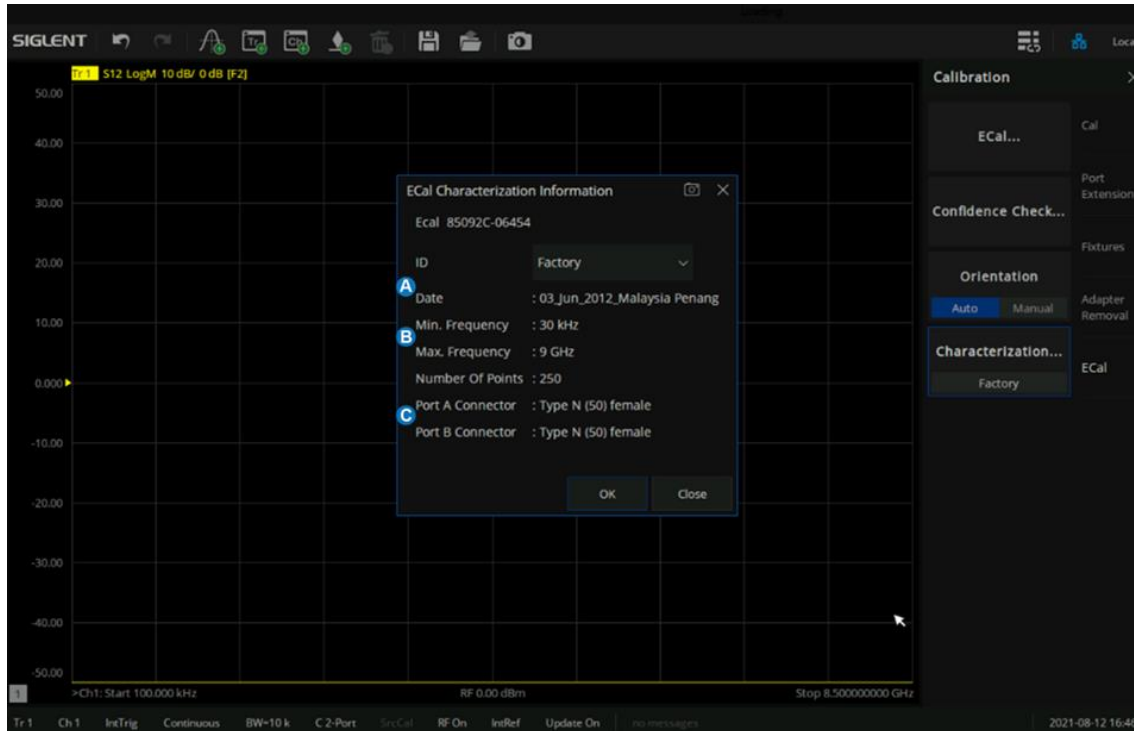

Figure 7-42 The factory information of Cal Kit

- A. The date when the characteristics were measured
- B. The stimulus conditions when the characteristics were measured
- C. The information of the Connector type

8 Data Analysis

8.1 Marker

The marker can display defined measurement data of traces. Each trace can set nine ordinary markers and one reference marker.

8.1.1 Ordinary marker:

Press the **Marker** button on the front panel, click **Add Marker** in the **Marker** submenu to create a marker, then set the required test frequency. If there are many markers on the trace, click **Select** to select the desired marker. After the marker is created, the measurement value of the marker will be displayed at the top right of the window, and the value format is the same as the format of the trace. We can click the **Delete Marker** command under the marker submenu to delete the marker and select the marker to delete from the pop-up menu. When a trace is deleted, all markers on the trace will be deleted. Click the **All Off** command under the **Marker** submenu or the **Marker Setup** submenu to delete all markers on the current trace.

8.1.2 Reference marker:

Press the **Marker** button on the front panel, click **Reference Marker** in the **Marker** submenu, make the **On** option selected then the **Reference Marker** will be created. By default, the **Reference Marker** is created at the location of the current ordinary **Marker**. If there is no ordinary **Marker** on the current trace, the **Reference Marker** will be created at the center of the trace. **Reference Markers** are denoted by an R. After creating a **Reference Marker**, set the **Reference Marker** as value discretization, fixed marker, and coupling, we can set the data format of **Reference Marker's** display value and view the **Reference Marker's** value in the marker table, but the **Reference Marker** cannot be set as a difference (delta) marker. Click **Reference Marker** in the **Marker** submenu, select the **Off** option to delete the **Reference Marker**.

8.1.3 Marker setting:

Press the **Marker** button on the front panel, set the current marker in the **Marker Setup** submenu, we can make the following settings for the currently selected marker:

1. **Difference (delta) display:**

The difference display mode is closed by default, to open the difference display mode, click the **Delta** to select the **On** option, then the marker's value will display the difference between the ordinary marker and the reference marker, and the marker's value is marked with " Δ ". If a reference marker has not been added to the trace, the reference marker will be automatically set on the trace. To display the absolute value of the marker, click the **Delta** again to select the **Off** option.

2. Value discretization:

The value discretization mode is closed by default. Due to the limited number of sampling points set on the trace, the data of other points except the sampling points are based on the interpolation value of the sampling point data, which is approximate to the actual data, not the real measured data. By setting the value discretization of the marker, the value of the marker can only be taken at the sampling point, which ensures that the marker's value is from the measurement data and not interpolated data. To open the value discretization mode, click the **Discrete** to select the **On** option, at this time, the data of the marker is only selected from the sampling points, when the coordinate value of the marker is not in the sampling point, the marker is automatically moved to the nearest sampling point. To turn off the value discretization, click the **Discrete** to select the **Off** option.

3. Fixed marker:

The fixed marker mode is closed by default. Fixed markers have a fixed excitation position (x-axis coordinate), its response value (Y-axis coordinate) will change according to the trace data update. To keep the fixed value of the marker unchanged, click the **Type** command to select the **Fixed** option, then the marker's value will keep the current value unchanged, and the marker does not move up or down with the trace update. To restore the marker real-time update, click the **Type** command again to select the **Normal** option.

4. Data format:

The newly created marker uses the current trace's data format by default. To change the data format of the marker, click the **Format** and select the corresponding data format in the pop-up menu. The following data formats are available:

- **Trace Default**
- **Log/Phase**
- **Lin/Phase**
- **Re/Im**
- **R+jx**
- **G+jB**
- **Lin Magnitude**
- **Phase**
- **SWR**
- **Delay**
- **Real**
- **Imaginary**

- **Log Magnitude**

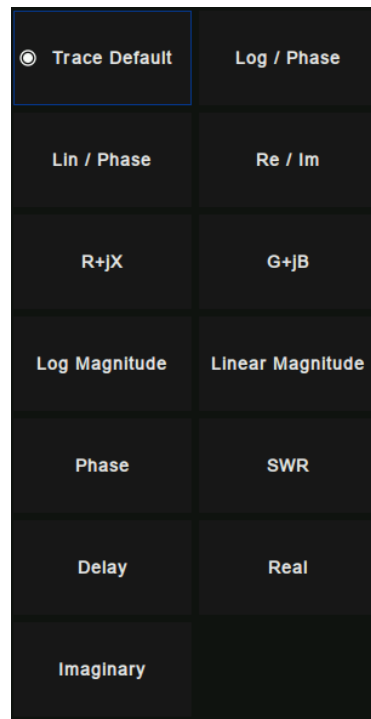

<input checked="" type="radio"/> Trace Default	Log / Phase
Lin / Phase	Re / Im
R+jX	G+jB
Log Magnitude	Linear Magnitude
Phase	SWR
Delay	Real
Imaginary	

Figure 8-1 Data format interface

5. Marker coupling:

The newly created marker turns off coupling by default. At this time, the marker is only set on a single trace, and the markers on different traces do not affect each other. If we need multiple markers on different traces to share settings, we can use the marker coupling function. Click the **Coupled** command, and select the range of the marker coupling in the pop-up menu for coupling operation. When the marker coupling mode is on, the markers of the same number and X-axis (such as frequency or time) on all traces in the coupling range share the settings, and the marker's setting on the current trace will be used by default. If the current marker is not in the coupling range, the marker with the same number on the trace with the smallest trace number is used.

Note: when the marker coupling mode is on, the marker on the trace within the coupling range will automatically move to the same X-axis coordinate.

6. Marker table:

The newly created marker closes the marker table by default. If we need to display all marker data in the form of a table, we can use the marker table function. Click the **Marker Table** to select the **On** state, a table will appear at the bottom left to display all marker's values, click

the **Marker Table** again to select the **Off** option to close the marker table.

8.1.4 Marker function:

Press the **Marker** button on the front panel, use the current marker to set the excitation in the **Marker Function** submenu. Use the currently selected marker to achieve the following functions:

- **Marker → Start:**

Set the current marker position (X coordinate) as the sweeping starting point.

- **Marker → Stop:**

Set the current marker position (X coordinate) as the sweeping ending point.

- **Marker → Center:**

Set the current marker position (X coordinate) as the sweeping center point. Note: When using this command, the sweeping boundary value far from the current marker will be changed to reduce the sweeping range, so that the marker position becomes the new sweeping center point.

- **Marker → Span:**

This function is only available when the current marker is a difference (delta) marker. Set the sweeping range between the current marker position and the reference marker position (x coordinate).

- **Marker → Ref Level:**

Set the response value (Y coordinate) of the current marker to the reference level of the current trace.

- **Marker → Delay:**

Referring to the phase slope of the current marker position, the line length is adjusted to the receiver input, this function helps to smooth the phase trace around the current marker. For the equipment without constant group delay in the measurement frequency span, another electrical delay adjustment is needed. This function can be used to measure electrical length or deviation from a linear phase. This function requires the measured phase difference, so it is only suitable for proportional measurements.

- **Marker → CW Freq:**

Set the current marker position (frequency) to continuous wave (CW) frequency. This function requires the x-axis field of the current marker, otherwise, it is invalid. After changing CW frequency with this command, enable power or CW sweeping to apply the changed CW

frequency setting.

- **Marker → SA:**

If the current mode is SA, the center frequency is set to the current marker value; If it is not SA mode, then switch to SA mode, set the center frequency to the current marker value, and set span to 10 times of the previous step freq.

8.1.5 Marker search function:

The marker can be used to search the maximum value, minimum value, peak value, and target value of the trace in the specified search domain. It can also search for multi-peak value, multi-target, bandwidth filtering, and band-stop filtering.

8.1.5.1 Search domain:

The search domain is the frequency span included in a marker search operation. Each marker has an independent search domain, and the default is full span, which is the same as the current sweep range. The X coordinate movement range of the marker is limited in its search domain. The user can set up up to 16 custom search domains. The search domains are independent of each other and allowed to overlap. The search field can be set for each marker, and multiple markers are allowed to share one search domain.

To set a custom search domain, press the **Search** button on the front panel, click the **Domain** command in the **Search** submenu, and click the **Add** command in the pop-up menu. Then click the **Domain** command again, click and select the newly created custom search domain in the pop-up menu, and enter the required values in the **Start** and **Stop** text boxes below the domain command. When the search domain of the current marker is not full span, the indicator "Δ" will appear on the x-axis to identify the search domain of the current marker. To delete a user-defined search domain, click the **Domain** command, select the search domain to be deleted in the pop-up menu, then click the **Domain** command again, and then click **Delete** in the pop-up menu. If the search domain of the marker is deleted, its search domain is automatically set to full span.

8.1.5.2 Max and min search:

Press the **Search** button on the front panel and click the **Max Search** command in the **Search** submenu to move the current marker to the maximum response value in the search domain. Press the **Search** button on the front panel and click the **Max Search** command in the **Search** submenu to move the current marker to the maximum response value in the search domain. Click the **Min Search** command to move the current marker to the minimum response value

in the search domain.

Peak search:

Press the **Search** button on the front panel to search the peak in the **Peak** submenu. Before searching for the peak value, the effective peak value to be searched should be defined first. The validity of the peak value is determined by the search domain, peak polarity, threshold, and deviation:

Peak polarity:

According to the polarity, the peaks are divided into two categories:

Positive and negative. The positive peak value refers to situations where the measured value is greater than the measured value at both ends of a span, and the negative peak value refers to the peak value that the measured value is less than the measured value at both ends of a span. Click the **Peak Polarity** command in the **Peak** submenu to select the peak polarity. The **Both** option means that both positive and negative peaks are regarded as valid peaks for the search.

Threshold:

For the positive peak, only the peak whose measured value is greater than the threshold is considered valid; for the negative peak, only the peak whose measured value is less than the threshold is considered valid; when the polarity of the peak is set to **Both**, the threshold is not used as the basis for judging the validity of the peak. To set the threshold, click the **Threshold** command in the **Peak** submenu to enter the required value.

Deviation:

The deviation value of peak value refers to the smaller difference between the measured value of peak value and the measured value of an adjacent peak with the opposite polarity. Only the peak value with a deviation greater than the rated value is considered valid. To set the deviation value, click the **Excursion** command in the **Peak** submenu to enter the required value.

After determining the effective peak range and search domain, the peak search can be started. There are several peak searching modes available:

- Using the **Peak Search** command in the **Peak** submenu, the peak with the largest measured value among the effective positive peaks or the peak with the smallest measured value among the effective negative peaks will be included in the search according to the peak polarity setting. If the current peak polarity is set to **Both**, the peak with the largest measured value among the effective positive peaks is searched.
- Use the **Peak Right** → **Search** command in the **Peak** submenu to search the nearest effective peak from the current marker position to the right.

- Use the **Peak Left ← Search** command in the **Peak** submenu to search the nearest effective peak from the current marker position to the left.
- Use the **Next Peak Search** command in the **Peak** submenu to search for the effective positive peak value next lower than the current marker measurement value or the effective negative peak value next higher than the current marker measurement value according to the peak polarity setting. If the current peak polarity is set to **Both**, the effective peak next lower than the current vernier measurement value is searched.

8.1.5.3 Target search:

Press the **Search** button on the front panel to search the target in the **Target** submenu. Before searching the target, set the target value and transition type:

Target value:

The target value refers to the response value to search (Y coordinate). If the response value of a point on the trace is equal to the target value, then the point is the target point to search. To set the target value, click the **Target Value** command in the **Target** submenu to enter the required value.

Transition type:

The target points are divided into two types, positive and negative. The positive target conversion type means that the measured value on the right side of the target point is greater than that on the left side, while the negative target conversion type means that the measured value on the right side of the target point is less than that on the left side. Click the **Transition** command in the **Target** submenu to select the conversion type to search for. The **Both** option means that both positive and negative target conversion types are regarded as valid targets.

After the target value, transition type and search domain are determined, the target search can be started. The vector network analyzer has the following target search modes:

- Use the **Target Search** command in the **Target** submenu to search for the nearest effective target from the current marker position to the right. When no effective target can be found from the right, search from the starting point of the search domain to the right.
- Use the **Target Right → Search** command in the target submenu to search the nearest valid target from the current marker position to the right.
- Use the **Target Left ← Search** command in the **Target** submenu to search the nearest valid target from the current marker position to the left.

8.1.5.4 Multi-peak search:

Press the **Search** button on the front panel to search for multiple peaks in the **Multi Peak & Target** submenu. Before searching for multiple peaks, you need to set the threshold, deviation, and peak polarity in the **Peak Threshold**, **Peak Excursion** and **Peak Polarity** commands in the submenu to define the peak validity. After setting the above parameters, click the **Multi Peak Search** command to search all effective peaks from the starting point of the search domain to the right, and mark the peaks with a marker. Since there can only be 9 common markers on a single trace, only the first 9 effective peaks can be found when there are many effective peaks.

8.1.5.5 Multi-target search:

Press the **Search** button on the front panel to search for multiple targets in the **Multi Peak & Target** submenu. Before multi-target search, you need to set the target value and conversion type in the **Target Value** and **Transition** submenu to define the target validity. After setting the above parameters, click the **Multi-Target Search** command to search all valid targets from the starting point of the search domain to the right, and mark the searched targets with a marker. Since there can only be 9 common markers on a single trace, only the first 9 valid targets can be found when there are many valid targets.

Tracking search:

When using the above search function, the marker position is only based on the current sweeping result, and will not be dynamically updated with the trace update after the search. Tracking mode can be used to update search results with trace data. Press the **Search** button on the front panel, click the **Tracking** command, and select the search type in the pop-up menu; the search in the tracking mode uses the search parameter settings in the above search.

8.1.5.6 Bandwidth search

The bandwidth search is a function for determining the bandwidth of the trace, center frequency, cut-off points (on the higher frequency and the lower frequency sides), Q and insertion loss based on the position of the active marker or peak marker.

Press the **Search** button on the front panel to search the bandwidth in the **Bandwidth** submenu. Click **BW Search Enable** and select the **On** option to search the bandwidth. After the bandwidth search is completed, a small triangle will be used to mark the cut-off frequency

of the trace, and the bandwidth, center frequency, cut-off frequency, quality factor, and insertion loss will be displayed in the upper right corner of the window. To turn off the bandwidth search, click **BW Search Enable** again and select the **Off** option. You can set whether to alarm when the bandwidth search fails in the **Sound On Fail** command.

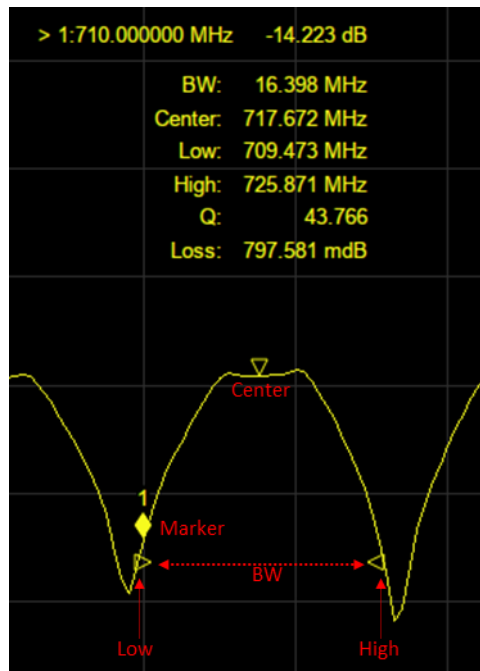

Figure 8-2 Bandwidth search example

8.1.5.7 Notch search

The notch search function is used to obtain the bandwidth, center frequency, cutoff points (high-frequency side and low-frequency side), Q and insertion loss of a trace based on the active marker or peak marker position. The notch search function starts from the left side of the active marker position and ends when points that meet the conditions are found.

Press the **Search** button on the front panel to search the band stop in the **Notch** submenu. Click the **Notch Search Enable** command and select the **On** option to perform the band stop search. After the band stop search is completed, a small triangle will be used to mark the cut-off frequency of the trace, and the bandwidth, center frequency, cut-off frequency, quality factor, and insertion loss will be displayed in the upper right corner of the window. To turn off the band stop search, click the **Notch Search Enable** command again and select the **Off** option. You can set whether to alarm when the band stop search fails in the **Sound On Fail** command.

The following values are displayed for Bandwidth and Notch Search:

Bandwidth (BW): The difference in frequency between the higher frequency cut-off and lower

frequency cut-off points (High - Low).

Center frequency (Center): Frequency at the middle point between the lower frequency cut-off and higher frequency cut-off points. $(\text{High} + \text{Low})/2$.

Lower frequency cut-off point (Low): Lower frequency of 2 measurement points, both separated by the defined bandwidth / notch value from the active marker position.

Higher frequency cut-off point (High): Higher frequency of 2 measurement points, both separated by the defined bandwidth / notch value from the active marker position.

Q: Ratio of Center Frequency to Bandwidth (Center Frequency / Bandwidth).

Insertion loss (loss): The measured value of the position of the center frequency at the time the bandwidth/notch search is executed.

8.2 Mathematical operation

The vector network analyzer supports saving the current data-trace in memory. It can perform four kinds of mathematical operations on the current data-trace and memory trace. In addition, it can calculate and display statistical data (mean, standard deviation, and peak-peak) on the data-trace. In addition, through the built-in formula editor, you can use multiple types of traces from the same or different channels to build custom formulas. When the mathematical operation with memory trace needs to be carried out, the current data needs to be stored in memory first. Click **Data** → **Memory** to complete the storage operation. In the **Display** menu bar, you can select three display modes: Display data-trace only, display memory trace and display data-trace and memory trace at the same time. The four mathematical operations of data-trace and memory trace are as follows, in which the values on data-trace and memory trace are linear:

- Data/Memory:

Divide the measured data by the data in the stored trace. This function can be used to calculate the ratio of two traces (such as calculating gain or attenuation), which can also be regarded as the normalization operation of test data.

- Data*Memory:

The current measurement data is multiplied by the data in memory.

- Data+Memory:

Current measurement data plus data in memory.

- Data–Memory:

Current measurement data minus data in memory. For example, you can use this function to store measured data, The error is then subtracted from the DUT measurement.

8.3 Conversion

The vector network analyzer supports parameter conversion, which can convert the S parameter of the current trace to the required parameter mode. The vector network analyzer supports the following 8 conversion types.

- Z-Reflect: Impedance in reflection measurement Z_r .

$$Z_r = Z_{0a} \times \frac{1 + S_{aa}}{1 - S_{aa}}$$

- Z-Transmit: Impedance in transmission measurement Z_t .

$$Z_t = \frac{2 \times \sqrt{Z_{0a} \times Z_{0b}}}{S_{ab}} - (Z_{0a} + Z_{0b})$$

- Z-Trans-Shunt: Impedance in parallel transmission Z_t .

$$Z_t = \frac{1}{Y_t}$$

- Y-Reflect: Reflection measurement admittance Y_r .

$$Y_r = \frac{1}{Z_r}$$

- Y -Transmit: Admittance in transmission measurement Y_t .

$$Y_t = \frac{1}{Z_t}$$

- Y -Trans-Shunt: Admittance in parallel transmission Y_t .

$$Y_{01} = \frac{1}{Z_{01}}$$

$$Y_{02} = \frac{1}{Z_{02}}$$

$$Y_t = \frac{2 \times \sqrt{Y_{01} \times Y_{02}}}{S_{ab}} - (Y_{01} + Y_{02})$$

- 1/S: Reciprocal of S parameter.
- Conjugation: Convert the measured value to a complex conjugate number.

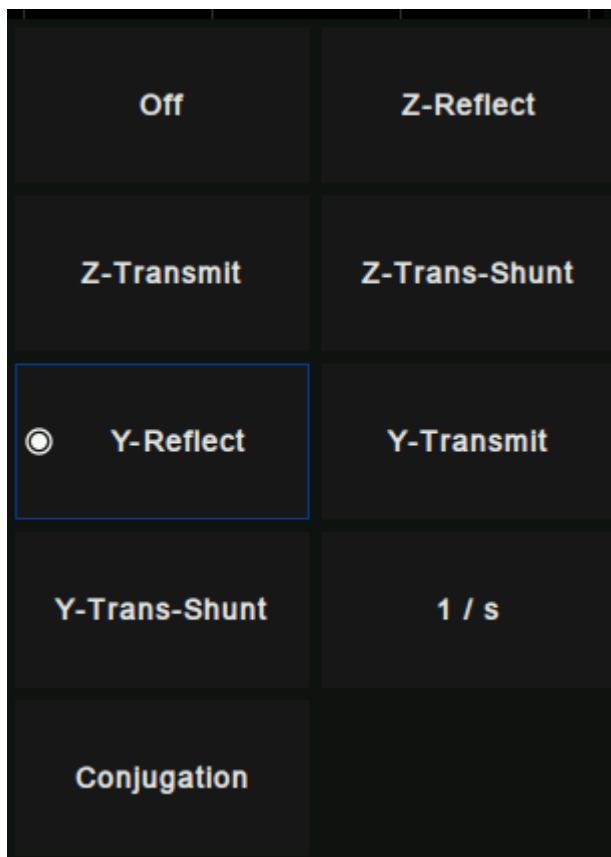

Figure 8-3 Parameter conversion type

When both the fixture simulation measurement function and the port impedance function are in the “on” state, the system will use the value set in the port impedance conversion. In other cases, the system Z_0 (preset value: 50Ω) will be used. The operation steps for selecting the conversion type are as follows:

1. Click **Math** → **Analysis** → **Conversion** enter the selection interface.
2. Select the corresponding conversion type, effective immediately.

8.4 Equation editor

In the equation editor, we can input the algebraic formulas of standard mathematical operators and functions, and reference the data available in the vector network analyzer. After a valid formula is entered and enabled, the working trace will be displayed as the result of the set formula and updated in real-time.

For example, enter the formula $S_{21}/(1 - S_{11})$. The trace is calculated by dividing each S_{21} data point by 1 and subtracting the value of the corresponding S_{11} data point. For a 201 point sweep, the calculation is repeated 201 times, once per point. In addition, suppose that the vector network analyzer is required to measure the directivity of a 3-port device to be tested, and the directivity is not the measurement parameter of the vector network analyzer, then the formula editor can be used to complete the measurement, and the result is the sum and difference of the traces in logarithmic amplitude format, that is $S_{12} + S_{23} - S_{13}$. Because the formula editor operates on linear complex data, the actual required formula is $S_{12} * S_{23} / S_{13}$.

Finally, the vertical axis format is set to logarithmic amplitude for display. The operation steps of the equation editor are as follows:

1. Click **Math** → **Analysis** → **Equation Editor** enter the equation editor interface.

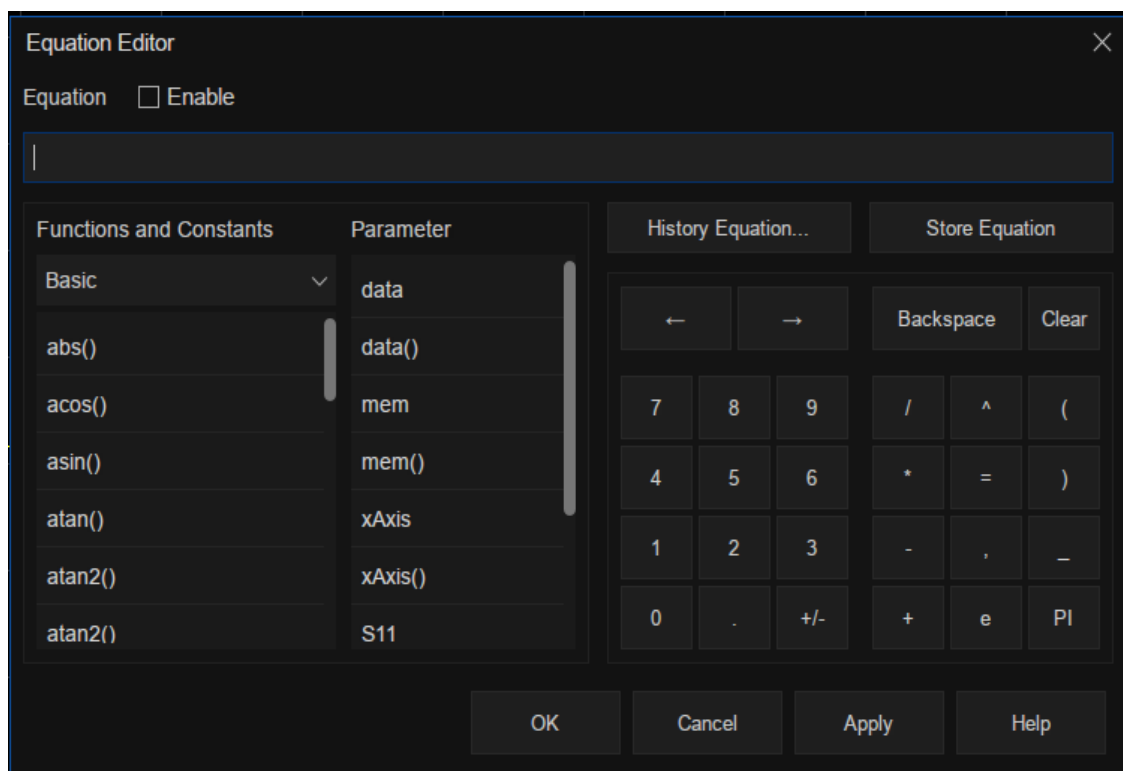

Figure 8-4 Formula editor interface

2. In the formula edit box, enter functions, operators, and data to form the formula.
3. After setting the formula, click OK to exit the formula editing interface and click the **Equation** status to On to take effect.

Introduction to formula editor interface:

- **Enable:** Select the box to enable the currently entered formula, and clear the box to disable the currently edited formula. If the data traces used are from other channels instead of formula traces, these channels must have the same number of data points to be valid channels.
- **Functions and Constants:** It stores some commonly used functions and constants, as well as other functions set by the system.
- **Parameter:** Select the items that need to be measured only from the working channel.
- **History Equation:** Used to save previously-stored formulas.
- **Store Equation:** Store the current input formula to facilitate subsequent use.
- **←:** Move the cursor to the left without clearing the characters.
- **→:** Move the cursor to the right without clearing the character.
- **Backspace:** Clear the character while moving the marker to the left.
- **Clear:** Clear the currently entered formula.
- **Numbers, operators, and constants:** Numbers, common operators, and constants.

Description of functions and constants in formula editor:

Common functions	Description
Abs (complex a)	Returns the $\sqrt{a.re^2+a.im^2}$
Acos (scalar a)	Returns the arc cosine of a in radians
Asin (scalar a)	Returns the arc sine of a in radians
Atan (scalar a)	Returns the arc tangent of a in radians
atan2 (complex a)	Returns the phase of a = (re, im) in radians
atan2 (scalar a, scalar b)	Returns the phase of (a, b) in radians
Conj (complex a)	Returns the conjugate of a
Cos (complex a)	Takes a in radians and returns the cosine

Cpx (scalar a, scalar b)	Returns a complex value (a+ib) from two scalar values
Exp (complex a)	Returns the exponential of a
Im (complex a)	Returns the imaginary part of a as the scalar part of the result (zeroes the imaginary part)
Ln (complex a)	Returns the natural logarithm of a
log10 (complex a)	Returns the base 10 logarithm of a
Mag (complex a)	Returns $\sqrt{a.re*a.re+a.im*a.im}$
Phase (complex a)	Returns $\text{atan2}(a)$ in degrees
Pow (complex a, complex b)	Returns a to the power b
Re (complex a)	Returns the scalar part of a (zeroes the imaginary part)
Sin (complex a)	Takes a in radians and returns the sine
Sqrt (complex a)	Returns the square root of a, with phase angle in the half-open interval $(-\pi/2, \pi/2]$
Tan (complex a)	Takes a in radians and returns the tangent

Constant	
e	2.71828182845904523536
PI	3.14159265358979323846

Advanced function	Description
A (complex a, complex b, complex c, complex d)	F11 conversion = $((1+a)*(1-d) + b*c)/(2*b)$
A (scalar i, scalar j)	returns A(Sii, Sji, Sij, Sjj)
B (complex a, complex b, complex c, complex d)	F12 conversion = $Z0*((1+a)*(1+d) - b*c)/(2*b)$
B (scalar i, scalar j)	returns B(Sii, Sji, Sij, Sjj)
C (complex a, complex b, complex c, complex d)	F21 conversion = $(1/Z0)*((1-a)*(1-d)-b*c)/(2*b)$

C (scalar i, scalar j)	returns C(Sii, Sji, Sij, Sjj)
D (complex a, complex b, complex c, complex d)	F22 conversion = $((1-a)*(1+d) + b*c)/(2*b)$
D (scalar i, scalar j)	returns D(Sii, Sji, Sij, Sjj)
H11 (complex a, complex b, complex c, complex d)	H11 conversion = $Z0*((1+a)*(1+d) - b*c)/((1-a)*(1+d) + b*c)$
H11 (scalar i, scalar j)	returns H11(Sii, Sji, Sij, Sjj)
H12 (complex a, complex b, complex c, complex d)	H12 conversion = $2*c/((1-a)*(1+d) + b*c)$
H12 (scalar i, scalar j)	returns H12(Sii, Sji, Sij, Sjj)
H21 (complex a, complex b, complex c, complex d)	H21 conversion = $-2*b/((1-a)*(1+d) + b*c)$
H21 (scalar i, scalar j)	returns H21(Sii, Sji, Sij, Sjj)
H22 (complex a, complex b, complex c, complex d)	H22 conversion = $(1/Z0)*((1-a)*(1-d) - b*c)/((1-a)*(1+d) + b*c)$
H22 (scalar i, scalar j)	returns H22(Sii, Sji, Sij, Sjj)
Kfac (complex a, complex b, complex c, complex d)	k-factor = $(1 - \text{abs}(a)^2 - \text{abs}(d)^2 + (\text{abs}(a*d - b*c)^2)/(2*\text{abs}(b*c)))$
Kfac (scalar i, scalar j)	returns kfac(Sii, Sji, Sij, Sjj)
MAPG (complex a, complex b, complex c, complex d)	maximum available power gain = $\text{abs}(b/c)*(\text{kfac}(a,b,c,d) - \text{sqrt}(\text{kfac}(a,b,c,d)^2 - 1))$
MAPG (scalar i, scalar j)	Returns MAPG(Sii, Sji, Sij, Sjj)
MSG (complex a, complex b, complex c, complex d)	maximum stable power gain = $\text{abs}(b)/\text{abs}(c)$
MSG (scalar i, scalar j)	Returns MSG(Sii, Sji, Sij, Sjj)
mu1 (complex a, complex b, complex c, complex d)	μ -factor = $(1 - \text{abs}(a)^2) / (\text{abs}(d - \text{conj}(a)) * (\text{abs}(d - b*c)) + \text{abs}(b*c))$
mu1 (scalar i, scalar j)	Returns mu1(Sii, Sji, Sij, Sjj)
mu2 (complex a, complex b, complex c, complex d)	μ -factor = $(1 - \text{abs}(d)^2) / (\text{abs}(a - \text{conj}(d)) * (\text{abs}(a - b*c)) + \text{abs}(b*c))$

mu2 (scalar i, scalar j)	Returns mu2(Sii, Sji, Sij, Sjj)
T11 (complex a, complex b, complex c, complex d)	T11 conversion = $-(a*d - b*c)/b$
T11 (scalar i, scalar j)	Returns T11(Sii, Sji, Sij, Sjj)
T12 (complex a, complex b, complex c, complex d)	T12 conversion = a/b
T12 (scalar i, scalar j)	Returns T12(Sii, Sji, Sij, Sjj)
T21 (complex a, complex b, complex c, complex d)	T21 conversion = $-d/b$
T21 (scalar i, scalar j)	Returns T21(Sii, Sji, Sij, Sjj)
T22 (complex a, complex b, complex c, complex d)	T22 conversion = $1/b$
T22 (scalar i, scalar j)	Returns T22(Sii, Sji, Sij, Sjj)
Y11 (complex a, complex b, complex c, complex d)	Y11 conversion = $(1/Z0)*((1-a)*(1+d) + b*c)/((1+a)*(1+d) - b*c)$
Y11 (scalar i, scalar j)	Returns Y11(Sii, Sji, Sij, Sjj)
Y12 (complex a, complex b, complex c, complex d)	Y12 conversion = $(1/Z0)*(-2*c)/((1+a)*(1+d) - b*c)$
Y12 (scalar i, scalar j)	Returns Y12(Sii, Sji, Sij, Sjj)
Y21 (complex a, complex b, complex c, complex d)	Y21 conversion = $(1/Z0)*(-2*b)/((1+a)*(1+d) - b*c)$
Y21 (scalar i, scalar j)	Returns Y21(Sii, Sji, Sij, Sjj)
Y22 (complex a, complex b, complex c, complex d)	Y22 conversion = $(1/Z0)*((1+a)*(1-d) + b*c)/((1+a)*(1+d) - b*c)$
Y22 (scalar i, scalar j)	Returns Y22(Sii, Sji, Sij, Sjj)
Z11 (complex a, complex b, complex c, complex d)	Z11 conversion = $Z0*((1+a)*(1-d) + b*c)/((1-a)*(1-d) - b*c)$
Z11 (scalar i, scalar j)	Returns Z11(Sii, Sji, Sij, Sjj)
Z12 (complex a, complex b, complex c, complex d)	Z12 conversion = $Z0*(2*c)/((1-a)*(1-d) - b*c)$

Z12 (scalar i, scalar j)	Returns Z12(Sii, Sji, Sij, Sjj)
Z21 (complex a, complex b, complex c, complex d)	Z21 conversion = $Z0*(2*b)/((1-a)*(1-d) - b*c)$
Z21 (scalar i, scalar j)	Returns Z21(Sii, Sji, Sij, Sjj)
Z22 (complex a, complex b, complex c, complex d)	Z22 conversion = $Z0*((1-a)*(1+d) + b*c)/((1-a)*(1-d) - b*c)$
Z22 (scalar i, scalar j)	Returns Z22(Sii, Sji, Sij, Sjj)

Channel parameter data	
data	Corrected data
data(scalar i)	Corrected data of trace i (trace number)
mem	Memory data
mem(scalar i)	Memory data of trace i (trace number)
xAxis	X-axis data
xAxis(scalar i)	X-axis data of trace i (trace number)
S11 - S44	S-parameter data

Common H parameter, Y parameter, Z parameter, F parameter, and T parameter definition (2-port network):

- 1) Mixing Parameter(H)

$$\begin{pmatrix} V_1 \\ I_2 \end{pmatrix} = (H) \begin{pmatrix} I_1 \\ V_2 \end{pmatrix} \quad (H) = \begin{pmatrix} H_{11} & H_{12} \\ H_{21} & H_{22} \end{pmatrix}$$

- 2) Admittance parameter(Y)

$$\begin{pmatrix} I_1 \\ I_2 \end{pmatrix} = (Y) \begin{pmatrix} V_1 \\ V_2 \end{pmatrix} \quad (Y) = \begin{pmatrix} Y_{11} & Y_{12} \\ Y_{21} & Y_{22} \end{pmatrix}$$

- 3) Impedance parameter(Z)

$$\begin{pmatrix} V_1 \\ V_2 \end{pmatrix} = (Z) \begin{pmatrix} I_1 \\ I_2 \end{pmatrix} \quad (Z) = \begin{pmatrix} Z_{11} & Z_{12} \\ Z_{21} & Z_{22} \end{pmatrix}$$

4) Basic parameter(F)

$$\begin{pmatrix} V_1 \\ I_2 \end{pmatrix} = (F) \begin{pmatrix} V_2 \\ -I_2 \end{pmatrix} \quad (F) = \begin{pmatrix} A & B \\ C & D \end{pmatrix}$$

$$a_1 = \frac{V_1 + I_1 Z_0}{2 \cdot \sqrt{Z_0}} \quad a_2 = \frac{V_2 + I_2 Z_0}{2 \cdot \sqrt{Z_0}}$$

$$b_1 = \frac{V_1 - I_1 Z_0}{2 \cdot \sqrt{Z_0}} \quad b_2 = \frac{V_2 - I_2 Z_0}{2 \cdot \sqrt{Z_0}}$$

5) Scattering transmission parameter(T)

$$\begin{pmatrix} a_1 \\ b_1 \end{pmatrix} = (T) \begin{pmatrix} b_2 \\ a_2 \end{pmatrix} \quad (T) = \begin{pmatrix} T_{11} & T_{12} \\ T_{21} & T_{22} \end{pmatrix}$$

S parameter convert to H parameter, Y parameter, Z parameter, F parameter and T parameter (2-port network):

1) S parameter convert to H parameter

$$H_{11} = Z_0 \cdot \frac{(1 + S_{11})(1 + S_{22}) - S_{12}S_{21}}{(1 - S_{11})(1 + S_{22}) + S_{12}S_{21}}$$

$$H_{12} = \frac{2 \cdot S_{12}}{(1 - S_{11})(1 + S_{22}) + S_{12}S_{21}}$$

$$H_{21} = \frac{-2 \cdot S_{21}}{(1 - S_{11})(1 + S_{22}) + S_{12}S_{21}}$$

$$H_{22} = \frac{1}{Z_0} \cdot \frac{(1 - S_{11})(1 - S_{22}) - S_{12}S_{21}}{(1 - S_{11})(1 + S_{22}) + S_{12}S_{21}}$$

2) S parameter convert to Y parameter

$$Y_{11} = \frac{1}{Z_0} \cdot \frac{(1 - S_{11})(1 + S_{22}) + S_{12}S_{21}}{(1 + S_{11})(1 + S_{22}) - S_{12}S_{21}}$$

$$Y_{12} = \frac{1}{Z_0} \cdot \frac{-2 \cdot S_{12}}{(1 + S_{11})(1 + S_{22}) - S_{12}S_{21}}$$

$$Y_{21} = \frac{1}{Z_0} \cdot \frac{-2 \cdot S_{21}}{(1 + S_{11})(1 + S_{22}) - S_{12}S_{21}}$$

$$Y_{22} = \frac{1}{Z_0} \cdot \frac{(1 + S_{11})(1 - S_{22}) + S_{12}S_{21}}{(1 + S_{11})(1 + S_{22}) - S_{12}S_{21}}$$

3) S parameter convert to Z parameter

$$Z_{11} = Z_0 \cdot \frac{(1 + S_{11})(1 - S_{22}) + S_{12}S_{21}}{(1 - S_{11})(1 - S_{22}) - S_{12}S_{21}}$$

$$Z_{12} = Z_0 \cdot \frac{2 \cdot S_{12}}{(1 - S_{11})(1 - S_{22}) - S_{12}S_{21}}$$

$$Z_{21} = Z_0 \cdot \frac{2 \cdot S_{21}}{(1 - S_{11})(1 - S_{22}) - S_{12}S_{21}}$$

$$Z_{22} = Z_0 \cdot \frac{(1 - S_{11})(1 + S_{22}) + S_{12}S_{21}}{(1 - S_{11})(1 - S_{22}) - S_{12}S_{21}}$$

4) S parameter convert to basic parameter

$$A = \frac{(1 + S_{11})(1 - S_{22}) + S_{12}S_{21}}{2 \cdot S_{21}}$$

$$B = Z_0 \cdot \frac{(1 + S_{11})(1 + S_{22}) - S_{12}S_{21}}{2 \cdot S_{21}}$$

$$C = \frac{1}{Z_0} \cdot \frac{(1 - S_{11})(1 - S_{22}) - S_{12}S_{21}}{2 \cdot S_{21}}$$

$$D = \frac{(1 - S_{11})(1 + S_{22}) + S_{12}S_{21}}{2 \cdot S_{21}}$$

5) S parameter convert to T parameter

$$T_{11} = \frac{-D_s}{S_{21}}$$

$$T_{12} = \frac{S_{11}}{S_{21}}$$

$$T_{21} = \frac{-S_{22}}{S_{21}}$$

$$T_{22} = \frac{1}{S_{21}}$$

$$D_s = S_{11}S_{22} - S_{12}S_{21}$$

Description of formula editor's operator:

Operator	Description
+	plus
-	minus
*	multiply
/	divide
^	power
(opening parenthesis
]	closing parenthesis
,	comma, parameter separator
=	equal
E	exponent

Note: operator priority:

1. ^
2. *, /
3. +, -

8.5 Trace statistics

Click **Math**→**Analysis**→**Statistics**, set the status to On to open the statistics function. The upper right corner of the interface will display the mean value, standard deviation, and peak to peak value of the current working trace.

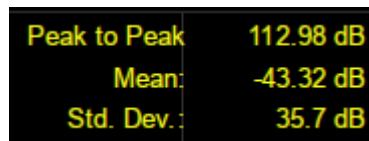

Peak to Peak	112.98 dB
Mean:	-43.32 dB
Std. Dev.:	35.7 dB

Figure 8-5 Statistical data interface

8.6 Limit test

Limit Line is a test form that can visualize test data and results. The limit test compares the measured data with the defined limit and provides the qualified or unqualified judgment information of each measured data point. Limit line and limit test are not suitable for smith chart and polar coordinate display formats, and limit line and limit test functions are automatically disabled for these display types.

Limit table setting

Click **Math** → **Analysis** → **Limit** and the pop-up dialog box is shown in the figure below. Limit test, sound type, limit table, global pass/fail can be set in this interface.

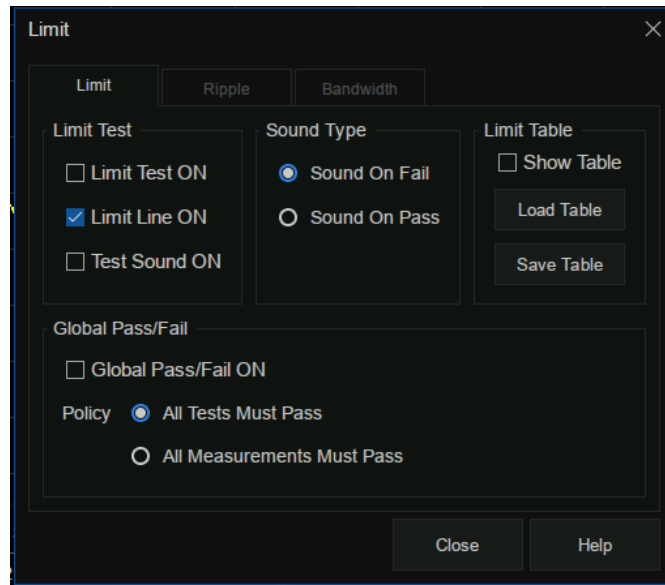

Figure 8-6 Limit test interface

Limit test:

- Limit test on: Check this box to compare the data with the limit and display “pass” or “Fail” judgment result.
- Limit line on: Check this box to display the limit on the screen.
- Sound on fail: When this box is selected, when the point on the trace fails in the limit test, a beep will sound.

Sound type:

- Sound on fail: When this box is checked, the equipment will beep when the test fails.
- Sound on pass: When this box is checked, the equipment will beep when the test passes.

Limit table:

- Show table: Check this box to open a table at the bottom of the screen to create and edit limits.
- Load table: Call the saved limit table, The saved format of the limit table is CSV by default.

Global pass / fail:

Pass / fail indicator is a convenient way to monitor all measurement status.

Global pass / fail on - Check this box to display the global pass / fail status.

Policy - Select which of the following requirements must be met for the global pass/fail status to display “pass” :

- **All tests must pass** - This setting will read the results from the limit test. If all tests (limit test is on) pass, the global pass/fail status will be “pass”.
- **All measurements must pass** - Unless all measured data points are within the established test limits and the limit test is “on”, the global pass/fail status will be “fail”.

Note: In this mode, if there is a test that does not set the limit test to the on state, the global pass / fail will display “fail”.

Limit line setting

Click **Math** → **Analysis** → **Limit Table** → **Limit** to open the limit line setting interface, we can also click **Math** → **Analysis** → **Limit** → **Show Table** to open the limit line setting interface, as shown in the figure below.

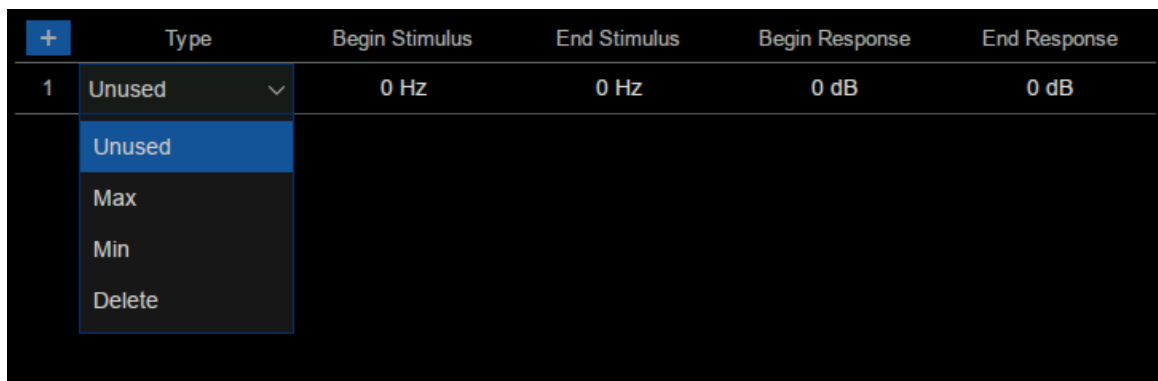

	Type	Begin Stimulus	End Stimulus	Begin Response	End Response
1	Unused	0 Hz	0 Hz	0 dB	0 dB

Figure 8-7 Limit line setting interface

Limit line type:

- **Unused:** Invalid limit line.
- **Max:** Above this limit line, the measurement fails.
- **Min:** Below this limit line, the measurement fails.
- **Delete:** Delete limit line.

Begin stimulus: Frequency of the limit line’s starting point.

End stimulus: Frequency of the limit line’s ending point.

Begin response: Response of the limit line’s starting point.

End response: Response of the limit line’s ending point.

8.7 Ripple limit test

The ripple limit test function can be performed independently of the limit test function, and the ripple limit can be set to evaluate whether the measurement result is qualified or unqualified. Ripple is defined as the difference between the maximum value and the minimum value within the specified excitation range. The ripple limit function is only applicable to the measured point value, not to the interpolation.

Ripple table setting

Click **Math** → **Analysis** → **Limit** → **Ripple** to open the ripple test setting interface, we can set ripple test, sound type, and ripple table in this interface.

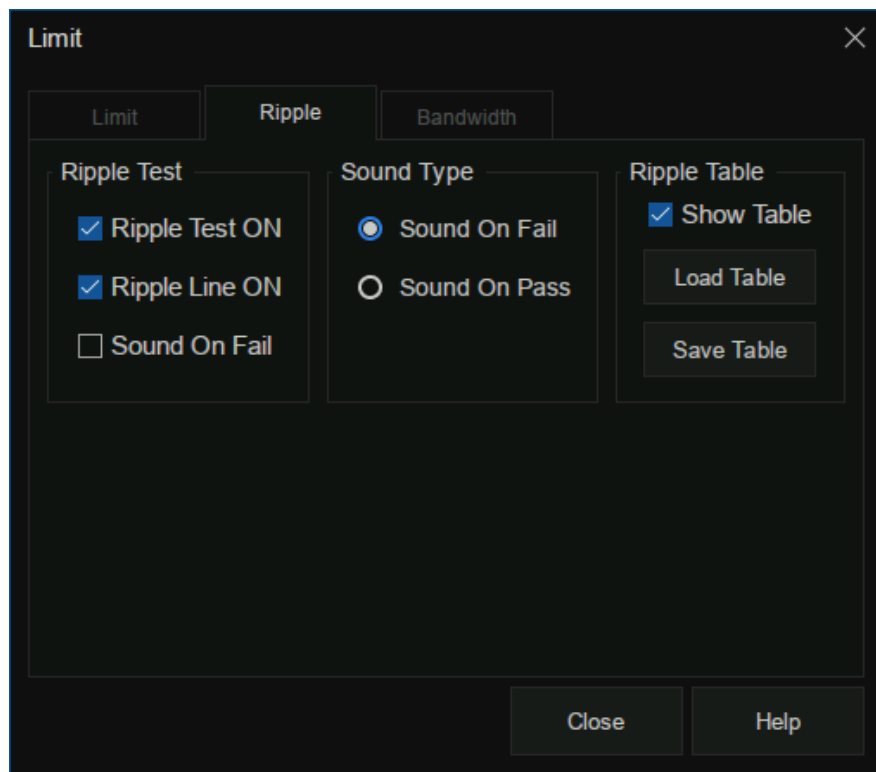

Figure 8-8 Ripple test setting interface

Ripple test:

- **Ripple test on:** Check this box to set the ripple test to “on” state and display “pass” or “Fail”.
- **Ripple line on:** Check this box to display the ripple limit line on the screen.
- **Sound on fail:** When this box is checked, the VNA will beep when the test fails.

Sound type:

- **Sound on fail:** When this box is checked, the equipment will beep when the test fails.
- **Sound on pass:** When this box is checked, the equipment will beep when the test passes.

Ripple table:

- **Show table:** Check this box to display a table at the bottom of the screen for creating and editing limits.
- **Load table:** Call the saved ripple limit table.
- **Save table:** Save the ripple limit table, the saved format of the ripple table is CSV by default.

Ripple limit line setting

Click **Math** → **Analysis** → **Limit Table** → **Ripple** to open the ripple limit setting interface, we can also click **Math** → **Analysis** → **Limit** → **Ripple** → **Show Table** to open the ripple limit setting interface, as shown in the figure below.

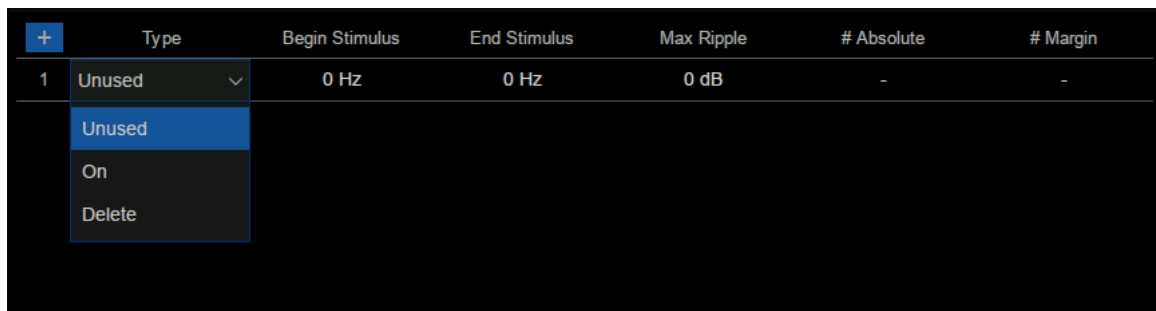

	Type	Begin Stimulus	End Stimulus	Max Ripple	# Absolute	# Margin
1	Unused	0 Hz	0 Hz	0 dB	-	-

Figure 8-9 Ripple limit setting interface

Type:

- **Unused:** Invalid ripple test line.
- **On:** Open ripple test limit line.
- **Delete:** Delete ripple test limit line.

Begin stimulus: Frequency of ripple limit line's starting point.

End stimulus: Frequency of ripple limit line's ending point.

Max ripple: Maximum value of ripple test.

Absolute: The difference between the maximum and minimum in the frequency band.

Margin: The difference between the absolute value of ripple and the limit value.

8.8 Bandwidth limit test

The bandwidth limit test function can be used to test the bandwidth of a bandpass filter. The bandwidth limit test can find the peak value in the bandwidth, and find the frequency points lower than the specified value of the peak value on the left and right sides of the peak point, and the frequency between these two points is the filter bandwidth, and then compare the obtained bandwidth with the minimum and maximum allowable bandwidth specified in advance.

Bandwidth test setting

Click **Math** → **Analysis** → **Limit** → **Bandwidth** to open the broadband test setting interface, we can set bandwidth test, sound type, and target bandwidth in this interface.

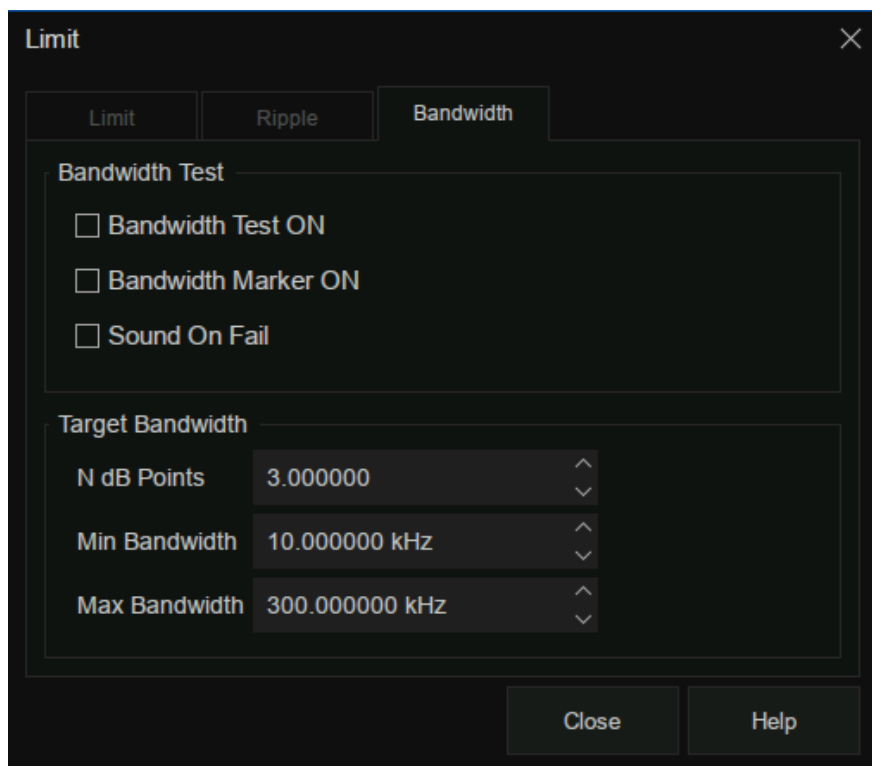

Figure 8-10 Bandwidth test setting interface

Bandwidth test:

- Bandwidth test on: Check this box to set the bandwidth limit test state to on.
- Bandwidth marker on: Check this box to display the bandwidth on the screen.
- Sound on fail: When this box is selected, an alarm will sound when the bandwidth limit test fails.

Target bandwidth:

- N dB points: Specifies the bandwidth threshold in dB.
- Min bandwidth: Enter the lower limit of bandwidth in Hz.
- Max bandwidth: Enter the upper limit of bandwidth in Hz.

Note: If the data format is Smith chart or polar coordinate format, the bandwidth test is skipped.

8.9 Time domain

A vector network analyzer is usually used to measure the frequency domain characteristics of the DUT. For the time domain characteristics of the DUT, the frequency domain parameters can be obtained by inverse Fourier transform. The time-domain characteristics use time as the horizontal axis to display the measurement results. Then the characteristics of the DUT can be observed from two different visual angles of frequency domain and time domain by the vector network analyzer.

8.9.1 Transform

Click **Math** → **Time Domain** → **Time Domain Setup** → **Transform** to open the time domain transform setting interface, we can set the start time, stop time, center time, span, transform mode in this interface.

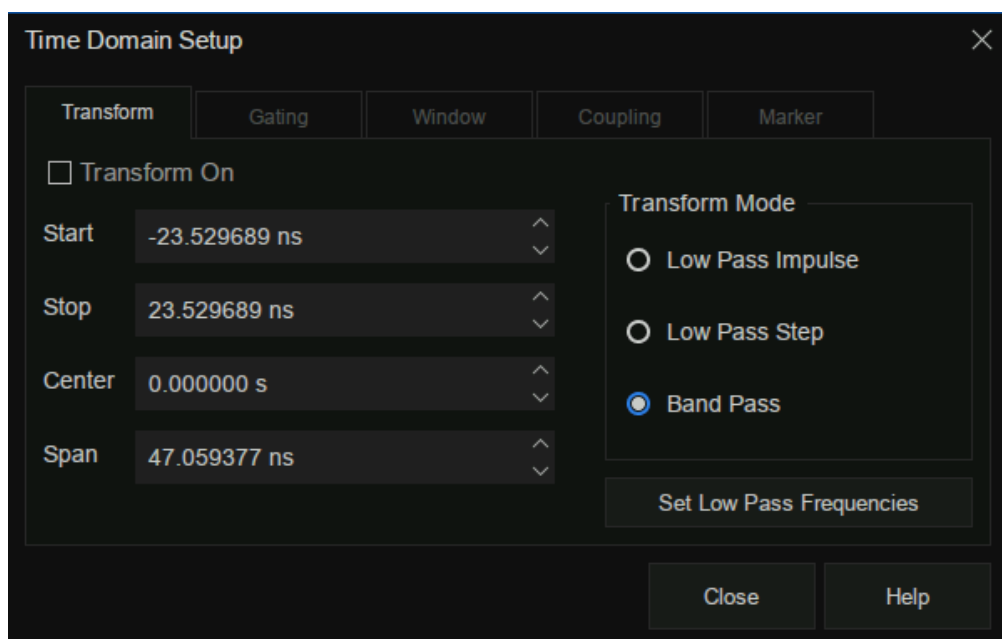

Figure 8-11 Time domain setting interface

Transform switch: Check the transform switch to switch to time-domain mode.

Start time: Set the start time of transformation displayed.

Stop time: Set the stop time of transformation displayed.

Center time: Set the center time of transformation displayed.

Time span: Set the time span of the transformation displayed on the screen of VNA.

Transform mode:

- **Low pass impulse:**

High resolution, suitable for viewing the small response of the device propagating low-frequency signal. In this low pass impulse mode, the frequency expands to DC and negative frequency. Therefore, when we click **Set Low Pass Frequencies**, the starting frequency will be automatically adjusted, which will affect the calibration accuracy. Therefore, it is necessary to calibrate after setting the time domain measurement parameters.

- **Low pass step:**

The simplest way to determine the discontinuities caused by inductors and capacitors in equipment that propagate low frequency signals.

- **Bandpass:**

The simplest method, which can be used with any frequency sweep, it is most useful when measuring devices with limited bandwidth. Capacitance and inductance reactance will not be shown. For the same frequency range and number of points, the bandwidth of bandpass mode is twice that of impulse mode, which will hide the closely spaced response and reduce the response resolution. The measurement range is inversely proportional to the frequency step.

Set low pass frequencies:

It can only be used in low pass mode. After clicking **Set Low Pass Frequencies**, the measurement range is inversely proportional to the starting frequency. Recalculate the start frequency and step frequency as the harmonics of the starting frequency. Calculate the starting frequency according to the formula of low pass start frequency = stop frequency/points. The calculated value must not be less than the minimum frequency of the vector network analyzer. The number of points or stop frequency may change.

8.9.2 Gating

The gating function of a vector network analyzer is the most useful feature in time domain transform. When the time domain characteristics of the equipment need to be viewed, the gating function can only choose the required time-domain response, eliminate unnecessary time domain response, and then view the frequency domain characteristic curve of the required response through Fourier transform. The gating function enables the DUT to be characterized without connectors or adapters.

Click **Math** → **Time Gating** → **Gating Setup** → **Gating** to open the gating setting interface, then we could set the start time, stop time, center time, span, gate type, and gate shape in this interface.

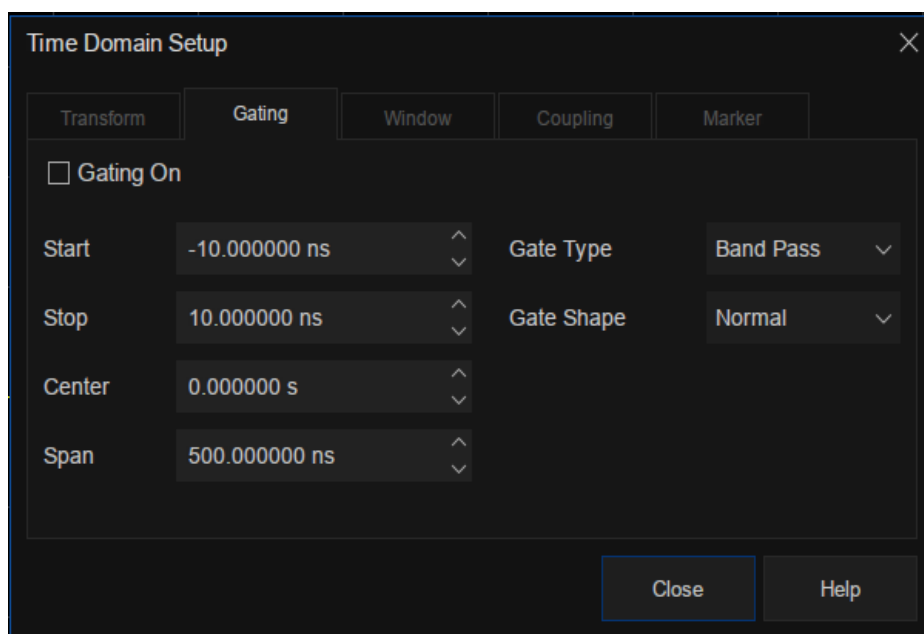

Figure 8-12 Gating setting interface

Gating on: Open or close the gating function.

Start time: Set the start time of gating.

Stop time: Set the stop time of the gate.

Center time: Set the center time of the gate.

Time span: Set the time span of the gate.

Gate type: Sets the type of filtering performed by the gating function.

- **Bandpass:** Keep the response in the gating span.

- **Notch:** Remove response using the gating span.

Gate shape: Set the filter characteristics of the gating function. There are four options: minimum, normal, wide, and maximum.

The parameter definition of the gating function is shown in the figure below:

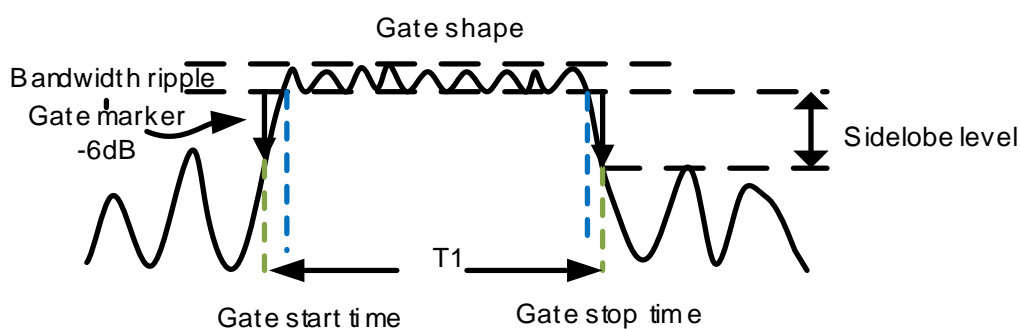

Figure 8-13 Diagram of gating

Parameter description of gating function:

Gate shape	Bandwidth ripple	Sidelobe level
Minimum	±0.1 dB	-25dB
Normal	±0.1 dB	-45dB
Wide	±0.1 dB	-52dB
Maximum	±0.01 dB	-80dB

8.9.3 Window

There will be sudden changes in the start and stop of frequency domain parameter measurement, which will lead to overshoot and ringing in the time domain. The window function is helpful to reduce the overshoot and ringing in the process of frequency domain and time domain conversion.

Click **Math** → **Time Gating** → **Gating Setup** → **Window** to open the window setting interface, we can set the window size, The size of the window should be balanced between response resolution and dynamic range. Setting the minimum window can get the best response resolution, and setting the maximum window can get the maximum dynamic range.

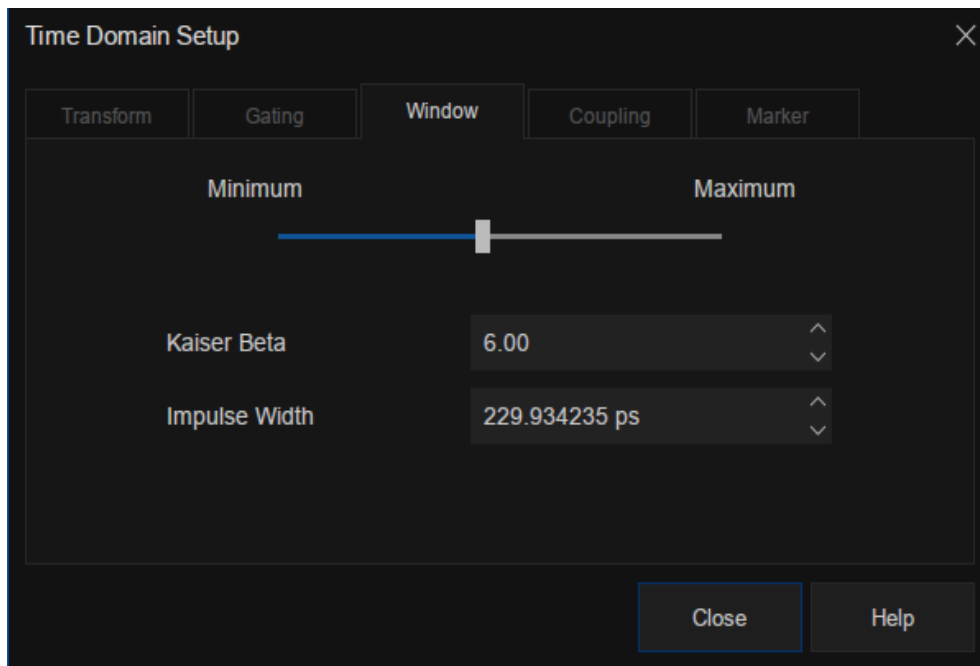

Figure 8-14 Window setting interface

Three methods of setting window size:

- **Minimum-maximum:** Use the mouse or touch screen to move the slider to change the window size.
- **Kaiser Beta:** Use the value of Kaiser Beta to change the window size.
- **Impulse width:** Use the value of impulse width to change the window size.

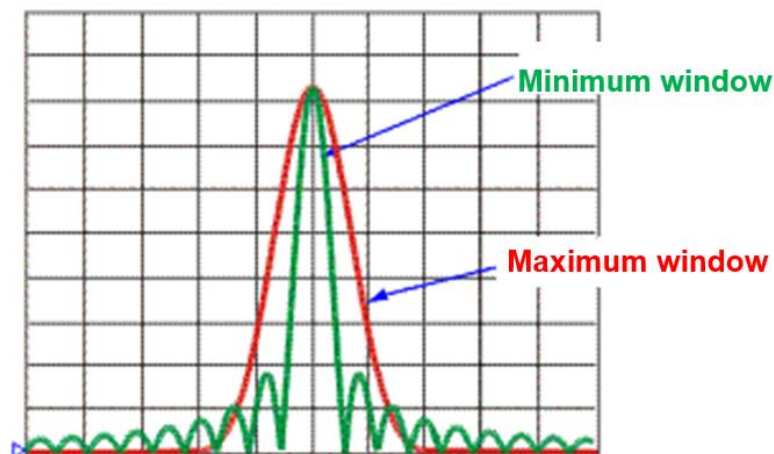

Figure 8-15 Diagram of maximum and minimum window

8.9.4 Coupling

Trace coupling allows to change the measured time-domain parameters and make all other measured parameters in the channel change the same. For example, to view the frequency-domain and time-domain measurement parameters at the same time, first turn on the coupling switch and select all the gating parameters in the coupling setting interface, at the same time, the parameters of gate span are changed in time domain measurement, the frequency-domain measurement parameters will be changed automatically to reflect the effect the time domain gate span parameters are modified. The trace coupling is only applicable to Y-axis scale / reference settings. The results of trace coupling do not change the measured data.

Click **Math** → **Time Gating** → **Gating Setup** → **Coupling** to open the coupling setting interface, we can set transmission parameters and gating parameters in this interface.

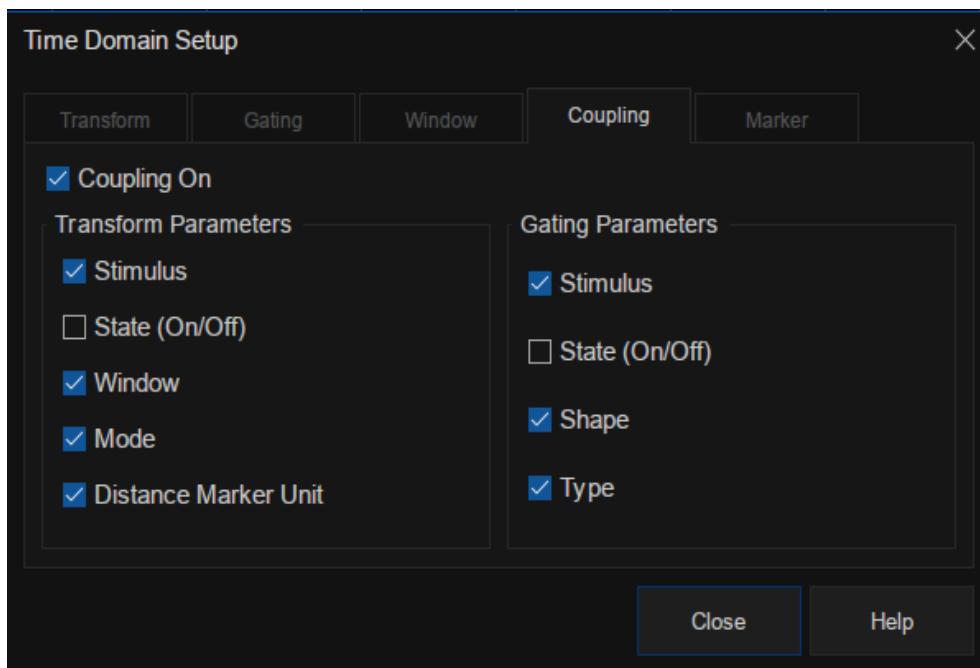

Figure 8-16 Coupling setting interface

Coupling on: Click to enable coupling. At this time, all measurements in the channel are coupled. The following conversion parameters and gating parameters can be used for coupling.

Transform parameters:

- **Stimulus:** Setting of the start time, stop time, center time, and span.

- **State(On/Off):** State of the transform.
- **Window:** Kaiser Beta and pulse width parameter.
- **Mode:** Low pass pulse, low pass step, bandpass.
- **Distance marker unit:** When selected, all measured distance marker units are coupled.

Gating parameters:

- **Stimulus:** Setting of the start time, stop time, center time, and span.
- **State (On/Off) :** Switch of gating function.
- **Shape:** “Minimum”, “normal”, “wide” and “maximum”.
- **Type:** Bandpass and notch filtering.

8.9.5 Marker

When a marker is added to a time-domain parameter, the distance parameter is automatically displayed in the marker reading. These settings only affect the display of all markers of the active measurement (Unless the distance marker unit is coupled in the trace coupling box).

Click **Math** → **Time Gating** → **Gating Setup** → **Marker** to open marker setting interface. Set the marker mode, units, and velocity factor in this interface.

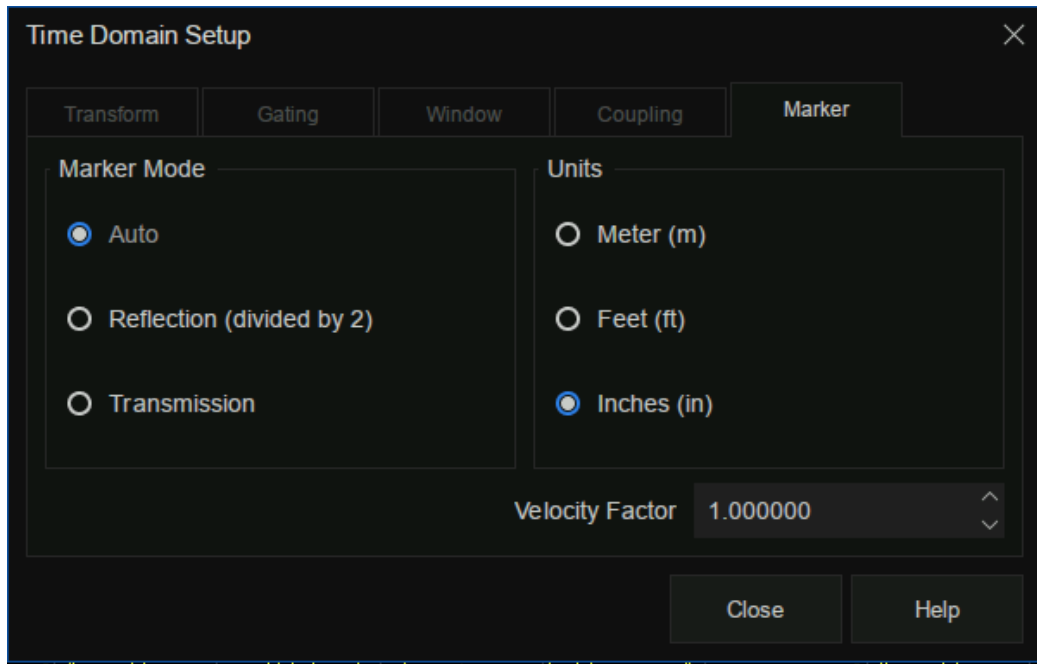

Figure 8-17 Marker setting interface

Marker mode: Specify the marker mode to determine the correct marking distance displayed. Generally, **Auto** can be selected when measuring S parameter, and **Reflection** or **Transmission** can be selected when measuring any ratio parameter.

- **Auto:** If the measurement parameter is S parameter, **Reflection** or **Transmission** will be selected automatically. If the measurement parameter is a non-S parameter, **Reflection** will be selected automatically.
- **Reflection:** Displays the distance from the source to the receiver and the return path, then divides by 2 (compensated return path).
- **Transmission:** Displays the distance from the source to the receiver.

Units: Specifies the unit for the displayed marker distance value, there are three options: meter, feet, inches.

Velocity factor: Set the velocity factor of the transmission line, where the value of PE is 0.66, PTFE is 0.7 and the corresponding value of vacuum is 1.

9 Guide For the TDR Option

9.1 Overview

Measured frequency responses can be transformed to the time domain to analyze the time-domain characteristics of the DUT. The TDR option provides the time domain reflection/transmission analysis functions and eye diagram simulation function, which can help users save time and money by minimizing the need for other test equipment. Time domain analysis also has some irreplaceable advantages:

1. Time-domain analysis shows the positions and properties of the impedance discontinuities on DUT. It can be easy to acquire the impedance value at any point on the transmission line by analyzing the time domain reflection characteristics. It's helpful to locate the faults on transmission lines.
2. Using the time domain gating function to remove the influences of the impedance discontinuities, it becomes possible to simulate the frequency domain characteristics of DUT after the faults are removed.
3. The eye diagram simulation function doesn't need any external waveform generators. The VNA uses a built-in virtual bit pattern generator to provide the input signal. It's a very important tool for signal integrality analysis.
4. If you want to design a compensation network for high-speed digital signal transmission by emphasis/ de-emphasis or equalization, the advanced waveform function in TDR waveform will be of vital use for you. You don't need to change the DUT connection or any extra devices, it's easy to simulate the eye diagrams with the different compensation methods.
5. You can directly inject jitter into the input signal for eye diagram simulations. A statistical eye diagram is introduced to simulate the probability density of the output signals.

When using the TDR option, there are some notes:

1. When opening the TDR option or switching the DUT topology, calibration and deskew data will be cleared. Please finish the calibration wizard before measuring to get the correct results. Save the calibration data and recall it when required, which can avoid unnecessary calibration operations.
2. Please operate in the bottom toolbar of the TDR menu as far as possible. The function in the TDR option depends on the time domain transform, so changing settings in the right toolbars can lead to incorrect transform results.

3. Don't close the eye diagram module while the eye diagram is drawing, or an unexpected error might occur. Unless necessary, don't switch between the TDR/TDT module and the eye diagram module, for the last eye diagram will be drawn when it's switched to the eye diagram module, which might take a long time.
4. It's NOT recommended to add too many traces, or the trace data update will be slow.
5. If there are too many windows or too much information in a window to observe the information or traces, it will be useful to maximize the window or trace.

9.2 Open/Close/Preset TDR Option

To switch on the TDR option, use the order **Math->TDR->TDR**, then the button "On" will be selected. The TDR toolbar will appear at the bottom of the screen, and the TDR option function will be open to the user. If you have the trial license for the TDR option, an information dialog will appear to notify you that the trial times will decrease. If the trial times expire, a permanent license is needed to switch on the TDR option.



Figure 9-1 TDR Option interface

To close the TDR option, use the order **Math->TDR->TDR** again, then the button "Off" will be selected, VNA will restore the state before the option opened. Click the  button at the top right corner of the TDR toolbar will close the TDR option too.

Click the **Preset** button in the **Basic** bar of the **Setup** tab in the TDR toolbar and the VNA will preset the TDR option: Clear the calibration data, allocate the traces and windows automatically, and reset the settings in the option. After the TDR option is started, the calibration wizard will need to be run again.

9.3 TDR Setup Wizard

The TDR setup wizard pops up when the TDR option is switched on for the first time. Click the checkbox “**Show this wizard next start-up**” to decide whether the wizard pops up when opening the option or not. The wizard can be opened by clicking the **Setup Wizard** button in the **Basic** bar of the **Setup** tab in the TDR toolbar.

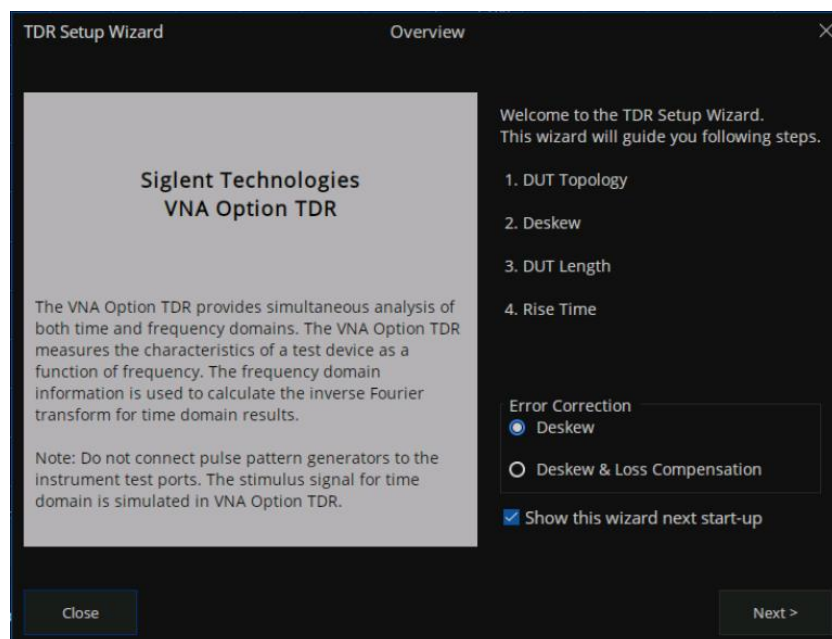

Figure 9-2 TDR Setup Wizard

The wizard will guide you to finish the DUT topology selection, port extension setup, DUT length measurement, and stimulus rise time setting. The calibration type can be selected in the **Error Correct** bar on the first page of the wizard, and the wizard will also guide you to finish the calibration you select. The calibration operation will be illustrated in detail in the section “**TDR calibration**”.

If you don't need to finish the setup in the wizard immediately, you can close the wizard. But the calibration is necessary before accurate measurement or analysis.

9.4 Calibration for TDR Option

There are two calibration types in the TDR option: **Deskew** or **Deskew & Loss Compensation**. The former only moves the reference plane to the end of the cables connected to the ports of VNA, ignoring the signal loss in the cables. And the latter tries to compensate the loss in the cables.

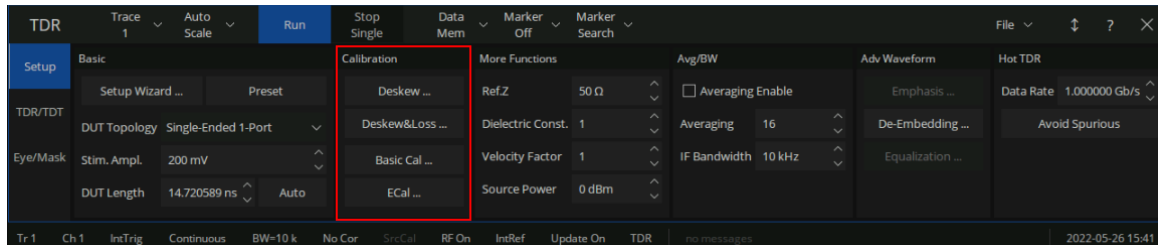



Figure 9-3 TDR Calibration Tab

9.4.1 Deskew

Click the **Deskew** button in the **Basic** bar of the **Setup** tab in the TDR toolbar to open the **Deskew** dialog. Connect all cables and fixtures to the VNA, and connect the other ends of the fixtures to nothing or the OPEN calibration kit. Then click the **Deskew** button in the dialog, and click the **Finish** button after a  mark appears at the **Deskew** button to finish the Deskew calibration.

Click the **Option** button to open the **Deskew Option** dialog, in which you can select the calibration type or operate the calibration one-by-one for each port. The calibration type can be selected by the **Standard Type** pull-down menu. It's set to **Open** by default. If you choose the **Short** option, you should connect the SHORT calibration kit to the port to finish the calibration. You can calibrate only one port at a click on the corresponding **Port** button, but you should finish the calibration of all ports to finish the task in the dialog.

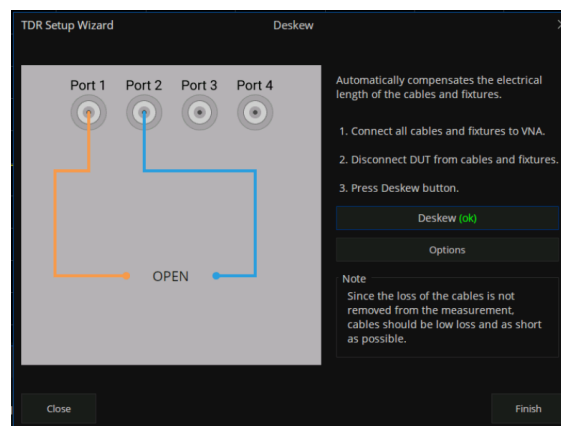



Figure 9-4 TDR Deskew Wizard

9.4.2 Deskew & Loss Compensation

Click the **Deskew&Loss** button in the **Basic** bar of the **Setup** tab in the TDR toolbar to open the **Deskew & Loss Compensation** wizard. The wizard can be divided into 3 steps, which guide you to finish the Deskew and Loss Compensation calibration.

At the first step, a Deskew calibration is required. The method is the same as the operation introduced in the section “Deskew”.

At the second step, the calibration operation depends on the correct DUT topology. Under the topology Single-Ended 1 Port, you need to connect the cables and fixtures to the VNA, connect the other ends of the fixtures to nothing or an OPEN calibration element. Click the **Measure** button in the wizard, wait for the  mark to appear at the **Measure** button to finish the second step of calibration. Under other DUT topologies, you need to connect two cables and fixtures, which are connected to the ports as the wizard instructs, to both ends of a THRU calibration kit. Click the **Measure** button in the wizard, wait for the  mark to appear at the **Measure** button, then execute the next operation. If under Single-Ended 4-Port or Differential 2-Port, you will need to execute the operation as stated above once for each page of the wizard respectively to finish the second step.

At the third step, you can connect the LOAD calibration element to every port, and click the corresponding **Port** button to execute the calibration step. The step is optional, so it's not necessary to finish the calibration wizard.

If you finish all necessary calibration operations, click the **Apply** button to save and apply new calibration data, and click the **Finish** button to close the wizard.

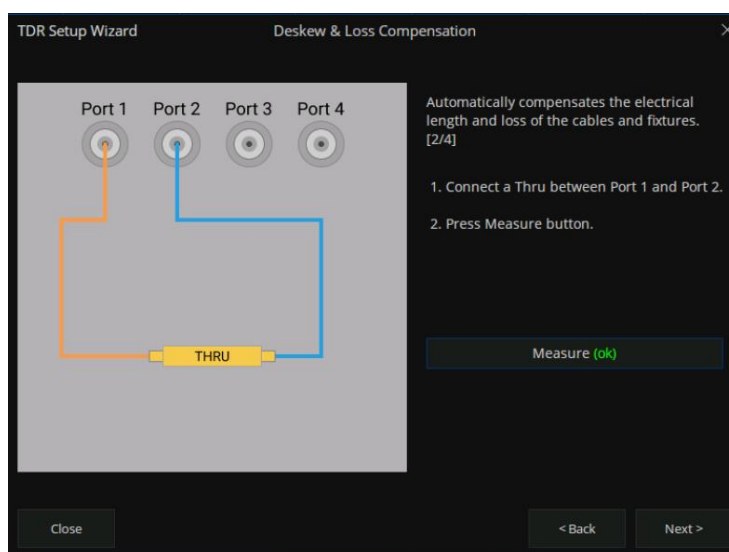

Figure 9-5 TDR Deskew&Loss Wizard

At any step of the wizard, it's allowed to execute a calibration operation repeatedly, new measured data will replace original data. You can click the **Close** button to close the wizard, which will give up all data measured in the wizard unless you have clicked **Apply** button to save them.

9.5 TDR Channel Setup

When the TDR function is activated, the current state is saved, and all existing traces and channels are deleted, and a new channel is added for the option. When the option is closed, all traces and the channel being used are deleted, and the instrument is returned to the state before TDR was opened.

The current channel settings can be changed in the TDR toolbar at the bottom of the screen, usually in the **Setup** tab.

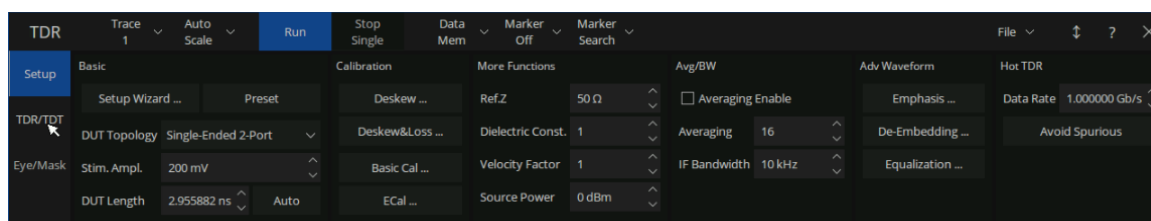

Figure 9-6 TDR Setup Tab

9.5.1 DUT Topology

In addition to the Setup wizard, the DUT topology can be changed in the **DUT topology** pull-down menu in the **Basic** bar of the **Setup** tab. The traces and windows are allocated automatically according to the DUT topology.

If the DUT topology is changed, the calibration and deskew data will be cleared. Recalibration becomes necessary before an accurate measurement or analysis. If the calibration data is hoped to be held, save the state in time and recall it when required.

9.5.2 DUT Length

The DUT length means the time that the signal takes to transmit through the DUT or reflect the incident plane and is required to show the time-domain responses of DUT in full. The sweep frequency span and points of the channel are set according to the DUT length, and the span of the transformation is automatically calculated by the DUT length when the time domain traces are set

in the time axes. It's not recommended to change the sweep settings by other methods.

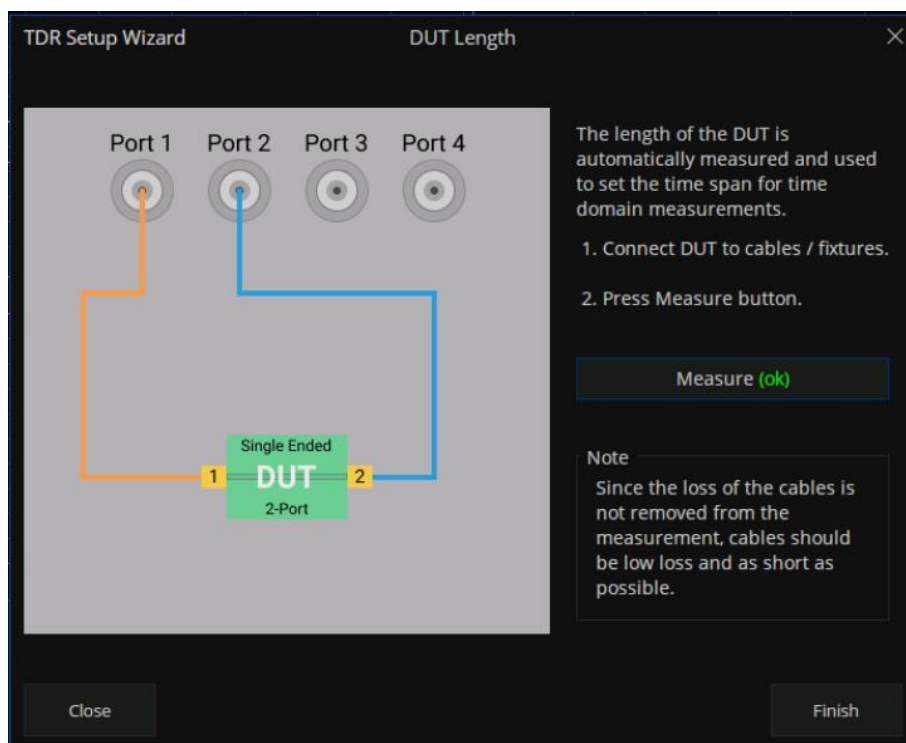



Figure 9-7 DUT Length measure wizard

In addition to the Setup wizard, the DUT length can be set in the **DUT Length** textbox in the **Basic** bar of the **Setup** tab. It's a convenient way to set the suitable value by measuring the DUT length in the **DUT Length** dialog. Click the **Auto** button on the left of the textbox to open the dialog, connect the DUT according to the picture and instructions in the dialog, click the **Measure** button and wait for the  mark to appear, click the **Finish** button to close the dialog, and finish the DUT length setting. If the measurement result is out of the default range, an information dialog will pop up to notify the users that the DUT length will be set to the maximum or minimum.

9.5.3 Stimulus Magnitude in Time Domain

The stimulus magnitude in the time domain can be set in the **Stim. Ampl.** textbox in the **Basic** bar of the **Setup** tab, which defines the magnitude of the impulse or step stimulus signal for the time-domain responses of the traces under the format **Volt**.

9.5.4 Port Impedance

The port impedance can be set in the **Ref. Z** textbox in the **More Function** bar of the **Setup** tab, which defines the reference impedance to calculate the impedance values of the traces under the format **Impedance**.

9.5.5 Velocity Factor & Dielectric Constant

The velocity factor is the ratio of the velocity of the electric signal in the DUT to that in the vacuum. VNAs calculate the distances by the transmission or reflection time based on this factor, which provides the accurate positions of the impedance discontinuities. There is a functional relationship between the velocity factor and the dielectric constant of the materials. When either is changed, the other will be calculated by the equation below:

$$\text{Velocity Factor} = \frac{1}{\sqrt{\text{Dielectric Constant}}}$$

The velocity factor and dielectric constant can be set in the **Velocity Factor** and **Dielectric Const.** textboxes in the **More Function** bar of the **Setup** tab.

9.5.6 Power Level

The power level is the power of the test signal transmitted to the DUT, which can be set in the **Source Power** spinbox in the **More Function** bar of the **Setup** tab.

9.5.7 Average

The average function means that the final measure results are equal to the average of the measure results in the several sweeps in the same setting, and the number of sweeps needed depends on the averaging factor. The average function can decrease the random errors to some degree, but slow down the update of trace data. It's necessary to keep the characteristics and connection of the DUT unchanged during an average sweep.

To enable or disable the average function, click the **Averaging** checkbox in the **Average** tar of the **Setup** tab. The average factor can be set in the textbox to the right of the checkbox.

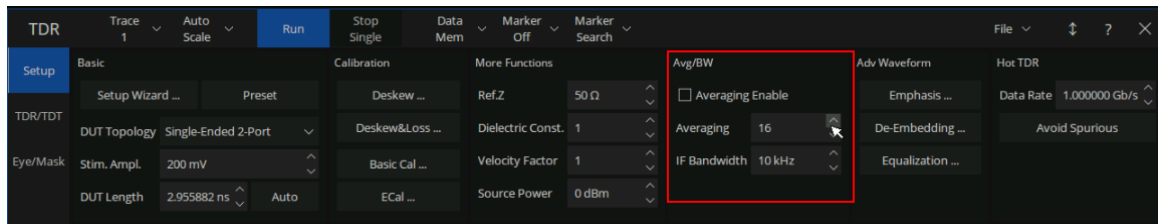

Figure 9-8 Avg/BW setting

9.5.8 IF Bandwidth

The IF bandwidth is the bandwidth of the intermediate-frequency filters in the receivers. A narrow IF bandwidth leads to lower trace noise levels and longer sweep times.

The IF bandwidth can be set in the **IF Bandwidth** textbox in the **Average** tar of the **Setup** tab.

9.5.9 Trigger Mode

The trigger mode gates the channel sweep state change when the trigger signal is detected. The trigger mode **Hold/Stop** means that sweep can't be started even if the trigger signal is detected. **Single** means that only one sweep is triggered by the trigger signal. Upon sweep completion, the trigger mode is set to **Hold/Stop**. **Continuous/Run** means that the trigger signal starts and continuously sweeps.

To switch the trigger mode to **Continuous/Run**, click the **Run** button at the top of the TDR toolbar. To switch the trigger mode to **Single**, click the **Stop/Single** button at the top of the TDR toolbar.

9.6 TDR Trace Setup

Without taking the set coupling into account, the settings as follows are applied to a single trace. Usually, the traces in the TDR option are in a time-domain coupling and marker coupling, meaning that the correlated settings are applied to all the traces. In addition, There is a set of default trace configurations for every DUT topology.

9.6.1 Select a Trace

In addition to clicking the trace or trace information bar on the screen, the **Trace** pull-down menu at the top of the TDR toolbar has the same function.

9.6.2 Scale Management

In the TDR option, there are several automatic scale settings to use, and it is allowed to change the scale or reference value manually.

9.6.2.1 Auto Scale

To apply the automatic scale settings, click the **Auto Scale** button at the top of the TDR option and click the suitable option in the pull-down menu. Every option in the menu represents a set of automatic scale settings.

Option **X** means that the horizontal axis of the current trace is set automatically. For the traces in the time domain, the scale and reference value are calculated by the DUT length. For the traces in the frequency domain, the horizontal axis is set to the frequency sweep setting of the channel.

Option **Y** means that the vertical axis of the current trace is set automatically. The scale and reference value are calculated by the maximum and minimum of the trace data.

Option **X&Y** means that the horizontal and vertical axes of the current traces are set automatically. The method is the same as introduced above.

All Trace means that the horizontal and vertical axes of all the traces are set automatically. The method is the same as introduced above.

9.6.2.2 Manual Scale Setup

Manual calibration Settings are implemented through the Scale setting option in the TDR menu. **Horizontal** is used to set the Horizontal coordinate and the reference point position, **Vertical** is used to set the Vertical coordinate and the reference value. Users click the corresponding edit box to enter the value through the number button on the front panel.

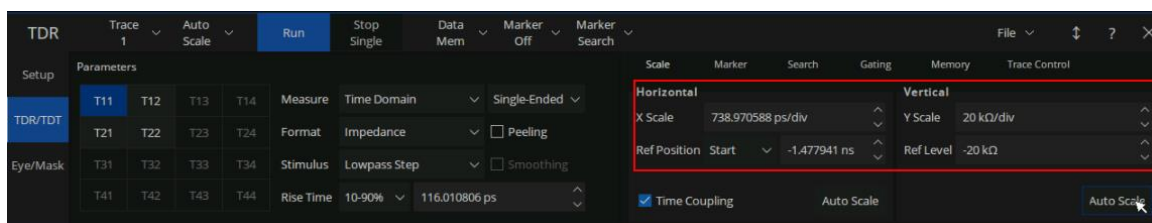

Figure 9-9 Scale Setup by manual

The vertical axis of the traces in the frequency domain has no concern with the sweep setting of the channel, only to set the displayed span of the trace data.

9.6.3 Memory Trace Management

Memory trace management is in the **Data/Mem** pull-down menu at the top of the TDR toolbar. Click the **Data->Mem** order in the menu, and the current trace data is saved to the memory trace. Other orders in the menu are display modes of the data trace and the memory trace for the current trace: The option **Off** means the data trace and the memory trace are invisible. The option **Memory** means only the memory trace shows in the window. The option **Data** means only the data trace shows. The option **Data&Mem** means both of them are visible.

9.6.4 Measure Parameter & Format

The measurement parameters and formats of the traces can be set in the **Parameter** tab of the **TDR/TDT** tab.

The physical significance of measurement parameters and formats in the frequency domain is the same as the general parameters of the VNA. In the time domain, T parameters are used as measurement parameters, meaning that the ratio of the magnitudes of the response signals received to the stimulus signals when a unit step / impulse stimulus signal is transmitted to DUT at time zero, in a span. For a specified DUT, S parameters are functions of the signal frequency, while T parameters are functions of the time under a specified stimulus type. T parameters show the unit

step / impulse response of the DUT, which is of vital importance in the time domain system analysis.

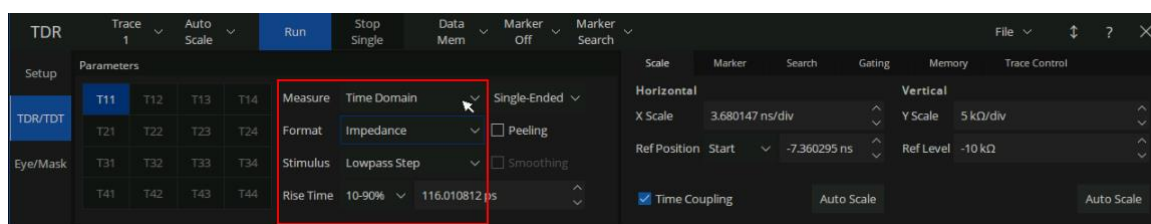

Figure 9-10 measure parameter setting

The formats of T parameters include **Log Mag**, **Lin Mag**, and **Real**, which are the same as S parameters; moreover, **Impedance** and **Volt** are added. T parameters show the time domain responses, so the values are always real numbers. In the other words, the imaginary parts are always zero. Therefore, Imaginary or phase formats aren't provided for T parameters in the TDR option. The magnitude of **Log Mag** and **Lin Mag** formats is intrinsically the absolute values of the real parts of T parameters.

Impedance format is usually used for the reflection T parameters under a unit step stimulus. It calculates the impedance value of each point in the signal transmitting path by the reflection T parameters (reflection coefficients) under the unit step stimulus, which is on the base of the port impedance. The distances are calculated by the delay of transmission and the velocity factor. In the **Impedance** format, the positions and properties of impedance discontinuities in the DUT are shown on the traces visually, which provides a piece of important information for fault detection and removal. In the **Impedance** format, the TDR option regards the T parameters as the reflection coefficients ρ , and calculates the impedance by the equation as follow:

$$Z = Z_0 \cdot \frac{1 + \rho}{1 - \rho}$$

Volt format means the trace shows the time domain waveform of the response signal received under the specified stimulus. The magnitude of the stimulus signal is defined by the value in the **Stim. Ampl.** textbox in the **Basic** bar of the **Setup** tab. Intrinsically, the **Volt** format means the trace data is a product of the T parameters and the magnitude of the stimulus signal.

Click the measure parameter button in the grids on the left of the **Parameter** bar, the measurement parameter of the current trace switches to the corresponding parameter. To switch on or off the time domain transform of the current trace, click the pull-down menu in the left of the **Measure** line. To switch to balance or unbalance parameters, click the pull-down menu in the right of the **Measure** line. To change the format, click the **Format** pull-down menu.

9.6.5 Stimulus in Time Domain

The stimulus type can be set in the **Stimulus** pull-down menu in the **Parameter** bar of the **TDR/TDT** tab. There are two stimulus types to choose: The option **Lowpass Step** means T parameters show the unit step responses and the option **Lowpass Impulse** means T parameters show the unit impulse responses.

The rise time or impulse width of the stimulus signal can be set in the Rise Time or Impulse Width textbox. Intrinsicly, it controls the beta value of the Kaiser window function applied in the time domain transformation to weaken the sidelobes. Because the transformation is based on the finite frequency domain data, the data truncation at the end of frequency domain data leads to some problems, such as the extension of the rise time or impulse width of the responses signal and the appearance of sidelobes, which is called "truncation effect". Applying the Kaiser window lowers the sidelobe levels, but aggravates the extension of the rise time or impulse width and brings down the resolution ratio of transformation. The longer the rise time or impulse width of the stimulus signal, the larger the beta value of the Kaiser window function, the stronger effects explained above are introduced into the transformation.

9.6.6 Smoothing

The smoothing function makes the trace data smooth by replacing the original trace data with the average of the data nearby. If the local change ratios of trace data are relatively large, the smoothing leads to large data errors. Therefore, the smoothing function is available for the traces whose measure parameters are reflection S parameters.

To switch on or off the smoothing function, click the **Smoothing** checkbox in the **Parameter** bar of the **TDR/TDT** tab.

9.6.7 Trace Allocation

The TDR option will delete all existing traces and windows, allocate all the traces and windows automatically for the DUT topology, and set the traces to default settings if the trace allocation function is activated. The operation deletes all original traces and their settings, but the channel settings remain. There are three allocation methods to choose from: The option **Mixed** means that the traces in the time and frequency domain are allocated. The option **All T** means that only traces in the time domain are allocated. The option **All S** means only traces in the frequency domain. Note that in Single-ended 1 Port topology, only the option **Mixed** is available.

To use the trace allocation function, click the button of the corresponding method in the **Allocation** box in the **Trace Control** bar of the **TDR/TDT** tab.

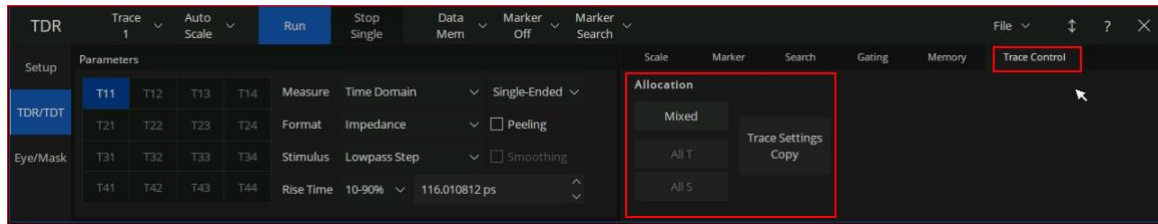

Figure 9-11 Trace Control Tab

9.6.8 Trace Setup Coupling

To switch on or off the time domain or marker coupling, click the **Time domain** or **Marker** checkbox in the **Coupling** box in the **Trace Control** bar of the **TDR/TDT** tab.

9.6.9 Time Domain Gating

The time-domain gating function transforms the time domain response into the frequency domain after removing a part of the response. Usually, the function is used to simulate the expected frequency domain response after removing some faults by removing the abnormal responses resulting from the impedance discontinuities. The operation procedure includes enabling the time domain transformation, setting the parameter to remove partial time-domain responses, observing the other traces in the frequency domain whose gating settings are coupled with the trace, or close the time domain transformation to observe the frequency responses.

The time-domain gating settings in the TDR option can be changed in the **Gating** bar of the **TDR/TDT** tab.

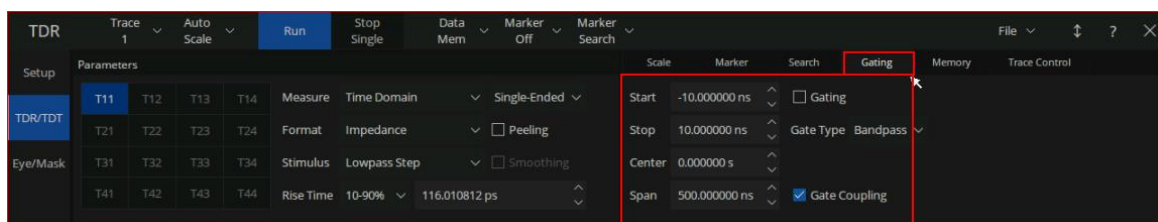

Figure 9-12 TDR Gating Tab

To switch on or off the time domain gating function, click the **Gating** checkbox.

To change the function type of the gating range, click the ratio button in the **Type** box. The option **Notch** means that the responses in the gating range will be ignored, while the option **Bandpass** means that the responses beyond the gating range will be ignored.

The scroll-wheel and textbox can be used to change the start and stop position of the time domain gating range.

9.7 TDR Data Analysis & Output

The general marker search function is available in the TDR option for data analysis, and there are some shortcuts provided at the top of TDR toolbar for marker management and search for maximum/minimum with tracking. In addition, the functions of the rise time search and delta time search are introduced as the time domain trace data analysis tools in the TDR option.

To correct the errors of impedance calculation resulting from the complicated distribution of mismatches in the DUT, a peeling algorithm is introduced to reveal the actual impedance value of every point on the passive DUTs.

The shortcuts to save/recall the state files, output the trace data to the files, and save the screenshot are provided in the **File** pull-down menu at the top of the TDR toolbar.

9.7.1 Marker Setup

In addition to the general ways to manage the markers in the VNA, the **Marker** pull-down menu at the top of the TDR toolbar is a way to add or delete markers.

The order in the first group of the **Marker Search** pull-down menu is shortcuts to manage the common marker tracking marker. The option **Off** closes the search function of the current marker, while the **Max** or **Min** starts the tracking search for maximum or minimum.

9.7.2 Rise Time Search

Rise time search is only available for the trace in the time domain, which searches for the rising or falling edge, sets a label to the start and stop, and displays the transition type and time at the top left corner of the window if successful. It's a tracking search, the results update if the trace data changes.

To switch on or off the rise time search, click the **Rise Time(10-90%)** or **Rise Time(20-80%)** option in the **Marker Search** pull-down menu. Selecting the suitable search type depends on the requirements.

9.7.3 Delta Time Search

Delta time search is only available for the trace in the time domain, which searches for the difference between the time where two traces rise or fall to a specified relative level in respective transition edge. If successful, a label will be set to the relative level on both traces, and the results will be displayed at the top left corner of the window that contains the start trace of the search. It's a tracking search, the results update if the trace data changes.

Click the **ΔTime...** order in the **Marker Search** pull-down menu to open the **ΔTime** dialog, and the settings of delta time search can be changed here.

Click the **Trace(Start)** pull-out menu to change the start trace of the search, click the **Trace(Stop)** pull-out menu to change the stop trace. A trace in the time domain can start one search at most as a start trace, while it's allowed that more than one searches set the same trace as the stop trace.

The target relative level of the search can be set in the **Position(%)** textbox in the dialog.

To switch on or off the search, click the **ΔTime Enable** checkbox.

9.7.4 Peeling

If there are two or more impedance mismatches on the DUT, a part of the incident wave is reflected at the first mismatch, the incident energy arriving at the next mismatch reduces, so the reflection at the next mismatch might seem weaker than that in reality. Calculating impedance using reflection coefficients might lead to obvious errors after the first mismatch. To avoid the effect of the masking phenomena explained above, a new approach to calculate impedance, called the peeling algorithm, is introduced in the TDR option. The algorithm divides the DUT into many sections, calculates the impedance of the next section by the impedance of the last section as the reference value, and the incident and reflected energy in reality.

The algorithm presupposes that the energy sum of input equals that of output at any points on the path the signal transmits through, which means that the signal transmits through the DUT without loss. This is an imperfection of the algorithm, and transmission loss always decreases the accuracy. Because of the recurrence method in the algorithm, the accuracy also decreases with the distance increases.

If the peeling function is enabled, the TDR option calculates impedance in the way explained above, instead of the traditional way. The function is available only if the format of the trace is **Impedance** of the reflection T parameters. To switch on or off the function, click the **Peeling** checkbox in the **Parameter** bar of the **TDR/TDT** tab.

9.7.5 File & Data Output

In the **File** pull-down menu at the top of the TDR toolbar, there are some shortcuts for file operation and data output.

The order **Save State...** is used to save the current state and calibration data as a **.CSA** file, and **Recall State...** is used to restore them from the files.

The order **Save Trc Data...** is used to save the current trace data to **.CSV** file, and **Save SnP...** saves all available S parameters data as an **.SNP** file whose format depends on the DUT topology.

Screenshot... is used to save the screenshot as a **.PNG** file.

9.8 Eye Diagram Simulation

9.8.1 Overview

Eye diagrams are used to analyze the influence of the intersymbol interference and noise on transmission performance, which is an important tool for signal integrity analysis. The eye diagram simulation function, included with the TDR option, is built on a virtual digital signal generator and the frequency characteristics of the DUT. It simulates that a virtual input digital signal transmits through the DUT, and analyzes the output signal to get an eye diagram. This is different from the traditional way of using an oscilloscope to draw eye diagrams. There is no need to provide an external digital signal to the input port of the DUT. To simulate different input signals, change the stimulus settings in the eye diagram module.

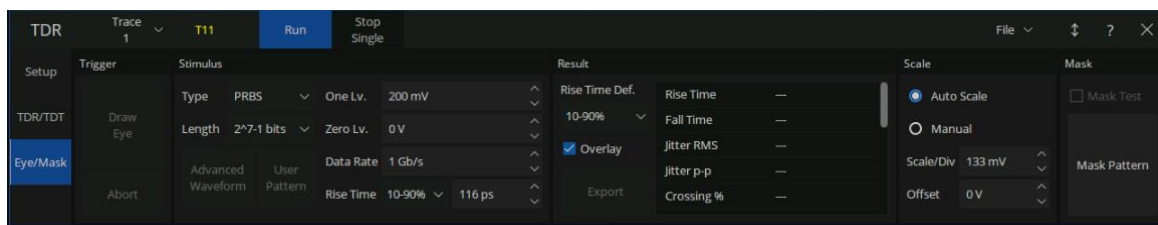

Figure 9-13 Eye/Mask Tab

The data analysis of eye diagrams in the option will try to get the numerical characteristics of the diagram and mark them on the diagram if required, which is designed to help the users obtain the key information quickly.

The jitter injection and statistical eye diagram function are provided to analyze the influence of the jitter in the input signal on the transmission performance.

The mask test on the eye diagram and preinstalled mask patterns are a convenient method of estimating whether the eye diagram meets the design requirements.

To start an eye diagram simulation after completing the simulation settings, click the **Draw Eye** button in the **Trigger** box of the **Eye/Mask** tab.

9.8.2 Stimulus Bit Pattern

There are 3 bit pattern types to choose in the option: Pseudo-Random Binary Sequence (PRBS), K28.5 comma code, and the user's bit pattern.

For more information about PRBS, refer to the section [Bit Pattern Length](#). K28.5 comma code is defined in an industry-standard developed by IBM which includes comma (control) characters. The user's bit pattern is imported from the user-defined files. The introduces of the bit pattern types in the table as follow:

Type	Bit Pattern Length	Generator
PRBS	Depends on the users, limited in 2^n-1 , $n = 3,5,7,9,11,13,15$	Generated by a virtual PRBS generator
K28.5	20	"00111110101100000101" (20 bits)
User	limited between 2 and 8192	Imported from a user-defined file

9.8.2.1 Bit Pattern Type

To change the input bit pattern types, click the **Type** pull-down menu in the **Stimulus** box of the **Eye/Mask** tab.

The option **Statistical** in the menu is used to switch on the statistical eye diagram mode, which cannot change the bit pattern types for the normal eye diagram simulation.

9.8.2.2 Bit Pattern Length

The bit pattern length of K28.5 code is 20 bits, and that of the user pattern depends on the text in the file. Only the length of PRBS can be changed in the eye diagram simulation module by clicking the **Length** pull-down menu in the **Stimulus** box.

A set of Linear Feedback Shift Register (LFSR) is simulated to generate virtual PRBS, whose maximum period is selected to equal the bit pattern length. The maximum of the period of PRBS, generated in a set of LFSR of n level, is 2^n-1 . In the other words, in ideal conditions, the sequence will iterate all possible binary numbers of n bits. The initial condition of the LFSR is random, PRBS generated becomes random to find the worst bit pattern of n bits for transmission performance. Eye diagram simulation always includes all n -bit input patterns to show the worst transmission performance of DUT, if PRBS is set as the input signals. So it's recommended to use PRBS as a bit pattern to draw eye diagrams.

The bit pattern length of PRBS is limited in 2^n-1 , and $n = 3, 5, 7, 9, 11, 13, 15$. That means the bit pattern will be generated by LFSR of n level, to include the worst condition as far as possible. The larger length is selected, the degree of the simulation perfection for intersymbol interference becomes better, but running time becomes longer.

9.8.2.3 User Pattern

If the eye diagram is required to simulate the specific bit pattern as the input signal, select the option **USER** in the **Type** pull-down menu, and click the **User Pattern** button to open the **Bit pattern Editor** dialog to set the user-defined pattern. In the dialog, you can load .txt files to import the text as the bit pattern and edit the bit pattern in the textbox. Close the dialog after loading or saving the bit pattern file, the pattern will be used for the next eye diagram simulation.

The text file to load must contain 0 and 1, but any other characters; and the length of text must be between 2 and 8192.

9.8.3 Stimulus Signal Setup

9.8.3.1 Logic Level

To change the logic level of the input signal, set the value in the **One Lv.** or **Zero Lv.** textbox in the **Stimulus** box.

9.8.3.2 Data Rate

The data rate of the signal is the number of bits transmitted per second, which reflects the base frequency of the signal. Considering the lowpass characteristics of transmission systems in reality, the transmission becomes bad with a large data rate, and the signal integrity analysis becomes important.

To change the data rate of the input signal, set the value in the **Data Rate** textbox in the **Stimulus** box.

9.8.3.3 Rise Time

The rise time of the signal reflects the steepness of the transition edge. The smaller rise time means the higher degree of steepness, the larger proportion of high-frequency parts, and the more serious high-frequency losses can be during transmission. It's effective to widen the eye by reducing the rise time properly. But too small a rise time leads to ringing phenomena at the logic level of the output signal, resulting in the decrease of the eye height.

To change the rise time type or value of the input signal, operate the **Rise Time** pull-down menu or textbox in the **Stimulus** box.

9.8.4 Eye Diagram Analysis

During the eye diagram simulation, the option analyzes the eye diagram automatically and try to get the numerical characteristics as follow: **Rise Time, Fall Time, Jitter, Crossing Percent, Opening Factor, The Ratio of Signal to Noise, Duty Cycle Distortion, Level One, Level Zero, Level Mean, Amplitude, Height, Width.** And **Rise Time, Fall Time, Jitter (peak-peak value), Amplitude, Height, Width** are allowed to be marked on the eye diagram to conveniently obtain the characteristics of the eye diagram.

9.8.4.1 Analysis Result Overlay

To switch on or off the data analysis markers on the diagram, click the **Overlay** checkbox in the **Result** bar.

9.8.4.2 Rise Time in Data Analysis

To change the rise time type for data analysis of eye diagrams, click the **Rise Time Def.** pull-down menu in the **Result** bar.

9.8.5 Eye Diagram Scale Management

By default, the eye diagram is displayed in the automatic scale settings, which show the details as clearly as possible. They can also be manually changed.

The scale settings in the vertical axis can be changed manually. But those in the horizontal axis depend on the data rate of the input signal, which can't be changed after the simulation starts.

To switch to a scale setting mode, click the **Auto Scale** or **Manual** radio button in the **Scale/Mask** bar.

To change the scale or offset values in **Manual** scale mode, set the value in the **Scale/Div** or **Offset** textbox. The **Offset** value here is the value that the center vertical scale line refers to.

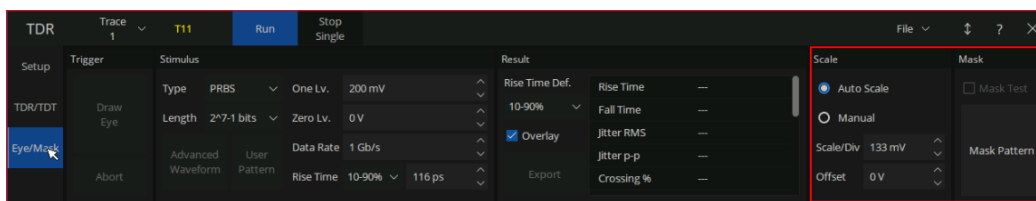

Figure 9-14 Eye/Mask setting

9.8.6 Mask Test for Eye Diagram

Mask patterns are some areas where the eye diagram is forbidden to pass, which transfer the design requirements of the transmission systems into the numerical characteristics of eye diagrams. They usually rule the tolerance of logic 0,1 level and rise or fall time. If the eye diagram passes through the areas, the TDR option judges that the eye diagram can't meet the requirement, leading to the failure of the mask test. According to different communication standards, or at the different nodes in a communication system, different mask patterns should be applied. The first step to mask test is to select or design a suitable mask pattern based on the requirements.

To select or change the mask pattern applied, click the **Mask Pattern** button in the **Scale/Mask** bar to open the **Mask Pattern** dialog.

In the **File** tab of the dialog, preinstalled standard patterns or user-defined mask files (.MSK format) can be loaded. In the **Scale** tab, the **Margin** of the mask, start **Position** of a bit, **Delta** time of a bit, and **Logic Level** can be set in textboxes. In the **Edit** tab, the positions of vertices in the mask pattern can be changed by set values in the textboxes. Dragging the vertices in the left window also makes sense, but it's recommended to drag with a mouse connected to the VNA, because the points may be too close together for easy entry using touch operation.

Close the dialog after saving the modifications to a mask file, the new pattern will be applied to the next mask test.

To switch on or off the mask test, click the **Mask Test** checkbox in the **Scale/Mask** bar.

9.8.7 Jitter & Statistical Eye Diagram

Jitter is the transient deviation from the corresponding ideal position of a signal over successive trigger events. High jitter worsens the transmission performance. It's divided into the Deterministic Jitter (DJ) and the Random Jitter (RJ). RJ is generated by some unpredictable factors and is independent of the input bit patterns. The models for RJ usually have a Gaussian distribution, and the magnitudes are represented in root mean square (RMS) values. DJ is generated by some repeatable and predictable factors and usually has a finite magnitude value. The jitter related to the input bit patterns in DJ is called the Data Dependent Jitter (DDJ), while the other jitter in DJ is called the Periodic Jitter (PJ).

To change the settings of the jitter injection, click the **Advanced Waveform** button in the **Stimulus** box of the **Eye/Mask** tab, or click the buttons in the **Adv Waveform** bar of the **Setup** tab, to open the **Advanced Waveform** dialog. Click the **Jitter** button at the top of the dialog to switch to enter the jitter setting interface.

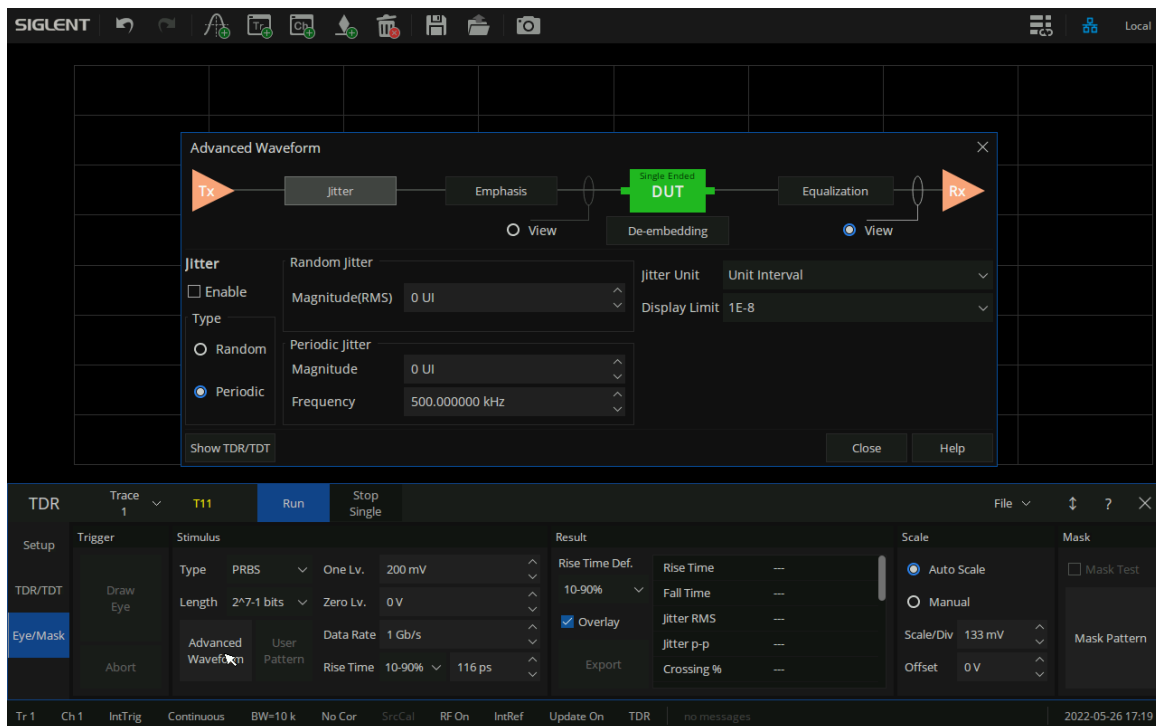

Figure 9-15 Eye jitter setting

To change the jitter type injected into the input signal, click the **Random** or **Periodic** ratio button in the **Type** box. To set the jitter parameters, set the values in the corresponding textboxes.

To select the jitter magnitude units, click the **Jitter Unit** pull-down menu. The unit UI means that the time difference value between the zero time of two adjacent transition edges in the signal, which is the default jitter magnitude unit.

To set the probability limit to display in the statistical eye diagram, click the **Display Limit** pull-down menu. If the probability of the signal appearing is lower than the display limit, it will be ignored and set to zero in the statistical eye diagrams.

To switch on the jitter injection for the next simulation after completing the jitter settings, click the **Enable** checkbox in the jitter setting interface. When the jitter injection function is switched on, the statistical eye diagram mode is enabled at the same time, the input bit pattern type is switched to **Statistical**.

To switch to the statistical eye diagram mode in manual, select the option **Statistical** in the **Type** pull-down menu in the **Stimulus** box. In the statistical mode, the input bit pattern is set to PRBS with a fixed length, so the statistical eye diagrams might be slightly different in several simulations of the same settings. The probabilities are represented by colors in the statistical eye diagrams: Warm colors indicate a large probability, red represents the largest ones; cold colors indicate a small probability, with deep blue representing the smallest values.

9.9 TDR Advanced Waveform Function

The Advanced waveform function is applied in both modules of the TDR option, TDR/ TDT analysis, and eye diagram simulation, which includes viewpoint setting, emphasis/ de-emphasis, de-embedding, and Continuous Time Linear Equalization (CTLE).

The corresponding settings in the **Advanced Waveform** dialog, which can be opened by clicking the buttons in the **Adv Waveform** bar of the **Setup** tab or the **Advanced Waveform** button in the **Stimulus** box of the **Eye/Mask** tab.

To switch the dialog to the interface for setting the specified function, click the corresponding button at the top of the dialog.

9.9.1 View point

To switch the viewpoint of the waveform to stimulus or responses, click the corresponding **View** ratio button at the top of the dialog.

Click the ratio button before the DUT icon, switch the viewpoint to stimulus, and the trigger mode is set to **Hold /Stop**, the transmission parameters show the stimulus signal only processed by emphasis /de-emphasis, which is the signal transmitted to the DUT. Setting the trigger mode to **Continuous /Run**, the viewpoint will be set to responses automatically.

Click the ratio button after the DUT icon, switch the viewpoint to responses, and set the trigger mode to **Continuous /Run**. The transmission parameters show the responses processed by emphasis /de-emphasis, DUT, and equalization.

9.9.2 Emphasis/De-emphasis

Because of the lowpass characteristics of transmission systems, the high-frequency components in the signal have higher losses than those at lower frequencies and the phenomenon becomes more serious as the transmission distance increases. The phenomenon is the main contributor to signal distortion during transmission. To control this distortion, the emphasis /de-emphasis technology is introduced to compensate for these additional losses by increasing the relative levels before the transmission. Transition edges in the time domain represent high-frequency components in the frequency domain. Emphasis /De-emphasis technology is designed to increase the level variation of the edges by adjusting the levels of the bits close to the edges. The parameters to adjust the levels of the first bit before or after the edges, and those for the two bits after the edges, are provided in the TDR option and are defined as Pre Cursor, Post 1 Cursor, Post 2 Cursor. By

changing these parameters, it's easy to simulate the influence of the different emphasis/de-emphasis strategies on the transmission performance in eye diagram simulations.

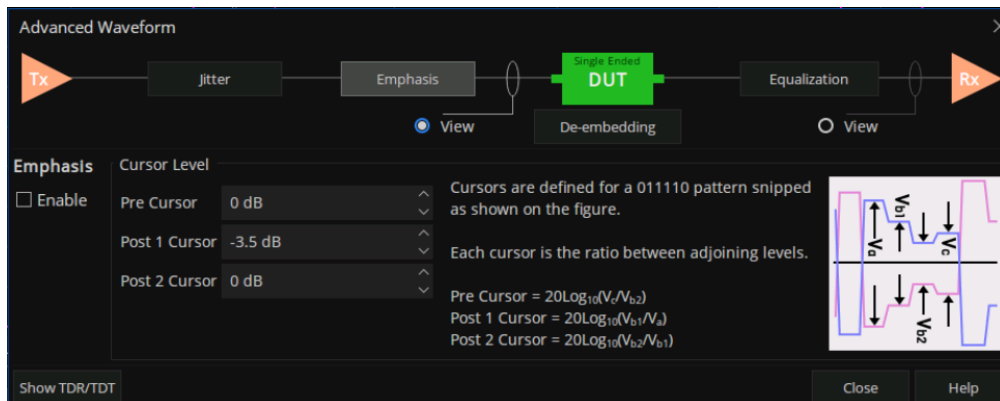

Figure 9-16 Emphasis setting

To change the parameters, set the value in the textbox in the **Emphasis** interface, and click the **Enable** checkbox to enable the function. The function is available in transmission parameters measurement and eye diagram simulations.

9.9.3 Equalization

To control the signal distortion resulting from the additional loss of high-frequency signal components, equalization technology is introduced to amplify the high-frequency parts properly after receiving the signal to balance the loss over various frequency spans. A highpass filter and a continuous-time linear equalizer (CTLE) can be implemented. The CTLE simulation function in the TDR option allows the user to adjust the system function of the equalizer, to simulate the influence of the equalization on the transmission performance in eye diagram simulations.

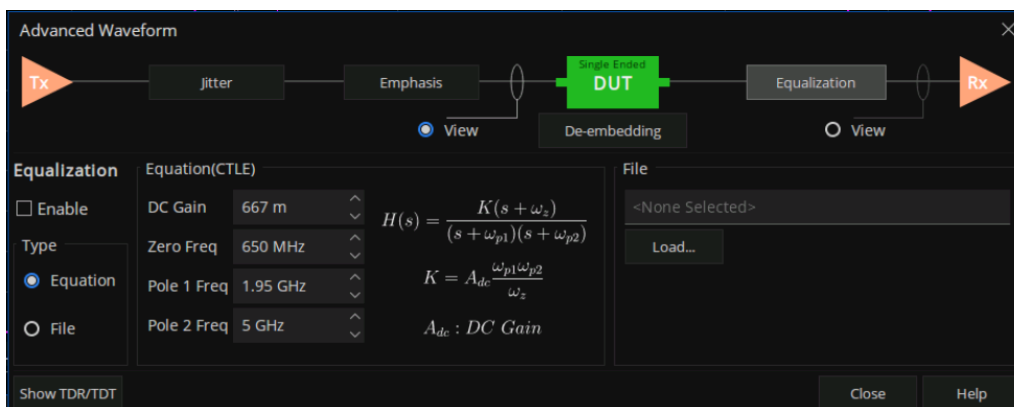

Figure 9-17 Equalization setting

To change the system function, set the value in the textbox in the **Equalization** interface, and click the **Enable** checkbox to enable the function. The function is available in transmission parameters measurement and eye diagram simulations.

10 Guide For the SA Option

10.1 Overview

Spectrum Analysis function is based on the VNA hardware, by adjusting the local oscillator signal and mirror suppression algorithm processing to obtain the signal spectrum, so as to achieve spectrum analysis function.

10.2 User Interface

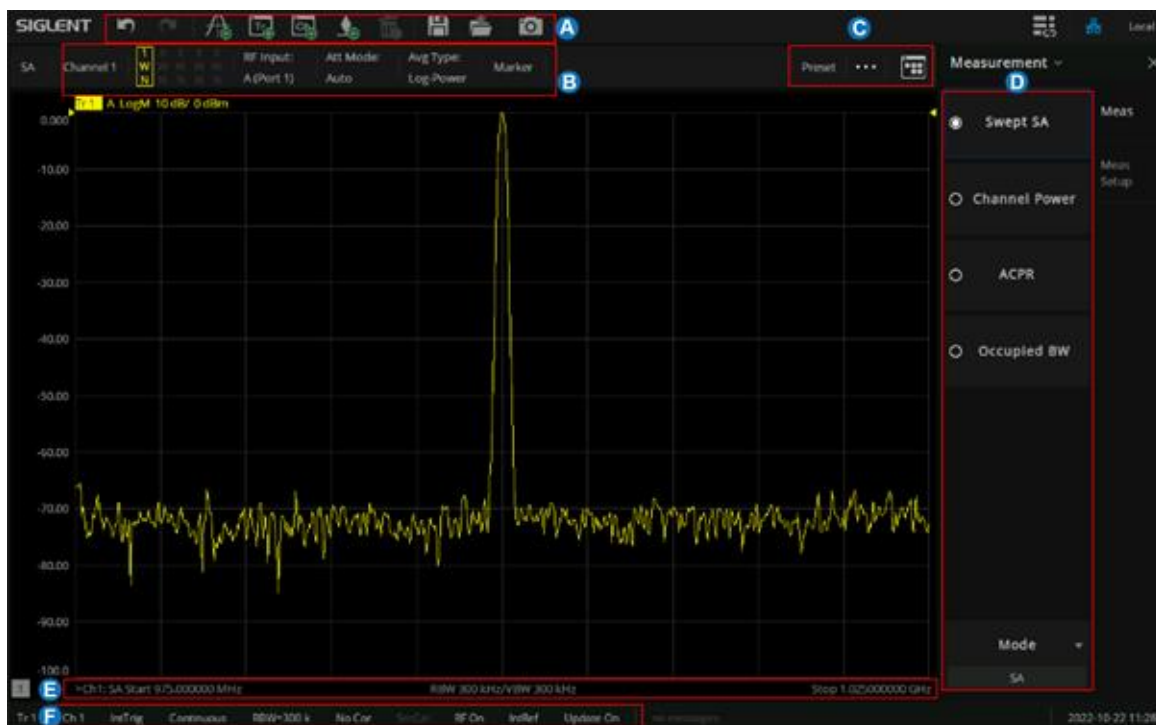

- A. Active Entry
- B. Indicate the main working state of state, the port of RF input, Attenuation mode, Average Type, Current Marker operation.
- C. Display the SA setting dialog box, SA parameter reset, SA processing flow chart
- D. SA Measurement items.
- E. Indicate and control the main sweep parameters, such as frequency, resolution.
- F. Status bar.

10.3 Create a Spectrum Analysis Channel

Press [Meas] > S-Params > Mode > SA. The SA channel selection dialog box will be displayed after the SA measurement mode was selected. Select “Active Channel” (delete the existing measurement) or “New Channel” then click OK. A Spectrum Analysis measurement is displayed on the current channel or on a new channel and New Window.

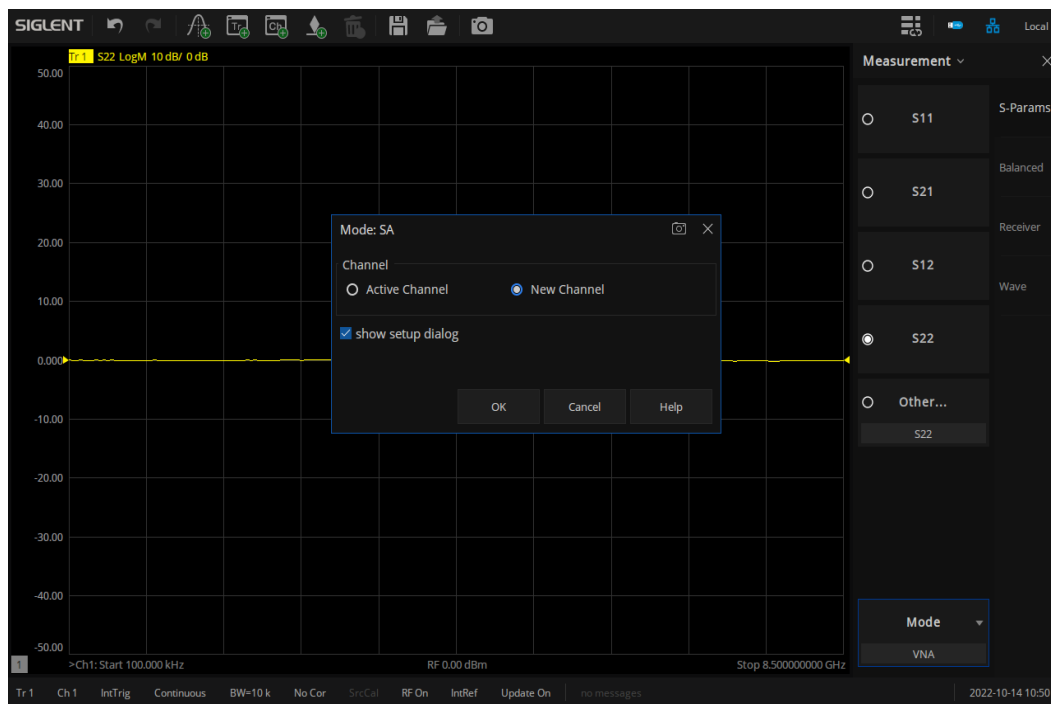

Figure 10-1 SA mode channel selection dialog box

In the interface of the SA channel selection dialog box, The “show setup dialog” check box is selected by default. When user clicks “OK”, a SA Setup dialog box will be displayed that can set related parameters. As figure shown below:

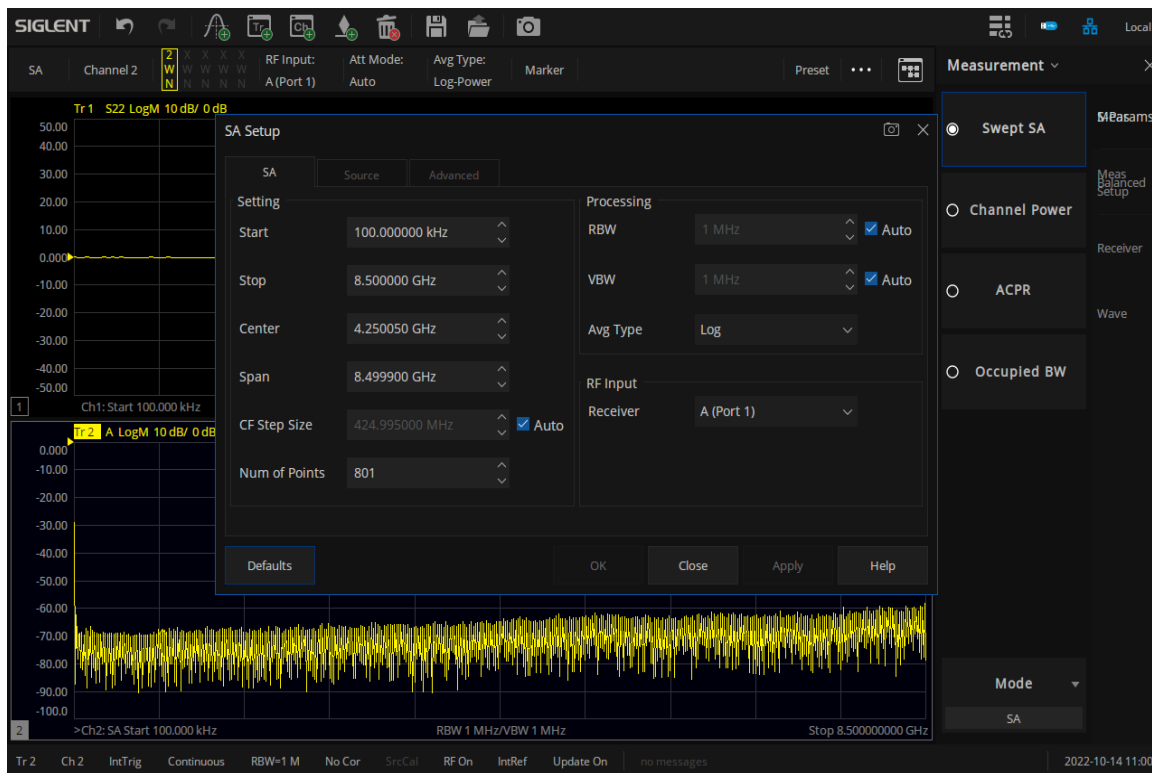

Figure 10-2 SA Setup dialog box

If the show Setup Dialog check box is deselected, the SA Setup dialog box will not be displayed when the SA function is enabled. If the user wants to modify the SA parameters, there are two ways to enter the SA Setup dialog box.

- Press [Sweep] > Sweep > SA Setup... to recall the SA Setup dialog box.
- Press [Power] > Power > SA Setup... to recall the SA Setup dialog box.

10.4 Spectrum Analyzer Settings

The SA Setup dialog box has three tabs: SA Tab, Source Tab and Advanced Tab.

The SA Tab configures the SA frequency range, CF step, sweep points, RBW, VBW, Average type and RF Input .Receiver.

The Source Tab is the configuration of signal parameters when uses the internal source for spectrum analysis.

The Advanced Tab the configuration of relevant parameters related to signal processing.

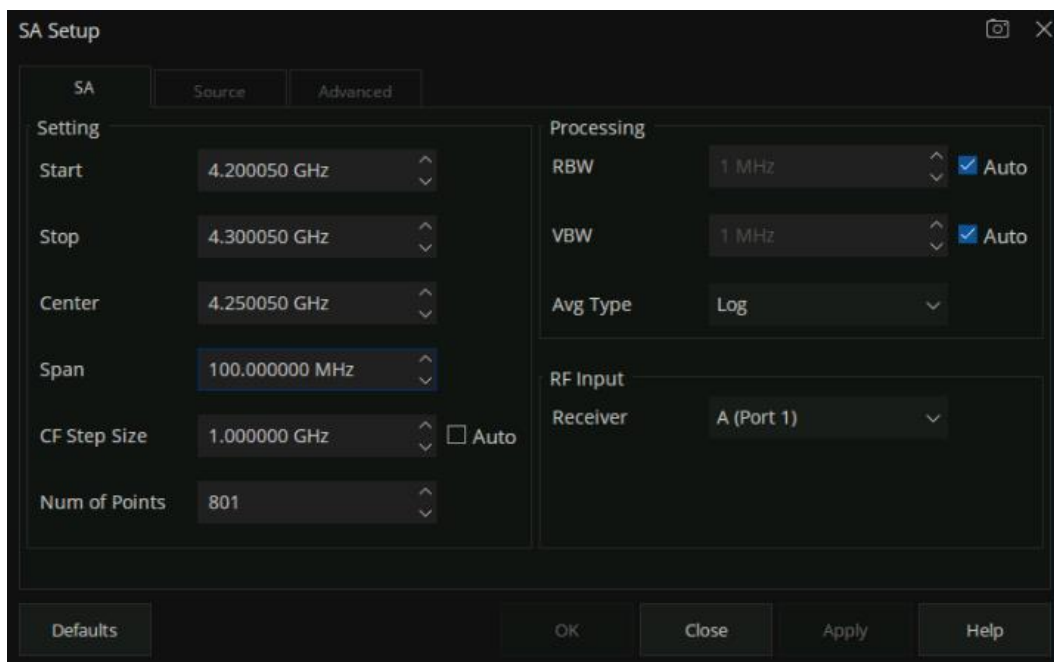

Figure 10-3 The SA Tab setting interface

10.4.1 SA Tab Setting

SA Tab Setting is mainly related to Spectrum analysis frequency setting, which can be set through the SA Setup dialog box or by pressing the [Freq] key on the front panel to enter the frequency setting menu, as the figure shown below. If the frequency is changed, the frequency sweep will restart.

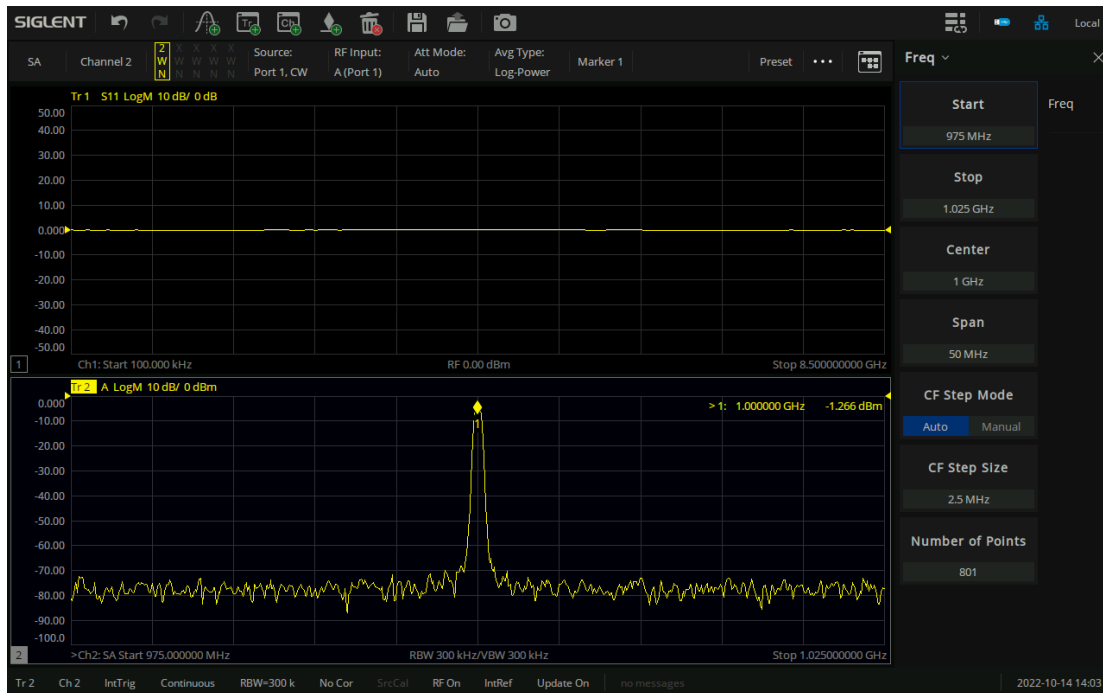

Figure 10-4 [Freq] key to set SA frequency parameters

The frequency range of a channel can be expressed by three parameters: Start Frequency, Center Frequency and Stop Frequency. If any of the parameters change, the others will be adjusted automatically in order to ensure the coupling relationship among them:

$$f_{center} = (f_{start} + f_{stop})/2, f_{span} = f_{stop} - f_{start}$$

10.4.1.1 Start Frequency

Set the start frequency of the Spectrum Analyzer. The start frequency and the stop frequency will display at the bottom of the grid respectively.

- The span and center frequency vary with the start frequency when the Span does not reach the minimum.

10.4.1.2 Stop Frequency

Set the stop frequency of the Spectrum Analyzer. The start frequency and the stop frequency will display at the bottom of the grid respectively.

- The span and center frequency vary with the stop frequency.

10.4.1.3 Center Frequency

Set the center frequency of the Spectrum Analyzer.

- Modifying the center frequency will modify both the start frequency and stop frequency when the span is constant (except when the start frequency or stop frequency reaches the boundary).

10.4.1.4 Span

Set the span of the Spectrum Analyzer. Any changes of the span will restart the sweep.

Pay attention to the following points when set the span:

- The start and stop frequency vary with the span when the center frequency is constant.
- The span can be set down to 100 Hz and up to the maximum bandwidth.
- Modifying the span may cause an automatic change in both CF Step Size and RBW if they are in Auto mode. Besides, the change of RBW may influence VBW (in Auto VBW mode).
- Variation in the Span, RBW or VBW would cause a change in the sweep time.

10.4.1.5 CF Step Size

Setting the value of CF step will change the direction key step of center frequency, start frequency, stop frequency and frequency offset.

When Auto mode is selected, the Center frequency step Size is 5% of the current span. that is , $f_{CF\ step} = f_{span} * 5\%$. Each press of the ▲|▼ arrows on the front panel or click the up and down sign of the SA Setup's center box. The center frequency $f_{CF\ step}$ increases or decreases by the CF step size.

When Manual mode is selected, Users can customize the size of CF Step. Each press of the ▲|▼ arrows on the front panel or click the up and down sign of the SA Setup's center box. The center frequency $f_{CF\ step}$ increases or decreases by the CF step size.

10.4.1.6 Num of Points

The number of sweep points represents the number of sweep and trace displayed points (201~10001)

More sweep points will improve the resolution of waveform, but also affect the minimum sweep time, and increase the time of data processing and remote access to data, and reduce the response rate.

10.4.2 SA Tab Processing setup

The SA processing setup is to config the signal's parameters. User can set the parameters via the SA Setup dialog, or by pressing [AvgBW] > BW to enter the spectrum analysis signal processing parameters setting menu, as the shown figure below.

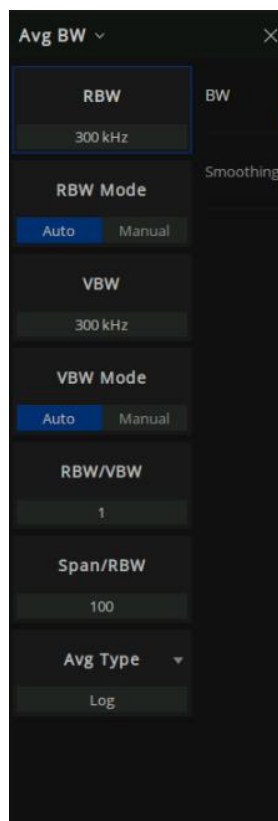

Figure 10-5 Spectrum analysis signal processing setup menu

10.4.2.1 RBW

Set the RBW (resolution bandwidth) in order to distinguish between signals which have frequency components that are near one another.

- Reducing the RBW will increase the frequency resolution. but lead to a longer sweep time (influenced by both RBW and VBW when the sweep time is in automatic mode).
- RBW varies with the Span/RBW setting in Auto RBW mode.

10.4.2.2 VBW

Set the video bandwidth in order to filter out the noise outside the video band.

- Reducing the VBW will smooth the trace and helps to highlight small signals from noise, but it will also increase the sweep time (Sweep Time is affected by a combination of RBW and VBW when it is in Auto mode).
- VBW varies with RBW when it is in Auto mode. While in Manual mode, VBW is not affected by RBW.

10.4.2.3 Detector Type

The analyzer displays the sweep signal on the screen in the form of a trace. For each trace point, the analyzer always captures all the data within a specific time interval and processes (Peak, Average, etc.) the data using the detector currently selected, then it displays the processed data (a single data point) on the screen.

Select an appropriate detector type according to the actual application in order to ensure the accuracy of the measurement.

The available types are Positive Peak, Negative Peak, Sample and Average. The default is Positive peak.

1. Positive Peak

For each trace point, Positive Peak detector displays the maximum value of data sampled within the corresponding time interval.

2. Negative Peak

For each trace point, Negative Peak detector displays the minimum value of data sampled within the corresponding time interval.

3. Sample

For each trace point, Sample detector displays the transient level corresponding to the central time point of the corresponding time interval. This detector type is applicable to noise or noise-like signal.

4. Normal

Normal detector (also known as normal detection or Rosenfell Detector) displays the maximum value and the minimum value of the sample data segment in turn: Odd-numbered data points display the maximum value and even-numbered data points display the minimum value. In this way, the amplitude variation range of the signal is clearly shown.

5. Average

For each trace point, Average detector displays the average value of data sampled within the corresponding time interval.

10.4.2.4 Averaging Type

Average type refers to the processing mode of intermediate frequency data in data detection and display detection, which affects the effect of trace average and detection average.

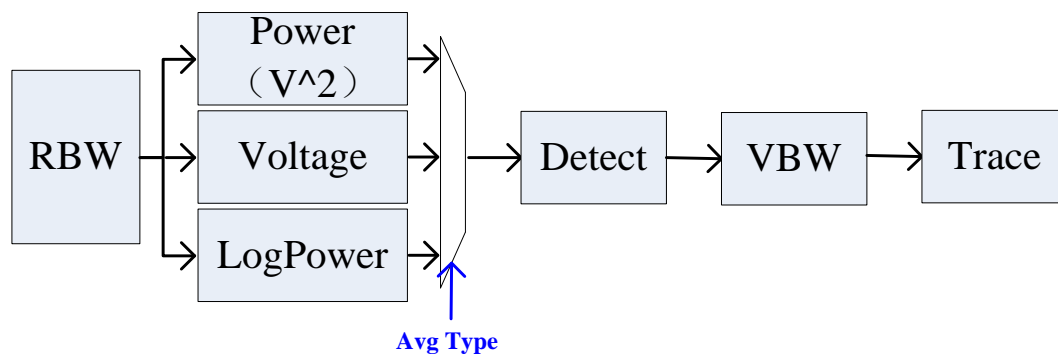

Figure 10-6 Flow chart of Average type

1. Log Power

Select the logarithmic (decibel) scale for all filtering and averaging processes. This scale is “Video” because it is the most common display and analysis scale for the video signal within analyzer. This scale is excellent for finding Sine/CW signals near noise.

2. Power Average

In this average type, all filtering and averaging processes work on the power (the square of the magnitude) of the signal, instead of its log or envelope voltage. This scale is best for real-time power measurement of complex signals.

3. Voltage Average

In this Average type, all filtering and averaging processes work on the voltage of the envelope of the signal. This scale is suitable for observing rise and fall behavior of AM or pulse-

modulated signals such as radar and TDMA transmitters.

10.4.2.5 RF Input Receiver

Select the receiver port for RF signal input.

10.4.3 Source Tab

The Source Tab of SA Setup is the configuration for internal sources as signal sources.

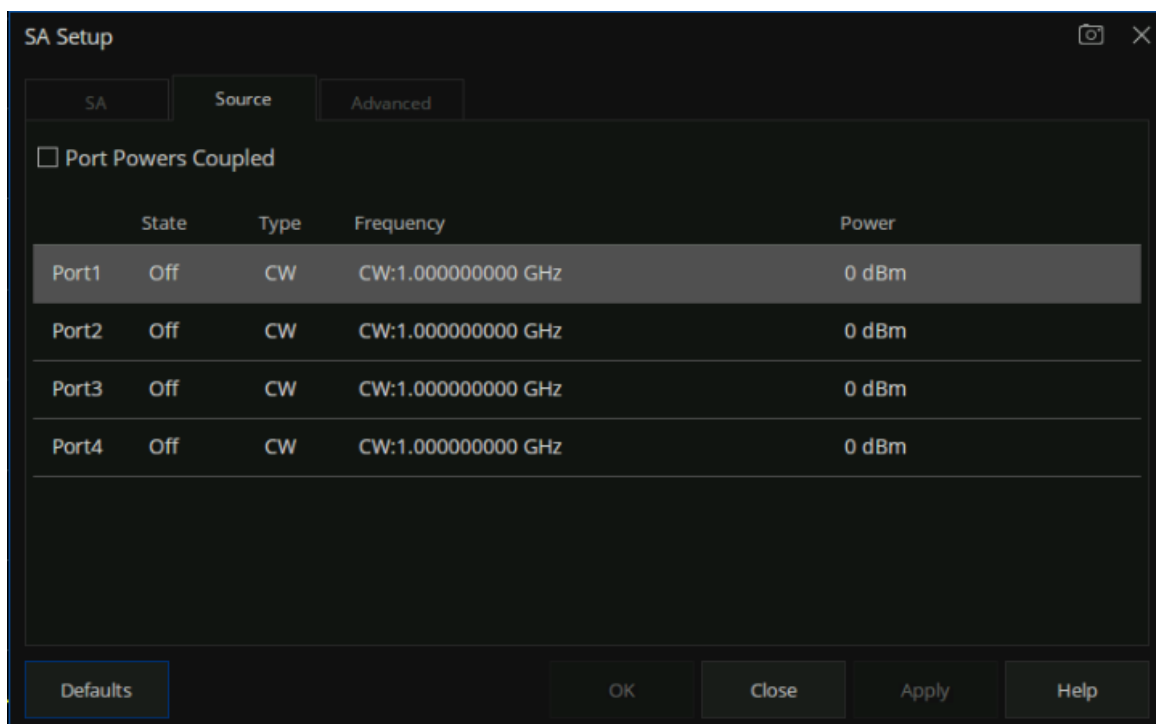

Figure 10-7 Source Tab

Port Powers Coupled (checked) the power levels are the same at each test port. Set power at any test port and all test ports change to the same power level.

SA Source Setup

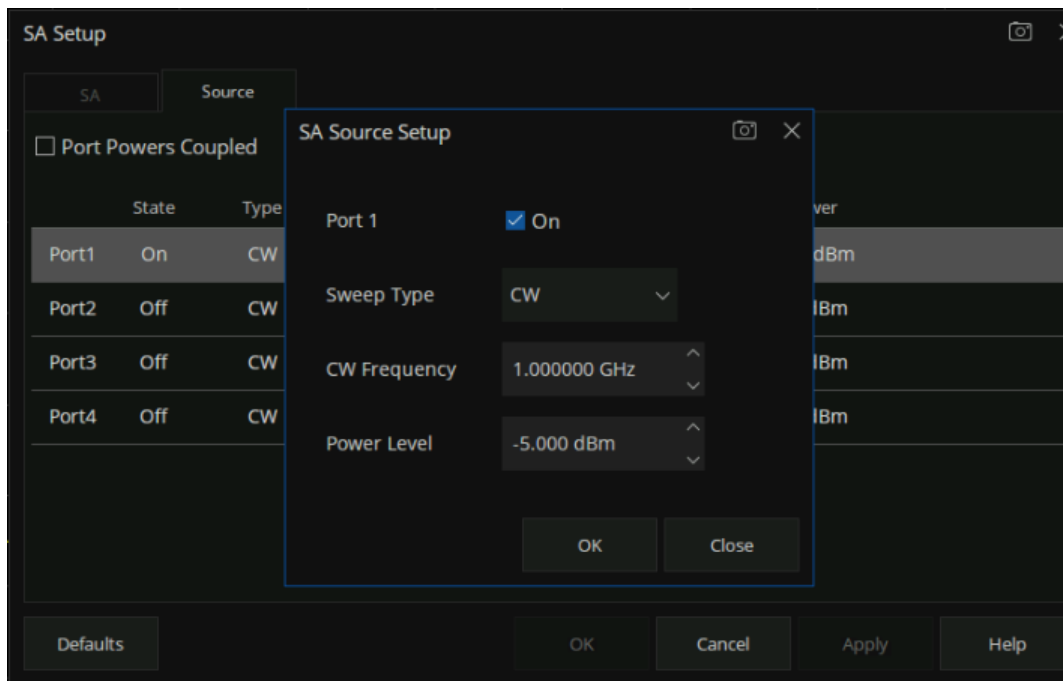

Figure 10-8 SA Source Setup

- State: If the “On” parameter is selected, the port source power is enable
- Type(Sweep):
 1. CW: The source is set to a CW frequency.
 2. Linear Freq: The source is set to a power sweep.
 3. Power: The source is set to a power sweep.
 4. LinFreq+Power: The source is set to sweep from the Start to Stop frequency and power sweep.
- Frequency: Set the sweep Frequency of the source.
- Power: Set the power level of the source.

When the internal source is used for the Spectrum analysis signal sources, the sweep type, source frequency and the port power level of the source can also be set by pressing the [Power] key on the front panel to enter the port power setting menu. As the figure shown below:

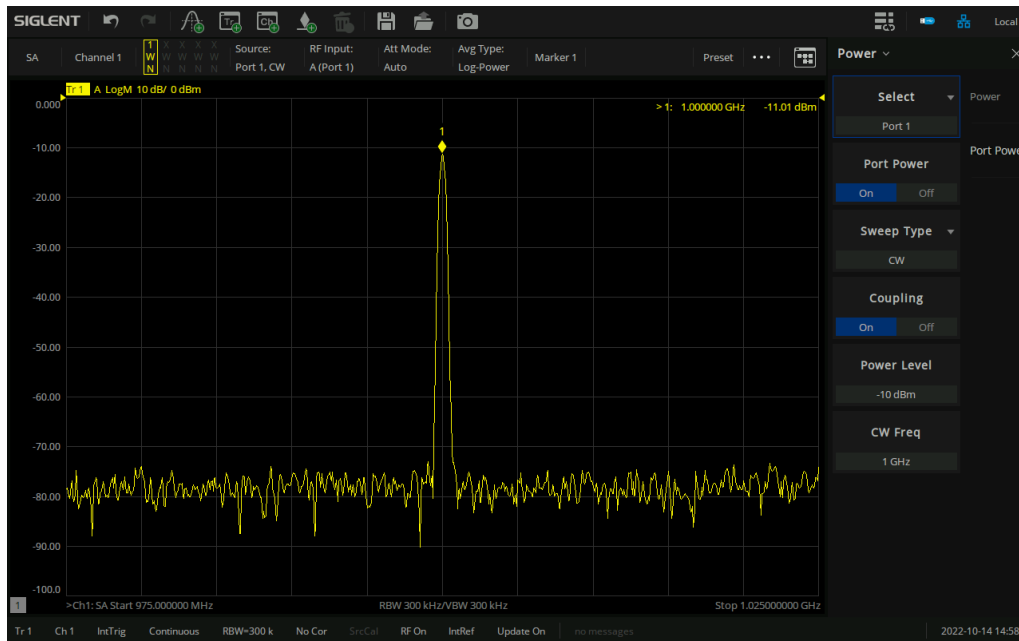

Figure 10-9 Press the [Power] key to enter the source's setting menu

10.4.4 Advanced Tab

The Advanced Tab is the configuration of parameters related to signal processing for Spectrum analysis, which can be set through the SA Setup dialog box or by pressing the [AveBW]>BW on the front panel to enter the setting menu, as the figure shown below.

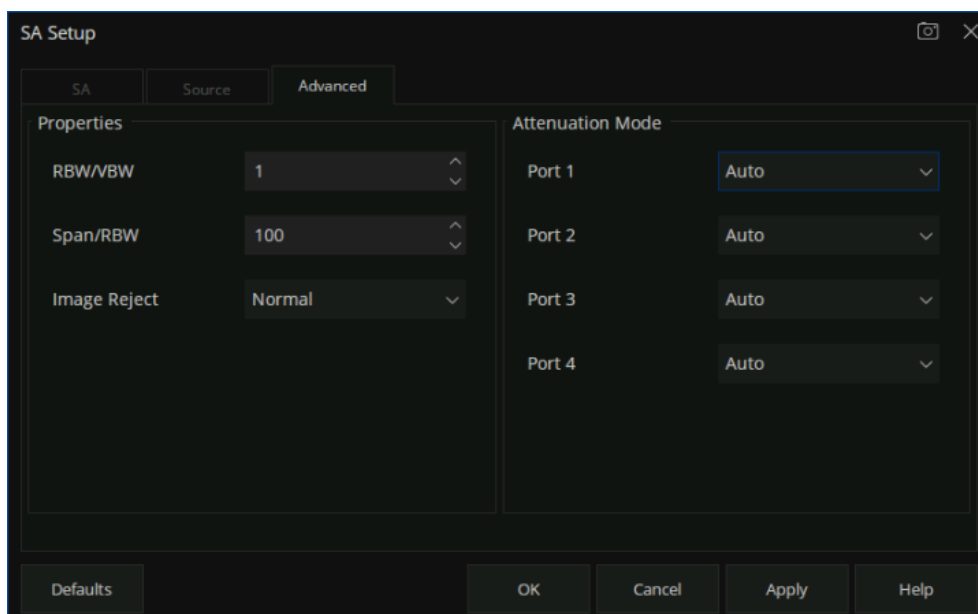

Figure 10-10 Advanced Tab setting menu

10.4.4.1 RBW/VBW

Sets the ratio of Resolution Bandwidth to Video Bandwidth when the Video Bandwidth is in Auto mode.

10.4.4.2 Span/RBW

Sets the ratio of Span to Resolution Bandwidth when the Resolution Bandwidth is in Auto mode.

10.4.4.3 Image Reject Type

The signal is mixed with the local oscillator to get an intermediate frequency signal, and the mixer may produce a mirrored frequency signal. Therefore, it is necessary to change the local oscillator or intermediate frequency to collect multiple groups of spectral data, and filter out the image through the image suppression algorithm.

None: Selects 1 acquisitions, and mirror suppression is not performed.

Min: Selects 3 acquisitions.

Normal: Selects 4 acquisitions.

Better: Selects 5 acquisitions.

Max: Selects 6 acquisitions.

Note: Only 3 sets of data can be acquisitions at most when the frequency point is below 40MHz.

10.4.4.4 Attenuation mode

Set the maximum power or voltage that can be currently displayed in the trace window. The value is displayed at the upper left corner of the screen grid.

The reference level is an important parameter of the spectrum analyzer, which indicates the upper limit of the current dynamic range of the spectrum analyzer. When the energy of the signal to be measured exceeds the reference level, nonlinear distortion or even overload alarm may be generated. The user should understand the nature of the signal to be measured and choose the reference level carefully. The reference level is too large to ensure full utilization of the linear range of the ADC, nor too small to be higher than the noise of the ADC. By setting a suitable reference level, the best measurement results can be obtained while protecting the spectrometer.

According to the amplitude of the input signal, the user can set the RF front-end attenuation mode of the response, which is to avoid the display distortion when the input signal is large and reduce

the noise when the input signal is small.

Input attenuation can be set up to Auto, Low Noise and Standard mode

- **Auto:** the attenuation value is automatically adjusted according to the state of preamplifier and the current reference level.
- **Low noise:** The minimum attenuation mode, The average noise level is lower.
- **Standard:** The maximum attenuation mode, The average noise level is higher.

10.4.5 Trace setup

Click the trace status area on the upper left corner of the interface, and the trace setting drop-down menu will pop up for trace setting operations.

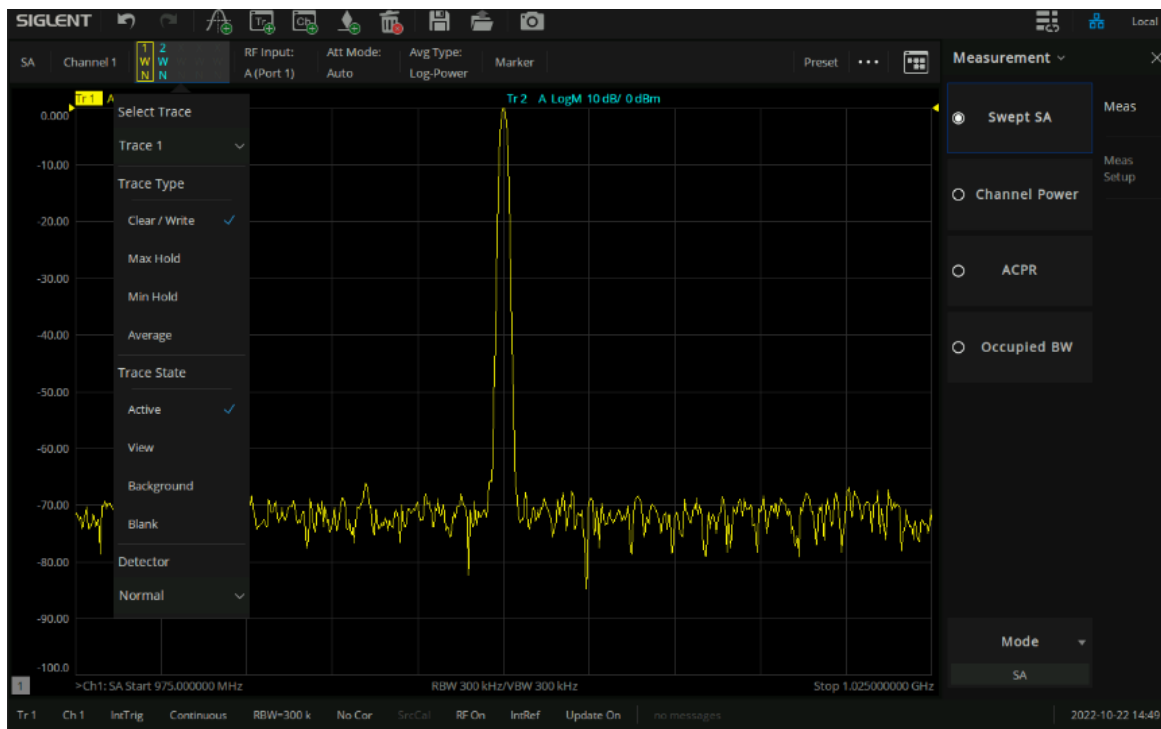

Figure 10-11 The trace Settings drop-down menu

10.4.5.1 Select Trace

Before operating on the Trace, the user needs to specify and only specify one trace at a time. The number of the selected trace will appear as selected in the status bar (with a yellow highlighted border).

10.4.5.2 Trace Type

There are four trace types: Clear/write, Max Hold, Min Hold, Average. Different trace types represent different processing methods of the trace data of a new frame on the historical frame data:

- **Clear/write** Erases any data previously stored in the selected trace, and display the data sampled in real-time of each point on the trace. The type identifier is “W”.
- **Max Hold** Retain the maximum level for each point of the selected trace. Update the data if a new maximum level is detected in successive sweeps. Max Hold is very effective when measuring events that may take successive scans to measure accurately. Some common applications include FM Deviation, AM NRSC, and frequency hopping or drift. The type identifier is “M”.
- **Min Hold** Display the minimum value from multiple sweeps for each point of the trace and update the data if a new minimum is generated in successive sweeps. The type identifier is “m”.
- **Average** Set the averages times of the selected trace. The type identifier is “A”.

More averages can reduce the noise and the influence of other random signals; thus highlighting the stable signal characteristics. The larger the averages times is, the smoother the trace will be. Enabling averaging will take more time to collect the full spectral information because the analyzer needs to sweep the set average count. The displayed data is averaged in a first-in-first-out fashion.

10.4.5.3 Trace State

There are four trace states: active, view, blank, and background. Different trace states indicate the refresh and display states of traces:

- **Active:** Refreshed and displayed trace data.
- **View:** The trace data will not be refreshed, and the current latest trace will be displayed in a fixed frame.
- **Background:** Refreshed trace data but no display.
- **Blank:** Trace data is no longer refreshed or displayed

10.4.5.4 Detector

The analyzer displays the sweep signal on the screen in the form of a trace. For each trace point, the analyzer always captures all the data within a specific time interval and processes (Peak, Average, etc.) the data using the detector currently selected, then it displays the processed data (a single data point) on the screen.

Select an appropriate detector type according to the actual application in order to ensure the accuracy of the measurement

The available types are Positive Peak, Negative Peak, Sample, Normal and Average. The default is Normal.

- **Positive Peak:** For each trace point, Positive Peak detector displays the maximum value of data sampled within the corresponding time interval
- **Negative Peak:** For each trace point, Negative Peak detector displays the minimum value of data sampled within the corresponding time interval.
- **Sample:** For each trace point, Sample detector displays the transient level corresponding to the central time point of the corresponding time interval. This detector type is applicable to noise or noise-like signal.
- **Average:** For each trace point, Average detector displays the average value of data sampled within the corresponding time interval.
- **Normal:** Normal detector (also called ROSENFELL Detector) displays the maximum value and the minimum value of the sample data segment in turn: Odd-numbered data points display the maximum value and even-numbered data points display the minimum value. In this way, the amplitude variation range of the signal is clearly shown.

User can manually select an appropriate detection type based on actual requirements and application scenarios to ensure measurement accuracy, or set the detection type to automatic.

10.5 Spectrum Analysis measurement

10.5.1 Marker → SA

During S parameter measurement, If the user wants to have a quick view of the specific frequency point's spectrum, spectrum analysis can be opened by means of Marker → SA. That is to create a new SA channel in full frequency span based on the S parameters, and a marker is created on the trace at the same frequency as the S parameter channel marker.

The same receiver that is used for the S parameter channel is used for the SA channel. For example, if a marker is opened in the S11 channel, a SA measurement is created using the receiver "A" of port 1 after "Marker → SA".

How to open Marker → SA:

1. Make an S parameter measurement, such as S44, set the center frequency as 1GHz and Span as 50MHz. and mark the S44 trace by pressing the [Marker] key on the front panel;
2. Press [Marker] > Marker Function > Marker → SA to enable the SA function. You can view the frequency spectrum of 1GHz point of the S44, as figure shown below:

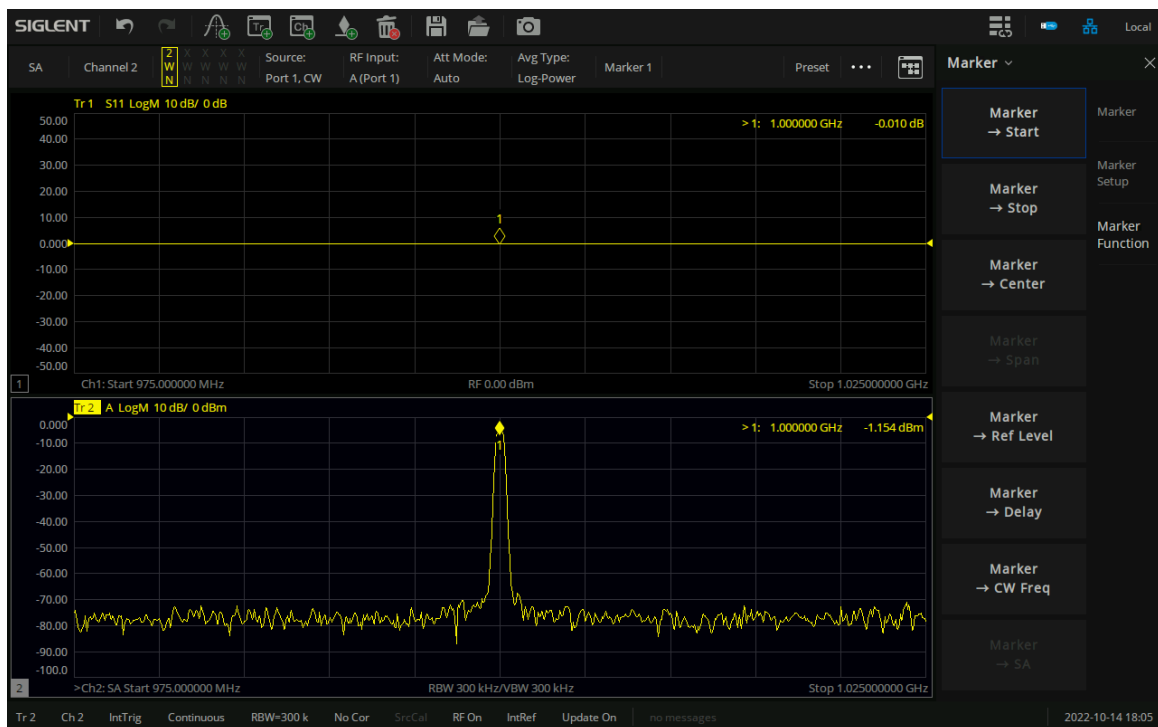

Figure 10-12 Marker → SA

Press [Sweep] > Sweep > SA Setup... can recall the SA Setup dialog box If the user needs to modify the SA parameter settings.

10.5.2 Channel Power

Measure the power and power density within the specified channel bandwidth. When this function is enabled, the span and resolution bandwidth are automatically adjusted to smaller values. Select "Channel Power" and click "Meas Setup" to set the corresponding parameters. The two vertical lines on the trace perpendicular to the X-axis represent the integration bandwidth. The Y-axis value is set to the measured power value, and displays on the upper right corner.

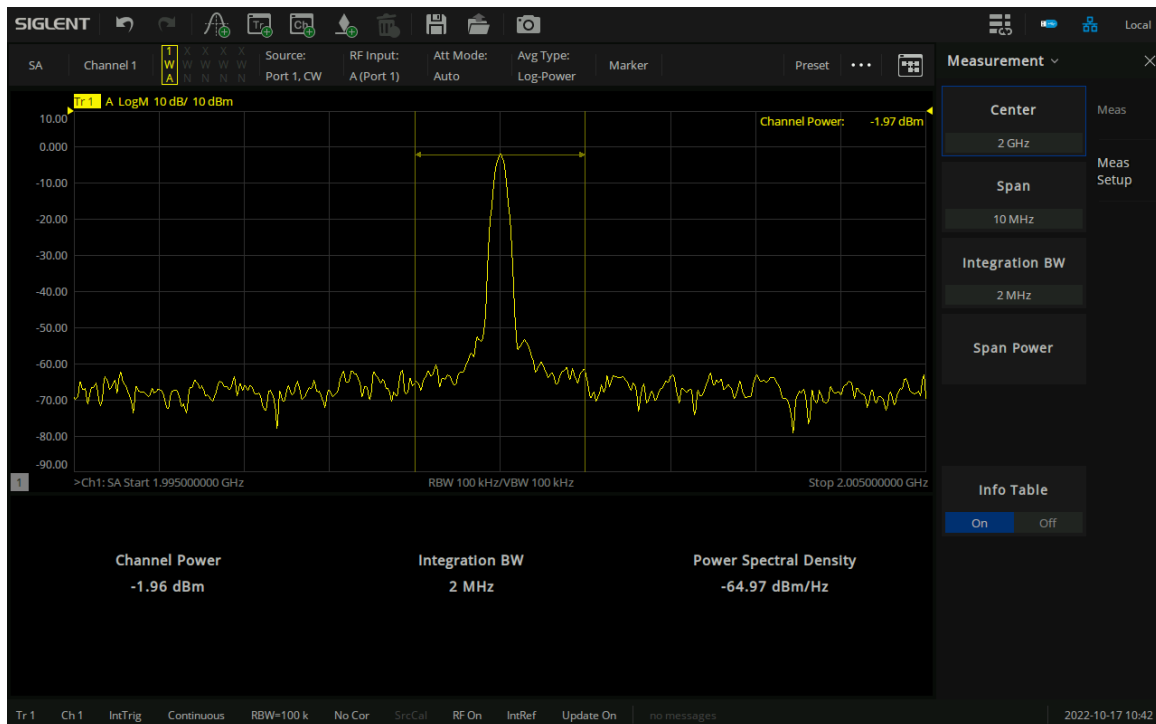

Figure 10-13 Channel Power measure

10.5.2.1 Integration BW

Set the frequency width of the channel to be tested and the power of the channel is the power integral within this bandwidth. You can use the numeric keys, knob or direction keys to modify this parameter.

10.5.2.2 Info Table

When the information table is “On”, click other menu options and the measurement result table will not be closed. When the status of the information table is “Off”, the measurement result information table will be closed

Channel power measurement results include: Channel power and power spectral density.

The measurement of the specified channel power is centered on the central frequency point of the channel, and the frequency Span of the test channel is adjusted. The channel power is the integral of this frequency span, and the bandwidth of the specified channel is called the integral bandwidth. The value of the integral bandwidth is related to Span but \leq Span.

- **Channel Power:** Power within the integration bandwidth.

$$chPow = \sum_{start}^{stop} \left(\frac{watt}{rbw} \right) * (itgBW / (stop - start))$$

chPow: Channel power, in watts

start, stop: The start and stop frequency of channel.

watt: Absolute power converted from sweep point data, in watts

rbw: resolution bandwidth

itgBW: integration bandwidth.

- **Power Spectral Density:** Power (in dBm/Hz) normalized to 1Hz within the integration bandwidth

$$nspd = chPow / itgBW$$

nspd: Power Spectral Density

itgBW: Integration bandwidth.

10.5.3 ACPR

Measure the power of the main channel and adjacent channels as well as the power difference between the main channel and each of the adjacent channels. When this function is enabled, the span and resolution bandwidth of the analyzer are adjusted to smaller values automatically. Select ACPR and click “Meas Setup” to set the corresponding parameters.

The main channel and the left and right adjacent channels are specified, the main channel is centered on the central frequency point, and the left and right adjacent channels are symmetric with respect to the main channel. Channel parameters can be changed by setting the bandwidth of the primary channel, the bandwidth of the neighboring channel, and the interval between the neighboring channel and the center point of the primary channel. The power of each channel is calculated by the same method as the channel power algorithm. The ratio of the power of the adjacent channel to the power of the main channel is the ratio of the power of the adjacent channel.

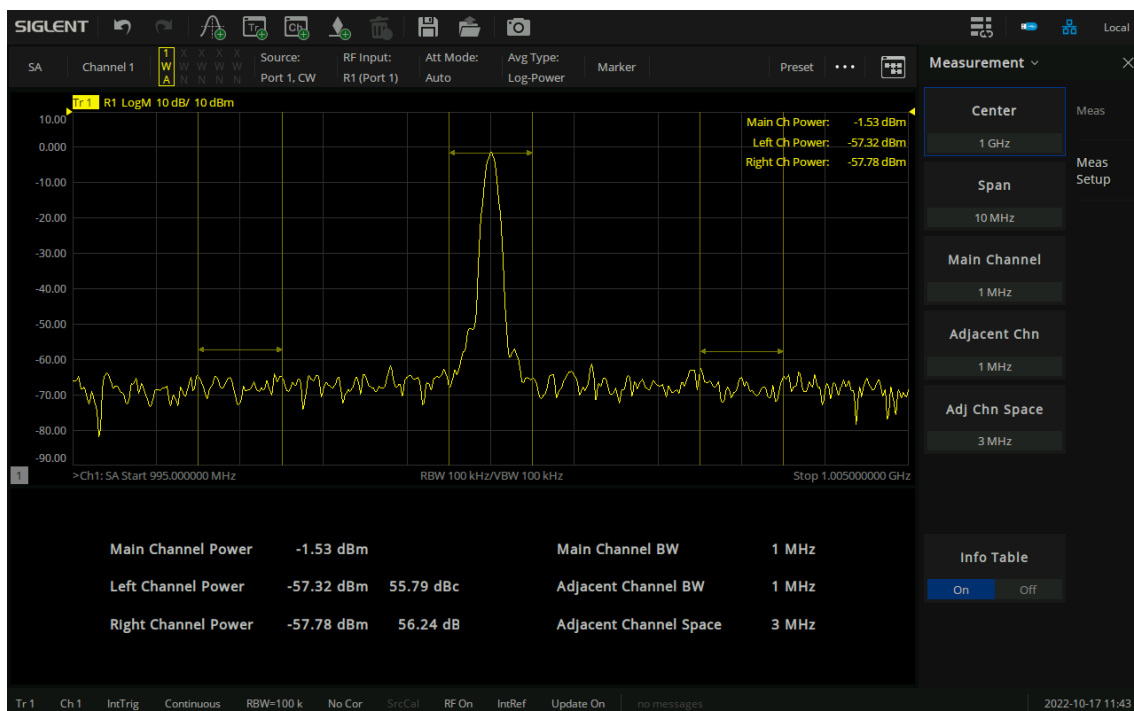

Figure 10-14 ACPR measurement

10.5.3.1 Main Channel

Set the bandwidth of the main channel, and its power is integrated within this bandwidth.

10.5.3.2 Adj Chn

Set the bandwidth of adjacent channels.

10.5.3.3 Adj Chn Space

Center frequency spacing between the main channel and neighboring channels. Adjusting the adjacent channel spacing will adjust the distance between the previous channel and the back channel and the main channel at the same time.

10.5.3.4 Info Table

When the information table is “On”, click other menu options and the measurement result table will not be closed. When the status of the information table is “Off”, the measurement result information table will be closed.

ACPR measurement results include: Main CH Power, Left channel power and Right channel power.

- Main CH Power: Displays the power within the bandwidth of the main power
- Left channel power : Displays the power of left channel and the power difference between the left channel and the main channel (in dBc)
- Right channel power: Display the power of the right channel and the power difference between the right channel and the main channel(in dBc)

10.5.4 Occupied BW

Integrates the power within the whole span and calculates the bandwidth occupied by this power according to the specified power ratio. The OBW function also indicates the difference (namely “Transmit Freq Error”) between the center frequency of the channel under measurement and the center frequency of the analyzer.

Select “Channel Power” and click “Meas Setup” to set the corresponding parameters. The two vertical lines on the trace perpendicular to the X-axis represent the occupancy span of the power percentage. The value on the Y-axis is the power occupying the bandwidth, and displays on the upper right corner.

11 The Frequency Offset Mode

11.1 Overview

Generally with network analyzers, the frequency must be the same both at the signal source and at the receiver, so frequency-translating devices such as mixers or converters cannot be measured. To enable the analyzer to measure frequency conversion devices, the receiver frequency must be synchronized with a frequency consisting of the input frequency and a certain added offset, which is called frequency-offset sweep. The frequency offset sweep function of SNA5000X can be used for mixers related measurement.

The SNA5000X provides not only this frequency-offset sweep but state-of-the-art mixer calibration features: scalar-mixer calibration. Scalar-Mixer Calibration performs high-accuracy measurement for the magnitude and reflection parameter of mixer conversion loss.

Moreover, the SNA5000X supports an absolute measurement function. The network analyzers normally measure the ratio of the test signal's magnitude and phase to the reference signal. In contrast, the absolute measurement function performs a measurement of the absolute value of the test signal's magnitude. In combination with the frequency-offset function, the absolute measurement function provides measurements that include measurement of harmonic distortion. It also provides high-accuracy measurement when combined with Power Calibration and Receiver Calibration.

11.2 Frequency Offset Mode

Frequency Offset Mode (FOM) enables the SNA internal RF signal source and SNA port receiver to operate at different frequencies. To realize the measurement of nonlinear characteristics of the device.

11.2.1 Frequency Offset settings

Press [Freq] > Freq Offset...to enter the frequency offset function setting dialog box.

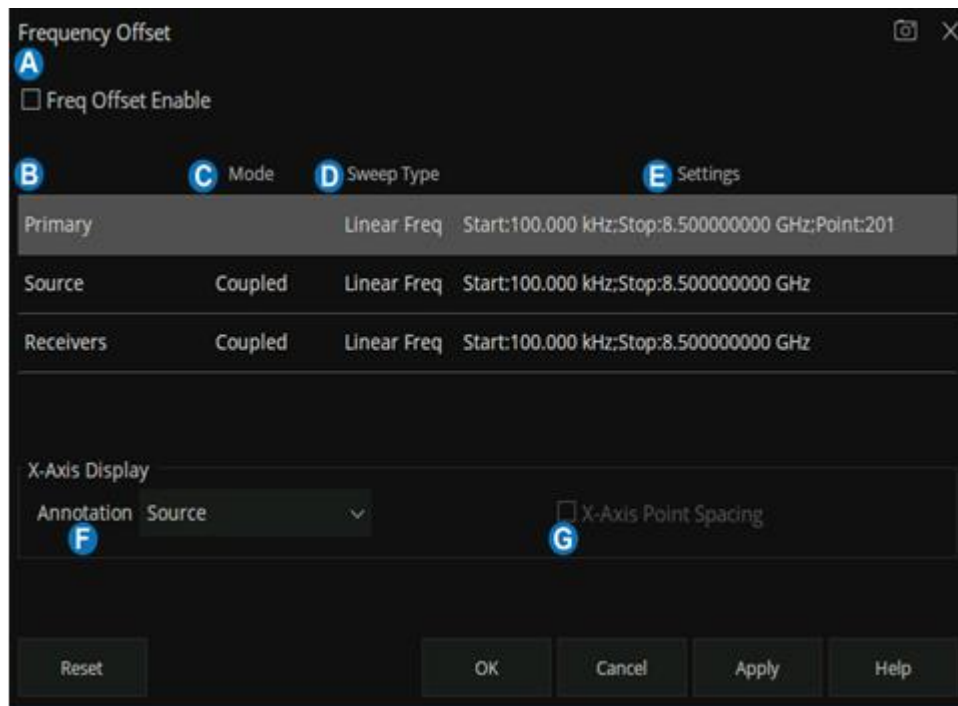

A. Frequency Offset (ON/OFF) Enables Frequency Offset Mode on ALL measurements that are present in the active channel. When frequency offset function is not enabled, all frequencies are the same as the Primary frequency. .

B. Sources and Receivers

- **Primary** The current Active Channel settings. When a Source or Receiver is coupled to the Primary settings, its Sweep Type is the same as that of the Primary. The frequency settings of the coupled range are mathematically derived from the Primary settings using the Multiplier, Divisor and offset values. With this approach, only the Primary settings need to be changed in order to affect change in the coupled Sources and Receivers. Changes to the Primary channel settings occur when Frequency Offset is checked ON.

Primary settings are only used when Sources and Receivers are Coupled. It is often easier to Uncouple, then set Sources and Receivers independently.

- **Source** The internal source signal of the VNA.
- **Receivers** All receivers that are used in the channel, including Reference receivers, are tuned to the specified frequency settings.

C. Mode

- Coupled Source and Receiver settings are mathematically derived from the Primary settings using Multiplier, Divisor, and Offset values.
 - Uncoupled Source and Receiver settings are entered independently, without reference to Primary settings. When Uncoupled, Source and Receiver Ranges can use separate sweep types.
- D. Sweep Type** Click to change the type of sweep for each range. Only available for Primary and Uncoupled Sources and Receivers.
- E. Settings** To change settings,click IN the appropriate Settings cell, then will pop up the corresponding settings dialog box that can be edited. If coupled, invokes the Coupled dialog. If uncoupled or Primary invokes the Uncoupled settings dialog.
- F. X-Axis Annotation** Select the settings to be displayed on the X-Axis.
- G. X-Axis Point Spacing** Only available when a Segment Sweep Type is selected as the X-Axis display.

Coupled settings dialog box

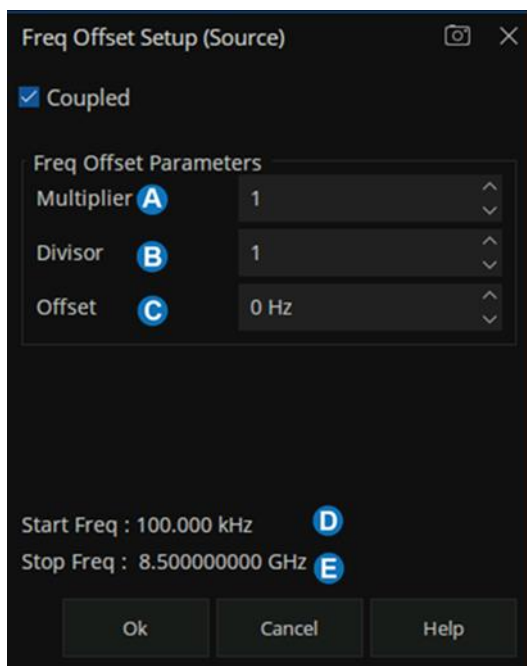

- A. Multiplier** Specifies (along with the divisor) the value to multiply by the stimulus. The value is an integer from -100 to 100.
- B. Divisor** Specifies (along with the multiplier) the value to multiply the stimulus. The value is an integer from -100 to 100.
- C. Start Freq** = [Primary Start x (Multiplier / Divisor)] + Offset
- D. Stop Freq** = [Primary Stop x (Multiplier / Divisor)] + Offset

Primary and Uncoupled settings dialog box

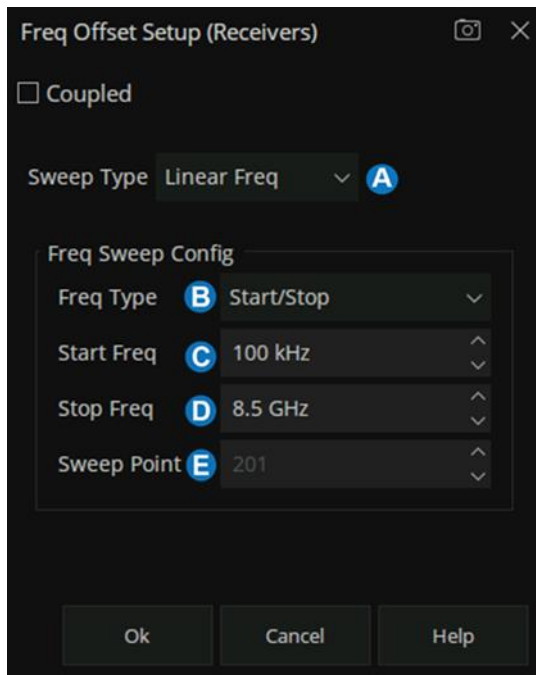

- A. Sweep Type** The settings dialog box is vary depending on the sweep type.
- B. Frequency Type** Select Start/Stop or Center/span.
- C. Start Freq** Enter values.
- D. Stop Freq** Enter values.
- E. Sweep Point (Primary only)** Enter number of data points for the sweep.

Tip:

When sweep type is Segment Sweep, the segment table edits are made exactly like the standard segment table. In segment sweep mode:

The OK button is NOT available until the total number of data points for all segments matches the number of Primary data points.

Independent IF Bandwidth and Independent Sweep Time are available ONLY on the Primary (channel) and the Uncoupled Receivers - NOT Sources.

Independent Power is available ONLY on the Primary (channel) and the Uncoupled Sources - NOT Receivers.

11.2.2 Setup Examples

Although the Frequency Offset settings can be used with many types of devices, these examples are mixer terminology.

11.2.2.1 Fixed LO - Upconverter

- Fixed LO: 2.5GHz
- Swept Stimulus (Mixer Input): 1GHz-1.5GHz
- Swept Response (Mixer Output): 3.5GHz-4GHz

Make the following settings on the FOM dialog

Source: Uncoupled, Sweep Type=linear Freq , Start = 1GHz, Stop = 1.5GHz;

Receiver: Uncoupled, Sweep Type=linear Freq , Start = 3.5GHz, Stop = 4GHz;

LO settings: If an external source is used, set the fixed output frequency to 1.5GHz.

11.2.2.2 Fixed LO – Downconverter(Input < LO)

- Fixed LO: 2.5GHz
- Swept Increasing Stimulus (Mixer Input): 1GHz-1.5GHz
- Swept Decreasing Response (Mixer Output): 1.5GHz-0.5GHz

Make the following settings on the FOM dialog

Primary: Not used

Source (Input): Uncoupled, Sweep Type=linear Freq , Start = 1GHz, Stop = 1.5GHz;

Receiver (Output): Coupled, Sweep Type=linear Freq , Multiplier=-1, offset =2.5GHz;

LO Settings: If an external source is used, set the fixed output frequency to 2.5GHz.

12 Scalar Mixer Measurements(SMM Option)

To get more accurate measurement results, connect the DUT to the VNA port as the following figure. Before measuring the scalar mixer, the VNA should be fully preheated and then do the following steps:

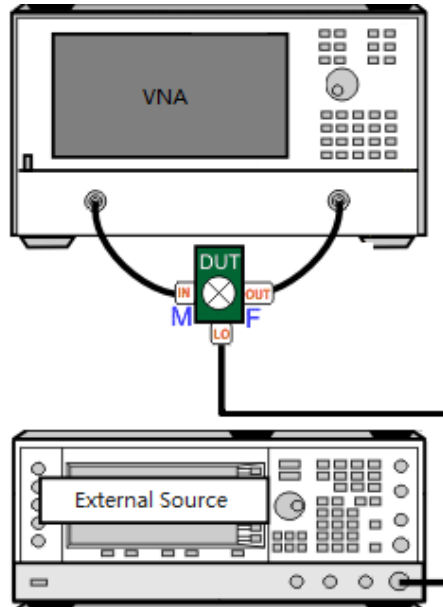

1. Create an SMM measurement
2. Configure the Scalar mixer setup
3. Do the Source Power Calibrate of the SMM mode (optional)
4. Do the Receiver Calibrate of the SMM mode (optional)
5. Do the SMM Calibration
6. Do the scalar mixer measurement

12.1 Create an SMM measurement

Press [Meas] >S-Params > Mode > SMM.The SMM channel selection dialog box will displayed after the SMM measurement mode was selected. Select “Active Channel” (delete the existing measurement) or “New Channel” then click OK. A Scalar mixer measurement is displayed on the current channel or on a new channel and New Window.

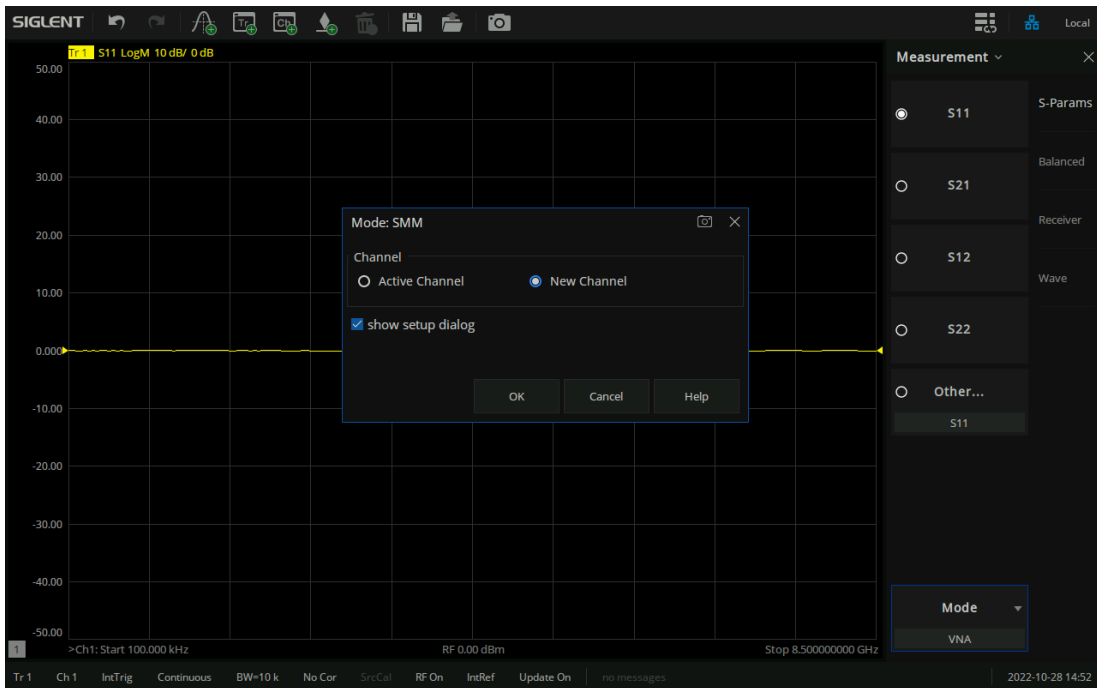

Figure 12-1 SMM mode channel selection dialog box

In the interface of the SMM channel selection dialog box, The “Mixer Measure dialog” check box is selected by default. When user clicks “OK”, a SA Setup dialog box will be displayed that can set related parameters. As figure shown below:

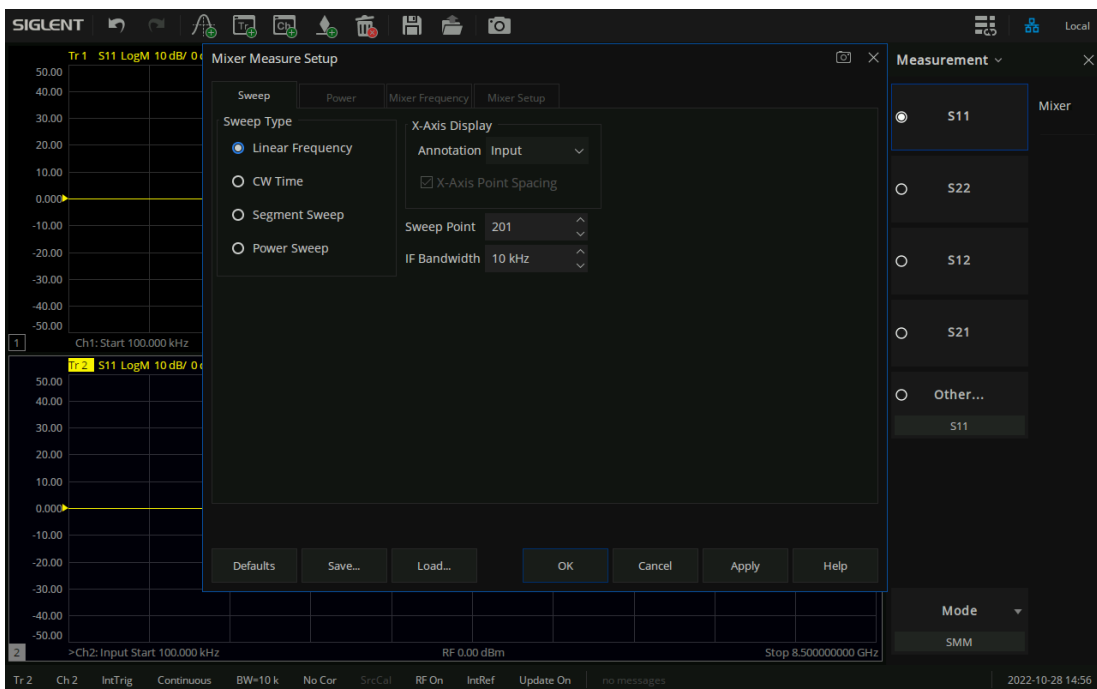
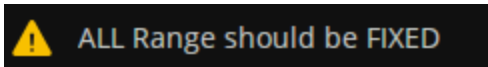

Figure 12-2 Mixer Measure Setup dialog

If the show Setup Dialog check box is deselected, the Mixer Measure Setup dialog box will not be displayed when the SMM function is enabled. If the user needs to modify the SMM parameter settings again, the Mixer Measure Setup dialog box can be called up by pressing the front panel Stimulus key [Start] / [Stop] / [Freq] / [Power] / [Sweep] > Mixer Measure....

12.2 Configure the Scalar mixer setup

Configuring the SMC Setup dialog can be challenging at first. Warning messages like this one appear at the bottom of the Setup dialog to notify you of an invalid setup.



At least one range (Input, LO, or Output) MUST be Fixed. The following are the Valid Mixer Configurations:

Sweep Type	input	Local	Output
Linear Frequency	Sweep	Sweep	Fixed
	Sweep	Fixed	Sweep
	Fixed	Sweep	Sweep
CW Time Power	Fixed	Fixed	Fixed

Although you will soon become comfortable navigating these tabs, at first it may be best to complete the dialog in the following order:

1. Enter the Mixer Measure Setup dialog box
2. Select Sweep tab settings.
3. Select Power tab settings.
4. Select Mixer Frequency tab settings.
5. Select Mixer Setup tab settings.

12.2.1 Sweep Tab – Mixer Measure Setup box

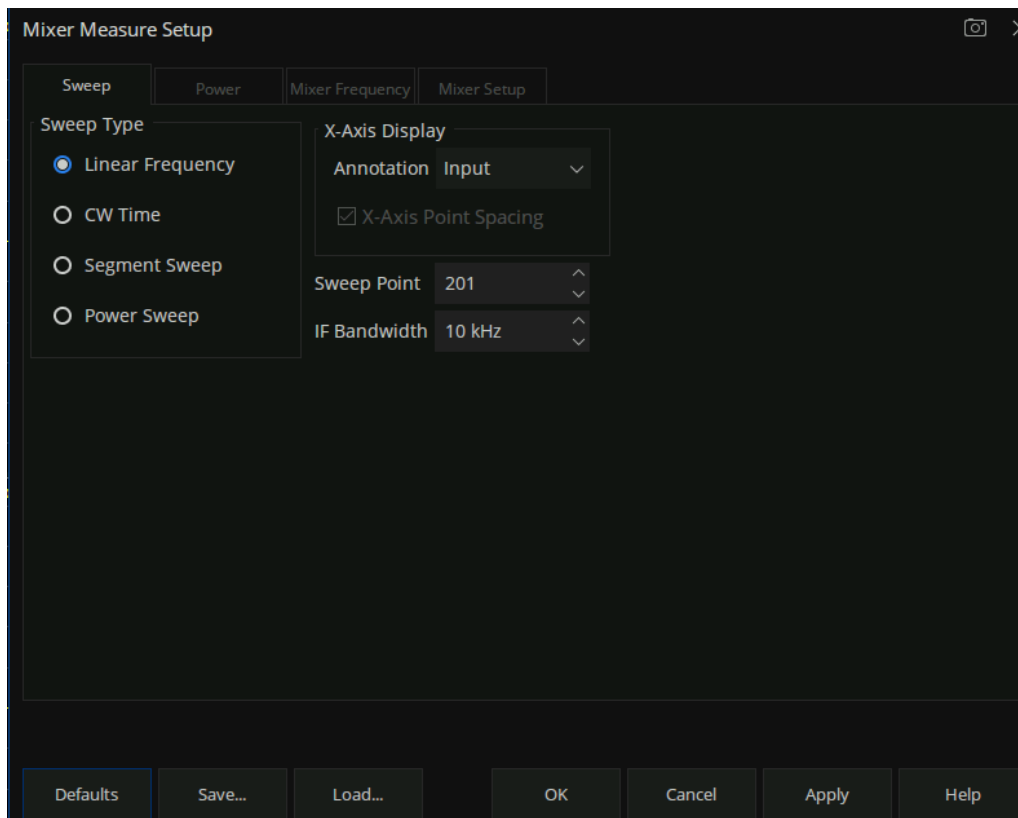

Figure 12-3 Sweep Type Tab

Sweep Type:

- **Linear frequency:** Measurements are displayed on a standard grid with ten equal horizontal divisions.
- **CW Time:** All ranges are set to a Fixed (CW) frequency, and the data is displayed versus time.
- **Segment Sweep:** Sweep user-defined segments.
- **Power Sweep:** Input or LO power.
- **X-Axis Display:**

Select the frequency range for displaying the sweep parameters (input, output, LO) on the X-axis.

X-Axis Point Spacing Available only with Segment Sweep.

- **Sweep Point:** The number of data points that the analyzer measures across a sweep.
- **IF Bandwidth:** The received signal is converted from its source frequency to a lower intermediate frequency (IF).

12.2.2 Power Tab - Mixer Measure Setup box

Configures Input and Output power settings for an SMM measurement.

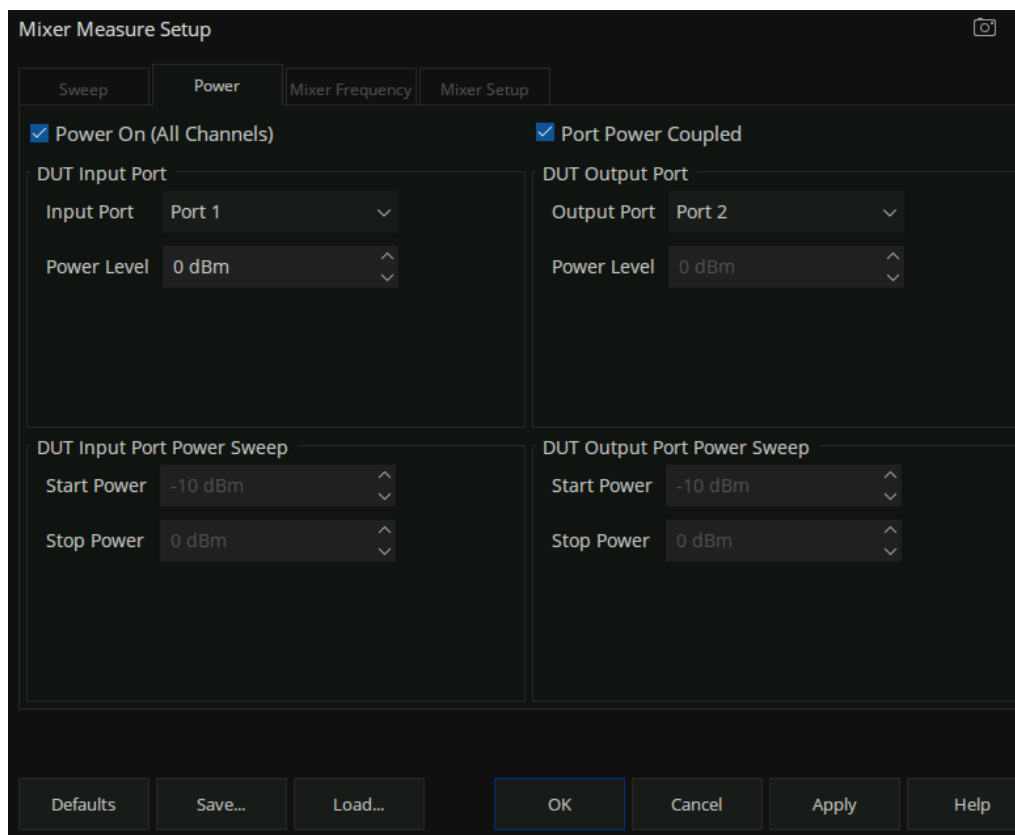

Figure 12-4 Power Tab

- **Power On(All Channels):** To turn the internal RF Power ON or turn power OFF for all channels.
- **Port Power Coupled:** To set the same power level at the DUT Input and Output ports.
- **DUT Input Port:** Select the VNA port that is connected to the DUT Input then Set the power level to the DUT Input port.
- **DUT Output Port:** Select the VNA port that is connected to the DUT Output then Set the power level to the DUT Output port.
- **DUT Input and Output Port Power Sweep:** Available when Power (sweep) is selected on the Sweep tab. And the Start and Stop Power editing boxes can be edit.

12.2.3 Mixer Frequency Tab- Mixer Measure Setup box

12.2.3.1 Mixer Frequency setting

Input: The stimulus frequencies of the DUT.

Output: the response frequencies of the DUT after conversion (either UP or DOWN).

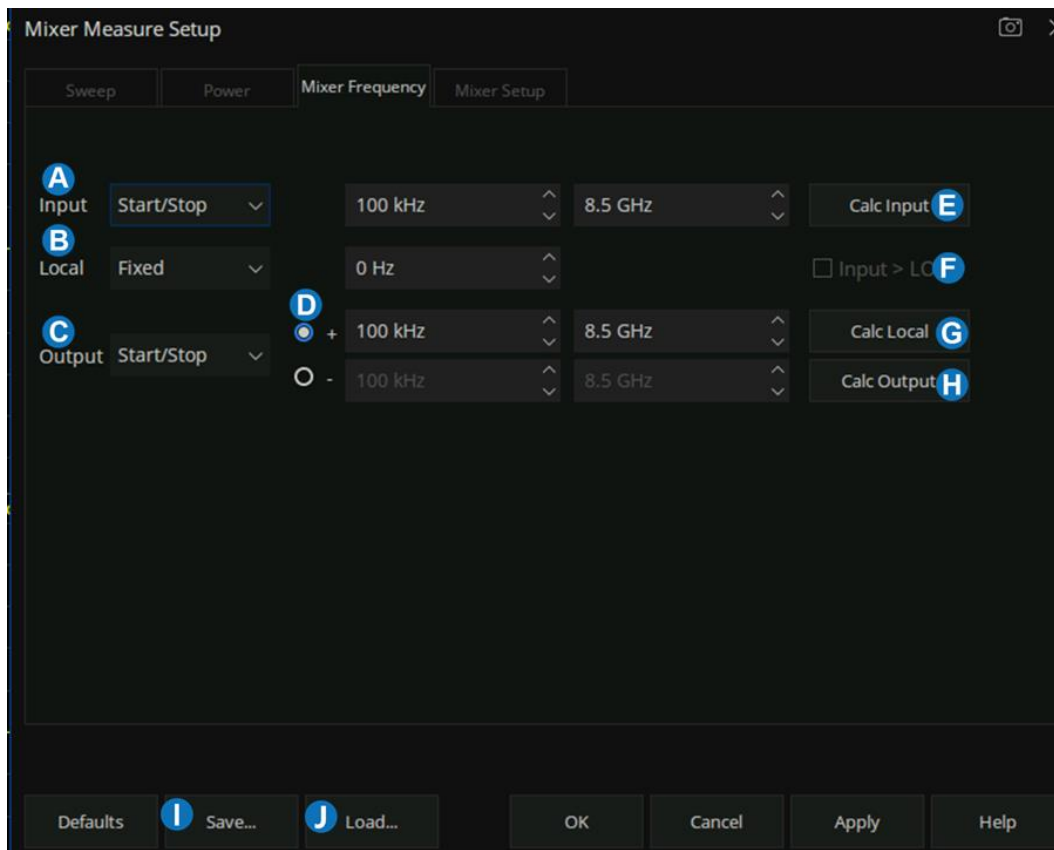

Figure 12-5 Mixer Frequency Tab

Frequency Format can select Start / Stop (Swept) or Fixed. For Linear sweep type, at least one of these must be fixed. For CW or Power, ALL must be Fixed.

- A. Select the DUT Input frequency format.
- B. Select the LO frequency format.
- C. Select the DUT Output frequency format.
- D. Mixer-Product Selector. Determines whether the receivers will tune to the Sum (+) or the Difference (-) of the Input and LO frequency.
- E. Calculates Input frequency settings based on your other mixer settings. For example, enter the Output frequency range and LO frequency range, then press “**Calc Input**”. The VNA will

calculate and display the Input frequency.

- F. Input > LO When DUT selects down-conversion mode and Input signal > local, this box must be selected, and then the output frequency can be calculated by clicking “Calc Output” button.
- G. Calculates LO frequency settings based on your other mixer settings. For example, enter the Input frequency range and Output frequency range, then press “**Calc Local**”. The VNA will calculate and display the LO frequency.
- H. Calculates Output frequency settings based on your other mixer settings. For example, enter the Input frequency range and LO frequency range, then press “**Calc Local**”. The VNA will calculate and display the Output frequency.
- I. Saves some of the mixer settings to a “*.mxr” file. The saved Settings are:Sweep Type (when Segment Sweep Type, all segment settings are saved) .Frequency,and power settings.
- J. Recalls a previously-configured mixer “*.mxr” file.

12.2.3.2 Segment Sweep Mixer Frequency setting

The following settings appear on the Mixer Frequency tab when Segment Sweep is selected on the Sweep tab.

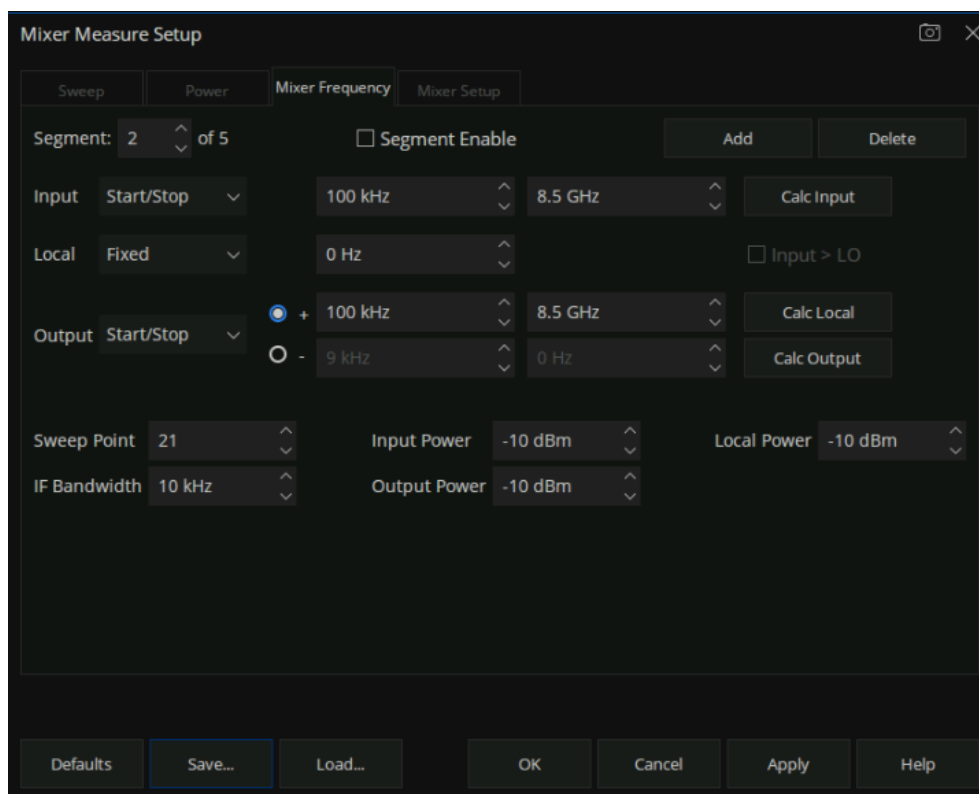

Figure 12-6 Segment Sweep Mixer Frequency Tab

How to configure a segment using the GUI:

1. Click "Add". To add a segment.
2. Click "Delete" to remove a segment and renumber all subsequent segments.
3. State is ON by default. Click OFF and that segment will not be included in the sweep.
4. Configure Frequency settings for Input, LO, and Output ranges.
 - For each segment, the same sweep requirements apply as a standard (non-segment) sweep. For example, at least one range MUST be Fixed (Start = Stop frequencies).
 - The Input, Output, and LO frequencies of segments are allowed to overlap other segments.
 - All segments must sweep in either the forward (Start<Stop) or reverse (Start>Stop) directions. Mixed sweep directions are NOT allowed.
 - The following settings can be set independently for each segment:
 - a) Number of Points - Total number of points for all segments is limited to the Max allowed by the VNA.
 - b) IF Bandwidth
 - c) Port Powers: Input, Output, LO. These settings override the settings on the Power tab
 - The following settings apply to ALL segments:
 - a) LO Source Selections
 - b) All Input and LO Multipliers and Dividers
 - c) Source Leveling
 - d) X-Axis Display
 - e) X-Axis Point Spacing
 - Mixer Segment setup information is saved to a "*.mxr" file.

12.2.4 Mixer Setup Tab- Mixer Measure Setup box

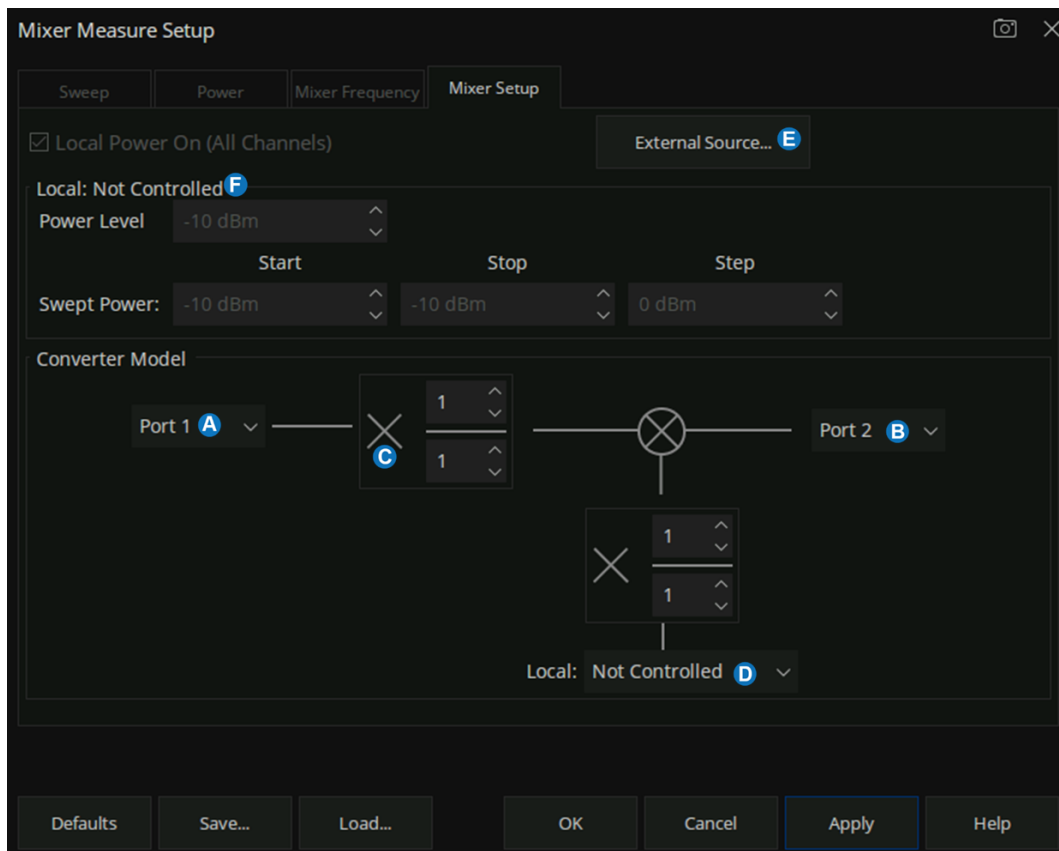

Figure 12-7 Mixer Setup Tab

- A. Select the VNA port to connect to the DUT input.
- B. Select the VNA port to connect to the DUT input.
- C. Fractional Multipliers $\times \frac{1}{1}$, The combination of (numerator / denominator) forms a fractional value that is multiplied by the input and LO frequency ranges. These values are used to calculate the response frequency of the VNA receiver for the converter output. The range for the numerator and denominator of a fractional multiplier is from -100 to +100. The denominator cannot be set to 0.
- D. Select "Not controlled" to allow an external source to provide a Fixed LO Frequency at all times. Otherwise, select an External source to be controlled by VNA and provides variable frequency used as the LO.
- E. Add External Source. Connect the External Source device to any USB port of the VNA by the USB cable, then click "External Source", after the VNA identifies the External Source, the external source information will displayed in the External Source dialog box. When LO selects a external source, the VNA controls the external source to provide the specified frequency

output based on the local frequency and power configuration.

F. Available when select a external source to provide the LO frequency.

Fractional Multiplier Examples

(1) Example 1: Use the LO fractional multiplier to replicate the action of the third-harmonic mixer so the VNA can accurately calculate the receiver frequency. The input and LO frequencies are known.

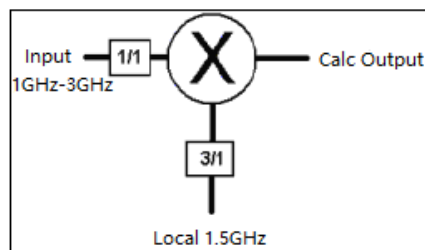

Enter these settings in the **Mixer Setup** dialog box:

- Input Start Freq: 1GHz
 - Input Stop Freq: 3GHz
 - LO Fixed Freq: 1.5GHz
 - Mixer-Product Selector: different ("-")
 - Input fractional multiplier: 1/1
 - LO fractional multiplier: 3/1
 - Click "Calc Output"
 - Result :Output Start Freq: 3.5GHz, Output Stop Freq 1.5GHz.
- (2) Example 2: Use the fractional multipliers to tune the VNA receiver frequency to the second harmonic of the mixer's 8 GHz fundamental output. The input, LO, and output frequencies are known.

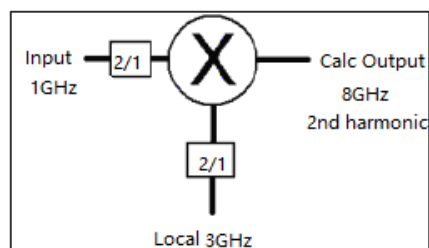

Enter these settings in the **Mixer Setup** dialog box:

- Input Fixed Freq: 1GHz
 - LO Fixed Freq: 3GHz
 - Mixer-Product Selector: sum (“+”)
 - Input fractional multiplier: 2/1
 - LO fractional multiplier: 2/1
 - Click “Calc Output”
 - Result :Output Fixed Freq: 8GHz.
- (3) Example 3: Use the LO fractional multiplier to replicate the action of the divide-by-two mechanism inside the mixer package. Having done this, the VNA can accurately calculate the receiver frequency. The input and LO frequencies are known.

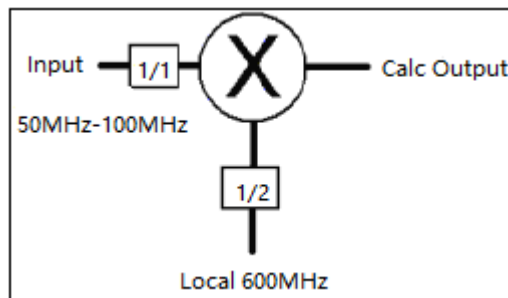

Enter these settings in the **Mixer Setup** dialog box:

- Input Start Freq: 50MHz
- Input Stop Freq: 100MHz
- LO Fixed Freq: 600MHz
- Mixer-Product Selector: sum (“+”)
- Input fractional multiplier: 1/1
- LO fractional multiplier: 2/1
- Click “Calc Output”
- Result : Output Start Freq: 350MHz, Output Stop Freq 400MHz.

12.3 Do the Source Power Cal of the SMM mode (optional)

In the SMM mode, connect the power meter to the VNA port and press the [Cal] key on the front panel > mixer calibration > power calibration > Perform source calibration related configurations > click "Take Cal Sweep" then source power calibration will be performed immediately.

12.4 Do the Receiver Cal of the SMM mode (optional)

In SMM mode, after source power calibration, press the [Cal] key on the front panel > mixer calibration > receiver calibration > receiver calibration related configuration > click "Take Cal Sweep", then receiver calibration will be performed immediately.

12.5 Do the SMM Calibration

12.5.1 Overview

VNA has a scalar-mixer calibration function for measuring frequency conversion devices.

Scalar-mixer calibration allows you to measure the magnitude value and reflection parameter of the mixer's conversion loss with very high accuracy by performing calibration using calibration standards (OPEN / SHORT / LOAD) in combination as well as a power meter.

For measurement of the conversion loss in a frequency conversion device, normal full 2-port calibration is not available because of the frequency difference between the stimulus port and the response port. Therefore, scalar-mixer calibration allows you to correct the error term that resides in a full 2-port error model by using the error model and an expression based on a new concept.

You can correct the following error elements by using the scalar-mixer calibration.

- The reflection between the output port of the network analyzer and the input port of the measured mixer (vector error correction).
- The reflection between the output port of the measured mixer and the input port of the network analyzer (vector error correction).
- Transmission frequency characteristics at different frequencies (scalar error correction).

Since the transmission tracking(ETF) in the error model used for scalar mixer calibration is a scalar value, the phase part of the compensated transmission measurement result is invalid.

12.5.2 Procedure Using Mechanical Calibration Kit

In scalar mixer measurement mode, only scalar mixer calibration can be used to compensate for S-parameter measurements. In mixer measurement mode, press the “Cal” key on the front panel > Mixer Calibration > Mixer calibration... Enter the mixer calibration wizard interface, default Port1 and Port2 calibration, connect the calibration kit according to the wizard instructions, click the corresponding kit name on the UI to calibrate the scalar mixer.



Figure 12-8 The interface of Scalar Mixer Calibration

12.5.3 Checking Calibration Status

After the mixer calibration is complete, the trace status area of the UI displays the type of error calibration that has been performed. For example, the mixer has performed full two-port calibration and the trace calibration status identifier displays “[F2]”.

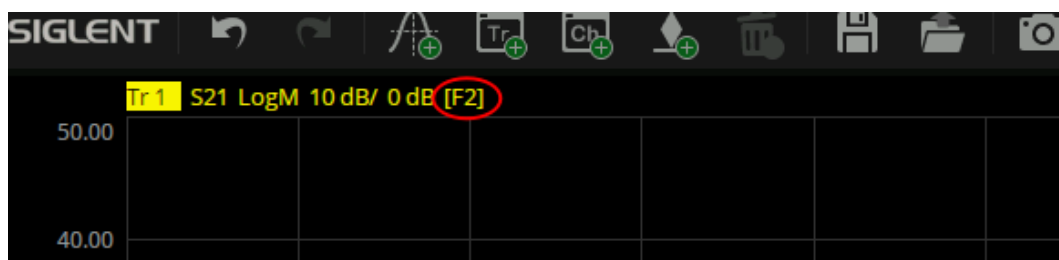

Figure 12-9 Calibration Status

13 Save and Recall

The vector network analyzer supports save and recall functions for files of various formats. Press the **Save/Recall** button on the front panel and select file, data, calibration data, and images to save or recall. in the menu bar on the right side of the screen.

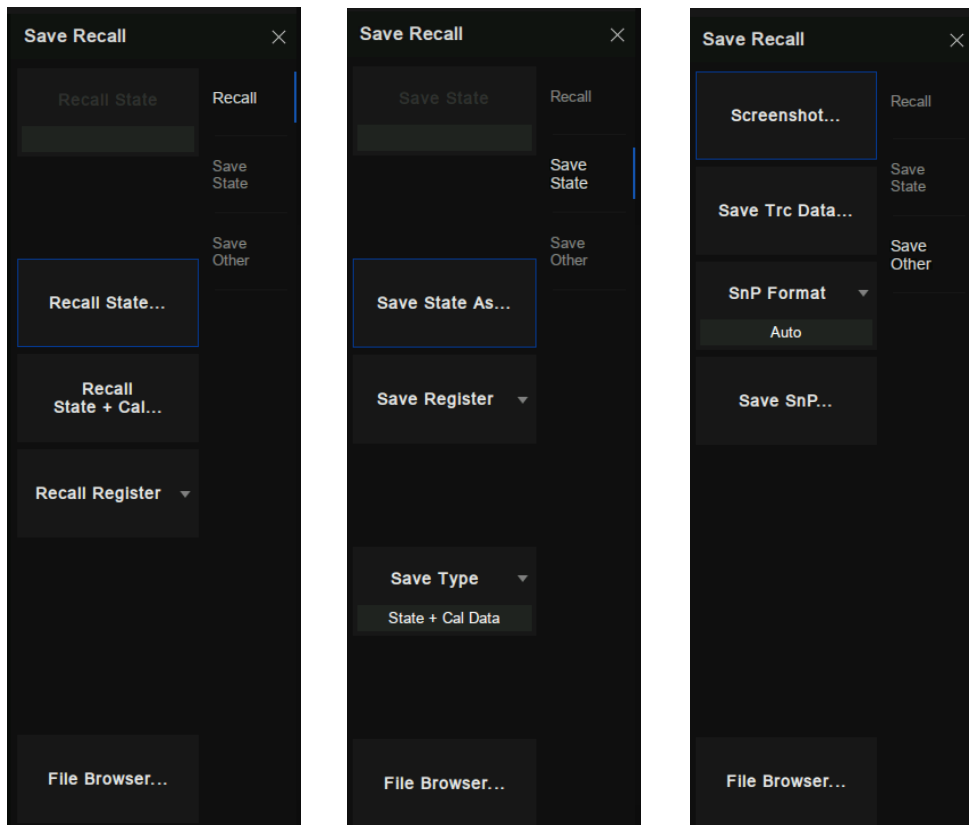

Figure 13-1 Operating interface

Description of supported file formats:

- STA file: The state file contains the configuration parameters (setup) of the instrument.
- CSA file: The calibration data and state file.
- CSV file: Trace data.
- SnP file: Also known as a Touchstone file. It contains the S parameter information.
- PNG /JPG /BMP file: Screenshot/exact copy of the display.

Save file:

- **Save the status of equipment:**

Use the Save State As command in the Save State submenu to save the equipment state.

- **Save the status and calibration data of equipment:**

Select State+Cal Data command in the Save Type submenu to save the equipment state and calibration data at the same time.

- **Save trace data:**

Use the Save Trc Data command in the Save Other submenu to save the trace data in CSV format; or use the Save SnP command to save the trace data in SnP format. When saving the trace data in SnP format, you can select the following formats: LinMag/ Angle, LogMag/ Angle and Real/ Imaginary in the SnP Format drop-down item.

- **Save screenshot:**

Use the Screenshot command in the Save Other submenu to save the screenshot. We can set the default path in the pop-up dialog box. The screenshot file type can be saved as PNG/ JPG/ BMP file formats.

- **Save register data:**

Use the Save Register command in the Save State submenu to save the data in the register.

Recall file:

- **Recall status of equipment:**

Use the Recall State command in the Recall submenu to select the required equipment state in the .sta file format.

- **Recall the status and calibration data of equipment:**

Use the Recall State + Cal command in the Recall submenu to select the required equipment state and calibration data in .csa file format.

- **Recall register data:**

Use the Recall Register command in Recall submenu to select the register data to be recalled.

File management:

Click **File Browser** command to open the file browser, File management can be carried out in the file browser.

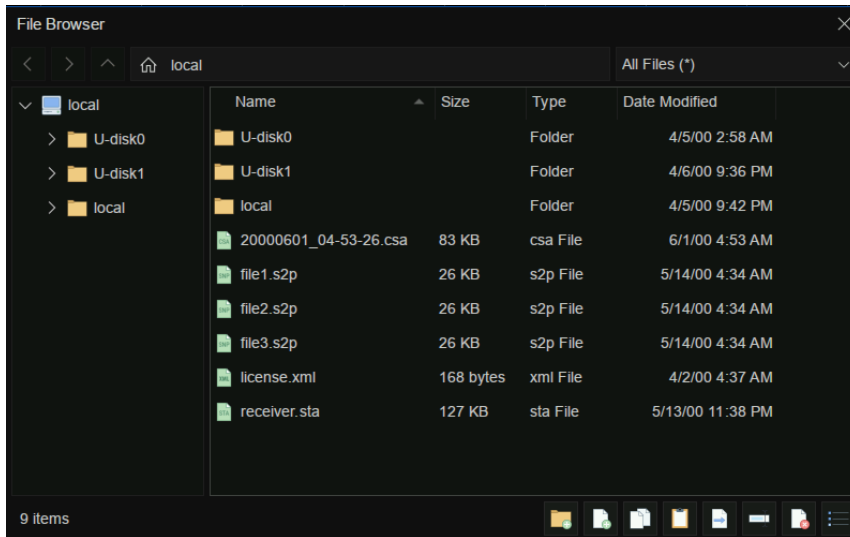

Figure 13-2 File management interface

14 System setting

Press the **System** button on the front panel. We can set the IP address, set the date, restore the factory settings, consult the help document, set the buzzer, self-detection, language setting, obtain the software and hardware information of the device, and license management in the menu on the right side of the screen.

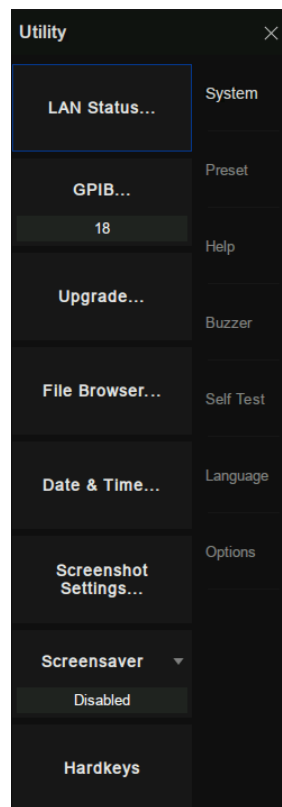

Figure 14-1 System setting interface

14.1 Communication interface setting

- **LAN setting:**

We can select static or dynamic allocation of LAN-related parameters. Use LAN Status command in System submenu to set LAN parameters.

- **Set GPIB port number:**

Use the GPIB command in the System submenu to set the GPIB port number.

14.2 Firmware upgrade

Store the.ADS file in the firmware upgrade package downloaded from the official website in the U disk root directory, insert the U disk into the USB port of the vector network analyzer, click the **Upgrade** command in the **System** submenu, select the required file in the pop-up file browser, and click **OK** to upgrade the firmware. The firmware upgrade process may last for several minutes. When the upgrade is completed, the device will automatically restart. Any operation that interrupts the upgrade process may cause the upgrade to fail or even the device cannot start normally. Please keep the U disk stable and the power supply of the equipment normal during the firmware upgrade process.

14.3 Date/Time setting

Use the **Date & Time** command in the **System** submenu to set the date/time. You can set whether to display the date/ time and display the format at the bottom right of the screen and modify the date/ time value.

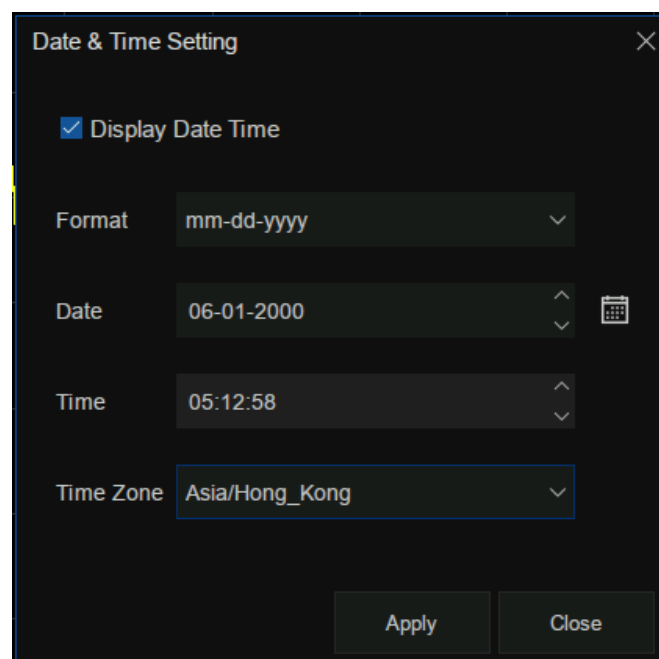

Figure 14-2 Date/Time setting interface

14.4 Screenshot setting

Use the **Screenshot Settings** command in the **System** submenu to set the screen capture parameters.

14.5 Preset

Preset operation and related settings can be performed in Preset submenu.

- **Preset:**

Use the Preset command to reset immediately according to the setting reset options.

- **Preset Option:**

Use the Preset Option command to set the reset options, and to determine the preset source:

1. **Default:** Load default parameters.
2. **Last:** When the equipment is shut down, the current state will be saved automatically. Use this option to restore to the last shutdown state.
3. **User:** Restore the equipment to the user-specified state.

- **User Preset:**

Use the User Preset command to specify the user preset status information file.

- **Confirm Preset:**

Use the Confirm Preset command to set whether to confirm before reset.

- **Power On Option:**

Use the Power On Option command to set the default source of equipment reset when the equipment starts.

- **Power On-Line:**

Use the Power On-Line command to set whether the device starts automatically when it is powered on.

14.6 Factory Reset

Configuration files(Selected by default)

Indicates that the equipment is restored to the factory default state, but the files saved by the user to local will not be deleted.

User data

(Optional), user can selectively delete the files saved to local.

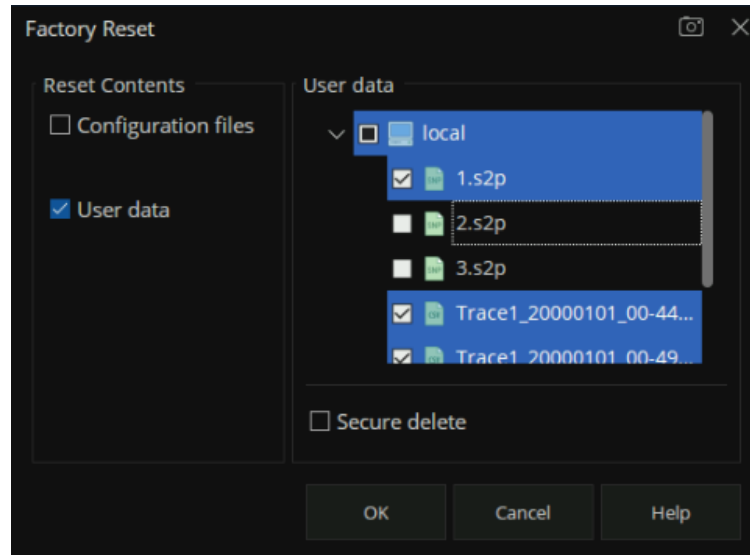

Figure 14-3 Select the saved file

Configuration files and User data

If user select both, the equipment is restored to the factory default state and deletes the files saved to local by users.

14.7 Help information

In the Help submenu, we can open the help document (Help command) or view the equipment information (About command).

14.8 Buzzer

We can set the sound in the Buzzer submenu.

- Buzzer: Use the Buzzer command to turn the device sound on or off.
- Complete Test: Use the Complete Test command to test the completion tone.

- Complete Buzzer: Use the Complete Buzzer command to turn the completion tone on or off. Warning Test: Use the Warning Test command to test the alarm tone.
- Warning Buzzer: Use the Warning Buzzer command to turn on or off the alarm tone.
- Touch Buzzer: Use the Touch Buzzer command to turn on or off the touchscreen keystone.

14.9 Self-Test

14.9.1 Key and touch screen test

In the **Self Test** submenu, we can perform keyboard self-test (**Key Test** command), touch screen self-test (**Touch Test** command), screen self-test (**Screen Test** command) and LED self test (**LED Test** command).

14.9.2 Performance test

14.9.2.1 Enter VNA Test Dialog Method

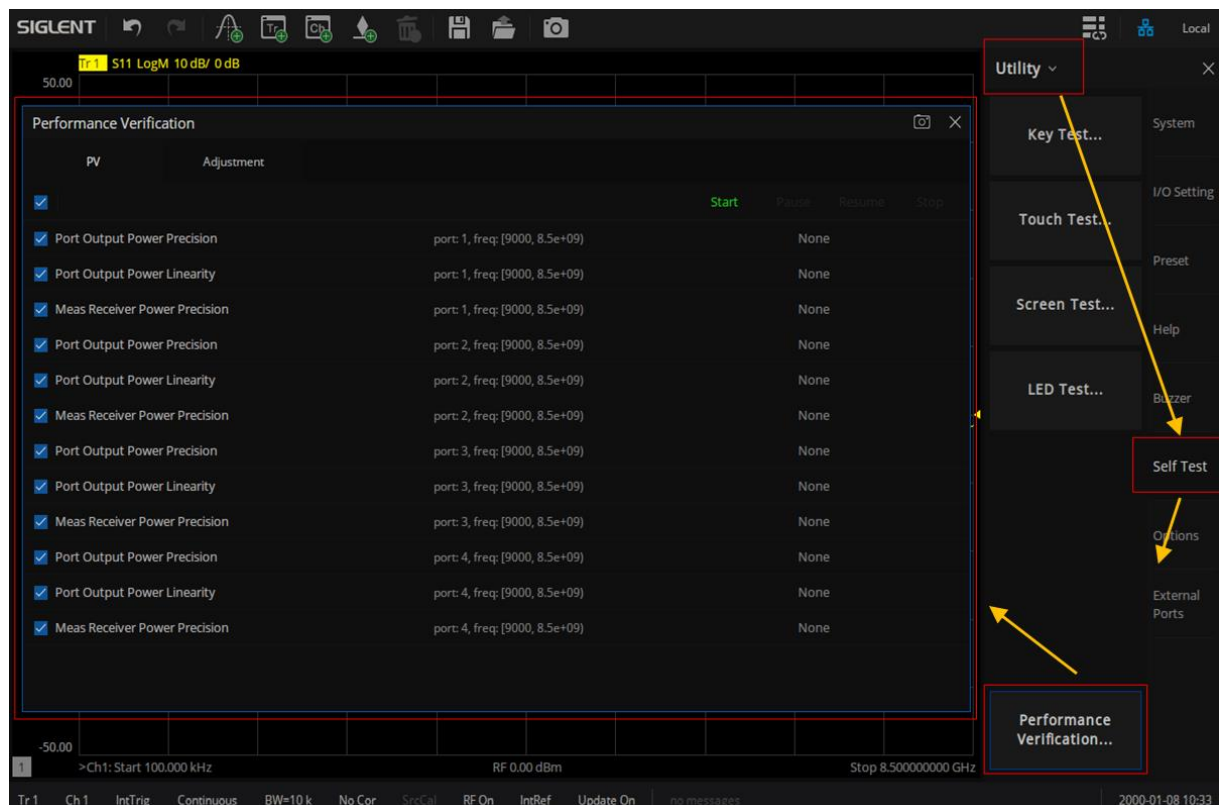
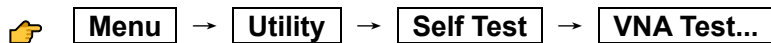

14.9.2.2 VNA Test Dialog UI Description

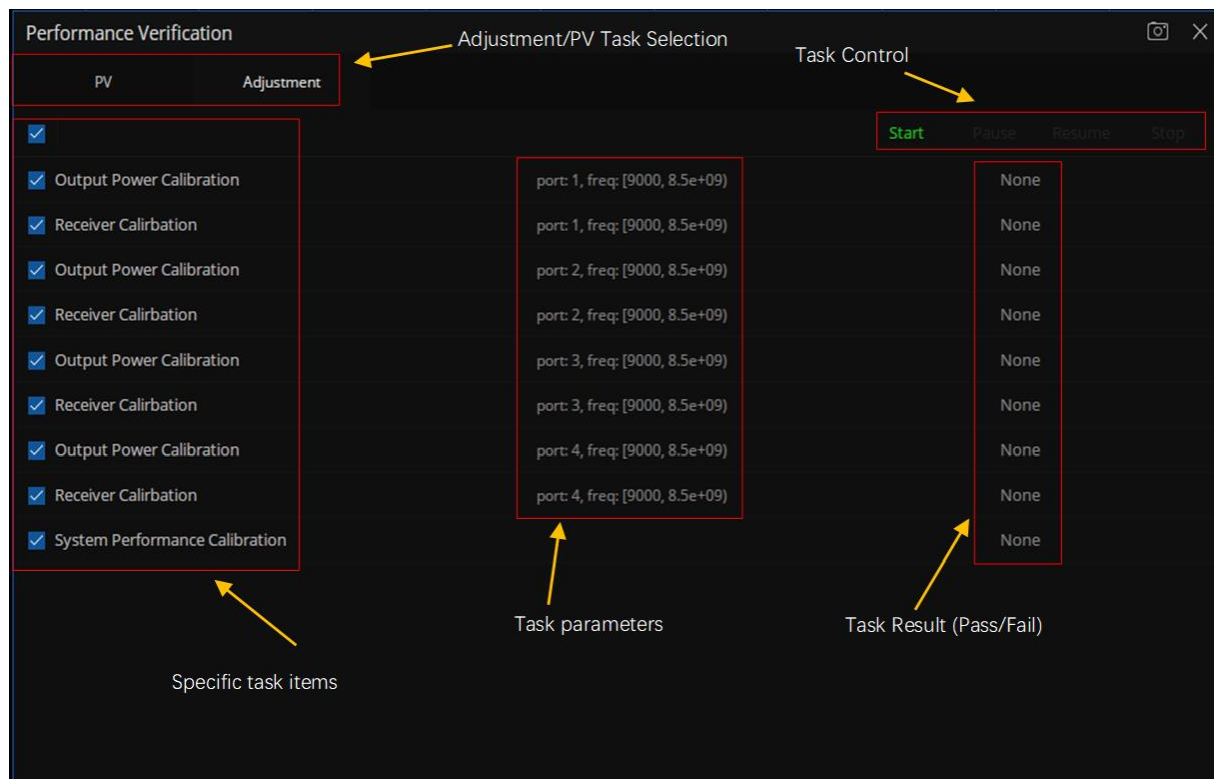

14.9.2.3 Task Process Description

14.9.2.3.1 Adjustment Task

Needed equipment:

- ✧ Power Meter (R&S NRP18A) × 1
- ✧ 10 dB attenuator × 1
- ✧ Coaxial cable × 1
- ✧ Calibration Kits (Open × 1 + Short × 1 + Load × 4)
- ✧ Adapter × 1

Adjustment Process:

1. Enter adjustment tab page.
2. Select all calibration items.
3. Click **Start** button to begin adjustment tasks.
4. Follow the tips to complete the adjustment process.

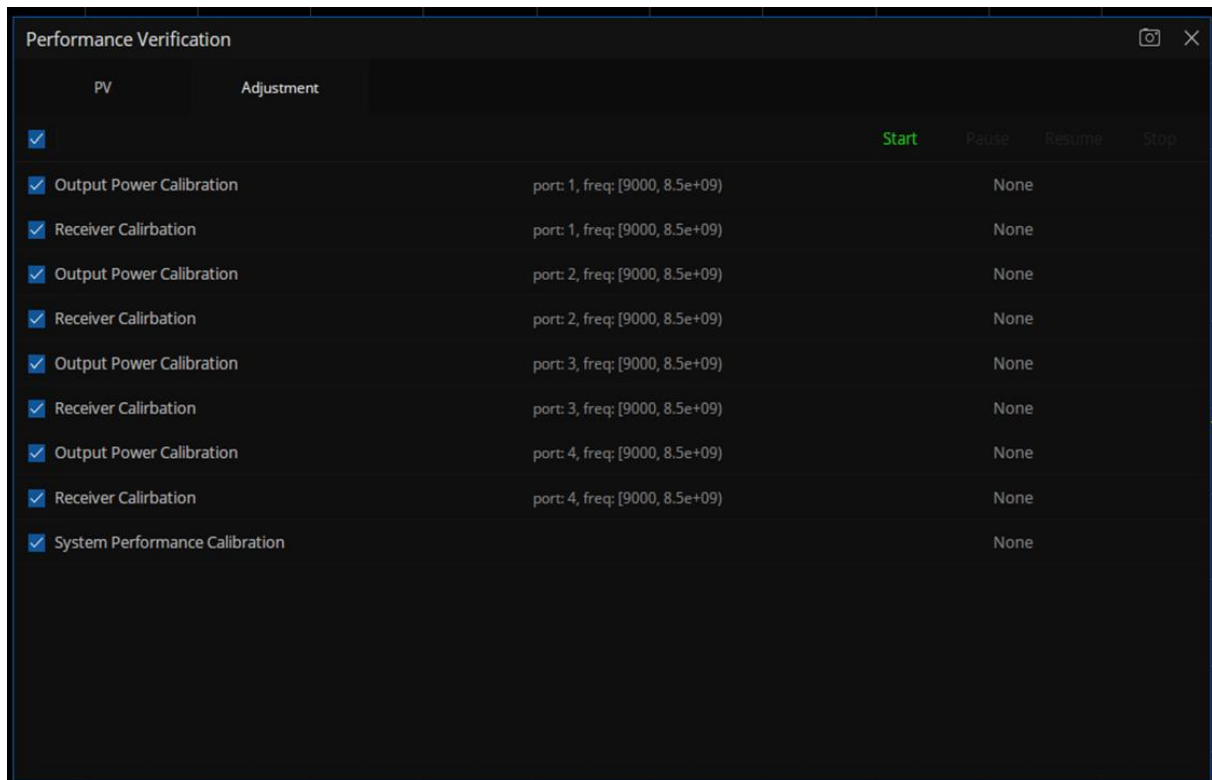

14.9.2.3.2 PV Task

Needed equipment:

- ✧ Power Meter (R&S NRP18A) × 1
- ✧ Coaxial cable × 1
- ✧ Adapter × 1

PV Process:

1. Enter PV tab page.
2. Select all test items.
3. Click **Start** button to begin PV tests.
4. Follow the tips to complete the PV process.
5. Click test item **Export Report...** button to save the report. (Optional)

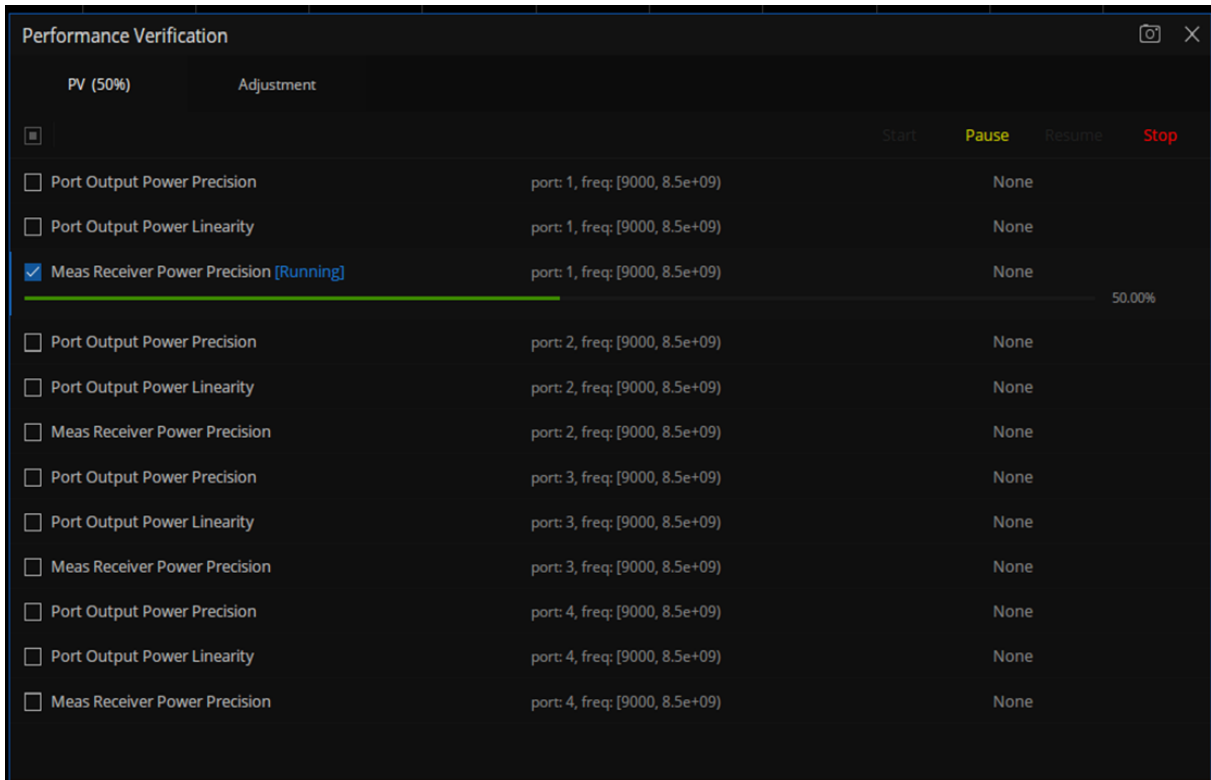

14.9.2.4 Switch to User Factory Calibration Data

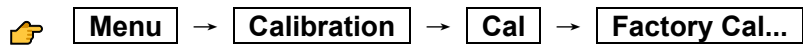

Tips:

1. Factory mode, VNA use 'SIGLENT' factory calibration data.
2. When the check box is checked, VNA will use user calibrated calibration data.
3. After the user performs factory calibration, this check box will be automatically selected.



14.10 System language

The **Language** command in the **Language** submenu can be used to change the language of the equipment. Simplified Chinese and English are supported.

15 Service and Support

15.1 Ordering and activating the options

There are two ways for you:

1. Pre-activate the options by Siglent factory.

If you order a instrument and options, Siglent factory will activate the options for you before delivery.

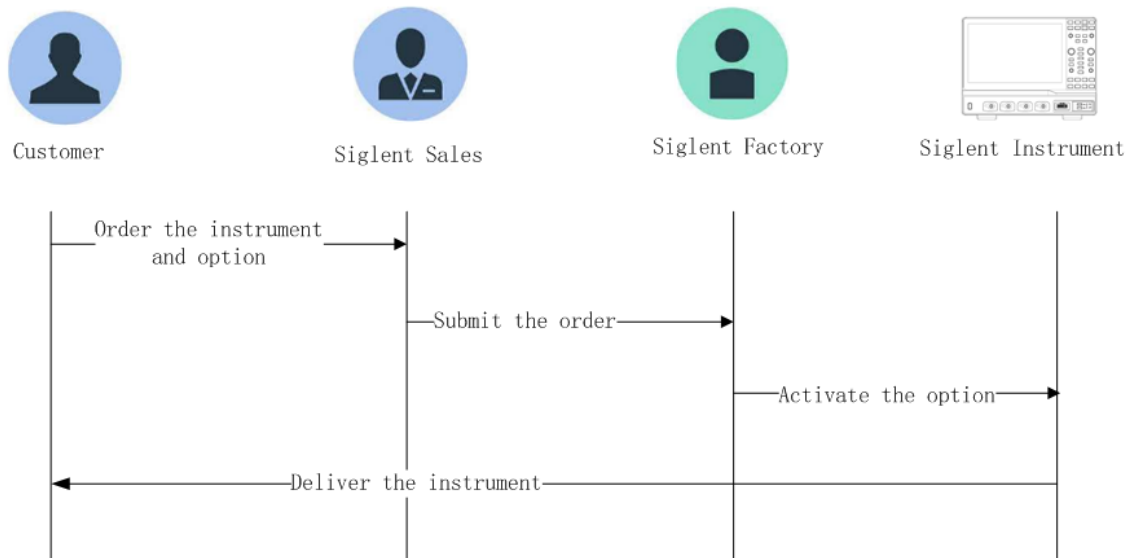

2. Post-activate the options by yourself.

If you want to activate options on a instrument that you are using.

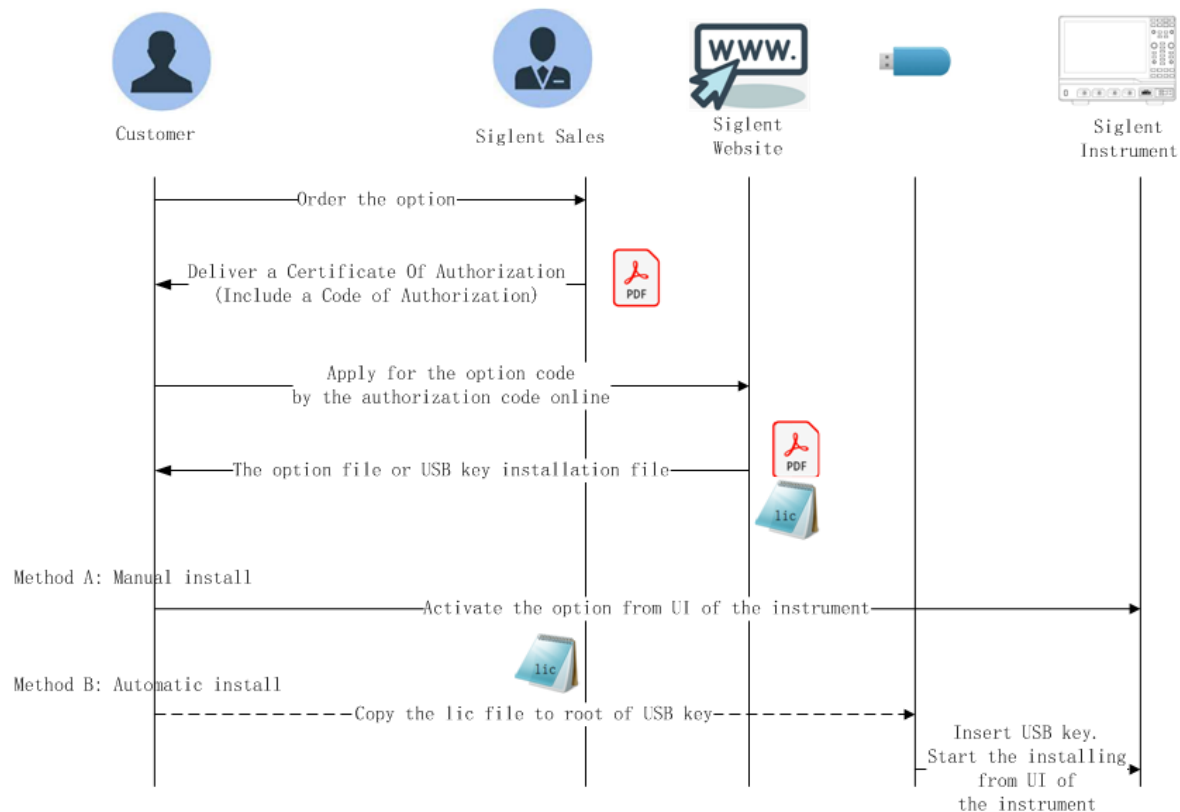

15.2 Warranty overview

SIGLENT guarantees that the products produced and sold will not have defects in materials and technology within three years from the date of delivery by authorized distributors. If the product is defective within the warranty period, **SIGLENT** will provide repair or replacement service according to the detailed provisions of the warranty.

For service or a complete copy of the warranty, please contact your nearest **SIGLENT** sales and service office. **SIGLENT** makes no other warranty, express or implied, except as provided in this summary or the applicable warranty, including but not limited to the implied warranty of merchantability and special applicability. **SIGLENT** shall not be liable for any indirect, special or consequential damages.



About SIGLENT

SIGLENT is an international high-tech company, concentrating on R&D, sales, production and services of electronic test & measurement instruments.

SIGLENT first began developing digital oscilloscopes independently in 2002. After more than a decade of continuous development, SIGLENT has extended its product line to include digital oscilloscopes, isolated handheld oscilloscopes, function/arbitrary waveform generators, RF/MW signal generators, spectrum analyzers, vector network analyzers, digital multimeters, DC power supplies, electronic loads and other general purpose test instrumentation. Since its first oscilloscope was launched in 2005, SIGLENT has become the fastest growing manufacturer of digital oscilloscopes. We firmly believe that today SIGLENT is the best value in electronic test & measurement.

Headquarters:

SIGLENT Technologies Co., Ltd

Add: Bldg No.4 & No.5, Antongda Industrial Zone, 3rd Liuxian Road, Bao'an District, Shenzhen, 518101, China

Tel: + 86 755 3688 7876

Fax: + 86 755 3359 1582

Email: sales@siglent.com

Website: int.siglent.com

North America:

SIGLENT Technologies America, Inc

6557 Cochran Rd Solon, Ohio 44139

Tel: 440-398-5800

Toll Free: 877-515-5551

Fax: 440-399-1211

Email: info@siglentna.com

Website: www.siglentna.com

Europe:

SIGLENT Technologies Germany GmbH

Add: Staetzlinger Str. 70

86165 Augsburg, Germany

Tel: +49(0)-821-666 0 111 0

Fax: +49(0)-821-666 0 111 22

Email: info-eu@siglent.com

Website: www.siglenteu.com

Follow us on
Facebook: [SiglentTech](https://www.facebook.com/SiglentTech)

