



PFC100 Series Fiber Connector Epoxy Curing Ovens

User Manual

















Curing Block(s) and Guide Plate(s) Sold Separately

Table of Contents

Chapter 1	Warning Symbol Definitions.....	1
Chapter 2	Safety.....	2
Chapter 3	Description	3
Chapter 4	Unboxing and Setup.....	4
	4.1. <i>Shipping List</i>	4
	4.2. <i>Setup</i>	5
Chapter 5	Operation	8
	5.1. <i>Loading Connectors</i>	8
	5.2. <i>Load Curing Profile</i>	8
	5.3. <i>Edit Profile / Custom Profile</i>	9
	5.4. <i>Curing</i>	10
	5.6. <i>Lights and Indicator</i>	11
	5.6.1. Yellow Burn Hazard Light.....	11
	5.6.2. Red Fault Light.....	11
	5.6.3. End of Cycle Indicator	12
	5.6.4. Line Signal Output.....	13
	5.7. <i>Export Curing Data</i>	14
	5.8. <i>Shut Down</i>	15
Chapter 6	Trouble Shooting	16
	6.1. <i>No Power</i>	16
	6.1.1. Screen Lock-up	16
	6.1.2. General Reset	16
Chapter 7	General Maintenance.....	17
	7.1. <i>Residual Epoxy Cleaning</i>	17
	7.2. <i>General Cleaning</i>	17
Chapter 8	Specifications.....	18
Chapter 9	Mechanical Drawings	19
Chapter 10	Regulatory	21
	10.1. <i>Waste Treatment is Your Own Responsibility</i>	21
	10.2. <i>RF Interference</i>	21
	10.3. <i>Ecological Background</i>	21
Chapter 11	Declaration of Conformity	22
Chapter 12	Thorlabs Worldwide Contacts.....	23

Chapter 1 Warning Symbol Definitions

Below is a list of warning symbols you may encounter in this manual or on your device.

Symbol	Description
	Direct Current
	Alternating Current
	Both Direct and Alternating Current
	Earth Ground Terminal
	Protective Conductor Terminal
	Frame or Chassis Terminal
	Equipotentiality
	On (Supply)
	Off (Supply)
	In Position of a Bi-Stable Push Control
	Out Position of a Bi-Stable Push Control
	Caution: Risk of Electric Shock
	Caution: Hot Surface
	Caution: Risk of Danger

Chapter 2 Safety



SHOCK WARNING



Do not open the unit under any circumstances. There are no user serviceable parts inside.
Do not operate the unit without curing blocks.



CAUTION



Before connecting the AC power cord, make sure the source voltage is correct.
Input voltages outside this range may result in damage to the unit.



WARNING



Do not use this product in environments where flammable or explosive gasses may be present! Do not use the oven near flammable liquid, e.g., alcohol or acetone. Only cure epoxy in a well-ventilated area.



WARNING



Do not touch the hot oven surfaces while the unit is on or while cooling.
At the end of cycle, do not unplug unit until the yellow hazard lamp is off.

If the red fault light is ON, disconnect the unit.
The oven is malfunctioning and must be returned to Thorlabs for inspection and repair.
Do not use or attempt to repair the malfunctioning oven.



BASIC SAFETY EQUIPMENT



Safety glasses and heat resistant gloves are required while operating this machine.

Chapter 3 Description

The PFC100 series fiber connector epoxy curing ovens are specifically designed for curing high performance epoxy during the fiber to ferrule termination process. Models are available with simultaneous curing capacities of 36 connectors (PFC111 & PFC112) or 72 connectors (PFC121 & PFC122). FC/PC, FC/APC, SMA, ST®/PC, and SC/PC connectors are compatible.

PFC100 is controlled by its own touch screen PID heater controller. It has a capability of 50 ramp soak steps and 99 preset curing schedules. The 250 W heater is capable to bring the curing area up to 150 °C (300 °F). The PID has the capability of controlling the heater ± 1.5 °C during the curing cycle. The oven can be set at constant temperature (soak) or programmed ramp and soak cycle.

A time vs temperature log is recorded by the controller and then exported through the USB for tracking and quality control purposes. Refer to this manual for the procedure.

This device is solely designed for curing fiber connectors. Do not use the oven for any other purposes. Doing so will void the warranty and may cause damage to the machine and/or result in personal injury.

Check the voltage and corresponding model number before operation.

PFC111	Single Bay Oven, 120 VAC
PFC112	Single Bay Oven, 220 VAC
PFC121	Dual Bay Oven, 120 VAC
PFC122	Dual Bay Oven, 220 VAC

The following accessories are sold separately. One curing block is required per oven bay, while the guide plates are optional:

PFC9AL	Aluminum Curing Block for $\varnothing 8$ - 9 mm Connectors
PFC10AL	Aluminum Curing Block for $\varnothing 9$ - 10 mm Connectors

PFC8TF	PTFE Guide Plate for $\varnothing 8$ mm Connectors
PFC9TF	PTFE Guide Plate for $\varnothing 9$ mm Connectors
PFC10TF	PTFE Guide Plate for $\varnothing 10$ mm Connectors



Figure 1 Curing Block (Left) and Guide Plate (Right)

Chapter 4 Unboxing and Setup

4.1. Shipping List

- Curing Oven
- Tool Kit
 - 5/32" Hex Driver
 - Curing Block Removal Tools
 - Plastic Scraper
 - Plastic Blade (5 pcs)
- Fiber Holder(s) (One per Bay)
- Region-Specific Power Cord
- **If Ordered:** Curing Block(s) (Required; Sold Separately) and Guide Plate(s) (Optional; Sold Separately)



Figure 2 Unit packaging, showing manual tool pouch and power cord on first layer. The second layer contains the curing block(s) with guide plate(s) installed (if purchased) in white cardboard box(es) above the curing oven.

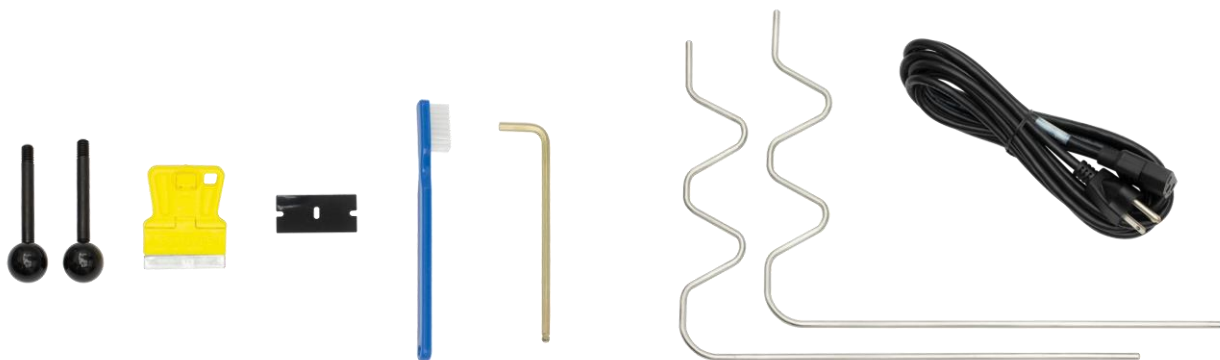

Figure 3 Tools & Accessories



CAUTION



For future repair and transportation, it is recommended that the customer retain the original packaging to prevent shipping damage. The curing block should never be attached to the oven during shipping. Serious damage to the unit will occur.

4.2. Setup

These curing ovens are intended to be used in indoor lab and manufacturing environments.

1. Place the unit on a level table top, preferably in a fume hood or well ventilated area. Fume may emit during the epoxy curing.
2. Plug the power supply cable into an AC outlet (120 VAC **OR** 220 VAC).
CAUTION: This unit is voltage specific and is not dual voltage.
Check the label on the back of the oven for the unit's voltage.



Figure 4 Power Supply Connector (120 VAC Model Shown)

3. Insert the fiber holder(s) in the rear of the control console.



Figure 5 Install Fiber Holder(s)

4. Prepare the curing block(s) for installation. If the optional guide plate(s) were also purchased, use the supplied hex driver to install them onto the curing block(s) using a criss cross tightening pattern. Repeat the pattern twice to ensure the block is fully seated, but **do not over tighten the mounting screws**. The guide plate(s) will appear loose; once heated, there will be no movement. Next, attach the lifting tools to the curing block as shown below.



Figure 6 *Installing Guide Plate and Lifting Tools*

5. Lower the curing block assembly onto the heater plate in the oven bay and tighten the four corner screws. **Do not over tighten the curing block to the heater plate.**



Figure 7 *Install Curing Block on the Oven*

6. Remove the lifting tools and store them in the tool holder on the back of the oven.

7. Turn on the unit with the power switch located at the front. The unit will start up and go through the boot-up sequence (approx. 30 seconds).



Figure 8 On/Off Toggle Switch on Front Panel

8. When the unit boots up, the default screen will automatically be the last curing profile.

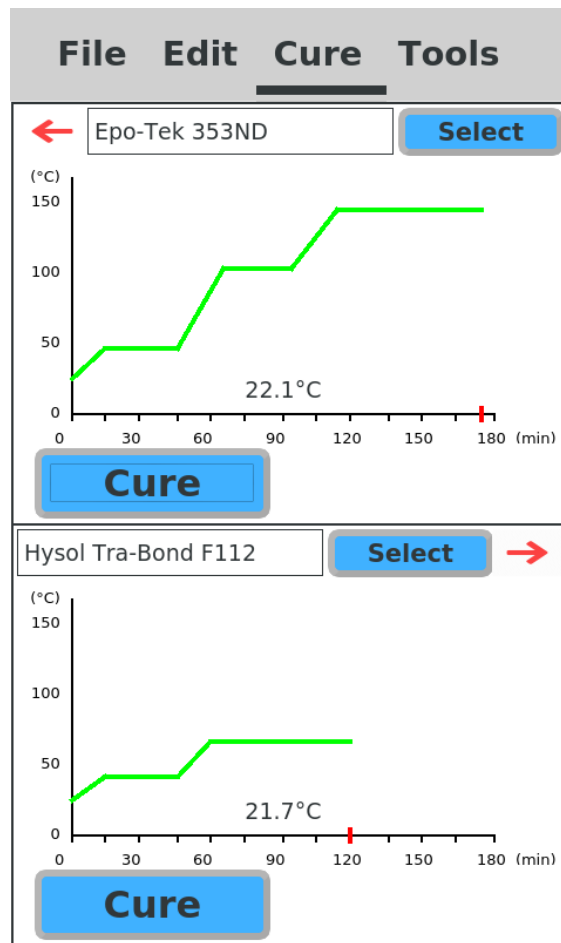

Figure 9 Default Screen

Chapter 5 Operation

5.1. Loading Connectors

After each connector is filled with epoxy, clean off excessive epoxy. Load the prepared connectors from rear to front. If the number of connectors is less than the number of ports, it is recommended to space out the connectors evenly for more accurate thermal distribution.



Figure 10 Loading Fibers

5.2. Load Curing Profile

The curing oven is preloaded with common curing profiles. The operator can press the **File** button to choose between these profiles. Profiles can also be imported or exported using an attached USB drive. Once the profile is selected, press the “**Cure**” button to begin the process.

This step can be omitted if the desired profile is already loaded on the startup screen.

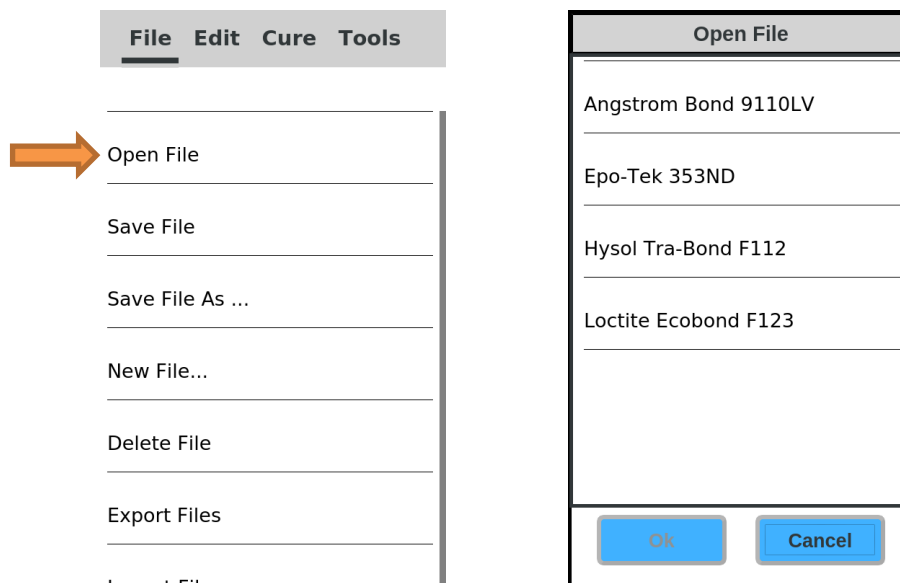

Figure 11 Select Profile

5.3. Edit Profile / Custom Profile

After the profile is selected, press Edit to display the ramp and soak steps.

File	Edit	Cure	Tools
Epo-Tek 353ND			
1: Ramp 15 min to 45C, Soak 30 min			
2: Ramp 20 min to 100C, Soak 30 min			
3: Ramp 20 min to 140C, Soak 60 min			

Fan Cooled

Figure 12 Profile Steps & Fan Option

The operator can create up to 99 custom profiles for the oven. After pressing “**Edit**”, the operator can then input the ramp time and temperature accordingly. A new step can also be added by pressing “**Add**” or “**Delete**” for removal. By pressing “**File, Save**” and input a new profile name. Alternately, the operator can modify each step individually by clicking on each line item. Once the profile is modified, it can either overwrite the existing profile or save file under a new name.

Temperature (°C)

45

Ramp Time (Min)

15

Soak Time (Min)

30

Figure 13 Step Parameters

5.4. Curing

At default screen by pressing “Cure” the process will begin. A red profile plot will be shown indicating the current heating status. A current temperature is indicated on the RHS of the screen. A black time lapse indicator at the bottom of the graph shown the current progress status.

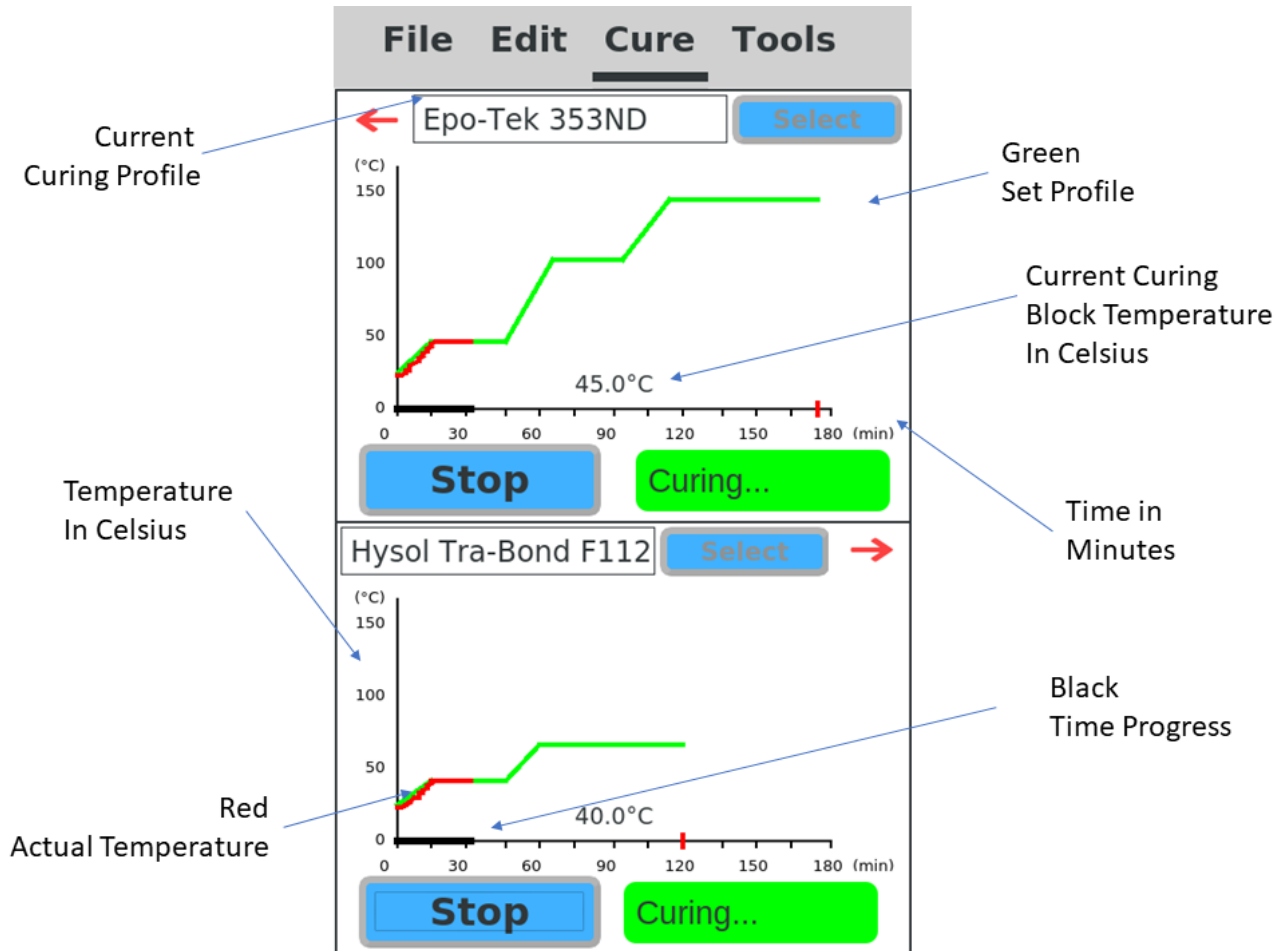

Figure 14 Showing oven curing in process

5.6. Lights and Indicator

5.6.1. Yellow Burn Hazard Light

Once the oven reaches 45 °C, a yellow caution LED will turn on signalling the burn hazard of the heating area. The light will remain on as long as the curing block is above 45 °C regardless of whether the oven is running a curing cycle or not.



Figure 15 Yellow Burn Caution Warning Light

5.6.2. Red Fault Light

A red warning LED will light up when the oven is too hot indicating there is a malfunction. Do not continue to use the oven. Unit must be returned to Thorlabs for inspection and repair.



Figure 16 Red Fault Warning Light

5.6.3. End of Cycle Indicator

At the “End of Cycle”, the message “Cure Complete” will be displayed across the screen for the corresponding oven bay and the buzzer will sound for 20 seconds. The operator can touch anywhere on the screen to clear the message. If the “Fan On” option is checked, the rear cooling fan will also turn on, shortening the cooling time.

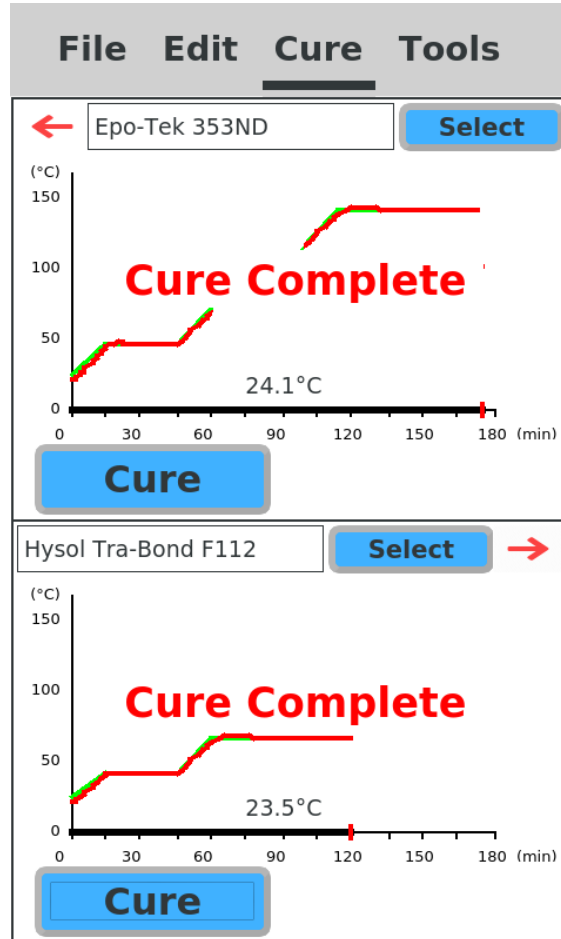

Figure 17 End of Cycle Screen and Rear Cooling Fan

5.6.4. Line Signal Output

The curing oven is also equipped with a **Line Light output**. The output is a **Normally Open relay contact** and does not provide any power. It is rated at 24 VAC or 35 VDC, 200 mA RMS (DC or AC). The load rating should not exceed these values, or a damage to the Line Light Output might occur. The intended load is either a light indicator (such as an Andon light) with external power, or control inputs for such lights.

No inductive load (motors, relays, solenoids, etc.) are allowed. Inductive load might damage the Line Light output.



Figure 18 Line Light Output

5.7. Export Curing Data

The oven actively logs each curing cycle. To access these logs, go to “Tools” and insert a USB thumb drive in the front USB port, then press “Export Temperature Profile”. One comma-separated value (.CSV) file per oven bay will be saved on the thumb drive, which can then be imported into spreadsheet software. A new version with the same filename will be saved at the end of every curing cycle.

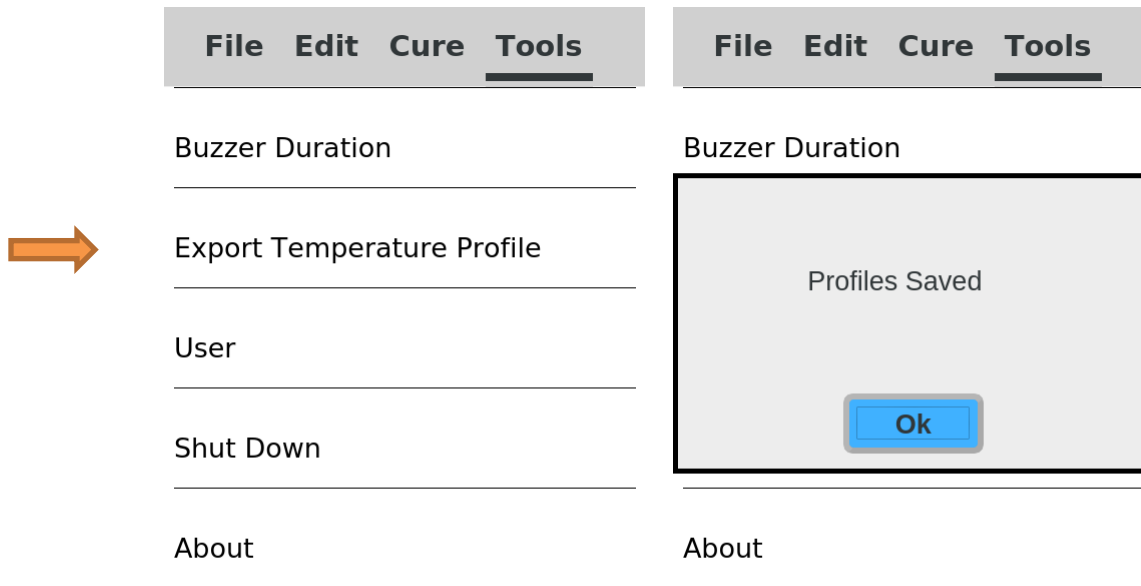

Figure 19 Export Temperature Profile

<input type="checkbox"/>	Name	Date modified	Type	Size
<input type="checkbox"/>	Heater1Profile.txt	11/3/2021 11:57	Text Document	4 KB
<input type="checkbox"/>	Heater2Profile.txt	11/3/2021 11:57	Text Document	3 KB

**Figure 20 Exported Data Sample (Double Bay)
(Single Bay Unit will Only Output Heater2Profile)**

5.8. Shut Down

In order to protect the integrity of the memory and the operating system, the unit should be properly shut down. Simply press the “Tools” button and click “Shut Down” The screen will go blank and a blue “no signal” icon will be displayed, at which point the operator can safely turn off the unit.

The oven must be power cycled using the power switch in order to come out of the “Shut Down” state.

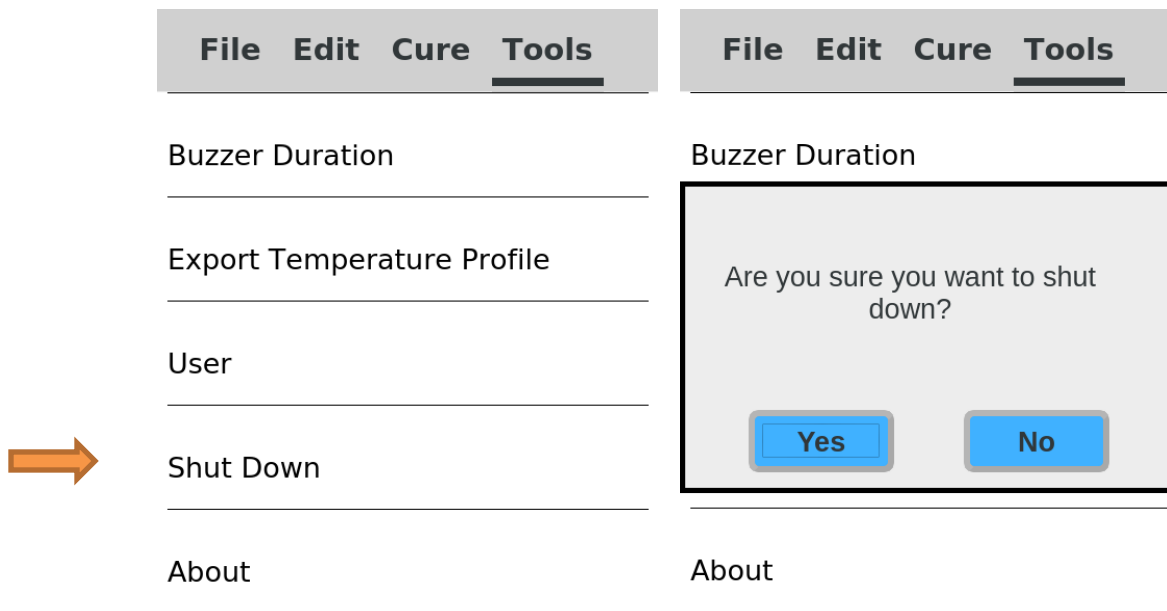

Figure 21 Shut Down Screen

Chapter 6 Trouble Shooting

6.1. No Power

The curing oven's fuse tray is located at the power entry module on the rear panel and contains two 6.3 A fuses. Use a screwdriver to remove the fuse compartment and use a continuity meter to check if a fuse is blown. Replace both fuses with the same amperage rating and size. Using a fuse with a higher amperage rating can cause severe wire damage and could start a fire.



Figure 22 Fuse Compartment

6.1.1. Screen Lock-up

In case the screen freezes up, the curing cycle may continue running. To unfreeze the screen, cycle the power.

6.1.2. General Reset

Turn the oven off and remove power from the outlet. Wait one minute to turn the machine back on. The machine should go back to default screen.

Chapter 7 General Maintenance

7.1. Residual Epoxy Cleaning

Before any cleaning, ensure the oven is at room temperature and the power is disconnected.

	Safety Glasses and Gloves Required	
There maybe broken glass fiber inside the curing compartent		

During normal use there may be epoxy deposit and broken glass fiber on the the curing block or the heater plate. The curing block and heater plate are coated with non-stick coating. Epoxy will generally bead up upon curing. Do not use any hard object to scrape off epoxy residue. The enclosed plastic scraper can easily remove the cured epoxy. Then the loose epoxy can be removed by vacuuming or be picked up with masking tape.

Discard the loose epoxy and uncured epoxy in accordance with local regulations.

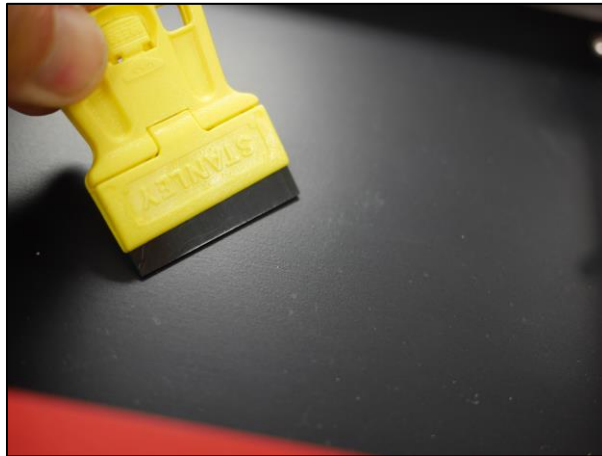

Figure 23 Clean Epoxy from Heater Plate

7.2. General Cleaning

When necessary, let the unit cool to room temperature and disconnect the power. The unit can be wiped with a cloth soaked with isopropyl alcohol. Do not spray any liquid on the unit and do not use acetone on unit as it will damage the markings and plastic components.

Chapter 8 Specifications

Item #	PFC111	PFC112	PFC121	PFC122
Compatible Fiber Connectors	FC/PC, FC/APC, ST@/PC, SMA			
Connector Capacity	36		72	
Max Temperature	150 °C			
Temperature Accuracy	±1.5 °C			
Power Consumption	250 W (Single Bay)		500 W (Double Bay)	
Max # of Curing Profiles	99			
Max # of Steps	50			
Temperature Logging	1 min. Increment CSV Format Accessible Through USB			
Operating Conditions	15 to 30 °C, 0 - 85% RH (Non-Condensing)			
Storage Conditions	-40 to 80 °C, 0 - 95% RH (Non-Condensing)			
Power Source	90-130 VAC @ 47-63 Hz	210-240 VAC @ 47-63 Hz	90-130 VAC @ 47-63 Hz	210-240 VAC @ 47-63 Hz
Physical Dimensions	16.96" x 15.10" x 9.72" (430.7 mm x 383.6 mm x 247.0 mm)		24.88" x 15.10" x 9.72" (631.8 mm x 383.6 mm x 247.0 mm)	
Mass (Weight)	7 kg (15 lbs)		10 kg (22 lbs)	

Chapter 9 Mechanical Drawings

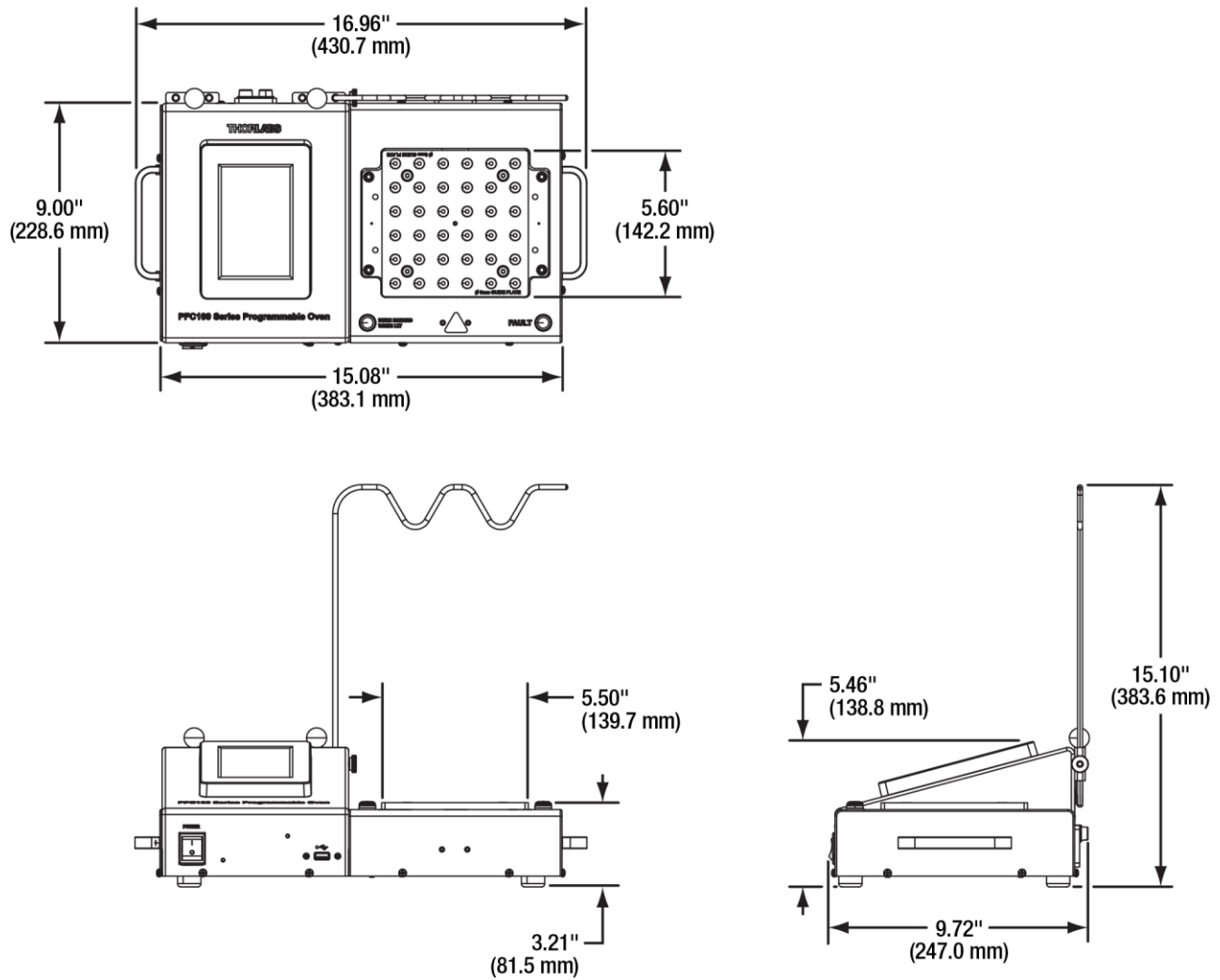

Figure 24 Single Bay Ovens (Curing Blocks Sold Separately)

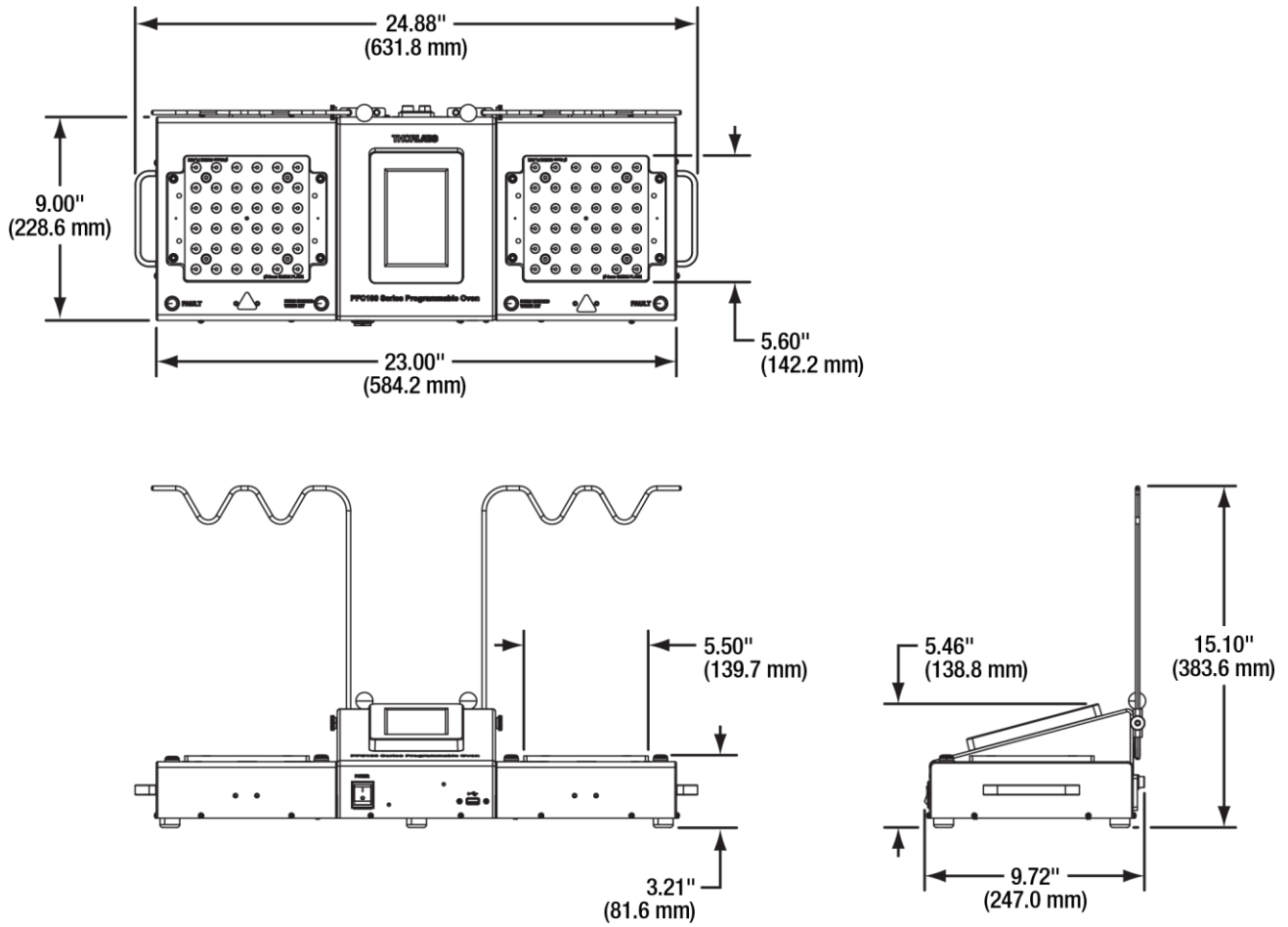
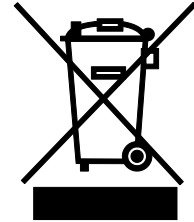

Figure 25 Double Bay Ovens (Curing Blocks Sold Separately)

Chapter 10 Regulatory

As required by the WEEE (Waste Electrical and Electronic Equipment Directive) of the European Community and the corresponding national laws, Thorlabs offers all end users in the EC the possibility to return “end of life” units without incurring disposal charges.

- This offer is valid for Thorlabs electrical and electronic equipment:
- Sold after August 13, 2005
- Marked correspondingly with the crossed out “wheelie bin” logo (see right)
- Sold to a company or institute within the EC
- Currently owned by a company or institute within the EC
- Still complete, not disassembled and not contaminated



As the WEEE directive applies to self-contained operational electrical and electronic products, this end of life take back service does not refer to other Thorlabs products, such as:

- Pure OEM products, that means assemblies to be built into a unit by the user (e. g. OEM laser driver cards)
- Components
- Mechanics and optics
- Left over parts of units disassembled by the user (PCB's, housings etc.).

If you wish to return a Thorlabs unit for waste recovery, please contact Thorlabs or your nearest dealer for further information.

10.1. Waste Treatment is Your Own Responsibility

If you do not return an “end of life” unit to Thorlabs, you must hand it to a company specialized in waste recovery. Do not dispose of the unit in a litter bin or at a public waste disposal site.

10.2. RF Interference

WARNING

This equipment has been tested and found to comply with the limits for a Class A digital device, pursuant to Part 15 of the FCC Rules and meets all requirements of the Canadian Interference-Causing Equipment Standard ICES-003 for digital apparatus. These limits are designed to provide reasonable protection against harmful interference when the equipment is operated in a commercial environment. This equipment generates, uses, and can radiate radio frequency energy and, if not installed and used in accordance with the instruction manual, may cause harmful interference to radio communications. Operation of this equipment in a residential area is likely to cause harmful interference in which case the user will be required to correct the interference at his own expense.

The use of shielded I/O cables shorter than 3 meters (9.8 feet) is required when connecting this equipment to any and all optional peripheral or host devices. Failure to do so may violate FCC and ICES rules.

Thorlabs GmbH is not responsible for any radio television interference caused by modifications of this equipment or the substitution or attachment of connecting cables and equipment other than those specified by Thorlabs GmbH. The correction of interference caused by such unauthorized modification, substitution or attachment will be the responsibility of the user.

10.3. Ecological Background

It is well known that WEEE pollutes the environment by releasing toxic products during decomposition. The aim of the European RoHS directive is to reduce the content of toxic substances in electronic products in the future.

The intent of the WEEE directive is to enforce the recycling of WEEE. A controlled recycling of end of life products will thereby avoid negative impacts on the environment.

Chapter 11 Declaration of Conformity



THORLABS
www.thorlabs.com

EU Declaration of Conformity
in accordance with EN ISO 17050-1:2010

We: Thorlabs Inc.
Of: 56 Sparta Avenue, Newton, New Jersey, 07860, USA

in accordance with the following Directive(s):

2014/35/EU	Low Voltage Directive (LVD)
2014/30/EU	Electromagnetic Compatibility (EMC) Directive
2011/65/EU	Restriction of Use of Certain Hazardous Substances (RoHS)

hereby declare that:
Model: **PFC111, PFC112, PFC121 & PFC122**

Equipment: **Fiber Connector Epoxy Curing Ovens**

is/are in conformity with the applicable requirements of the following documents:

EN 61010-1	Safety Requirements for Electrical Equipment for Measurement, Control and Laboratory Use - EMC Requirements 2013
EN 61326-1	Electrical Equipment for Measurement, Control and Laboratory Use - EMC Requirements 2013

and which, issued under the sole responsibility of Thorlabs, is/are in conformity with Directive 2011/65/EU of the European Parliament and of the Council of 8th June 2011 on the restriction of the use of certain hazardous substances in electrical and electronic equipment, for the reason stated below:

contains no substances in excess of the maximum concentration values tolerated by weight in homogenous material

I hereby declare that the equipment named has been designed to comply with the relevant sections of the above referenced specifications, and complies with all applicable Essential Requirements of the Directives.

Signed:  **On:** 08 March 2022

Name: Danielle Strong
Position: Director of Quality and Compliance

CE

EDC - PFC111, PFC112, PFC121 & P...

Chapter 12 Thorlabs Worldwide Contacts

For technical support or sales inquiries, please visit us at www.thorlabs.com/contact for our most up-to-date contact information.



USA, Canada, and South America

Thorlabs, Inc.
sales@thorlabs.com
techsupport@thorlabs.com

Europe

Thorlabs GmbH
europe@thorlabs.com

France

Thorlabs SAS
sales.fr@thorlabs.com

Japan

Thorlabs Japan, Inc.
sales@thorlabs.jp

UK and Ireland

Thorlabs Ltd.
sales.uk@thorlabs.com
techsupport.uk@thorlabs.com

Scandinavia

Thorlabs Sweden AB
scandinavia@thorlabs.com

Brazil

Thorlabs Vendas de Fotônicos Ltda.
brasil@thorlabs.com

China

Thorlabs China
chinasales@thorlabs.com



THORLABS
www.thorlabs.com
