

UNI-T®

UTL8500 Series Programmable DC Electronic Load User Manual



Preface

Thank you for purchasing this brand new product. In order to use this product safely and correctly, please read this manual thoroughly, especially the safety notes.

After reading this manual, it is recommended to keep the manual at an easily accessible place preferably close to the device, for future reference.

Copyright Information

Uni-Trend Technology (China) Co., Ltd. all rights reserved.

UNI-T is the registered trademark of Uni-Trend Technology (China) Co., Ltd.

UNI-T products are protected by patent rights in China and other countries, including issued and pending patents. Uni-Trend reserves the rights to any product specification and pricing changes.

Uni-Trend reserves all rights. Information in this manual supersedes all previously published versions. No part of this manual may be copied, extracted or translated by any means without the prior permission of Uni-Trend.

Warranty Service

The instrument has a warranty period of one year from the date of purchase. If the instrument is damaged due to improper operation by the user during the warranty period, the maintenance fee and the costs caused by the maintenance shall be borne by the user, and the instrument shall be maintained by the company for life.

If the original purchaser sells or transfers the product to a third party within one year from the date of purchase of the product, the warranty period of one year shall be from the date of the original purchase from UNI-T or an authorized UNI-T distributor. Power cords, accessories and fuses, etc. are not included in this warranty.

If the product is proved to be defective within the warranty period, UNI-T reserves the rights to either repair the defective product without charging of parts and labor, or exchange the defected product to a working equivalent product (determined by UNI-T). Replacement parts, modules and products may be brand new, or perform at the same specifications as brand new products. All original parts, modules, or products which were defective become

the property of UNI-T.

The “customer” refers to the individual or entity that is declared in the guarantee. In order to obtain the warranty service, "customer" must inform the defects within the applicable warranty period to UNI-T, and perform appropriate arrangements for the warranty service. The customer shall be responsible for packing and shipping the defective products to the designated maintenance center of UNI-T, pay the shipping cost, and provide a copy of the purchase receipt of the original purchaser. If the product is shipped domestically to the location of the UNI-T service center, UNI-T shall pay the return shipping fee. If the product is sent to any other location, the customer shall be responsible for all shipping, duties, taxes, and any other expenses.

Guarantee Limit

This warranty shall not apply to any defects, malfunction or damages caused by accidental, machine parts' wear and tear, using outside the product's specifications, improper use, and improper or lacking of maintenance. UNI-T under the provisions of this warranty has no obligation to provide the following services:

- a) Any repair damage caused by the installation, repair, or maintenance of the product by non UNI-T service representatives;
- b) Any damage caused by improper use or connection to an incompatible device;
- c) Any damage or malfunction caused by the use of a power source not provided by UNI-T;
- d) Any maintenance on altered or integrated products (if such alteration or integration leads to an increase in time or difficulty of product maintenance).

This warranty is written by UNI-T for this product and it is used to substitute any other express or implied warranties. UNI-T and its distributors do not offer any implied warranties for merchantability or applicability purposes. For violation of this guarantee, UNI-T is responsible for the repair or replacement of defective products as the only and complete remedy available to customers. Regardless of whether UNI-T and its distributors are informed that any indirect, special, incidental, or consequential damage may occur, the UNI-T and its distributors shall not be responsible for any of these damages.

Safety Information

⚠Warning ⚠Caution: to avoid specifies conditions and actions that may pose hazards

to the user, be sure to use this product in accordance with the regulations.

Please read through the safety guideline, in case the meter is not used properly as instructions, the protection provided may be weakened or lost.

Correct connection of ground wire: To avoid electric shock, please use the provided cable to connect and make sure that the product is properly grounded before use.

Please notice the rated operating range. Please ensure that the mains supply does not exceed 10% of rated operating range to prevent damage.

Use the correct power line: Only use the dedicated UNI-T power line to connect the measured power supply and the electronic load, which is to ensure that there is no overheat by short-circuit current, otherwise electric shock may occur.

Please notice the product marks before connecting. The instrument supports 2 kinds of AC input method: 110V and 220V. Please check if the switch of load is match with the input power source, and the fuse is correctly installed, or damage will occur.

Please do not operate in inflammable and explosive environment. Do not use or store the meter in high temperature, high humidity, flammable, explosive and strong magnetic field environments.















Never open the casing of the product. Only trained personnel can perform the maintenance program. The instrument will not fully discharged after power off, which may cause electric shock and injury.

Do not operate the product if you suspect it is faulty. Please contact UNI-T authorized service personnel for inspection. Please disconnect the power supply and stop using.

Never use the instrument beyond the dedicated range of instruction. The provided protection will be weaken or invalid. It is forbidden to use this product in life-support system or other devices with safety requirements.

Only trained personnel can perform the maintenance program. Any maintenance, adjustment, or replacement of parts must be performed by UNI-T authorized maintenance personnel.

Safety Symbols

	Direct Current		Alternating Current		Both Direct and Alternating Current
	Three Phase AC		Earth (Ground) Terminal		Protective Conductor Terminal
	Signal Grounding		Caution, Possibility of Electric Shock		Warning or Caution
	Neutral Wire or Central Wire		Live Wire		On (Power)
	Off (Power)		Backup Power		Ground Terminal for Chassis

Environment-Friendly Use Period (EFUP)



This product contains certain hazardous substances and can be used safely during its environmental-friendly use period (EFUP) of 40 years, as shown in the symbol on the left. If the specified time is exceeded, the product should be recovered.

Waste Electrical and Electronic Equipment (WEEE) Instruction 2002/96/EC



Do not dispose the product and its accessories in trash bin.

Table of Contents

Preface	2
Copyright Information	2
Warranty Service	2
Guarantee Limit	3
Safety Information	3
Safety Symbols	5
1. Product Description	8
1.1 Product Series	8
1.2 Front Panel	9
1.3 Rear Panel.....	11
2. Inspection and Installation	9
2.1 Packing List	12
2.2 Requirements of Power Supply.....	12
2.3 Operating Environment	13
2.4 Cleaning	13
2.5 Handle of Instrument.....	13
3. Display Page of Measurement	11
3.1 Power on and Run	14
3.2 Introduction of Screen Display	15
3.2.1 Display of Measurement Interface	15
3.2.2 Introduction of Status Bar	16
3.2.3 Running Indicator	16
4. Measurement Setting	14
4.1 Constant State Test Modes.....	17
4.1.1 Constant Current Test	17
4.1.2 Constant Voltage Test.....	18
4.1.3 Constant Resistance Test	19
4.1.4 Constant Power Test.....	20
4.2 More Modes.....	22
4.2.1 Dynamic Mode	23
4.2.2 List Mode.....	24
4.2.3 Dual Mode.....	28

4.2.4 OCP/OPP Mode	29
4.2.5 CR-LED Mode	30
4.2.6 Battery Mode	31
4.2.7 Load Effect	33
4.2.8 OVP Mode.....	34
4.2.9 Short-Circuit Mode	35
4.2.10 Time Mode	36
4.3 Parameter Input and Loading Measurement	37
4.3.1 Numeric Key.....	37
4.3.2 Pulse Knob.....	38
4.3.3 Ripple Measurement	38
4.3.4 Input Control.....	38
4.4 Trigger Method	38
4.5 Sense	39
4.6 Screenshot	39
4.7 Saving and Applying of Configuration	39
5. System Configuration Page.....	40
5.1 System Configuration.....	40
5.1.1 Language	42
5.1.2 Key Sound.....	42
5.1.3 Date	42
5.1.4 Warn Sound	42
5.1.5 Time	42
5.1.6 DIM Display	42
5.1.7 Initial Mode.....	42
5.1.8 Knob Active	43
5.1.9 Communication Setting	43
5.1.10 Restore Factory Setting.....	43
5.2 Parameter Setting.....	44
5.3 File	47
5.4 Instrument Info.....	47
5.5 Local/Remote	47
6. Communication Interface and Terminal.....	48
7. Technical Specifications.....	51

1. Product Description

Thank you for purchasing the Uni-Trend Programmable DC electronic load. This chapter mainly covers the following:

- Product Series
- Front Panel
- Rear Panel

1.1 Product Series

UTL8500 series DC electronic load contains 4 models: UTL8511, UTL8512, UTL8512B+ and UTL8513.

Models	Measurement Range		
	Voltage	Current	Power
UTL8511	0~150V	0~30A	0~150W
UTL8512	0~150V	0~30A	0~300W
UTL8512B+	0~500V	0~15A	0~300W
UTL8513	0~150V	0~120A	0~600W

UTL8500 series DC electronic load comes with 4.3-inch LCD screen, wide power range and up to 0.1mV/0.1mA resolution. It supports multiple test modes: dynamic test, overload test, auto test, list test, battery test and CR-LED test, etc. The instrument is great tools in areas of electronic performance test, battery set test, power supply test, new energy test, aerospace industries, high-power test, labs, R&D and production line, etc.

Equipped with standard RS232 interface and support more extension interfaces, UTL8500 series offer multiple-role solutions for your different design and testing requirements.

1.1.1 Features

- Measurement Range: 150W/300W/600W, 150V/500V, 15A/30A/120A
- Four Basic Test Modes: CC/CV/CR/CP
- Function of Remote Current Monitoring and External Triggering
- High Resolution of 0.1mV/0.1mA
- Dynamic Voltage/Current Test with up to 10k Dynamic Frequency
- Voltage/Current Sampling Rate: 40kHz
- CR-LED Test, Power Source Rise/Decline Time Test
- Protections of Over-Voltage/ Under-Voltage/ Over-Current/ Over-Power/ Overheat/ Anti- Reverse Connection

- The list mode comes with storage, and supports the saving and applying of the external U disk and the upgrade of the U disk system.
- Screenshot Function with List Storage & Recall
- Equipped with Standard RS232 Interface and Support More Extension Interfaces (USB or RS-485 Converted by RS-232)
- Remote Voltage Compensation Input Function
- Configured with Upper Computer Software for Remote Control and Monitoring
- Ripple Sampling and Detection Function
- Three Dual Tests: CR + CC, CV + CR, CV + CC
- OCP/OPP/OVP Test and Load Effect Test
- Intelligent Cooling Fan and Power-Down Memory Function
- Independent Short-Circuit Test Function (Only for CC/CV/CR/CP Mode)
- List Auto-Power-On Function and Over-Voltage Short Circuit
- Pause Function in List Mode

1.2 Front Panel

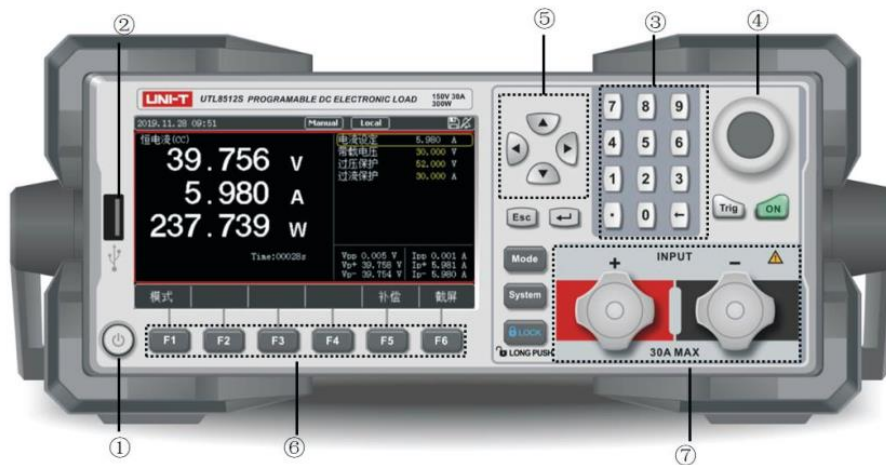













Figure 1-2-1 Front Panel (UTL8512)

Table 1-2-1 Introduction of Front Panel

No.	Items	Description
①		Power Button: Press It to Power ON/OFF
②		USB Interface: The user can save the test data and screenshot to U-disk. It can also be used in list test files storage/recalling and system upgrade
③		Numeric Keyboard: It is used to enter numbers and decimal points.

		Delete the Input Values
④		Pulse Knob: It is used to adjust the parameters or move cursor in the menu.
⑤		Direction Buttons: They are used to move cursor or adjust the selected value.
⑥		F1-F6 Function Keys: They are used to perform the function displayed on the screen.
⑦		Input Terminals: They are used to connect power source, please do not inversely connect to prevent damage
		Mode Shortcut Key: Press to enter setting interface to select CC, CV, CR, CP and other modes.
		System Configuration: It is used to set the system parameters, operating parameters, file operations and view the instrument information.
		In order to avoid misoperation, the instrument adds keyboard lock function. After pressing the lock key, other keys are disabled except the ON key. When the key light is on, the keyboard has been locked; long press for 1-2S to unlock.
		Manual Trigger Button: Press Once to Operate a Manual Trigger
		Load Input Control: ON/OFF
		Esc Button: Exit or Return to Previous Menu
		This button is used to confirm/modify the selected item or parameters.

1.3 Rear Panel

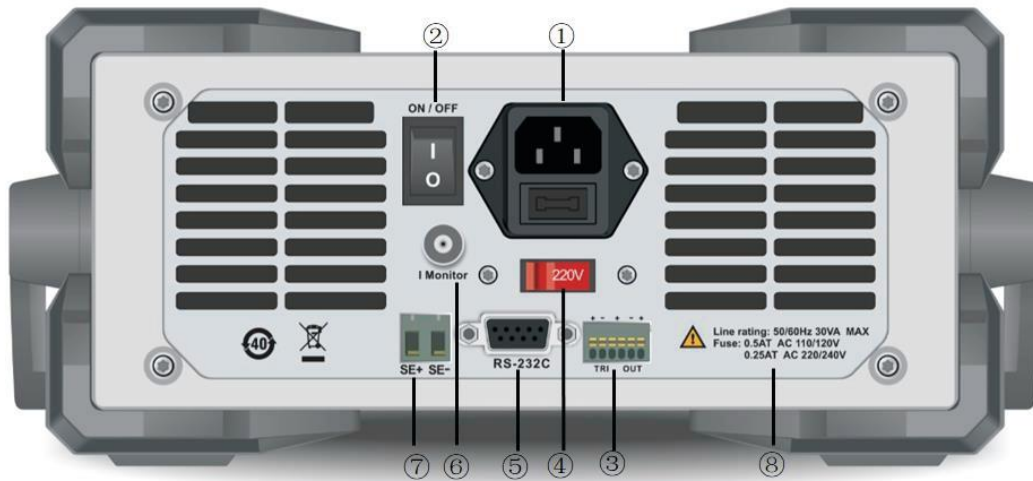

Figure 1-3-1 Rear Panel

Table 1-3-1 Introduction of Rear Panel

No.	Items	Description
①	AC 220/110V Socket	AC Power Input Socket (with Fuse)
②	ON/OFF Power Button	
③	Trigger Signal Terminal	Please refer to part 6.2 for details.
④	AC 220/110V Transfer Switch	Voltage Scale Switch of AC Power Source
⑤	RS232 Interface	External Communication Interface to Realize the Remote Control with the Load
⑥	Current Monitor Terminal	BNC Current Monitor Output Terminal
⑦	Sense (Remote Compensation) Terminal	Remote Voltage Sampling for Electrical Load
⑧	Specification of Fuse	240V/0.25A 120V/0.5A

2. Inspection and Installation

This chapter mainly covers the following:

- Packing List
- Requirements of Power Supply
- Operating Environment
- Cleaning
- Handle of Instrument

2.1 Packing List

Before using the instrument, please first:

1. Check whether the appearance of the product is damaged, scratched or has other defects;
2. Check whether the instrument accessories are missing according to the instrument packing list.

If it is damaged or the accessories are missing, please contact Uni-Trend Instrument Sales Department or the distributor immediately.

Items	Quantity	Remarks
Programmable DC Electronic Load	1pc	The model is subject to the actual order.
Power Cable	1pc	Standard Cable 250V/10A for China
Spare Fuse	2pcs	240V/0.25A, Suitable for 10V Voltage
User Manual	1pc	Users can download the manuals from UNI-T's official website.
Factory Quality Report	1pc	For UTL8512B+ and UTL8513
Certificate of Conformity and Warranty	1pc	

2.2 Requirements of Power Supply

UTL8500 series can only be used in following conditions:

Parameters	Requirements
Voltage	AC 220/110 ($\pm 10\%$)V
Frequency	50/60Hz
Power	50W
Fuse	AC220V Input Voltage: 240V/0.25A AC110V Input Voltage: 120V/0.5A

- Three-core power cable is provided; please make sure that the ground wire of three-phase socket is properly grounded before use.
- The instrument comes with 220V/110V power transfer switch. Before connecting to

the power supply, please check and ensure that the switch is in correct gear.

- 250V/0.25A (5x20mm) fuse is selected and installed for the instrument (220V) with a spare fuse in the fuse case.
- In addition, 2 spare fuses of 250V/0.5A are provided for input voltage of AC 110V.
- When replacing the fuse, please remove the external power cable first, then open the fuse slot under the power interface, take out the old fuse and replace it with a new one, and install the fuse slot back after completion.



Warning: please do not use the damaged power cable to avoid danger. Use the 250V/0.5A fuse when 110V AC power is input.

2.3 Operating Environment

UTL8500 series can only be used in common-temperature and low-condensing zone. The general environment requirements are listed as follows. During the on-load process, the speed of the cooling fan will adjust based on the change of the cooling fin's temperature.

Environment	Requirements
Operating Temperature	0°C~40°C
Operating Humidity	20%~80% (Non-Condensing)
Storage Temperature	-10°C~60°C
Altitude	≤2000m
Degree of Pollution	II

2.4 Cleaning

To avoid electric shock, please unplug the power cable before cleaning.

Clean the casing and the panel with a soft damp cloth, and make sure it is completely dry.



Warning: Do not use solvents like alcohol and gasoline.

Do not block the cooling outlet and clean the casing regularly (Unplug the power supply before cleaning).

2.5 Handle of Instrument

The handle of UTL8500 is adjustable. Please hold the handle by both sides, pull outward, and rotate it as needed, as shown in figures below.



Figure 2-5-1 Original Handle Position
Measurement

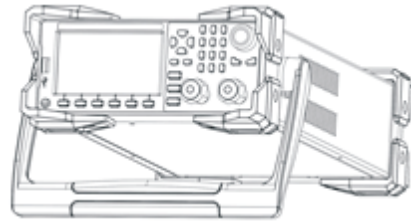

Figure 2-5-2 Handle Position during

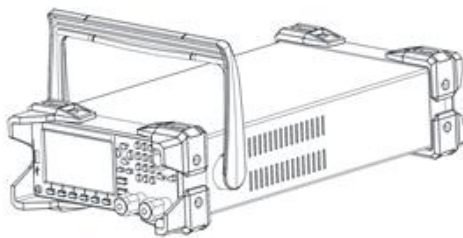

Figure 2-5-3 Removing Position



Figure 2-5-4 Lifting Position

3. Display Page of Measurement

This chapter mainly covers the following:

- Power on and Run
- Introduction of Screen Display

3.1 Power on and Run

The correct power-on and self-inspection processes of the electronic load are as follows:

1. To power the electronic load on, please connect the power cable correctly, adjust the ON/OFF switch on the rear panel to ON, and press the power button on the front panel. At this time, the power button is green. The electronic load screen will display the progress bar of current power-on and self-inspection, instrument information and other parameters.
2. After initialization, the current measuring status will be displayed on the screen. If start-up mode has been set, the instrument will enter the preset measurement mode directly. The completion of the correct power-on and self-check indicates that the electronic load meets the factory standards, and the user can use it normally.
Turn off the power button on the front panel and adjust the ON/OFF switch on the rear panel to OFF when the instrument is not in use.

⚠ Note: Please read through the content of safety information in preface carefully before using the load.

⚠ Warning: Please make sure that the power supply voltage is consistent with the supply voltage before turning on the power, otherwise the instrument will be burnt out. Please be sure to connect the main power plug to a power socket with ground protection. Do not use a wiring board without ground protection.

3.2 Introduction of Screen Display

After entering into the test mode, the LCD screen will be divided into several areas to display different information.





Figure 3-2 Interface of Measurement

3.2.1 Display of Measurement Interface

No.	Items	Description of Function
1	Mode	Current Measurement Mode or Status
2	Time	Current System Time
3	System Icon	Display the Status of U Disk, Remote Compensation, Short-Circuit Test and Trigger Function
4	Parameters	Real-Time Voltage, Current and Power
5	Set Value	Mode Setting Information, Voltage and Current Value
6	Other Parameters	Real-Time Running Time, Other Processes and Result Data
7	Mode Selection (Soft Keyboard)	Select the Work Mode and Operate the Corresponding Functions at the Bottom of the Screen

3.2.2 Introduction of Status Bar

Status Description	Display Status	Description of Function
Measurement Status	Status (Mode)	Current Measurement Status or Work Mode
Control Mode	Local/Remote	Current Operating Mode: Local/Remote
Screenshot Status	Waiting/OK/Fail	Saving the Picture/Saved Successful/Fail
Trigger Mode	Manual/External	Current Trigger Mode: Manual/External
Remote Compensation	Sense	Sense Displays on the Screen: Remote Compensation Has Been Turned on
USB Status		USB Storage Device Has Been Connected
System Time	0000.00.00 00:00	Current System Time: Year/Month/Date /Hour/Minute
Alarm		Audio Alarm Is ON
Trigger Ready	Trig	Wait for Trigger, the Icon will Disappear after Triggering
Start-Up Delay	Delay	Wait for Start-Up Delay, the Icon will Disappear when Reaching the Delay Time, and then Start up
Short-Circuit	Short	In Short-Circuit Test Mode
Pause Operation	Pause	In Pause Status

3.2.3 Running Indicator

UTL8500 series electronic load comes with running indicator on the ON button. In on-load mode, the indicator will light up, indicating that the load is in a loaded status. Pressing the ON button again can stop loading and the indicator will go out.

4. Measurement Setting

This chapter gives a detailed description of the main functions of the electronic load so that you can have a deeper understanding on the operation of the electronic load. It mainly contains the following contents:

- Constant State Test Modes (CC/CV/CR/CP)
- More Modes (Dynamic, List, Dual, OCP/OPP, etc.)
- Parameter Input and Loading Measurement
- Trigger Method
- Sense
- Screenshot

- Saving and Applying of Configuration

4.1 Constant State Test Modes

There are four types of constant state test mode: constant current (CC), constant voltage (CV), constant resistance (CR) and constant power (CP). In the initialization interface, the user can select [Mode] by pressing the soft key at the bottom of the screen, and then press [CC], [CV], [CR], [CP] to enter the corresponding mode.

The user can also press [More] to select more other modes, see Table 4-1.

Table 4-1 Introduction of Constant State Test Modes

Name	Description
CC Mode	The electronic load always consumes constant current regardless of the input voltage.
CV Mode	The electronic load changes current consumption to keep the input voltage as the set value.
CR Mode	The electronic load is equivalent to a resistance; it changes the input current as the voltage changes.
CP Mode	The electronic load always consumes constant power; it reduces the current when the voltage rises to remain constant power.
More Modes	There are many modes under this menu that can be selected by the cursor to meet diverse testing requirements.
V, A, W Parameters	Current Voltage, Current and Power Value
Status Bar	Current Mode, Time, Status and Other Parameters

In constant state test modes, set current/voltage/resistance/power and other parameters will be displayed on the right side of screen. Input on-load parameters that need to be set by numeric keyboard or knob. In on-load status, Time, Vpp, Ipp and some other parameters will be displayed at the bottom of the main screen.



4.1.1 Constant Current Test

In CC mode, the electronic load always consumes constant current regardless of the input voltage.



Figure 4-1-1-1 Setting Interface of CC Mode

Operation Steps:

1. In initial interface, select [Mode], and then press [CC] to enter the setting interface of <Constant Current CC>.
2. Move the cursor to current setting by pulse knob, and press the Enter button  to change the current value (the value changes from yellow to white) by keyboard or pulse knob. Press the Enter button  again to confirm. At this time, the set current value changes from white to yellow.
3. Other parameters can be modified in a similar way.
4. Press the ON button, the electronic load starts to load, and the indicator light below the button lights up. If you need to stop the load, press the ON button again, and the running indicator light goes out.

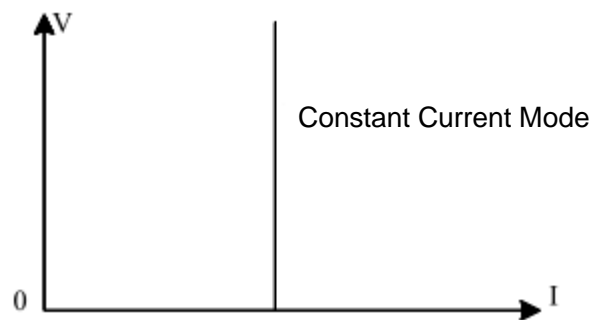

Figure 4-1-1-2 Relationship of Voltage and Current in CC Mode



4.1.2 Constant Voltage Test

In CV mode, the electronic load changes current consumption to keep the input voltage as set value.



Figure 4-1-2-1 Setting Interface of CV Mode

Operation Steps:

1. In initial interface, select [Mode], and then press [CV] to enter the setting interface of <Constant Voltage CV>.
2. Move the cursor to voltage setting by pulse knob, and press the Enter button  to change the voltage value (the value changes from yellow to white) by keyboard or pulse knob. Press the Enter button  again to confirm. At this time, the set voltage value changes from white to yellow.
3. Other parameters can be modified in a similar way.
4. Press the ON button, the electronic load starts to load, and the indicator light below the button lights up. If you need to stop the load, press the ON button again, and the running indicator light goes out.

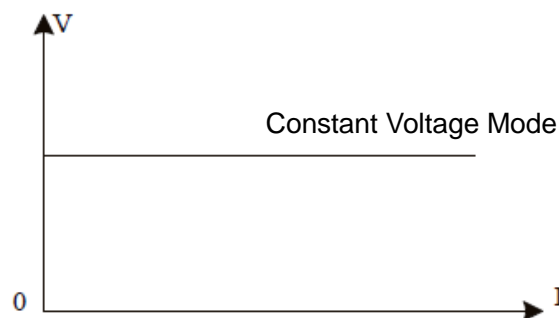

Figure 4-1-2-2 Relationship of Voltage and Current in CV Mode



4.1.3 Constant Resistance Test

In CR mode, the electronic load is equivalent to a resistance; it changes the input current as the voltage changes to maintain a constant resistance value.



Figure 4-1-3-1 Setting Interface of CR Mode

Operation Steps:

1. In initial interface, select [Mode], and then press [CR] to enter the setting interface of <Constant Resistance CR>.
2. Move the cursor to resistance setting by pulse knob, and press the Enter button  to change the resistance value (the value changes from yellow to white) by keyboard or pulse knob. Press the Enter button  again to confirm. At this time, the set resistance value changes from white to yellow.
3. Other parameters can be modified in a similar way.
4. Press the ON button, the electronic load starts to load, and the indicator light below the button lights up. If you need to stop the load, press the ON button again, and the running indicator light goes out.

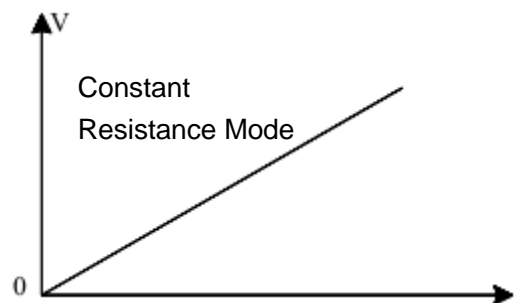

Figure 4-1-3-2 Relationship of Voltage and Current in CR Mode



4.1.4 Constant Power Test

In CP mode, the electronic load consumes constant power, and it will adjust the current according to the voltage change to maintain the set power value.



Figure 4-1-4-1 Setting Interface of CP Mode

Operation Steps:

1. In initial interface, select [Mode], and then press [CP] to enter the setting interface of <Constant Power CP>.
2. Move the cursor to power setting by pulse knob, and press the Enter button  to change the power value (the value changes from yellow to white) by keyboard or pulse knob. Press the Enter button  again to confirm. At this time, the set power value changes from white to yellow.
3. Other parameters can be modified in a similar way.
4. Press the ON button, the electronic load starts to load, and the indicator light below the button lights up. If you need to stop the load, press the ON button again, and the running indicator light goes out.

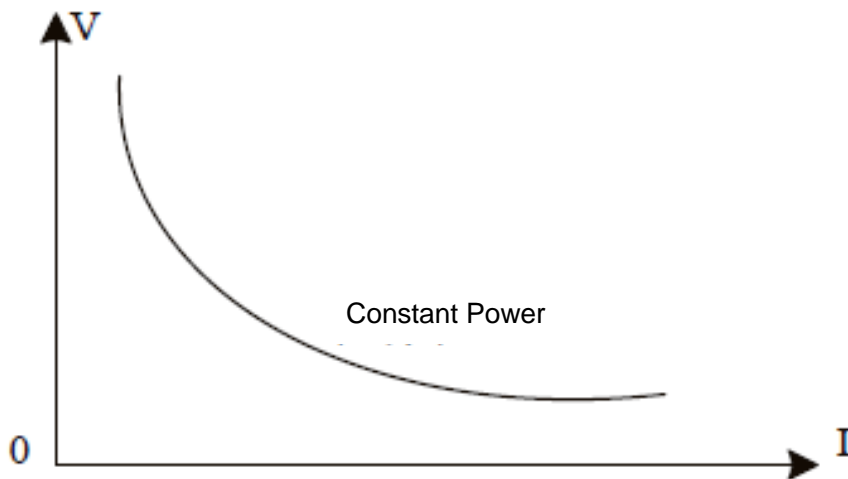

Figure 4-1-4-2 Relationship of Voltage and Current in CP Mode

4.2 More Modes

To meet various test requirements, UTL8500 series electronic load offers more test modes for choice, including Dynamic, List, Dual, OCP/OPP, CR-LED, Battery, Load Effect, OVP, Short Circuit, Time and more, as shown in Table 4-2.

Table 4-2 Introduction of More Modes

More Modes	Description
Dynamic	Two different voltage/current values are set. The load will switch between these two values when testing.
List	Up to 16-step different loading modes can be set. It can customize the stepping mode and the upper and lower limits of test and judgment, and have the function of saving and memorizing for each group of test modes.
Dual	Two constant test modes combine to form a dual on-load mode, including CR+CC, CV+CR and CV+CC.
OCP/OPP	Set the overload current/power/voltage value to identify whether the protection function of the tested object is normal. The load continuously increases the set load value during the test, and detects the value of the tested object when performing the protection function.
CR-LED	The test mode is for LED power supply, which can simulate the operating parameters (voltage/current and LED coefficient) to measure the performance of LED power supply.
Battery	Discharge the measured battery by CC/CR/CP mode. The test will end automatically when reaching the ending value. The battery capacity and the discharge graph will also be display.
Load Effect	Load according to three different loads of the set value to calculate ΔV and Reg (load regulation).
OVP	Set the overload current/power/voltage value to identify whether the protection function of the tested object is normal. The load continuously increases the set load value during the test, and detects the value of the tested object when performing the protection function.
Short Circuit	A short-circuited circuit will be simulated in input terminal to test if the protection function of measured object can work normally when its output terminal is short-circuited.
Time	For the start/drop time test of the switching power supply, set the start value and end value of the load. After the voltage of the tested object is stabilized, the time it takes for the process to rise to the stable voltage is detected.

4.2.1 Dynamic Mode

UTL8500 series electronic load has two dynamic loading modes: CC and CV. In the dynamic mode, the user can set two fixed-value parameters for corresponding constant state modes. Through the set operation mode, the load is switched back and forth between the two values. .



Figure 4-2-1-1 Interface of Dynamic Mode

Parameters of Dynamic Mode:

Dynamic Test	Description of parameters
Mode	Dynamic On-Load Mode: CC/CV
Operate Mode	Continues: The load will automatically and continuously switch between two set high/low values till the operation reaches the set repeating times, and then the test ends.
	Pulse: Lower parameters will be on-loaded at first, and then the load will switch to an upper value each time when it receives a trigger signal, and it will switch back to the lower value at the end of the set time. In pulse mode, lower timing is not necessary because the reverse action will be triggered only once when one trigger signal is received.
	Reverse: Each trigger will lead to the switching of current on-load status, and upper/lower timing is not necessary at this time.
Lower Value	Set the Lower Parameter Value
Lower Duration	Set the Lower On-Loading Time
Upper Value	Set the Upper Parameter Value
Upper Duration	Set the Upper On-Loading Time
Rise Slope	Set the Rise Slope
Fall Slope	Set the Fall Slope
Repeat	Set the Time of Repetition Cycles for an Operation

For example, in the dynamic CC mode in the figure below, the user sets the lower current value and the upper current value, and the load will continuously switch the current value

back and forth between the lower current and the upper current.

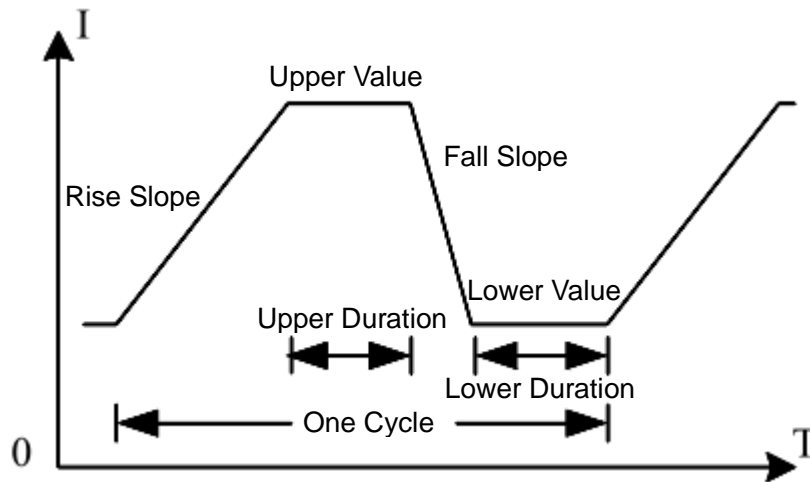



Figure 4-2-1-2 Dynamic Mode

Operation Steps:

1. In initial interface, select [Mode], and then press [Dynamic] to enter the setting interface of <Dynamic Mode>.
2. Move the cursor to the needed setting position by pulse knob, and press the Enter button  to change the parameter (the parameter changes from yellow to white) by keyboard or pulse knob. Press the Enter button  again to confirm. At this time, the set value changes from white to yellow.
3. Other parameters can be modified in a similar way.
4. Press the ON button, the electronic load starts to load, and the indicator light below the button lights up. If you need to stop the load, press the ON button again, and the running indicator light goes out.

4.2.2 List Mode

The list test function can switch between different modes according to the set parameters. For power products and charger devices, through multi-parameter mixed test, you can have a more comprehensive and in-depth understanding of the operating characteristics of the tested product in actual applications. The setting interface of list mode is shown in Figure 4-2-2 below.



Figure 4-2-2 Setting Interface of List Mode

4.2.2.1 Parameter Setting in List Mode



In the setting interface of list mode, the upper area is used to set the list group number and other parameters, as shown in the following table 4-2-2-1.

Table 4-2-2-1 Parameter Setting in List Mode

List Mode	Parameters	Description
Group	1~60	Set the group number of the list test parameters for easy calling.
Step	1~16	Set the step of the list test.
Repeat	0~99999	Set the number of repetitions of each measurement in the current mode.
Mode	Continus/Trig/Con+Err/Trig+Err	Set the switching method of each step and the stopping method.

<Group>

The Flash of the electronic load can save 60 groups of list modes. When setting the list parameters, please set a reasonable group number first.

1. Press function key to enter [List] mode, move the cursor to [Group] by rotating the knob, and press the Enter key  or the knob to change the group number value from yellow to white. Input the appropriate group number value through the numeric keyboard, and then press the Enter key  after setting the value. Used/unuse will be displayed behind the number, indicating whether the group number has been used.
2. If the set group number is already in use, used will be displayed, and the original group number parameters will be overwritten when the test file is saved.
3. If the group number has not been used, unuse will be displayed. It will create a new list file after the setting.

4. Select the storage location (Flash memory/U disk) before saving and press the save button to finish saving; record the set group number so that it can be called next time.

<Step>

After setting the group number, rotate the knob to move the cursor to [Step] to set the number of steps for the list test, up to 16 steps can be set.

<Repeat>

Rotate the knob to move the cursor to [Repeat] to set the number of repetitions for each measurement in the current mode. You can set up to 99999 times.

<Mode>

Rotate the knob to move the cursor to [Mode] to set the current running mode. Err means that the load will automatically stop loading if there is an abnormality during operation.

There are four options for setting the operating mode: Continues/Trig/Continues +Err/Trig+Err.

Continues: The load will continue to the next step after executing one step until the end of the operation.

Trig: The load will pause after executing a step, and wait for the trigger signal before continuing to the next step.

Err: The test will automatically stop when an overrun or other error occurs during the load operation.

4.2.2.2 Parameter Setting of Mode

After setting Group, Step and Mode parameters, the mode parameters for the set step will appear in the list below, as shown in Table 4-2-2-2. Modify the parameters according to the required mode.

Table 4-2-2-2 Parameter Setting of Mode

	List Value	Description
Mode	CC/CV/CR/CP/Open/Short	Load Operation Mode
Value	Set Constant Value	Open/Short Default Value Is 1
Time/ms	200~999999ms	Set the load execution time of each step between 200~999999ms.
Check	Off/Curr/Volt/Power	Select Check Item
Min	Minimum Value of the Check Item	Set Minimum Value of the Check Item
Max	Maximum Value of the Check Item	Set Maximum Value of the Check Item

Operation Steps:

1. Use the knob or arrow key to move the cursor to a specific line.
2. First select the modes of each step, and press  or the knob to change the current mode. Stop when the desired mode appears, and switch the cursor to set the next parameter by rotating the knob or pressing direction keys
3. The constant value setting only needs to input the number directly after the cursor is selected, and then move the cursor to the next parameter that needs to be changed by rotating the knob or pressing direction keys after completion.
4. Follow step 3 to set Time, Check, Min and Max. (Note: When the parameter you input is not within the correct upper and lower limits, the cursor will not be able to move. You need to use the delete button to clear the parameter or change it to the correct value.)
5. Other parameters can be modified in a similar way.
6. After setting, press the function key [Test] to enter the <List Mode> test page, as shown in Figure 4-2-2-2.

**Figure 4-2-2-2 Test Page of List Mode**

7. Press the ON button, the electronic load starts to load, and the indicator light below the button lights up. If you want to suspend the test, you can press the [Pause] button. If you need to stop the load, press the ON button again, and the running indicator light goes out.
8. After the test is completed, the user can press [Result] to view the test results. If the test result is within the upper and lower limits set by the user, Pass will be displayed, otherwise Fail will be displayed instead. The user can check whether each item is passed and save the test record by taking a screenshot.

⚠ Note: The input data should not exceed the upper and lower limits of the current parameter. When the data exceeds the parameter limits, they will not be saved, and the cursor will stay in the grid. At this time, you need to clear or re-enter the appropriate range of parameters. When you need to change the numbers in the list, click Delete to clear the data in the table. After completing each parameter setting in the list, click the Save button for easy calling next time.

4.2.3 Dual Mode

In order to meet more test requirements, the electronic load provides three dual modes: CR+CC, CV+CR and CV+CC. The user can choose the appropriate mode according to the actual situation. CR+CC can be used for power-on test, CV+CR can be used for setting the Von point, and CV+CC can be used for battery discharge test.



Figure 4-2-3-1 Interface of Dual Mode

Parameter Setting in Dual Mode:

Parameter	Description
Mode	CR+CC/CV+CR/CV+CC
Start Value	Set the Start Value of the Dual Mode
Swap Value	Set the Swap Value of the Dual Mode

To use the dual mode, first select the needed mode, and then set the fixed values of the two corresponding modes. When the load starts to load, first start the load according to the fixed value of the first mode, and when the external input changes so that the parameter reaches the set switching value, the load switches to the second load mode.

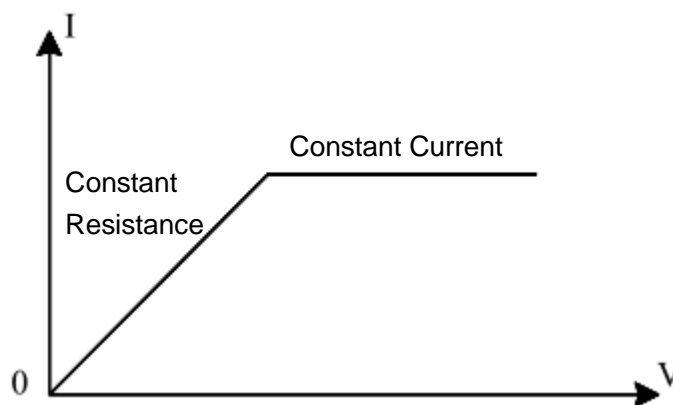



Figure 4-2-3-2 Dual Mode

Description of Dual Mode:

When using dual mode, it is necessary to set reasonable starting and switching parameters to ensure that the set switching value can be reached during the test.

Operation Steps:

1. In initial interface, select [Mode], [More], and then press [Dual] to enter the setting interface.
2. Move the cursor to the needed setting position by pulse knob, and press the Enter button  to change the parameter (the parameter changes from yellow to white) by keyboard or pulse knob. Press the Enter button  again to confirm. At this time, the set value changes from white to yellow.
3. Other parameters can be modified in a similar way.
4. Press the ON button, the electronic load starts to load, and the indicator light below the button lights up. If you need to stop the load, press the ON button again, and the running indicator light goes out.

4.2.4 OCP/OPP Mode

This mode is used to detect the protection function of the tested power supply under overload conditions. UTL8500 series electronic load provides two test modes: OCP/OPP.



Figure 4-2-4-1 Interface of OCP/OPP Mode

Parameter Setting in OCP/OPP Mode:

Parameter	Description
Mode	OCP/OPP
Start Value	Set the Initial Value of the Test Mode
Step Value	Set the Step Value in Every Step Time
End Value	Set the Maximum End Value of the Test Mode
Step Time	Set the Time Interval of Every Step
End Voltage	Set the Minimum End Voltage

In OCP/OPP mode, the user continuously increases the load value by setting the start value, step value and step time until the end value is reached or the protection point of the measured object is detected, and the test stops.

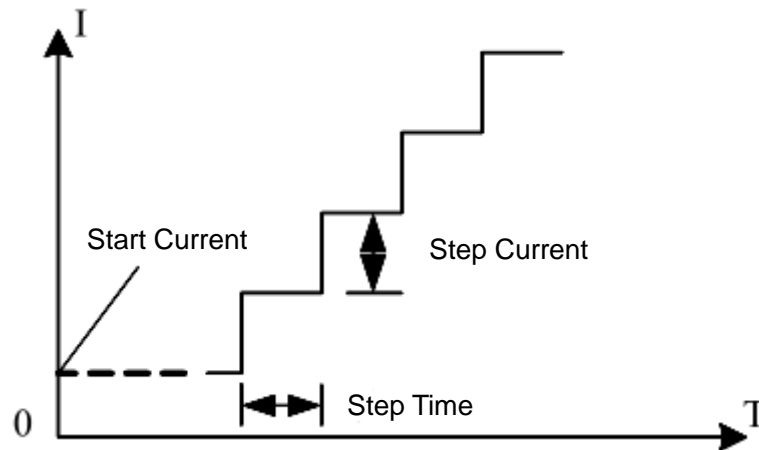

Figure 4-2-4-2 OCP/OPP Mode



Description of OCP/OPP Mode:

Since OCP/OPP mode will continuously increase the output power of the tested object, please input reasonable load parameters during the test to avoid damage to the tested object. After the test is over, the electronic load will display the time of this test and the current/power value of the peak point.

Test Results of OCP/OPP Mode:

When the protection value of the test result is less than the end value, it is Pass; when it exceeds the end value, it is Fail. On the software framework, there are only two pop-ups for passing and failing the test, and no judgment pop-ups. Therefore, when the selected mode does not have a judgment item, that is, the pass pop-up pops up, but it is not used as a judgment, but only as a test end prompt.

Operation Steps:

1. In initial interface, select [Mode], [More], and then press [OCP/OPP] to enter the setting interface.
2. Move the cursor to the needed setting position by pulse knob, and press the Enter button  to change the parameter (the parameter changes from yellow to white) by keyboard or pulse knob. Press the Enter button  again to confirm. At this time, the set value changes from white to yellow.
3. Other parameters can be modified in a similar way.
4. Press the ON button, the electronic load starts to load, and the indicator light below the button lights up. If you need to stop the load, press the ON button again, and the running indicator light goes out.

4.2.5 CR-LED Mode

The CR-LED mode is a test mode for the LED power supply. By simulating the conduction voltage and working current of the light-emitting diode, the working principle of the LED is truly simulated, so that the test voltage and current are between a normal and stable value,

avoiding oscillations and other unstable conditions produced by constant resistor discharge, so as to better check the actual loading of the LED drive power supply.





Figure 4-2-5-1 Interface of CR-LED Mode

Parameter Setting in CR-LED Mode:

Parameter	Description
LED-Vo	The Operating Voltage at the Rated Current of the LED Power Supply
LED-Io	Rated Output Current of LED Power Supply
Rd Coeff	Rd Coefficient of the LED (Setting Range: 0.1~0.4)

Operation Steps:

1. In initial interface, select [Mode], [More], and then press [CR-LED] to enter the setting interface.
2. Move the cursor to the needed setting position by pulse knob, and press the Enter button  to change the parameter (the parameter changes from yellow to white) by keyboard or pulse knob. Press the Enter button  again to confirm. At this time, the set value changes from white to yellow.
3. Other parameters can be modified in a similar way.
4. Press the ON button, the electronic load starts to load, and the indicator light below the button lights up. If you need to stop the load, press the ON button again, and the running indicator light goes out.

4.2.6 Battery Mode

Battery mode is used to detect the battery capacity. Battery capacity is an important indicator of the battery which reflects battery life and reliability. The voltage will decrease as the discharge time increases when testing the battery capacity, so the stop voltage should be set. When the stop voltage is reached, the test ends. The user can click and view the curve of battery discharge.



Figure 4-2-6-1 Interface of Battery Mode

Parameter Setting in Battery Mode:

Parameter	Description
Mode	Battery Discharge Mode: CC/CR/CP
Load Value	Set Loading Value
Stop Voltage	Set the Lower Limit Voltage of Stopping Discharge

In the battery mode, select any discharge mode as needed, and set the load parameters and stop voltage of this mode. When the battery is discharged to the stop voltage, the electronic load automatically stops loading.

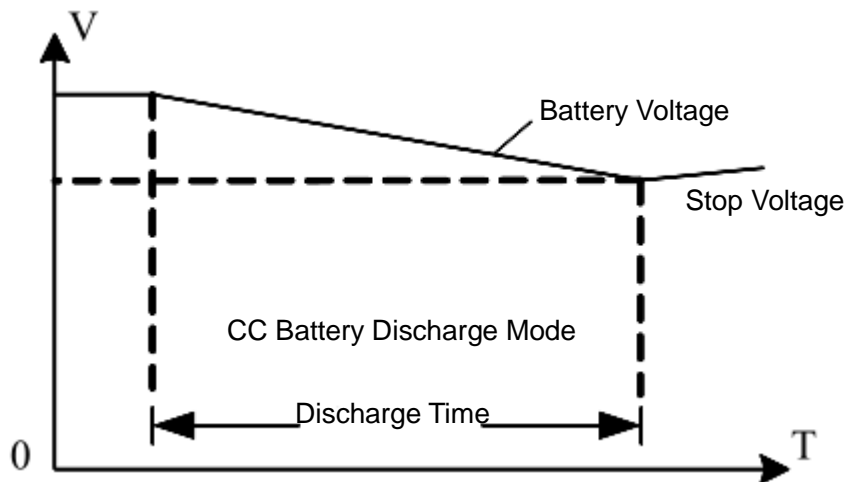



Figure 4-2-6-2 Battery Mode

Description of Battery Mode:

In the actual test process, you can check the battery voltage, discharge current and discharged capacity at any time. After the test, you can choose to display the discharge curve for reference.

Operation Steps:

1. In initial interface, select [Mode], [More], and then press [Battery] to enter the setting interface.

2. Move the cursor to the needed setting position by pulse knob, and press the Enter button  to change the parameter (the parameter changes from yellow to white) by keyboard or pulse knob. Press the Enter button  again to confirm. At this time, the set value changes from white to yellow.
3. Other parameters can be modified in a similar way.
4. Press the ON button, the electronic load starts to load, and the indicator light below the button lights up. If you need to stop the load, press the ON button again, and the running indicator light goes out.
5. Press [Curve] to view the curve of battery discharge when the test is over. (Note: User can't view the curve during the test.)

4.2.7 Load Effect

The load effect mode can carry out loading under 3 different load conditions (10%, 50%, and 100%), and continue the load for a preset time (5s), and then record the voltage under different loads. Finally, calculate the load regulation rate Regulation, ΔV and other values according to the formula.





Figure 4-2-7-1 Interface of Load Effect Mode

Parameter Setting in Load Effect Mode:

Parameter	Description
Rate Voltage	Set the Rated Voltage of the Load
Rate Current	Set the Rated Current of the Load

Formula: $V_{max}=V_{dc}@I_{min}$, $V_{min}=V_{dc}@I_{max}$, $\Delta V=V_{max}-V_{min}$, $Regulation=\Delta V/V_{set}$
 Before the load effect test, input the rated voltage and rated current, and then press ON to enter the test. At this time, the load will be loaded according to 3 different loads in turn, and the values of ΔV and Reg will be detected. During the test, the ON button can be used to control the load switch.

Operation Steps:

1. In initial interface, select [Mode], [More], [More], and then press [Load Effect] to enter the setting interface.
2. Move the cursor to the needed setting position by pulse knob, and press the Enter button  to change the parameter (the parameter changes from yellow to white) by keyboard or pulse knob. Press the Enter button  again to confirm. At this time, the set value changes from white to yellow.
3. Other parameters can be modified in a similar way.
4. Press the ON button, the electronic load starts to load, and the indicator light below the button lights up. If you need to stop the load, press the ON button again, and the running indicator light goes out.

4.2.8 OVP Mode

The OVP (overvoltage protection) test function can capture the peak point of the input voltage and the entire fall process after protection. When the voltage drops to the set trigger voltage, the load will record the time from the peak point to the trigger point. This recorded time is the over-voltage protection time of the tested power supply.





Figure 4-2-8-1 Interface of OVP Mode

Parameter Setting in OVP Mode:

Parameter	Description
Trigger Voltage	Set the Voltage of the Trigger Point

If you want to perform OVP test, you can press More in the menu to select the OVP test mode, set the voltage of the trigger point, and then press the ON button to start loading. The overvoltage protection function of the power supply is triggered by increasing the output voltage of the power supply under test. After the load captures the peak and falling edge of the voltage, it starts timing and triggers at the set trigger voltage. The load records the voltage at the peak point, and calculates the time from the peak point to the trigger point. After the measurement, the load will display the tested Vmax (peak voltage) and Tgap (protection time). The measurement accuracy of the protection time is 1mS.

Operation Steps:

1. In initial interface, select [Mode], [More], [More], and then press [OVP] to enter the setting interface.
2. Move the cursor to the needed setting position by pulse knob, and press the Enter button  to change the parameter (the parameter changes from yellow to white) by keyboard or pulse knob. Press the Enter button  again to confirm. At this time, the set value changes from white to yellow.
3. Other parameters can be modified in a similar way.
4. Press the ON button, the electronic load starts to load, and the indicator light below the button lights up. If you need to stop the load, press the ON button again, and the running indicator light goes out.

4.2.9 Short-Circuit Mode

The electronic load can simulate a short circuit at the input terminal to test whether the protection function of the measured object can operate normally when the output terminal of is short-circuited.



Figure 4-2-9-1 Interface of Short-Circuit Mode

Parameter Setting in Short-Circuit Mode:



Parameter	Description
Current	Load Current Value in Normal Status
V on	Set the Starting Voltage
V Limit	Constant Value of Overvoltage Protection
C Limit	Constant Value of Overcurrent Protection

When the set short-circuit time is reached (refer to Chapter 5.2 for the short-circuit time setting), the electronic load returns to the original working state.

The actual current value consumed by the electronic load in the short-circuit mode depends on the current load working mode and current range. During the short circuit test, the electronic load is loaded with the full range. When one of the current/power reaches the upper limit first, the load is loaded according to the full range of this upper limit.

 Note: The short-circuit mode is effective only in CC, CV, CR and CP mode.

Operation Steps:

1. In initial interface, select [Mode], [More], [More], and then press [Short Cir] to enter the setting interface.
2. Move the cursor to the needed setting position by pulse knob, and press the Enter button  to change the parameter (the parameter changes from yellow to white) by keyboard or pulse knob. Press the Enter button  again to confirm. At this time, the set value changes from white to yellow.
3. Other parameters can be modified in a similar way.
4. Press the ON button, the electronic load starts to load, and the indicator light below the button lights up. If you need to stop the load, press the ON button again, and the running indicator light goes out.
5. Press the function key [Short Cir] to enter the short circuit mode. When the short circuit mode takes effect, the status bar will display the word Short. When the short-circuit mode ends, the word Short disappears.
6. Note: Step 4 and Step 5 can be interchanged. If step 4 is before, after pressing the ON button to start, first load according to the current setting value, and then enter the short circuit mode; if step 5 is before, press the ON button to start and enter the short circuit mode directly.

4.2.10 Time Mode

The time mode is to detect the time for the power supply under test to rise/fall from one voltage point to another voltage point under preset conditions. After the test is completed, the load will display the interval between the two time points, and the accuracy of the time measurement is 1ms.



Figure 4-2-10-1 Interface of Time Mode

Parameter Setting in Time Mode:



Parameter	Description
Mode	Set the Load Mode (CC/CV/CR/CP/Open)

Value	Set the Load Value of the Current Mode
Start Trigger	Set the Start Condition (Voltage/Current/External)
End Trigger	Set the End Condition (Voltage/Current/External)
Start Edge	Start Trigger Mode: Rise/Fall
End Edge	End Trigger Mode: Rise/Fall
Start Value	Set the Start Trigger Value
End Value	Set the End Trigger Value

First set the loading mode and loading value, then set the start and end conditions and trigger mode, and then set the start and end values. After the time test starts, the electronic load is loaded according to the set mode and value. When the load captures that the initial trigger condition is met, it starts timing; after running to the end trigger condition, the load ends timing and the time measured is displayed on the screen.

The time mode simulates the test of the rising voltage speed of the oscilloscope, and can be widely used in the field of startup time test of switch and power supply.

Operation Steps:

1. In initial interface, select [Mode], [More], [More], and then press [Time] to enter the setting interface.
2. Move the cursor to the needed setting position by pulse knob, and press the Enter button  to change the parameter (the parameter changes from yellow to white) by keyboard or pulse knob. Press the Enter button  again to confirm. At this time, the set value changes from white to yellow.
3. Other parameters can be modified in a similar way.
4. Press the ON button, the electronic load starts to load, and the indicator light below the button lights up. If you need to stop the load, press the ON button again, and the running indicator light goes out.

4.3 Parameter Input and Loading Measurement

There are two ways to input parameter. You can rotate knob or press the numeric key to enter and change parameter. When running with load, press the ON key on the front panel to control the input switch of the electronic load. See the following chapters for details.

4.3.1 Numeric Key

Move the cursor to current value setting by pulse knob, press the numeric key to enter parameter and then press the Enter button  to confirm. Please enter value within valid range. If the value is out of valid range, the setting cannot be saved and the cursor will jump to the first number.

4.3.2 Pulse Knob

Before inputting parameters, there will be a default value at the cursor position. You can use the knob to adjust the number at the cursor position, and then move the cursor until the number on each digit is set to the needed value. You should press Enter button  again to complete the parameter setting.

 Note: When the set parameters reach the upper and lower limits, the number at the corresponding position cannot continue to scroll.

4.3.3 Ripple Measurement

UTL8500 series electronic load supports voltage ripple (V_{pp}) and current ripple (I_{pp}) measurement and real-time display. In the test interface, you can see these parameters: $V_{pp}/V_{p+}/V_{p-}$, $I_{pp}/I_{p+}/I_{p-}$, and you can alternately view the required parameters by using the "Page" soft key at the bottom right.

Different from the measurement method of the traditional oscilloscope, the ripple measurement of the electronic load has good flatness and accuracy in a certain measurement range and bandwidth. At the same time, the ripple generally includes two types with different frequency, power frequency ripple and switching ripple. The ripple test result is affected by the combination and superposition of these two ripples.

4.3.4 Input Control

After the electronic load is powered on, it is in an unloaded state. You can control the input switch of the load by pressing the ON button on the front panel.

If the indicator light of the ON button is on, it means that the input is turned on, and the real-time voltage, current and power in the current loop will be displayed on the LCD screen. If the indicator light is off, it means that the input is closed, and the current voltage across the load will be displayed on the LCD screen.

4.4 Trigger Method

When using Dynamic, List or Time mode, the trigger function of the electronic load may be used. The user can choose manual trigger (Manual) or external trigger (External).

Operation Steps:

1. In the Dynamic, List or Time mode page, you can quickly modify the trigger mode by selecting [Trigger] through the function keys at the bottom of the screen, and the words "Manual" or "External" will appear at the top of the screen;
2. When the external trigger is selected, the trigger signal is connected through the trigger terminal on the rear panel to control every action of the electronic load;
3. When the manual trigger is selected, use the [Trig] button on the panel to trigger. Each time you press [Trig] button, a corresponding trigger operation will be executed.

4.5 Sense

When the electronic load is loaded with a relatively large current, it will produce a large voltage drop on the connection lead between the load and the measured object. In order to ensure the measurement accuracy, the electronic load has a pair of remote measurement terminals on the rear panel. Through the terminals, you can have a sampling measurement on the precise voltage at the output terminal of the instrument under test.

Operation Steps:

1. On each test mode page, select [Sense] via the function key at the bottom of the screen. When the "Sense" icon appears at the top of the screen, it means that the remote sense function has been turned on. At this time, the remote sampling voltage measured on the back terminal is the actual voltage detected.
2. Press the function key [Sense] again to turn off the remote sense function. At this time, the voltage measured on the main terminal on the front panel is the actual voltage detected.

 Note: When wiring, be sure to connect the object under test and the positive and negative poles of the terminals correctly; the Sense switch cannot be switched in the running state.

4.6 Screenshot

After inserting the U disk in the front panel, the electronic load will automatically recognize it and display the USB symbol  on the upper right corner of the screen, indicating that the U disk has been connected to the device.

When you need to use the screenshot function, press the [Print Sc] button, and the load will save the current screen image to the U disk. During the saving process, "Wait..." will be displayed at the top of the screen to indicate that the image is being saved. Displaying "Ok" means that the picture has been saved. If the picture is not saved successfully, the screen will display "Fail". Screenshots can only be saved to a U disk because they take up a lot of space. After the screenshots are taken, the images stored in the U disk can be viewed on the computer.

4.7 Saving and Applying of Configuration

After detecting the connection of a U disk, the electronic load will automatically create a folder named "UTL8500X" in the root directory. This directory is used to save the

screenshots and list test files. Press the "System" button on the front panel to enter the SYSTEM CONFIG interface, and then press the [File] key at the bottom of the screen to enter the file operation interface to delete, copy, and apply files.

The screenshot BMP file name saved by the electronic load is 12 digits composed of date and time. The first six digits are the year, month and day, and the last six digits are the hour, minute and second. The format of list file name is in LIST000.txt, and the last two numbers indicate the group number of the test mode.

UTL8500 series electronic load can save commonly used test files in U disk or internal Flash. Flash can save 60 groups of test files.

▲ Note: The U disk used to save files must use the FAT32 file system. The allocation unit size cannot be greater than 4096 bytes, and the maximum capacity is 32G. Please format it in advance when using it, otherwise it may cause file storage failure. It is recommended to use a branded U disk.

5. System Configuration Page

This chapter mainly covers the following:

- Packing List
- Requirements of Power Supply
- Operating Environment
- Cleaning
- Handle of Instrument

In non-running state, pressing the [System] button on the panel can enter the system configuration page. The system configuration page includes <System Config>, <Para Set>, <File>, <Info> and local/remote switching. Select the corresponding function keys at the bottom of the panel to enter the corresponding setting page.

5.1 System Configuration

Press the [System] button on the panel to enter the <SYSTEM CONFIG> page, as shown in Figure 5-1. Language, time, communication, etc. can be set on this page. For details, please see Table 5-1.



Figure 5-1 System Configuration Page

Table 5-1 Description of Parameters on System Configuration Page

System Parameter	Setting Content	Description
Language	[CHN]/ENGLISH	Set System Language
Key Sound	On/Off	Whether to Enable Key Sound
Date	Year/Month/Day	Set System Date
Warn Sound	On/Off	Whether to Enable Warn Sound
Time	Hour/Minute/Second	Set System Time
DIM Display	1~5 Levels of Brightness	Adjust the Screen Brightness, 5 Levels
Initial Mode	Default/Last	Default: Boot into the Constant Current (CC) Interface Last: Boot into the Last Test Mode
Knob Active	On/Off	If it is On, the parameter will change immediately after rotating the knob.
Address	001~032	Set the Current Communication Address
Baud Rate	9600/19200/38400/57600/115200	Set the Baud Rate of RS232 Communication Interface
SCPI Set	SCPI1/Own	SCPI1: General SCPI Protocol; Own: For Internal Debugging
Restore Factory Setting		Choose to Restore Factory Settings: The Device will Delete the Current Setting Parameters and Restore

		to the State of Factory Settings
--	--	----------------------------------

5.1.1 Language

The electronic load provides two system languages (CHN/ENGLISH), which can be changed in the system parameter settings. Select Language, turn the knob or change the up and down direction keys to adjust to the language you need, and then press  to complete the setting.

5.1.2 Key Sound

The key sound is used to set whether to sound when you operate the keyboard or the knob. If it is on, the buzzer will emit a short sound when you press any key or rotate the knob. If it is off, no sound will be emitted at any time when you operate the button or the knob. The factory default key sound is on.

5.1.3 Date

It is used to set the current date of the system. The user first selects the setting option, moves the cursor to the position to be modified by the left and right direction keys, and then rotates the knob or directly enters the number with the keyboard to adjust the content to be modified. Lastly, press  to complete the modification.



5.1.4 Warn Sound

The UTL8500 series electronic load has warn sound function. When the load ends or encounters an abnormal problem during the test, the electronic load will emit a warn sound through the built-in buzzer. When the test is successful, the load will emit two short beeps. When the test fails or encounters other abnormalities, the load will emit two long beeps. The warn sound is on by default. If you need to change it, select this option on the system configuration page and adjust it.

5.1.5 Time

Time setting is the same as the date setting. It is used to set the current system time.

5.1.6 DIM Display

In order to adapt to the operating environment of different brightness, the electronic load has a screen brightness adjustment function, which can be changed in the system parameters. Select the option DIM Display, press , rotate the knob or use the direction keys to adjust to the required value, and then press  to complete the setting.

5.1.7 Initial Mode

When the initial mode is selected as "Last", the state of the load each time it is powered

on is the test mode used before the last shutdown. If "Default" is selected, the electronic load will enter a constant current (CC) test mode after each power-on.

5.1.8 Knob Active

This option is used to make the current adjustment by the knob take effect immediately. It is on by default, that is, every time you rotate the knob to change the parameter in CC, CV, CR, CP mode, it will take effect immediately. After it is turned off, you need to press  after changing the parameter every time by the knob.

5.1.9 Communication Setting

The communication setting is mainly used to set the communication mode used between the electronic load and the host computer. The electronic load communicates with the upper computer through RS232. The user can purchase the required connection lead to achieve remote control with the electronic load. Before connecting to the host computer, please make sure to purchase the designated connection lead and select the corresponding communication parameters in the communication setting.

Communication Setting	Setting Content	Description
Communication Mode	RS232	The general model only supports RS232 and supports expansion.
Baud Rate	9600/19200/38400/57600/115200	Set the communication baud rate of RS232 communication interface.
Address	001~032	Set the current communication address of the load.
SCPI Setting	SCPI1/Own	SCPI1: general SCPI protocol; own: for internal debugging.

5.1.10 Restore Factory Setting

The option can restore the set value in the electronic load to the factory default value. If you choose to restore factory settings, a dialog box will pop up on the screen to confirm whether to restore. Move the cursor to "Yes" and press  to confirm. The system will restore the system configurations and parameter settings to the factory settings status.



Parameter Setting (UTL8511)



System Configuration (UTL8511)

5.2 Parameter Setting

You can enter the system configuration interface by pressing the [System] key, and select [Para Set] at the bottom of the screen can enter the <PARAMETER SETTING> page, as shown in Figure 5-2. The parameter setting is used to set the operating parameters and protection parameters of the system.



Figure 5-2 Parameter Setting Page

Table 5-2 Description of Parameter Setting (UTL8511)

Parameter Setting	Setting Range	Description
Run Time	0~99999s	Set the Time for Scheduled Uninstall

Delay On	0~9999s	Set the Start Time of Delay
Short Time	0.1~99999ms	Set the Time for Short Circuit Test
V Limit	0~150V	Set the Voltage Value of Over-Voltage Protection
I Limit	0~30A	Set the Current Value of Over-Current Protection
P Limit	0~150W	Set the Power Value of Over-Power Protection
V on	0~150V	Set the Load Voltage at the Beginning of Each Run
V off	0~150V	Set the Low Voltage to Automatically End Loading
V Trigger	0~150V	Set the Self-Start Voltage of the List Mode
OVP	ON/OFF	Set whether to Enable the Overvoltage Protection Function
Digit Filt	LV1/LV2/LV3/LV4	Set the Level of Digital Filter
Trig Select	Trig/On/Off	Set the Role of External Trigger Signal Input (Function Multiplexing)

5.2.1 Run Time

If you set the single load time of the electronic load, no matter what mode it is running in, the load will automatically stop loading after the set timing is reached. When this function is not needed, set the parameter to 0.

5.2.2 Delay On

If you set the delay before the electronic load is loaded each time, no matter what mode it is running, when the ON button is pressed, the electronic load will wait for the set delay time and then start loading.

5.2.3 V Trigger

V Trigger is the voltage value of automatically-started loading after setting the list mode. After setting the self-start voltage, enter the list mode without pressing the ON key to enable the load. When the input voltage of the electronic load exceeds the set self-start voltage, the list mode will automatically start.

This operation is suitable for testing environments that do not need manual operations such as automated production lines. The default self-start voltage of the device is 0, which means it is not enabled. When you need to use, first set the required V Trigger in the parameter setting, then you only need to set the parameters in the list mode according to the normal operation, and then you can enter the test. When the electronic load detects that the external input voltage exceeds the set value, it will run automatically and check out the result.

5.2.4 OVP

Overvoltage protection is used to protect the equipment from damage as much as possible under overvoltage conditions. After being turned on, when the external input voltage exceeds the voltage range that the electronic load can withstand, the load will short-circuit the external power supply to protect the load itself from damage. This function is mainly suitable for LED power supply testing and other fields.

5.2.5 Digit Filt

Adjusting the parameter of digital filter can improve the stability of the displayed value. The electronic load has a total of 4 digital filter parameters that can be selected. The larger the filter parameter, the better the effect and the more stable the displayed value. The load defaults to LV4 digital filter and you can set it according to actual needs.

5.3 File

Press the [System] key to enter the SYSTEM CONFIG interface, and select [File] at the bottom of the screen to enter the <File> page, as shown in Figure 5-3.

File operations are mainly for applying, copying and deleting list test files and screenshots;

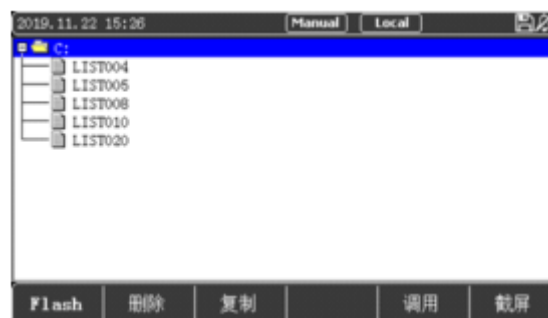

Figure 5-3 File Page

Save: The device has two storage methods (U disk/internal Flash). You can view the files stored in the two paths. The screenshots can only be saved to the U disk and cannot be viewed on the electronic load.

Delete: Users can delete any files stored in the two paths.

Copy and apply: The user can copy and apply the list test files of the two storage spaces, and at the same time, the files can also be deleted.

File Function:

Name	Description
U Disk/Flash	Select U Disk or Flash as the Currently Displayed Storage Space
Delete	Delete the Currently Highlighted File
Copy	Copy the Selected File to Another Storage Space
Apply	Apply the Selected Test File (Apply the List Test File)
Print Sc	Save the Current Screen Image to U disk

 Note: On File page, only the list test files can be copied and applied mutually, and the screenshots in the U disk cannot do that.

5.4 Instrument Info

Press the [System] key to enter SYSTEM CONFIG interface, and select [Info] function key at the bottom of the screen to enter the <Instrument Info> page. The Instrument Info page can view the basic information of the instrument, including the model, version number and serial number of the electronic load.

5.5 Local/Remote

The electronic load has two operating modes: local and remote.

Local: use the buttons on the electronic load to operate.

Remote: The electronic load is connected to the PC through RS232 and other communication cables, and commands are sent on the PC to perform related operations on the load through the upper computer software.

When the electronic load is in Remote mode, except for the function key [Local], other keys on the panel will not work. When you do not need to use the Remote function, you can switch to Local mode by pressing the [Local] button.

The status bar at the top of the screen will display Local/Remote, indicating the current control status of the load. The user can judge the control status of the load according to the display on the screen.

Operation Steps:

1. Press the [System] key to enter SYSTEM CONFIG interface, and select [Local] at the bottom of the screen to switch the current Local mode to Remote mode. The "Remote" icon will be displayed at the top of the screen, indicating that the electronic load is in

Remote mode.

2. If you want to return to Local mode, just press the [Local] function key. At this time, the word "Local" will be displayed at the top of the screen, indicating that the electronic load is in Local mode.
3. Repeat step 1 to enter Remote mode again.

6. Communication Interface and Terminal

This chapter mainly covers the following:

- RS-232C Communication
- Introduction of Terminal

6.1 RS-232C

UTL8500 series electronic load is equipped with RS-232C communication interface according to standards. You can use the corresponding communication lead for remote operation if you need. There is a DB9 female interface at the end of the electronic load, which can be connected to the computer COM port by using a standard RS-232C cable.

⚠ Note: In actual use, the electronic load only uses three pins (2, 3 and 5) to communicate with the device. It is recommended to turn off the power of the instrument when plugging or unplugging the connector to avoid electrical shock.

Table 6-1 Definition of COM Interface (RS-232C) Pins

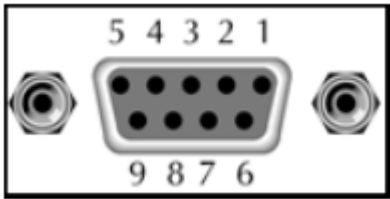
Pin Number	Symbol	Description	
1	---	/	
2	TXD	Transmit Data	
3	RXD	Receive Data	
4	---	/	
5	GND	Ground	
6	---	/	
7	---	/	
8	---	/	
9	—	/	

The communication setting is mainly used to set the communication mode between the electronic load and the host computer. The electronic load communicates with the upper computer through RS-232C. The user can purchase the needed connecting lead to achieve remote control with the electronic load. Before connecting to the host computer,

please make sure to purchase the designated connection lead and select the corresponding communication parameters in the communication settings.

Communication Setting	Setting Content	Description
Communication Mode	RS-232C	The general model only supports RS-232C and supports expansion.
Baud Rate	9600/19200/38400/57600/115200	Set the communication baud rate of RS-232C communication interface.
Address	001~032	Set the current communication address of the load.
SCPI Setting	SCPI1/Own	SCPI1: general SCPI protocol; own: for internal debugging.

6.2 Current Monitor (I Monitor)

The current monitor output terminal uses 0~10V analog output signal to represent the zero to full rated input current of the channel to which the terminal belongs. An external voltmeter or oscilloscope can be connected to display the change of input current.

6.3 Remote Compensation Terminal

When the load consumes a large current, a voltage drop will be generated on the connection lead between the instrument under test and the load terminal. In order to ensure the measurement accuracy, the UTL8500 series electronic load provides a remote measurement terminal on the rear panel. The user can use this terminal to measure the output terminal voltage of the instrument under test.

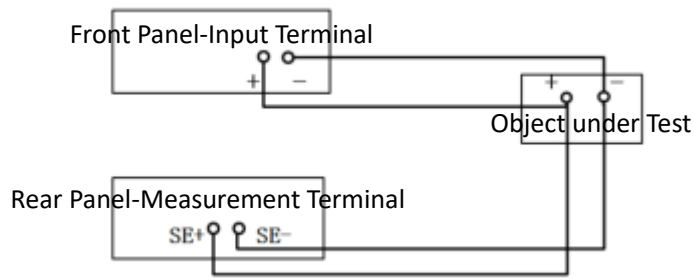

Figure 6-3 Wiring Diagram of Remote Compensation

SE+ and SE- are remote input terminals. In order to avoid the voltage drop caused by too long load input leads, remote test allows to measure directly on the input terminal source to improve measurement accuracy.

6.4 Trigger Signal Terminal

The external trigger signal is a voltage trigger. When a voltage signal of DC5V~DC24V is given, the trigger is valid; when there is no voltage, the trigger is invalid. The current monitoring output is a voltage output, and the output signal range is 0~10V. The real-time current from zero to full range is indicated. The output signal impedance is less than or equal to 10KΩ.

Description of Terminals:

Terminal NO.	Description
1	Passive Trigger Positive / Test Result Power Supply Positive
2	Passive Trigger Negative/Active Trigger Positive
3	Ground (GND)/Active Trigger Negative
4	Test Result Output 1 (Incorrect Detection)
5	Test Result Output 2 (Correct Detection)

Trigger Signal Terminal Diagram

Wiring Instructions:

1. Wiring Method for Passive Trigger Input (External Passive Switch)

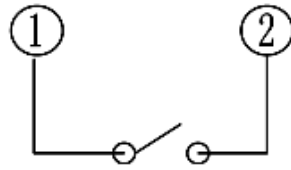

2. Wiring Method for Active Trigger Input (External Power Signal)

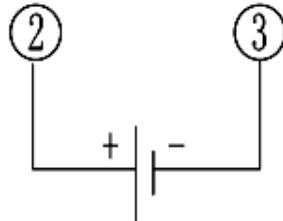

3. Wiring Method for Test Result Output (Need External Power Supply)

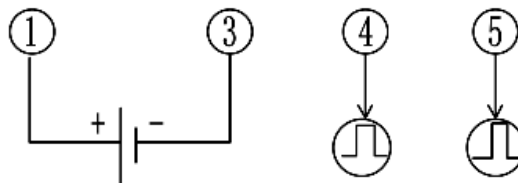

Note:

- 1) The voltage range of all external power supplies shall not exceed DC5V~DC24V.
- 2) The maximum withstand current of the test result output terminals (④ and ⑤) is 20mA.
- 3) Due to the internal optocoupler, when the terminals ④ and ⑤ output high level, the high level voltage will be about 1V lower than the external power supply voltage.
- 4) When the test result is correct, the terminal ⑤ outputs a high level of about 500ms. When the test result is wrong or fails, the terminal ④ outputs a high level of about 1500ms. The terminals ④ and ⑤ are both low level when there is no output.
- 5) The trigger input adopts positive transition edge input. Once the passive switch is closed (or the trigger voltage signal is loaded), it indicates that the trigger signal input has been completed. When triggering again, the operation needs to be redone.
- 6) When the terminal ① is connected to the external power source positive, either passive trigger or active trigger can be used normally. It is recommended that passive trigger input be used at this time.

7. Technical Specifications

This chapter mainly covers the following:

- Main Technical Parameters
- Notes on Calibration Parameters

Table 7-1 Main Technical Parameters of UTL8500 Series Electronic Load

Model		UTL8511		UTL8512		UTL8512B+		UTL8513	
Rated Value 0~40°C	Input Voltage	0~150V		0~150V		0~500V		0~150V	
	Input Current	0~3A	0~30A	0~3A	0~30A	0~1.5A	0~15A	0~12A	0~120A
	Input Power	150W		300W		300W		600W	
	Minimum Operating Voltage	1.4V at 30A		1.4V at 30A		3V at 15A		2.8V at 120A	
Constant Voltage Mode	Range	0~18V	0~150V	0~18V	0~150V	0~50V	0~500V	0~18V	0~150V
	Resolution	0.1 mV	1mV	0.1 mV	1mV	0.1 mV	1mV	0.1 mV	1mV
	Precision	± (0.05%+0.025%FS)		± (0.05%+0.025%FS)		± (0.05%+0.025%FS)		± (0.05%+0.025%FS)	
Constant Current Mode	Range	0~3A	0~30A	0~3A	0~30A	0~1.5A	0~15A	0~12A	0~120A
	Resolution	0.1mA	1mA	0.1mA	1mA	0.1mA	1mA	0.1mA	1mA
	Precision	± (0.05%+0.05%FS)		± (0.05%+0.05%FS)		± (0.05%+0.05%FS)		± (0.05%+0.05%FS)	
Constant Resistance Mode	Range	0.05Ω~7.5KΩ		0.05Ω~7.5KΩ		0.1Ω~25KΩ		0.05Ω~7.5KΩ	
	Resolution	16bit		16bit		16bit		16bit	
	Precision	0.1%+0.08S		0.1%+0.08S		0.1%+0.08S		0.1%+0.08S	
Constant Power Mode	Range	150W		300W		300W		600W	
	Resolution	10mW		10mW		10mW		10mW	
	Precision	± (0.1%+0.1%FS)		± (0.1%+0.1%FS)		± (0.1%+0.1%FS)		± (0.1%+0.1%FS)	
Dynamic Mode (CC Mode)	T1&T2	50μS~99.999S/Res:1μS		50μS~99.999S/Res:1μS		50μS~99.999S/Res:1μS		50μS~99.999S/Res:1μS	
	Precision	5μS±100ppm		5μS±100ppm		5μS±100ppm		5μS±100ppm	
	Rise/Fall Slope	0.001~3.0A/us		0.001~3.0A/us		0.001~1.5A/us		0.001~1.5A/us	
	Minimum Rise Time	≥10us		≥10us		≥10us		≥10us	
Voltage Readback Value	Range	0~18V	0~150V	0~18V	0~150V	0~50V	0~500V	0~18V	0~150V
	Resolution	0.1mV	1mV	0.1mV	1mV	0.1mV	1mV	0.1mV	1mV
	Precision	± (0.025%+0.025%FS)		± (0.025%+0.025%FS)		± (0.025%+0.025%FS)		± (0.025%+0.025%FS)	
Current Readback Value	Range	0~3A	0~30A	0~3A	0~30A	0~3A	0~15A	0~12A	0~120A
	Resolution	0.1mA	1mA	0.1mA	1mA	0.01mA	0.1mA	0.01mA	0.1mA
	Precision	0.025%+0.05%FS		± (0.025%+0.05%FS)		0.05%+0.05%FS		± (0.025%+0.05%FS)	
Power Readback Value	Range	150W		300W		300W		600W	
	Resolution	10mW		10mW		10mW		10mW	
	Precision	± (0.1%+0.1%FS)		± (0.1%+0.1%FS)		± (0.1%+0.1%FS)		± (0.1%+0.1%FS)	
Over Power Protection	≥1.05 Times the Set Value, Delay Protection	≥1.1 Times the Set Value, Immediate Protection		≥1.05 Times the Set Value, Delay Protection		≥1.1 Times the Set Value, Immediate Protection		≥1.05 Times the Set Value, Delay Protection	
	>(FS+15W), Immediate Protection	>(FS+15W), Immediate Protection		>(FS+15W), Immediate Protection		>(FS+15W), Immediate Protection		>(FS+15W), Immediate Protection	
Over Current Protection	≥1.05 Times the Set Value, Delay Protection	≥1.1 Times the Set Value, Immediate Protection		≥1.05 Times the Set Value, Delay Protection		≥1.1 Times the Set Value, Immediate Protection		≥1.05 Times the Set Value, Delay Protection	
	>(FS+1.5A), Immediate Protection	>(FS+1.5A), Immediate Protection		>(FS+1.5A), Immediate Protection		>(FS+1.5A), Immediate Protection		>(FS+1.5A), Immediate Protection	
Over Voltage Protection	≥1.05 Times the Set Value, Delay Protection	≥1.1 Times the Set Value, Immediate Protection		≥1.05 Times the Set Value, Delay Protection		≥1.1 Times the Set Value, Immediate Protection		≥1.05 Times the Set Value, Delay Protection	
	>(FS+3V), Immediate Protection	>(FS+3V), Immediate Protection		>(FS+3V), Immediate Protection		>(FS+3V), Immediate Protection		>(FS+3V), Immediate Protection	
Over Temperature Protection	≥85°C		≥85°C		≥85°C		≥85°C		
Short Circuit	Current (CC)	≤3A	≤30A	≤3A	≤30A	≤1.5A	≤15A	≤12A	≤120A
	Voltage (CV)	0V	0V	0V	0V	0V	0V	0V	0V
	Resistance (CR)	35mΩ	35mΩ	35mΩ	35mΩ	35mΩ	35mΩ	35mΩ	
Impedance of Input Terminal	300KΩ		300KΩ		1MΩ		300KΩ		
Fuse Specification	0.5A(110V)/0.25A(220V)		0.5A(110V)/0.25A(220V)		0.5A(110V)/0.25A(220V)		0.5A(110V)/0.25A(220V)		
Requirements of Power Supply	110V/220V		110V/220V		110V/220V		110V/220V		
	Frequency 50/60Hz		Frequency 50/60Hz		Frequency 50/60Hz		Frequency 50/60Hz		
Size mm (Width*Height*Depth)	214W*88H*340Dmm		214W*88H*340Dmm		214W*88H*340Dmm		214W*88H*520Dmm		
Net Weight (kg)	5.3KG		5.3KG		5.3KG		7.6kg		

Remarks:

Environmental Requirements: $23^{\circ}\text{C} \pm 5^{\circ}\text{C}$ $\leq 90\% \text{RH}$.

Recommended Calibration Frequency: Once/Year

AC Power Input Level: (The switch on the rear panel of the electronic load can choose 110V or 220V)

110V: $110\text{V} \pm 10\%$ 50~60Hz

220V: $220\text{V} \pm 10\%$ 50~60Hz

UNI-T®**UNI-TREND TECHNOLOGY (CHINA) CO., LTD.**

No.6, Gong Ye Bei 1st Road,
Songshan Lake National High-Tech Industrial
Development Zone, Dongguan City,
Guangdong Province, China

Made in China