

Model 4300C

Programmable Digital μ -Ohmmeter

Operation Manual



Need Help? Call 800-548-9806.
www.valhallascientific.com

©2015 Valhalla Scientific, Inc. All Rights Reserved.



*4300C Programmable μ -Ohmmeter - User & Maintenance Manual
Edition 1*

Copyright © 2009 Valhalla Scientific, Inc. All rights reserved

Certification

Valhalla Scientific Inc. certifies that this instrument was thoroughly tested, inspected, and found to meet published specifications when shipped from the factory. Valhalla Scientific, Inc. further certifies that its calibration measurements are traceable to the National Institute of Standards and Technology to the extent allowed by N.I.S.T.'s calibration facility.

Due to continuing product refinement and due to possible parts manufacturer change, Valhalla Scientific, Inc. reserves the rights to change any or all specifications without notice.

Warranty Statement

The warranty period for this instrument is stated on your invoice and packing list. Please refer to these to determine appropriate warranty dates.

Valhalla Scientific, Inc. will repair the instrument during the warranty period provided it is return to our repair and calibration facility freight prepaid. No other warranty is expressed or implied.

Valhalla Scientific, Inc. is not liable for consequential damages.

Permission and a Return Material Authorization number (RMA) must be obtained directly from the factory for warranty repairs. No liability will be accepted if returned without such permission.

Document History

All Editions and Updates of this manual and their creation date are listed below. The first edition of the manual is 1. The edition number increases by 1 whenever the manual is revised. Updates, which are issued between editions, contain replacement pages to correct or add additional information to the current Edition of the manual. Whenever a new Edition is created, it will contain all of the update information for the previous Edition. Each new Edition or Update also includes a revised copy of this documentation history page.

Edition 1 June 2009



Safety Symbols



Instruction manual symbol affixed to product. Indicates that the user must refer to the user manual for specific WARNING or CAUTION information to avoid personal injury or damage to the product.



Warning - Risk of Electrical Shock.

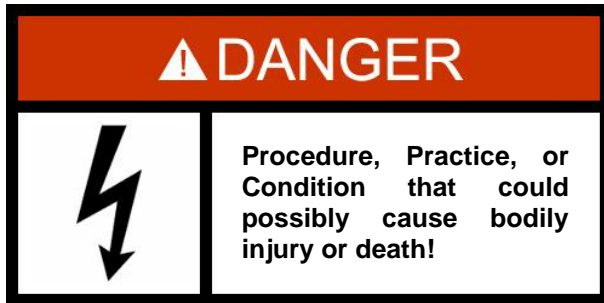

The following general safety precautions must be observed during all phases of operation, service, and repair of this product. Failure to comply with these precautions or with specific warnings elsewhere in this manual violates safety standards of design, manufacture, and intended use of the product. Valhalla Scientific assumes no liability for the customer's failure to comply with these requirements.

Ground the equipment: For Safety class 1 equipment (equipment having a protective earth terminal), an interrupted safety earth ground must be provided from the main power source to the product input wiring terminals or supplied power cable.

DO NOT operate the product in an explosive atmosphere or in presence of flammable gases or fumes.

For continued protection, replace the line fuse(s) only with fuse(s) of the same voltage and current rating and type. **DO NOT** use repaired fuses or short-circuited fuse holders.

Keep away from live circuits: Operating personnel must not remove equipment covers or shields. Procedures involving the removal of covers or shields are for the use of service-trained personnel only. Under certain conditions, dangerous voltage may exist even with the equipment switched off. To avoid dangerous electrical shock, **DO NOT** perform procedures involving cover or shield removal unless you are qualified to do so.

DO NOT operate damaged equipment: Whenever it is possible that the safety protection features built into this product have been impaired, either through physical damage, excessive moisture, or any other reason, **REMOVE POWER** and do not use the product until safe operation can be verified by service-trained personnel. If necessary, return the product to Valhalla Scientific for service and repair to ensure that safety features are maintained.

DO NOT service or adjust alone: Do not attempt internal service or adjustment unless another person, capable of rendering first aid and resuscitation, is present.

DO NOT substitute parts or modify equipment: Because of the danger of introducing additional hazards, do not install substitute parts or perform any unauthorized modification to the product. Return the product to Valhalla Scientific for service and repair to ensure that safety features are maintained.

Measuring high voltage is always hazardous: ALL multimeters input terminals (both front and rear) must be considered hazardous whenever inputs greater than 42V (dc or peak) are connected to ANY input terminal.

Permanent wiring of hazardous voltage or sources capable of delivering greater than 150VA should be labeled, fused, or in some other way protected against accidental bridging or equipment failure.

DO NOT leave measurement terminals energized when not in use.

Table of Contents

CHAPTER 1 INSPECTION & INSTALLATION.....	1-1
INTRODUCTION.....	1-1
INITIAL INSPECTION	1-2
SETTING THE LINE VOLTAGE	1-3
FUSE SELECTION	1-3
RACK MOUNTING	1-4
SAFETY PRECAUTIONS.....	1-5
CHAPTER 2 SPECIFICATIONS.....	2-1
STANDARD MEASUREMENT MODE SPECIFICATIONS.....	2-1
TEMPERATURE COMPENSATOR MODE SPECIFICATIONS	2-1
GENERAL SPECIFICATIONS.....	2-2
ENVIRONMENTAL.....	2-2
POWER REQUIREMENTS	2-2
PHYSICAL.....	2-2
CHAPTER 3 GETTING STARTED	3-1
FRONT PANEL.....	3-1
<i>On/Off Switch</i>	3-1
<i>Display</i>	3-2
<i>Range Selection and Test Current Key</i>	3-2
Range Selection	3-2
Test Current Key	3-3
<i>Function/Numerical Keys</i>	3-3
<i>TC Mode Key and Sensor Receptacle</i>	3-5
<i>HLC LEDs</i>	3-5
<i>Cable Disconnect Status Indicators</i>	3-6
<i>Charging Inductor Mode</i>	3-6
<i>Source and Sense Binding Post</i>	3-6
REAR PANEL.....	3-8
<i>Line Voltage Switch</i>	3-8
<i>Fuse Holder</i>	3-9
<i>Power Connector</i>	3-9
<i>HLC Relay Terminal</i>	3-9
<i>RS-232 Connector</i>	3-10
APPLYING POWER	3-11
POWER-ON DEFAULT SETTINGS.....	3-11
CONNECTING A LOAD TO THE 4300C.....	3-12
TAKING STANDARD MEASUREMENTS	3-14
<i>Setting the Range</i>	3-14
<i>Test Current</i>	3-14
<i>Charging Inductor Mode</i>	3-15
<i>Cable Disconnect Status Indicators</i>	3-15
CHAPTER 4 MEASUREMENT MODES AND FUNCTIONS.....	4-1
STANDARD MEASUREMENT MODE.....	4-1
“TCM” - TEMPERATURE COMPENSATED MEASUREMENT MODE	4-1
<i>Omni Compensator</i>	4-3
<i>TCM ON</i>	4-3
<i>TCS – Temperature Compensator Setup</i>	4-3
<i>TCC – Temperature Compensator Calibration</i>	4-5
“HLC” – HI-LO COMPARATOR MODE	4-6
<i>HLC Relay Terminal</i>	4-6

<i>Setting the Limits</i>	4-7
<i>HLC ON</i>	4-8
UPDATE FUNCTION	4-8
<i>Display Update Rate</i>	4-8
<i>Display Intensity</i>	4-8
<i>Setting the Display Update Rate and Intensity</i>	4-9
RUN/HOLD FUNCTION	4-10
<i>RUN/HOLD</i>	4-10
<i>RUN/PKHI</i>	4-10
<i>RUN/PKLO</i>	4-10
<i>Configuring the Run/Hold Function</i>	4-10
PRINT/LOG FUNCTION	4-11
<i>PRINT</i>	4-11
<i>LOG</i>	4-11
<i>LOG2</i>	4-11
<i>Configuring the Print button function</i>	4-12
VIEW FUNCTION	4-13
<i>Using the View function</i>	4-13
CHAPTER 5 OPTIONAL FEATURES AND ACCESSORIES	5-1
OPTIONS	5-1
<i>BCD: Data Output</i>	5-1
<i>GPIB</i>	5-1
<i>USB</i>	5-1
ACCESSORIES.....	5-1
<i>Omni Compensator</i>	5-1
<i>Option RX-3: Rack Mount Adapter</i>	5-1
TEST LEADS.....	5-2
<i>Alligator Clip Type Leads</i>	5-2
Option K: Kelvin Lead Set.....	5-2
Option KK: Heavy-Duty Lead Set.....	5-2
Option C: Banana-to-Clip Cable	5-2
<i>Needle Type Probes</i>	5-3
Option MP-1: Kelvin Micro-Probes	5-3
Option MP-2: Kelvin Mini-Probes	5-3
Option MP-S: Single Pointed Probe Set	5-3
<i>Surface Probes</i>	5-4
Option MP-4: Surface Probes	5-4
Option MP-5: Surface Probes	5-4
<i>Other Lead Sets</i>	5-4
Option BBL: Banana-to-Banana Cable	5-4
Option SL-48: Low Thermal Leads	5-4
CHAPTER 6 REMOTE OPERATIONS	6-1
IEEE INTERFACE	6-1
THE PURPOSE OF IEEE STANDARD 488.....	6-1
DEFINITIONS	6-2
BUS RESTRICTIONS	6-3
DETAILED DESCRIPTIONS OF BUS OPERATIONS.....	6-4
SETTING THE IEEE ADDRESS.....	6-7
REMOTE AND LOCAL STATES	6-8
<i>Local State</i>	6-8
<i>Remote State</i>	6-8
READING THE DISPLAY DATA	6-8
4300C COMMAND SET FOR GPIB	6-10
<i>Voltage Range</i>	6-10

<i>Test Current Range</i>	6-11
<i>SRQ's and Serial Polls</i>	6-11
<i>Output Data Terminator</i>	6-12
<i>Test Current Control</i>	6-12
<i>Display Hold</i>	6-12
<i>Temperature Compensation</i>	6-12
<i>Configuration Status Query</i>	6-13
RS-232 INTERFACE	6-15
CONNECTING THE 4300C VIA RS232 INTERFACE	6-15
<i>The RS232 interface capabilities:</i>	6-15
<i>Notes for RS232 installation</i>	6-15
<i>Connecting to a Computer</i>	6-16
<i>Checking Connections</i>	6-16
INPUT AND OUTPUT QUEUE	6-17
COMMANDS AND SYNTAX	6-17
<i>RS232 message terminators</i>	6-17
<i>Entering Commands</i>	6-17
<i>Command Characters</i>	6-17
<i>Combining Commands</i>	6-17
<i>Synopsis of Commands</i>	6-17
DETAILS OF COMMAND REFERENCE	6-18
COMMAND INDEX	6-18
BCD INTERFACE	6-35
GENERAL	6-35
BCD PIN ASSIGNMENTS	6-35
<i>Data</i>	6-35
<i>Ranges</i>	6-36
<i>Overload – Pin 12</i>	6-36
<i>Pin assignment</i>	6-36
CHAPTER 7 THEORY OF OPERATIONS	7-1
4-WIRE CONFIGURATION	7-1
GENERAL DESCRIPTION OF CIRCUITS	7-2
DETAILED CIRCUIT DESCRIPTIONS	7-5
<i>Current Source</i>	7-5
Reference	7-5
Error Amplifier	7-5
Output Stage	7-6
Range Switching	7-6
Protection Circuitry	7-6
Power Supply	7-6
Charging Inductor Mode	7-6
<i>Micro-Controller Board</i>	7-7
Micro-Controller	7-7
Over-Voltage Protection	7-7
TCM	7-7
2.5V Reference	7-8
RS-232/Display Switch and RS 232 Driver/Receiver	7-8
TROUBLESHOOTING	7-8
<i>Localizing the Problem</i>	7-8
<i>Component Replacement</i>	7-9
CHAPTER 8 ROUTINE MAINTENANCE	8-1
GENERAL	8-1
REQUIRED TEST EQUIPMENT	8-1
PRE-CALIBRATION PROCEDURE	8-1

4300C CALIBRATION PROCEDURE.....	8-2
<i>Standard Calibration</i>	8-2
<i>Sense Calibration</i>	8-2
<i>Current Source Calibration</i>	8-3
Reference Adjustment.....	8-3
10 Amp Adjustment.....	8-4
1 Amp Adjustment.....	8-4
0.1 Amp Adjustment.....	8-4
10mA Adjustment.....	8-4
1mA Adjustment.....	8-4
0.1mA Adjustment.....	8-4
<i>TCM Calibration</i>	8-5
CHAPTER 9 SPECIAL PROCEDURES	9-1
GENERAL.....	9-1
CONNECTIONS AND SETTLING TIME	9-1
NOISY READINGS	9-2
DISCONNECTING THE CABLES.....	9-3
CHAPTER 10 ADDENDUMS.....	10-1
CHAPTER 11 PARTS LIST	11-1
INDEX	11-1
μCONTROLLER PC BOARD ASSEMBLY	11-2
4300C MAIN PC BOARD ASSEMBLY	11-5
4300C DISPLAY PC BOARD ASSEMBLY	11-8
4300C OUTPUT PC BOARD ASSEMBLY.....	11-9
CHAPTER 12 SCHEMATICS	12-1
INDEX	12-1
μCONTROLLER BOARD SCHEMATICS.....	12-2
(DWG#: 834U-071) PG 1 of 3	12-2
(DWG#: 834U-071) PG 2 of 3	12-3
(DWG#: 834U-071) PG 3 of 3	12-4
4300C MAIN BOARD SCHEMATICS	12-5
(DWG#: 4300C-070) PG 1 of 2	12-5
(DWG#: 4300C-070) PG 2 of 2	12-6
4300C DISPLAY BOARD SCHEMATICS	12-7
(DWG#: 4300C-071) PG 1 of 2	12-7
(DWG#: 4300C-071) PG 2 of 2	12-8

List of Tables

Table 1 – Ranges Parameters and Accuracies.....	2-1
Table 2 - Temperature Compensation Mode Accuracy	2-1
Table 3 – Range Selection Table.....	3-2
Table 4 - Function/Numerical Keys Description	3-4
Table 5 – RS-232 Pin out	3-10
Table 6 - Power-Up Defaults	3-11
Table 7 – Range Selection Table.....	3-14
Table 8 – TCM Setup Ref. Table	4-4
Table 9 – HLC Truth Table	4-7
Table 10 – HLC Default Limits.....	4-7
Table 11 – HLC Truth Table	4-8
Table 12 - ASCII Character Codes	6-5
Table 13 - IEEE.....	6-14
Table 14 – RS-232 Connector Pin Configuration	6-16

Table 15 – BCD Measurement Data	6-33
Table 16 – BCD Range Data	6-34
Table 17 – BCD Pin Assignment Reference Table.....	6-34

List of Figures

Figure 1 - Rear Panel Configuration	1-2
Figure 2 – Rack Mount Kit	1-4
Figure 3 - Front Panel Layout	3-1
Figure 4 - Display Windows	3-2
Figure 5 - Voltage Setting	3-2
Figure 6 - Ohms Setting	3-3
Figure 7 - Test Current	3-3
Figure 8 – Function/Numerical Buttons	3-3
Figure 9 - Temp. Comp. Mode Key and Receptacle	3-5
Figure 10 - HLC LEDs.....	3-5
Figure 11 - Disconnect Status & Charging Inductor LEDs.....	3-6
Figure 12 - Binding Post	3-6
Figure 13 – Banana Plugs to Binding Post	3-7
Figure 14 - 4300C Rear Panel	3-8
Figure 15 – HI-LO Comparator Relay Pins	3-9
Figure 16 – 9 Pin RS-232 Connector	3-10
Figure 17 – Display	3-11
Figure 18 – Alligator	3-12
Figure 19 – Surface.....	3-13
Figure 20 – Dual	3-13
Figure 21 - Voltage Setting	3-14
Figure 22 - Ohms Setting.....	3-14
Figure 23 – Test Current.....	3-14
Figure 24 – Omni Compensator Temperature Sensor	4-3
Figure 25 - HLC LEDs.....	4-6
Figure 26 - HLC Relay Pins.....	4-6
Figure 27 – Display Function Window.....	4-10
Figure 28 –Omni Compensator	5-1
Figure 29 – “K” Kelvin Lead Set	5-2
Figure 30 – “KK” Heavy Duty Lead Set	5-2
Figure 31 – “C” Banana/Clip Cable.....	5-2
Figure 32 – “MP-1” Micro Probes	5-3
Figure 33 – “MP-2” Mini Probes	5-3
Figure 34 - “MP-S” Single Pointed Probes.....	5-3
Figure 35 – “MP-4” Surface Probes.....	5-4
Figure 36 – “MP-5” Surface Probes.....	5-4
Figure 37 – “SL-48” Low Thermal Leads.....	5-4
Figure 38 – 4-Wire Configuration.....	7-1
Figure 39 – 4300C Block Diagram	7-2
Figure 40 – Current Source Block Diagram	7-5
Figure 41 – μ -Controller Block Diagram	7-7
Figure 42 – Drawing № 4300C-700	8-6

INTRODUCTION

Welcome to the world of low resistance measurement!

The Model 4300C is a unique instrument capable of handling even the toughest resistance measurement applications. The 4300C is designed to measure the low resistance of such items as coils, transformers, ballasts, heater elements, etc. Some features of the 4300C that give it an edge over competitive products are:

- "Charging Inductor" mode for reduced settling times.
- "Disconnect Status" indicators designed with safety in mind.
- Full 4-wire Kelvin terminal configuration.
- Fully selectable test currents up to 10A.
- Temperature Compensation.
- Internal Hi-Lo Limit Comparator.
- Available locking rear Bendix connectors.
- Available data outputs and remote programming capability.

Please read this manual thoroughly and all accompanying addendums before attempting to operate this ohmmeter.

INITIAL INSPECTION

If the shipping carton is damaged, request that the carrier's agent be present when the unit is unpacked. If the instrument appears damaged, the carrier's agent should authorize repairs before the unit is returned to the factory. Even if the instrument appears undamaged, it may have suffered internal damage in transit that may not be evident until the unit is operated or tested to verify conformance with its specifications. If the unit fails to operate or fails to meet the performance specifications of Chapter 2, notify the carrier's agent and the nearest Valhalla Sales Office. Retain the shipping carton for the carrier's inspection. DO NOT return equipment to Valhalla Scientific, Inc. or any of its sales offices prior to obtaining authorization to do so.

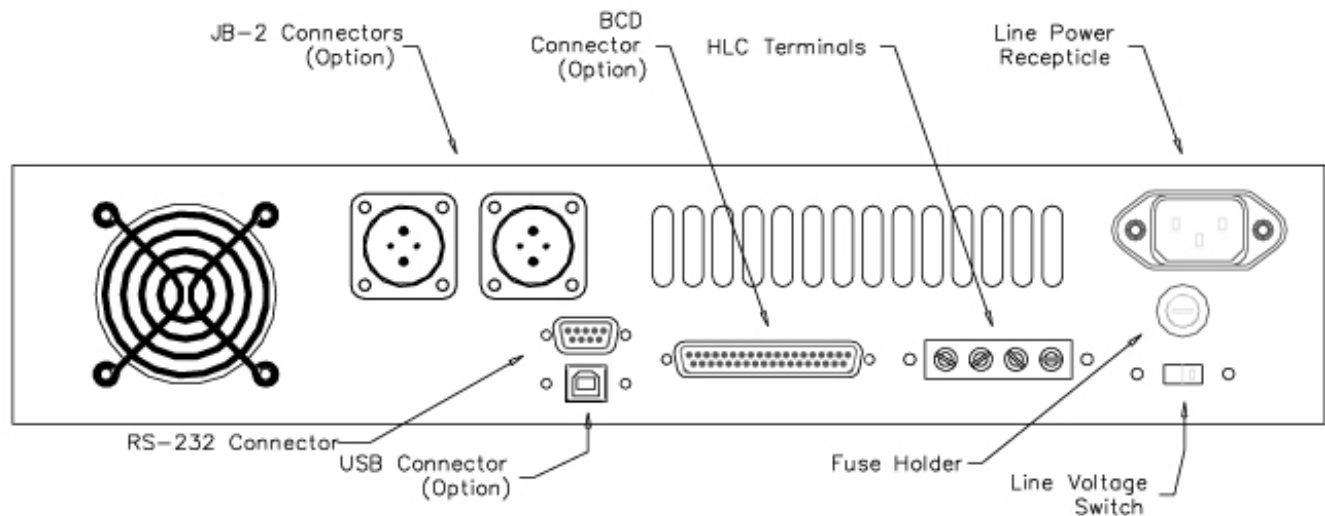

Figure 1 - Rear Panel Configuration

SETTING THE LINE VOLTAGE

The line voltage selection is preconfigured according to the country to which it is shipped or as specified by the customer.

To change this setting, follow the steps below:

1. Remove the power cord from the instrument.
2. With a small flat head screwdriver, slide the “Line Voltage Selector” switch to the appropriate position.
3. Replace the line power fuse accordingly.



Before connecting the device to an AC power source, verify that the line voltage selection switch is set to match the AC line voltage and that the proper line fuse is installed. These topics are discussed in the following sections.

FUSE SELECTION

The line power fuse must match the line voltage selection as follows:

- 105-125VAC – 3A SLO-BLO
- 210-250VAC – 1.5A SLO-BLO

The fuse holder is located on the rear panel (see Figure 1). To install a fuse, first disconnect the Ohmmeter’s power cord. Insert one end of the fuse into the fuse cap. Insert the fuse cap into the fuse holder. With a small flathead screwdriver, push in on the fuse cap and rotate it clockwise.

RACK MOUNTING

Optional brackets are available for mounting the ohmmeter in a standard 19" equipment rack. The rack mount kit consists of two brackets plus 4 flat head screws. The brackets are easily installed on the front end of each side rail (see Figure 2). The kit is listed in chapter 5 as *Option RX-3*

Figure 2 – Rack Mount Kit

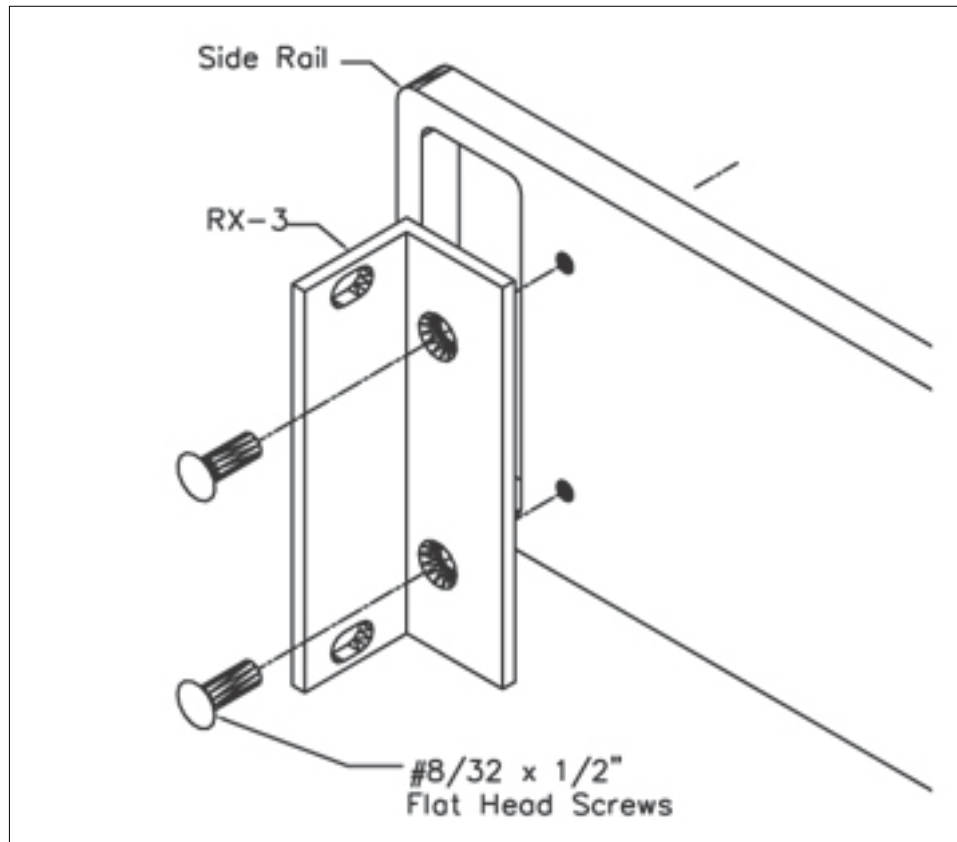

The size of the ohmmeter and the location of its center of gravity dictate that it must be supported on both sides along its entire length through the use of trays or slides. If it is to be transported while mounted in a rack, it should be supported so as to prevent upward or downward movement.

It is recommended that blank panels at least 1.75 inches high be installed between this and any other units in the rack to ensure freedom of air flow. Under no circumstances should the ambient air temperature around the unit exceed 50°C while the unit is in operation or 70°C when power is removed.

SAFETY PRECAUTIONS

The power plug must be a three-contact device and should be inserted only into a three-contact mating socket where the third contact provides a ground connection. If power is provided through an extension cable, the ground connection must be continuous. Any discontinuity in the ground lead may render the unit unsafe for use!

The Model 4300C utilizes forced air cooling of the internal components. This operates continuously and care must be taken to ensure that the intake and exhaust ports remain clear. Blocked vents may cause a dangerous overheating condition!

This section contains accuracy and operational specifications for the Model 4300C. The accuracy specifications are valid for a period of one year from the date of calibration at a temperature of 22°C to 28°C. Outside this range, the temperature coefficient specification applies.

STANDARD MEASUREMENT MODE SPECIFICATIONS

#	Range	Test Voltage	Full Scale	Resolution	Current Source ¹	Accuracy ² (±% of Reading ±Ω)	Temperature Coefficient ³
1)	2mΩ	20mV	2.0000mΩ	100nΩ	10A	± .06 ± .0006m	±50ppm/°C
2)	20mΩ	20mV	20.000mΩ	1μΩ	1A	± .04 ± .006m	±50ppm/°C
3)	200mΩ	20mV	200.00mΩ	10μΩ	.1A	± .04 ± .06m	±50ppm/°C
4)	2Ω	20mV	2.0000Ω	100μΩ	10mA	± .04 ± .0006	±50ppm/°C
5)	20Ω	20mV	20.000Ω	1mΩ	1mA	± .04 ± .006	±50ppm/°C
6)	200Ω	20mV	200.00Ω	10mΩ	.1mA	± .04 ± .16	±50ppm/°C
7)	20mΩ	200mV	20.000mΩ	1μΩ	10A	± .06 ± .003m	±50ppm/°C
8)	200mΩ	200mV	200.00mΩ	10μΩ	1A	± .04 ± .03m	±50ppm/°C
9)	2Ω	200mV	2.0000Ω	100μΩ	.1A	± .04 ± .0003	±50ppm/°C
10)	20Ω	200mV	20.000Ω	1mΩ	10mA	± .04 ± .003	±50ppm/°C
11)	200Ω	200mV	200.00Ω	10mΩ	1mA	± .04 ± .03	±50ppm/°C
12)	2kΩ	200mV	2.0000kΩ	100mΩ	.1mA	± .04 ± .0013k	±50ppm/°C
13)	200mΩ	2V	200.00mΩ	10μΩ	10A	± .06 ± .03m	±50ppm/°C
14)	2Ω	2V	2.0000Ω	100μΩ	1A	± .04 ± .0003	±50ppm/°C
15)	20Ω	2V	20.000Ω	1mΩ	.1A	± .04 ± .003	±50ppm/°C
16)	200Ω	2V	200.00Ω	10mΩ	10mA	± .04 ± .03	±50ppm/°C
17)	2kΩ	2V	2.0000kΩ	100mΩ	1mA	± .04 ± .0003k	±50ppm/°C
18)	20kΩ	2V	20.000kΩ	1Ω	.1mA	± .04 ± .003k	±50ppm/°C

¹ Current source is ±1% absolute accuracy

² Accuracy specifications are valid following a 30 minute warm-up at an ambient temperature between 22°C and 28°C, and include the effects of line voltage variations within the allowed range.

³ Temperature coefficient Specified for temperature ranges from 5°C to 21°C and 29°C to 50°C.

Table 1 – Ranges Parameters and Accuracies

TEMPERATURE COMPENSATOR MODE SPECIFICATIONS

#	Range	Range Settings	Accuracy ⁴ (±% of Reading ±Ω)	#	Range	Range Settings	Accuracy ⁴ (±% of Reading ±Ω)
1)	2m	10A/20mV	± .11 ± .0006m	10)	20	10mA/200mV	± .09 ± .003
2)	20m	1A/20mV	± .09 ± .006m	11)	200	1mA/200mV	± .09 ± .03
3)	200m	.1A/20mV	± .09 ± .06m	12)	2k	.1mA/200mV	± .09 ± .0003k
4)	2	10mA/20mV	± .09 ± .0006	13)	200m	10A/2V	± .11 ± .03m
5)	20	1mA/20mV	± .09 ± .006	14)	2	1A/2V	± .09 ± .0003
6)	200	.1mA/20mV	± .09 ± .06	15)	20	.1A/2V	± .09 ± .003
7)	20m	10A/200mV	± .11 ± .003m	16)	200	10mA/2V	± .09 ± .03
8)	200m	1A/200mV	± .09 ± .03m	17)	2k	1mA/2V	± .09 ± .0003k
9)	2	.1A/200mV	± .09 ± .0003	18)	20k	.1mA/2V	± .09 ± .003k

⁴Accuracy specifications valid following a 30 minute warm-up at an ambient temperature between 21°C and 29°C.

Table 2 - Temperature Compensation Mode Accuracy

GENERAL SPECIFICATIONS

Display:Multi Section VFD 140px x 32px

Overload Indication:Display flashes "OVERLOAD"

Terminal Configuration: Four-wire Kelvin

ADC Conversion Rate:45 conversions / second

Display Update:.....5 user selections (100msec, 200msec, 300msec, 400msec, 500msec)

Maximum Kick-Back Protection: 500A Peak Induced Current

Compliance Voltage (Normal Mode): 7.5 VDC nominal at 10A resistive

Compliance Voltage (Charging Inductor Mode): > 20 VDC when indicator is lit

Open Circuit Voltage (Test Current Off) : < 20mV between IHI and ILO terminals

ENVIRONMENTAL

Operating Temperature Range: 0 to 50°C

Humidity: 70% RH at 40°C non-condensing

Storage Temperature Range: -30°C to 70°

POWER REQUIREMENTS

Power Supply Voltage: 105-125 or 210-250 VAC

Power Supply Frequency:50 - 60 Hz

Power Supply Consumption:200VA Maximum

PHYSICAL

Dimensions:17"(43cm) W x 17"(43cm) D x 4"(10cm) H

Weight:9.1Kg (20 lbs) Net; 11.8Kg (26 lbs) Shipping

Chapter 3 covers the fundamentals of ohmmeter operation. This chapter will demonstrate how to use the ohmmeter's front & rear panel, how to make connections, and also describes the display sections and messages. Before explaining how to make measurements, it is useful to describe the sections of the front and rear panel of the 4300C

FRONT PANEL

The front panel of the 4300C can be broken down into nine parts. Figure 3 depicts the regions indicated by their name.

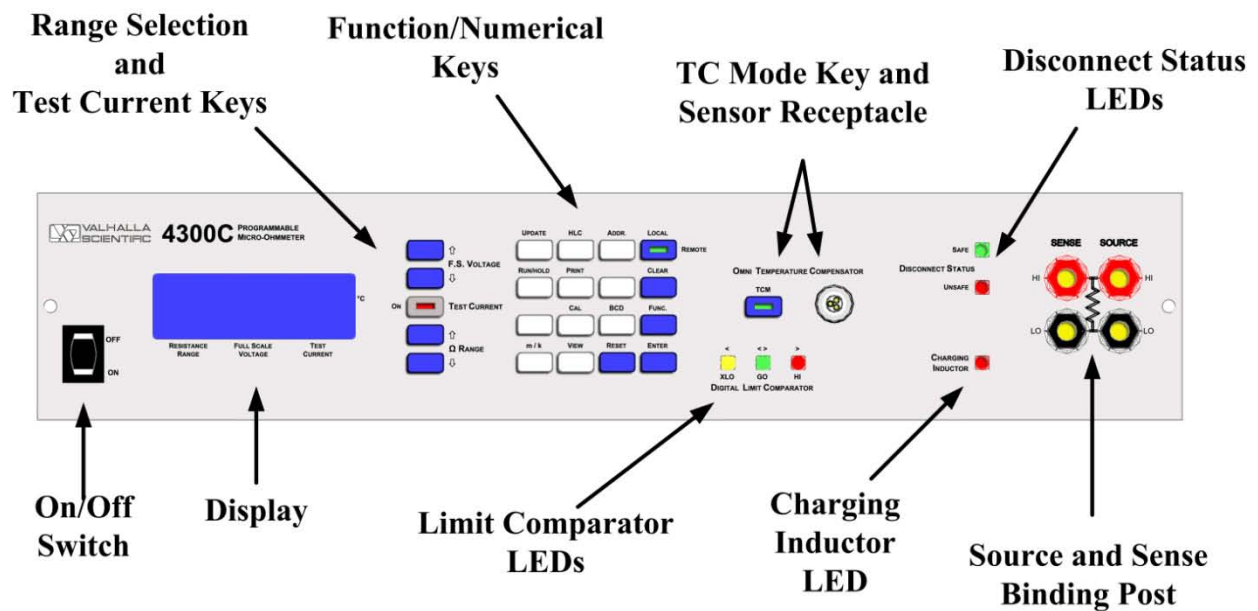

Figure 3 - Front Panel Layout

On/Off Switch

The power switch is a two position ON/OFF rocking switch, used to apply (ON position) or disconnect (OFF position) the AC power source from the internal circuitry of the ohmmeter.

Display

During measurements, the display presents 3 windows described in the table below.

Figure 4 - Display Windows

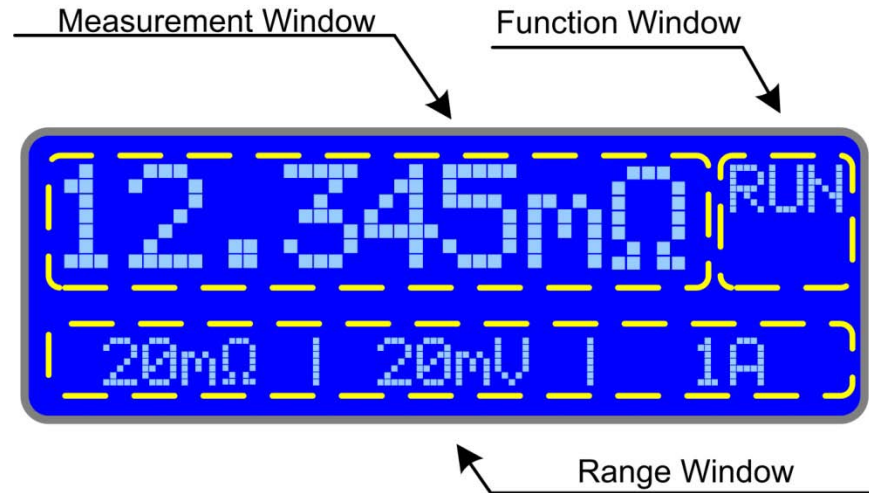

The display is also used to prompt the user with alerts and messages

Range Selection and Test Current Key

Range Selection

The 4300C has 3 voltage settings and 6 current ranges. The combination of the two result in 16 possible resistance measurement ranges. (See table 3).

Table 3 – Range Selection Table

	Voltage Setting		
	20mV	200mV	2V
10A	1) 2mΩ	7) 20mΩ	13) 200mΩ
1A	2) 20mΩ	8) 200mΩ	14) 2Ω
.1A	3) 200mΩ	9) 2Ω	15) 20Ω
10mA	4) 2Ω	10) 20Ω	16) 200Ω
1mA	5) 20Ω	11) 200Ω	17) 2kΩ
.1mA	6) 200Ω	12) 2kΩ	18) 20kΩ

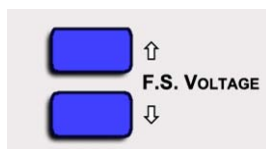

Figure 5 - Voltage Setting

The two keys labeled **F.S. Voltage** are used to change the voltage setting. The ↑ key is used to increase the voltage setting and the ↓ key is used to decrease the setting.



Figure 6 - Ohms Setting

Within a voltage setting there are six possible Ohms Ranges. The two keys labeled **Ω Range** are used switch between the ranges. The \uparrow key is used to increase the range and the \downarrow key is used to decrease the range. As the Ohms range increases, the current range decreases and vice versa.

Test Current Key



Figure 7 - Test Current

The **Test Current** key is used to turn the current source ON and OFF. A red LED within the Test Current key indicates the status of the current source.

The current source may also be turned on and off via a command from one of the interfaces, or by a remote foot switch Option "RS".

Function/Numerical Keys

There are sixteen Function/Numerical keys which are used to trigger the standard and/or optional ohmmeter functions and for data entry. Figure 8 depicts the key arrangement while table 4 lists a brief description of the keys and their use. The Remote Led indicates the remote/local state of the instrument. If the LED is on, the instrument is in remote state and can only receive commands through one of its remote interface ports. If the LED is off, the ohmmeter is in local state will receive commands only from the front panel keys.

Figure 8 – Function/Numerical Buttons

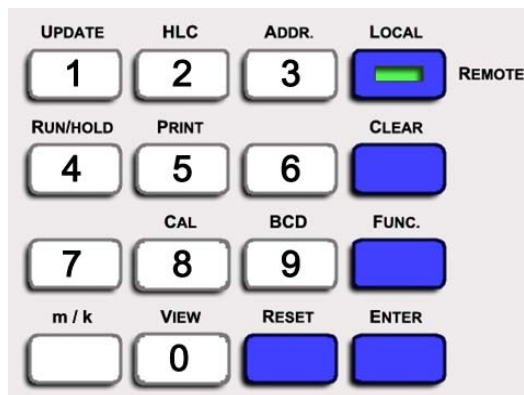
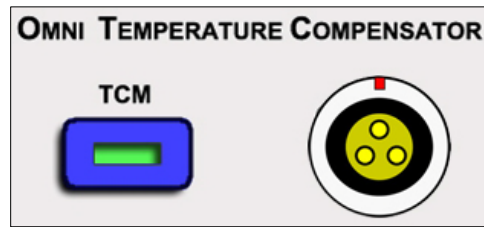

**Table 4 -
Function/Numerical Keys
Description**

Key	#	Description
Func.	-	The "FUNC." key is used in combination with other keys to change stored settings. This key is also used as a "Forward" key to skip through screens.
View	0	The "VIEW" key is used in combination with other function keys. It is used to view stored settings.
Update	1	The "UPDATE" key is used to set and/or view display update rate and intensity.
HLC	2	The "HLC" key is used to enable or disable the 4300C's internal "Multi-Range Dual Limit Comparator. Also used to set and/or view the limits used.
Addr.	3	The "ADDR." key is used to view the setting information for all of the standard or optional remote interfaces.
Run/Hold	4	The "RUN/HOLD" key is used to switch between run and hold state. Also used to select the hold configuration.
Print	5	The "PRINT" key is used to trigger the output of a print or log package to the RS- 232 port. Also used to select the print/log setting.
-	6	-
-	7	-
Cal	8	The "CAL" key is used to initiate the standard and TCM calibration procedure.
BCD	9	The "BCD" key enables the binary coded decimal output on models where the BCD option is installed.
Clear		The "CLEAR" key functions like a backspace when entering values. The key is also used to return to the previous screen.
Reset	-	The "RESET" key resets the ohmmeter returning it to Start-Up state.
Local	-	The "LOCAL" key is used to return from a remote to a local state.
Enter	-	The "ENTER" key is the user confirmation to a display prompt.
Store	-	The "Store" key is used to store the active range as default.

TC Mode Key and Sensor Receptacle

Figure 9 -
Temp. Comp. Mode Key
and Receptacle



This portion of the front panel is utilized only during temperature compensated type measurements (TCM). TCM mode is described in detail in the next chapter.

Critical to this measurement mode is precise temperature sensing, which entails solid and reliable connections between the sensing device and the instrument. The temperature sensor receptacle is designed so that the mating connector/sensor, the Valhalla Scientific Omni Compensator¹, can be inserted only in the proper mating position. A red dot on the Omni Compensator and a red tab on the receptacle are met to guide you in the insertion of the connector in the receptacle.

The TCM feature of the 4300C, arithmetically calculates the resistance value to display utilizing the ambient temperature and other parameters that will be present in later chapters. It is solemn for the user to be aware if the TCM mode is enabled or disabled so that the display reading may be interpreted correctly.

The green LED located within the TCM key is the visual indication that the TCM mode is on. A “Fault” message on the display indicates a missing sensor or that the sensor is not properly inserted in the receptacle.

The TCM key is used to enable or disable the TCM mode.

HLC LEDs

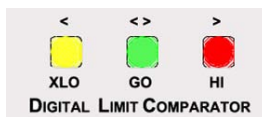

Figure 10 - HLC LEDs

This portion of the front panel is designated to give the user a visual indication of the HLC results. HLC mode is described in detail in the next chapter. The HLC LEDs are active only when the Hi-Lo comparator mode (HLC) is in use. The green LED, labeled “GO”, is on if the measured resistance value is between the limits² set by the user. The yellow LED, labeled “XLO”, is on if the measured resistance value is less than the lower limit. The red LED, labeled “XHI”, is on if the measured resistance value is greater than the upper limit.

¹ The Omni Compensator is an optional accessory to the 4300C. See Chapter 4-3 for more detail.

² See Chapter 4-8 for detail on how to set the Hi-Lo limits.

Cable Disconnect Status Indicators

The SAFE and UNSAFE LED's indicate whether or not it is safe to disconnect the test leads from the load or from the instrument. When a highly inductive load is being measured, a potentially lethal back-EMF is induced when the test current is removed. The 4300C provides a discharge path for this back-EMF and monitors the voltage. The SAFE LED is illuminated when the back-EMF is less than five volts.



Figure 11 - Disconnect Status & Charging Inductor LEDs

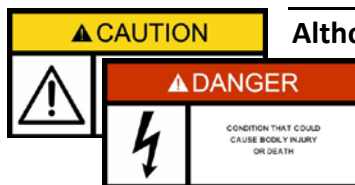

Although the 4300C is protected against up to 500

Amps of inductive kickback, it is not

advisable to remove test leads with the Test Current On, or with the UNSAFE LED lit. In some extreme applications if leads are removed or pull loose before the SAFE LED is lit, damage may occur to the 4300C and/or injury to the operator!

The UNSAFE LED is also illuminated whenever a test current of .1A or greater is selected and the Test Current is on, regardless of the load.

Charging Inductor Mode

The Charging Inductor mode LED indicates when the standard current source compliance voltage of 7V is exceeded. In this situation the 4300C provides a booster shot in excess of 20V to reduce the settling time when a large inductive load is being measured. The display readings should be ignored when this LED is illuminated.

Source and Sense Binding Post

Connections to the 4300C are made via the front panel source/sense terminals, which consist of two red and two black heavy duty binding posts with gold plated brass contact material. The posts can accept standard banana plugs, wires up to 12 AWG, or spade lugs. The four

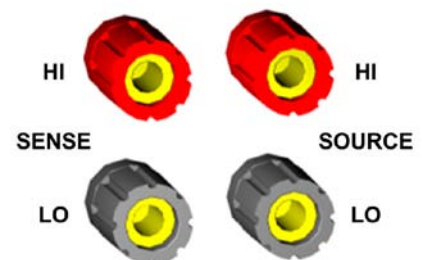

Figure 12 - Binding Post

terminals provide full 4-Wire Kelvin measurement capability. The right posts are the current source terminals and provide the test current, while

the left posts are the positive and negative voltage sense terminals used to monitor the voltage drop across the load.

When using Valhalla test leads, the tabbed side of each banana jack is connected to the current terminals. This ensures that current is carried in the largest conductor of the cable, and that the voltage input is shielded.



Figure 13 – Banana Plugs to Binding Post

The 4-Wire configuration eliminates errors normally caused by test lead and contact resistances. In many applications the contact resistance can exceed the value of the load by several orders of magnitude. The 4300C bypasses this potential error source by providing two terminals of constant current and an additional two terminals for high impedance voltage sensing. The result is a fast, accurate resistance measurement of the load, independent of the resistance of the current carrying leads. The Theory of Operation in Chapter 7 will illustrate how the 4-wire principle is used to eliminate lead, wire, and contact resistances as potential error sources.

REAR PANEL

The rear panel of the 4300C may vary from unit to unit according to the optional features installed. This section of the manual refers to the standard model without any optional features or modifications. If the 4300C that you are using features terminals or connectors not described in this section, please refer to Chapter 10 of this manual for addendums that reference the particularities of your model. Here is an outline to the use of each of the rear panel controls and connectors.

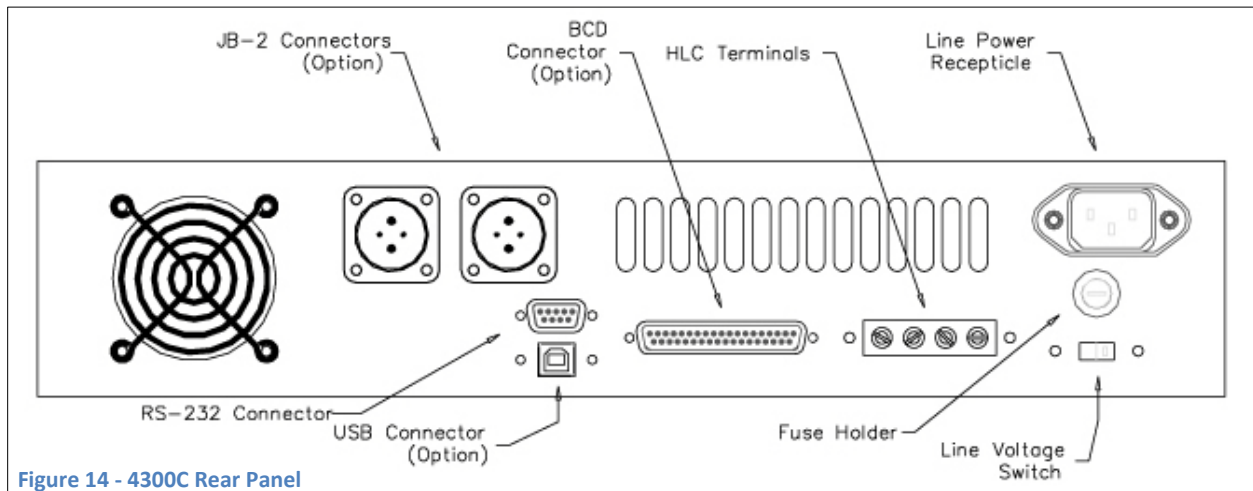

Figure 14 - 4300C Rear Panel

Line Voltage Switch



The line voltage switch allows the user to select the power settings according to the local AC line voltage. By sliding the switch upwards, the number 115 will appear on the switch. The instrument is now configured for line voltages of 115VAC \pm 10%. By sliding the switch downwards, the number 230 will appear. The instrument can now be used with line voltages of 230VAC \pm 10%. Prior to powering on the ohmmeter it is important to verify that the switch is set for the correct line voltage.



Selecting the incorrect line voltage setting may cause damage to the instrument!

Fuse Holder

The line power fuse must match the line voltage selection as follows:

- 105-125VAC – 3A SLO-BLO
- 210-250VAC – 1.5A SLO-BLO

The fuse holder is located on the rear panel (see Figure 1). To install a fuse, first disconnect the Ohmmeter's power cord. Insert one end of the fuse into the fuse cap. Insert the fuse cap into the fuse holder. With a small flathead screwdriver, push in on the fuse cap and rotate it clockwise.



Replace blown fuses with their exact equivalent only!

Power Connector

The 3-prong power connector on the rear panel of the ohmmeter is for the application of AC power to the instrument. The mating power cord is included with the instrument at time of purchase. Refer to Chapter 1 for available voltages and safety precautions.

HLC Relay Terminal

The HLC relay terminal is internally wired to three relays which are active only when the HLC mode is selected. According to the result of the comparison, one of the relays will have its contacts closed while the remaining two relays will have contacts open. The standard "relay contact closure" feature allows an automated sorting process to be set up at an economical cost. The screw type terminal allows connections to wires or spade lugs. Contacts are rated at 100V, 100mA. The truth table of the contacts is located in Chapter 4.

Figure 15 – HI-LO Comparator Relay Pins

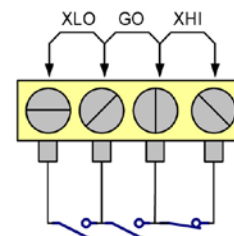

RS-232 Connector

The RS-232 serial interfacing is done through the 9 pin female D-Sub connector located on the rear panel of the instrument. Knowledge of the specific pin functions of the serial connector may be necessary for certain applications; Table 5 lists the pin assignment for the RS-232 connector.

Pin #	Pin Function
1	No connection
2	Receive Data (RxD) (input)
3	Transmit Data (TxD) (output)
4	No connection
5	Signal Ground (GND)
6	No connection
7	No connection
8	No connection
9	No connection

Table 5 – RS-232 Pin out

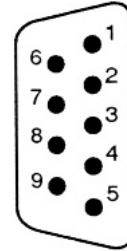

Figure 16 – 9 Pin RS-232 Connector

APPLYING POWER

Before applying power, please refer to Chapter 1 for safety precautions.

Turn on the ohmmeter by placing the front panel power switch in the ON position. If the ohmmeter does not turn on, verify that the instrument is connected to the power line. If line power is not the problem, remove the power cord and check the line power fuse and the line voltage selection switch settings.

POWER-ON DEFAULT SETTINGS

Figure 17 – Display Power-Up Messages

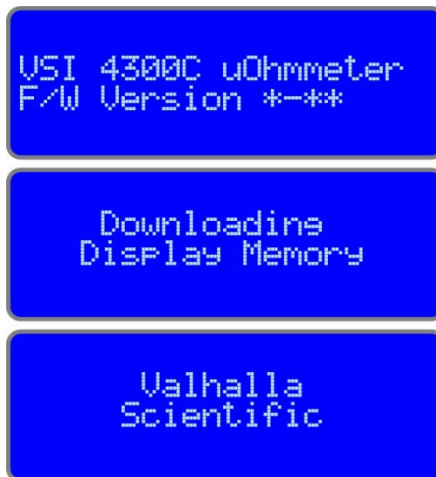

Once on, the ohmmeter performs its power-on routine. On the display you should see the messages in Figure 17.

When the power-on routine is finished, the ohmmeter will beep twice.

The power-on routine will default the ohmmeter's functions as described in the following table.

Functions	Setting
Standard Measurement Mode	ON
Voltage Setting	2V
Range	20kΩ
TCM (Temperature Compensation Mode)	OFF
HLC (Hi-Lo Comparator Mode)	OFF
BCD (binary Coded Decimal Output)	OFF
PIM (Printer/Log Mode)	OFF

Table 6 - Power-Up Defaults

CONNECTING A LOAD TO THE 4300C

The next step in using the ohmmeter is to connect to a load. Valhalla Scientific, Inc. offers a number of different test leads that can be used with the Model 4300C and other Valhalla ohmmeter models (see Chapter 5 for a list of available test leads).

All ohmmeter test leads are composed of a pair of leads, both terminated in a multi-stacking dual banana plug. It is important to notice the position of the ground marker on the plug. Marked side of each banana jack is connected to the **source** terminals.

- Connect the first lead between the SENCE HI and SOURCE HI terminals, with the ground marker on the source side.
- Connect the second lead between the SENCE LO and SOURCE LO terminals, with the ground marker on the source side.

This configuration ensures that current source is carried in the largest conductor of the cable, and that the sense input is shielded.

The opposite end of the lead may vary in style of termination. Here is a description of the three most common terminations used.

Figure 18 – Alligator Type clips



The most common termination is alligator type clips (Figure 18).

If this is your choice of leads, simply connect one clip to one end of your load and the other clip to the opposite side of the load.

Figure 19 – Surface Type clips

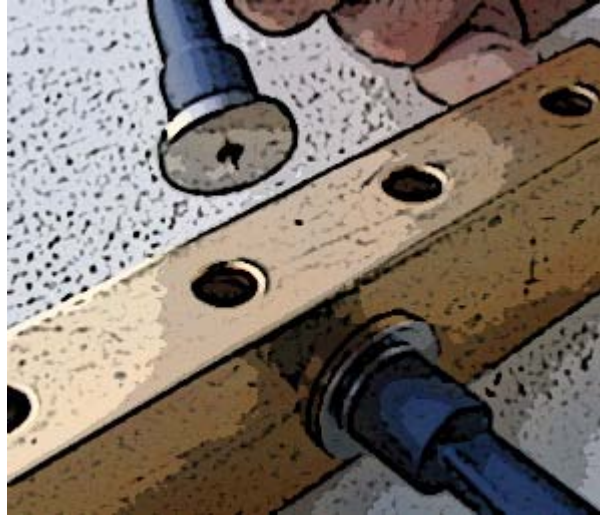

For flat surfaces, you can use between two different spring loaded surface probes.

If this is your choice of leads, simply press one probe against one side of the surface of your load, making sure that the surface of the probe is in full contact with the surface of the load. Press the second probe against the surface at the opposite side of your load making sure that the surface of the probe is in full contact with the surface of the load.

Figure 20 – Dual Needle type probes



For hard to reach surfaces, Valhalla Scientific offers three different sets of spring loaded dual needle probes that differentiate in overall size and distance between the needles.

If this is your choice of leads, simply press both the needles of one probe against one end of the surface of your load, press both needles of the second probe against the surface at the opposite end of your load.

TAKING STANDARD MEASUREMENTS

To make a measurement, select to proper range and engage the Test Current. Always be sure to disengage the Test Current after each measurement or before disconnecting the load and/or leads from the instrument.

Setting the Range

The 4300C has 3 voltage settings and 6 current ranges. The combination of the two result in 16 possible resistance measurement ranges. (See table 7).

Table 7 –
Range Selection Table

	Voltage Setting		
	20mV	200mV	2V
10A	1) 2mΩ	7) 20mΩ	13) 200mΩ
1A	2) 20mΩ	8) 200mΩ	14) 2Ω
.1A	3) 200mΩ	9) 2Ω	15) 20Ω
10mA	4) 2Ω	10) 20Ω	16) 200Ω
1mA	5) 20Ω	11) 200Ω	17) 2kΩ
.1mA	6) 200Ω	12) 2kΩ	18) 20kΩ

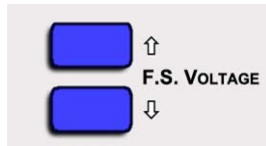

Figure 21 - Voltage Setting

The two keys labeled **F.S. Voltage** are used to change the voltage setting. The \uparrow key is used to increase the voltage setting and the \downarrow key is used to decrease the setting.

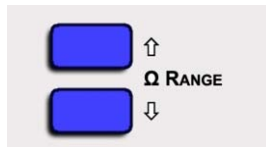

Figure 22 - Ohms Setting

Within a voltage setting there are six possible Ohm Ranges. The two keys labeled **Ω Range** are used switch between the ranges. The \uparrow key is used to increase the range and the \downarrow key is used to decrease the range. As the Ohms range increases, the current range decreases and vice versa.

Test Current



Figure 23 – Test Current

To engage or disengage the Test Current press the **Test Current** key located on the front panel. A red LED within the Test Current key indicates the status of the current source.

The current source may also be turned on and off via a command from one of the interfaces, or by a remote footswitch using Option "RS".

Charging Inductor Mode

The Charging Inductor mode LED indicates when the standard current source compliance voltage of 7V is exceeded. In this situation the 4300C provides a booster shot in excess of 20V to reduce the settling time when a large inductive load is being measured. The display readings should be ignored when this LED is illuminated.

Cable Disconnect Status Indicators

The SAFE and UNSAFE LED's indicate whether or not it is safe to disconnect the test leads from the load. When a highly inductive load is being measured, a potentially lethal back-EMF is induced when the test current is removed. The 4300C provides a discharge path for this back-EMF and monitors the voltage. The SAFE LED is illuminated when the back-EMF is less than five volts.

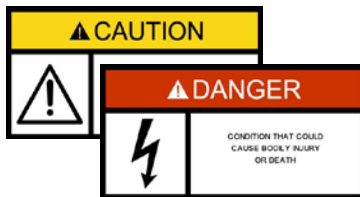

Although the 4300C is protected against up to 500A of inductive kickback, it is not advisable to remove test leads with the Test Current On, or with the UNSAFE LED lit. In some extreme applications if leads are removed or pulled loose before the SAFE LED is lit, damage may occur to the 4300C and/or injury to the operator!

The UNSAFE LED is also illuminated whenever a test current of .1A or greater is selected and the Test Current is turned ON, regardless of the load.

The main characteristic of the 4300C is the 4-wire resistance measurements. In addition to standard measurements, the 4300C includes the TCM and HLC modes. These features may significantly ease time and cost of temperature sensitive and automated selection applications.

STANDARD MEASUREMENT MODE

In the standard measurement mode, the instrument simply measures the value of the applied load using a 4-wire configuration. This configuration eliminates errors normally caused by test lead and contact resistances. In many applications the contact resistance can exceed the value of the load by several orders of magnitude. The 4300C bypasses this potential error source by providing two terminals of constant current and an additional two terminals for high impedance voltage measurement. The result is a fast, accurate resistance measurement of the load, independent of the resistance of the current carrying leads.

“TCM” - TEMPERATURE COMPENSATED MEASUREMENT MODE

Valhalla Engineers are pioneers in the technology of accurate measuring devices using recognized formulas that compensate for measurement inaccuracies as a result of environmental changes. The TCM feature simulates a constant ambient temperature chamber for materials which are normally subject to varying ambient temperatures. When in the TCM mode, the temperature sensor (Omni Compensator), automatically senses the ambient temperature and compensates the reading to indicate what the actual resistance value should be in a controlled environment (usually 20°C). The compensated value is calculated with the following equation:

$$\frac{\Delta R}{R_0} = \alpha \Delta T$$

The variation of resistance (ΔR) divided by the initial resistance (R_0), is equal to the temperature coefficient of the material (α) multiplied by the variation of temperature (ΔT).

Expressed in terms of the resistance:

$$\frac{R - R_0}{R_0} = \alpha(T - T_0) \quad \text{or} \quad R = R_0[1 + \alpha(T - T_0)]$$

To better understand our uses of the equation, we will now express it in terms of our application.

$$R_M = R_C[1 + \alpha(T_A - T_R)]$$

Where R_C is the compensated value, R_M is the measured resistance, T_A is the ambient temperature and T_R is the temperature reference. The compensated resistance is therefore calculated as follows:

$$R_C = \frac{R_M}{1 + \alpha(T_A - T_R)}$$

The user can select from a list of temperature coefficients and temperature references. The list is based on the most commonly used values. The user can also customize these settings with unique values.

Once the temperature coefficient and the temperature reference are set, the instrument's task is to measure the load resistance and the ambient temperature. After all the variables are determined, the 4300C automatically calculates the compensated resistor value.

Here is an example of the equation.

Let's assume that we are measuring a copper wire, and we wish to know the resistance value at a temperature of 20°C. The temperature coefficient of copper is 0.003931Ω/°C.

If the load measures 1.0000Ω and the ambient temperature is 22.5°C:

$$R_C = \frac{1}{1 + 0.003931(22.5 - 20)} = 0.9903\Omega$$

The value of the load at 20°C would be 0.9903Ω.

Omni Compensator

The 4300C measures the ambient temperature through a removable external sensor, the Omni Compensator. This item does not come standard with the ohmmeter, and must be purchased separately. If the 4300C and the Omni Compensator are purchased at the same time, the pair will be calibrated together. Each instrument should have a dedicated sensor. The user cannot interchange sensors between different ohmmeters without prior calibration. Calibration will also be necessary if the sensor is purchased as a single item. The TCM calibration routine is describe later in the chapter.

Figure 24 – Omni Compensator Temperature Sensor



TCM ON

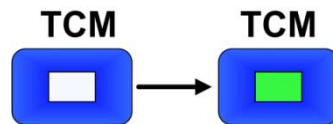

The TCM mode can be selected from the front panel by pressing the TCM function key.

The display will briefly read “TCM ON”. The instrument will continuously notify the user that the TCM mode is active by lighting the green LED within the TCM button.

If the TCM mode is turned ON without an Omni Compensator connected to the instrument, the screen will displays “SENSOR REMOVAL RESTART TCM SYSTEM”. Press “**TCM**” to turn the mode OFF. Check if the Omni Compensator in properly connected to the front panel and turn TCM back ON.

To return to the standard measurement mode, repress the TCM key. The display will briefly read “TCM OFF”.

TCS – Temperature Compensator Setup

As earlier mentioned in this chapter, the 4300C needs to reference a temperature coefficient and a temperature reference to calculate the compensated value. Stored in the instruments memory are six configurations that can be selected. Table 8 illustrates the values associated to each of the configurations.

Table 8 –
TCM Setup Ref. Table

Material	Configuration	Temperature Coefficient	Temperature Reference
Copper	CU20	3931ppmΩ/°C	20°C
	CU25		25°C
Aluminum	AL20	4030ppmΩ/°C	20°C
	AL25		25°C
Gold	AG20	3000ppmΩ/°C	20°C
	AG25		25°C

The following procedure illustrates how to select one of these configurations and how to setup a customized configuration. This procedure does not need to be repeated every time the TCM mode is selected. The configuration that is selected or the custom values inputted will be set as default.

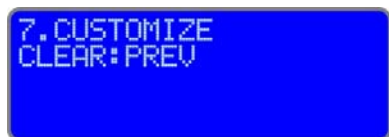

- Press “FUNC. + TCM + 1” to bring up the first selection screen.
- Press the number associated with one of the configurations, and press “ENTER” or go to the next selection screen by pressing “FUNC.”
- Press the number associated with one of the configurations, and press “ENTER” or go to the next selection screen by pressing “FUNC.”. (Press “CLEAR” to return to the previous screen.)
- Press “7 + ENTER” to enter the custom configuration screen. (Press “CLEAR” to return to the previous screen.)
- Using the numeric keys input a value for the temperature coefficient. (Use “CLEAR” as a backspace to correct errors.)
- Press “ENTER” to confirm the value.
- Using the numeric keys input a value for the reference temperature. (Use “CLEAR” as a backspace to correct errors.)
- Press “ENTER” to confirm the value.



- The screen will display the values entered.
- Press “ENTER” to confirm the values or “CLEAR” to return to the previous screen.
- The screen will display a brief message and the instrument will return to the standard measurement mode.

TCC – Temperature Compensator Calibration

This procedure is used to match a 4300C with its Omni Compensator.



- Verify that the instrument is in a temperature controlled area.
- Press “FUNC. + TCM + 2” to initiate the process.
- Connect the Omni Compensator to the TCM receptacle on the front panel of the Ohmmeter.



- Allow the Omni Compensator to reach ambient temperature. (Wait 5 to 10 minute before proceeding.)
- Press “ENTER” to continue.



- Using the numeric keys input a value for the ambient temperature. (Use “Clear” as a backspace to correct errors.)
- Press “ENTER” to confirm the value.
- Press “ENTER” to confirm the value or “CLEAR” to return to the previous screen.
- Once the calibration values are stored, press “TCM” and verify that the temperature displayed matches the ambient temperature. If the values do not match, repeat the procedure.

“HLC” – HI-LO COMPARATOR MODE

Figure 25 - HLC LEDs

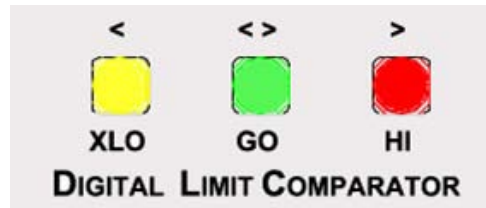

Another useful feature of the 4300C is the Dual Limit Comparator (HLC). This feature helps eliminate operator interpretation of ohmmeter readings. Operator error and fatigue are drastically reduced while significantly increasing testing efficiency.

A common application is receiving inspection of precision resistors by unskilled operators using the HLC mode. If, for example, the resistors to be inspected and tested are $1\text{ k}\Omega \pm 0.1\%$, the 4300C would be set on the $2\text{ k}\Omega$ range; the upper limit would be set at $1.0010\text{ k}\Omega$, and the lower limit to $0.9990\text{ k}\Omega$. If measured resistance is within these limits, the GREEN indicator will remain illuminated, indicating a within tolerance condition. If either RED or the YELLOW indicator is illuminated, that respective limit has been exceeded and the test sample should be rejected.

HLC Relay Terminal

Figure 26 - HLC Relay Pins

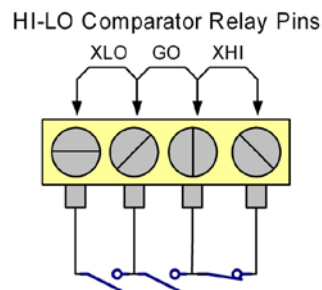

The 4300C provides relay closure outputs which can be used to implement an automated batch sorting system for components or products, operate counters, sound alarms or shut off a process. Resistors, transformers, strain gauges, thermocouples and thermistors are a few items which could be individually tolerated in this manner for matching purposes.

The HLC relay terminal is internally wired to three relays which are active only when the HLC mode is selected. According to the result of the comparison, one of the relays will have its contacts closed while the remaining two relays will have contacts open. The standard "relay contact closure" feature allows an automated sorting process to be set up at an economical cost. The screw type terminal allows connections to wires or spade lugs. Contacts are rated at 100V, 100mA. Truth table of the contacts is listed in Table 9. Ω 's symbol represents the load measured value, UL is the upper limit and LL is the lower limit set by the user.

Table 9 – HLC Truth Table

HLC State	HLC Result	XLO	GO	XHI
ON	$LL \leq \Omega \leq UL$	OPEN	CLOSED	OPEN
ON	$\Omega < LL$	CLOSED	OPEN	OPEN
ON	$UL < \Omega$	OPEN	OPEN	CLOSED
OFF	X	OPEN	OPEN	OPEN
OFF	X	OPEN	OPEN	OPEN
OFF	X	OPEN	OPEN	OPEN

Setting the Limits

Each range has a different set of limits that can be programmed by the user. Table 10 lists the default values programmed for each range. Once the user sets new values, the default settings will be overwritten and the user settings will be stored in memory.

Table 10 – HLC Default Limits

Range	Lower Limit	Upper Limit
2mΩ	1.0000mΩ	2.0000mΩ
20mΩ	10.000mΩ	20.000mΩ
200mΩ	100.00mΩ	200.00mΩ
2Ω	1.0000Ω	2.0000Ω
20Ω	10.000Ω	20.000Ω
200Ω	100.00Ω	200.00Ω
2kΩ	1.0000kΩ	2.0000kΩ
20kΩ	10.000kΩ	20.000kΩ

To set your custom readings, simply select the range that better fits your load and follow this procedure.

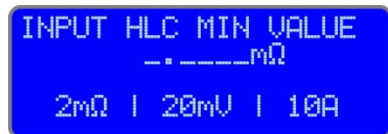
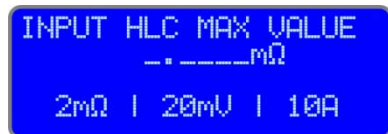

- Press **“Func. + HLC”** to bring-up the first input screen.
- Using the numeric keys input a value for the upper limit. (Use **“CLEAR”** as a backspace to correct errors.)
- Press **“ENTER”** to continue.
- Using the numeric keys input a value for the lower limit. (Use **“CLEAR”** as a backspace to correct errors.)
- Press **“ENTER”** to continue.
- The screen will display a brief message and the instrument will return to the standard measurement mode.

HLC ON

To start working with the HLC mode, simply select the correct range for your load and press the **“HLC”**. The screen will briefly display **“HLC ON”**. The instrument will also perform an LED check-sequence. Make sure that all three of the HLC LEDs illuminate. After the LED check-sequence, only one of the three HLC LEDs will remain illuminated.

It is always good practice to check if the limits set for the range in use meet your specifications. To view the set limits:



- press **“VIEW+ HLC”**
- The screen will display the both the upper and lower limit set for that range.

UPDATE FUNCTION

The Update function is designed to allow the user to set the display update rate and the display intensity. The user can choose from a list of five possible display update rates and eight levels of display intensities.

Display Update Rate

The display update rate indicates the time interval in-between every display update. Table 11 lists these values and the equivalent in updates per second.

Table 11 – HLC Truth Table

	Display Update Rate	Display Updates/second
.1s	100msec	10
.2s	200msec	5
.3s	300msec	3.3
.4s	400msec	2.5
.5s	500msec	2

Display Intensity

The intensity of the display is broken down into 8 levels, where level 1 is the least intense and level 8 is the most intense.

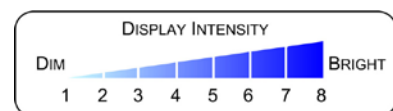

Setting the Display Update Rate and Intensity

To change the display update rate and the display intensity:

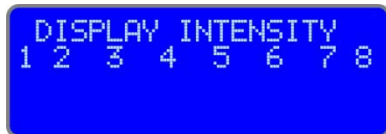
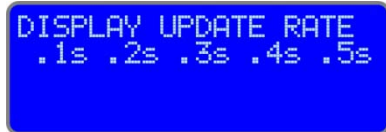
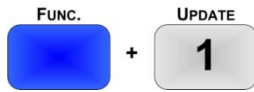

- Press **"FUNC. + UPDATE"**
- Select an update rate using the numerical keys from 1 thru 5 and press **"ENTER"**.
- Select an intensity level using the numerical keys from 1 thru 8 and press **"ENTER"**.
- The screen will display a brief message. The values are stored in memory and the instrument automatically returns to the previous mode.

RUN/HOLD FUNCTION

The Run/Hold function of the 4300C can be configured in three different ways:

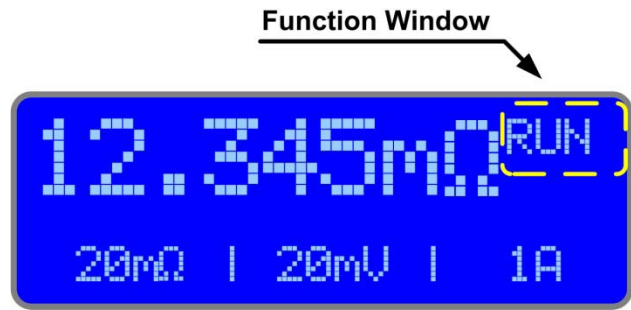

Figure 27 – Display Function Window

RUN/HOLD



- When configured for Run/Hold, pressing the “**Run/Hold**” key will freeze the readings on the display. The function window displays “HOLD”. To exit the hold state, press “**Run/Hold**” again, the function window displays “RUN”.

RUN/PKHI



When configured for Run/PeakHi, pressing the “**Run/Hold**” key will activate the Peak-Hi state, the readings on the display will only increment therefore showing the maximum value measured. The function window displays “PKHI”. To exit the PKHI state, press “**Run/Hold**” again, the function window displays “RUN”.

RUN/PKLO



When configured for Run/PeakLo, pressing the “**Run/Hold**” key will activate the Peak-Lo state, the readings on the display will only decrease therefore showing the lowest value measured. The function window displays “PKLO”. To exit the PKLO state, press “**Run/Hold**” again, the function window displays “RUN”.

Configuring the Run/Hold Function

To configure the Run/Hold function:



- Press “**Func. + Run/Hold**”
- Select one of the three options by pressing keys 1, 2, or 3 and press “**Enter**”.
- The screen will display a brief message, the selection is stored in memory and the instrument automatically returns to the previous mode.

PRINT/LOG FUNCTION

The Print/Log function allows the user to receive the measurements through the instrument's RS-232 or USB interface. A thermal printer/labeler or the HyperTerminal of a PC can be used to capture the readings. The measurements can also be log to an Excel spreadsheet by using a Data Sources Open Database Connectivity (ODBC) to access data from ohmmeter

The Print/Log function can be configured in three different ways:

PRINT

When configured for Print, pressing the **"PRINT"** key transmits one reading as it is displayed on the ohmmeter's screen.

LOG

When configured for Log, pressing the **"PRINT"** key continuously transmits the measurements at a rate equal to the display update rate¹. Pressing the print key once again will terminate the transmission. The measurements are transmitted in the same format in which they are displayed on the ohmmeter's screen.

LOG2

When configured for Log, pressing the **"PRINT"** key continuously transmits the measurements at a rate equal to the display update rate¹. Pressing the print key once again will terminate the transmission. The measurements are transmitted in engineering format.

For example:

$$10.000k\Omega = 1.00E + 04$$

¹ See Display Update Rate page 4-8

Configuring the Print button function

To configure the Print/Log function:

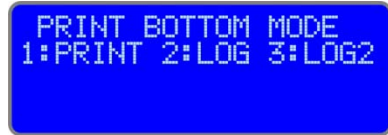
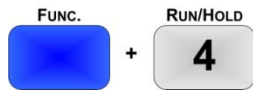





- Press **"FUNC. + PRINT"**
- Select one of the three options by pressing keys 1, 2, or 3 and press **"ENTER"**.
- The screen will display a brief message, the selection is stored in memory and the instrument automatically returns to the previous mode.

VIEW FUNCTION

The View function allows the user to view how the instrument's functions are configured. This function is easy to use and is very useful especially for HLC and TCM users.

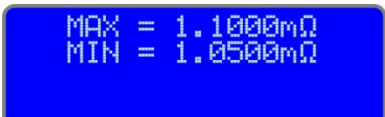
Using the View function

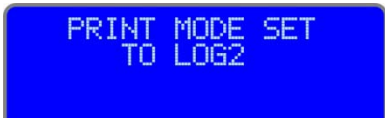
Press "**VIEW**" followed by one of the following keys:

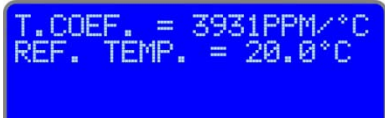
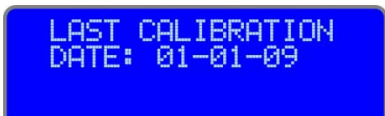
<p>UPDATE 1</p>		<p>UPDATE - The screen shows the display update rate and intensity settings.</p>
<p>HLC 2</p>		<p>HLC - The screen displays the HLC limits for the range that is selected at the time. In this mode, the user can switch through the ranges to view all the values set as limits.</p>
<p>RUN/HOLD 4</p>		<p>RUN/HOLD - The screen will display the configuration of the "RUN/HOLD" key.</p>
<p>PRINT 5</p>		<p>PRINT - The screen will display the configuration of the "PRINT/LOG" feature.</p>
<p>TCM </p>		<p>TCM - The screen will display the temperature coefficient and temperature reference value set for the TCM mode.</p>
<p>CAL 8</p>		<p>CAL - The screen displays the date of the last calibration. This is update from the interface.</p>

To exit the view function press "**VIEW**".

The 4300C μ -Ohmmeters are shipped with a detachable power cord, and an Operation Manual as standard equipment. This section lists several items that may be desirable for special applications.

OPTIONS

BCD: Data Output

This option provides parallel BCD data on a rear-panel 50-pin connector. All outputs are TTL compatible levels with a drive capability of 1 LS load. Also refer to Chapter 6 *Remote Operations – BCD Interface*.

GPIB

The Valhalla 4300C comes standard with a RS-232 interface. Also available is an optional GPIB IEEE-488.2 compatible interface. The interface is talk/listen, and provides range and ohmmeter function control. Also refer to Chapter 6 *Remote Operations – IEEE Interface*.

USB

Another interface that is available is USB. The interface is talk/listen, and provides range and ohmmeter function control. Drivers are provided.

ACCESSORIES

Omni Compensator

To be able to use the TCM feature of the 4300C, the user will need an Omni Compensator temperature sensor. This item allows the ohmmeter to compensate for temperature variations when testing any material.



Figure 28 –Omni Compensator

Option RX-3: Rack Mount Adapter

The 4300C μ -ohmmeters may be mounted in a standard 19" equipment rack using a set of optional rack ears. Option RX-3 comes with all the necessary hardware for installation and mounting. An assembly diagram on how to install to rack ears on to the instrument can be found in Chapter 1.

TEST LEADS

This section details the different test lead sets and connectors available for use with the 4300C μ -ohmmeters. All cables and test leads are manufactured by Valhalla Scientific Inc. and are tested before shipping.

Alligator Clip Type Leads

Option K: Kelvin Lead Set

Option "K" is a shielded, 4-wire Kelvin cable set, 48 inches in length terminated in gold plated alligator clips (*Option-KCS*). Option "K" is the recommended general purpose lead set for most applications.

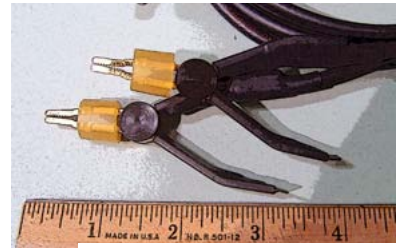

Figure 29 – "K" Kelvin Lead Set

Option KCS: Gold-Plated Clips

Option "KCS" are gold-plated alligator clips used on the Option "K" lead set for 4-wire measurements of smaller components and leads. Clips open to 1/2 inch and accommodate test currents of up to 10A.

Option KK: Heavy-Duty Lead Set

Option "KK" is a 4-wire Kelvin cable set, 48-inches in length terminated in heavy-duty gold-plated clamps (*Option-JAWS*).

Option JAWS: Gold-Plated Clamps

Option "JAWS" are gold-plated heavy-duty clamps used to terminate Option "KK" lead set. Clamps open to 2 inches for connection to large motors, bushings, etc.



Figure 30 – "KK" Heavy Duty Lead Set

Option C: Banana-to-Clip Cable

Option "C" is a 48" general purpose shielded lead set terminated on one end in dual banana plugs and on the other end in red and black alligator clips.



Figure 31 – "C" Banana/Clip Cable

Needle Type Probes

Option MP-1: Kelvin Micro-Probes

Option "MP-1" is a 48-inch shielded 4-wire Kelvin cable set with a 1A test current capacity employing a set of Kelvin Micro-Probes. The probes are equipped with spring-loaded stainless steel tips with 0.05" spacing.



Figure 32 – "MP-1" Micro Probes

Option MP-2: Kelvin Mini-Probes

Option "MP-2" is a 48-inch shielded 4-wire Kelvin cable set with a 1A test current capacity employing a set of Kelvin Mini-Probes. The probes are equipped with spring-loaded stainless steel tips with 0.18" spacing.



Figure 33 – "MP-2" Mini Probes

Option MP-S: Single Pointed Probe Set

Option "MP-S" is a 48-inch shielded cable set with a 1A test current capacity employing a set of single pointed handheld pencil type probes. (2 wires to each point)

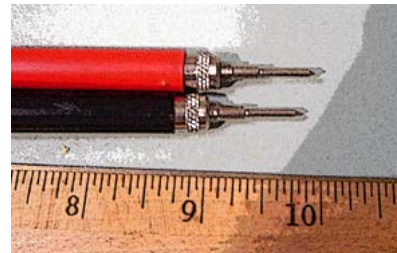

Figure 34 - "MP-S" Single Pointed Probes

Surface Probes

Option MP-4: Surface Probes

These probes permit rapid, repeatable bonding testing on a variety of screened or flat surfaces. Test current is evenly distributed through the probe base while sensing is accomplished via a spring loaded center contact. The target area is 1-inch in diameter.



Figure 35 – “MP-4” Surface Probes

Option MP-5: Surface Probes

These probes permit rapid, repeatable bonding testing on a variety of screened or flat surfaces. Test current is evenly distributed through the probe base while sensing is accomplished via a spring loaded center contact. The target area is ½ inch in diameter.



Figure 36 – “MP-5” Surface Probes

Other Lead Sets

Option BBL: Banana-to-Banana Cable

Option "BBL" is a 48" shielded cable terminated on both ends in dual stacking banana plugs. This cable may be used for voltage and current connections to the ohmmeter.

Option SL-48: Low Thermal Leads

Option "SL-48" is a 48" shielded lead set terminated in gold-plated spade lugs. This lead set is designed to eliminate problems caused by thermal EMF's and is rated for the maximum output current of 1A.



Figure 37 – “SL-48” Low Thermal Leads

IEEE INTERFACE**THE PURPOSE OF IEEE STANDARD 488**

The purpose of the IEEE Standard 488 is to allow for interconnection of programmable instruments with minimum engineering. The intent is to remove the need for adapters and the numerous types of patching cables often encountered with other forms of interfaces. The IEEE-488 standard defines a system configuration for programmable instruments such as calculators, voltmeters and other types of peripheral devices produced by various manufacturers. It provides a set of rules for establishing defined communication links with a high degree of compatibility yet maintaining flexibility between independently manufactured products.

DEFINITIONS

Listed below are definitions of the terms used to describe the IEEE-488 interface:

Bus: A data link which is usually a set of several parallel wires within a multi-wire cable.

Bi-Directional Bus: A "highway" used for two-way communication, with input and output data being carried on the same lines.

Bit-Parallel: A data transmission method in which all of the bits composing an item of data are present simultaneously on a group of wires in a bus.

Byte: A group of eight data bits which is treated as a single item of data.

Byte-Serial: A data transmission method in which information, in bit-parallel bytes, is transferred sequentially between devices.

Device Dependent Message: A message containing commands or data intended for a specific device.

Handshake: An exchange of signals between two devices which is used to control the transfer of data between them.

Interface: The part of an instrument or system which enables it to be connected to another via a bus.

Interface Message: A message intended for interface management.

Local Operation: Operation of a device by its front panel controls (also referred to as Manual Control).

Remote Operation: Operation of device under the control of another via the bus.

BUS RESTRICTIONS

The IEEE-488 Interfacing Standard (also known as IEC DTC66 (WG3), ANSI MC1-1, GPIB, HP-IB, etc.), defines a bidirectional bus for interconnecting programmable instrumentation in a bit-parallel, byte-serial fashion. It defines limitations as follows:

1. A maximum of 15 devices may be interconnected by a single bus.
2. The total bus length may not exceed 20 meters, with a maximum interconnection length of 4 meters.
3. Maximum transmission rate is 1 megabyte per second.
4. All bus data is digital.

Of the devices on the bus, only one may be the controller which exercises control over all other devices, and is also capable of operating as a talker or listener. The other devices may be listeners (only able to receive data) or talkers (only able to send data), or both. The model 4300C is capable of talking and listening. The controller may address other devices and command them to listen or talk. Only one device may talk at any one time.

The interconnecting cable consists of sixteen signal wires and eight ground returns linking devices into a complete system:

1. Eight data wires (DIO-0 thru DIO-7)
2. Five management wires (ATN, EOI, SRQ, IFC, and REN)
3. Three "handshake" wires (DAV, NRFD and NDAC)

Each cable connector is a plug/socket combination to permit "daisy-chaining" of units. It should be noted that these wires use "inverse logic". That is to say that a low level indicates the true (asserted) state and a high level indicates a false (non-asserted) state.

DETAILED DESCRIPTIONS OF BUS OPERATIONS

The five management wires are described as follows:

- ATN:** Asserted by the controller whenever an address or a command is present on the bus.
- EOI:** May be asserted by the controller or any talker. With ATN true, EOI indicates that the controller is polling devices. With ATN false, EOI is asserted by the talker to indicate the end of data.
- SRQ:** May be asserted by any device. This indicates that the device requires attention (e.g., a fault has occurred). Normally, the controller will respond by polling to determine which device requires service.
- IFC:** May be asserted only by the controller. This line initializes the bus to a reset state.
- REN:** May be asserted only by the controller. This signal places the addressed device into the remote mode.

The three handshake wires are described as follows:

- DAV:** May be asserted by any talker; indicates that a valid data byte is present on the data wires.
- NRFD:** May be asserted by any listener. Indicates that the listener is not ready to receive data.
- NDAC:** May be asserted by any listener. Indicates that the listener has not yet finished reading the data byte.

The transfer of data on the bus is controlled by these three handshake wires. It is important to note that the drivers for the handshake wires are all connected for wired-on operation. That is, as long as any of the devices on the bus asserts a handshake line, it will remain true. There must be a complete consensus among the devices for any handshake wire to be high (false).

The talker first waits for all devices to be ready to accept data (checks that NRFD is false) then puts one byte of data on the bus and asserts DAV. It waits for all devices to indicate that the data has been accepted

(that is, NDAC to become false) before starting to transfer the next byte of data. This handshake protocol assures that data on the bus is transferred at the speed of the slowest device on the bus.

Data is sent in 8-bit bytes on the DIO wires, usually (as in the 4300C) using the ISO-7 standard ASCII characters. Table 12 lists each ASCII character and the bus messages applicable to each.

ISO BIT & DIO LINE NUMBER	0		1		2		3		4		5		6		7		← COLUMN ROW ↓
	7	6	5	4	3	2	1	0	7	6	5	4	3	2	1	0	
0 0 0 0	NUL		DEL		SP	00	0	16	@	00	P	16	.		p		0
0 0 0 1	SOH	GTI	DC1	LLO	!	01	1	17	A	01	Q	17	a		q		1
0 0 1 0	STX		DC2		"	02	2	18	B	02	R	18	b		r		2
0 0 1 1	ETX		DC3		#	03	3	19	C	03	S	19	c		s		3
0 1 0 0	EOT	SDC	DC4	DCI	\$	04	4	20	D	04	T	20	d		t		4
0 1 0 1	ENQ	PCC ¹	NAK	PPU	%	05	5	21	E	05	U	21	e		u		5
0 1 1 0	ACK		SYN		&	06	6	22	F	06	V	22	f		v		6
0 1 1 1	BEL		ETB		'	07	7	23	G	07	W	23	g		w		7
1 0 0 0	BS	GET	CAN	SPE	(08	8	24	H	08	X	24	h		x		8
1 0 0 1	HT	TCT	EM	SPD)	09	9	25	I	09	Y	25	i		y		9
1 0 1 0	LF		SUB		*	10	:	26	J	10	Z	26	j		z		10
1 0 1 1	VT		ESC		+	11	;	27	K	11	[27	k		{		11
1 1 0 0	FF		FS		,	12	<	28	L	12	\	28	l				12
1 1 0 1	CR		GS		-	13	=	29	M	13]	29	m		}		13
1 1 1 0	SO		RS		.	14	>	30	N	14	^	30	n		~		14
1 1 1 1	SI		US		/	15	?	UNL	O	15	_	UNT	o		DEL		15
		ADDRESSED COMMAND GROUP (ACG)		UNIVERSAL COMMAND GROUP (UCG)		LISTEN ADDRESS GROUP (LAG)				TALK ADDRESS GROUP (TAG)							
PRIMARY COMMAND GROUP (PCG)												SECONDARY COMMAND GROUP (SCG)					

Table 12 - ASCII Character Codes

- Notes:
- 1 Devices Address messages shown in decimal
 - 2 Messages codes are:

DCI	Device Clear	LLO	Local Lockout	SDC	Selected Device Clear
GET	Device Trigger	PPC	Parallel Poll Configure	SPD	Serial Poll Disable
GTI	Go to Local	PPU	Parallel Poll Unconfigure	SPE	Serial Port Enable

Note that the table is divided into two main groups; the primary command group and the secondary command group. The secondary command group is not utilized in the 4300C.

¹ Requires Secondary Command

The primary command group is further divided into four subgroups as follows:

1. **Addressed Command Group** - applied only to addressed devices.
2. **Universal Command Group** - applied to all devices.
3. **Listen Address Group** - set of device listen addresses.
4. **Talk Address Group** - set of device talk addresses.

Data in the above command groups is sent with ATN "true". These type of commands are understood by all devices using the IEEE-488 standard. When data is sent with ATN "false", it is referred to as a *device dependent* command. A device dependent command is specific to a particular device, and may or may not be understood by other devices.

SETTING THE IEEE ADDRESS

The IEEE "address" is the method by which the system controller distinguishes one device on the bus from another. The address of the 4300C is determined by the setting of a binary-weighted switch on the rear of the instrument. Here are two examples to help you set the address.

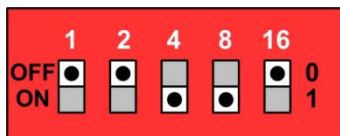

Example 1: Switches 1, 2, and 16 are OFF (or 0) and switches 4 and 8 are ON (or 1).

The resulting address is:

$$(1 \times 0) + (2 \times 0) + (4 \times 1) + (8 \times 1) + (16 \times 0) = 4 + 8 = 12$$

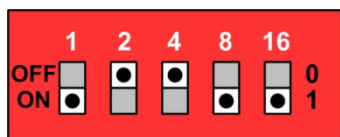

Example 2: Switches 2 and 4 are OFF (or 0) and switches 1, 8, and 16 are ON (or 1).

The resulting address is:

$$(1 \times 1) + (2 \times 0) + (4 \times 0) + (8 \times 1) + (16 \times 1) = 1 + 8 + 16 = 25$$

The address you choose is entirely dependent on your application and by the type and quantity of devices on your IEEE bus. Some guidelines to follow are:

1. Each device on the bus must have its own unique address. Operating two devices at the same address will produce undefined results and is not recommended.
2. Avoid setting the 4300C to address 0 (all switches off) or to address 31 (all switches on) as this may interfere with the system controller.
3. If the setting of the switches is changed, power must be cycled in order to place the new address into memory.

Note: In all future examples, we will assume that the address is set to "12".

REMOTE AND LOCAL STATES

Local State

When the 4300C is in the "local" state the REMOTE indicator on the front panel is extinguished and full manual control as described in Chapters 3 and 4 may be performed. The user should also note that the 4300C will ignore commands from the GPIB while in the local state.

The 4300C automatically powers-up in the local state. Other methods for placing it in the local state are by cycling power or by sending a return to local (RTL) command over the bus. This is done in HP Basic using the command: LOCAL 712

To ensure compatibility with all controllers, the 4300C may also be returned to the local state by sending it the code: L

Remote State

In this state the REMOTE indicator on the front panel is illuminated and all controls on the front panel are disabled except the power switch.

The remote state may only be entered via the bus. If the 4300C receives its listen address while the REN line is asserted, it will enter the remote state. Placing the instrument into remote is an easy way of verifying that all connections and address selections have been done properly. This may be accomplished in HP Basic using the command: REMOTE 712 The 4300C should enter the remote state and illuminate the REMOTE indicator. Verify that no other device on the bus was affected by execution of this command.

READING THE DISPLAY DATA

The resistance data on the 4300C's display is always available to be read by the system controller. The 4300C does not require that a query or any other command be issued in order to retrieve it. Also, the 4300C does not need to be in REMOTE in order for the display to be read. Retrieving the data will clear the reading buffer. The controller must then wait until the next update of the A-to-D converter before a new value becomes available. Data may be read at the rate of 2½ readings per second for a 4300C.

The fact that the readings are always available simplifies measurement retrieval. Every time the system controller polls the 4300C's address, an instantaneous resistance value is returned corresponding to the displayed value.

The following program shows an example of retrieving a resistance measurement from the 4300C. The program is written in HP Basic. If you are using a programming language or package other than HP Basic, consult your

Programmer's Manual for the correct command syntax. The 4300C is assumed to be at address 12.

```
10   ENTER 712;A$
20   PRINT A$
30   GOTO 10
40   END
```

The execution of this program results in a continuous display of the resistance measurement, updated at the conversion rate of the instrument's A-to-D converter.

The result is returned in scientific notation, in ohms. As an example, assume that the 4300C is in the 2V and .1mA ranges and the front panel display indicates "10567" which is 10,567Ω. The program above is executed.

The 4300C responds with the following number (contained in A\$):

```
+1.0567E+4
```

This is the measurement in scientific notation, in ohms. The "E" signifies a power of 10^4 , or 10000. This means that the significant digits of the response should be multiplied by 10000.

In another example, assume that the 4300C is in the 20mV and 10A ranges, and the front panel display indicates "1.9095" which is equal to 1.9095mΩ. The program is executed.

The 4300C responds with the following number (contained in A\$):

```
+1.9095E-3
```

This is the measurement in scientific notation, in ohms. The "E" signifies a power of 10^{-3} , or 0.001. This means that the significant digits of the response should be multiplied by 0.001.

An over-range condition is indicated by:

```
+2.0000E±?
```

Each response is terminated with an "output data terminator" which is used to signal the end of the transmission to the controller.

The default terminator is a $\text{C}_R \text{L}_F$ (carriage-return and line-feed). The terminator may be changed using the "D" command. Refer to Output Data Terminator section of this chapter.

4300C COMMAND SET FOR GPIB

This section contains a description of all commands that are recognized by the 4300C using its IEEE-488 interface (Option TL-488). As noted earlier in this chapter, the 4300C does not need to be queried in order to retrieve the measured resistance data. The commands listed in this section are used to set ranges, turn the test current on and off, and to setup internal communication protocol.

A condensed listing of the 4300C command set is given in Table 13.

When sending commands to the 4300C, an "input data terminator" must be used to signal the end of the command line. The 4300C recognizes a _ (carriage-return) or EOI asserted with the last character as valid input terminators.

Commands must be sent using upper case characters. Multiple commands may be sent on the same line provided that they are separated by a comma (,).

The following program shows an example of setting the ranges of the 4300C. The program is written in HP Basic. If you are using a programming language or package other than HP Basic, consult your Programmer's Manual for the correct command syntax. The 4300C is assumed to be at address 12.

```
10 REMOTE 712
20 OUTPUT 712;"V2,I3,C1"
30 WAIT 2
40 ENTER 712;A$
50 PRINT A$
60 LOCAL 712
70 END
```

The result of this program is to set the 4300C to the 2V, 100mA ranges and turn on the test current. The controller waits for 2 seconds (for settling), then retrieves the measured value. The 4300C is then returned to local mode.

Voltage Range

The "V" command is used to set the full scale voltage range of the internal voltmeter. The 4300C interprets this command as follows:

V0 - Selects the 20mV range

V1 - Selects the 200mV range

V2 - Selects the 2V range

Test Current Range

The "I" command sets the value of test current that will be used to make the resistance measurement. The 4300C interprets this command as follows:

- I0** - Selects .1mA
- I1** - Selects 1mA
- I2** - Selects 10mA
- I3** - Selects .1A
- I4** - Selects 1A
- I5** - Selects 10A

SRQ's and Serial Polls

The IEEE-488 bus incorporates a serial line that may be used by a device on the bus to alert the controller if problems are encountered or if it requires attention. This method draws attention to a device without disrupting normal bus operation. The controller may then choose to ignore or act upon the request.

The "SRQ" or "service request" line may be asserted to alert the controller. The 4300C may be setup using the "Q" command to assert SRQ if the controller sends data to it that is not decodable by the 4300C.

Q0 - 4300C will not assert SRQ (default)

Q1 - 4300C will assert SRQ if it receives a command that it does not understand

If the SRQ line is asserted, the controller should then perform a serial poll to determine which device requires service. The 4300C will return an ASCII zero (0) in response to a serial poll if it did not generate the SRQ. A non-zero number will be returned if it was responsible for asserting SRQ. A serial poll is performed in HP Basic using the command: **SPOLL(712)** which would poll the device at address 12.

Output Data Terminator

The "D" command determines the type and quantity of terminators that will be used to signal the end of any data that the 4300C returns to the controller. This includes measured resistance data as well as the response to the "configuration status" query. The 4300C interprets this command as follows:

- D0** $\overset{C}{\underset{R}{F}}$ (default)
- D1** $\overset{C}{\underset{R}{F}}$ with EOI asserted
- D2** $\overset{C}{\underset{R}{F}}$
- D3** $\overset{C}{\underset{R}{F}}$ with EOI asserted

The D1 selection is preferred by IEEE-488.2 systems such as National Instruments®.

Test Current Control

The "C" command is used to enable or disable the output of the current source. This command is decoded as follows:

- C0** Turns the test current off
- C1** Turns the test current on

Display Hold

The display of the 4300C may be frozen from the GPIB bus using the commands listed below. While in the "hold" mode the A-to-D converter is still performing measurements, but the results are not sent to the 4300C's display or to the IEEE output buffer. Therefore once a trigger is sent or tracking is resumed, the display will instantly reflect the latest measurement. The 4300C interprets these commands as follows:

- T** selects continuous tracking mode (default)
- S** selects hold mode; also used to trigger a single reading while holding

Temperature Compensation

The automatic temperature compensation mode (TCM) feature of the 4300C may be enabled or disabled from the GPIB. If TCM mode is enabled the readings are automatically adjusted by the temperature sensor attached to the front of the 4300C (refer to Chapter 4).

- N** selects normal mode; TCM off
- A** selects TCM on

Configuration Status Query

This advanced command may be used to verify the results of sending the commands mentioned previously. It may also be used to check for faults in the TCM system or to check the present setting of the manual controls on the front panel.

The charge and discharge of inductive loads may be monitored to determine when valid readings are available and also to check the cable disconnect status indicators.

Upon receiving the code **E** the 4300C will place into its output buffer a "configuration status word". The status word is made available for the next read by the controller. No measurement data is available until this word is read.

The word is in the format:

Q?V?I?SND?C?UHF

Where:

- Q?** reflects the present value of the SRQ command
- V?** reflects the present voltage range setting
- I?** reflects the present test current setting
- S** is the letter "S" if hold mode has been selected, or "T" if tracking mode is selected
- N** is the letter "N" if normal mode has been selected or "A" if TCM is enabled
- D?** reflects the present value of the output data terminator command
- C?** reflects the test current status
- U** is the letter "U" if the 4300C senses that it is UNSAFE to disconnects cables; an ASCII space character indicates SAFE
- H** is the letter "H" if the 4300C's charging inductor mode has been activated; an ASCII space character indicates no charging inductor
- F** is the letter "F" if a fault is detected in the TCM sensing mode; an ASCII space character indicates no faults

Table 13 - IEEE
Commands
Quick Reference

ASCII CODE:		V _x	I _x	Q _x	D _x	C _x
X=	0	20mV	0.1mA	No SRQ	C _R L _F	Test Current OFF
	1	200mV	1mA	SRQ on Input Error	C _R L _F W/EOI	Test Current ON
	2	2V	10mA		C _R	
	3		100mA		C _R W/EOI	
	4		1A			
	5		10A			

- S** Selects hold mode / Triggers single reading
- T** Selects continuous reading mode
- N** Selects normal mode (TCM OFF)
- A** Selects TCM mode ON
- L** Returns 4300C to Local
- E** Configuration Status Word Query
(Q?V?I?SND?C?UHF)

RS-232 INTERFACE

CONNECTING THE 4300C VIA RS232 INTERFACE

The RS232 interface capabilities:

The RS232 interface provides a point-to-point connection between two items of equipment such as a computer and the 4300C. There are some parameters you need to set on both sides. Once you have set these parameters, you can control the 4300C through the RS232 interface.

- Baud rate: 9600 baud.
- Parity bit: none.
- Data bit: 8 bits.
- Stop bit: 1 stop bit.
- Data flow control: none.

Notes for RS232 installation

The 4300C is a DCE (Data Channel Equipment) device with a 9-pin D-type shell RS232 connector located on the rear panel. Table 14 shows the 9-pin connector (Female) with its pin number assignments. When the 4300C is set up with a RS232 interface, please check the following points:

- Many devices require a constant high signal on one or more input pins.
- Ensure that the signal ground of the equipment is connected to the signal ground of the external device.
- Ensure that the chassis ground of the equipment is connected to the chassis ground of the external device.
- Do not use more than 15 meters of cable to connect devices to a PC.
- Ensure the same baud rate is used on the device as the one used on PC terminal.
- Ensure the connector for both sides of cable, and the internal connection lines meet the demands of the instrument.

Table 14 –
RS-232 Connector
Pin Configuration

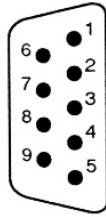

Pin #	Pin Function
1	Not Connected
2	Receive Data (RxD) (input)
3	Transmit Data (TxD) (output)
4	Not Connected
5	Signal Ground (GND)
6	Not Connected
7	Not Connected
8	Not Connected
9	Not Connected

Connecting to a Computer

A personal computer with a COM port is essential in order to operate the 4300C via RS232 interface.

The connections between 4300C and computer are as follows:

- I. Connect one end of a RS232 cable to the computer.
- II. Connect the other end of the cable to the RS232 port on the 4300C.
- III. Turn on the 4300C.
- IV. Turn on the computer.

Checking Connections

If you want to test whether the RS232 connection is working or not, you can send a command from the computer. For instance, using a terminal program send the query command

***idn?**

Should return the Manufacturer, model number, serial number and firmware version in the following format:

VALHALLA SCIENTIFIC 4300C,1.81,0"

If you do not receive a proper response from the 4300C, please check if the power is on, and all cable connections are active.

INPUT AND OUTPUT QUEUE

The design of 64 bytes input queue and 128 bytes output queue for storing the pending commands or return messages is to prevent the transmitted commands of remote control and return messages from missing. As the maximum stored capacity for Error/Event

Queue is 20 groups of messages, it should be noted that input data exceeding the capacity by using these buffers will cause data missing.

COMMANDS AND SYNTAX

RS232 message terminators

As there is no signal of end message on RS232 bus, therefore, use LF, CR, or CR/LF as message terminator. After the 4300C processes a command a CR/LF is placed in the output buffer and delivered. As for query command, the return message of the instrument is also added a LF for PC to judge message terminator.

Entering Commands

The standards that govern the command set for the 4300C allow for a certain amount of flexibility when you enter commands. The 4300C does not adhere to any friendly listening standards so the commands and queries must be typed as specified.

Command Characters

The 4300Cs are not sensitive to the case of command characters. You can enter commands in either uppercase or lowercase.

You can execute any command with preceding white space characters. You must use at least one space between the parameter and the command header. Subsequent parameters are separated by commas.

Combining Commands

You can use a semicolon (;) to combine commands, but not queries.

Example:

RANGE 4; HLCHI 14.999<LF>

Synopsis of Commands

The tables in this section summarize the commands of the programmable 4300C Ohmmeter.

DETAILS OF COMMAND REFERENCE

Each command in this chapter will give a detailed description. The examples of each command will be provided and what query form might return.

Syntax and return values for each are explained in the function header. The “*STB?” gives the status of the command.

Remote mode is entered when a valid printable character is received and is exited with the LOCAL front panel key or LOCAL command.

COMMAND INDEX

*RST COMMAND.....	6-32	IDN? QUERY	6-24
*STB? QUERY	6-33	KEY COMMAND.....	6-25
*TST? QUERY.....	6-34	KEY? QUERY	6-26
BCD COMMAND	6-19	LOCAL COMMAND	6-27
BCD QUERY.....	6-19	LOG COMMAND.....	6-27
CALDATE QUERY	6-20	OHMS? QUERY	6-28
CLS COMMAND	6-20	OPT? QUERY.....	6-28
CNFG COMMAND.....	6-20	RANGE? QUERY.....	6-29
CNFG QUERY	6-20	RDNG? QUERY.....	6-31
CURRENT RANGE COMMAND.....	6-29	RESET COMMAND.....	6-31
CURRENT RANGE COMMANDS.....	6-30	SAVSETUP COMMAND.....	6-32
FAULT COMMAND	6-21	SAVSETUP? QUERY.....	6-32
FAULT QUERY	6-21	SYST:ERR?.....	6-19
HLC COMMAND	6-22	TCM COMMAND	6-34
HLC QUERY	6-22	TCM QUERY.....	6-34
HLCHI COMMAND.....	6-22	TEST CURRENT COMMAND.....	6-30
HLCHI? QUERY.....	6-23	TEST CURRENT QUERY	6-30
HLCLO COMMAND	6-23	VOLTAGE RANGE COMMAND.....	6-28
HLCLO? QUERY	6-23	VOLTAGE RANGE QUERY	6-29

:SYST:ERR?

QUERY Sends the System Error value to the remote host.
Cleared with *CLS<crLf>

Syntax: :SYST:ERR?

Example: :SYST:ERR?<crLf>

Response: 1F<crLf>

Power-on default = 0

BCD COMMAND

Selects BCD mode on or off

Syntax: BCD <ON or OFF>

Example: BCD ON<crLf>
 BCD?<crLf>
 ON<crLf>

Power-on default = OFF

Note: BCD mode on puts the logic level BCD on the rear panel connector and the ranges on the relays outputs. See the BCD Interface section of this chapter for BCD connector pin-outs and relay descriptions.

BCD QUERY

Responds with BCD mode on or off

Syntax: BCD?

Example: BCD?<crLf>
 ON<crLf>

Response: <"ON" or "OFF">

Power-on default = OFF

CALDATE QUERY

Request the last calibration date and technician initials.

Syntax: CALDATE?

Response: "00-00-04 VSI"

Power-on default = "00-00-00 VS####"

***CLS COMMAND**

Sets buffers to power on default.

Syntax: *CLS<crLf>

CNFG COMMAND

Turns on and off system configuration items. Alarms, key beeps, other features.

Syntax: CNFG <item number>, <ON or OFF>

Example: CNFG 1, ON<crLf>
CNFG? 1<crLf>
ON<crLf>

- 1 - Suppress Alarms
- 2 - Suppress Key Beeps

Power-on defaults = OFF

CNFG QUERY

Responds with CNFG mode on or off

Syntax: CNFG?

Example: CNFG? 2<crLf>
ON<crLf>

Response: <"ON" or "OFF">

- 1 - Suppress Alarms
- 2 - Suppress Key Beeps

Power-on defaults = OFF (pleasantly noisy)

FAULT COMMAND

Sets an alarm fault to watch the system react.

Syntax: FAULT <Hexadecimal number>

FAULT_ALARM_NO_FAULT	00	
FAULT_ALARM_OVER_TEMP	01	Internal temperature too high
FAULT_ALARM_CAL_LIMIT	02	Input level for calibration exceeded limit
FAULT_ALARM_TCM	04	Input level for TCM calibration exceeded limits
FAULT_ALARM_CMD_CHAR	08	Unprintable characters received / cmd too long
FAULT_TXBUF_SPACE	10	Low on space in transmit buffer
FAULT_ALARM_TXBUF_FULL	20	Serial transmitter buffer full
FAULT_ALARM_RCVBUF_FULL	40	Serial receiver buffer full
FAULT_ALARM_NVRAM	80	NV RAM fault

Power-on default = 00

FAULT QUERY

Returns the alarm bit mapped byte.

Syntax: FAULT?

Response: 2 digit Hexadecimal number

FAULT_ALARM_NO_FAULT	00	
FAULT_ALARM_OVER_TEMP	01	Internal temperature too high
FAULT_ALARM_CAL_LIMIT	02	Input level for calibration exceeded limit
FAULT_ALARM_TCM	04	Input level for TCM calibration exceeded limits
FAULT_ALARM_CMD_CHAR	08	Unprintable characters received / cmd too long
FAULT_TXBUF_SPACE	10	Low on space in transmit buffer
FAULT_ALARM_TXBUF_FULL	20	Serial transmitter buffer full
FAULT_ALARM_RCVBUF_FULL	40	Serial receiver buffer full
FAULT_ALARM_NVRAM	80	NV RAM fault

Power-on default = 00

HLC COMMAND

Selects HLC mode on or off

Syntax: HLC <ON or OFF>

Example: HLC ON<crLf>
 HLC?<crLf>
 ON<crLf>

Power-on default = OFF

Note: HLC mode on puts the logic level HLC relays on the rear panel connector and the ranges on the relays outputs. See Chapter 4 for HLC relay contact descriptions.

HLC QUERY

Responds with HLC mode on or off

Syntax: HLC?

Example: HLC?<crLf>
 ON<crLf>

Response: <"ON" or "OFF">
Power-on default = OFF

HLCHI COMMAND

Sends the Hi-Lo Comparator High Limit for current range.

Syntax: HLCHI <value>

Where value = 1.0000 for 1 Ω in the 3 Ω range and 100.00 for 100m Ω in the 100m Ω range, and 00.500 for .5k Ω in the 20k Ω range.

This command writes the value to RAM memory only. To store these values in non-volatile memory follow with SAVSETUP. Send RANGE command before sending this command. Must send all 5 digits with leading zeroes.

Power-on default = Depends on range.

HLCHI? QUERY

Reads the Hi-Lo Comparator high value from RAM for range.

Syntax: HLCHI?

Response: Floating (fixed) point Ohm value for current range.

"1.0000" for 1 Ω in the 2 Ω range and 100.00 for 100m Ω in the 200m Ω range.

This command reads the value from RAM memory only. If you have used the HLCHI command to write a HLC value it will be different than the value stored in non-volatile memory if the SAVSETUP command has not been sent.

Power-on default = Depends on range.

HLCLO COMMAND

Sends the Hi-Lo Comparator Low Limit for current range.

Syntax: HLCLO <value>

Where value = 1.0000 for 1 Ω in the 1 Ω range, 100.00 for 100m Ω in the 100m Ω range, 1.000 for 1k in the 1k Ω range.

This command writes the value to RAM memory only. To store these values in non-volatile memory follow with SAVSETUP. Send RANGE command before sending this command.

Power-on default = Depends on range.

HLCLO? QUERY

Reads the Hi-Lo Comparator low value from RAM for range.

Syntax: HLCLO?

Response: Floating (fixed) point Ohm value for current range.

"1.0000" for 1 Ω in the 1 Ω range and 100.00m for 100m Ω in the 100m Ω range, 1.0000k for 1k Ω in the 1k Ω range. This command reads the value from RAM memory only. If you have used the HLCLO command to write a HLC value it will be different than the value stored in non-volatile memory if the SAVSETUP command has not been sent. Send RANGE command before sending this command.

Power-on default = Depends on range.

***IDN? QUERY**

Returns the IEEE or RS-232 identification string from non-volatile.

Syntax: *IDN?<crLf>

Response: ID string "VALHALLA SCIENTIFIC 4300C,1.01G,0"

Example: *IDN?<crLf>
 "VALHALLA SCIENTIFIC 4300C,1.01G,0"<crLf>

ID_STRING	:	"VALHALLA SCIENTIFIC"
VERSION	:	"1.01G"
MODEL	:	"4300C"
HARDWARE_VER	:	"0"
OPTION_STRING	:	"Option(s) : GPIB(IEEE488.2)"

KEY COMMAND

Presses a key from the interface, use for macros when the command you desire is not listed here.

Syntax: KEY <key number>

Response: <crLf> (only after the key has been processed)

Key number = 0 - 24

0	KEY_NO_KEY	19	KEY_1
1	KEY_0	20	KEY_RANGE_1
2	KEY_3	21	KEY_4
3	KEY_CLEAR	22	KEY_RANGE_0
4	KEY_9	23	KEY_7
5	KEY_LOCAL	24	KEY_RANGE_3
6	KEY_RESET		
7	KEY_FUNC	KEY_UPDATE	KEY_1
8	KEY_ENTER	KEY_HLC	KEY_2
9	KEY_DP	KEY_ADDR	KEY_3
10	KEY_RANGE_4	KEY_RUNHOLD	KEY_4
11	KEY_2	KEY_PRINT	KEY_5
12	KEY_RANGE_5	KEY_TCM	KEY_6
13	KEY_5	KEY_AUTO_RNG	KEY_7
14	KEY_RANGE_6	KEY_CAL	KEY_8
15	KEY_8	KEY_BCD	KEY_9
16	KEY_6	KEY_VIEW	KEY_0
17	KEY_NOTUSED	KEY_DISPLAY	KEY_1
18	KEY_RANGE_2	KEY_mk	KEY_DP

Power-on default = 0

Note: The remote key macro command was developed so our customers can literally perform any action from the remote available to the key press enthusiast. This capability is not without restrictions. Illegal key sequences may get the machine in a menu you do not expect or cause the meter to not process properly the keys you send. Key presses are human interface and therefore not buffered.

Because of this key delays may be necessary as sending keys too quickly may lose keys.

KEY? QUERY

Returns the decimal number of the key last key processed by the state machine. This query returns any key in the remote mode even if the key is locked out by remote mode, i.e. KEY_LOCAL is not locked out.

Syntax: KEY?<crLf>
 21<crLf>

Response: Decimal Key value between 0-24, 0 = No key pressed

0	KEY_NO_KEY	19	KEY_1
1	KEY_0	20	KEY_RANGE_1
2	KEY_3	21	KEY_4
3	KEY_CLEAR	22	KEY_RANGE_0
4	KEY_9	23	KEY_7
5	KEY_LOCAL	24	KEY_RANGE_3
6	KEY_RESET		
7	KEY_FUNC	KEY_UPDATE	KEY_1
8	KEY_ENTER	KEY_HLC	KEY_2
9	KEY_DP	KEY_ADDR	KEY_3
10	KEY_RANGE_4	KEY_RUNHOLD	KEY_4
11	KEY_2	KEY_PRINT	KEY_5
12	KEY_RANGE_5	KEY_TCM	KEY_6
13	KEY_5	KEY_AUTO_RNG	KEY_7
14	KEY_RANGE_6	KEY_CAL	KEY_8
15	KEY_8	KEY_BCD	KEY_9
16	KEY_6	KEY_VIEW	KEY_0
17	KEY_NOTUSED	KEY_DISPLAY	KEY_1
18	KEY_RANGE_2	KEY_mk	KEY_DP

Usage: Keys are polled every 25ms in a timer interrupt. This routine changes mode to local and responds with the last key pressed. It can sense keys even in remote mode. Keys are debounced but are not tested for each menu state.

In other words, sending KEY 4 in a state that does not accept that key will have no effect to change the state. In addition if the KEY X commands are sent without enough interval the key handler task will not have executed and the key press can be overwritten by the next key command and the previous one is skipped. This is due to no buffering of remote key presses.

LOCAL COMMAND

Returns meter to local mode, remote LED off, Goto Local.

Syntax: LOCAL

Returns: <crLf>

Power-on default = LOCAL mode

Notes: REMOTE mode is selected when the meter receives a valid character (not <crLf>). Once selected, all keys are disabled and will not be scanned. Therefore no key beeps with the exclusion of the LOCAL key at the top right of the key pad. This key is active in REMOTE mode and will extinguish the REMOTE LED and transition the device to the front panel local user mode.

LOG COMMAND - Selects LOG mode on or off

Syntax : LOG <ON or OFF>,0 (synonymous with OHMS?)

Example: LOG ON 0<crLf> (space or comma)
 13.693<crLf>
 13.664<crLf>

LOG ON,4 (default)
 13.693<crLf>
 13.664<crLf>

LOG ON,6
 13.693,23.2,.0003931,13.699,20.0

Possible options, responses as if the following queries sent

=====

- 0 – OHMS?
- 1 – OHMS?,ATOD1?,RDNG?
- 2 – ATOD1?
- 3 – ATOD1?,RDNG?
- 4 – RDNG?
- 5 – RDNG?,RANGE?
- 6 – OHMS?,EXTEMP?,Setup.TC.Load_Coeff,COMPENSATED_OHMS,Ref_Degress
- 7 – EXTEMP?
- 8 – EXTEMP?,RDNG? (Run TCM ON first)
- 9 – LOG PENDING, starts when user presses PRINT

Power-on default = OFF

OHMS? QUERY

Responds with reading from the front panel display and causes an immediate update of the conversion so repeated query requests gets most accurate data. Send range command or AUTO prior to sending this to get the scaling factor.

The Ohms omega, milli and kilo characters are removed during remote formatting.

Syntax: OHMS?

Example: OHMS?<crLf>
 20.000<crLf> (on 20m or 20k Ohm ranges)

Response: <20.000<crLf>>

Power-on default = 0.000

Note: For Scientific notation/Engineering format, use RDNG?

***OPT? QUERY**

Returns the option text strings factory installed on meter from nonvolatile.

Syntax: *OPT?

Example: *OPT?<crLf>
 Option(s) :
 GPIB(IEEE488.2),BCD,PLC,HLC,TCM,AUTO,RS232,USB<crLf>

VOLTAGE RANGE COMMAND

Selects a voltage range

Syntax: VRANGE <range number>

Range number = 1 – 3

1 = 20mV

2 = 200mV

3 = 2V

CURRENT RANGE COMMAND

Selects a current range

Syntax: IRANGE <range number>

Range number = 1 – 6

1 = 10A	4 = 10mA
2 = 1A	5 = 1mA
3 = 0.1A	6 = 0.1mA

RANGE? QUERY

Returns the selected range.

Syntax: RANGE?

Response: Range number = 1 – 18

1 = RNG1 2.0000m Ω (I1+V3)	10 = RNG10 2.0000 Ω (I-4+V3)
2 = RNG2 20.000m Ω (I1+V2)	11 = RNG11 20.000 Ω (I4+V2)
3 = RNG3 200.00m Ω (I1+V1)	12 = RNG12 200.00 Ω (I4+V1)
4 = RNG4 20.000m Ω (I2+V3)	13 = RNG13 20.000 Ω (I5+V3)
5 = RNG5 200.00m Ω (I2+V2)	14 = RNG14 200.00 Ω (I5+V2)
6 = RNG6 2.0000 Ω (I2+V1)	15 = RNG15 2.0000k Ω (I5+V1)
7 = RNG7 200.00m Ω (I3+V3)	16 = RNG16 200.00 Ω (I6+V3)
8 = RNG8 2.0000 Ω (I3+V2)	17 = RNG17 2.0000k Ω (I6+V2)
9 = RNG9 20.000 Ω (I3+V1)	18 = RNG18 20.000k Ω (I6+V1)

VOLTAGE RANGE QUERY

Returns the selected voltage range.

Syntax: VRANGE?

Response: Range number = 1 - 3

1 = 20mV
2 = 200mV
3 = 2V

CURRENT RANGE COMMANDS

Returns the selected current range.

Syntax: IRANGE?

Response: Range number = 1 - 6

1 = 10A	4 = 10mA
2 = 1A	5 = 1mA
3 = 0.1A	6 = 0.1mA

TEST CURRENT COMMAND

Selects TEST CURRENT on or off

Syntax: TCURRENT <ON or OFF>

Power-on default = OFF

TEST CURRENT QUERY

Responds with TEST CURRENT on or off

Syntax: TCURRENT?

Example: TCURRENT?<crLf>
ON<crLf>

Response: <"ON" or "OFF">

Power-on default = OFF

RDNG? QUERY

Responds with reading from the device in engineering notation. Query function also uses an immediate update of the conversion so repeated query requests gets the most accurate data.

Syntax: RDNG?

Example: RDNG?<crLf>
2.4321e+1<crLf> (on 20.000Ω ranges)

Response: <value in reduced engineering notation<crLf>>

Power-on default = 0.000e+0

CAUTION: Will not work if the transmit interrupt happens to be busy with a display update and the following occurs:

Remote	->RANGE 6 <2kΩ)
System	->Places "REM^" in TX buffer (Tiny Display)
System	->Change to R6
System	->Places "2k^" in TX buffer (Tiny Display)
System	->Formats Display String "1.6543k^"
Remote	->READING?
System	->Places in TX buffer to VFD 'D' characters
Remote	->RANGE 4
System	->Change to R4
System	->Executes READING? query, uses Range=4 and last displayed value
System	->Places in TX buffer, next 'R' characters

RESET COMMAND

Executes a soft reset of the ADuC834 processor system.

Syntax: RESET

Response: Front panel display show soft reset initiation. "RESETTING" is displayed flashing inverse mode for 300ms while all system configurations are returned to power up default.

Example: RESET<crLf>

Response: <crLf>

Notes: Resetcpu() executes as soft reset of the system by "nicely" changing the return stack function and popping it. Expect a 500ms delay after receiving the linefeed before transmitting next command.

***RST COMMAND**

Sets buffers to power on default.

Syntax: *RST<crLf>

Response: <crLf>

Remote command buffer, Serial I/O, history, statistics, stability

SAVSETUP COMMAND

Stores current RAM setup data in NV RAM.

Syntax: SAVSETUP<crLf>

SAVSETUP? QUERY

Refreshes the current Setup from NV-RAM and then sends it to the remote port.

Syntax: SAVSETUP?<crLf>

Response: FF EE DD CC BB AA 99 88 77 66 55 44 33 22 11 00<crLf>
 FF EE DD CC BB AA 99 88 77 66 55 44 33 22 11 00<crLf>
 FF EE DD CC BB AA 99 88 77 66 55 44 33 22 11 00<crLf>
 BB AA 99 88<crLf>

***STB? QUERY**

Returns the command status byte.

Syntax: *STB?

Response: Command status number = 0 - 0xFF

Example: *STB?<crLf>
 01<crLf>

Fragment: TCM ON<crLf>
 *STB?<crLf>
 TCM AFF<crLf>
 **STB?<crLf> (returns * ERROR)
 03<crLf>
 TCM?<crLf>
 ON<crLf>

0 = CMD_LAST_COMPLETE
1 = CMD_UNKNOWN
2 = CMD_MISSING_PARAM
4 = CMD_INVALID_PARAM
8 = CMD_MODE_OFF
16 = CMD_INCORRECT_NUMBER_PARAMS
32 =
64 =
128 = CMD_CALLAREALPGMR

Power-on default = 0

Note: After a command or query with or without a response, the *STB? query responds with hexadecimal number with bits mapped as above. The *STB? query clears the command status byte as does any other correctly completed command. The bits are "sticky" through the sending of the *STB? query response but are cleared after the data is transmitted.

TCM COMMAND

Selects TCM mode on or off

Syntax: TCM <ON or OFF>

Example: TCM ON<crLf>
TCM?<crLf>
ON<crLf>

Power-on default = OFF

TCM QUERY

Responds with TCM mode on or off

Syntax: TCM?

Example: TCM?<crLf>
ON<crLf>

Response: <"ON" or "OFF">

Power-on default = OFF

Send this date after the calibration is complete followed by a SAVESETUP to store in EE memory.

*TST? QUERY

Causes internal self-test to run and returns the result.

Syntax: *TST?

Response Format: %hd

CAUTION:THIS FORMAT IS THE ONLY ACCEPTABLE BY IVI DRIVER.

BCD INTERFACE

GENERAL

Option "BCD" provides parallel Binary Coded Decimal data output that corresponds to the display indication.

Signals are also provided for range information, and overload. A run/hold line is also provided to halt the 4300C.

The signals are TTL compatible ($0 \leq .8V$, and $1 \geq 2.4V$) and will drive 1 LS TTL load.

BCD PIN ASSIGNMENTS

Option "BCD" provides parallel Binary Coded Decimal data output that corresponds to the display indication.

Signals are also provided for range information, and overload. A run/hold line is also provided to halt the 4300C.

The signals are TTL compatible ($0 \leq .8V$, and $1 \geq 2.4V$) and will drive 1 LS TTL load.

Data

This is the BCD coded data which is identical to that being displayed by the 4300C.

Table 15 – BCD
Measurement Data

PIN #	Function	PIN #	Function
1	1	24	200
20	2	6	400
2	4	25	800
21	8	7	1000
3	10	26	2000
22	20	8	4000
4	40	27	8000
23	80	9	10000
5	100	28	20000

Ranges

This is a BCD exponent which indicates the present resistance range as follows:

Table 16 – BCD Range Data

PIN #	Function	Range	R3	R2	R1	R0
10	R0	2mΩ	0	0	0	0
29	R1	20mΩ	0	0	0	1
11	R2	200mΩ	0	0	1	0
30	R3	2Ω	0	0	1	1
		20Ω	0	1	0	0
		200Ω	0	1	0	1
		2kΩ	0	1	1	0
		20kΩ	0	1	1	1

Overload – Pin 12

This pin is set to logic 1 when the data on the lines above is an overload indication. (Note: The Data is arbitrary during this condition.)

Pin assignment

Table 17 – BCD Pin Assignment Reference Table

PIN #	Function	PIN #	Function
1	1	20	2
2	4	21	8
3	10	22	20
4	40	23	80
5	100	24	200
6	400	25	800
7	1000	26	2000
8	4000	27	8000
9	10000	28	20000
10	R0	29	R1
11	R2	30	R3
12	Overload	31	NC
13	NC	32	AVDD
14	AVDD	33	AVDD
15	AVDD	34	AVDD
16	AGND	35	AGND
17	AGND	36	AGND
18	NC	37	NC
19	NC		

The information contained in this section describes the theory of operation behind the Valhalla Model 4300C Digital Micro-Ohmmeter. The theory is divided into two sections. The first is a general description referring to the block diagrams of Figure 39. The second section is a detailed description referring to the schematics and diagrams at the back of this manual.

4-WIRE CONFIGURATION

Figure 38 on the right, illustrates how the 4-wire principle is used to eliminate lead, wire, and contact resistances as potential error sources. The internal current source inherently overcomes all series resistance (within compliance voltage limits) and delivers a precise

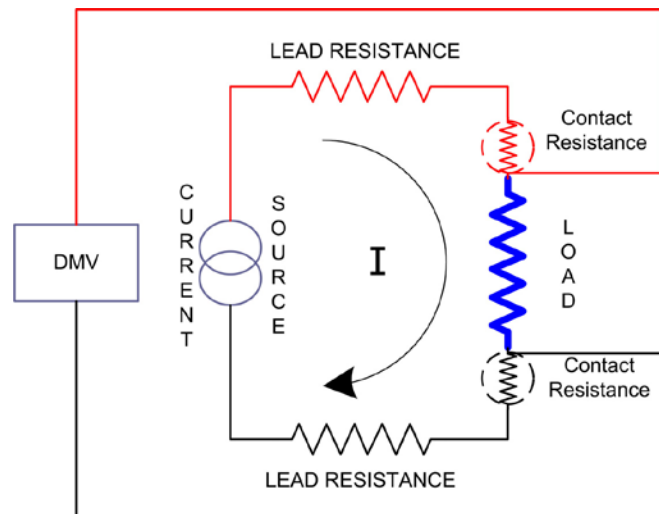

Figure 38 – 4-Wire Configuration

constant current. The internal high-impedance DVM senses the voltage drop across the load. There is negligible contact and lead resistance error created by the voltage measurement because the high input impedance of the DVM limits current flow in the voltage leads.

GENERAL DESCRIPTION OF CIRCUITS

This section describes the general function of each section of the Model 4300C. The ohmmeter may be divided into four separate parts:

Figure 39 – 4300C Block Diagram

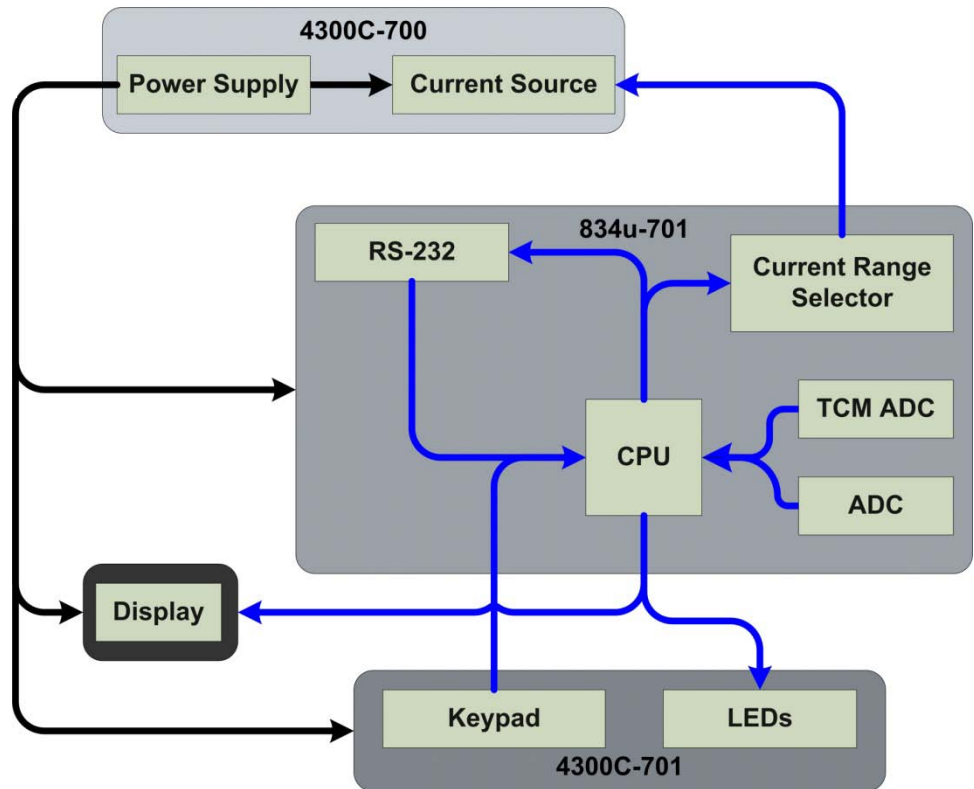

- **4300C Main Board** (4300C-700) – This portion of the ohmmeter contains the power supply and the constant current source.
 - **Power Supply** – This section converts the AC line power into the DC levels necessary to power the ohmmeter’s circuitry.
 - **Constant Current Source** – This section of the main board provides a stable test current that is passed through the load to develop a voltage across it. The value of this current for each range is indicated on the front panel of the instrument.
 - **Current Source Reference** – The current source reference voltage is provided by an internally opened zener reference and its associated components. The reference circuit provides a 1.0000 volt output to the error amplifier circuit.
 - **Error Amplifier** – The error amplifier compares the reference voltage with the signal from the range switching circuit to drive the output stage. The ON/OFF signal from the control logic commands the error amplifier to turn on or off the output stage.
 - **Output Stage** – The output stage provides current gain capable of driving +10 amps into the unknown resistance. The ON/OFF signal from the control logic disables the current source output when the test current is turned off.
 - **Range Switching** – The range switching circuits provide six ranges of precision current shunts to control the output current. The current shunt values are selected so that 1V is dropped across the shunt for each current range (e.g. 10A in, 1V out; 1A in, 1V out; etc.). The operation of the current source is as follows: Current from the power supply flows through the load, output stage and current shunt. The voltage dropped across the shunt is compared to the reference voltage by the error amplifier. The error amplifier uses the voltage drop across the internal shunt to control the amount of current passing through the load as necessary to maintain a precise constant current.
 - **Protection Circuitry** – The protection circuitry protects the output stage from inductive kickback voltages. The UNSAFE signal indicates the presence of back EMF from the load.

- **Micro-Controller Board (834u-701)** –This is the central processing unit of the ohmmeter. The analog to digital conversion, the range selection, LED indicator selection and all other decision making processes occur in this portion of the instrument.
 - **CPU** – The micro-controller processes the data received by the ADC's and sends a ohms reading to the display. Also from the data received from the keypad, the micro-controller selects the current range, activates the LEDs and sends data out from the rs-232 port.
 - **ADC** – The micro-controller's analog to digital converters sense the voltage drop across the load.
 - **TCM ADC** – The micro-controller's analog to digital converter sense the voltage across the temperature sensor (Omni Compensator).
 - **Current Range Selector** – The current range selection occurs within the microcontroller. According to the data received from the keypad, a signal is sent to activate the appropriate relay on the current source circuitry.
 - **RS-232** – The RS-232 data is also sent and received by the micro-controller.
- **Display** – This is the visual interface to the user. The display receives its data directly from the micro-controller.
- **Keypad Board (4300C-701)** – This section of the ohmmeter contains the keypad and the LED indicators for the TCM and HLC function.
 - **Keypad** – The keypad is used to send commands to the micro controller.
 - **HLC LEDs** – These LEDs indicate the result of the HLC comparison.
 - **TCM LEDs** – These LEDs indicate the status of the temperature compensation mode.

DETAILED CIRCUIT DESCRIPTIONS

This section describes in detail the operation of the main circuits of the Model 4300C. The reference designators used in this section refer to the drawings included at the back of this manual.

Current Source

The operation of the Current Source is described in the following paragraphs. All components in this section can be found on Schematic 4300C-070.

Figure 40 – Current Source Block Diagram

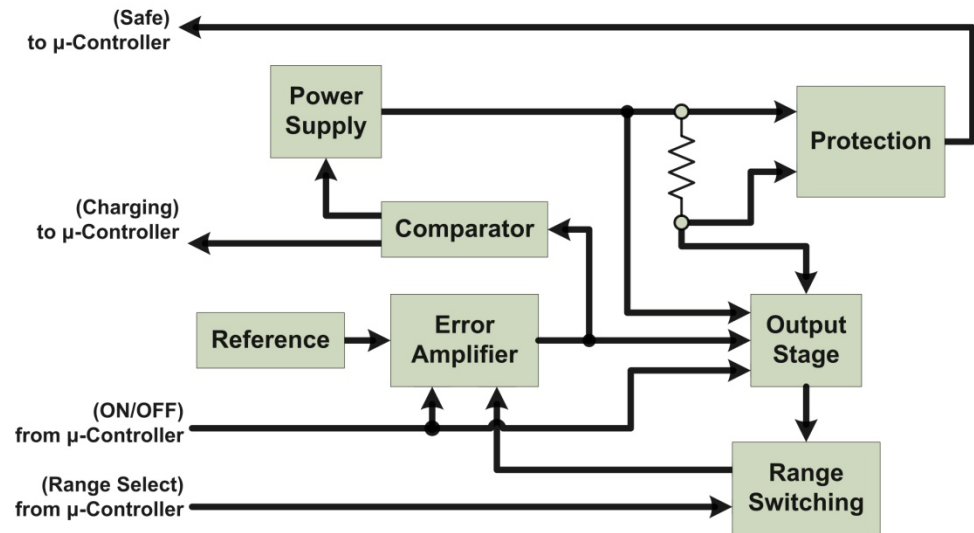

Reference

IC103 along with resistors R116-R118 and RV101 form a temperature-stabilized voltage reference. IC103 is a precision 4.1V precision reference (LM4140ACM). The zener current is limited by resistor R116. A voltage divider composed of R117, RV101 and R118 divide the zener voltage down to 1.0000 VDC. Capacitor C103 removes any noise riding on the reference output.

Error Amplifier

The error amplifier is composed of C102, IC101A, R104, R103, RLB-2 and TR103. IC101A provides high DC gain to drive transistor TR103 via resistors R104 and R103. C102 provides local AC feedback around IC101A for stability. TR103 provides base current to the output stage. Relay contact RLB-2 is closed when the test current is turned off which removes the gate drive to TR103.

Output Stage

The output stage composed of TR101, TR102, R101, R102, R126 and RLB-1 provides current gain capable of sourcing 10 amps. Base drive for transistors TR101 and TR102 is provided by the error amplifier. Resistors R101 and R102 equalize the emitter currents in the two output devices. Relay contact RLB-1 is closed when the test current is turned off, which connects resistor R126 across the output terminals to reduce the output voltage to less than 20mV.

Range Switching

Range selection is accomplished by selecting one of the precision current shunts R105, R107, R109, R111, R113 or R115. Relays RLC thru RLH select the appropriate combination of shunts. Only one range relay is ever energized at any one time. Resistors R106, R108, R110, R112, and R114 along with potentiometers RV102 through RV105 are used to trim the shunts to produce a precise current output.

Protection Circuitry

The protection circuitry is composed of diodes D101, D102, opto-isolator IC102-A, R123 and R124. The two diodes provide a discharge path for inductive loads. D102 conducts when the back EMF from the load is greater than 5V which turns on the opto-coupler through R123 and R124. This circuitry is used to determine the Disconnect Status LED condition.

Power Supply

Relay RLA selects which secondary tap of transformer T1 is applied to the bridge rectifier composed of diodes D103-D106. Capacitor C101 levels the rectified AC voltage. Relay RLA is controlled by the comparator circuit to provide a higher voltage to the output stage to reduce settling time when an inductive load is being charged.

Charging Inductor Mode

The gate voltage of TR103 is compared to a reference voltage defined by D107-D109. When the gate voltage exceeds the reference voltage, TR105 conducts which energizes relay RLA and opto-coupler IC102-B. Transistors TR104 and TR105 form a Schmidt trigger circuit to reduce relay chattering. Buffer IC101-B isolates the gate drive circuit from the comparator to reduce rail injected noise.

Micro-Controller Board

Complete circuitry is shown on schematic 834u-071.

Figure 41 – μ -Controller Block Diagram

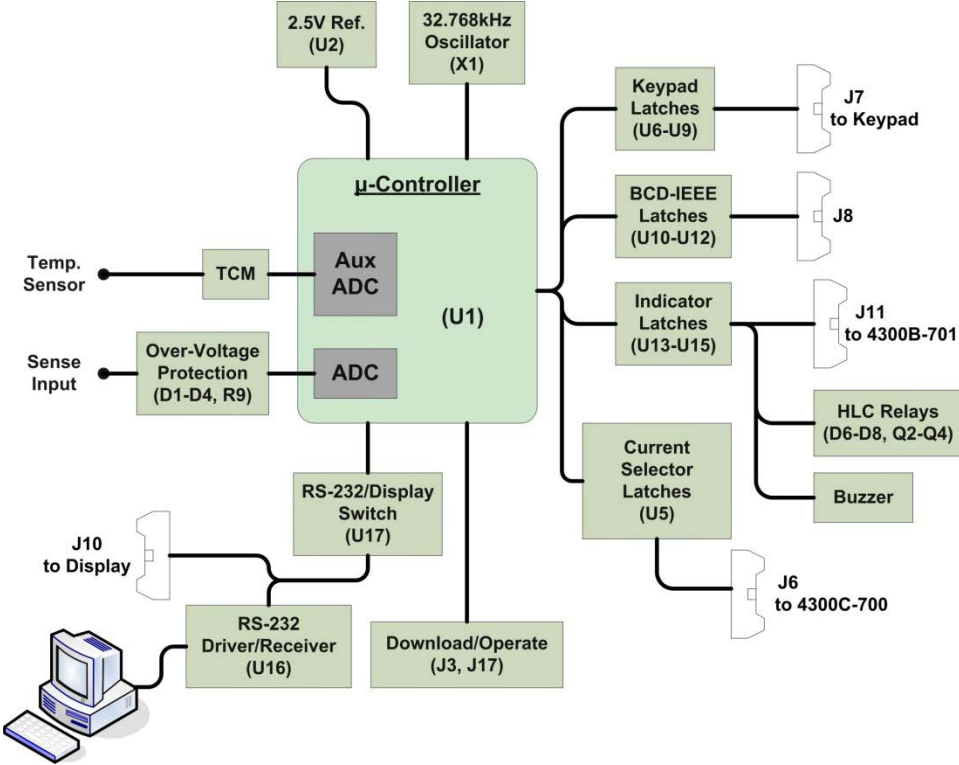

Micro-Controller

The micro-controller executes the analog to digital conversion on the voltage across the load. Also all other processes, such as range selection, HLC relay switching, LEDs activation and so on. Refer to schematic 834u-070 sheet 1.

Over-Voltage Protection

The resistor R9 and diode D1 thru D4, form the Over-Voltage protection circuitry. This block limits the input voltage to only $\pm 7V$ if an extreme overload occurs. Refer to schematic 834u-070 sheet 1.

TCM

The zener diode D5 and its associated components create a +1.2V reference. This voltage level plus AVDD are used to power the temperature compensator if attached. Refer to schematic 834u-070 sheet 1.

2.5V Reference

U2 is a precision 2.5V reference used by the micro-controller during the analog to digital conversion. Refer to schematic 834u-070 sheet 1.

RS-232/Display Switch and RS 232 Driver/Receiver

U17 is a digital switch that allows the micro-controller to send data to the display or to the RS-232 port. U16 is a RS-232 Driver Receiver. This component converts data to the RS-232 level. Refer to schematic 834u-070 sheet 6.

TROUBLESHOOTING

Apparent malfunctions are often the result of misinterpretation of specifications or due to an incomplete understanding of the instrument. A thorough review of the operating instructions for this instrument is recommended prior to any component replacement, etc. Check to be sure that cables and other test equipment are in good working order before attempting to troubleshoot the 4300C.

If the Model 4300C exhibits problems that cannot be eliminated by reviewing chapters 2, 3, 4, 6, 7, or 9; the following guidelines have been established to help solve the problem.

Localizing the Problem

The key to successful troubleshooting is to localize the problem as much as possible before trying to pin the problem down to a specific component. Certain questions should be asked such as "Does the problem occur on all ranges or on a specific range only?". The power supplies are also one of the first things that should be checked.

As it is not possible to anticipate all failure modes of the 4300C, servicing personnel should become familiar with this chapter to gain a complete understanding of the internal workings of this instrument.

Component Replacement

If the problem has been identified as a faulty component, the accuracy of the 4300C can be maintained only if the following precautions are taken:

- Use only the specified component or its exact equivalent. Spare parts can be ordered from your nearest Valhalla Scientific Service Center or from the factory directly by referring to the Valhalla Stock Number listed in the Parts Lists section at the back of this manual.
- Use only 63/37 grade rosin core electronic grade solder with a 50W or lower maximum power soldering iron.
- When soldering, heat the terminal of the component, not the solder. Apply solder smoothly and evenly. Do not move the component until the solder has cooled. Bad solder joints can cause additional problems!
- Static sensitive parts require special handling procedures. Always treat an unknown part as if it were static sensitive.

GENERAL

This Chapter provides general maintenance information and a procedure for calibrating the ohmmeter. The Model 4300C μ -ohmmeter should be calibrated on a routine basis (every 12 months is recommended) to ensure continued accuracy.

Before performing the calibration procedure below, the ohmmeter should be allowed to warm up at a stable temperature for at least 30 minutes with the covers in place.

REQUIRED TEST EQUIPMENT

The following equipment is required to perform calibration of the 4300C:

1) Precision resistors within $\pm 0.005\%$, the following values:

0.1 Ω 1 Ω 10 Ω 100 Ω 1k Ω 10k Ω

2) DC voltage standard capable of outputting 10mV, 300mV, 1V and 2V. Valhalla Model 2701C is suitable for the task.

3) Four wire test lead set.

4) Precision Digital Voltmeter.

Note: If this equipment is not available, the ohmmeter may be returned to Valhalla Scientific for calibration traceable to NIST.

PRE-CALIBRATION PROCEDURE

The calibration adjustments are accessed by removing the top cover of the instrument.

The locations of the adjustment potentiometers are shown in Figure 42 at the end of the chapter. Leave the cover in place as much as possible. After each adjustment is made, the cover should be replaced and the instrument allowed to stabilizing.

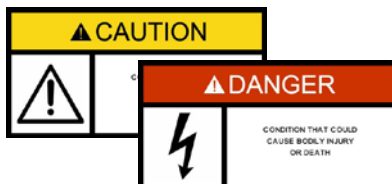

Dangerous AC line voltages exist inside the instrument. Use caution when making adjustments to avoid contact with these voltages.

4300C CALIBRATION PROCEDURE

Standard Calibration

The standard calibration consists of three parts: sense calibration, source calibration and final adjustment. The sense calibration and the final adjustment calibration is cover-on and automated; the instrument will prompt the user throughout the steps. The source calibration is performed by adjusting six potentiometers located on the 4300C main board. All three calibrations must be performed for a complete calibration of the 4300C.

Sense Calibration

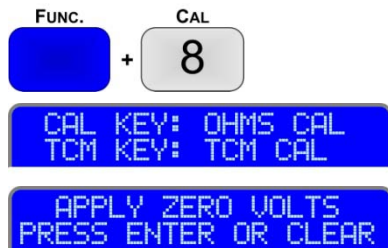

- I. Press the “**FUNC. + CAL**”.
- II. Press “**CAL**” to choose the standard calibration.
- III. Apply a short between the Sense Hi and the Sense Lo binding post. Once the short is applied, press “**ENTER**”. The ohmmeter will perform the zero calibration for all ranges. Press “**CLEAR**” to return to the previous screen.

While zeroing the ranges, the screen will display the following information:

Pass indicates the number of passing values that have been measured. 15 passing values must be measured before the timer reaches the 100 second limit for a successful calibration.

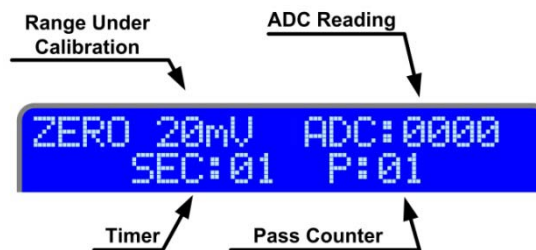

- IV. When prompted by the display, remove the short and apply 10mV to the sense terminals. Press “**ENTER**” to continue or “**CLEAR**” to return to the zero cal screen. While calibrating the ranges, the screen will display the following information.



```
APPLY 300mV PRESS
ENTER OR CLEAR
```

- V. When prompted by the display, apply 300mV to the sense terminals. Press “**ENTER**” to continue or “**CLEAR**” to return to the 10mV cal screen. While calibrating the ranges, the screen will display the following information:

```
3.0000KΩ  ADC:####
SEC:01    P:01
```

```
APPLY 2.0V PRESS
ENTER OR CLEAR
```

- VI. When prompted by the display, apply 2V to the sense terminals. Press “**ENTER**” to continue or “**CLEAR**” to return to the 300mV cal screen. While calibrating the ranges, the screen will display the following information:

```
20.0000KΩ  ADC:####
SEC:01    P:01
```

```
SAVE CAL VALUES:
PRESS ENTER OR CLEAR
```

- VII. When prompted by the display, press “**ENTER**” to save the calibration values to memory, or press “**CLEAR**” to return to the 2V cal screen.

```
CALIBRATION COMPLETE
PRESS ENTER OR TCM
```

- VIII. When prompted by the display, press “**ENTER**” to exit the calibration mode, or press TCM to continue with the TCM Cal (see Chapter 4).

Current Source Calibration

The following procedure should be performed when calibrating the current source section of the 4300C. In all steps the current source is calibrated to the internal voltmeter therefore the sense calibration, described earlier in the chapter, should be performed before proceeding. Alternately, an external voltmeter of greater than $\pm 0.005\%$ accuracy may be used.

Reference Adjustment

This adjustment should only be performed if components in the reference section have been replaced and need not be performed on a routine basis. A DC voltmeter with a minimum of $\pm 0.03\%$ accuracy is needed to make the adjustment.

Connect the voltmeter low lead to 0V (front of R117) and the voltmeter high lead to IC101 pin 5. Adjust RV101 for 1.0000V. Remove the voltmeter leads.

10 Amp Adjustment

Connect the 0.1 Ω standard resistor to the 4300C using four-wire connections. Select the 2V and 10A ranges on the 4300C. Adjust RV102 for a reading of 100.00m Ω . Allow extra time for settling in this range. Keep the cover on as much as possible to ensure proper cooling of components.

1 Amp Adjustment

Connect the 1 Ω standard resistor to the 4300C using four-wire connections. Select the 2V and 1A ranges. Adjust RV103 for a reading of 1000.0m Ω .

0.1 Amp Adjustment

Connect the 10 Ω standard resistor to the 4300C using four-wire connections. Select the 2V and .1A ranges. Adjust RV104 for a reading of 10000m Ω .

10mA Adjustment

Connect the 100 Ω standard resistor to the 4300C using four-wire connections. Select the 2V and 10mA ranges. Adjust RV105 for a reading of 100.00 Ω .

1mA Adjustment

Connect the 1k Ω standard resistor to the 4300C using four-wire connections. Select the 2V and 1mA ranges. Adjust RV106 for a reading of 1.0000k Ω .

0.1mA Adjustment

Connect the 10k Ω standard resistor to the 4300C using four-wire connections. Select the 2V and .1mA ranges. Adjust RV107 for a reading of 10.000k Ω .

TCM Calibration

REMOVE SENSOR
PRESS ENTER OR CLEAR

- I. Remove the top cover of instrument.

- IX. Verify that the Omni Compensator (Temp. Sensor) is not connected to the ohmmeter. Press “ENTER” to continue. The instrument will perform the TCM Zero Cal. The screen will display the following information:

ZERO ADC:0000
SEC:01 P:01

APPLY 1.000V SENSOR
PRESS ENTER OR CLEAR

- X. When prompted by the display, apply 1V to TP1 and TP2 (follow polarity). Press “ENTER” to continue or “CLEAR” to return to the zero cal screen. While calibrating the full scale TCM, the screen will display the following information:

SCALE:### (380-410)
SEC:01 ADC:####

SAVE CAL VALUES:
PRESS ENTER OR CLEAR

- XI. When prompted by the display, press “ENTER” to save the calibration values to memory, or press “CLEAR” to return to the TCM full scale cal screen.

CONNECT THE SENSOR
AND PRESS ENTER

- II. Connect an Omni Compensator to the TCM receptacle on the front panel.

- XII. Allow the sensor to settle for 2-3 minutes and press “ENTER”.

INPUT AMBIENT TEMP
---.°C

- III. Using a precision thermometer, record the ambient temperature.

- XIII. Using the numerical keys, enter the ambient temperature recorded in the previous step. Press “ENTER” to continue.

- XIV. Press “ENTER” to confirm the value or press “CLEAR” to return to the previous screen.

SAVE CAL VALUES:
PRESS ENTER OR CLEAR

- XV. When prompted by the display, press “ENTER” to save the TCM calibration values to memory, or press “CLEAR” to return to the previous screen.

Figure 42 – Drawing No
4300C-700

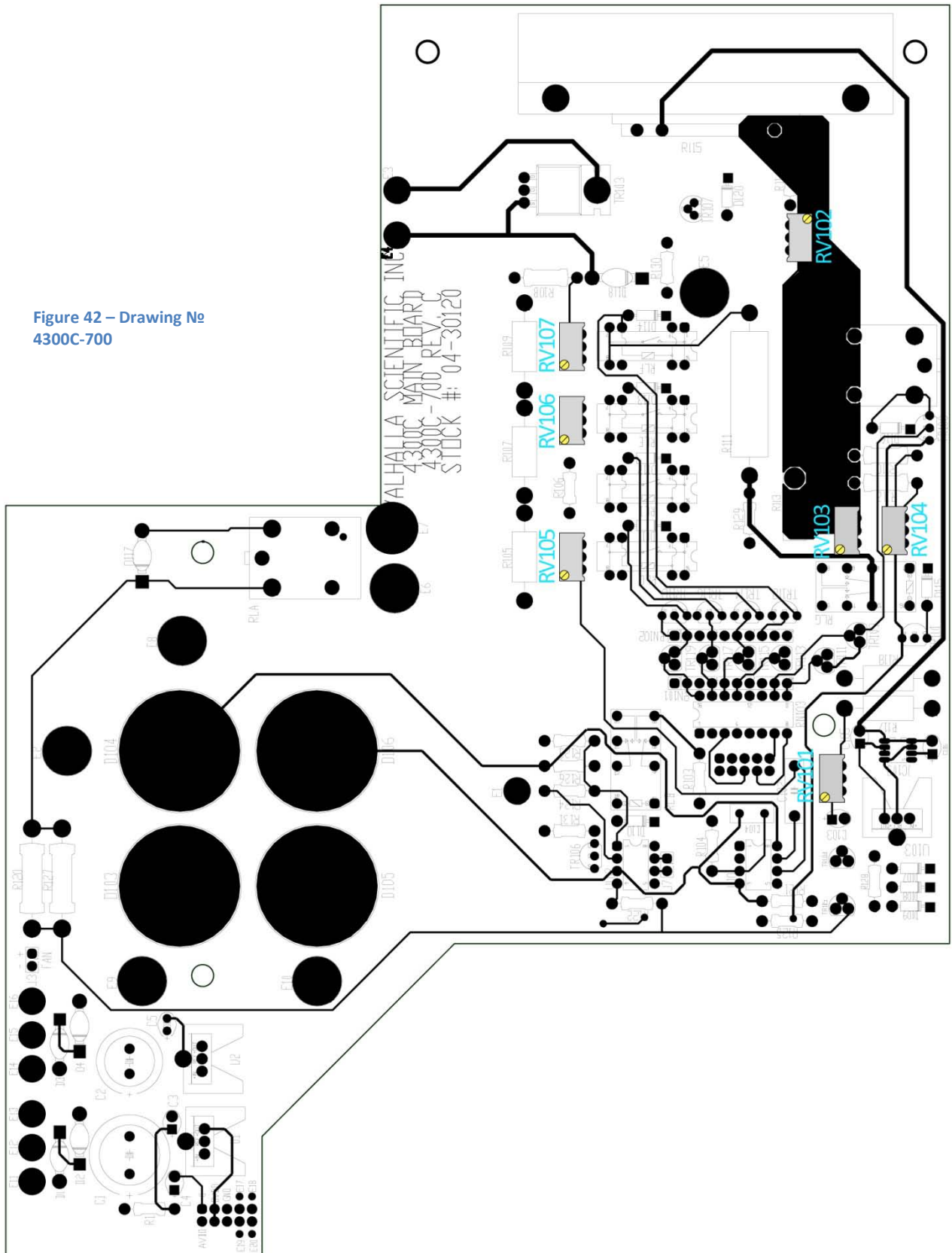

GENERAL

This section contains a number of useful tips that should be noted when working with inductive loads.

Inductive loads include devices such as transformers, coils, ballasts, wire-wound resistors, magnets and motors. These types of devices require special consideration as described below.

CONNECTIONS AND SETTLING TIME

When connecting the cables to the inductive load, care should be taken not to draw an arc. The Test Current should be turned Off and the cables positively clamped onto the load before applying current.

When measuring highly inductive loads the settling time of the ohmmeter is determined by the compliance voltage of the current source. Typically, the compliance voltage of a 4300C in the Charging Inductor mode is in excess of 20V. Thus, with an inductor of 1000 Henries (an extremely large transformer) the unit will take approximately 10 minutes to settle. During settling, the unit will display overload and should be ignored until the Charging Inductor indicator is extinguished.

The actual equation for determining settling time is as follows:

$$T = (L \times I)/V$$

Where:

T = settling time in seconds

L = inductance in Henries

I = current range (in amps)

V = compliance voltage of 4300C (20V)

Note that the higher the test current, the longer the settling time.

NOISY READINGS

When measuring very low resistances of highly inductive loads, care should be taken to reduce 60Hz pickup at the input to the 4300C. The noise pickup is caused by the very high impedance of the load at 60Hz given by the formula:

$$Z = 377 \times L$$

Where:

Z = Impedance in ohms

L = Inductance in Henries

Thus, with a 1000 Henry transformer the impedance at 60Hz would be 377Kohm, across which many millivolts of noise may be induced by movement or by interference from other devices.

This effect may be reduced by using fully shielded cables such as Valhalla Option "K". It may also be helpful (and will cause the settling time to be reduced) if the unused windings of the transformer can be short-circuited during the measurement. This will significantly reduce the inductance of the winding under test, and will also prevent the unused windings from producing dangerous voltages during charging and discharging of the transformer.

When using the 20mV voltage range, the measurement may be subject to the effects of thermal EMF's. This effect is seen as noise on the display. The best way to reduce this effect is to use a low-thermal lead set such as Valhalla Option SL-48.

DISCONNECTING THE CABLES

When disconnecting the test leads from the load or from the 4300C, extreme care must be taken to ensure that the inductor has been discharged to prevent an extremely high energy, high voltage "kick-back" which can be LETHAL to the user and can certainly damage the 4300C. There are two methods of discharging the energy in the inductor listed below.

a) Using the "Flyback Diode" in the 4300C.

As discussed in Chapter 7, the 4300C has an internal diode which can sink the excess current being discharged from the inductor. Therefore turning off the test current and/or reducing the 4300C's current range from the original test current to a low value (less than 10mA) will automatically discharge the inductor into the Flyback diode. The cables should not be disconnected until the SAFE cable disconnect status LED is illuminated.

The time required to discharge the inductor into the Flyback diode is given by the formula:

$$T = (L \times I) / V$$

T = Discharge time in seconds

L = Inductance in Henries

I = Current range (in Amps)

V = Flyback Diode voltage drop (typically 6V)

For example, a 1000 Henry inductor will take approximately 30 minutes to discharge. During discharge the 4300C display will read overload until the inductor has completely discharged. The reading will then return close to zero.

b) Using a Shorting Switch

When using a shorting switch instead of the 4300C flyback diode, the current stored in the inductor discharges through the cables and switch. The current discharges with a time constant calculated from the formula below which is dependent on the test current that was used to charge the inductor:

Test Current Discharge Time

Range Used: (in Seconds):

10 Amps $7 \times L \div R$

1 Amp $5 \times L \div R$

.1 Amp $2 \times L \div R$

< .1 Amp Not required

Where:

L = Inductance in Henries

R = Total resistance of cables, switch and inductor (in ohms)

In a typical application R might be approximately 1 milliohm (.001Ω) and L might be 1000 Henries. If the 10 amp range of the 4300C was used to measure the inductor, 7,000,000 seconds are required (11½ weeks) to discharge it. The 4300C may be disconnected at any time provided the short circuit is maintained across the winding.