

No. C-40

AC Pulse Ionizing Clean Bar

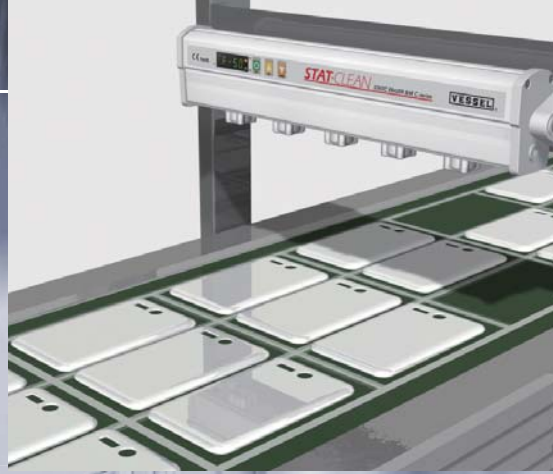

Aerodynamic body design of the thin cross sectional area enables quick static electricity elimination to be achieved without causing changes in air flow in a clean room or above in a clean bench. Being capable of setting frequency in 10 levels as well as being equipped with auto ion balance mode in which ion balance is automatically adjusted according to the polarity of a charged object, these ionizers can make adjustments according to the installation distance or the amount of charge.

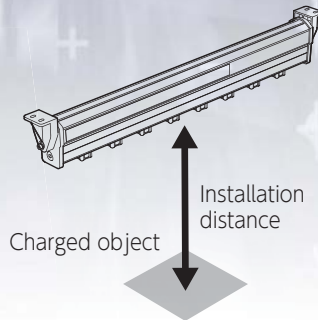
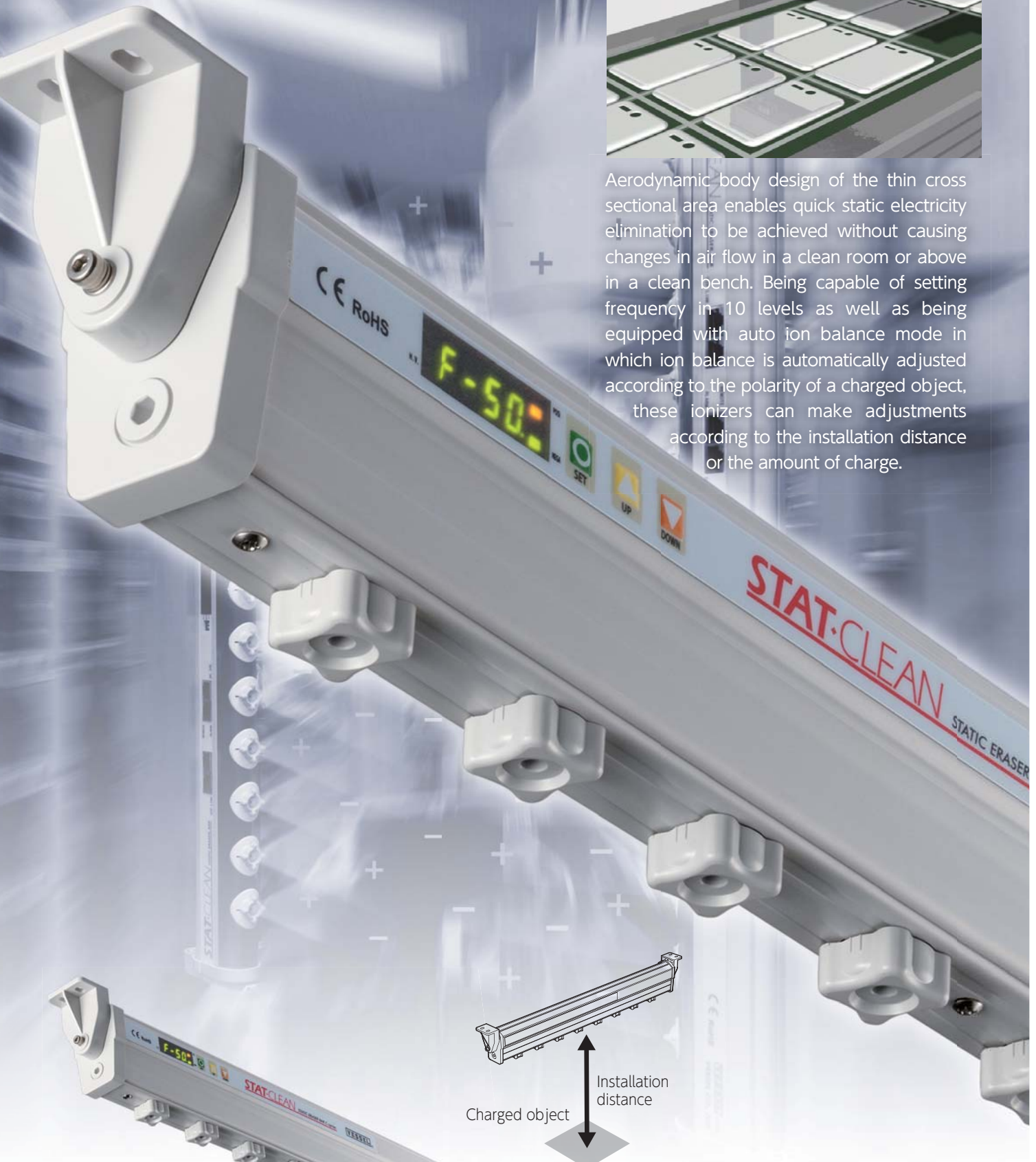

No. C-40

AC Pulse Ionizing Clean Bar

Bar-type ionizers best suited to mounting to a variety of equipment Air purge construction enables super-fast static electricity removal to be accomplished. With a lineup of abundant sizes, they respond to various applications.

Frequency setting

Installation place	Location	mm	Frequency, Hz
Film/conveyor	Close distance	50~300	20~50
Clean bench	Intermediate distance	600~750	8~10
Clean room ceiling	Long distance	900~1500	0.1~5

HAND TOOLS

BITS & SOCKETS

ELECTRIC TOOLS

AIR TOOLS

STATIC SOLUTIONS

GASOLINE ENGINE TOOLS

C-series

No. C-series AC Pulse Ionizing Clean Bar

Ionizing method:Pluse AC corona discharge Applied voltage:8~12.5kVAC(p-p)

- Super compact design in which a high-voltage power supply, control circuit, and air circuit have been incorporated.
- Terminals are collected on one side for easy daisy chain.
- Newly developed needle electrode socket is of air purge construction in which air purge outlets are provided around electrode needles. This does not only prevent contamination on the needle electrode tip but also helps super-fast static electricity removal.
- Opposing electrodes are incorporated in the body. This structure prevents particles from adhering to the body outside that is caused by induction voltage, and minimizes losses in applied voltage, enabling the ion generation efficiency to be improved.
- Adopts the needle electrode socket type in which a needle can be easily replaced by one-touch operation.
- Equipped with auto balance mode that optimally adjusts ion balance automatically according to the polarity of a charged object (target distance: 50 to 100 mm)



- Accessories :
AC cable (5m)
Remote Control RMC-01 (Except C-40/C-60)
End brackets 2pcs,
Middle bracket (Quantity See below)

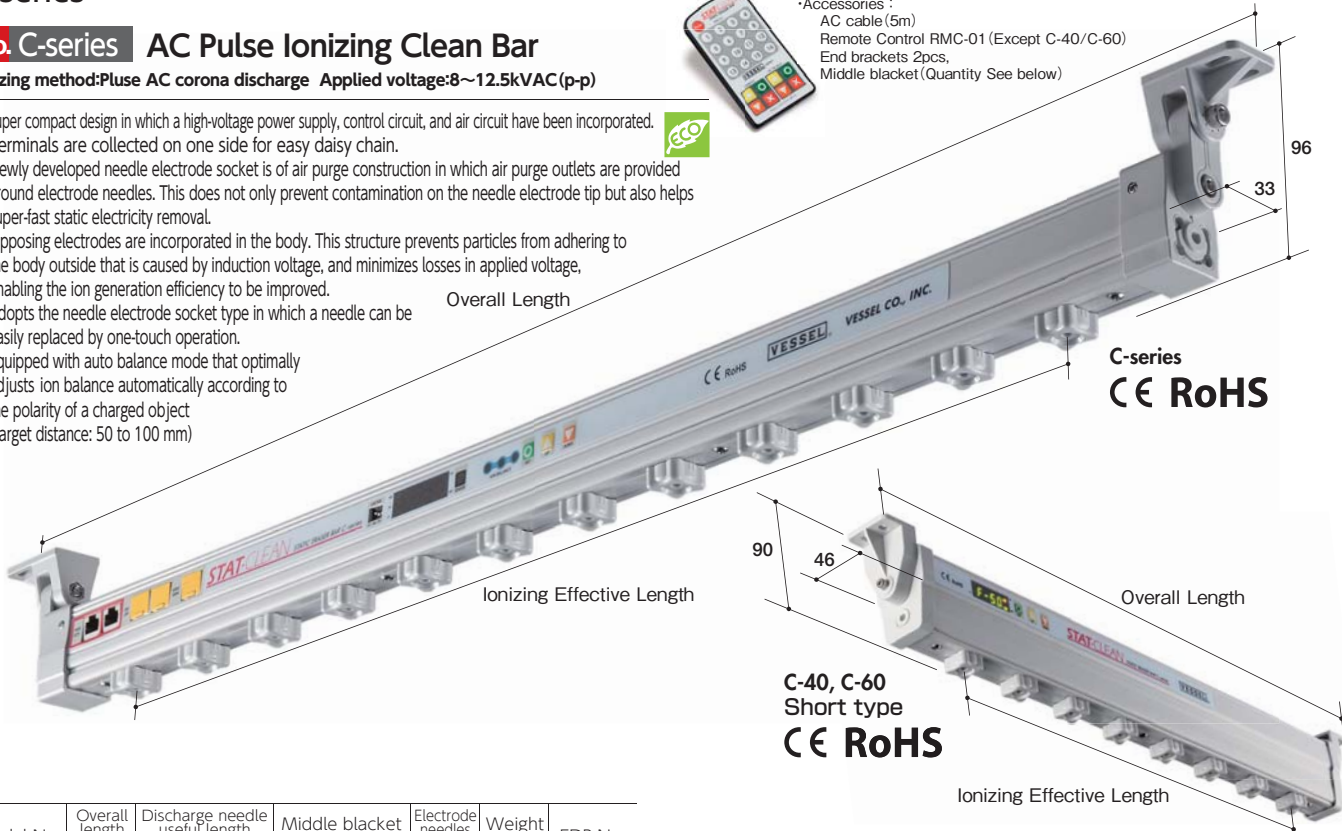

Model No.	Overall length (mm)	Discharge needle useful length (mm)	Middle bracket (pcs)	Electrode needles (pcs)	Weight (kg)	EDP No.
C-90	877	660	0	12	0.9	621851
C-100	1078	900	1	16	1	621852
C-120	1318	1140	1	20	1.2	621853
C-150	1558	1380	1	24	1.4	621854
C-170	1798	1620	2	28	1.6	621855
C-200	2038	1860	2	32	1.8	621856
C-220	2278	2100	2	36	2.3	621859
C-250	2518	2340	3	40	2.6	621860
C-270	2758	2580	3	44	2.8	621861
C-300	2998	2820	3	48	3.1	621862

Power supply	Current consumption (mA) max.	Decay time ※	Frequency	Pulse ratio	Voltage level
24VDC±5%	600	within 0.8sec	10steps (0.1~50Hz)	+: 40~70% -: 60~30%	±10steps each

※Decay time :30Hz 10.5kVp-p 300mm directly below at 0.3MPa
 •Air supply pressure: 0 to 0.3MPa, Air supply hose diameter $\Phi 8 \times \Phi 6$ mm (Air supply port: PT1/8)
 •Accessories: Remote controller, Power cable (5m), End brackets (included with device), Middle brackets (included with device)
 •Option: AC Adapter AD24-IT-EX, AD24-ITCF-EX, AD24-IT19-EX, Power Supply cable (5m)CT-5

No. C-40/C-60 AC Pulse Ionizing Clean Bar

Ionizing method:Pluse AC corona discharge Applied voltage:8~12.5kVAC(p-p)

- Short type optimal for installation on a conveyor or in equipment.
- Consolidated terminals on the back side. Power can be supplied by daisy chain wiring.

Model No.	Overall length (mm)	Discharge needle useful length (mm)	Electrode needles (pcs)	Weight (kg)	EDP No.
C-40	422	240	5	0.78	621857
C-60	602	420	8	1.08	621858

Power supply	Current consumption (mA) max.	Decay time ※	Frequency	Pulse ratio	Voltage level
24VDC±5%	600	within 0.8sec	10steps (0.1~50Hz)	+: 40~70% -: 60~30%	±10steps each

※Decay time :30Hz 10.5kVp-p 300mm directly below at 0.3MPa
 •Air supply pressure: 0 to 0.3MPa, Air supply hose diameter $\Phi 8 \times \Phi 6$ mm (Air supply port: PT1/8)
 •Accessories: Remote controller, Power cable (5m), End brackets (included with device),
 •Option: AC Adapter AD24-IT-EX, AD24-ITCF-EX, AD24-IT19-EX, Power Supply cable (5m)CT-5

One point

AC Pulse Auto Balance Mode

The C series are equipped with a mode to optimally adjust the ion balance automatically according to the polarity of the charged object. (Target distance: 50 to 100 mm)

※C-series

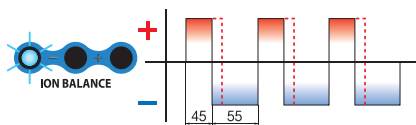
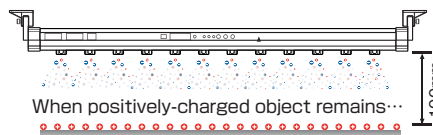

AC pulse method

Generating alternately positive ions and negative ions from each electrode. Since ions are generated at the maximum width of each positive and negative electrode cycle, the ion volume is high and static electricity can be removed quickly.

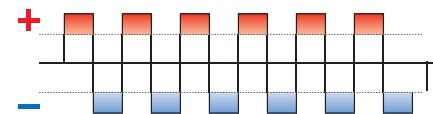

Typical alternating current

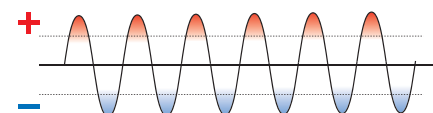

HAND TOOLS

BITS & SOCKETS

ELECTRIC TOOLS

AIR TOOLS

STATIC SOLUTIONS

GASOLINE ENGINE TOOLS

SH-series

No. SH-series Compact AC Pulse Ionizing Bar (separate power supply type)

- Ion balance can be adjusted by changing a pulse ratio.
- The main body is as compact as 30 × 33 mm, ideal for installation in cramped spaces.
- Use of a branch box enables multiple bars to be operated from one power supply equipment.
- High-voltage cable can be attached/detached from the bar's main body.

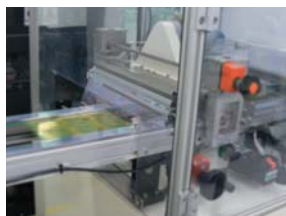
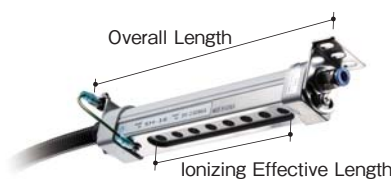

エアージェット機能

CE RoHS

Model No.	Overall length (mm)	Discharge needle useful length (mm)	Decay time ※ (sec.)	Electrode needles (pcs)	Weight (kg)	EDP No.
SH-16	218	105	within 0.5	8	0.36	621541
SH-20	258	135	within 0.5	10	0.40	621542
SH-30	338	210	within 0.5	7	0.42	621543
SH-40	443	315	within 0.5	10	0.50	621544
SH-50	548	420	within 0.5	13	0.57	621545
SH-60	653	525	within 0.5	16	0.63	621546
SH-70	758	630	within 0.5	19	0.70	621547

Decay time: 30Hz 10.5kVp-p Straight down 300mm at 0.3MPa
 Air supply pressure: 0 to 0.5MPa. Air supply hose diameter $\phi 6 \times \phi 4$ mm
 Options: Branch box SH-SP2, Relay cable (3m)SH-EC3, Relay cable (5m)SH-EC5

No. SH-G3 Power supply units

Ionizing method : Pluse AC corona discharge Applied voltage: 10.5kVAC p-p

- Equipped with two sockets for connecting the SH ionizing bars. They can be installed and wired easily.
- With the ion balance adjustment function (pulse ratio).
- Equipped with a safety circuit that shuts down the output if overcurrent or high-voltage error occurs.
- Lightest-weight body in the industry: 1.5kg.



PS E CE RoHS

Model No.	Input power supply	Power consumption (W)	Frequency (Hz)	Plus ratio	Weight (kg)	EDP No.
SH-G3	100~240V AC (50/60Hz)	10	30	+ : 40~70% - : 60~30%	1.5	621555

Accessories: AC Power cable 1.8m (for 100VAC and input) 2cables



HAND TOOLS

BITS & SOCKETS

ELECTRIC TOOLS

AIR TOOLS

STATIC SOLUTIONS

GASOLINE ENGINE TOOLS