

STAT·CLEAN **G2-E**
STATIC ERASER GUN

CE RoHS



Thank you for purchasing our Stat Clean No.G2-E.

Read this instruction manual before use. Keep it in a safe handy place for future reference.



Table of Contents

■For Your Safety	P.2
■Product Features.....	P.3
■Product Specifications.....	P.4
■External View.....	P.5
■Performance.....	P.5
■Installation	P.6
■Operation	P.8
■Maintenance	P.9
■Troubleshooting.....	P.11
■Storage.....	P.11
■Warranty	P.12

■ For Your Safety

Safety Precautions

- Carefully read these Safety Precautions before use. Observe the precautions indicated herein to ensure safety.
- Safety precautions in this instruction manual are categorized into two types by the degree of danger associated with each on the followings. Based on danger analyses performed by Vessel, all precautions in this instruction manual are of the CAUTION level.
- If the equipment is used in a manner not specified by the manufacturer, the protection provided by the equipment may be impaired.

	WARNING	Indicates that improper handling can lead to serious injury or even death.
	CAUTION	Indicates that improper handling can lead to minor injury and property damage.













This symbol indicates a WARNING or CAUTION.



This symbol indicates a prohibited action.



This symbol indicates a mandatory required action

 CAUTIONS	
 PROHIBITED	Do not use the G2-E in environments that require explosion-proofing. The G2-E is not of explosion-proof construction, therefore explosion or fire may occur.
 PROHIBITED	Do not use the G2-E in flammable atmospheres. The corona discharge can act as an ignition source and cause an explosion or fire.
 PROHIBITED	Do not use the G2-E in environments subjected to sharp temperature fluctuations or dewing. This kind of environment can lead to breakdown.
 DO NOT WET	Do not use the G2-E in highly damp places or anywhere it may be wet by water, oil, solvent or other liquid. Contact with moisture can result in electric shock or breakdown.
 PROHIBITED	Do not use the G2-E for anything other than removal of static electricity or dust.
 PROHIBITED	Do not use the G2-E with power supplies of ratings not specified in the specifications. Inappropriate power supplies can result in fire and electric shock.
 PROHIBITED	Do not install, use or service the G2-E until having understood the information in this instruction manual.
 REMEMBER	Keep this instruction manual in a safe handy place for future reference.
 CAUTION	Vessel assumes no responsibility whatsoever for consequences arising from the use of this product.

Special Features

* **Corona Discharge AC type**

AC Corona discharge method has an advantage of stable ion balance, not much influenced by contamination on the electrode needle.

High Frequency Voltage Transformer produces ions in its high performance with less production loss due to the ion recombination.

* **Changeable wiring direction upward or downward**

The wiring direction of the hose and the AC cable can be changed upward or downward according to the on-site layout. It can be upward by letting the hose and the cable into the dedicated groove on the grip.

This makes it easy to use the G2-E by hanging it from the top of a cell production table (e.g. when using a tool balancer).

* **Comfortable soft grip**

Body is made of polycarbonate which is light and chip-proof. The molded surface is made of elastomer, which is non-slip and easy-to-grip soft handle.

* **LED Indication**

You can confirm the operational status at one view, because an operation lamp is placed on the top side of the product.

- Operation ON indication: Pulling the trigger operates the product, and the lamp lights up in blue.
- High voltage alarm: When the built-in transformer detects the abnormal high voltage and shuts down the output, the lamp lights in red to show the abnormality.

* **Compact and Light-Weight**

Wiring with a high Voltage power supply cable is not necessary. High Frequency Voltage Transformer is built in for safety. Small and light-weight for easy handling.

The power source is 24VDC to supply the power with the AC adaptor (accessory).

* **Maintenance**

Electrode needle can be easily replaced with a dedicated screwdriver (option).

* **Environmentally Friendly**

Compliant with RoHS standards.

* **CE Compliance**

The G2-E has been tested and approved under CE directive, EN61000-6-4, 6-2.and CE-compliant.

Applications

Blow away dust or dirt caused by the electrostatic charge; static electricity removal to avoid dust adhesion on a product, and so on.

■ Product Specifications

ION/BEAM GUN

Model	: No. G2-E
Ion generation method	: High voltage AC corona discharge
Impressed voltage	: 4.5kVAC(P-P) approx.
Input voltage	: 24VDC \pm 5%
Power consumption	: 100mA (TYP.)
Dimensions	: L148 x H157 x W44(mm)
Weight	: 260g
Air consumption	: 0.1~0.6MPa
Ozone generation	: 0.05ppm or less (Measured at 50mm)
Warning output	: High voltage alarm output stop (Red LED)
Protective function	: Current fuse (0.5 A on the board)
Working ambient temperature / humidity	: 5~40°C 35~65%RH (No dew condensation or freezing)
Storage temperature/humidity	: 0~60°C 35~85%RH (No dew condensation or freezing)
Distance from target object	: 50~300mm (Installation:Indoor, non-hazardous area)
Static electricity removal time	: Refer to the table on the page 5.
Ion balance	: Within \pm 10V (At 0.3MPa and 150mm from the target)
Material	: Casing : Fire retardant polycarbonate and elastomer : Hook : SUS : Electrode Needle : Tungsten
Accessories	: Instruction Manual, AC Adapter

AC Adapter No.AD24-ITC

Rated input voltage	: 100-240VAC(50/60Hz) 0.4A (TYP.)
Rated output voltage	: 24VDC 0.75A
Working ambient temperature / humidity	: 0~40°C 5~95%RH (No dew condensation or freezing)
Cable length	: DC output cable:2.5m approx. AC input cable:1.8m approx.
Weight	: about 170g

*The measurement values were obtained on the VESSEL measurement environment and conditions, so error could be induced depending on the operation environment.

Replaceable Parts : Electrode Needle GN-H



Options : Tube-Fitting Nozzle G-7THN / AC Adapter AD24-ITC /

Speed Controller G-7SC G-7DR / Electrode Needle Replacement Screwdriver G-7DR

External View / Performance

No.G2-E

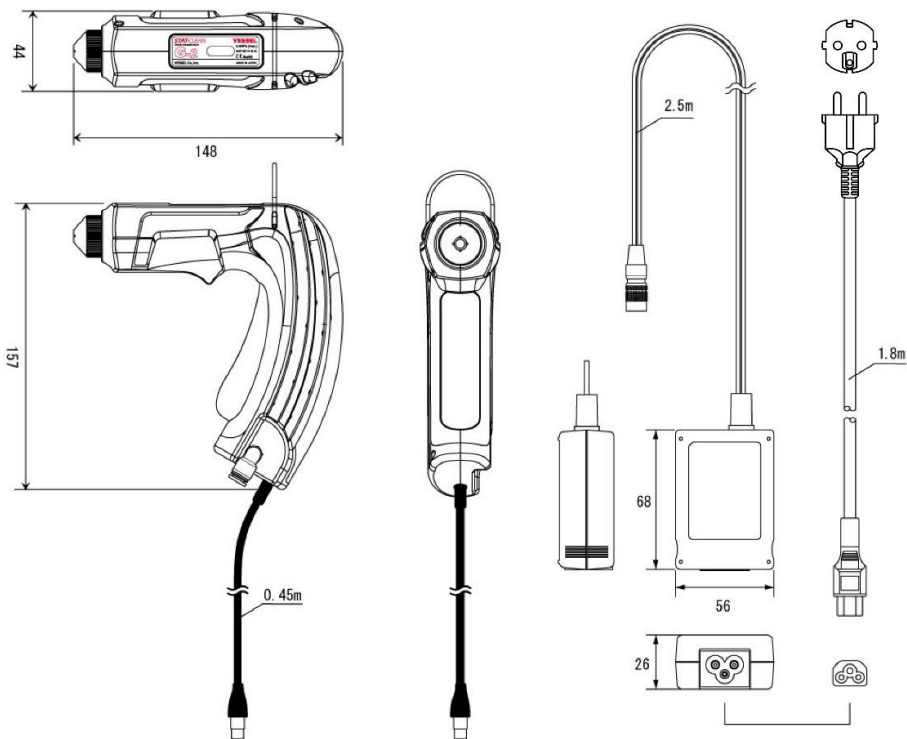







Static Elimination Performance

Air Pressure (MPa)		0.1	0.2	0.3	0.4	0.5	0.6
Air Volume (L/min)		66	111	153	193	233	279
Decay time	+1000V ↓ +100V (min)	1.2	0.7	0.6	0.5	0.5	0.4
	-1000V ↓ -100V (min)	1.2	0.8	0.6	0.5	0.4	0.4
Ion Balance (V)		-0.6	1.2	1.6	2.3	3.7	4.1

※Measured at 150mm from the target object.

■ Installation

 CAUTIONS IN INSTALLATION	
 REMEMBER	Use only the included power supply adapter. Use of other adapters may result in fire, electric shock and static electricity removal failure.
 REMEMBER	Use an air hose of sufficient withstanding pressure performance. Air hoses of insufficient withstanding pressure may rupture and leak air.
 REMEMBER	Install the G2-E in the following environment. Adverse environments cause product deterioration and breakdown. Humidity: 35~65%RH (No dew condensation or freezing) Temperature: 5~45°C
 PROHIBITED	Do not use the G2-E in the following environments. Adverse environments cause product deterioration and breakdown, as well as personal accidents. Where explosion-proofing is required; where in flammable atmospheres, high temperature and high humidity, or sharp temperature fluctuations; where dewing occurs; where possibly wet by water, oil or solvent.
 PROHIBITED	Do not pull excessively the hose and cable. Abusive handling can damage the gun and internally disconnect the power cable and air hose.

Installation place

Select a location that is suitable for work and near to an air source and 100-240V AC supply.

Hose

Use an air hose (OD ϕ 6 mm x ID ϕ 4 mm) of sufficient withstanding pressure performance.

Air

Remove all impurities with a mist separator (0.3 μ m). Remove all moisture with an air dryer.
(Dew-point temperature: -15°C or less)

Supply air at a temperature of 0~40°C.

*Be sure to supply clean air only because oil-mixed air may cause the discharge stop.

Grounding

Connect to the AC power source with a ground.

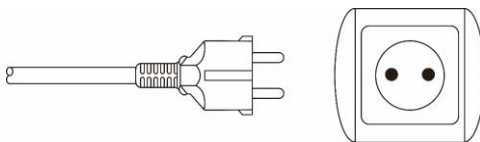

Points to be checked before use

1. Before use, check the G2-E, tube and power adapter for trouble.
2. Make sure that there is no damage, loose screws, disconnected hosing, loose connectors, or other defects.
3. Do not pull strongly the air hose or power cable when using.
4. Tightening strongly the trigger lever with a clamp, etc. may cause damage. Use this product within your grip strength.

Connector connection/Air hose connection

Connect the power cable from the body to the power supply connector of the provided AC adapter. Also confirm pin positions, insert and lock.

Insert the air hose into the joint at the bottom of the body.

* Banding the hose and cord together with banding bands (locally purchased item) makes it easy to work because the wires are bundled.

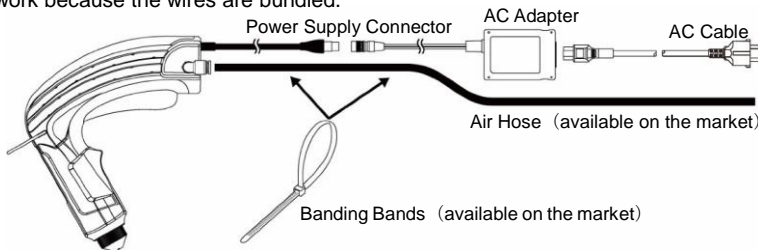

When wiring air hose and power cord from upside

It is possible to set the air hose and the power cable upward so as to hang the G2-E from above (e.g. balancer).

Procedures: 1) Insert the air hose through the hook from the above and the power cable (already connected to the casing) through the hook from below.

2) Let the hose and the cable into the dedicated groove on the casing completely as illustrated below.



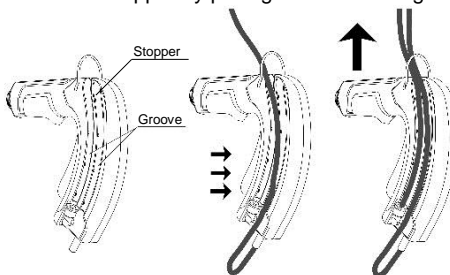



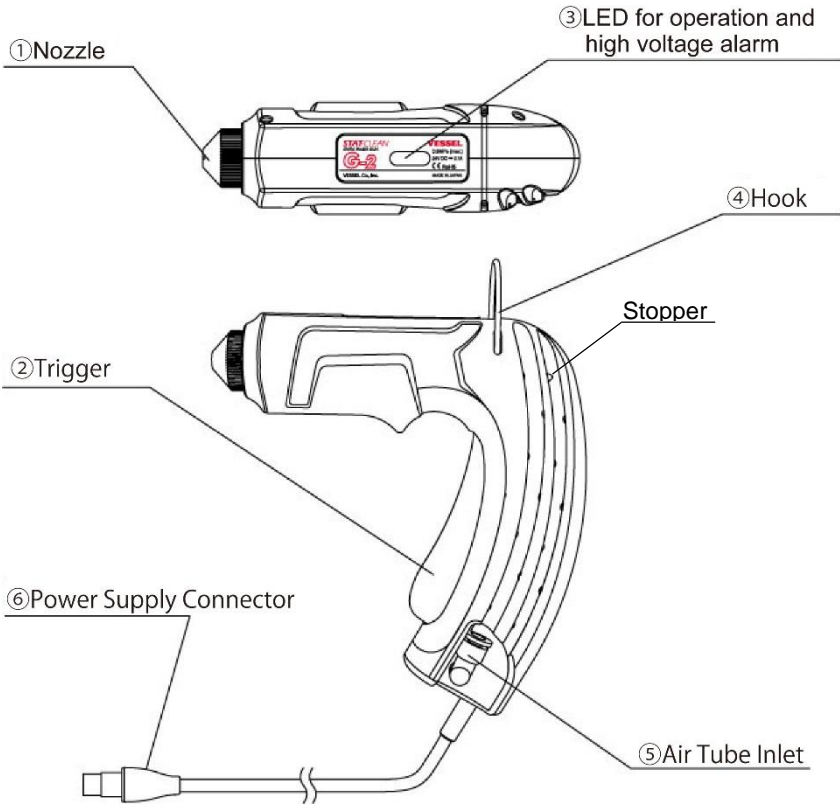



3) Please note that there is a stopper on the upper side of the groove for the power cable. Place the cable assuredly below this stopper by pulling it back with fingers.



■ Operation







- | | |
|--|--|
| 1.Nozzle | Air Blow Point Part which ejects air. According to the application, you can install the Tube-Fitting Nozzle (option) instead. |
| 2.Trigger | Pull the trigger for air blow and static electricity removal. |
| 3.LED for operation and high voltage alarm | LED lights during static electricity removal after pulling the trigger. H.V. ALARM LED lights at the time of high voltage abnormality. |
| 4.Hook | To hang on this gun while not in use. |
| 5.Air Tube Inlet | Air Tube connecting (Outer dia. 6mm x Inner dia. 4mm). |
| 6.Power Supply Connector | Power inlet fitting for attached power supply adapter (AD24-ITC-E). |

 CAUTIONS IN OPERATION	
 PROHIBITED	Do not use the G2-E for anything other than removal of static electricity or dust.
 REMEMBER	If noticing anything strange, stop using the G2-E immediately.
 REMEMBER	Supply clean dry air.
 REMEMBER	Mount the nozzle after cleaning the electrode needle for maintenance. If the G2-E is used without the nozzle, the electrode needle may fly off because of the air pressure.
 PROHIBITED	Do not remodel or disassemble the G2-E. The G2-E contains high voltage parts.
 PROHIBITED	Do not drop the G2-E or make high impacts on the G2-E.
 PROHIBITED	Do not pull excessively the tube. Abusive handling can damage the gun and internally disconnect the power cable and air hose.
 PROHIBITED	Do not damage the hose or cable. Keep the hose and cable away from sources of heat.
 REMEMBER	Before leaving the workplace, return the G2-E to the specified place.
 REMEMBER	Do not use the G2-E if it has a defect.

OPERATION

1. Make sure that the air tube is correctly connected;
2. Plug the power adapter into a 100-240V AC electrical outlet;
3. Make sure that the power supply connectors are rightly connected;
4. Regulate the air pressure by an air regulator in the range of 0.1 to 0.6MPa;
5. Make sure of the emission of ion air through the Nozzle by pulling the trigger; blow ion air towards the statically charged workpiece or dust-covered workpiece;
6. Release the trigger when static electricity and dust are removed.

■ Maintenance

 CAUTIONS IN MAINTENANCE AND CHECKS	
 DO NOT DISASSEMBLE	Do not perform any maintenance on the G2-E except for the electrode needle.
 REMEMBER	Before cleaning the electrode needle, shut OFF power and unplug the adapter from its electrical outlet. Shut off air supply at the source and disconnect the air hose.
 PROHIBITED	Do not wipe the G2-E with detergent or solvent. Substances of the sort can cause cracking and result in electric shock or breakdown.
 DO NOT WET	Do not wet the G2-E. Contact with moisture can result in electric shock or breakdown.

■ Maintenance

1. How to Clean the Gun Casing

Wipe off the dirt on the gun with soft and dried cloth.

Use the vacuum cleaner to remove the dust stained around body.

Do not use solvent such as alcohol or thinner, or detergent on the casing.

2. How to Clean the Electrode Needle

When performing a cleaning of electrode needle, be sure to pull the power supply adaptor off electric outlet.

Cleaning order:

1 .Remove the Nozzle.

2 .Clean the tip of the needle with cotton swab.

If it is heavily contaminated or dirty, use wet cloth with a few drops of alcohol.

3 .How to mount the Nozzle back.

Be sure that the Nozzle is fixed firmly.

If it is too tightly fastened, it may damage or break itself. If it is not firmly fixed, the Nozzle may be popped out due to it is air blow power.



3. How to Replace the Electrode Needle

When replacing the electrode needle, use the screwdriver G-7DR (optional).

Pull off Power Supply Adapter first before the cleaning of electrode needle.

Replacement Order:

1 .Remove the Nozzle.

2 .Release the electrode needle by loosening the threads with the screwdriver G-7DR.

3 .Change it with new needle (G-NH) and fasten firmly with the same screwdriver.

4 .Place the Nozzle back.

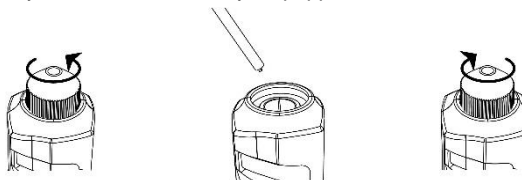

Mount the Nozzle firmly. If it is too tightly fastened, it may damage or break itself.

If it is not firmly fixed, the Nozzle may be popped out due to it is air blow power.



■ Troubleshooting

CAUTIONS IN TROUBLESHOOTING

 PROHIBITED	<p>Do not use the G2-E in the following situations. They can result in fire or electric shock.</p> <ul style="list-style-type: none"> *When the power cable is damaged or hot *When the G2-E has been damaged because of dropping or shock. *When the plug of AC adaptor does not fit the electric outlet.
 UNPLUG POWER CABLE	<p>Unplug power cable if the G2-E has a defect.</p>
 DO NOT DISASSEMBLE	<p>Do not disassemble the G2-E.</p>

Using the G2-E in anything but proper working condition, can cause product damage or personal accident.

Therefore, promptly request servicing if trouble occurs. For servicing, contact the place of purchase.

■ Storage

CAUTIONS IN STORAGE

 PROHIBITED	<p>Do not store the G2-E in the following places. Adverse environments can cause product breakdown;</p> <ul style="list-style-type: none"> ●Where exposed to marked vibrations or shock; ●Where temperature and humidity are outside specified ranges; ●Where dewing occurs; ●Where temperature fluctuates sharply; ●Where there is the possibility of ignition or explosion of flammable solvents, dust, etc; ●Where there is heavy dirt, dust, or smoke; ●Where possibly wet by water, oil , chemicals, etc; ●Where strong electric or magnetic fields are generated.
---	---

In the following cases, contact the place of purchase for servicing.

Do not service the G2-E yourself as this can be dangerous.

- * When the power lamp does not light when the trigger is pulled;
- * When air leaks from another place than the Nozzle;
- * When the power cable is excessively hot;
- * When the power supply adapter is excessively hot;
- * When the G2-E emits strange noises or vibrates during use;
- * When sparks are seen coming from electrode needle tip (In normal operation, sparks are not seen).

LIMITED WARRANTY:

VESSEL expressly warrants that for a period of one (1) year from the date of purchase, VESSEL static erasers will be free of defects in material (parts) and workmanship (labour). Within the warranty period, Defects occurring will be repaired or products will be replaced at VESSEL's option and expense, if VESSEL receives notice during the warranty period. Defective products must be returned to VESSEL Osaka Japan with proof of purchase date. And if your unit is out of warranty, VESSEL will quote repair charges necessary to ship your unit freight prepaid to where you have originally purchased.

WARRANTY EXCLUSIONS:

THE FOREGOING EXPRESS WARRANTY IS MADE IN LIEU OF ALL OTHER PRODUCT WARRANTIES, EXPRESSED AND IMPLIED, INCLUDING FITNESS AND MERCHANTABILITY AND FITNESS FOR A PARTICULAR PURPOSE WHICH ARE SPECIFICALLY DISCLAIMED.

The express warranty will not apply to defects or damage due to accidents, neglect, misuse, alterations, operator error, or failure to properly maintain, clean, or repair products.

LIMIT OF LIABILITY:

This electronic static eraser use high voltage corona discharge and should not be used in or near flammable or explosive environments. In no event will VESSEL or any seller is responsible or liable for any injury, loss or damage, direct or consequential, whether based in tort or contract arising out of the use of or the inability to use the product. Fulfillment of VESSEL's warranty obligations will be Customer's exclusive remedy and VESSEL's and Seller's limit of liability for any breach of warranty or otherwise. Before using this unit, users shall determine the suitability of the product for their intended use, and users assume all risk and liability whatsoever in connection therewith.

Model	G2-E	
Warranty	(1) year from the date of purchase	
Customer	Name	
	Address	
	Tel. No.	
Dealer	Name/Address/Tel. No.	

Manufactured by:**VESSEL Co., Inc.**

17-25, Fukae-Kita 2-chome,
Higashinari-ku, Osaka 537-0001 Japan
Tel : +81 6 6976 7778 Fax : +81 6 6972 9441
E-mail : export@vessel.co.jp
URL : http://www.vessel.jp

Product of Japan
15082000.00000

Advice to use the G2-E for a long time

In the case of using the G2-E with the hose and the cable dropping down, please band them with the provided “self-fusion butyl rubber tape”, by bowing the power cable as shown in the photograph below.

It can prevent the air hose and the power cable from scattering, and it can also improve durability of the power cable.

Making an extra space by bowing the power cable reduces the load on the connector and the connecting area with the main unit.

Also it is recommended, for the same result, to band the hose and the cable somewhere on the opposite side of the intermediate connector.

3 sheets of tape are enclosed. You may band another area of these cables with the remaining 1 piece, taking into consideration the actual work and/or wiring.

- The tape should be prepared by the user if additionally needed. The provided sheet is made by cutting the following tape to 105 mm in length each.

<Recommended article>

Self-fusion butyl rubber tape No.15 made by NITTO

[Size: thickness x width x length] 0.5 mm x 19 mm x 10 m

