**User's
Manual**

**AQ6375B
Optical Spectrum Analyzer**

Thank you for purchasing the AQ6375B Optical Spectrum Analyzer. This instrument enables high speed measurement of the optical properties of LD and LED light sources, optical amps, and other devices. To improve ease of use, it includes mouse-based user operation and a brand-new zoom function.

This getting started guide describes the instrument's functions, operating procedures, and handling precautions, and provides other important information for use of the instrument. For correct operation, please read this manual thoroughly before use. After reading this manual, keep it in a convenient location for quick reference in the event a question arises during operation. There are three manuals for the AQ6375B including this one. Read them along with this manual.

List of Manuals

Manual Title	Manual No.	Description
AQ6375B Optical Spectrum Analyzer User's Manual	IM AQ6375B-01EN	This manual. The manual is located on the CD included in your package (pdf format). Explains all functions and operating procedures of the AQ6375B except remote control and program functions.
AQ6370C/AQ6370D/AQ6373/AQ6373B/AQ6375/AQ6375B Optical Spectrum Analyzer Remote Control User's Manual	IM AQ6370C-17EN	The manual is located on the CD included in your package (pdf format). Explains functions for controlling the instrument with communication commands and program functions.
AQ6375B Optical Spectrum Analyzer Getting Started Guide	IM AQ6375B-02EN	Provided as a printed manual. This guide explains the handling precautions, basic operations, and specifications of the AQ6375B.
Model AQ6375B-01 AQ6375B Optical Spectrum Analyzer Limited model	IM AQ6375B-51EN	Explains the specifications of the limited model of the AQ6375B.
AQ6375B Optical Spectrum Analyzer	IM AQ6375B-92Z1	A document for China.

The "-EN" in the manual number is the language code.

Contact information of Yokogawa offices worldwide is provided on the following sheet.

Document Description	Description
PIM 113-01Z2	List of worldwide contacts

Notes

- The contents of this manual are subject to change without prior notice as a result of improvements in the instrument's performance and functions. Display contents illustrated in this manual may differ slightly from what actually appears on your screen.
- Every effort has been made in the preparation of this manual to ensure the accuracy of its contents. However, should you have any questions or find any errors, please contact your nearest YOKOGAWA dealer.
- Copying or reproducing all or any part of the contents of this manual without the permission of YOKOGAWA is strictly prohibited.

Trademarks

- Microsoft and Windows are trademarks or registered trademarks of Microsoft Corporation in the United States and/or other countries.
- Adobe and Acrobat are trademarks or registered trademarks of Adobe Systems incorporated.
- The company and product names used in this manual are not accompanied by the trademark or registered trademark symbols (TM, ®)
- Other company and product names are trademarks or registered trademarks of their respective companies.

Revisions

- 1st Edition: November 2015
- 2nd Edition: October 2017

Symbols and Notation Used in This Manual

Safety Markings

The following markings are used in this manual.



Improper handling or use can lead to injury to the user or damage to the instrument. This symbol appears on the instrument to indicate that the user must refer to the user's manual for special instructions. The same symbol appears in the corresponding place in the user's manual to identify those instructions. In the manual, the symbol is used in conjunction with the word "WARNING" or "CAUTION."

WARNING

Calls attention to actions or conditions that could cause serious or fatal injury to the user, and precautions that can be taken to prevent such occurrences.

CAUTION

Calls attentions to actions or conditions that could cause light injury to the user or damage to the instrument or user's data, and precautions that can be taken to prevent such occurrences.

French

AVERTISSEMENT

Attire l'attention sur des gestes ou des conditions susceptibles de provoquer des blessures graves (voire mortelles), et sur les précautions de sécurité pouvant prévenir de tels accidents.

ATTENTION

Attire l'attention sur des gestes ou des conditions susceptibles de provoquer des blessures légères ou d'endommager l'instrument ou les données de l'utilisateur, et sur les précautions de sécurité susceptibles de prévenir de tels accidents.

Note

Calls attention to informn that is important for proper operation of the instrument.
on that is important for proper operation of the instrument.

Notations Used on Pages Describing Operating Procedures

On pages that describe the operating procedures in Chapter 3 through 11, the following notations are used to distinguish the procedures from their explanations.

Procedure

This subsection contains the operating procedure used to carry out the function described in the current chapter. All procedures are written with inexperienced users in mind; experienced users may not need to carry out all the steps.

Explanation

This subsection describes the setup parameters and the limitations on the procedures. It may not give a detailed explanation of the function. For a detailed explanation of the function, see chapter 2.

Notations Used in the Procedures

Panel Keys and Soft keys

Bold characters used in the procedural explanations indicate characters that are marked on the panel keys or the characters of the soft keys displayed on the screen menu.

Unit

k: Denotes "1000."	Example: 100kS/s
K: Denotes "1024."	Example: 459KB (file data size)

Flow of Operation

The figure below is provided to familiarize the first-time user with the general flow of this instrument operation. For a description of each item, see the relevant section or chapter.

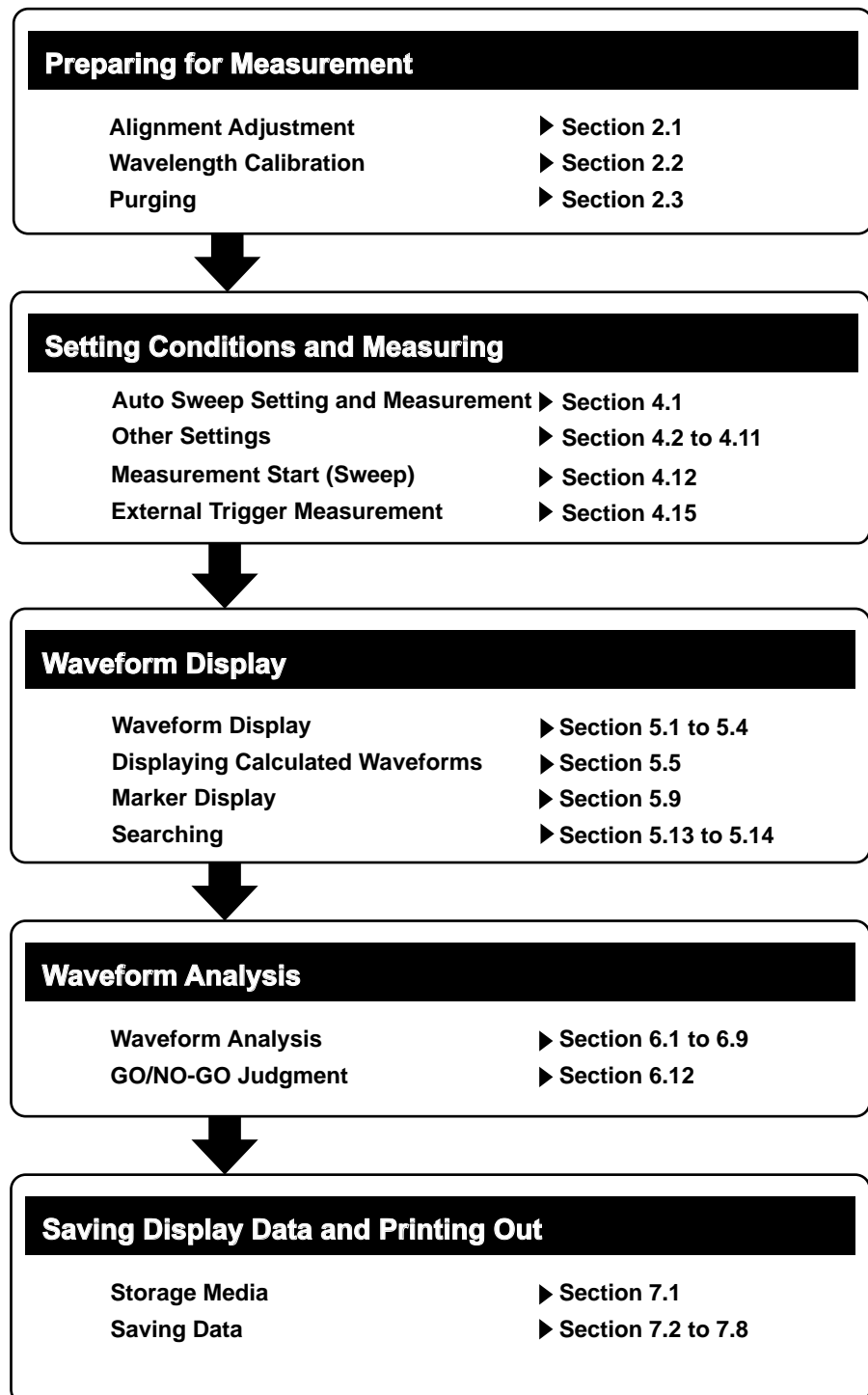

Contents

Symbols and Notation Used in This Manual	iii
Flow of Operation.....	v

Chapter 1 Functions

1.1 System Structure	1-1
1.2 Measurement	1-2
1.3 Waveform Display	1-7
1.4 Analysis	1-12
1.5 Other	1-14

Chapter 2 Preparing for Measurement









▲ 2.1 Alignment Adjustment.....	2-1
▲ 2.2 Wavelength Calibration	2-4
▲ 2.3 Purge.....	2-8
2.4 Important Points During Measurement.....	2-12

Chapter 3 Common Operations

3.1 Description of Soft Keys	3-1
3.2 Using the Mouse and External Keyboard.....	3-3
3.3 Entering Numerical Values and Strings.....	3-5
3.4 Screen Display	3-7
3.5 Setting the Date and Time.....	3-8

Chapter 4 Measurement

4.1 Auto Measurement	4-1
4.2 Horizontal/Vertical Axis Settings.....	4-2
4.3 Sub Scale	4-7
4.4 Setting the Reference Level	4-11
4.5 Center Wavelength (Center Frequency / Center Wavenumber) Setting	4-15
4.6 Sweep Width Settings	4-21
4.7 Wavelength (Frequency / Wavenumber) Resolution Settings.....	4-25
4.8 Sampling Point/Interval Settings	4-27
4.9 Sensitivity Settings	4-29
4.10 Sweep Speed Settings.....	4-31
4.11 Averaging Times Setting.....	4-32
4.12 Trace Settings	4-33
4.12 Measurement Start (Sweep)	4-35
4.14 Specifying a Sweep Range	4-37
4.15 Pulse Light Measurement.....	4-38
4.16 External Trigger Measurement.....	4-43
4.17 Trigger Output	4-47
4.18 Smoothing	4-48
4.19 Analog Out	4-49

Chapter5	Waveform Display		1
5.1	Zooming In/Out on Waveforms.....	5-1	
5.2	Wavelength Updating/Fixing.....	5-8	2
5.3	MAX/MIN HOLD Display	5-10	3
5.4	Sweep Average	5-11	4
5.5	Displaying Calculated Waveforms.....	5-13	5
5.6	Normalized Display	5-18	
5.7	Curve Fitting	5-19	6
5.8	Power Density Trace	5-25	7
5.9	Marker Display	5-26	8
5.10	Displaying a Split Screen	5-44	9
5.11	Noise Mask.....	5-46	10
5.12	Copying and Clearing Traces.....	5-48	11
5.13	Single Search.....	5-50	App
5.14	Multi Search	5-54	Index
Chapter 6	Analysis		
6.1	Spectrum Width Measurement.....	6-1	
6.2	Notch Width Measurement.....	6-4	
6.3	SMSR Measurement	6-6	
6.4	POWER Measurement.....	6-8	
6.5	DFB-LD, FP-LD, and LED Measurement	6-9	
6.6	PMD Measurement	6-10	
6.7	WDM Transmission Signal Analysis (Except Wavenumber Mode)	6-12	
6.8	Optical Amp Gain and NF Measurement (Except Wavenumber Mode)	6-19	
6.9	Optical Filter Characteristics Measurement (Except Wavenumber Mode).....	6-26	
6.10	Editing the Grid Table (Except Wavenumber Mode)	6-35	
6.11	Measurement of Level Fluctuations in Single-Wavelength Light (0 nm Sweeping).....	6-39	
6.12	Go/No-Go Judgment (Template)	6-42	
6.13	Specifying an Analysis Range	6-54	
6.14	Correcting Displayed Values	6-57	
6.15	Analysis Data Logging.....	6-60	
Chapter 7	Saving/Loading Data		
7.1	USB Storage Media.....	7-1	
7.2	Temporarily Saving and Redisplaying Traces to and from Internal Memory	7-2	
 7.3	Saving/Loading Displayed Data	7-6	
 7.4	Saving/Loading Displayed Data(All Trace).....	7-22	
 7.5	Saving/Loading Setting Data	7-28	
 7.6	Saving/Loading Analysis Results Data	7-33	
 7.7	Saving/Loading Program Data	7-41	
 7.8	Saving Screen Image Data	7-47	
 7.9	Saving/Loading Template Data.....	7-51	
 7.10	Saving and Loading Logging Data	7-57	
 7.11	Creating Files	7-63	

Chapter 8 Other Operations

8.1	Registering Soft keys	8-1
8.2	Data Initialization	8-2
8.3	Help	8-17
8.4	Registering and Loading Character Strings	8-18
8.5	Locking Keys	8-19
8.6	Other Settings	8-21
8.7	Displaying System Information	8-26

Chapter 9 Maintenance

9.1	Updating the Firmware	9-1
9.2	Mechanical Inspection	9-4
9.3	Operational Inspection	9-5
9.4	Inspection of Wavelength Accuracy	9-6
9.5	Inspection of Level Accuracy	9-7
9.6	Replacing Fuses	9-8
 9.7	Daily Maintenance	9-9
9.8	Care during Storage	9-11
9.9	Recommended Replacement Parts	9-12
9.10	Warning Display Function	9-13

Appendix

Appendix 1	GRID Table for WDM Wevelength	App-1
Appendix 2	Data Calculation Algorithms for Spectrum Widths	App-2
Appendix 3	Details of Each Analytical Functions	App-11
Appendix 4	Detailed Explanations of WDM Analysis Function	App-19
Appendix 5	Details of Optical Amplifier Analysis Function	App-30
Appendix 6	Details of Optical Filter Analysis Function	App-33
Appendix 7	Soft Key Tree Diagram	App-50
Appendix 8	END USER LICENSE AGREEMENT	App-69

Index

1.1 System Structure

System Structure

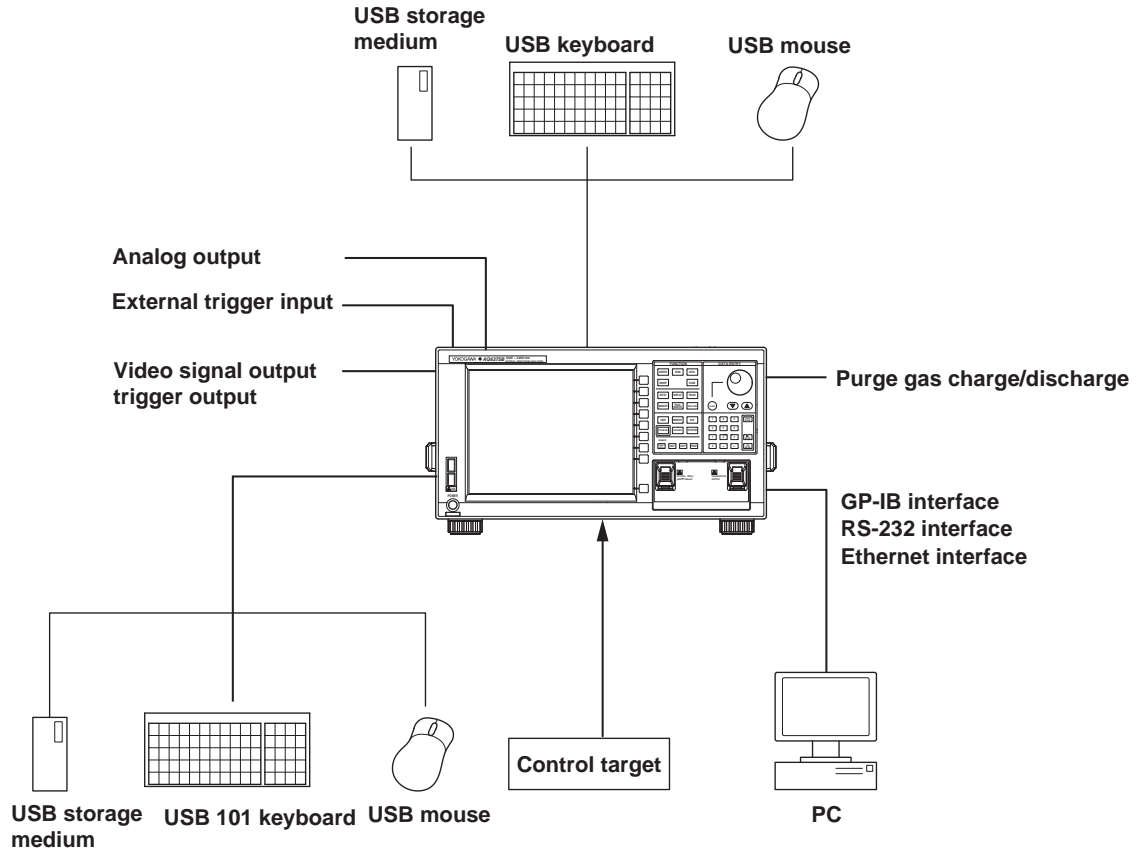

1.2 Measurement

Alignment Adjustment <<See section 2.1 for the operating procedure>>

This function allows adjustment of the optical axis of the instrument's built-in monochromator (spectroscope).

The instrument's optical performance is not guaranteed until the alignment adjustment function has been executed. Failure to perform this adjustment can result in distortion of measured waveforms. After alignment adjustment has been executed, wavelength calibration is also subsequently performed automatically. If you are using the instrument for the first time or using it after it has been severely shaken while being moved, perform the alignment adjustment procedure after warm-up ends.

Wavelength Calibration <<See section 2.2 for the operating procedure>>

Wavelength calibration can be performed using the internal reference light source or an external light source.

Purge

<<See section 2.3 for the operating procedure>>

In a typical measurement environment, water vapor contained in the air inside the monochromator, which is integrated in the AQ6375B, absorbs light. Purge is a function that continuously supplies purge gas such as nitrogen gas through the PURGE GAS IN port on the rear panel of the AQ6375B to the monochromator in order to eliminate moisture contained in the internal air (the PURGE GAS OUT is open).

This reduces the effects of light absorption in measurements.

Auto Measurement <<See section 4.1 for the operating procedure>>

This function automatically sets the optimal measuring conditions for the input light and displays the spectrum waveform. This function is useful when the characteristics of the input light are not well known.

The wavelength range of input light that can be auto-measured is 1200–2400 nm.

The measurement conditions that are set automatically are as follows.

1. Span (SPAN)
2. Center wavelength (CENTER)
3. Reference level (REF LEVEL)
4. Resolution (RESOLUTION)

Other measuring conditions (sensitivity, averaging times, number of sampling points, and interval settings) are set to their defaults. The horizontal and vertical axes of the displayed spectrum waveform are zoomed to an appropriate degree.

Single Sweep <<See section 4.13 for the operating procedure>>

This function executes a single sweep or forcibly stops a sweep operation.

Repeat Sweep <<See section 4.13 for the operating procedure>>

This function performs repeat sweeping or forcibly stops a sweep operation. It enables repeated, real-time measurement of waveforms.

Marker-to-marker sweep <<See section 4.14 for the operating procedure>>

This function enables sweeping between two specified waveform line markers. You can sweep an arbitrary interval on screen.

Segment Measurement <<See section 4.13 for the operating procedure>>

This function allows you to divide up items to be measured in units of previously specified segments.

Allows measurement delimited by segments (portions).

Smoothing <<See section 4.18 for the operating procedure>>

This function attenuates the noise in the measured waveform. By using the Smoothing function, areas on the waveform with a large amount of noise can be “smoothed out” when measured.

One-Action Keys <<See section 4.4 to 4.6, 5.1 and 5.9 for the operating procedure>>

This is the general name for a key that uses data from the active trace waveform (the currently displayed waveform) to set measurement conditions.

Setting conditions requires that a waveform is displayed for the active trace.

One-Action Key Name	Description
PEAK → REF LEVEL	Sets the peak level of the measured waveform of the active trace as the reference level.
MARKER → REF LEVEL	Sets the moving marker level as the reference level.
PEAK → CENTER	Sets the peak wavelength (frequency / wavenumber) of the active trace measurement waveform to center wavelength (frequency / wavenumber)
MEAN WL → CENTER	Sets THRESH 3 dB center wavelength (frequency / wavenumber) of the active trace measured waveform to center wavelength (frequency / wavenumber).
VIEW → MEAS	Sets the currently displayed ZOOM scale as the measurement scale (CENTER, START, STOP, SPAN) for the next sweep.
MARKER → CENTER	Sets the wavelength (frequency / wavenumber) of the moving marker to center wavelength (frequency / wavenumber).
$\Delta\lambda$ → SPAN	Sets the sweep width as six times the RMS 20 dB width of the active trace measurement waveform.
MKR L1-L2 → SPAN	Sets spacing between line markers 1 and 2 for sweep width.
PEAK → ZOOM CTR	Sets the peak wavelength (frequency / wavenumber) of the active trace measurement waveform to center wavelength (frequency / wavenumber) of zoom display.
MARKER → ZOOM CTR	Sets the wavelength (frequency / wavenumber) of the moving marker to center wavelength (frequency / wavenumber) of zoom display.
MKR L1-L2 → ZOOM SPAN	Sets spacing between line markers 1 and 2 for sweep width of zoom display.

Switching between Vacuum Wavelength and Air Wavelength**<<See section 4.2 for the operating procedure>>**

This function switches the measured wavelength to either a vacuum wavelength or an air wavelength.

Measurement can be performed in either air or vacuum wavelength mode.

Switching among Wavelength, Frequency and Wavenumber**<<See section 4.2 for the operating procedure>>**

This function switches the horizontal axis display to wavelength / frequency / wavenumber.

You can display either the wavelengths or frequencies of marker values and analysis results.

Averaging <<See section 4.10 for the operating procedure>>

This function performs multiple measurements and displays the average values. The function is used in cases such as: when the light source's level is fluctuating; when measuring a modulated signal of several kHz or less; when the waveform is disrupted and difficult to measure; when it is necessary to obtain even higher measurement sensitivity.

Power spectral density Display <<See section 6.4 for the operating procedure>>

The power per 1 nm is called the power spectral density. The level axis of the AQ6375B indicates the absolute power per wavelength resolution. For example, if the resolution is set to 0.1 nm, the power per 0.1 nm will be displayed. Since the optical spectrum of such devices as a gas laser or a laser diode is narrower than the wavelength resolution of the instrument, the entire power is accommodated within the band of a resolution. Therefore, the measured power (peak level) is equal to the total power of the light source. This instrument has been calibrated to display accurate power under such conditions.

On the other hand, natural light or lights such as fluorescent lamps or LEDs, have, in many cases, optical spectrums wider than the wavelength resolution set for the instrument. Therefore, if the instrument measures these lights, measured power will vary, depending on the resolution setting.

In order to deal with this issue, the instrument is equipped with the dBm dBm/nm soft key to allow the level axis displays to switch from the absolute power (dBm, mW, μ W, nW, pW) per resolution to power spectral density (dBm/nm, mW/nm, μ W/nm, nW/nm, pW/nm).

In the case of power spectral density displays, a measured value is converted to power per 1 nm. Therefore, whatever resolution is used for measurement, certain measured values will always be available.

Differences in usage between the absolute power display and the power spectral density display are shown below:

Absolute power display: measurement of light sources with narrow spectrum widths, such as gas lasers or laser diodes.

Power spectral density display: measurement of light sources with wide spectrum widths, such as natural light or LEDs.

If the subtraction function between traces is used for such cases as $A-B(A/B) \rightarrow C$ or $B-A(B/A) \rightarrow C$, results will be the same whether the absolute power display or the power spectral density display is used.

Since the power measurement function performs different calculations according to the level axis display, correct results will be available whichever display is employed.

Note that, if the NF measurement function (ANALYSIS 2 EDFA-NF soft key) and the WDM analysis function (ANALYSIS 2 WDM soft key) are executed, the level axis display will be forcibly changed to the absolute power display.

Note

Specifications such as level accuracy, measurement level range, and level linearity of the instrument are provided for the absolute power display.

External Trigger Measurement <<See section 4.15 for the operating procedure>>

This function performs measurement in synchronization with an external trigger signal. The SMPL TRG IN terminal is an input terminal on the TTL level and in positive/negative logic (which can be set by the <EXT TRIGGER SETTING> key). The SMPL TRG IN terminal is an input terminal for TTL level, positive/negative logic signals. The measurement points (wavelength/frequency) are incremented each time edges of input external trigger signals are detected. Thus, sweeping stops when a number of external trigger signals equaling the specified number of sampling points is input. (However, when the REPEAT sweep is performed, the sweep will be repeated until the **STOP** key is pressed or until trigger signals are no longer input.)

The delay time (from the time when a trigger signal is detected until the time when the sampling is performed) specific to the instrument is about 20 μs . Supply the trigger signal at a timing appropriate for the measurement sensitivity. An optional delay time can be set to this specific delay time. With the DELAY key of the EXT TRIGGER SETTING key, the 0.0 μs to 1000.0 μs range can be set in units of 0.1 μs .

Note that after the measurement points are set, input trigger signals during the movement to the next measurement point are ignored. The time varies depending on the measurement wavelength band and the number of sampling points (sampling intervals). Since the SMPL TRG IN terminal is pulled up internally, it can be set to the HIGH level while it is in the open state and to the LOW level while it is in the GND short state.

Sweep Trigger <<See section 4.15 for the operating procedure>>

This function performs a single sweep measurement based on an externally input trigger signal.

The instrument starts a single sweep measurement by allowing sweep trigger signals on the TTL level and in negative logic to enter the TRGGER IN terminal at the back of the instrument.

The signal logic of the sweep trigger input signals is fixed to negative logic, which cannot be changed.

The pulse width of sweep trigger signals must be 5 ms or more.

The action when entering a sweep trigger is the same as that for the SWEEP key or SINGLE key.

The sweep trigger function detects sweep trigger signals by polling in certain cycles.

Thus, the time after a sweep trigger signal is input until the sweep starts will fluctuate in the range of 5 ms.

Trigger Output <<See section 4.16 for the operating procedure>>

This function outputs trigger signals from the trigger output terminal on the rear panel of the instrument (only during sweeping).

Analog Out <<See section 4.17 for the operating procedure>>

An analog voltage is output from the ANALOG OUT terminal on the rear panel of the main unit according to the input light.

The temporal changes in the input light can be measured by an oscilloscope.

However, to enable this output, the sensitivity setting must be NORM/HOLD.

When set to NORM/HOLD, the RANGE is switched relative to the REF LEVEL without implementing the AUTORANGE function. Therefore, if the level of the input light is high, the output voltage level is saturated.

The saturation level and noise level varies depending on the REF level.

The table below shows the relationship between the REF level and the saturation level.

REF LEVEL(dBm or dBm/nm)	Saturation Level * (dBm)
REF > 0	23 dBm or more
0 <= REF > -10	13 dBm or more
-10 <= REF > -20	3 dBm or more
-20 <= REF > -30	-7 dBm or more
-30 <= REF	-17 dBm or more

* At wavelength 1450 to 1620 nm

ANALOG OUT Output Specifications

Output saturation voltage	+6 V or more
Offset voltage (including noise)	±5 mVp-p
Bandwidth	10 kHz or more
Load	1 kΩ or more

1.3 Waveform Display

Zoom

<<See section 5.1 for the operating procedure>>

This function allows you to zoom freely in and out on measured waveforms.

You can easily zoom an area simply by selecting it with the mouse. Drag the mouse over an area of the displayed waveform to zoom in on the area. ZOOMING is displayed at the bottom of the screen to indicate that the screen is displaying a zoomed area. You can also zoom in and out with key operations.

Overview

<<See section 5.1 for the operating procedure>>

This function displays an overview window at the very bottom of the waveform display area. The overview window is displayed when the waveform display is enlarged or reduced using the zoom function. (Only displayed when a zoom is performed.)

You can easily check which part of the measured waveform is zoomed. The overview window can be shown or hidden, and you can change its position and size.

Trace

<<See section 4.11 for the operating procedure>>

A trace shows a waveform and measurement conditions. The instrument has a total of seven independent traces (A through G). Multiple traces can be displayed at the same time on the waveform screen. In addition, display ON/OFF and mode settings can be set separately for each trace.

Traces can be set to the following modes.

- WRITE mode Section 5.2
- FIX mode Section 5.2
- MAX/MIN HOLD mode Section 5.3
- ROLL AVG mode Section 5.4
- CALCULATE mode Section 5.5

The following explains each of the modes.

WRITE Mode

Waveform data are written during sweeping.

When a trace is set to WRITE mode, waveform data are written during measurement, and the data are updated. Traces used in measurements are normally set to WRITE mode. The trace display at the side of the data area changes to "WRITE."

FIX Mode

Fixes the data; does not write waveform data.

When a trace is set to FIX mode, its waveform data are not overwritten even when measurement is performed. Therefore, the waveform on the screen is not overwritten. If you want to fix the waveform data of a trace, set the trace to FIX mode. The trace display at the side of the data area changes to "FIX."

MAX/MIN HOLD Mode (Maximum/Minimum Value Detection Mode)

Writes the maximum/minimum values of the waveform data for each sweep.

When a trace is set to MAX/MIN HOLD mode, each time a sweep is performed, the data at the individual measurement points are compared with prior measurements, and the measurement with the higher level (MAX HOLD) or lower level (MIN HOLD) is written. If you want to measure the maximum or minimum value of a waveform which changes each time a sweep is performed, set the trace you want to measure to MAX/MIN HOLD mode and perform REPEAT sweeping.

The trace display at the side of the data area appears as "MAX HOLD" or "MIN HOLD". Note that the NOISE MASK soft key setting applies when a waveform is displayed, and is not affected when a maximum or minimum value is detected.

ROLL AVG Mode (Rolling Average Mode)

Writes the rolling average values of the waveform data during each sweep.

When a trace is set to ROLL AVG mode, each time measurement is performed the rolling average of the current measurement and past measurements is calculated, and the measurement data are updated. The number of averagings is set in the range of 2 to 100. The trace display at the side of the data area changes to "ROLL AVG".

CALCULATE Mode (Calculation Results Display)

Writes the results of calculations performed between data from different traces.

When a trace is set to CALCULATE mode, subtraction between data from different traces, normalized display, or curve-fit display is performed according to the set CALCULATE mode. Note that CALCULATE mode can only be set for traces C, F, and G. Also, the available calculations vary from trace to trace. For more information, see chapter 6.

Normalized Display Function <<See section 5.6 for the operating procedure>>

This function is one of the trace CALCULATE modes. It normalizes and displays the trace data.

With normalized display, normalization is performed and the waveform is displayed with the waveform peak set to 1 if the sub-scale is linear, or set to 0 dB if the sub-scale is LOG. One trace can be normalized, either trace A, B, or C. If both traces selected for calculation are set to "BLANK", then the sub-scale is displayed on the left side of the screen. Otherwise it is displayed on the right side. The calculation results are displayed in the sub-scale. The trace display at the side of the data area changes to "NORM @".

Curve Fit

<<See section 5.7 for the operating procedure>>

Makes an approximation of the specified trace waveform. The result is written to TRACE G. Calculations are applied to data from the peak to the threshold value. The threshold value is set in the range of 0 to 99 dB (steps of 1). The trace display at the side of the data area changes to "CRV FIT @."

Peak Curve Fit

<<See section 5.7 for the operating procedure>>

Makes an approximation of the specified trace waveform. The result is written to TRACE G. Calculations are applied to mode peaks at or above the threshold value. The threshold value is set in the range of 0 to 99 dB (steps of 1). The trace display at the side of the data area changes to "PKCVFIT @".

Marker Functions <<See section 5.9 for the operating procedure>>

Marker functions can be used to easily measure wavelength differences and level differences, and to search for peak wavelengths, peak levels, and spectrum widths. There are markers and line markers.

Markers

A total of 1025 markers (one moving marker and 1024 fixed markers) are provided. Moving markers can be moved to an arbitrary wavelength using the rotary knob, arrow keys, or numeric key pad. You can also drag the markers with the mouse. Moving markers can be moved over a waveform to display the marker values (wavelength and level value) in the data area. If a moving marker is fixed in an arbitrary position, it changes to a fixed marker.

Fixed markers are markers fixed to a number on which the moving marker was set. Fixed markers are assigned marker numbers in order starting from 001. You can enter an arbitrary number using the rotary knob, arrow keys, or numeric key pad. A number up to 1024 can be set. When multiple fixed markers are set, it is possible to display wavelength differences and level differences between a given marker and adjacent markers.

Line Markers

There are four line markers—two wavelength line markers and two level line markers. Wavelength line markers show wavelength and wavelength difference, and level line markers show level values and level difference. Also, you can use line markers to specify a sweep or analysis range.

Advanced Markers

There are four advanced markers.

There are three types of advanced markers: moving marker, power density marker, and integrated power marker. Advanced markers can be placed on any of the waveforms from trace A to G.

Each marker can be moved to an arbitrary wavelength using the rotary knob, arrow keys, or numeric keypad.

You can also drag the markers with the mouse.

Moreover, you can use the search function to move the marker to the peak of the target waveform.

Advanced markers measure the following values.

- **Moving markers**
Moving markers move along the waveform and show marker values (wavelength and level) in the data area.
They are the same as the moving markers described above, except they do not have the fixed marker function.
- **Power density markers**
Power density markers move along the waveform and show marker values (power values per normalization bandwidth) in the data area.
- **Integrated power markers**
Integrated power markers move along the waveform and show marker values (integrated power value over the specified wavelength range) in the data area.

Single Search

- **PEAK SEARCH**

A peak search (a search for the maximum value) is performed on the marker trace waveform.

An advanced marker is displayed at the peak point, and the marker value is displayed in the data area.

If the peak level is off the screen, its marker is displayed at the top or bottom edge of the screen. Even in this situation, the correct marker value is displayed.

After the measurement has been completed, you can use the rotary knob to move the moving marker.

You can use the arrow keys to scroll through the data area.
- **BOTTOM SEARCH**

A bottom search (a search for the minimum value) is performed on the marker trace waveform.

An advanced marker is displayed at the bottom point, and the marker value is displayed in the data area.

If the bottom is off the screen, its marker is displayed at the top or bottom edge of the screen. Even in this situation, the correct marker value is displayed.

After the measurement has been completed, you can use the rotary knob to move the moving marker. You can use the arrow keys to scroll through the data area.
- **NEXT LEVEL SEARCH**

On the marker trace waveform, the advanced marker at the peak or bottom is set to the next peak (local maximum value) or bottom (local minimum value).

If such peak or bottom is not found, a warning appears.

WARNING 103: No data in active trace
- **NEXT SEARCH RIGHT**

On the marker trace waveform, the advanced marker at the peak or bottom is set to the peak (local maximum value) or bottom (local minimum value) on its right.

If such peak or bottom is not found, a warning appears.

WARNING 103: No data in active trace
- **NEXT SEARCH LEFT**

On the marker trace waveform, the advanced marker at the peak or bottom is set to the peak (local maximum value) or bottom (local minimum value) on its left.

If such peak or bottom is not found, a warning appears.

WARNING 103: No data in active trace

Displaying Wavelength Difference and Level Difference

This function places a fixed marker and measures the wavelength difference and level difference compared to a moving marker.

Note

For details, see the explanation in section 5.9, "Displaying Markers."

Displaying Line Markers

When line markers are displayed, the marker values are shown in the upper left part of the waveform area.

When both wavelength line markers 1 and 2 are displayed, or both level line markers 3 and 4 are displayed, the wavelength difference (L2-L1) or level difference (L4-L3) is shown below the marker values.

Note

For details, see the explanation in section 5.9, "Displaying Markers."

Split Display <<See section 5.10 for the operating procedure>>

You can split the screen into an upper and lower display (SPLIT mode).

You can assign trace waveforms to either the upper or lower split.

TRACE A UP/LOW

This function is used to set whether to put trace A on top or on bottom during upper/lower split display. If you select UP, it is assigned to the top. (Default) If you select LOW, it is assigned to the bottom.

Noise Mask <<See section 5.11 for the operating procedure>>

This key is used to display a waveform so that parts of the waveform at or below the set value are masked. In addition, when a noise mask value is set, the waveform is overwritten in real time.

When you press the NOISE MASK soft key, the current noise mask value is displayed in the noise mask value setting screen. The allowed settings for the noise mask setting are OFF (-210 dBm), and the range from -100 to 0 dBm (fine: in steps of 1; coarse: in steps of 10).

Peak/Bottom Search <<See section 5.13 and 5.14 for the operating procedure>>

The peak/bottom search function has two search modes: single, in which a single peak or a single bottom of the measured waveform's level are detected, and multi, in which multiple peaks and bottoms are detected in a single search. Markers are displayed at the peak and bottom points. You can also detect the next level peak or bottom.

There is also an auto search function that automatically performs peak/bottom searches during each sweep. This is useful when you want to observe the changes to the peak and bottom levels during repeat sweeping.

1.4 Analysis

Spectrum Width Analysis <<See section 6.1 for the operating procedure>>

You can display the spectrum width and center wavelength using the following four types of calculation.

- THRESH method
- ENVELOPE method
- RMS method
- PEAK RMS method

<See appendix 2, "Spectrum Width Data Calculation Algorithms" for a description of the spectrum width analysis algorithms and parameters.>

Notch Width Measurement <<See section 6.2 for the operating procedure>>

With notch width measurement, it is possible to measure pass band width / notch width from the measured waveform of a filter with V-character type or U-character type wavelength characteristics.

<For a description of the notch width analysis algorithm and parameters, see appendix 2, "Data Calculation Algorithms for Spectrum Widths.">

Device Analysis <<See section 6.3 and 6.4 for the operating procedure>>

Light source parameters can be analyzed from the measured waveform of each light source (DFB-LD, FP-LD, LED).

DFB-LD SMSR Measurement

The side-mode suppression ratio (SMSR) can be measured from the DFB-LD measured waveform.

FP-LD and LED TOTAL POWER Measurement

Optical power can be measured by integrating the measured waveform level measurements.

PMD Measurement <<See section 6.6 for the operating procedure>>

It is possible to measure the polarization mode dispersion (PMD) of a DUT (such as an optical fiber) by using the instrument in combination with an analyzer, polarization controller, polarizer, and an amplified spontaneous emission (ASE) light source, high-output LED light source, or other wideband light source.

WDM Analysis <<See section 6.7 for the operating procedure>>

You can analyze WDM transmission signals. You can also measure OSNR of a DWDM transmission system with 50 GHz spacing. Measurements of WDM signal wavelength, level, wavelength interval, and OSNR can be made collectively on up to 1024 channels, and the analysis results can be displayed in a data table.

Optical Amp Analysis <<See section 6.8 for the operating procedure>>

Measurement can be performed of the optical amp gain and noise figure from measured waveform of the signal light going into the optical amp, as well as the measured waveform of the output light leaving the optical amp.

Optical Filter Characteristics Measurement

<<See section 6.9 for the operating procedure>>

Optical filter characteristics can be measured from the measured waveform of the light input to the optical filter from the light source, as well as from the measured waveform light output from the optical filter.

Analysis can be performed not only on optical filters with only one mode, but also multi-mode WDM filters.

Measurement of Level Fluctuations in Single-Wavelength Light

<<See section 6.11 for the operating procedure>>

This function is used to measure changes over time in the level of a specific wavelength level. The sweep width is set to 0 nm, and measurement of the single-wavelength light is taken. The horizontal axis is the time axes. It is useful for purposes such as optical axis alignment when a light source is input to an optical fiber.

Template

<<See section 6.12 for the operating procedure>>

The template function compares preset reference data (template data) with a measured waveform. In addition, if a function for displaying the target spectrum (target line) on the measurement screen is used, the target spectrum can be referenced while adjusting the optical axis of an optical device.

The following three templates are provided.

- Upper limit line
- Lower limit line
- Target line

Go/No Go Judgment <<See section 6.12 for the operating procedure>>

The Go/No Go test function compares the active trace waveform against reference data (template data) preset by the user, and performs a test on the measured waveform (Go/No Go test).

The template function can be used effectively in situations such as pass/fail tests on production lines.

Analysis between Line Markers

<<See section 6.13 for the operating procedure>>

You can specify an analysis range with line markers. Analysis is performed in the range outlined by the two line markers.

Analysis in the Zoom Area <<See section 6.13 for the operating procedure>>

You can specify the zoomed area as the analysis range.

For example, there is a zoom area power measurement function. This function calculates totalized power between display scales. It is effective for purposes such as ASE evaluation on optical amplifiers.

Analysis Data Logging <<See section 6.15 for the operating procedure>>

The analysis data logging function measures and records WDM analysis, DFB-LD analysis, and peak data at regular intervals. The recorded data can be shown on the screen in tables or graphs. In addition, the contents in tables can be saved to a file in CSV format.

The following types of data are recorded for WDM analysis and peaks.

- WDM analysis: Wavelength, level, SNR (signal-to-noise ratio)
- Peak: Wavelength, level

1.5 Other

Using the USB Mouse <<See section 3.2 for the operating procedure>>

With a connected USB mouse you can perform the same operations as with the instrument's panel keys. Also, if you move the mouse pointer over the item in the menu screen that you wish to select and click it, the instrument responds exactly as if you had pressed the corresponding soft key.

The USB mouse is connected to the connector on the front panel of the instrument.

Registering Soft Keys <<See section 8.1 for the operating procedure>>

Frequently used soft keys can be registered in the soft key menu.

Registering soft keys reduces the steps needed to execute their functions. Twenty-four soft keys can be registered. By default, all keys are unregistered.

Data Initialization <<See section 8.2 for the operating procedure>>

You can restore all settings to their factory defaults.

The parameter setting values and data of each function are initialized.

Help

<<See section 8.3 for the operating procedure>>

Displays an explanation of the soft key menus.

Certain soft keys have additional help text ("MORE INFO"). MORE INFO contains detailed explanations of the corresponding soft keys.

Locking Keys <<See section 8.5 for the operating procedure>>

This function locks key input temporarily to prevent users from operating the AQ6375B through the keys. Even when the keys are locked, soft keys registered as USER keys can be used for operation.

Remote (Separate Document)

An external device can be connected to the instrument through the GP-IB port or another port to remotely control the instrument. This function requires a special connector cable for connecting with the external device. For details, see the separate user's manual, "Remote Control User's Manual."

Program (Separate Manual)

The program function allows you to control an external instrument without using a PC. The function uses Ethernet, RS-232, or GP-IB. For details, see the separate user's manual, "Remote Control User's Manual."

2.1 Alignment Adjustment



WARNING

The instrument has a built-in reference light source for wavelength calibration, and infrared light is always being output from the optical output connector. Never look into the optical output connector. Infrared light entering the eyes can cause severe injury and loss of vision.

French



AVERTISSEMENT

Cet instrument dispose d'une source de lumière de référence intégrée pour les ajustements d'alignement. La lumière infrarouge est toujours émise depuis le connecteur de sortie optique. Ne regardez jamais directement dans le connecteur de sortie optique. La lumière infrarouge risquerait de gravement vous blesser ou de provoquer une perte de vision.

Procedure

1. Turn the power to the instrument ON. Turn ON the **MAIN POWER** switch and press the **POWER** switch. For instructions on turning the power ON and OFF, see chapter 7 of the *Getting Started Guide*, IM AQ6375B-02EN.
2. Use a 9.5/125 μm SM optical fiber to connect the instrument's optical input connector with the optical output connector.

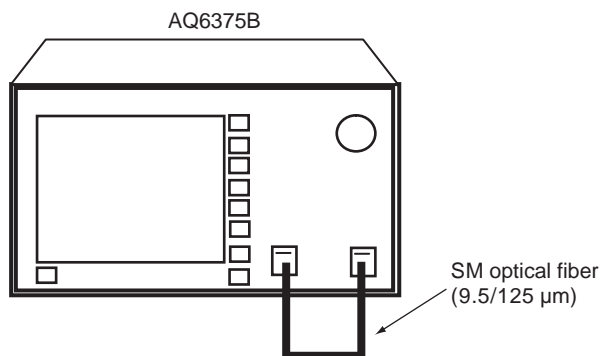

3. Press **SYSTEM**. The soft key menu is displayed.
4. Press the **OPTICAL ALIGNMENT** soft key.

2.1 Alignment Adjustment

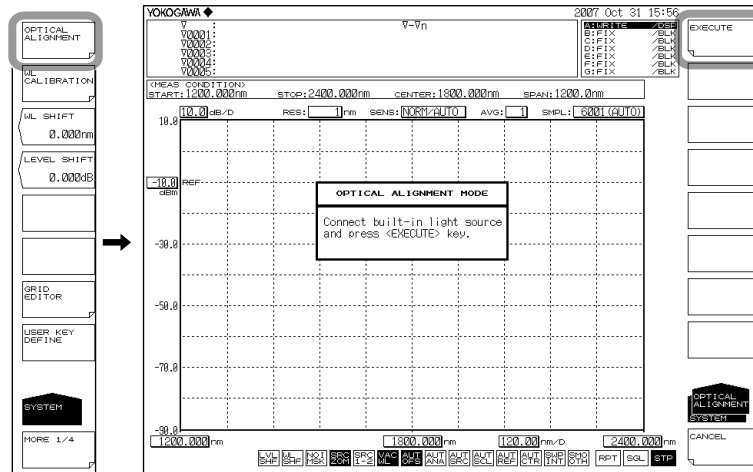

5. Press the **EXECUTE** soft key. Alignment adjustment is automatically executed. Adjustment finishes a few minutes thereafter, and you are returned to the original screen.
6. Press the **CANCEL** soft key to cancel alignment adjustment partway through the process.

Note

- After alignment has been executed, wavelength calibration is also performed automatically inside the instrument.
- The alignment adjustment has no effect if the process is stopped. The instrument remains in the state prior to execution of the alignment adjustment.

Explanation**Types of Optical Fibers**

The instrument can use single mode optical fibers with core diameters of 5 to 9.5 μm , and multimode (GI) optical fibers with core diameters of 50 and 62.5 μm . Functions may be limited or restricted depending on which type of optical fiber is used. The table below shows which of the typical types of fiber may be used and the limitations on their use.

Limitations on Wavelength Resolution

The maximum wavelength resolution for the instrument is 0.05 nm, which is only obtainable when using a single-mode optical fiber with a core diameter of 9.5 μm or less. As shown in Table, the maximum wavelength resolution decreases when optical fibers with thicker core diameters are used.

Setting a resolution value finer than those shown in the table below will simply result in an inaccurate measurement level without improving resolution.

Optical fibers with a thick core diameter are especially useful for inputting spatial light for measurement, but they have poor resolution.

Choose the best type of optical fiber for your particular application.

Note that the instrument is designed for input through optical fiber only. It will not work with inputs that do not pass through optical fiber, such as direct input of a gas laser beam to the optical input connector, or bonding an LED to the optical input connector. It is important to note that optical spectrum measurements taken through such inputs are completely unreliable.

For spatial light measurements, input the spatial light to the optical fiber and from the optical fiber to the instrument. A variety of adapters are available for this purpose.

Summary of usable optical fiber types and usage limitations

Optical Fiber Type		Obtained Wavelength Resolution (in nm)	Absolute Level Accuracy
Type	Core Diameter		
SM	5	0.05	NG
SM	9.5	0.05	OK
GI	50	0.10	NG
GI	62.5	0.10	NG
SI	50	0.10	NG
SI	80	0.20	NG
SI	100	0.50	NG
SI	200	1.00	NG
SI	400	2.00	NG
SI	800	2.00	NG

Level Accuracy below the Cutoff Wavelength (Short Wavelength) of a Connected Optical Fiber

With wavelengths at or below the cutoff level of the connected fiber, light propagates through the optical fiber in multiple modes. When high-coherent light from a light source such as a gas laser or DFB-LD light source propagates in multiple modes, speckle noise contained in the optical fiber output light may become unstable by the optical fiber's form, resulting in an inaccurate measurement level.

In such cases, improving the coupling between the light source and the optical fiber will lessen the level inaccuracy.

2.2 Wavelength Calibration



WARNING

The instrument has a built-in reference light source for wavelength calibration, and infrared light is always being output from the optical output connector. Never look into the optical output connector. Infrared light entering the eyes can cause severe injury and loss of vision.

French



AVERTISSEMENT

Cet instrument dispose d'une source de lumière de référence intégrée pour les ajustements d'alignement. La lumière infrarouge est toujours émise depuis le connecteur de sortie optique. Ne regardez jamais directement dans le connecteur de sortie optique. La lumière infrarouge risquerait de gravement vous blesser ou de provoquer une perte de vision.

Procedure

Wavelength Calibration Using the Internal Reference Light Source

1. Turn the power to the instrument ON.
Turn ON the MAIN POWER switch and press the **POWER** switch.
For instructions on turning the power ON and OFF, see chapter 7 of the Getting Started Guide, IM AQ6375B-02EN.
2. Use a 9.5/125 μm SM optical fiber to connect the instrument's optical input connector with the optical output connector.
3. Press the **SYSTEM** key. The soft key menu is displayed.
4. Press the **WL CALIBRATION** soft key.

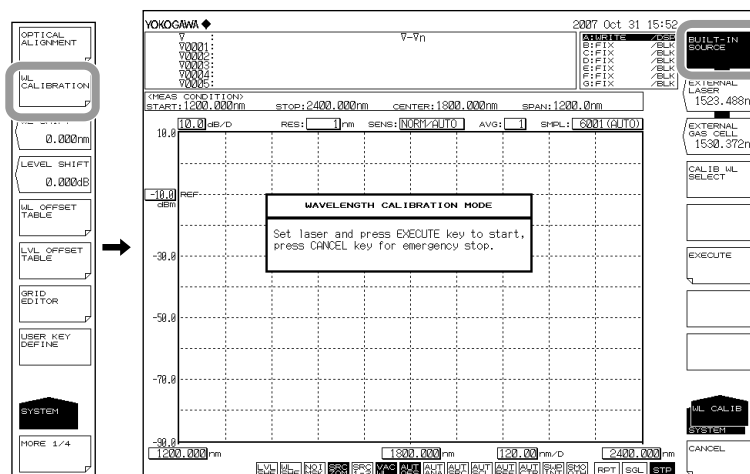

5. Press the **BUILT-IN SOURCE** soft key.
6. Press the **EXECUTE** soft key. Wavelength calibration is executed for 2 minutes. The previous screen is displayed again after the calibration process ends.

- Press the **CANCEL** soft key during wavelength calibration to cancel the wavelength calibration process.

Note

- Always perform wavelength calibration after turning ON the power to the instrument and allowing the warm-up to finish.
- If you are using this instrument for the first time or using it after it has been severely shaken while being moved, you must perform the alignment adjustment procedure after warm-up ends.
- If the wavelength error of the instrument is outside of ± 20 nm, you cannot perform wavelength calibration with the internal reference light source.
(Readjustment required. Contact your nearest Yokogawa representative.)

Wavelength Calibration Using and External Light Source

Instead of using the internal reference light source, it is also possible to calibrate the instrument using an external light source. However, the following light sources cannot be used for wavelength calibration.

- If the set wavelength is not the same as that of the calibration light source.
- If the wavelength error of the instrument is outside of ± 0.5 nm.
(Readjustment required. Please contact your nearest Yokogawa representative.)
- If you are using a reference light source with multiple absorption lines, and the instrument's wavelength shift is greater than the wavelength interval of the absorption lines (with the result that an adjacent absorption line is used as the reference wavelength).

Connecting the External Light Source

- Turn the power to the instrument ON.
Press the MAIN POWER switch and press the **POWER** switch.
For instructions on turning the power ON and OFF, see chapter 7 of the Getting Started Guide, IM AQ6375B-02EN.
- Use a 9.5/125 μm SM optical fiber to connect the external light source's optical output connector with the optical input connector.

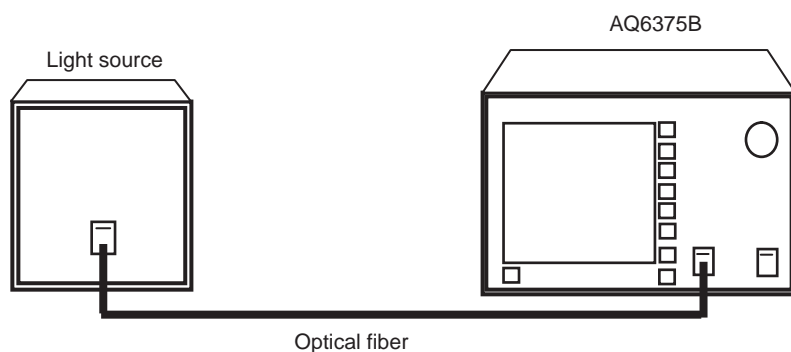

Setting the Type of External Light Source and Calibration Wavelength Value

- Press **SYSTEM**. The soft key menu is displayed.
- Press the **WL CALIBRATION** soft key.

Select the type of external light source (laser-type external light source or gas cell absorption line type external light source) and set the calibration wavelength value. There are three different ways to set the wavelength value.

For Laser Type Light Sources

5. Press the **EXECUTE LASER** soft key. A screen for specifying the wavelength of the external light source is displayed.
6. Select the laser wavelength value using the rotary knob or the arrow keys. The allowed wavelength range is 1200–2400 nm.
7. Press **nm/ENTER**. The wavelength value is set.
8. Press the **EXECUTE** soft key. Wavelength calibration is executed. The previous screen is displayed again after the calibration process ends.
9. Press the **CANCEL** soft key during wavelength calibration to cancel the wavelength calibration process.

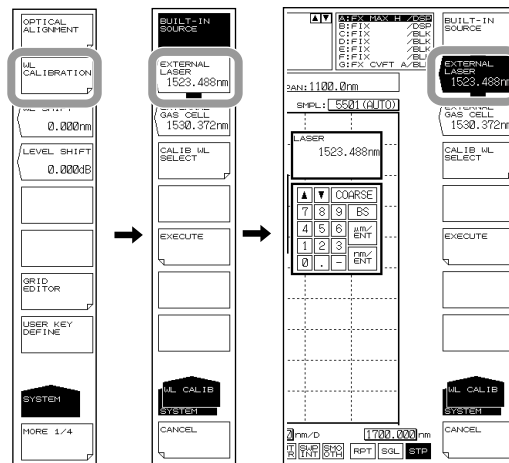

For Gas Cell Absorption Line Type Light Sources

5. Press the **EXECUTE GAS CELL** soft key. A screen for specifying the wavelength of the external light source is displayed.
6. Select the gas cell absorption line wavelength value using the rotary knob or the arrow keys. The allowed wavelength range is 1200–2400 nm.
7. Press **nm/ENTER**. The wavelength value is set.
8. Press the **EXECUTE** soft key. Wavelength calibration is executed. The previous screen is displayed again after the calibration process ends.
9. Press the **CANCEL** soft key during wavelength calibration to cancel the wavelength calibration process.

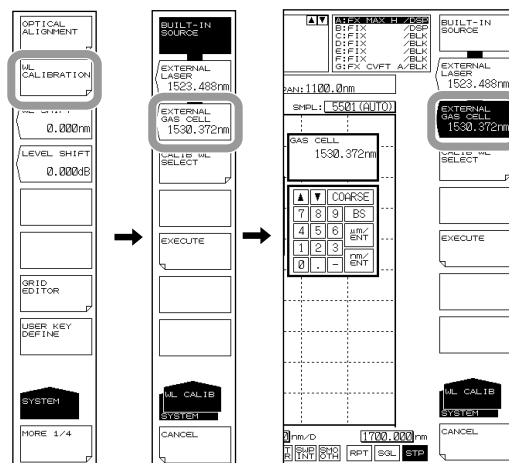

Using the Instrument’s Internal Calibration Wavelength Value

6. Press the **CALIB WL SELECT** soft key. The soft key menu changes to show wavelength values.
7. Press the soft key corresponding to the appropriate wavelength value.
8. Press the **EXECUTE** soft key. Wavelength calibration is executed. The previous screen is displayed again after the calibration process ends.
9. Press the **CANCEL** soft key during wavelength calibration to cancel the wavelength calibration process.

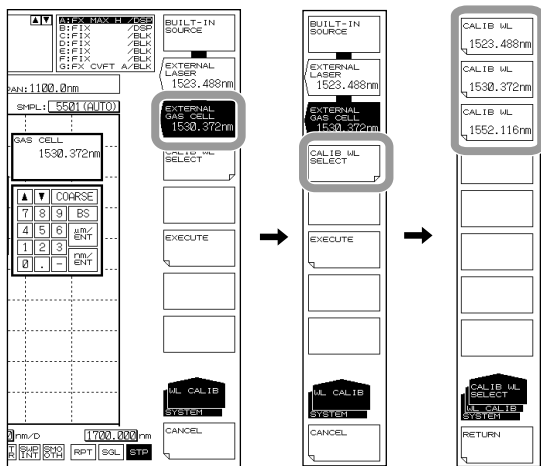

Note

It is not necessary to perform calibration on multiple wavelengths. If calibration is performed on multiple wavelengths, only the results from the final calibration are applied.

2.3 Purge



CAUTION

- NEVER use a flammable gas to purge the AQ6375B.
- The purge gas must be free of moisture, oil, carbon dioxide and other reactive or infrared-absorbing materials.

French



ATTENTION

- N'utilisez JAMAIS de gaz inflammable pour purger le AQ6375B.
- Le gaz de purge doit être exempt d'humidité, d'huile, de dioxyde de carbone et d'autres matériaux absorbant le rayonnement infrarouge.

Principles and objectives

Water vapor present in the monochromator absorb light in the 1350–1450 nm, 1800–1950 nm area, resulting in ripples in the measurement waveform.

The AQ6375B can be purged with high purity nitrogen or purge gas in order to reduce water vapor and carbon dioxide absorption lines in the measurement results. Nitrogen gas is recommended for AQ6375B which has hygroscopic optical components and ambient water vapor may interfere with measurements.



CAUTION

The instrument warranty will be void if damage is caused by the use of inappropriate facilities.

French



ATTENTION

La garantie de l'instrument est nulle si les dommages sont causés par l'utilisation de locaux inadaptés.

Nitrogen purge equipment

The nitrogen purge equipment is NOT supplied by YOKOGAWA, but the required hardware is available from appropriate commercial suppliers.

The on/off valve, the pressure regulator, the flowmeter and the tubing must be dry, oil-free and uncontaminated.

Supply tubing

The AQ6375B has 1/4" outer diameter quick connectors on the back panel. Use clean flexible 1/4" outer diameter resin tubing (6mm inner diameter) and never use rubber tubing.



CAUTION

- Before purge with nitrogen, ensure that there is adequate ventilation in the room.
- The instrument warranty will be void if damage is caused by the use of inappropriate nitrogen and purge gas.

French



ATTENTION

- Avant toute purge à l'azote, vérifiez que la pièce est correctement ventilée.
- La garantie de l'instrument est nulle si les dommages sont causés par l'utilisation d'azote ou d'air sec inadaptés.

Purge gas

Use ultra-high purity liquid nitrogen which must be 99.9999% pure grade with the heat exchanger is recommended. The gas temperature must be $23\pm 5^{\circ}\text{C}$.

If compressed nitrogen must be used, the gas must be dry, oil-free and uncontaminated. Never use compressed nitrogen from a supplier who uses oil or water in the compression process.

Maximum rating

Pressure and flow rate of purge gas must be lower than the following maximum rating.

Pressure: 1.5 psig (0.01 MPaG)

Flow rate: 25 SCFH (12 L/min)

Purge Gas Temperature Specifications

Gas temperature: $23\pm 5^{\circ}\text{C}$

Note

-
- A pressure regulator and precision flowmeter must be used.
 - A precision flowmeter with an adjustable needle valve is recommended.
-



CAUTION

The instrument warranty will be void if damage is caused by incorrect setting of pressure and flow rate.

French



ATTENTION

La garantie de l'instrument est nulle si les dommages sont causés par un paramètre incorrect de pression ou de débit.

Installation and operation

The pressure regulator and the precision flowmeter must be inserted in the system between the purge gas manifold outlet in your facility and the AQ6375B.

Moreover, gas out port of the AQ6375B must not be blocked and be sure there is adequate ventilation in the room.

Recommended Equipments for Purge	QTY.	Comments
Shut off valve for 1/4" tubing	1	Must be free of oil
Adjustable pressure regulator	1	To regulate up to: 75 psig (0.5 MPaG)
Flowmeter with needle valve	1	To control up to: 25 SCFH (12 L/min)
1/4" flexible resin tubing	As Required	Must not be rubber
Purge gas	As Required	99.9999% pure grade nitrogen gas recommended

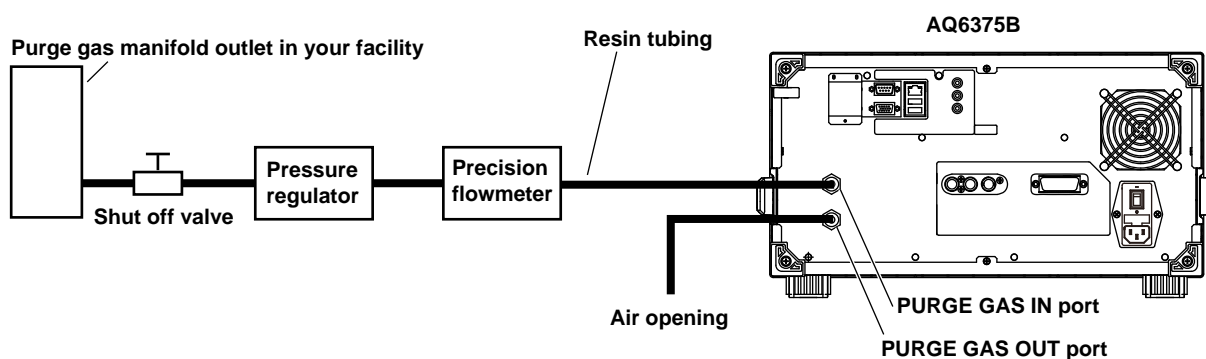

1. Open the purge gas shut off valve then adjust the pressure regulator to provide an appropriate supply pressure below the maximum rating of the precision flowmeter.
2. Adjust the needle valve of the precision flowmeter slowly to provide an appropriate purge gas flow rate.
The internal moisture of the AQ6375B can be displaced by the purge gas within approx. 60 minutes using a flow rate of 20 SCFH (9.5 L/min).
3. To use the AQ6375B in a purged condition, perform alignment adjustment and wavelength calibration with the internal air replaced with purge gas.
See section 2.1 for details on the alignment adjustment operation, and 2.2 for wavelength calibration.

Note

When the AQ6375B is shipped from the factory, a resin tube is attached to the PURGE GAS IN and PURGE GAS OUT terminals to prevent dust from entering the inside.

When installing required equipment and components, remove this resin tube.

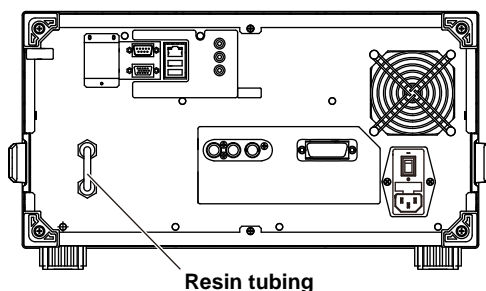

The recommended purge gas flow rate into the AQ6375B is 15 to 20 SCFH (7 to 9.5 L/min).

The figure below shows the purge efficiency by 15 and 20 SCFH pure nitrogen gas flow rate.

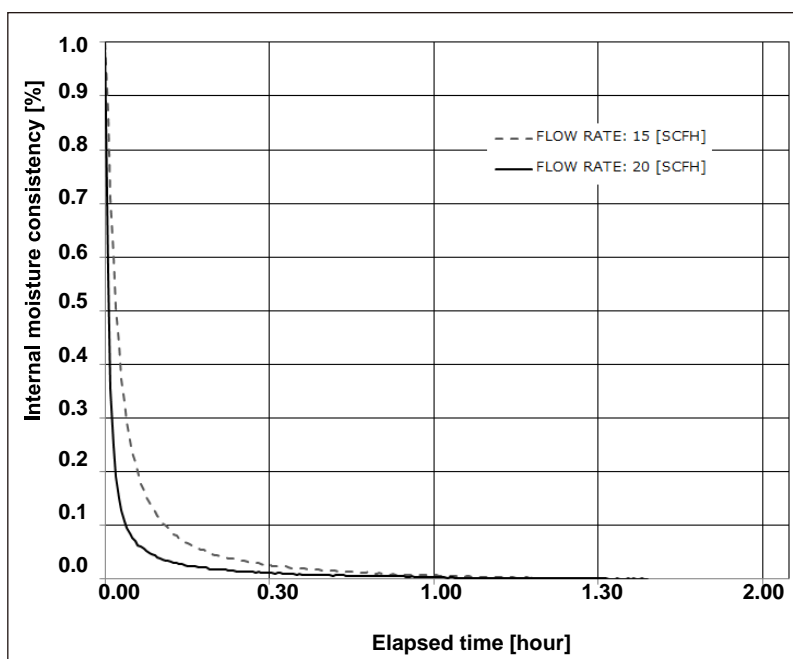
Purge efficiency of the AQ6375B

2.4 Important Points During Measurement

Types of Optical Fibers

The instrument can use single mode optical fibers with core diameters of 5 to 9.5 μm , and multimode (GI) optical fibers with core diameters of 50 and 62.5 μm . Functions may be limited or restricted depending on which type of optical fiber is used. The table below shows which of the typical types of fiber may be used and the limitations on their use.

Limitations on Wavelength Resolution

The maximum wavelength resolution for the instrument is 0.05 nm, which is only obtainable when using a single-mode optical fiber with a core diameter of 9.5 μm or less. As shown in Table, the maximum wavelength resolution decreases when optical fibers with thicker core diameters are used.

Setting a resolution value finer than those shown in the table below will simply result in an inaccurate measurement level without improving resolution.

Optical fibers with a thick core diameter are especially useful for inputting spatial light for measurement, but they have poor resolution.

Choose the best type of optical fiber for your particular application.

Note that the instrument is designed for input through optical fiber only. It will not work with inputs that do not pass through optical fiber, such as direct input of a gas laser beam to the optical input connector, or bonding an LED to the optical input connector. It is important to note that optical spectrum measurements taken through such inputs are completely unreliable.

For spatial light measurements, input the spatial light to the optical fiber and from the optical fiber to the instrument. A variety of adapters are available for this purpose.

Summary of usable optical fiber types and usage limitations

Optical Fiber Type		Obtained Wavelength Resolution (in nm)	Absolute Level Accuracy
Type	Core Diameter		
SM	5	0.05	NG
SM	9.5	0.05	OK
GI	50	0.10	NG
GI	62.5	0.10	NG
SI	50	0.10	NG
SI	80	0.20	NG
SI	100	0.50	NG
SI	200	1.00	NG
SI	400	2.00	NG
SI	800	2.00	NG

Input Optical Fiber Numerical Aperture (NA) and Level Measurement Values

The level measurement error of the instrument changes as shown in the figure below, according to the numerical aperture (NA) of the optical fiber connected to the input connector. The instrument's absolute level is calibrated using a 9.5/125 μm single-mode optical fiber (SSMA type in JIS C6835, with PC polishing, 9.5 μm mode field diameter, and 0.104 to 0.107 NA). Even if a single-mode optical fiber is used, the level accuracy will be outside the specifications if the NA is not in the range shown above.

Input optical fiber numerical aperture and level error (typical characteristics)

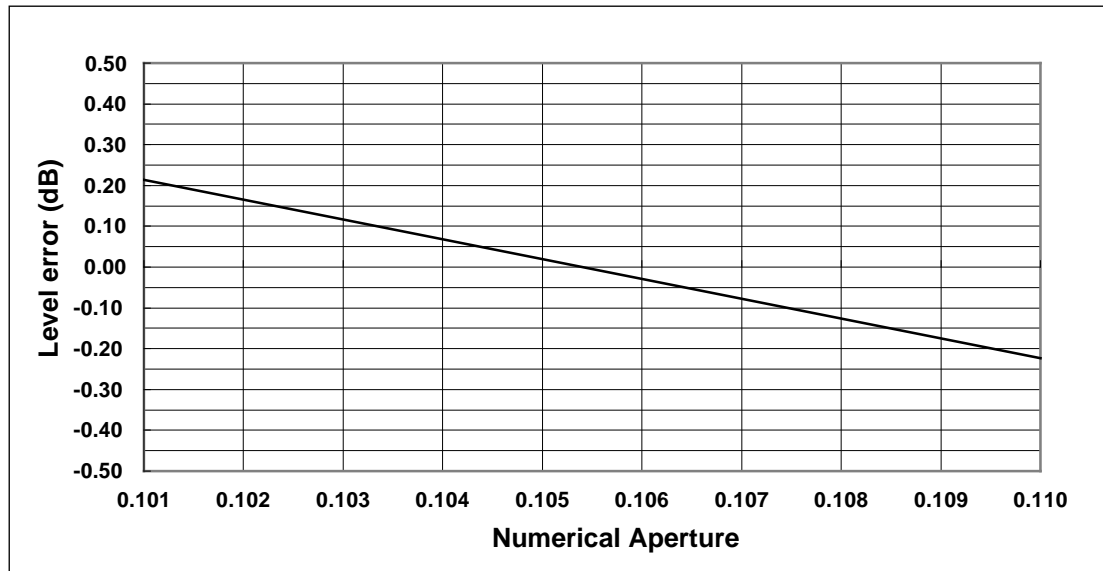

Absolute Level Accuracy

The instrument's absolute level is calibrated with a 9.5 μm single-mode optical fiber. In terms of actual capability, even single-mode optical fibers that do not have a core diameter of 9.5 μm provide nearly the same level of accuracy.

Multimode (GI) fiber provides a relatively accurate spectrum if the light source is low-coherent light such as white light, natural light, or an LED. If the light source has high coherency as in the case of a laser beam, interference will occur inside the optical fiber, and the intensity distribution of light radiating from the fiber tip will vary according to the fiber form. As a result, the spectrum (measurement level) may fluctuate if the fiber is moved.

When an optical fiber with a large core diameter or large NA value is used, a low fraction of the light emitted from the optical fiber is received. Therefore, the measurement level is lower than the true value, but the optical spectrum is accurate in relative terms.

Level Accuracy below the Cutoff Wavelength (Short Wavelength) of a Connected Optical Fiber

With wavelengths at or below the cutoff level of the connected fiber, light propagates through the optical fiber in multiple modes. When high-coherent light from a light source such as a gas laser or DFB-LD light source propagates in multiple modes, speckle noise contained in the optical fiber output light may become unstable by the optical fiber's form, resulting in an inaccurate measurement level.

In such cases, improving the coupling between the light source and the optical fiber will lessen the level inaccuracy.

2.4 Important Points During Measurement

Measurement Sensitivity and Vertical Axis Effective Range

When the measurement sensitivity is set to NORMAL HOLD, the internal amplifier has a fixed gain. Five different gains are set automatically according to the reference (REF) level setting. However, the effective range of measurement data is limited to the following range, using the reference (REF) level (dBm) as a reference.

$$\text{REF}-20 \text{ dBm} < (\text{effective range}) < \text{REF}+10 \text{ dBm}$$

If the level scale is set to 10 dB/DIV, the display would exceed the effective range, so the areas at 10 dB from the screen stop and 20 dB from the bottom are inaccurate.

When measurement sensitivity is set to NORMAL HOLD, we recommend setting the level scale to 5 dB/DIV or less.

Under the measurement sensitivity settings NORMAL AUTO, MID, and HIGH 1/CHOP–HIGH 3/CHOP, an automatic gain is used, permitting measurements over a wide level range through a single sweep. Select the appropriate sensitivity level based on the light reception level required for the particular measurement application.

Stray Light from the Monochromator

The instrument has a newly designed, high-performance monochromator. Depending on the measurement conditions, stray light at a level 30 to 50 dB below the original spectrum, as well as other stray light specific to the monochromator may occur in wavelength areas about 300 nm from the peak wavelength. If this stray light is likely to have a severe impact on measurements, the sensitivity can be set to HIGH 1/CHOP–HIGH 3/CHOP in order to reduce the effects of the stray light.

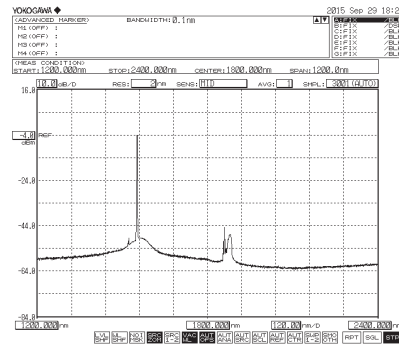

Waveform with CHOP MODE invalid

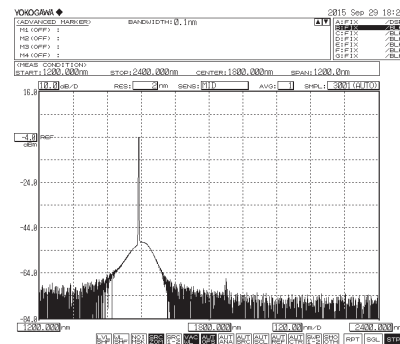

Waveform with CHOP MODE valid

CHOP MODE Function List

CHOP MODE	Function	Merit	Defect
Invalid	Measurement according to the stray light. Stray light suppression ratio: 40 dB or more	Measurement time is rapid even for high sensitivity measurements.	Since the stray light is also measured, the low level component is not accurate if the light source is of high power.
Valid	High dynamic measurement using internal modulation. Stray light suppression ratio: 60 dB or more	Measurement can be taken with stray light removed. Long-duration, high sensitivity measurements possible since offset does not change.	Measurement time is long.

Waveforms with Resolutions of 0.05 nm

When the resolution is set to 0.05 nm for measurements of a light source such as a DFB laser in which with the spectral width is narrower than the instrument's resolution, very small spikes may occur at the skirts of the waveform. This type of spike occurs due to characteristics of the optical block and is not an indication of any problem. Even if such spikes occur, satisfactory performance in terms of resolution, dynamic range, and the like can be ensured. These spikes will disappear if the resolution is set to a coarser value.

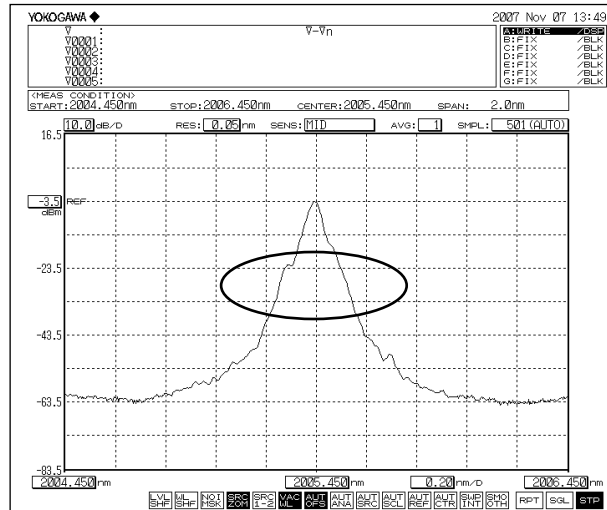

Ripples in the 1350–1450 nm, 1800–1950 nm Area

Water (OH-) ions present in the monochromator absorb light in the 1350–1450 nm, 1800–1950 nm area, resulting in ripples in the measurement waveform. Either set a coarser resolution, use the monochromator in a lower-humidity environment, or execute the purge described on section 2.3 to reduce the amount of ripples.

High-Order Diffracted Light

In principle, the monochromator emits high order diffraction light that is integer multiples of the input light. The AQ6375B is equipped with an optical filter inside the monochromator that suppresses incident rays that are less than 1150 nm (only on the standard model (SUFFIX-10)). However, the optical filter cannot completely eliminate high order diffraction light. Therefore, it is important to know how the high order diffraction light will appear.

The following figure is a graph of the wavelengths that appear on the screen versus the actual wavelengths. The horizontal axis is the wavelengths displayed on the screen, and the vertical axis is the actual wavelengths. In addition, the solid lines on the graph indicate the correspondence between the displayed wavelengths and actual wavelengths. The thick solid line displays the correct optical spectral correspondence (obviously the displayed wavelengths match the actual wavelengths), and the thin solid line displays the correspondence with the ghost caused by high order diffraction light. The numbers written next to the thin solid line indicate the level of suppression of the ghost caused by high order diffraction light relative to the correct optical spectrum. However, the values are rough estimates; they are not guaranteed.

For example, if a 1060 nm light, which is shorter than the measurement wavelength range of the AQ6375B, is applied, draw a horizontal line from 1060 nm on the vertical axis, and the intersections with the lines on the graph correspond to the displayed wavelengths.

As a result, we can see that in addition to 1060 nm, a ghost appears at the 2120 nm position. We also see that the level of the ghost is suppressed by more than 40 dB relative to the correct optical spectrum. Near the 2400 nm measurement wavelength region, the suppression characteristics of the optical filter are low, and the measurement is greatly affected by high order diffraction light. If the input light contains light less than 1150 nm or greater than 1200 nm, reduce such light using an optical filter in advance before making measurements.

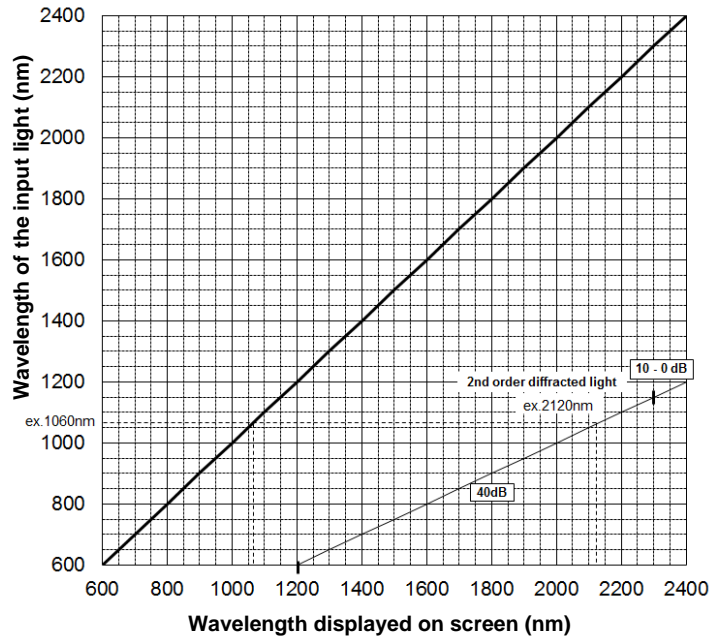

3.1 Description of Soft Keys

When you press a function key, the soft key menu (inside the screen) located on the right side of the screen changes.

The soft key menus are designed to provide a certain level intuitiveness, with the individual soft keys having particular forms which make them easy to understand.

Forms and Behavior



This is a normal soft key.
Press to execute its function immediately.



Contains a submenu.
Indicates that there is a submenu of additional items related to the current item.
Press to display the submenu.



A separate window will be displayed.
Press to display a separate window in the screen for entry of numerical parameters.
A submenu and separate window will be displayed.



Press to move to the submenu and display a separate window.
This softkey returns to the previous menu.



Press to display the previous soft key menu.
This is a selection soft key.

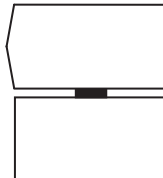

Select one of the soft keys connected with the black band.
When selected, the soft key is displayed in reverse video.
Several soft keys can be connected.

Display Examples

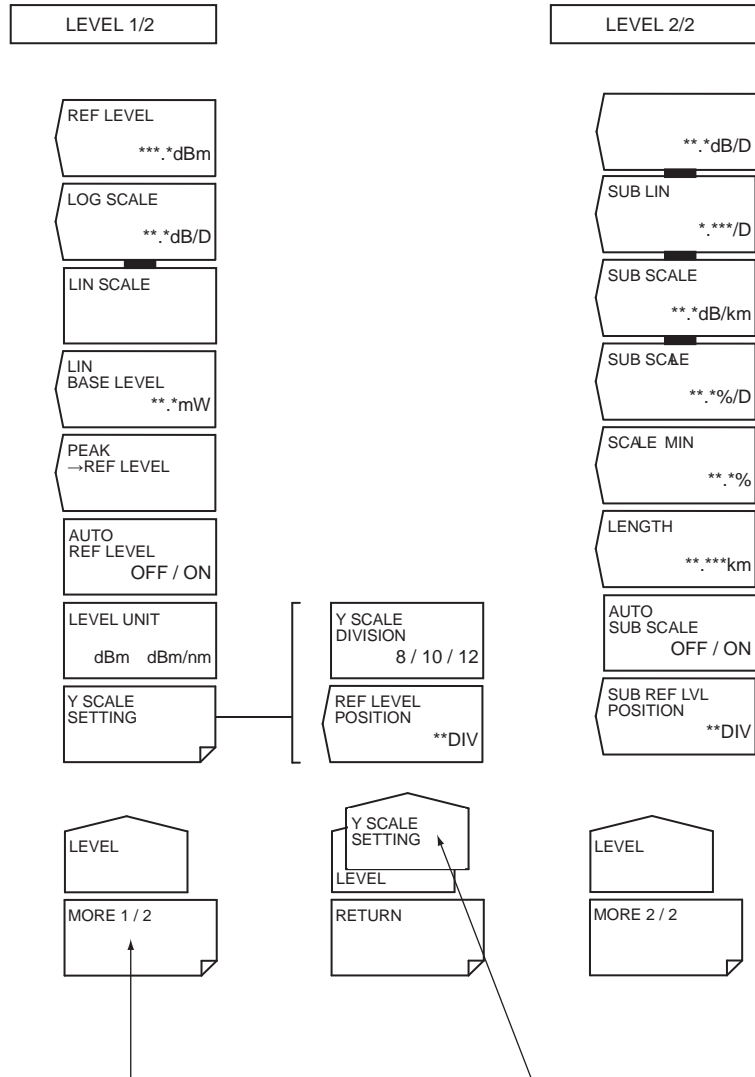

The LEVEL soft key menu is split into two parts. This key switches between the menus. In addition, in some cases this may change to a function that closes the window. For example, when the MORE 1/2 soft key is pressed, the menu changes to the LEVEL 2/2 soft key menu, and the key display changes to MORE 2/2.

Shows the submenu of the soft key menu. In this example, the soft key menu is within the Y SCALE SETTING submenu (for display only, no keys are available).

3.2 Using the Mouse and External Keyboard

Using the Mouse

With a connected mouse you can perform the same operations as with the instrument's panel keys. Also, if you move the mouse pointer over the item in the menu screen that you wish to select and click it, the instrument responds exactly as if you had pressed the corresponding soft key. The USB mouse is connected to the USB interface on the front panel of the instrument.

For instructions on connecting the mouse, see section 3.3.

Operations the Same as the Panel Keys

Displaying the Top Menu

Right-click the mouse in the screen. The names of the front panel keys in the instrument's FUNCTION section are displayed.

CENTER SPAN LEVEL
SWEEP ZOOM
SETUP TRACE DISPLAY
MARKER PEAK SEARCH ANALYSIS
USER MEMORY FILE PROGRAM ADVANCE SYSTEM
UNDO/LOCAL COPY PRESET HELP

Selecting Items

Move the pointer to the item you wish to select and click. A setting menu for the selected item appears. The list of front panel key names disappears.

Clearing the List of Front Panel Keys

Move the pointer away from the list of front panel keys and click.

Operations the Same as the Soft Keys

Selecting Functions from the Soft Key Menu

Move the pointer to the soft key you wish to select and click. A screen corresponding to the action of the soft key appears.

3.2 Using the Mouse and External Keyboard

Using the External Keyboard

The functions of each of the front panel keys of the instrument are assigned to keyboard keys, allowing you to manipulate them with a keyboard just as you would by using the instrument's panel keys.

The panel key correspondence table below shows the correspondences between the panel keys and the keys on the keyboard. Also, you can directly enter labels, file names, and numbers.

Panel Key Correspondence Table

Type	Function	External Keyboard	Description	
FUNCTION	Sweep	SWEEP	[SHIFT]+[F1]	Executes/sets sweep
	Meas. settings	CENTER	[SHIFT]+[F2]	Sets measurement center wavelength
		SPAN	[SHIFT]+[F3]	Sets measurement span
		LEVEL	[SHIFT]+[F4]	Sets level axis
		SETUP	[SHIFT]+[F5]	Sets resolution, sensitivity, etc.
	Display settings	TRACE	[SHIFT]+[F6]	Sets trace
		ZOOM	[SHIFT]+[F7]	Sets display scale
		DISPLAY	[SHIFT]+[F8]	Sets screen display
	Analysis functions	MARKER	[SHIFT]+[F9]	Sets marker
		SEARCH	[SHIFT]+[F10]	PEAK/BOTTOM search function
		ANALYSIS	[SHIFT]+[F11]	Sets analysis function
	Other	USER	[ALT]+[F1]	User settings menu
		MEMORY	[ALT]+[F2]	Memory
		FILE	[ALT]+[F3]	Saves/opens files, file actions
		PROGRAM	[ALT]+[F4]	Program Functions
ADVANCE		[ALT]+[F5]	Advanced functions	
SYSTEM		[ALT]+[F6]	System settings	
Soft keys	F1 to F9	F1 to F9	Depends on FUNCTION menu	
Auxiliary keys	UNDO/LOCAL	[ALT]+[F9]	Local: UNDO function Remote: Returns to the local state.	
	COPY	[ALT]+[F10]	Screen copy	
	PRESET	[ALT]+[F11]	Clears settings except remote settings	
	HELP	[ALT]+[F12]	Displays Help (use UNDO/LOCAL to exit Help)	
DATA ENTRY	Numeric keypad	0123456789.-	Numeric value input	
	BACK SPACE	Back Space	Deletes one character from input value	
	um/ENTER	None	Confirms entry	
	nm/ENTER	ENTER	Confirms entry	
	Rotary knob	[→],[←]	Changes numeric values/items	
	Arrow keys ([UP] [DOWN])	[↑],[↓]	Numeric value one-step change, item change, table scrolling	
	COARSE	[ALT]+[N]	Switches between fine and coarse encoder	

3.3 Entering Numerical Values and Strings

Entering Numerical Values

You can use the numeric keypad, rotary knob, or arrow keys in the DATA ENTRY section.

1. Press the soft key of a parameter. The currently set value is shown in the parameter input window.

Direct Entry Using the Numeric Keypad

2. Press a numeric keypad key. The numeric keypad input area appears, and the number of the pressed key is displayed.
3. After entering a numerical value, press the $\mu\text{m}/\text{ENTER}$ or nm/ENTER key depending on the unit of the input parameter. The value in the numeric keypad input area appears in the parameter input window, and is set internally. If a parameter does not have a unit associated with it, you can use either the $\mu\text{m}/\text{ENTER}$ or nm/ENTER key.

If you make an error when inputting values with the numeric keypad:

4. Press **BACK SPACE**. The last (right-most) entered character in the numeric keypad input area is removed, allowing entry of the correct character.

Note

- If the value entered with the numeric keypad is not in the allowed value range, the nearest allowed value will be set.
- By holding the BACK SPACE key down, you can erase the entire entry in the numeric keypad input area and make the numeric keypad input area disappear, returning to the condition preceding numeric keypad input.

Entry Using the Rotary Knob and Arrow Keys

2. Continuing on from step 1, turn the rotary knob, or press an arrow key. The currently set value is changed.
3. When you press the **COARSE** key the digit of the setting to be changed rises, or the numeric value increase/decrease step increases. Press the **COARSE** key again to restore the previous digit/step.

When COARSE is selected, the COARSE key lights.

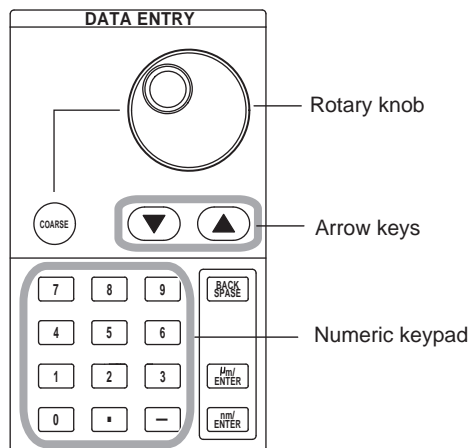

Entering Strings

Character strings can be entered from the character selection area displayed on screen using the rotary knob and soft keys.

Entry Procedure

The following is an example of entering a label.

1. Press **DISPLAY**. The soft key menu for the screen display appears.
2. Press the **LABEL** soft key. The text selection area and label entry area are displayed.

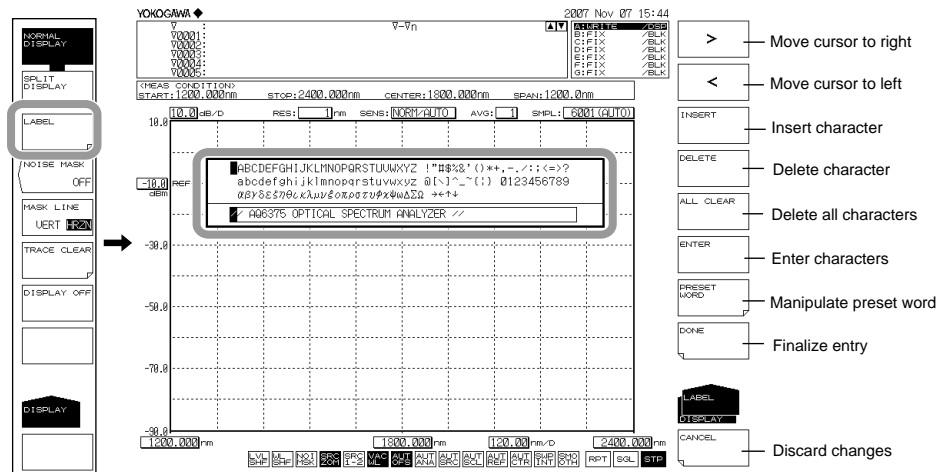

3. Move the cursor to the character in the character selection area that you wish to enter. Use the rotary knob or arrow keys to move the cursor in the character selection area.
4. Press the **ENTER** soft key. The character selected at the cursor position in the label input area is displayed.
5. To move the cursor, or insert or delete a character in the label input area, press the corresponding soft key.
6. When the character string is entered, press the **DONE** soft key. The input character string is entered.

Note

- In addition to when pressing **DISPLAY**, the character input screen appears whenever a string must be entered on the instrument, such as when entering a file name for saving a file.
- Numerical input can be performed directly from the numeric key pad.

3.4 Screen Display

Procedure

1. Press **SYSTEM**. The soft key menu is displayed.
2. Press the **MORE 1/4** soft key two times. The soft key menu switches to the **MORE 3/4** screen.

Setting the Number of Displayed Digits for Level Data

3. Press the **LEVEL DISP DIGIT** soft key. The digit setting menu is displayed.
4. Press the soft key corresponding to the desired number of digits.
 - 1DIGIT** Sets the number of level data display digits (below the decimal point) to 1 digit.
 - 2DIGIT** Sets the number of level data display digits (below the decimal point) to 2 digits.
 - 3DIGIT** Sets the number of level data display digits (below the decimal point) to 3 digits.

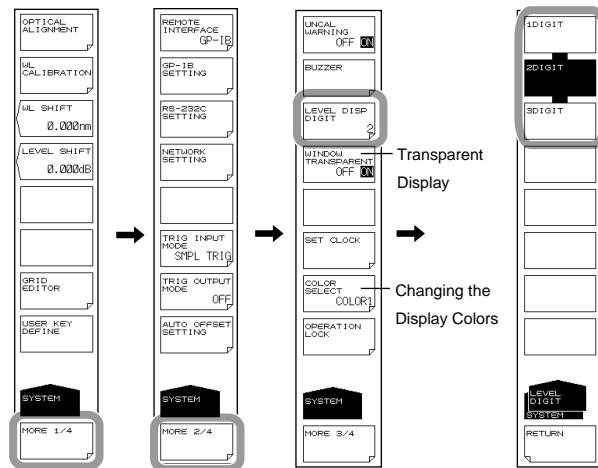

Transparent Display

3. Continuing on from step 2, press the **WINDOW TRANSPARENT OFF ON** soft key. Transparent display turns ON or OFF. When ON, the parameter input window and overview display window are displayed transparently.

Changing the Display Colors

3. Continuing on from step 2, press the **COLOR SELECT** soft key. The display color setting menu is displayed.
4. Press the soft key corresponding to the desired display color.
 - COLOR1** Sets the screen display color to "COLOR 1".
 - COLOR2** Sets the screen display color to "COLOR 2".
 - COLOR3** Sets the screen display color to "COLOR 3".
 - COLOR4** Sets the screen display color to "COLOR 4".
 - COLOR5** Sets the screen display color to "COLOR 5".
 - B&W** Sets the screen display color to black-and-white.

3.5 Setting the Date and Time

The AQ6375B displays the date and time in the upper right corner of the screen. This information is used for a time stamp when recording data.

Displaying the Date and Time Dialog Box

1. Press **SYSTEM**. The soft key menu is displayed.
2. Press the **MORE** soft key two times. The soft key menu switches to the MORE 3/4 screen.
3. Press the **SET CLOCK** soft key. The internal clock setting screen is displayed.

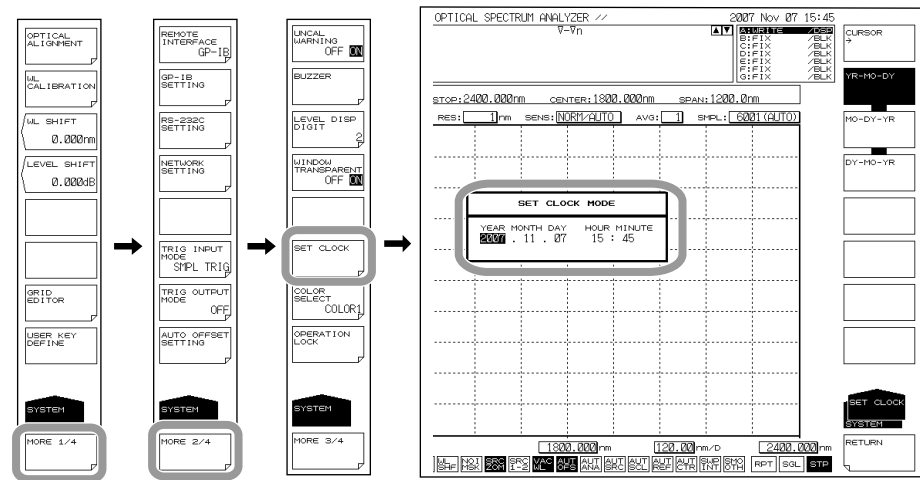

Entering the Date and Time

4. Press the **CURSOR ->** soft key, then move the cursor to the item you wish to input. The cursor moves each time you press the soft key.
5. Press a numeric key button to enter a number.
6. Press **ENTER**. The input number is entered.

Changing the Display Format

7. Press the **MO-DY-YR** soft key.
The date is displayed in the order Month, Day, Year.
Press the DY-MO-YR soft key.
The date is displayed in the order Day, Month, Year.
Press the YR-MO-DY soft key.
The date is displayed in the order Year, Month, Day.

Concluding the Settings

8. Press the **RETURN** soft key. The settings are concluded, and the screen returns to the previous stage.

4.1 Auto Measurement

Procedure

This key automatically sets the optimal measurement conditions for the light source being measured, and performs measurement.

1. Press **SWEEP**. The soft key menu regarding sweeping appears.
2. Press the **AUTO** soft key. The soft key display reverses, and auto measurement executes.

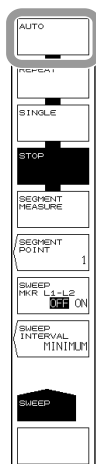

Waveform display example

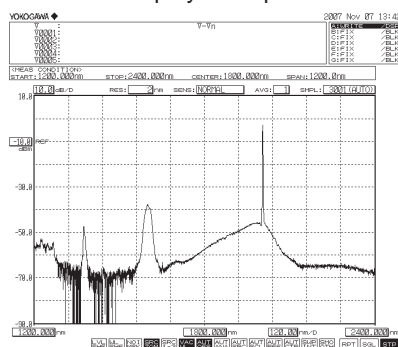

Screen after auto sweep start value

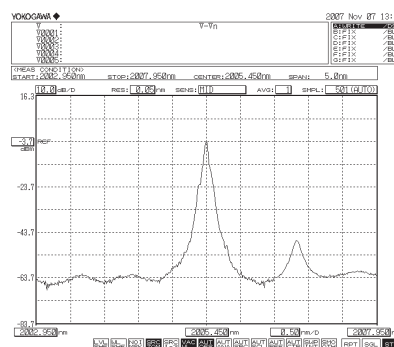

Screen after auto sweep stop

Explanation

The wavelength range of input light that can be auto-measured is 1200–2400 nm.

The following four items are set automatically, after which measurement is performed.

- Center wavelength (CENTER)
- Sweep width (SPAN)
- Reference level (REF LEVEL)
- Resolution (RESOLUTION)

After performing one auto sweep and setting optimal measurement conditions, a repeat sweep is made for measurement.

During the automatic setting, only the following keys are enabled: REPEAT, SINGLE, STOP, and UNDO/LOCAL (when under remote control).

4.2 Horizontal/Vertical Axis Settings

Procedure

Setting Up the Horizontal Axis

Setting the display mode of the horizontal axis to wavelength (frequency / wavenumber)

1. Press **SETUP**. The soft key menu for sweep condition settings appears.
2. Press the **MORE 1/2** soft key.
3. Press the **HORIZON SCAL nm/THz** soft key. The menu for selecting the units for the horizontal axis appears.
4. Press the **nm (/THz / cm⁻¹)** soft key.

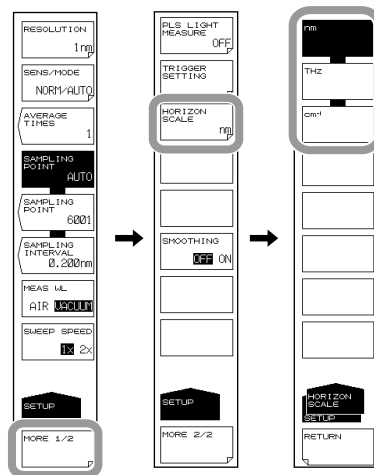

Setting the Measured Wavelength to Air Wavelength or Vacuum Wavelength

1. Press **SETUP**. The soft key menu for sweep condition settings appears.
2. Press the **MEAS WL AIR VACUUM** soft key. The measured wavelength is changed to either a vacuum wavelength or an air wavelength.

Note

- This function only applies to measurements taken after the setting is selected. Previously measured waveforms are not affected.
- If vacuum wavelength is set, **VAC WL** is displayed at the very bottom of the screen in inverse video.
- This function need not be set for Frequency mode and Wavenumber mode. The setting is only for vacuums.

Setting Up the Vertical Axis

Setting to Log Scale Display

1. Press **LEVEL**. The soft key menu for vertical axis settings appears along with the reference level setting screen.
2. Press the **LOG SCALE** soft key. The vertical axis is displayed with the currently specified log scale values. At the same time, the log scale value setting screen is displayed.
3. Enter a log scale value using the rotary knob, arrow keys, or numeric key pad.
4. Press **ENTER**.

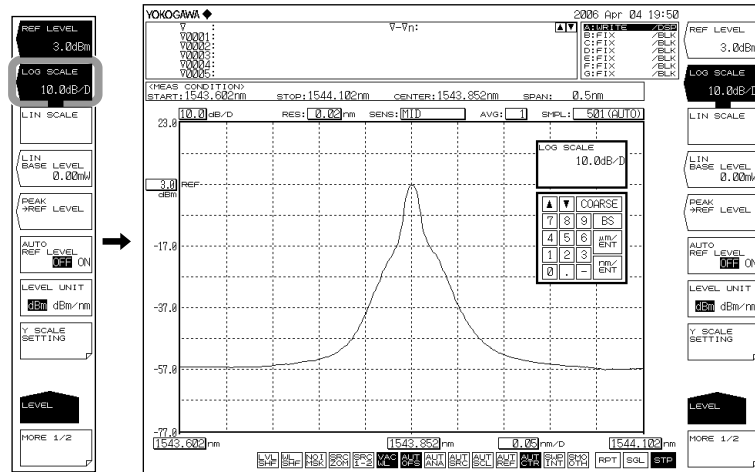

Setting to Linear Scale Display

1. Press **LEVEL**. The soft key menu for vertical axis settings appears along with the reference level setting screen.
2. Press the **LIN SCALE** soft key. The vertical axis is displayed with the currently specified linear scale values.
3. Press the **LIN BASE LEVEL** soft key. A screen for setting the lower-end value of the level scale is displayed.
4. Enter a value using the rotary knob, arrow keys, or numeric key pad.
5. Press **ENTER**.

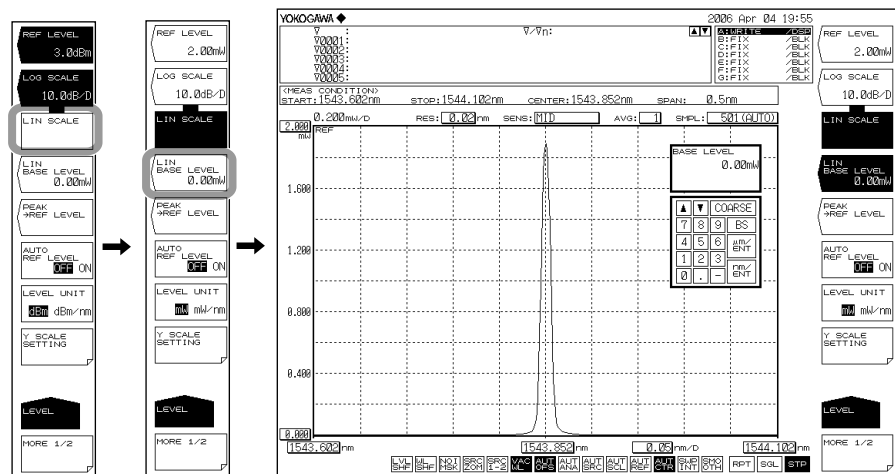

Setting Units for the Vertical Axis

1. Press **LEVEL**.
2. Press the **LEVEL UNIT** soft key. When the vertical axis is log scale, the instruments toggle between dBm and dBm/nm each time you press the key. With a linear scale, it scrolls through nW, μ W, mW, or pW, and nW/nm, μ W/nm, mW/nm or pW/nm.

Setting the Number of Vertical Axis Divisions (for LOG SCALE)

1. Press **LEVEL**.
2. Press the **LOG SCALE** soft key.
3. Press the **Y SCALE SETTING** soft key. The level scale setting menu is displayed.
4. Press the **Y SCALE DIVISION** soft key. The soft key menu for selecting a number of divisions is displayed.
5. Press a soft key corresponding to 8, 10, or 12 divisions. The level axis is displayed with divisions as selected.

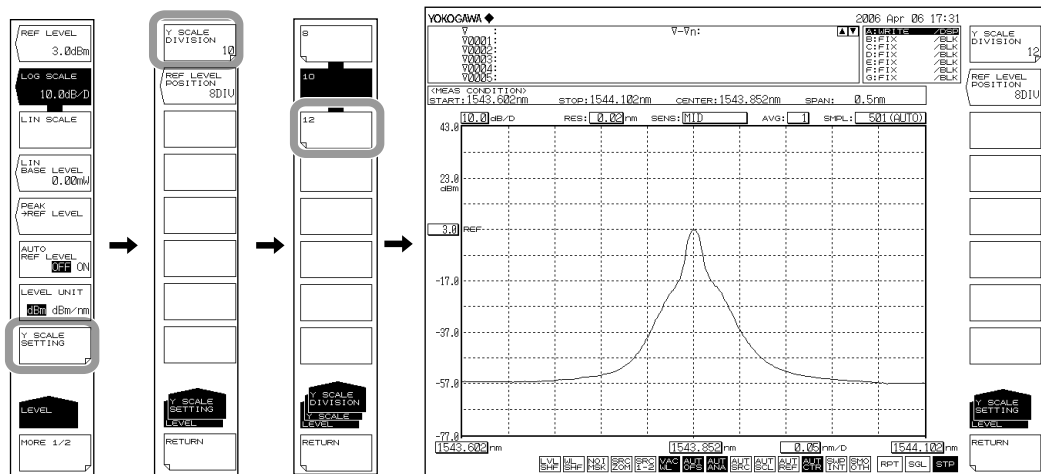

Note

- This is only available when the main scale is a log scale.
- When it is a linear scale, the number of divisions is fixed at 10.

Reference Level Screen Position Setting (for LOG SCALE)

4. Continuing on from step 3, press the **REF LEVEL POSITION** soft key. A screen for setting the screen position of the reference level (REF position) is displayed.
5. Enter a value starting from the bottom of the screen using the rotary knob, arrow keys, or numeric key pad. The setting range is 0 to 12. The setting resolution is steps of 1, or steps of 1-2-5 when COARSE is pressed.
6. Press **ENTER**.

Note

- This is only available when the main scale is a log scale.
- If the REF position value is larger than the number of divisions, it is forcibly reduced to the number of divisions.
- When using linear scale, the REF position is at the top (fixed to 10 divisions).

Explanation**Wavelength Display Mode**

- Displays the measured waveform with the wavelength on the X axis.
- The measurement scale and display scale are set based on the wavelength.
- The X axis unit for marker values and analysis function results is wavelength.

Frequency Display Mode

- Displays the measured waveform with the frequency on the X axis.
- The measurement scale and display scale are set based on the frequency.
- The X axis unit for marker values and analysis function results is frequency.

Wavenumber Display Mode

- Displays the measured waveform with the wavenumber on the X axis.
- The measurement scale and display scale are set based on the wavenumber.
- The X axis unit for marker values and analysis function results is wavenumber.

Display Units of the X-Axis and Marker Values

The display unit for the marker value (wavelength, frequency or wavenumber) can be set independently of the waveform display's horizontal axis units (wavelength, frequency, wavenumber) that were specified using the HORIZON SCALE soft key under SETUP. (Default: nm)

(This key can be used to enter settings such as frequency display mode on the X axis and wavelength display mode for the marker value.)

Also, the MARKER UNIT nm THz soft key's setting changes in conjunction with the setting of the HORIZON SCALE soft key. However, changing the MARKER UNIT nm THz soft key's setting does not change the setting for the HORIZON SCALE nm/THz soft key.

Note

The MARKER UNIT soft key's setting changes in conjunction with the setting of the HORZN SCALE soft key. However, changing the MARKER UNIT soft key's setting does not change the setting for the HORIZON SCALE nm/THz soft key under SETUP.

LOG SCALE **. *dB/D

This key switches the vertical axis to LOG display and sets the level scale.

The setting range is 0.1 to 10.0 dB/DIV. Settings can be adjusted in steps of 0.1 dB.

If you press the COARSE key you can change the numerical value in 1-2-5 steps, for example: 1dB/DIV -> 2dB/DIV -> 5dB/DIV.

When the setting is changed, the displayed waveform is redrawn according to the changed scale.

If the value is set to a scale larger than 5 dB/DIV in range fixing mode (SENS:NORMAL/HOLD) or pulse light measurement mode, the waveform will not be correctly measured in the vertical direction so a warning is displayed.

Measurement Sensitivity and Vertical Axis Effective Range

When the measurement sensitivity is set to NORMAL HOLD, the internal amplifier has a fixed gain. Five different gains are set automatically according to the reference (REF) level setting. However, the effective range of measurement data is limited to the following range, using the reference (REF) level (dBm) as a reference.

$$\text{REF}-20 \text{ dBm} < (\text{effective range}) < \text{REF}+10 \text{ dBm}$$

If the level scale is set to 10 dB/DIV, the display would exceed the effective range, so the areas at 10 dB from the screen stop and 20 dB from the bottom are inaccurate.

When measurement sensitivity is set to NORMAL HOLD, we recommend setting the level scale to 5 dB/DIV or less.

Under the measurement sensitivity settings NORMAL AUTO, MID, and HIGH 1–3, an automatic gain is used, permitting measurements over a wide level range through a single sweep. Select the appropriate sensitivity level based on the light reception level required for the particular measurement application.

LIN SCALE

This key is used to set the main scale to linear scale.

Settings per 1 DIV are set in the reference level.

LIN BASE LEVEL **. *mW

Value when the vertical axis is linear scale, you can set the level scale low-end. This is not available when using a log scale.

The setting range is 0.0 to REF level x 0.9. Settings can be adjusted in steps of 0.1. The value changes in steps of 1 if you press the COARSE key. Values can only be set in the instrument set for the REF level.

When the setting is changed, the displayed waveform is redrawn according to the changed scale.

The scale display in the upper left part of the waveform is 1/10 the value (*W/D) of the reference (REF) level minus the low-end (BASE) level.

For information on the REF level setting, see section 4.4, "Setting the Reference Level."

LEVEL UNIT dBm dBm/nm

When the vertical axis is log scale, the display toggles between dBm and dBm/nm.

dBm: Power per resolution (absolute power)

dBm/nm: Power per 1 nm (power spectral density)

For information on the use of dBm and dBm/nm, see "Power spectral density Display" in section 1.2, "Measurement."

This soft key is disabled if the unit of the horizontal axis is wavenumber.

LEVEL UNIT mW mW/nm

When the level axis uses a linear scale, the display switches between nW, μ W, mW, or pW (absolute power), and nW/nm, μ W/nm, mW/nm or pW/nm (power spectral density).

4.3 Sub Scale

Procedure

The level scale is displayed based on relative values when a differential waveform (based on LOG values) or normalized waveform is displayed. A level scale based on relative values is called a sub scale.

Displaying the Sub Scale

Following section 5.5, "Displaying MATH Waveforms" or section 5.6, "Normalized Display," you can select a display waveform of differential or normalized.

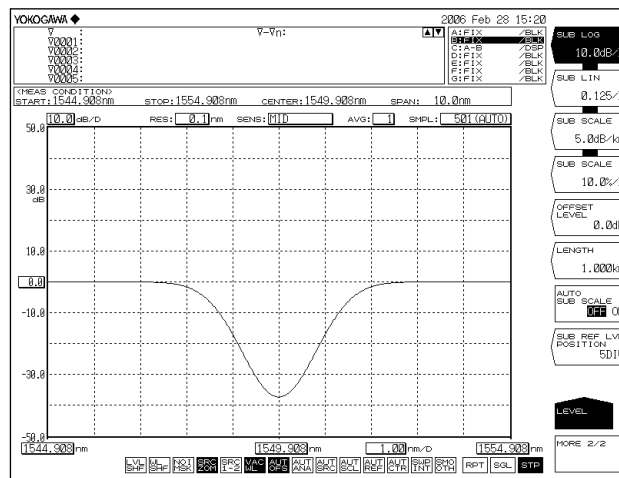

Automatic Scaling of the Sub Scale

1. Press **LEVEL**. The soft key menu for vertical axis settings appears.
2. Press the **MORE 1/2** soft key. The soft key menu for the sub scale appears.
3. Press the **AUTO SUB SCALE OFF ON** soft key to select ON.

Setting the Sub Scale REF Position

1. Press **LEVEL**.
2. Press the **MORE 1/2** soft key.
3. Press the **SUB REF LVL POSITION** soft key. The REF position setting screen is displayed.
4. Enter a value using the rotary knob, arrow keys, or numeric key pad.

Note

The sub scale is displayed when a differential waveform (based on LOG values) and normalized waveform are displayed. When these waveforms are displayed over a waveform based on absolute values, the absolute value scale is shown on the left and the relative value scale is shown simultaneously on the right. If the left scale (main scale) is changed to LOG (8 DIV) or linear (10 DIV), the sub scale is displayed to correspond to the DIV count on the main scale.

Log Display of the Sub Scale

1. Press **LEVEL**. The soft key menu for vertical axis settings appears.
2. Press the **MORE 1/2** soft key. The soft key menu for the sub scale appears.
3. Press the **SUB LOG** soft key. The sub scale is displayed with the currently specified log scale values. At the same time, the log scale value setting screen is displayed.
4. Enter a value using the rotary knob, arrow keys, or numeric key pad.
5. Press **ENTER**.

Setting the Sub Scale Units to dB/km

1. Press **LEVEL**.
2. Press the **MORE 1/2** soft key.
3. Press the **SUB SCALE **. *dB/km** soft key. The instruments of the sub scale change to dB/km. At the same time, the log scale value setting screen is displayed.
4. Enter a value using the rotary knob, arrow keys, or numeric key pad.
5. Press **ENTER**.

When displaying the loss characteristics of the optical fiber per unit of length (km)

6. Continuing on from step 5, press the **LENGTH** soft key. The optical fiber length entry screen appears.
7. Enter a value using the rotary knob, arrow keys, or numeric key pad.
8. Press **ENTER**.

Setting the Sub Scale Offset Value

1. Press **LEVEL**.
2. Press the **MORE 1/2** soft key.
3. Press the **OFFSET LEVEL** soft key. The offset value (sub scale REF value) setting screen is displayed.
4. Enter a value using the rotary knob, arrow keys, or numeric key pad.
5. Press **ENTER**.

Setting the Sub Scale to Linear Display

1. Press **LEVEL**. The soft key menu for vertical axis settings appears.
2. Press the **MORE 1/2** soft key. The soft key menu for the sub scale appears.
3. Press the **SUB LIN** soft key. The sub scale is displayed with the currently specified linear scale values. At the same time, the linear scale value setting screen is displayed.
4. Enter a value using the rotary knob, arrow keys, or numeric key pad.
5. Press **ENTER**.

Setting the Sub Scale Units to %/D

1. Press **LEVEL**.
2. Press the **MORE 1/2** soft key.
3. Press the **SUB SCALE **.*/D** soft key. The instruments of the sub scale display change to %. At the same time, the log scale value setting screen is displayed.
4. Enter a value using the rotary knob, arrow keys, or numeric key pad.
5. Press **ENTER**.

Setting the Sub Scale Lower-End Value

1. Press **LEVEL**.
2. Press the **MORE 1/2** soft key.
3. Press the **SCALE MIN** soft key. The sub scale lower end value setting screen is displayed.
4. Enter a value using the rotary knob, arrow keys, or numeric key pad.
5. Press **ENTER**.

Explanation

SUB SCALE **.*/dB/km

(Setting the sub scale to dB/km)

The setting range is 0.1 to 10.0 dB/km. Settings can be adjusted in steps of 0.1. If you press the COARSE key you can change the numerical value in 1-2-5 steps, for example: 1dB/DIV -> 2dB/DIV -> 5dB/DIV.

When the setting is changed, the displayed waveform is redrawn according to the changed scale.

SUB SCALE **.*%/D

(Sets the sub scale to %.)

The setting range is 0.5 to 125 %/D. Settings can be adjusted in steps of 0.1. The value changes in steps of 1-2-5 if you press the COARSE key.

When the setting is changed, the displayed waveform is redrawn according to the changed scale.

OFFSET LEVEL

(Sets the offset value. This is enabled when the sub scale is dB/D or dB/km.)

The range that can be set is as follows.)

For dB/D: 0–±99.9 dB. Settings can be adjusted in steps of 0.1. The value changes in steps of 1 if you press the COARSE key.

For dB/km: 0–± 99.9 dB/km in steps of 0.1.

SCALE MIN

(Sets the scale lower-end value. This is available when the sub scale is LIN or %.)

The range that can be set is as follows.)

For LIN: 0 to the sub scale value (**.**/D) x 10

For %: 0 to the sub scale value (**.*%/D) x 10

LENGTH **.*km

(Sets the length of the optical fiber. This is available when the sub scale is dB/km.)

The setting range is 0.001 to 99.999 km. Settings can be adjusted in steps of 0.001. The value changes in steps of 1-2-5 if you press the COARSE key.

AUTO SUB SCALE OFF/ON

(Turns OFF/ON the function for automatically scaling the sub scale following calculation.)

When set to ON, during trace C display, SUB LOG or SUB LIN and OFFSET LEVEL change automatically. When these are changed, the displayed waveform is redrawn according to the changed scale.

When set to ON,  is displayed at the bottom of the screen in inverse video.

SUB REF LVL POSITION **.*/DIV

(Sets the sub scale REF position.)

The REF position is set at DIV number **, counting from the bottom of the screen.

The setting range is 0 to 12. Settings can be adjusted in steps of 1. The value changes in steps of 1-2-5 if you press the COARSE key.

4.4 Setting the Reference Level

Procedure

There are two ways of setting the reference level.

- Press the **REF LEVEL** soft key.
- Use the one-action key.

The following explains these procedures.

Settings by Pressing the REF LEVEL Soft Key (Log Scale)

1. Press **LEVEL**. The soft key menu for vertical axis settings appears along with the reference level setting screen.
2. When the vertical axis is not using a log scale, press the **LOG SCALE** soft key. If a log scale is displayed, continue to step 4.
3. Press the **REF LEVEL** soft key. The reference level setting screen is displayed.
4. Enter a reference value using the rotary knob, arrow keys, or numeric key pad.
5. Press **ENTER**.

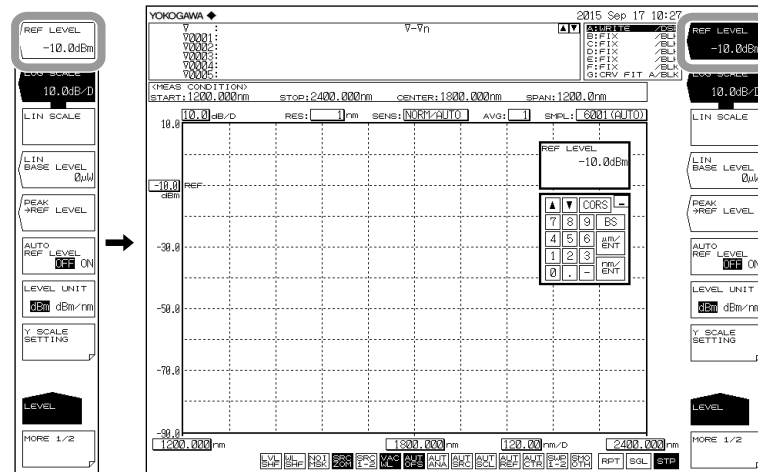

Note

The vertical axis setting is applied in real time on the waveform display.

Setting by Pressing the REF LEVEL Soft Key (Linear Scale)

1. Press **LEVEL**. The soft key menu for vertical axis settings appears along with the reference level setting screen.
2. When the vertical axis is not using a linear scale, press the **LIN SCALE** soft key. If a linear scale is displayed, continue to step 4.
3. Press the **REF LEVEL** soft key. The reference level setting screen is displayed.
4. Enter a reference value using the rotary knob, arrow keys, or numeric key pad. When a value is input a soft key menu for selecting the instrument appears.
5. Press the soft key corresponding to the desired units. The reference level is set.

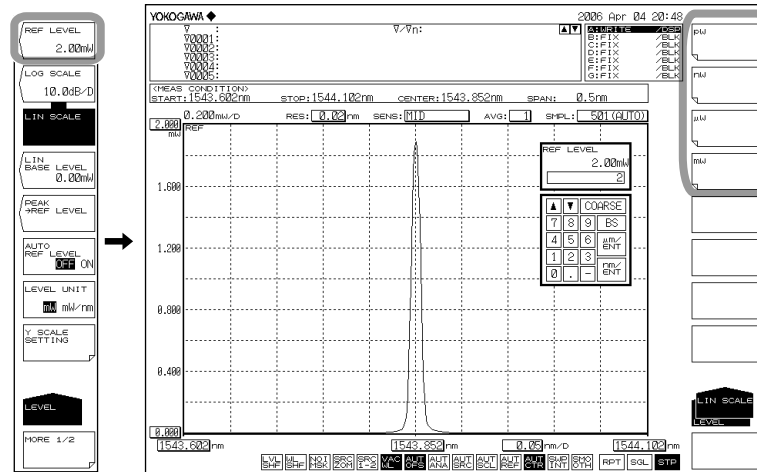

Note

When entered with the rotary knob or arrow keys, the reference level is set using the current units.

Setting by Using the One-Action Key

Sets the peak level of the waveform as the reference level.

1. Press **LEVEL**.
2. Press the **PEAK -> REF LEVEL** soft key. The specified reference level is displayed, and the displayed waveform is redrawn according to the changed reference level.

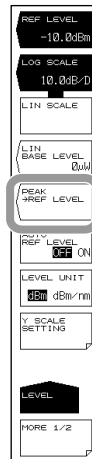

Automatically sets the peak level of the waveform measured every sweep as the reference level.

3. Continuing on from step 1, press the **AUTO REF LEVEL OFF/ON** soft key to select ON.

Note

- Sets the peak level of the measured waveform of the active trace as the reference level.
- This does not operate if the active trace is not set to WRITE (i.e., if it is set to MAX HOLD, MIN HOLD, CALCULATE, or ROLL AVG).
- When set to ON, **AUT REF** is displayed at the bottom of the screen in inverse video.

Sets the moving marker level as the reference level.

1. Press **MARKER**.
2. With the moving marker displayed, press the **MARKER-> REF LEVEL** soft key. The specified reference level is displayed, and the displayed waveform is redrawn according to the changed reference level.

For details on displaying moving markers, see the explanation in section 5.9.



Explanation

Log Scale (REF LEVEL)

The setting range for the log scale reference level is -90.0–30.0 dBm. Settings can be adjusted in steps of 0.1. The value changes in steps of 1 if you press the COARSE key.

Linear Scale (REF LEVEL)

The setting range for the linear scale reference level is 1.00 pW–1000 mW.

When 1.00 to 9.99 (pW, nW, μ W, mW), can be set in steps of 0.01.

When 10.0 to 99.9 (pW, nW, μ W, mW), can be set in steps of 0.1.

When 100 to 999 (pW, nW, μ W, mW), can be set in steps of 1.

If you press the COARSE key you can change the setting in 1-2-5 steps,

for example: 1pW -> 2pW -> 5pW -> 10pW -> 20pW.

If you make a change such as changing 999 to 1.00 or 1.00 to 999, the instrument will be changed.

(Example: Changing pW to nW or changing nW to pW)

One-Action Keys

This is the general name for a key that uses data from the active trace waveform (the currently displayed waveform) to set measurement conditions.

Setting conditions requires that a waveform is displayed for the active trace.

PEAK → REF LEVEL

Sets the peak level of the waveform of the active trace to the reference level.

Displays the specified reference level (peak level value) and waveform in the reference level setting screen. The reference level setting can be changed after being set initially.

The setting can be changed within the range of -90.0–+30.0 dBm for LOG scale, or 1.00 pW–1000 mW for linear scale. If the peak level value exceeds the allowed range, it is set to the nearest value in the range and a warning is displayed.

MARKER → REF LEVEL

This key is used to set the moving marker level as the reference level.

Displays the specified reference level and waveform in the reference level setting screen.

The reference level setting can be changed after being set initially. The setting can be changed within the range of -90.0–+30.0 dBm for LOG scale, or 1.00 pW–1000 mW for linear scale.

If the moving marker value exceeds the allowed range, it is set to the nearest value in the range and a warning is displayed. In the following states, the MARKER → REF LEVEL key is disabled.

- When the moving marker is OFF
- When both split screens are on HOLD

4.5 Center Wavelength (Center Frequency / Center Wavenumber) Setting

Procedure

The following are three ways of setting the center wavelength (center frequency / center wavenumber).

- Set with the **CENTER WL (CENTER FREQ / CENTER WNUM)** soft key.
- Set with the **START WL (START FREQ / START WNUM)** and **STOP WL (STOP FREQ / STOP WNUM)** soft key.
- Set with the One-Action key

The following explains these procedures.

Setting with the CENTER WL (FREQ / WNUM) Soft Key

1. Press **CENTER**. The soft key menu for center wavelength (frequency / wavenumber) settings appears along with the center wavelength (frequency / wavenumber) setting screen.
2. Press the **CENTER WL (FREQ / WNUM)** soft key .
3. Enter a center wavelength (frequency / wavenumber) using the rotary knob, arrow keys, or numeric key pad.
4. Press **nm/ENTER**.

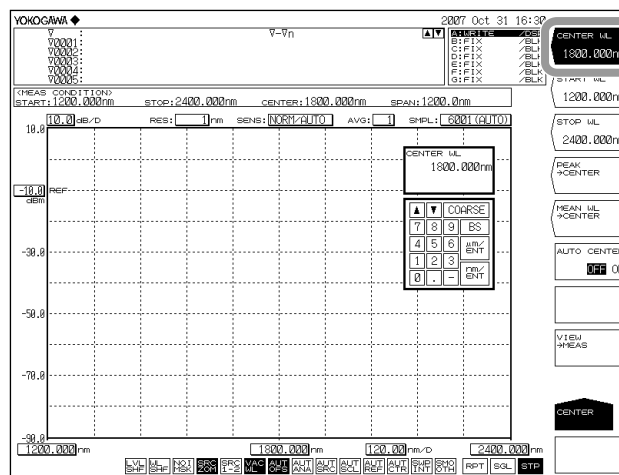

Note

- It is not necessary to press **nm/ENTER** when using the rotary knob or arrow keys.
- The set value is applied to the measurement conditions area.
- When a setting is changed, **NEW** appears in the measurement conditions area.
- If a value outside the setting range is entered, the nearest permitted value is set.

For instructions on switching the wavelength, frequency and wavenumber displays, see section 4.2.

4.5 Center Wavelength (Center Frequency / Center Wavenumber) Setting

Setting with the START WL (FREQ / WNUM) and STOP WL (FREQ / WNUM) Soft Keys

1. Press **CENTER**. The soft key menu for center wavelength (frequency / wavenumber) settings appears.

Setting the Start Wavelength (Frequency / Wavenumber)

2. Press the **START WL (FREQ / WNUM)** soft key. The start wavelength (frequency / wavenumber) setting screen appears.
3. Enter a start wavelength (frequency / wavenumber) using the rotary knob, arrow keys, or numeric key pad.
4. Press **nm/ENTER**.

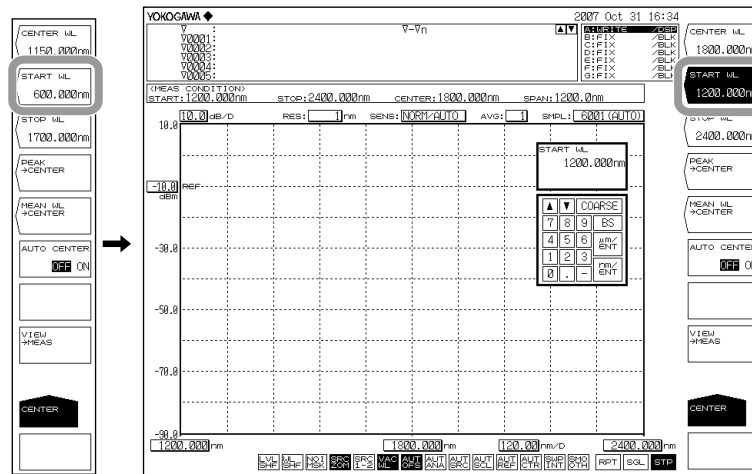

Setting the Stop Wavelength (Frequency / Wavenumber)

5. Press the **STOP WL (FREQ / WNUM)** soft key. The stop wavelength (frequency / wavenumber) setting screen appears.
6. Enter a stop wavelength or stop frequency using the rotary knob, arrow keys, or numeric key pad.
7. Press **nm/ENTER**.

Note

- It is not necessary to press **nm/ENTER** when using the rotary knob or arrow keys.
- The set value is applied to the measurement conditions area.
- When a setting is changed, **NEW** appears in the measurement conditions area.
- If a value outside the setting range is entered, the nearest permitted value is set.

For instructions on switching the wavelength, frequency and wavenumber displays, see section 4.2.

Setting by Using the One-Action Key

Setting the Peak Wavelength (Frequency / Wavenumber) to the Center Wavelength (Frequency / Wavenumber)

1. Press **CENTER**.
2. Press the **PEAK-> CENTER** soft key. The specified center wavelength (frequency / wavenumber) is displayed, and the displayed waveform is redrawn according to the changed center wavelength (frequency / wavenumber).

Setting the THRESH 3dB Center Wavelength (Frequency / Wavenumber) to the Center Wavelength (Frequency / Wavenumber)

1. Press **CENTER**.
2. Press the **MEAN WL-> CENTER** soft key. The specified center wavelength (frequency / wavenumber) is displayed, and the displayed waveform is redrawn according to the changed center wavelength (frequency / wavenumber).

Setting the ZOOM Scale Center Wavelength (Frequency / Wavenumber) to the Center Wavelength (Frequency / Wavenumber)

1. Press **CENTER**.
2. Press the **VIEW-> MEAS** soft key. The specified center wavelength (frequency / wavenumber) is displayed, and the currently set ZOOM scale is set as the measurement scale for the next sweep.

The peak wavelength (frequency / wavenumber) of the waveform measured every sweep can be set automatically to the center wavelength (frequency / wavenumber).

1. Press **CENTER**.
2. press the **AUTO CENTER OFF/ON** soft key to select ON.

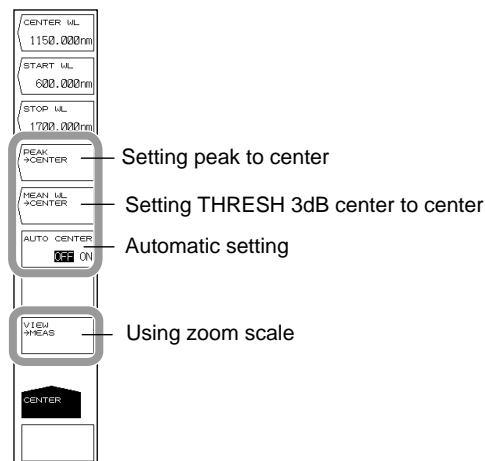

4.5 Center Wavelength (Center Frequency / Center Wavenumber) Setting

Also, you can set the wavelength of the moving marker placed on the measured waveform as the center wavelength (frequency / wavenumber).

1. Press **MARKER**.
2. With the moving marker displayed, press the **MARKER-> CENTER** soft key.
The specified center wavelength (frequency / wavenumber) is displayed, and the displayed waveform is redrawn according to the changed center wavelength (frequency / wavenumber).

For details on displaying moving markers, see the explanation in section 5.9.



Explanation**Center Wavelength (Frequency / Wavenumber)**

The ranges that can be set are as follows.

Center wavelength: 1200.000 to 2400.000 nm

Center frequency: 125.0000 to 250.0000 THz

Center wavenumber: 4167.000 to 8333.000 cm^{-1}

You can change the values using the rotary or arrow keys.

The value changes in 1 nm (0.1 THz/1 cm^{-1}) steps if you press the COARSE key.

The value changes in 0.1 nm (0.01 THz/0.1 cm^{-1}) steps if you do not press the COARSE key.

Start Wavelength (Frequency / Wavenumber)

The ranges that can be set are as follows.

Start wavelength: 600.000 to 2400.000 nm

Start frequency: 60.0000 to 250.0000 THz

Start wavenumber: 2067.000 to 8333.000 cm^{-1}

You can change the values using the rotary or arrow keys.

The value changes in 1 nm (0.1 THz/1 cm^{-1}) steps if you press the COARSE key.

The value changes in 0.1 nm (0.01 THz/0.1 cm^{-1}) steps if you do not press the COARSE key.

Stop Wavelength (Frequency / Wavenumber)

The ranges that can be set are as follows.

Stop wavelength: 1200.000 to 3000.000 nm

Stop frequency: 125.0000 to 315.0000 THz

Stop wavenumber: 4167.000 to 10433.000 cm^{-1}

You can change the values using the rotary or arrow keys.

The value changes in 1 nm (0.1 THz/1 cm^{-1}) steps if you press the COARSE key.

The value changes in 0.1 nm (0.01 THz/0.1 cm^{-1}) steps if you do not press the COARSE key.

Note

- When the start or stop wavelength is set, one wavelength becomes fixed, and this changes the value of the sweep width. In addition, the center wavelength value is also changed at the same time.
- Changing the center wavelength does not change the sweep width.
- The above is the same for Frequency and Wavenumber mode.

AUTO CENTER OFF/ON

This key sets whether the PEAK→CENTER soft key functions for each sweep.

When this key is set to ON, the peak is searched in the active trace waveform and set as the center wavelength automatically for each sweep. The active trace must be set to WRITE. When ON is selected,  at the bottom of the screen is displayed in reverse video.

4.5 Center Wavelength (Center Frequency / Center Wavenumber) Setting

One-Action Keys

This is the general name for a key that uses data from the active trace waveform (the currently displayed waveform) to set measurement conditions.

Setting conditions requires that a waveform is displayed for the active trace.

PEAK →CENTER

Sets the wavelength (frequency / wavenumber) of the peak value to the center wavelength (frequency / wavenumber).

After execution, the center wavelength (frequency / wavenumber) set in the center wavelength (frequency / wavenumber) setting screen is displayed. The center frequency (frequency / wavenumber) can be changed after the setting is made initially.

MEAN WL→CENTER

Sets the RMS center wavelength of the spectrum lowered by the threshold value (20 dB) from the waveform peak of the active trace to the center wavelength (frequency / wavenumber). The center wavelength (frequency / wavenumber) can be changed after the setting is made initially.

VIEW→MEAS

This key is used to set the currently set ZOOM scale (ZOOM CENTER, ZOOM SPAN, ZOOM START, ZOOM STOP) as the measurement scale (CENTER, START, STOP, SPAN).

When you press this key, the current waveform display scale is set as the measurement scale for the next sweep.

4.6 Sweep Width Settings

Procedure

The following are three ways of setting the sweep width.

- Set with the **SPAN WL (SPAN FREQ / SPAN WNUM)** soft key.
- Set with the **START WL (START FREQ / START WNUM)** and **STOP FREQ (START FREQ / START WNUM)** soft key.
- Use the one-action key (soft key).

The following explains these procedures.

Setting by Pressing the SPAN WL (FREQ / WNUM) Soft Key

1. Press **SPAN**. The soft key menu for sweep width settings appears along with the sweep width setting screen.
2. Press **SPAN WL (FREQ / WNUM)** for wavelength (frequency / wavenumber) measurement.
3. Enter a sweep width using the rotary knob, arrow keys, or numeric key pad.
4. Press **nm/ENTER**.

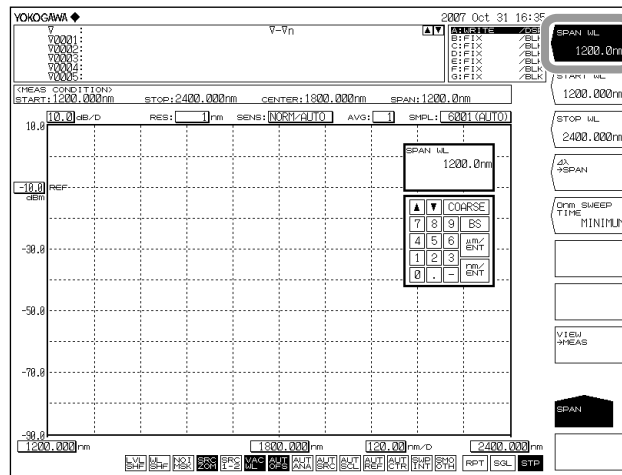

Note

- It is not necessary to press nm/ENTER when using the rotary knob or arrow keys.
- The set value is applied to the measurement conditions area.
- When a setting is changed, **NEW** appears in the measurement conditions area.
- If a value outside the setting range is entered, the nearest permitted value is set.

For instructions on switching the wavelength, frequency and wavenumber displays, see section 4.2.

Setting with the START WL (FREQ / WNUM) and STOP WL (FREQ / WNUM) Soft Key

1. Press **SPAN**. The soft key menu for sweep width settings appears.

Setting the Start Wavelength or Start Frequency

2. Press the **START WL (FREQ / WNUM)** soft key. The start wavelength (frequency / wavenumber) setting screen is displayed.
3. Enter a start wavelength (frequency / wavenumber) using the rotary knob, arrow keys, or numeric key pad.
4. Press **nm/ENTER**.

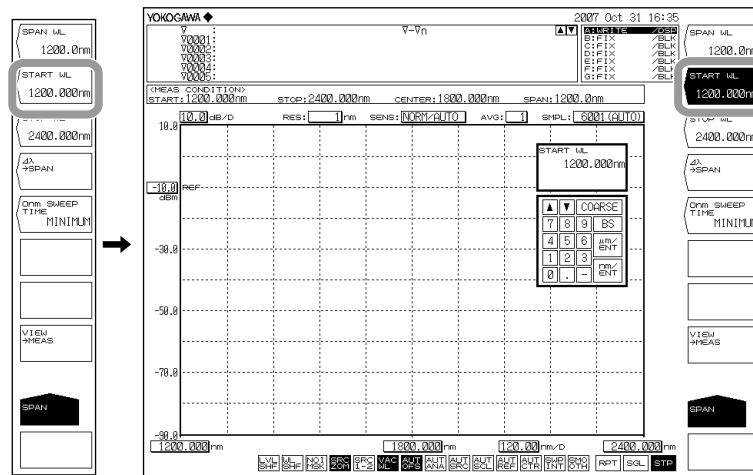

Setting the Stop Wavelength or Stop Frequency

5. Press the **STOP WL (FREQ / WNUM)** soft key. The stop wavelength (frequency / wavenumber) setting screen is displayed.
6. Enter a stop wavelength (frequency / wavenumber) using the rotary knob, arrow keys, or numeric key pad.
7. Press **nm/ENTER**.

Note

- It is not necessary to press **nm/ENTER** when using the rotary knob or arrow keys.
- The set value is applied to the measurement conditions area.
- When a setting is changed, **NEW** appears in the measurement conditions area.
- If a value outside the setting range is entered, the nearest permitted value is set.

For instructions on switching the wavelength, frequency and wavenumber displays, see section 4.2.

Setting by Using the One-Action Key

Setting the Sweep Width from the Measured Waveform

1. Press **SPAN**.
2. Press the $\Delta\lambda \rightarrow$ **SPAN** soft key. Sets the span as six times the RMS 20 dB width of the active trace measurement waveform.



Sets spacing between line markers 1 and 2 for sweep width.

1. Press **MARKER**.
2. Press the **MORE 1/3** soft key.
3. With the line markers 1 and 2 displayed, press the **MKR L1-L2 → SPAN** soft key. Sets spacing between line markers 1 and 2 for sweep width.

For details on displaying line markers, see the explanation in section 5.9.

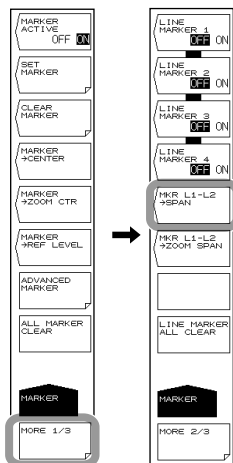

Note

- If only one of the line markers is displayed, for L1, the wavelength on the right edge of the screen is set to the measurement stop wavelength. For L2, the wavelength on the left edge of the screen is set to the measurement start wavelength.
- The MKR L1-L2 → SPAN soft key cannot be used under the following conditions.
 - When both L1 and L2 are OFF.
 - When both SPLIT screens are on HOLD.
 - When the span of the active trace is 0 nm.

Explanation

Wavelength Sweep Width(Frequency / Wavenumber)

The ranges that can be set are as follows.

Wavelength sweep width:	0, and 0.5 to 1200.0 nm
Frequency sweep width:	0, and 0.01 to 130.00 THz
Wavenumber sweep width:	0, and 0.5 to 4200.0 cm^{-1}

If you press the COARSE key you can use the rotary knob or arrow keys to change the numerical value in 1-2-5 steps. The value changes in 1 nm (0.1 THz/1 cm^{-1}) steps if you do not press the COARSE key.

Start Wavelength (Frequency / Wavenumber)

The ranges that can be set are as follows.

Start wavelength:	600.000 to 2400.000 nm
Start frequency:	60.0000 to 250.0000 THz
Start wavenumber:	2067.000 to 8333.000 cm^{-1}

You can change the values using the rotary or arrow keys.

The value changes in 1 nm (0.1 THz/1 cm^{-1}) steps if you press the COARSE key.

The value changes in 0.1 nm (0.01 THz/0.1 cm^{-1}) steps if you do not press the COARSE key.

Stop Wavelength (Frequency / Wavenumber)

The ranges that can be set are as follows.

Stop wavelength:	1200.000 to 3000.000 nm
Stop frequency:	125.0000 to 315.0000 THz
Stop wavenumber:	4167.000 to 10433.000 cm^{-1}

You can change the values using the rotary or arrow keys.

The value changes in 1 nm (0.1 THz/1 cm^{-1}) steps if you press the COARSE key.

The value changes in 0.1 nm (0.01 THz/0.1 cm^{-1}) steps if you do not press the COARSE key.

Note

- Setting the sweep width changes the start wavelength and stop wavelength. The center wavelength/frequency does not change.
 - Changing the center wavelength changes the start wavelength and stop wavelength. The sweep width does not change. When the start or stop wavelength is set, one wavelength becomes fixed, and this changes the value of the sweep width. In addition, the center wavelength value is also changed at the same time.
 - The above is the same for Frequency and Wavenumber mode.
-

One-Action Keys

This is the general name for a key that uses data from the active trace waveform (the currently displayed waveform) to set measurement conditions.

Setting conditions requires that a waveform is displayed for the active trace.

$\Delta\lambda \rightarrow \text{SPAN}$

Sets the sweep width as six times the spectrum width (threshold 20 dB) of the active trace measurement waveform with the RMS method.

MKR L1-L2 $\rightarrow \text{SPAN}$

Sets spacing between line markers 1 and 2 for sweep width.

The setting range is 0.5 to 1200 nm (in 0.1 nm steps).

4.7 Wavelength (Frequency / Wavenumber) Resolution Settings

Procedure

1. Press **SETUP**. The soft key menu for sweep condition settings appears.
2. Press the **RESOLUTION** soft key. The resolutions that can be set appear in the soft key menu.
3. Press the soft key corresponding to the desired resolution. The screen returns to the previous stage, and the value specified by the **RESOLUTION** soft key is displayed.

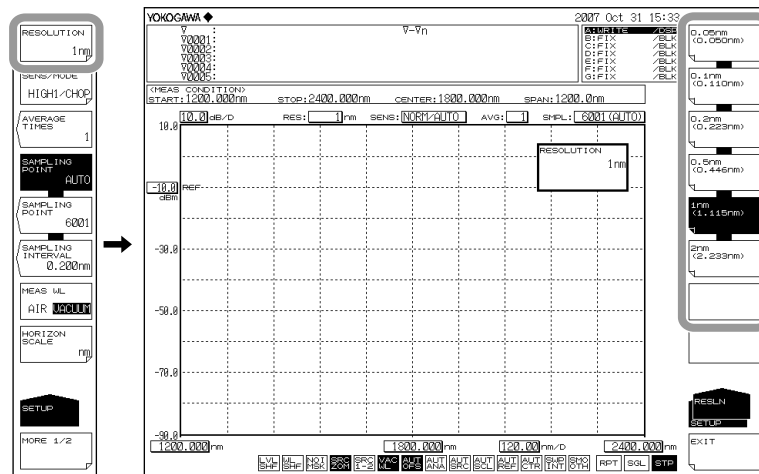

Note

- When entering an arbitrary value using the rotary knob, arrow keys, or numeric key pad in the resolution screen that appears when you press the **RESOLUTION** soft key, the soft key value that is closest to the entered value is set.
- The instrument displays **UNCAL** if the settings for span, the number of sampling points, and the resolution are inappropriate. When **UNCAL** is displayed, normal measurement is not possible.

Corrective Action When “UNCAL” Is Displayed

Perform the following steps.

- Decrease the span.
- Increase the number of samples.
- Lower the resolution (increase the value).
- Select **AUTO** with the **SAMPLING POINT** soft key under **SETUP**.

The “UNCAL” display disappears if the span, number of samples, and the resolution settings are appropriate.

Explanation

Conditions under Which “UNCAL” Is Displayed

“UNCAL” is displayed when a single or repeat sweep is started based on the following relationship between span, setting resolution, and set number of samples:

$$\frac{\text{Span}}{\text{Setting resolution}} \times 5 < \text{Set number of samples} - 1$$

Waveforms with Resolutions of 0.05 nm

When the resolution is set to 0.05 nm for measurements of a light source such as a DFB laser in which with the spectral width is narrower than the instrument’s resolution, very small spikes may occur at the skirts of the waveform. This type of spike occurs due to characteristics of the optical block and is not an indication of any problem. Even if such spikes occur, satisfactory performance in terms of resolution, dynamic range, and the like can be ensured. These spikes will disappear if the resolution is set to a coarser value.

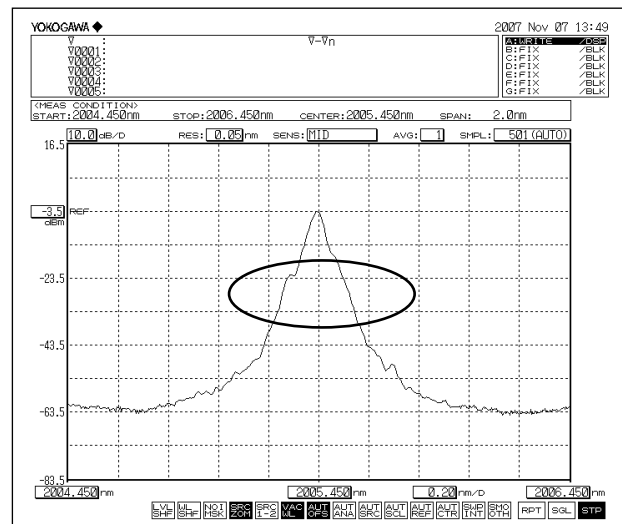

Ripples in the 1350–1450 nm and 1800–1950 nm Area

Water (OH-) ions present in the monochromator absorb light in the 1350–1450 nm, 1800–1950 nm area, resulting in ripples in the measurement waveform. Either set a coarser resolution, use the monochromator in a lower-humidity environment, or execute the purge described on section 2.3 to reduce the amount of ripples.

4.8 Sampling Point/Interval Settings

Procedure

The following are three ways in which the number of samples can be entered.

- Setting the number of samples directly
- Setting by the sampling interval
- Automatically setting the optimum number of samples or the sampling interval according to the sweep width (span) and resolution setting

1. Press **SETUP**. The soft key menu for sweep condition settings appears.
2. Press the **SAMPLING POINT** or **SAMPLING INTERVAL** soft key to set the sampling point or sampling interval, respectively. To automatically set the sampling points and interval according to the span and wavelength (frequency) resolution settings, press **SAMPLING POINT AUTO**. The sampling points or interval setting screen is displayed.

If you pressed **SAMPLING POINT AUTO**, the sampling points and interval are set automatically.

3. Enter a number of samples or interval using the rotary knob, arrow keys, or numeric key pad.
4. Press **ENTER**. The sampling points or interval are set.

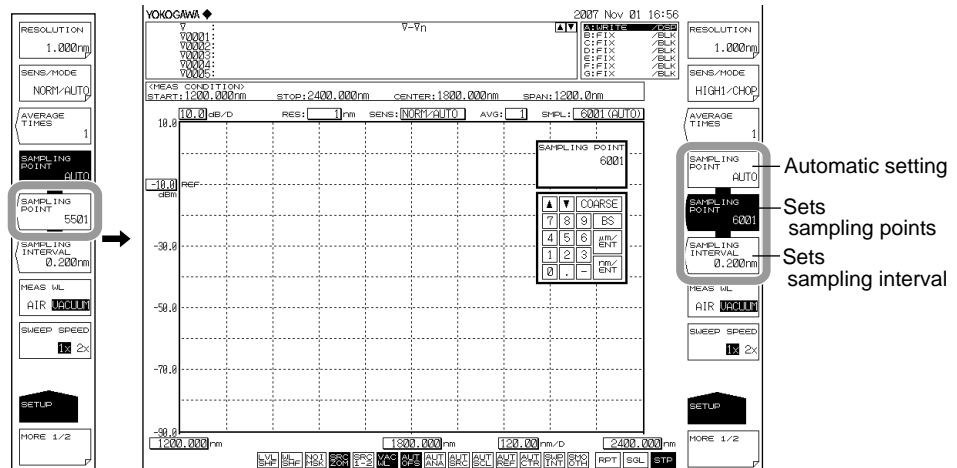

Note

- The instrument displays **UN CAL** if the settings for span, the number of sampling points, and the resolution are inappropriate. When **UN CAL** is displayed, normal measurement is not possible.
- See section 4.7 for the corrective actions when **UN CAL** is displayed.

Explanation

Sampling points (the number of points measured in a single sweep)

Sampling points are the number of points measured within the range of the specified span.

The setting range is 101 to 50001.

Relationship between Sampling Points, Interval, and Span

The relationship between the number of samples, the interval, and the span is as follows.

$$\text{Number of sampling points} = \frac{\text{Span}}{\text{Interval}} + 1$$

Given the same span, the sampling points are automatically determined when the interval is known, and viceversa.

For information about the allowed setting for the span, see the explanation in section 4.6, "Sweep Width Setting."

Note

- Increasing the number of sampling points or decreasing the sampling interval reduces the sweeping speed.
 - Settings that would cause the number of samples in the sweep range to be extremely few cannot be entered.
 - If the setting for the number of samples is changed, the sampling interval value also changes accordingly.
-

Relationship with Wavelength (Frequency / Wavenumber) Resolution

If settings are entered such that the sampling interval determined by the settings for the span and number of samples is extremely long relative to the wavelength (frequency / wavenumber) resolution, data may be lost. Enter settings that are appropriate for the resolution.

4.9 Sensitivity Settings

Procedure

1. Press **SETUP**. The soft key menu for sweep condition settings appears.
2. Press the **SENS/MODE** soft key. Seven sensitivity choices appear in the soft key menu.
3. Press the soft key corresponding to the desired choice. The screen returns to the previous stage, and the value specified by the **SENS/MODE** soft key is displayed.

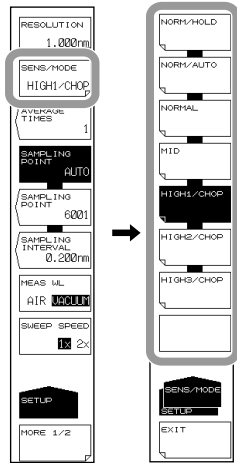

Note

If you set the sensitivity to HIGH1–HIGH3, it is forced to set to CHOP MODE.

Explanation

CHOP MODE

This mode activates the internal chopper of the monochromator. Stray light specific to the monochromator is reduced by turning the chopper. When CHOP MODE is set to CHOP or SWITCH, measurements of better S/N can be made. You can set the CHOP MODE to CHOP if the sensitivity setting is HIGH1–HIGH3. You can set the CHOP MODE to SWITCH if the sensitivity setting is HIGH1–HIGH3 or MID.

CHOP MODE Function List

CHOP MODE	Function	Merit	Defect
Invalid	Measurement according to the stray light. Stray light suppression ratio: 40 dB or more	Measurement time is rapid even for high sensitivity measurements.	Since the stray light is also measured, the low level component is not accurate if the light source is of high power.
Valid	High dynamic measurement using internal modulation. Stray light suppression ratio: 60 dB or more	Measurement can be taken with stray light removed. Long-duration, high sensitivity measurements possible since offset does not change.	Measurement time is long.

Stray Light from the Monochromator

The instrument has a newly designed, high-performance monochromator. Depending on the measurement conditions, stray light at a level 30 to 50 dB below the original spectrum, as well as other stray light specific to the monochromator may occur in wavelength areas about 400 nm from the peak wavelength. If this stray light is likely to have a severe impact on measurements, the sensitivity can be set to HIGH 1/CHOP–HIGH 3/CHOP in order to reduce the effects of the stray light.

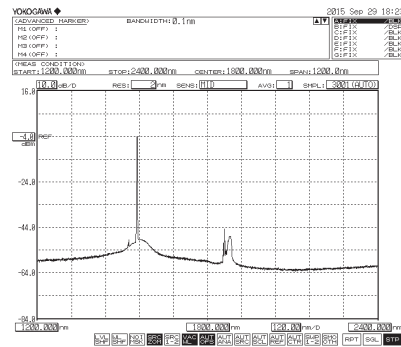

Waveform with CHOP MODE invalid

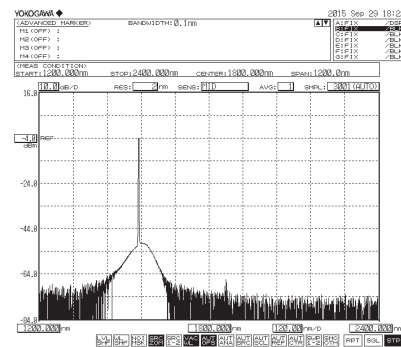

Waveform with CHOP MODE Valid

4.10 Sweep Speed Settings

Procedure

1. Press **SETUP**. The soft key menu for sweep condition settings appears.
2. Press the **SWEEP SPEED** soft key. Each time you press the soft key, the setting toggles between 1x and 2x.

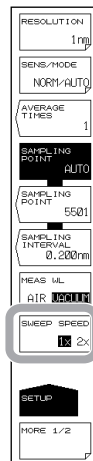

Explanation

SWEEP SPEED

Sets the sweep speed.

- 1x This is the instrument's standard sweep speed. To meet the instrument's specifications, set the sweep speed to this value. With the sweep speed set to this value, the instrument can measure light sources ranging from line spectrum (such as the DFB-LD) to broadband wavelength (such as LEDs) light sources.
- 2x Select this value to set the sweep speed to approximately twice the speed of the 1x value. Select this value when you are measuring light sources that have comparatively gentle spectrum shape level changes, such as LED light sources. Measurements using this value have the following characteristics.
- If you select this value when "UNCAL" is displayed, for waveforms that have sharp spectrum shape changes, such as those produced by the DFB-LD, the level and wavelength measurement accuracies may be lower than those when you select 1x. First check the measurement spectrum, and then select this value if appropriate.
 - The noise level is approximately 2 dB higher than that when you select 1x.

Note

When you set the sweep speed to 2x, **2x SPEED** is displayed in the measurement conditions area.

4.11 Averaging Times Setting

Procedure

1. Press **SETUP**. The soft key menu for sweep condition settings appears.
2. Press the **AVERAGE TIMES** soft key. The averaging times setting screen is displayed.
3. Enter a number of averaging times using the rotary knob, arrow keys, or numeric key pad.
4. Press **ENTER**. The value specified by the **AVERAGE TIMES** soft key is displayed.

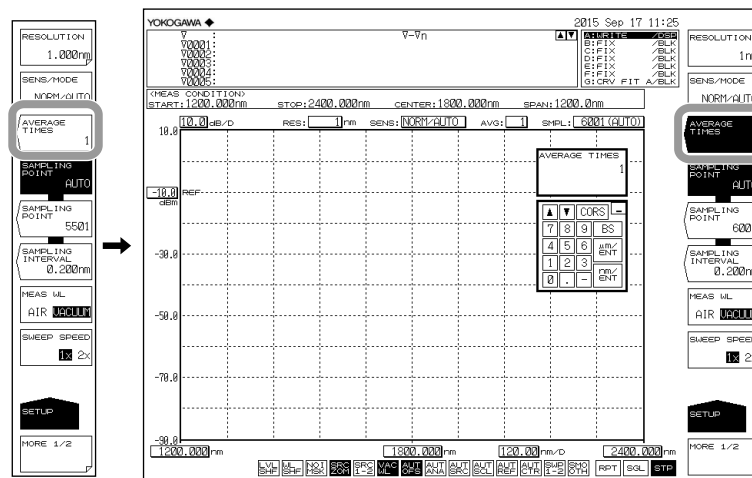

Note

Increasing the averaging times reduces the sweeping speed but the S/N improves.

Explanation

AVERAGE TIMES

This key is used to set the average times for each point.

The setting range is 1 to 999.

If you press the COARSE key you can use the rotary knob or arrow keys to change the numerical value in 1-2-5 steps. The value changes in 1 step if you do not press the COARSE key.

4.12 Trace Settings

Procedure

The following explains selecting a trace, writing waveform data, and displaying the data on screen.

1. Press **TRACE**. The soft key menu for traces appears.
2. Press the **ACTIVE TRACE** soft key. Traces A through G appear in soft keys.
3. Press the soft key corresponding to the trace you wish to use. That trace is set as the active trace (in the example below, this will be trace B).
4. Press the **VIEW B** soft key and select **DISP**.
5. Press the **WRITE B** soft key. Trace B is placed in write mode.

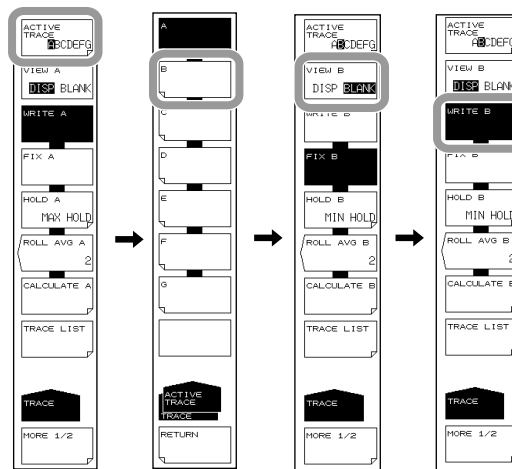

Note

Waveforms of traces for which VIEW A–VIEW G are set to BLANK cannot be displayed on screen.

Explanation

Active Trace

Active trace refers to a target trace to which settings and changes can be applied.

A trace shows a waveform and measurement conditions. The instrument has a total of seven independent traces (A through G). You can specify Show/Hide on each trace, and display multiple traces in the waveform screen.

The following explains the soft keys related to trace settings.

ACTIVE TRACE...ABCDEFG

Selects the active trace from among traces A to G.

You can also switch the active trace using the mouse by clicking TRACE display A through G on the screen.

Displaying Traces

Selects whether or not to display the active trace on screen.

VIEW @...DISP / BLANK

“VIEW @ DISP”: Displays the waveform on the screen. The trace display changes to "DSP".

“VIEW @ BLANK”: Does not display the waveform on the screen. The trace display changes to "BLK".

When you press this key, the highlight toggles between “VIEW @ DISP” and “VIEW @ BLANK”.

Note that if BLANK is set, markers applied to the trace set in DISP will be cleared.

The "at" (@) symbol indicates the currently selected trace. One is included from A–G.

Write Mode

WRITE @

This key is used to set the active trace to write mode.

When a trace is set to write mode, waveform data are written to it and updated during measurement. In addition, the trace display on the side of the data area changes to "WRITE".

The "at" (@) symbol indicates the currently selected trace. One is included from A–G.

Fix mode

FIX @

This key is used to set the active trace to data fixing mode.

When a trace is set to this mode, its waveform data do not change even when measurement is performed. Therefore, the waveform on the screen is not overwritten.

The trace display changes to "FIX".

When the FIX soft key is pressed during sweeping, the waveform displayed at that time is fixed.

The "at" (@) symbol indicates the currently selected trace. One is included from A–G.

4.12 Measurement Start (Sweep)

Procedure

1. Press **SWEEP**. The soft key menu regarding sweep appears.
2. Press the **SINGLE** or **REPEAT** soft key. Sweeping begins.
3. To set the sweep interval, press the **SWEEP INTERVAL** soft key. The sweep interval setting screen is displayed.
4. Enter a numerical value using the rotary knob, arrow keys, or numeric keypad, then press **ENTER**.
5. To stop the sweep, press the **STOP** soft key.

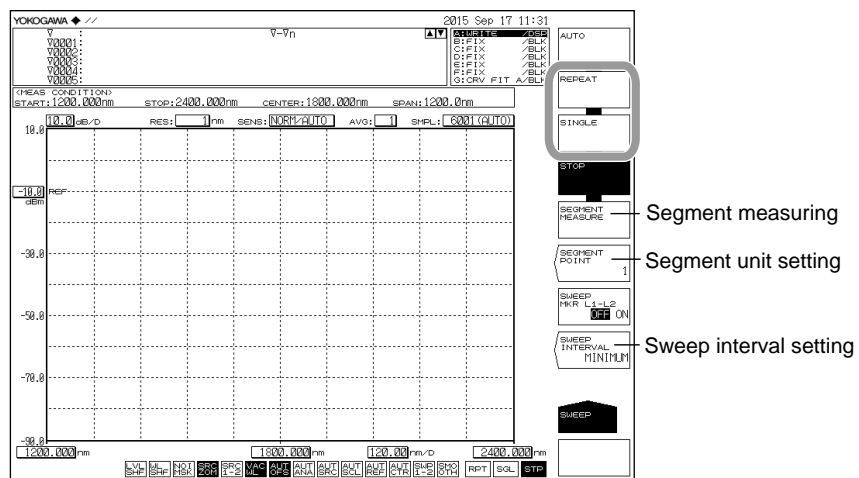

Note

- Sweeping can also be performed by clicking the sweep icons **RPT** | **SGL** located at the bottom of the screen.
- During a sweep, the sweep bar is displayed below the X axis, indicating conditions during the current sweep.
- During a sweep, a sweep icon indicating the sweep status is displayed in the lower left corner of the screen. (Sweep progress from the start wavelength to the sweep wavelength is indicated as a percentage.)

Dividing into Segments and Measuring

Setting the Unit of Segments

2. Continuing on from step 1, press the **SEGMENT POINT** soft key. The segment unit setting screen is displayed.
3. Enter a numerical value using the rotary knob, arrow keys, or numeric keypad, then press **ENTER**.

Starting the Sweep

4. Press the **SEGMENT MEASURE** soft key. Only the specified segment unit is measured, and sweeping stops. The first time (only), sweeping begins from the start wavelength.
5. If you press the **SEGMENT MEASURE** soft key again, sweeping of a segment unit begins from the stopped position.
6. Repeat step 5. When the measured number of samples reaches the specified number of samples, segment measurement ends.
7. To stop the sweep while in progress, press the **STOP** soft key.

Note

- With segment measurement, sweeping is performed in units of segments.
 - If you press the SINGLE key or REPEAT key during segment measurement, segment measurement stops, and sweeping begins from the start wavelength.
-

Explanation

SEGMENT MEASURE

This function divides up the specified number of measurement samples by the segment unit set using the SEGMENT POINT soft key, and performs measurement.

SEGMENT POINT

This key is used to set the number of sampling points for performing <SEGMENT MEASURE>. When you press this key, the current number of sampling points is displayed in the parameter entry window. The number of sampling points can be set in the range of 1 to 50,001 in the DATA ENTRY section. When the setting value of SEGEMENT POINT is larger than the value which deducted points in this time from measurement sampling points , it measures to the last sampling points.

SWEEP INTERVAL

This key is used to set the time from one sweeping start to the next sweeping start during repeat sweeping.

If the time required for sweeping is greater than the set time, the next sweeping is started immediately after sweeping ends.

When you press this key, the current setting time is displayed in the parameter input window. The setting range is MINIMUM or 1 to 99,999 seconds, and is set in the DATA ENTRY section.

If "0" is entered through the numeric keypad, then MINIMUM is set.

If a setting other than MINIMUM is entered,

SWP
INT

 is displayed at the very bottom of the screen in inverse video.

4.14 Specifying a Sweep Range

Procedure

Sweeping between Line Markers

You can sweep between wavelength line marker 1 and wavelength line marker 2.

1. Set wavelength line marker 1 and wavelength line marker 2 at either end of the range you want to sweep.
(For the display procedure, see section 5.9, "Displaying Markers.")
2. Press **SWEEP**. The soft key menu regarding sweep appears.
3. Press the **SWEEP MKR L1-L2 OFF/ON** soft key, and select ON. When set to ON,  is displayed at the very bottom of the screen.
4. Press the **REPEAT** or **SINGLE** soft key. Sweeping between line markers begins.
5. To cancel, press the **SWEEP MKR L1-L2 OFF/ON** soft key, and select OFF. Sweeping is performed over the entire screen.

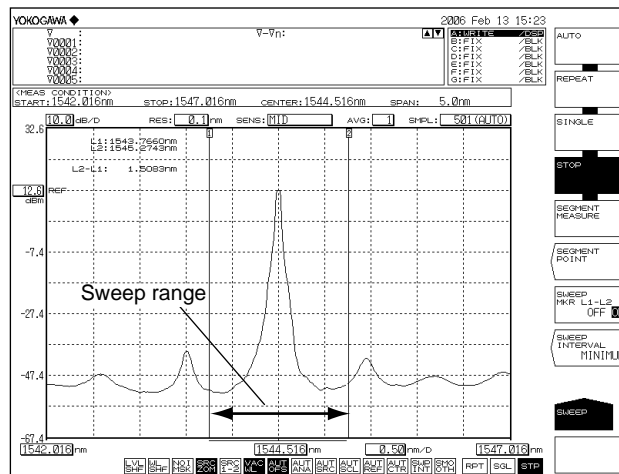

Note

- If both L1 and L2 are set, sweeping is executed between line markers 1 and 2.
- If just L1 is set, the sweep occurs over the span from line marker 1 to the right edge of the screen.
- If just L2 is set, the sweep occurs over the span from the left edge of the screen to line marker 2.
- If neither L1 nor L2 is set, analysis is performed from the set start wavelength to the stop wavelength.

4.15 Pulse Light Measurement

Procedure

The following three methods are available for measuring pulse light.

- Measurement using Peak hold mode
- Measurement as a time average spectrum (see “Explanation”).
- Measurement using External trigger mode.

Pulse Light Measurement Settings

1. Press **SETUP**. The soft key menu for sweep condition settings appears.
2. Press the **MORE** soft key. The MORE 2/2 soft key menu is displayed.
3. Press the **PLS LIGHT MEASURE** soft key.
4. Press the **PEAK HOLD** soft key. The peak hold value setting screen is displayed.
5. Enter a peak hold value using the rotary knob, arrow keys, or numeric key pad. A value larger than the period of the pulse light being measured must be entered for the peak hold value.
6. Press **ENTER**.

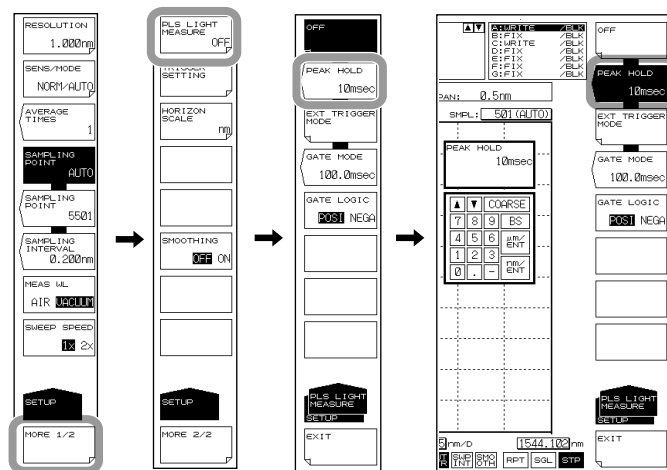

Displaying the Pulse Light Measurement Waveform

7. Press **SWEEP**. The soft key menu for sweep appears.
8. Press the **SINGLE** or **REPEAT** soft key. Sweeping begins, and a waveform is displayed.
9. To stop the sweep, press the **STOP** soft key.

Note

- An appropriate sensitivity is determined from the pulse width of the measured pulse light. For details, see the table, “Sensitivity Name and Corresponding Pulse Width.”
- Enter a value longer than the period of the pulse light being measured for the peak hold value.

Measuring using Gate Sampling

Setting the Sampling Interval Time

1. Press **SETUP**.
2. Press the **MORE 1/2** soft key.
3. Press the **PLS LIGHT MEASURE** soft key.
4. Press the **GATE MODE** soft key. The sampling interval time setting screen appears.
5. Enter the sampling interval using the rotary knob, arrow keys, or numeric keypad.
6. Press **ENTER**.

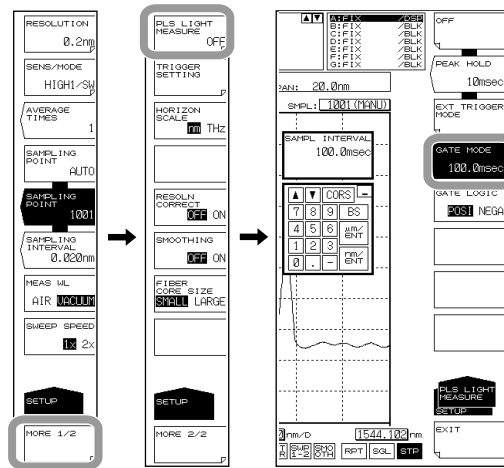

Note

The GATE MODE soft key will be unavailable if the following settings are used. To enable the soft key, change the settings.

- Unavailable when SWEEP MODE is set to 2x. Available when it is set to 1x. See section 4.10.
- Unavailable when CHOP MODE of SENS/MODE is not set to OFF. Available when it is set to OFF. See section 4.9.
- Unavailable when AVERAGE TIMES is not set to 1. Available when it is set to 1. See section 4.11.
- Unavailable when TRIG INPUT MODE of TRIGGER SETTING is set to SMPL ENABLE. Available when it is set to SMPL TRIG. See section 4.16.

Setting the Gate Signal Logic

- Press the GATE LOGIC soft key. Each time you press the key, the setting toggles between POSI and NEGA.



Explanation

PLS LIGHT MEASURE

You can enter pulse light measurement settings and external trigger mode settings.

PEAK HOLD

You can set the peak hold value for the pulse light. Pulse light measurement can be carried out based on this. The setting range is 1 to 9999 ms.

EXT TRIGGER MODE

This mode is used to measure pulse light using an external trigger signal. When this key is selected, sweeping is performed in external trigger mode, wherein sampling is done based on an external trigger signal.

For information on external trigger measurement, see section 4.15.

GATE MODE

In GATE MODE, the AQ6375B samples data when the external signal (gate signal) is active and measures the pulse light. To use this mode, you need to set the sampling interval and signal logic. For details, see “Gate Sampling Measurement,” described later.

Measurement Sensitivity and Corresponding Pulse Width

The measurement sensitivity is determined based on the light pulse width. Select the appropriate sensitivity level based on the pulse width in the table below.

Sensitivity Name and Corresponding Pulse Width

Sensitivity setting	CHOP MODE	On-Screen Notation			Corresponding Pulse Width (Min.)
		Normal	PEAK HOLD Setting	EXT TIRG Setting	
NORM/HOLD	Invalid	NORM/HOLD	P-NORM/HLD	E-NORM/HLD	PEAK: 100µs EXT: 50µs
NORM/AUTO		NORM/AUTO	P-NORM/AUT	E-NORM/AUT	300µs
NORMAL		NORMAL	P-NORMAL	E-NORMAL	1ms
MID		MID	P-MID	E-MID	3ms
HIGH1/CHOP	Valid	H11/CHOP	P-HI1/CHOP	E-HI1/CHOP	50ms
HIGH2/CHOP		H12/CHOP	P-HI2/CHOP	E-HI2/CHOP	200ms
HIGH3/CHOP		H13/CHOP	P-HI3/CHOP	E-HI3/CHOP	2000ms

Gate Sampling Measurement

Gate sampling can be used to measure data only when the gate signal is active during sweeping. By applying an external signal (gate signal) synchronized to the pulse light emission to the AQ6375B, you can efficiently measure pulse light.

Because the gate signal and the sampling time are asynchronous, not all light pulses may be sampled when a single sweep is performed. When the AQ6375B measures several times in repeat sweep mode using the MAX HOLD function, all the light pulses can be sampled, enabling the full waveform can be displayed.

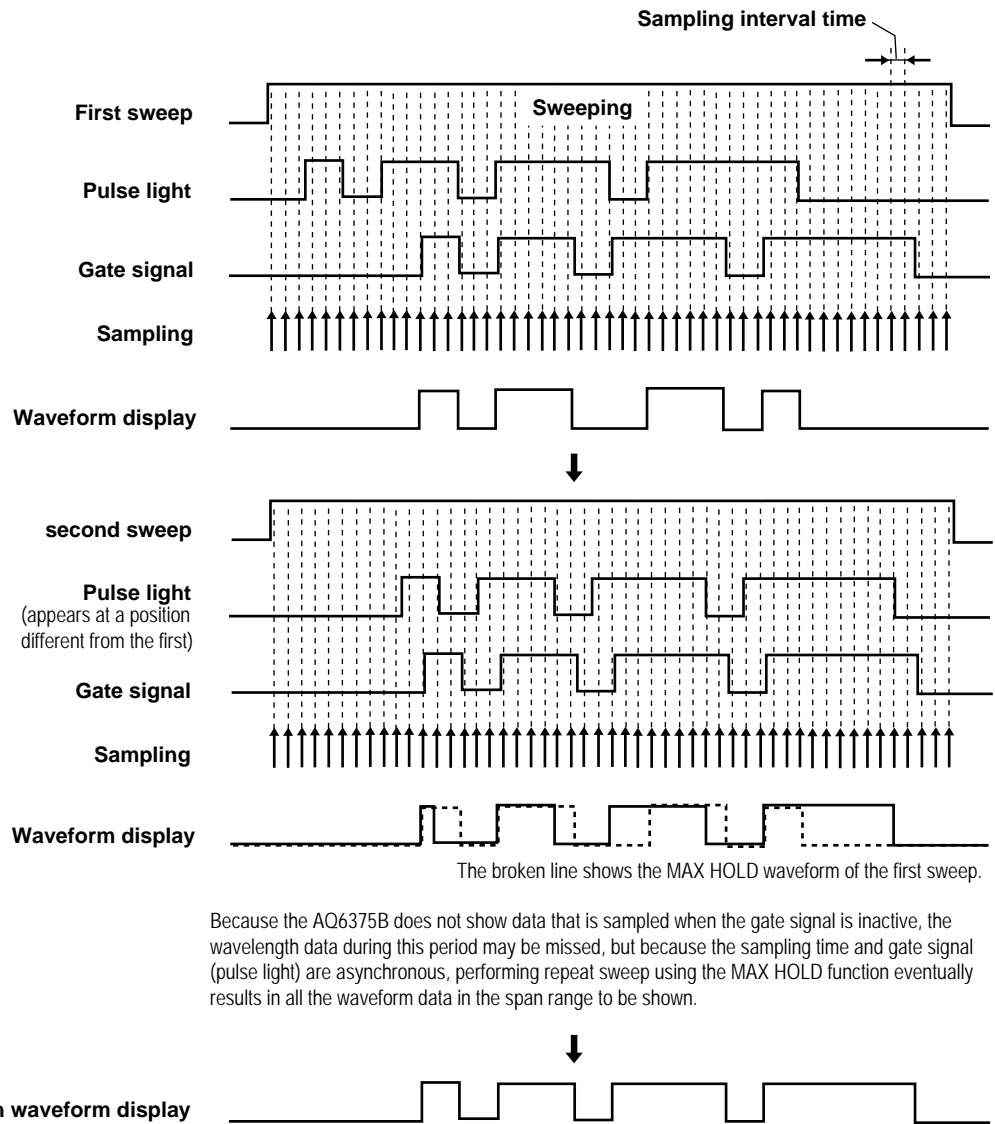

Because the AQ6375B does not show data that is sampled when the gate signal is inactive, the wavelength data during this period may be missed, but because the sampling time and gate signal (pulse light) are asynchronous, performing repeat sweep using the MAX HOLD function eventually results in all the waveform data in the span range to be shown.

* For details on the MAX HOLD function, see section 5.3.

4.15 Pulse Light Measurement

Sampling interval time

Set the sampling interval time for sweeping.

The selectable range is 0.1 to 1000.0 ms (in 0.1 ms steps).

An appropriate sampling interval must be set according to the measurement sensitivity.

Refer to the pulse width corresponding to the sensitivity in the “Sensitivity Name and Pulse Width” table on page 4-40.

Gate Signal Logic

Use GATE LOGIC to set the gate signal logic.

POS: Sampling is performed when the gate signal is at high level.

NEGA: Sampling is performed when the gate signal is at low level.

There is an external trigger input terminal on the rear panel of the AQ6375B. The input signal is TTL level.

Note

The following operations cannot be performed in GATE MODE.

- Set the trigger conditions (section 4.16).
 - Set the CHOP mode (section 4.9).
 - Set the average count (section 4.11).
 - Set the sweep speed (section 4.10).
-

4.16 External Trigger Measurement

Procedure

Setting the Trigger Input Mode

1. Press **SYSTEM**. The soft key menu regarding the system settings appears.
2. Press the **MORE** soft key. The MORE 2/4 soft key menu is displayed.
3. Press the **TRIG INPUT MODE** soft key. The trigger input mode's setting menu is displayed.
4. To set sample trigger mode or sweep trigger mode, press the **SMPL TRIG** or **SWEEP TRIG** soft key, respectively.

If you set **SWEEP TRIG**, that concludes the settings.

If you press the **EXEC** soft key, the instrument returns to the original screen.

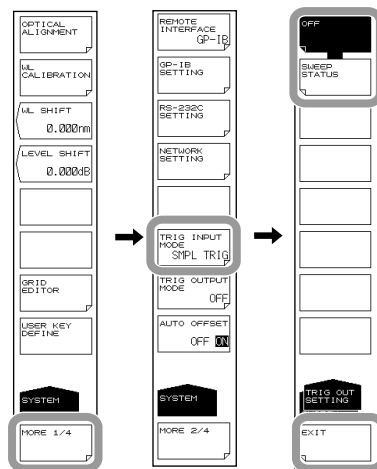

Note

- In sample trigger mode, set SWEEP SPEED to 1x.
- In sweep trigger mode, set SWEEP SPEED to 1x. Also, TRIGGER SETTING and EXT TRIGGER MODE cannot be set.

Setting External Trigger Mode (for SMPL TRIG)

5. Press **SETUP**. The soft key menu for sweep condition settings appears.
6. Press the **MORE** soft key. The MORE 2/2 soft key menu is displayed.
7. Press the **PLS LIGHT MEASURE** soft key.
8. Press the **EXT TRIGGER MODE** soft key. External trigger mode is set.

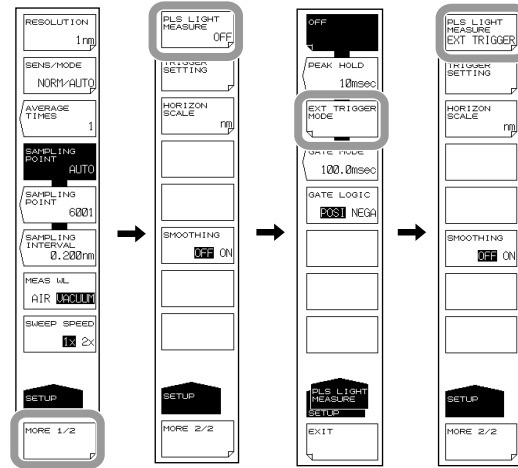

Setting Trigger Conditions (for SMPL TRIG)

9. Press the **TRIGGER SETTING** soft key. The trigger condition setting menu is displayed.
10. Press the **EDGE** soft key. RISE switches to FALL, or vice versa.
11. Press the **DELAY** soft key.
12. Enter a delay time and press **ENTER**.

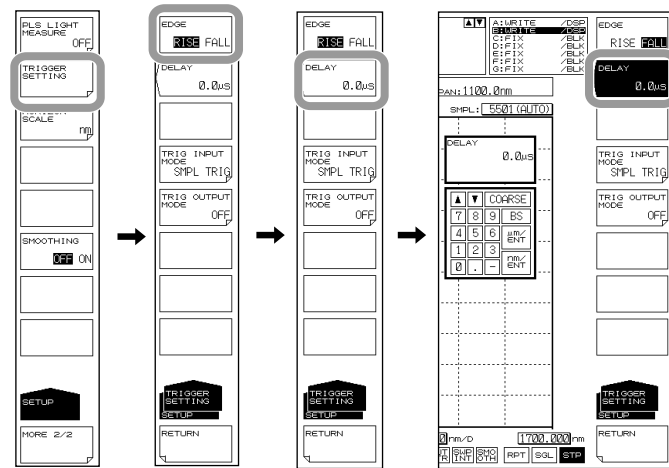

Note

When AVERAGE TIMES is set, sweeping stops when a number of external signals equaling the specified sampling points times the "average times" is input.

Explanation

Data measurement or signal sweeping starts when triggered by an external signal. An external trigger input terminal is located on the rear panel of the instrument. Input signals are of TTL levels.

- SMPL TRIG:** Measurement starts per external trigger signals. You can set whether the trigger activates on a rising or falling edge of the signal. Measurement starts approximately 70 μs after the trigger activates.
- SWEEP TRIG:** Sweeping starts per external trigger signals. The trigger activates on the rising/falling edge of the signal. Sweeping starts 5 ms at most after the trigger activates.
- SMPL ENABLE:** A single or repeat sweep starts when the external trigger signal level is low. The sweep is stopped when the signal level becomes high. If the signal level becomes low again, the sweep starts from the point that it stopped at.

Signal Logic and Delay Time (for SMPL TRIG)**EDGE**

This key is used to set the external trigger signal detection edges.

- RISE** The rising edge is recognized as a trigger.
- FALL** The falling edge is recognized as a trigger.

DELAY **.* μs**

This key is used to set the delay time between trigger signal edge detection and data measurement. The setting range is 0 to 1000.0 μs (fine: steps of 0.1; coarse: steps of 1). For information about the external trigger measurement function, see section 1.2.

Measurement Sensitivity and Corresponding Pulse Width

The measurement sensitivity is determined based on the light pulse width. Select the appropriate sensitivity level based on the pulse width in the table below.

Sensitivity Name and Corresponding Pulse Width

Sensitivity setting	CHOP MODE	On-Screen Notation			Corresponding Pulse Width (Min.)
		Normal	PEAK HOLD Setting	EXT TIRG Setting	
NORM/HOLD	Invalid	NORM/HOLD	P-NORM/HLD	E-NORM/HLD	PEAK: 100 μs EXT: 50 μs
NORM/AUTO		NORM/AUTO	P-NORM/AUT	E-NORM/AUT	300 μs
NORMAL		NORMAL	P-NORMAL	E-NORMAL	1ms
MID		MID	P-MID	E-MID	3ms
HIGH1/CHOP	Valid	HI1/CHOP	P-HI1/CHOP	E-HI1/CHOP	50ms
HIGH2/CHOP		HI2/CHOP	P-HI2/CHOP	E-HI2/CHOP	200ms
HIGH3/CHOP		HI3/CHOP	P-HI3/CHOP	E-HI3/CHOP	2000ms

4.16 External Trigger Measurement

When SMPL ENABLE Is Selected

The minimum necessary pulse width of the external trigger input signal varies according to the sensitivity setting.

If the time that the external trigger input signal level is low is less than this pulse width, the instrument cannot perform the sweep.

Sensitivity Name and Minimum Pulse Width

Sensitivity Setting	Minimum Pulse Width
NORM/HOLD	50 ms
NORM/AUTO	50 ms
NORMAL	50 ms
MID	50 ms
HIGH1/CHOP	100 ms
HIGH2/CHOP	250 ms
HIGH3/CHOP	2050 ms

4.17 Trigger Output

Procedure

Setting the Trigger Output Mode

1. Press **SYSTEM**. The soft key menu for the system settings appears.
2. Press the **MORE** soft key. The **MORE 2/4** soft key menu is displayed.
3. Press the **TRIG OUTPUT MODE** soft key. The trigger output setting menu is displayed.
4. Press the **SWEEP STATUS** soft key.

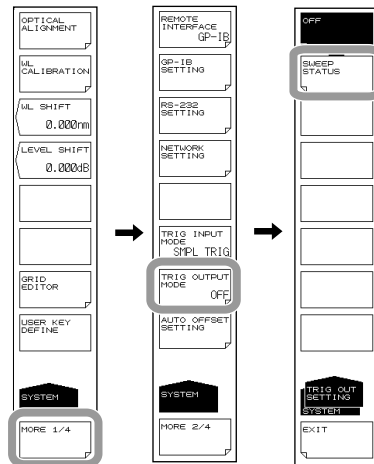

Note

When pulse light measurement is specified, external trigger output cannot be performed. Turn OFF PLS LIGHT MEASURE.

Explanation

You can synchronize sweeping from the trigger output terminal on the rear panel of the instrument and output a positive logic signal. Signals are only output when sweeping. Output signals are of TTL levels.

4.18 Smoothing

Procedure

Setting the Smoothing

1. Press **SETUP**.
2. Press the **MORE 1/2** soft key. The **MORE 2/2** key menu is displayed.
3. Press the **SMOOTHING OFF ON** soft key to select ON.

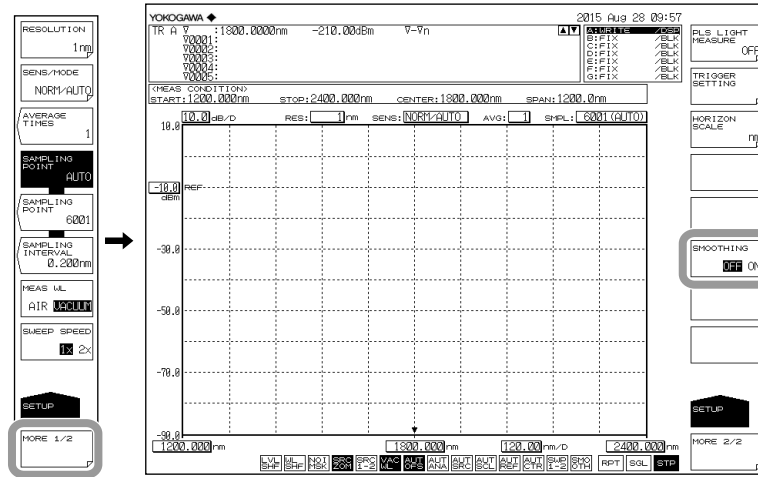

Explanation

Smoothing Function

This function attenuates the noise in the measured waveform. By using the Smoothing function, areas on the waveform with a large amount of noise can be “smoothed out” when measured. Note that when noise is superimposed on abrupt changes in the spectrum, the peaks and valleys of the spectrum are integrated thereby reducing the measurement resolution. Therefore, it is recommended not to use the Smoothing function all the time, but rather to use it judiciously, checking the effects on the measured spectrum. Also, if a relatively small number of samples is set relative to the measurement span (or example, when UNCAL is displayed), the appropriate Smoothing function may not be performed.

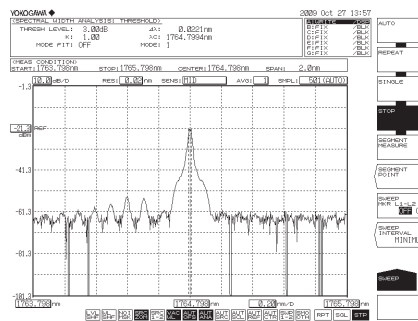

Waveform with SMOOTHING OFF

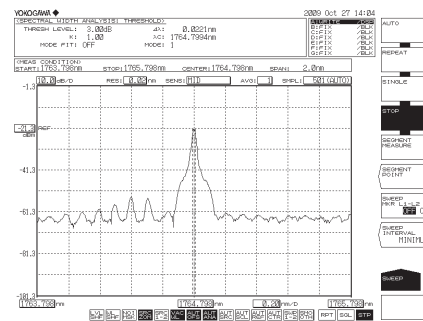

SMOOTHING set to ON

4.19 Analog Out

Procedure

Connecting to the Oscilloscope

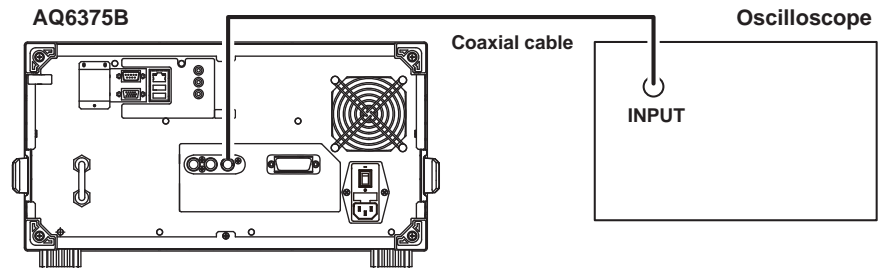

1. Press **SETUP**. The soft key menu for sweep condition settings appears.
2. Press the **SENS/MODE** soft key. Seven sensitivity choices appear in the soft key menu.
3. Press the **NORM/HOLD** soft key. The screen returns to the previous stage, and NORM/HOLD is displayed for the **SENS/MODE** soft key.
4. Press **SWEEP**. The soft key menu for sweep appears.
5. Press the **SINGLE** or **REPEAT** soft key. An analog voltage is output corresponding to the input light.

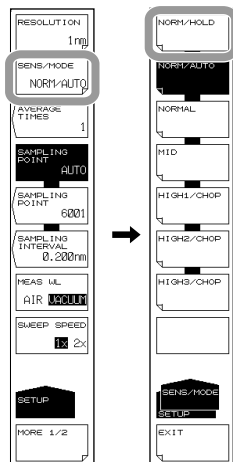

Note

- The analog out function is enabled only when the sensitivity is set to NORM/HOLD.
- If the level of the input light is high, the output voltage level is saturated.

4.19 Analog Out

Explanation

The saturation level and noise level varies depending on the REF level.
The table below shows the relationship between the REF level and the saturation level.

REF LEVEL(dBm or dBm/nm)	Saturation Level * (dBm)
REF > 0	23 dBm or more
0 <= REF > -10	13 dBm or more
-10 <= REF > -20	3 dBm or more
-20 <= REF > -30	-7 dBm or more
-30 <= REF	-17 dBm or more

* At wavelength 1450 to 1620 nm

ANALOG OUT Output Specifications

Output saturation voltage	+6 V or more
Offset voltage (including noise)	±5 mVp-p
Bandwidth	10 kHz or more
Load	1 kΩ or more

5.1 Zooming In/Out on Waveforms

Procedure

The following are three ways of zooming in and out on waveforms.

- By specifying a center wavelength (frequency / wavenumber) and display sweep
- By specifying a start wavelength (frequency / wavenumber) and stop wavelength (frequency / wavenumber)
- By zooming in/out on a range specified with the mouse

The following explains the procedure for each of these methods.

Zooming In/Out by Specifying a Center Wavelength (Frequency / Wavenumber) and Display Sweep

1. Press **ZOOM**. The soft key menu for settings related to zooming in/out on a measured waveform appears.

When Setting the Peak Wavelength (frequency / wavenumber) of the Displayed Waveform as the Center Wavelength for Zooming

2. Press the **PEAK ZOOM CTR** soft key. The peak wavelength (frequency / wavenumber) is set as the zoom center wavelength (frequency / wavenumber). Proceed to step 5.
2. Press the **ZOOM CENTER WL (FREQ / WNUM)** soft key. The zoom center wavelength setting screen is displayed.
3. Enter a zoom center wavelength using the rotary knob, arrow keys, or numeric key pad.
4. Press **nm/ENTER**.
5. Press the **ZOOM SPAN WL (FREQ / WNUM)** soft key. A screen for specifying the display sweep width (the range to zoom in/out on) is displayed.
6. Enter a display sweep width using the rotary knob, arrow keys, or numeric key pad.
7. Press **nm/ENTER**.

Restores the zoomed waveform to its original size

8. Press the **INITIAL** soft key.

Waveform display example

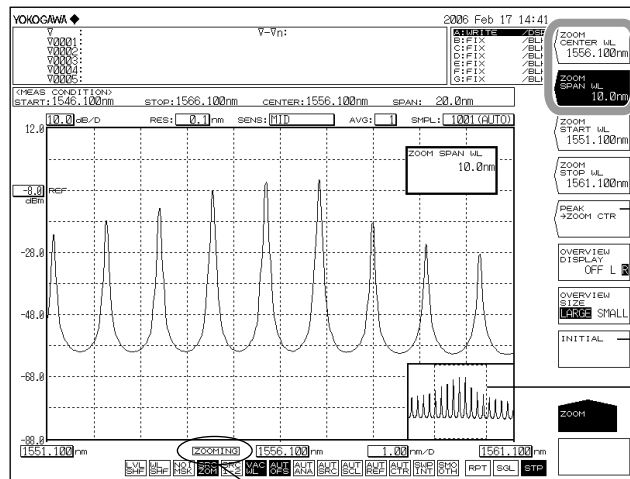

Setting the peak wavelength to the center wavelength of zoom display

Display scale initialization

The zoom area is displayed as a dotted line in the overview window

After changing the display scale (zooming), **ZOOMING** is displayed

5.1 Zooming In/Out on Waveforms

Note

- It is not necessary to press nm/ENTER when using the rotary knob or arrow keys.
- If a value outside the setting range is entered, the nearest permitted value is set.

Zooming In/Out by Specifying a Start Wavelength (Frequency / Wavenumber) and Stop Wavelength (Frequency / Wavenumber)

1. Press **ZOOM**. The soft key menu for settings related to zooming in/out on a measured waveform appears.
2. Press the **ZOOM START WL (FREQ / WNUM)** soft key. A screen for specifying the zoom start wavelength (frequency / wavenumber) is displayed.
3. Enter a zoom start wavelength (frequency / wavenumber) using the rotary knob, arrow keys, or numeric key pad.
4. Press **nm/ENTER**.
5. Press the **ZOOM STOP WL (FREQ / WNUM)** soft key. A screen for specifying the zoom stop wavelength (frequency / wavenumber) is displayed.
6. Enter a zoom stop wavelength (frequency / wavenumber) using the rotary knob, arrow keys, or numeric key pad.
7. Press **nm/ENTER**.

Waveform display example

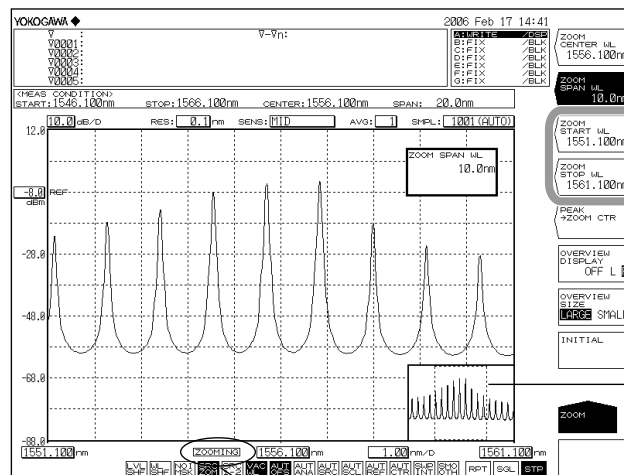

The zoom area is displayed as a dotted line in the overview window

After changing the display scale (zooming), **ZOOMING** is displayed

Note

- It is not necessary to press nm/ENTER when using the rotary knob or arrow keys.
- If a value outside the setting range is entered, the nearest permitted value is set.

Zooming In/Out on a Range Specified with the Mouse

1. In the waveform display area, drag the portion of the waveform to zoom in/out on. A dotted outline is displayed around the selected range. (The zoom area.)
2. When you release the left mouse button, the display zooms in on the zoom area. At the same time, the zoom area is indicated with a dotted line range in the overview window.

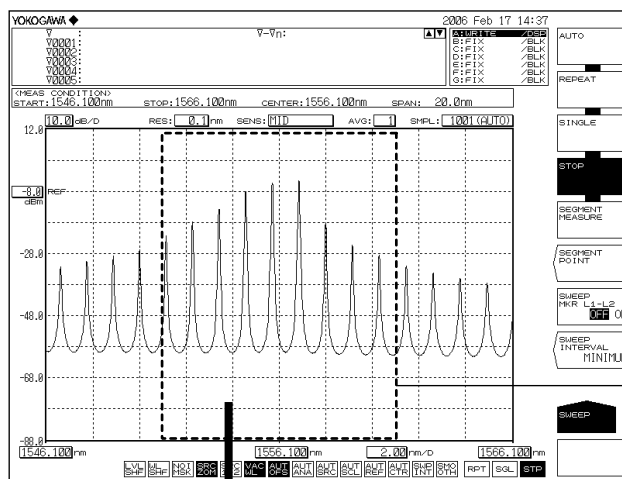

Drag the mouse in the waveform display area to set the zoom area

Zoom

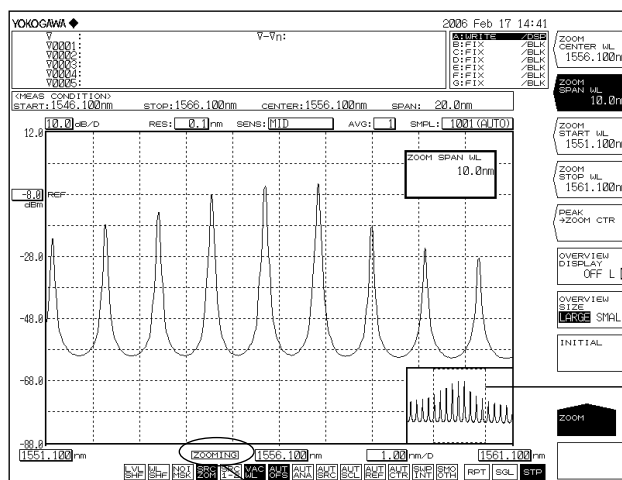

The zoom area is displayed as a dotted line in the overview window

After changing the display scale (zooming), **ZOOMING** is displayed

Note

- If you change the display scale to a value different from the measurement scale, ZOOMING appears on screen. Also, an overview window that shows the measurement scale is displayed in the corner of the measurement screen.
- The display scale and measurement scale are mutually independent.
- Changing the zoom function settings does not change the measurement conditions.

Setting Up the Overview Window

When the waveform display is enlarged or reduced using the zoom function, the overview window is displayed at the very bottom of the waveform display area. (Only displayed when a zoom is performed.)

Showing/Hiding the Window and Setting the Display Position

1. Press **ZOOM**.
2. Press the **OVERVIEW DISPLAY OFF/L/R** soft key. Each time the soft key is pressed, the setting changes in the order Hide, Display Left, and Display Right.

Setting the Window Size

1. Press **ZOOM**.
2. Press the **OVERVIEW SIZE LARGE/SMALL** soft key. The window switches between large and small.

Waveform display example

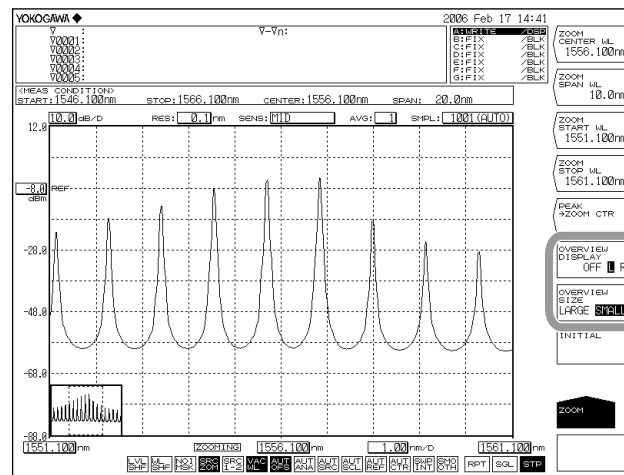

OVERVIEW DISPLAY OFF/L/R set to L and **OVERVIEW SIZE LARGE/SMALL** set to SMALL.

Changing Settings Using the Mouse

The mouse can be used in the overview window to change the display scale settings.

Changing the Center Wavelength (Center Frequency / Center Wavenumber)

1. Move the mouse pointer into the overview window.
2. Drag in the zoom area surrounded by a dotted line.
When doing so, the mouse pointer changes to a hand tool.

Changing the Zoom Start/Stop Wavelength (Frequency / Wavenumber)

1. Move the mouse pointer into the overview window.
2. Drag a vertical dotted line of the zoom area.
When doing so, the mouse pointer changes to an arrow.

Specifying a New Zoom Area

1. Move the mouse pointer into the overview window.
2. Drag outside of the zoom area. A new zoom area is created.
When doing so, the mouse pointer changes to a plus (+) sign.

Note

For information on power measurement inside the zoom area, see section 6.4, "Power Measurement."

Explanation

Zoom Center Wavelength (Frequency / Wavenumber)

The ranges that can be set are as follows.

Center wavelength: 1200.000 to 2400.000 nm

Center frequency: 125.0000 to 250.0000 THz

Center wavenumber: 4167.000 to 8333.000 cm^{-1}

You can change the values using the rotary or arrow keys.

The value changes in 1 nm (0.1 THz/1 cm^{-1}) steps if you press the COARSE key.

The value changes in 0.1 nm (0.01 THz/0.1 cm^{-1}) steps if you do not press the COARSE key.

Wavelength (Frequency / Wavenumber) Display Sweep Width

The ranges that can be set are as follows.

Wavelength sweep width: 0, and 0.5 to 1200.0 nm

Frequency sweep width: 0.01 to 130.00 THz

Wavenumber sweep width: 0.5 to 4200.0 cm^{-1}

If you press the COARSE key you can use the rotary knob or arrow keys to change the numerical value in 1-2-5 steps. The value changes in 1 nm (0.1 THz/1 cm^{-1}) steps if you do not press the COARSE key.

Zoom Start Wavelength (Frequency / Wavenumber)

The ranges that can be set are as follows.

Start wavelength: 600.000 to 2399.950 nm

Start frequency: 60.0000 to 249.9950 THz

Start wavenumber: 2067.000 to 8332.950 cm^{-1}

You can change the values using the rotary or arrow keys.

The value changes in 1 nm (0.1 THz/1 cm^{-1}) steps if you press the COARSE key.

The value changes in 0.1 nm (0.01 THz/0.1 cm^{-1}) steps if you do not press the COARSE key.

Zoom Stop Wavelength (Frequency / Wavenumber)

The ranges that can be set are as follows.

Stop wavelength: 1200.050 to 3000.000 nm

Stop frequency: 125.0050 to 315.0000 THz

Stop wavenumber: 4167.050 to 10433.000 cm^{-1}

You can change the values using the rotary or arrow keys.

The value changes in 1 nm (0.1 THz/1 cm^{-1}) steps if you press the COARSE key.

The value changes in 0.1 nm (0.01 THz/0.1 cm^{-1}) steps if you do not press the COARSE key.

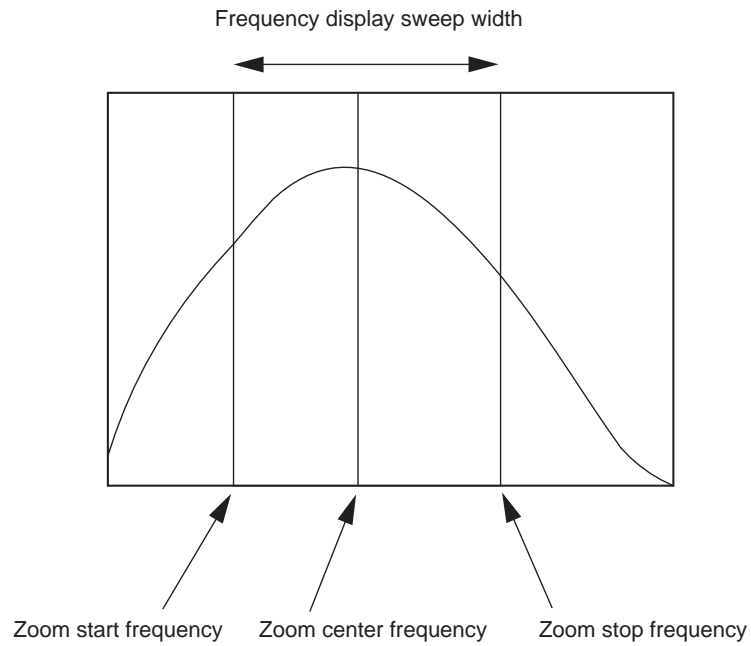
**Note**

- Changing the zoom center wavelength changes the zoom start wavelength and zoom stop wavelength. The waveform display sweep width does not change.
- Changing the wavelength display sweep width changes the zoom start wavelength and zoom stop wavelength. The zoom center wavelength does not change.
- When the zoom start or stop wavelength is set, one wavelength becomes fixed, and this changes the value of the wavelength display sweep width. In addition, the zoom center wavelength value is also changed at the same time.
- The above is the same for Frequency and Wavenumber mode.

5.2 Wavelength Updating/Fixing

Procedure

Selecting a Trace to Update or Fix

1. Press **TRACE**. The soft key menu for trace settings appears.
2. Press the **ACTIVE TRACE** soft key. Traces A through G appear in soft keys.
3. Press the soft key corresponding to the trace you wish to update or fix. The selected trace is set as the active trace, and becomes the target of the operation below.
4. Press the **VIEW** soft key of the selected trace and select **DISP**. Each time you press the soft key **DISP** switches to **BLANK**, or viceversa. (Trace B is given as an example.)

Updating a Waveform

5. Press the **WRITE** soft key. The trace area display switches to WRITE.
6. Perform measurement. The wavelength data is updated.

Fixing a Waveform

5. Press the **FIX** soft key. The trace area display switches to FIX.
6. The waveform data is fixed. Even if measurement is performed, the waveform data is not updated.

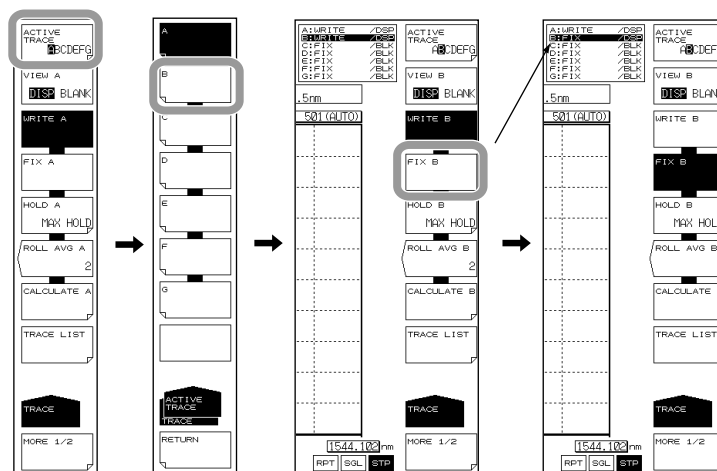

Note

- Only 1 trace can be set as the active waveform. If you wish to update multiple traces, update them one at a time.
- If all traces are set to FIX, a warning appears, and measurement cannot be performed.

For information on the trace function, see section 1.3

Explanation**Active Trace**

Active trace refers to a target trace to which settings and changes can be applied. A trace shows a waveform and measurement conditions. The instrument has a total of seven independent traces (A through G). You can specify Show/Hide on each trace, and display multiple traces in the waveform screen. The following explains the soft keys related to trace settings.

ACTIVE TRACE...ABCDEFG

Selects the active trace from among traces A to G. You can also switch the active trace using the mouse by clicking TRACE display A through G on the screen.

Displaying Traces

Selects whether or not to display the active trace on screen.

VIEW @...DISP / BLANK

"VIEW @ DISP": Displays the waveform on the screen. The trace display changes to "DSP".

"VIEW @ BLANK": Does not display the waveform on the screen. The trace display changes to "BLK".

When you press this key, the highlight toggles between "VIEW @ DISP" and "VIEW @ BLANK".

Note that if BLANK is set, markers applied to the trace set in DISP will be cleared. The "at" (@) symbol indicates the currently selected trace. One is included from A–G.

Write Mode**WRITE @**

This key is used to set the active trace to write mode.

When a trace is set to write mode, waveform data are written to it and updated during measurement. In addition, the trace display on the side of the data area changes to "WRITE".

The "at" (@) symbol indicates the currently selected trace. One is included from A–G.

Fixed mode**FIX @**

This key is used to set the active trace to data fixing mode.

When a trace is set to this mode, its waveform data do not change even when measurement is performed. Therefore, the waveform on the screen is not overwritten. The trace display changes to "FIX".

When the FIX soft key is pressed during sweeping, the waveform displayed at that time is fixed.

The "at" (@) symbol indicates the currently selected trace. One is included from A–G.

5.3 MAX/MIN HOLD Display

Procedure

Selecting a Trace to Hold

1. Press **TRACE**. The soft key menu for trace settings appears.
2. Press the **ACTIVE TRACE** soft key. Traces A through G appear in soft keys.
3. Press the soft key corresponding to the trace whose maximum or minimum value you wish to hold. The selected trace is set as the active trace, and becomes the target of the operation below.
4. Press the **VIEW** soft key of the selected trace and select **DISP**. Each time you press the soft key **DISP** switches to **BLANK**, or vice versa. (Trace B is given as an example.)

Holding the Maximum/Minimum Value

5. Press the **HOLD** soft key. The soft key menu for selecting MAX/MIN appears.
6. To hold the maximum value press the **MAX HOLD** soft key.
To hold the minimum value press the **MIN HOLD** soft key.
The maximum or minimum value is held.
7. Perform measurement.

If you selected **MAX HOLD** and the measured value is larger than the previous value, waveform data is updated.

If you selected **MIN HOLD** and the measured value is smaller than the previous value, waveform data is updated.

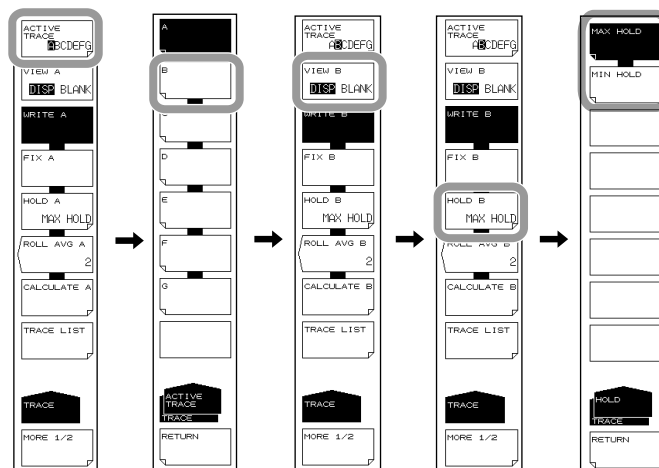

Note

MAX/MIN HOLD is only enabled when the sweep mode is REPEAT. It does not function even if you perform repeated SINGLE sweeps.

5.4 Sweep Average

Procedure

Selecting a Trace to Average

1. Press **TRACE**. The soft key menu for trace settings appears.
2. Press the **ACTIVE TRACE** soft key. Traces A through G appear in soft keys.
3. Press the soft key corresponding to the trace you wish to average. The selected trace is set as the active trace, and becomes the target of the operation below.
4. Press the **VIEW** soft key of the selected trace and select **DISP**. Each time you press the soft key **DISP** switches to **BLANK**, or viceversa. (Trace B is given as an example.)

Setting the Averaging Times

5. Press the **ROLL AVE** soft key. The averaging times dialog box is displayed.
6. Enter a number of averaging times using the rotary knob, step keys, or numeric key pad.
7. Perform measurement. The sweep average value is updated each time measurement is performed.

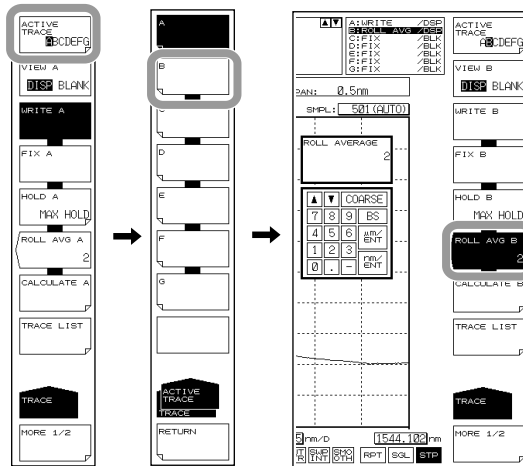

note

The allowed setting for averaging times is 2-100.

5.4 Sweep Average

Explanation

When a trace is set to ROLL AVG mode, each time measurement is performed the sweep average is taken of the current and past measured data, and the measurement data are updated.

The roll averaging is calculated according to the following equation.

$$W_j(i) = W_{j-1}(i) \cdot (n - 1) / n + W(i) \cdot 1 / n \quad (i=1, 2, \dots, N)$$

$W_j(i)$: Newly displayed waveform

$W_{j-1}(i)$: Previously displayed waveform

$W(i)$: Newly obtained waveform

N : Number of sampling points

n : Number of averagings

Note

- The setting values of the NOISE MASK function are not affected by sweep averaging. The noise mask is executed when the results of the sweep average are displayed.
 - When CHOP MODE in the measurement sensitivity settings is set to SWITCH, two sweepings is one count.
-

5.5 Displaying Calculated Waveforms

Procedure

Selecting Traces for Calculation

1. Press **TRACE**. The soft key menu for trace settings appears.
2. Press the **ACTIVE TRACE** soft key. Traces A through G appear in soft keys.
3. Press the soft key corresponding to a trace that is available for trace-to-trace calculation (C, F, or G).

The calculated results are displayed in the selected trace.

The items that can be calculated differ depending on the trace selected.

4. Press the **VIEW** soft key of the selected trace and select **DISP**. Each time you press the soft key **DISP** switches to **BLANK**, or viceversa.

Selecting a Calculation

5. Press the **CALCULATE** soft key. The LOG and Linear selection menus are displayed.
6. For log calculations, press the **LOG MATH** soft key. For linear calculations, press the **LIN MATH** soft key. The soft key menu showing the choices for calculation appears.
7. Press the soft key corresponding to the desired calculation. The calculation executes.

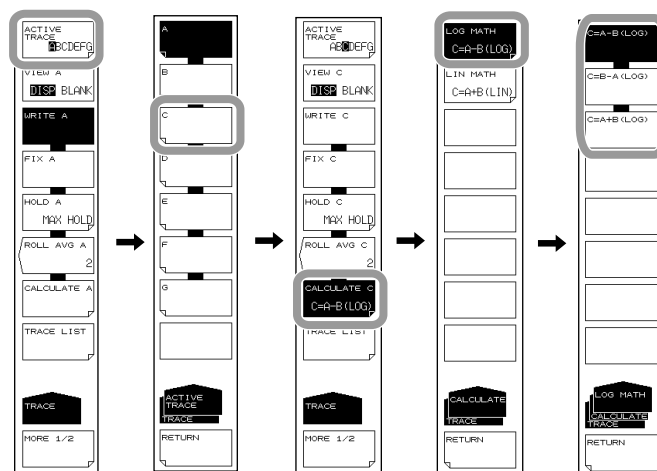

Note

- Trace-to-trace calculations can only be performed on C, F, or G. If the active trace is set to something other than trace C, F, or G, the CALCULATE key is disabled.
- If a trace targeted for calculation is remeasured and the center wavelength and measurement span of the trace being measured is changed, it is recalculated and redisplayed.
- If the measurement condition (resolution) of the trace targeted for calculation does not match, a warning is displayed after calculation.

Explanation

Executable Trace-to-Trace Calculations

Trace C

LOG calculations: A-B, B-A, A+B

Linear calculations: A+B, B-A, A-B, 1-k(A/B), 1-k(B/A)

Trace F

LOG calculations: C-D, D-C, C+D, D-E, E-D, D+E

Linear calculations: C+D, C-D, D-C, D+E, D-E, E-D

Trace G

LOG calculations: C-F, F-C, C+F, E-F, F-E, E+F

Linear calculations: C+F, C-F, F-C, E+F, E-F, F-E

NORMALIZE (A, B, C)

CURVE FIT (A, B, C)

PEAK CURVE FIT (A, B, C)

MARKER FIT

Calculation results are written to their corresponding traces.

Details of Calculation

The following are explanations given for traces C, F, and G.

Trace C: CALCULATE C

LOG MATH

This key is used to perform LOG calculations on trace-to-trace data and write the results to trace C. Calculations can be applied to trace A and trace B. If both traces selected for calculation are set to "BLANK", then the sub-scale is displayed on the left side of the screen. Otherwise it is displayed on the right side. The calculation results are displayed in the sub-scale.

C=A-B(LOG) Subtracts trace B from trace A in LOG form.

C=B-A(LOG) Subtracts trace A from trace B in LOG form.

C=A+B(LOG) Adds trace A and trace B in LOG form.

LIN MATH

This key is used to perform linear calculations on trace-to-trace data and write the results to trace F. Calculations can be applied to trace A and trace B. The calculation results are displayed in the main scale.

C=A+B(LIN) Adds trace A and trace B in linear form.

C=A-B(LIN) Subtracts trace B from trace A in linear form.

C=B-A(LIN) Subtracts trace A from trace B in linear form.

C=1-k(A/B) Given Trace A and Trace B, calculates 1-k(A/B).

Calculates $1-k \times (\text{trace A}/\text{Trace B})$ (linear value), and writes the results to trace C.

The coefficient k may be changed in the range of 1.0000 to 20000.0000 (in steps of 0.0001) using the rotary knob, arrow keys, or numeric keypad.

The coefficient k setting applies to both the <C=1-k(A/B)> key and <C=1-k(B/A)> key. The trace display on the side of the data area changes to "1-k(A/B)".

C=1-k(B/A) Given Trace A and Trace B, calculates 1-k(B/A).

Calculates $1-k \times (\text{Trace B}/\text{Trace A})$ (linear value), and writes the results to trace C.

The trace display on the side of the data area changes to "1-k(B/A)".

Example of Specific Usage

As shown below, this $\left\langle 1-kA/B \rightarrow C \right\rangle$ key or $\left\langle 1-kB/A \rightarrow C \right\rangle$ key may be used to estimate the transmission efficiency from the reflection light spectrum, or estimate the reflectivity from the transmission light spectrum for DUT.

- (1) Estimating the transmission efficiency (trace C) from the reflection light spectrum (trace A)

$$\text{Transmitted light spectrum (TRACE C)} = 1-k (\text{TRACE A}/\text{TRACE B})$$

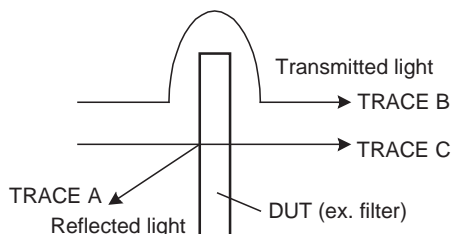

- (2) Estimating the reflectivity (trace C) from the transmission light spectrum (trace A)

$$\text{Reflected light spectrum (TRACE C)} = 1-k (\text{TRACE A}/\text{TRACE B})$$

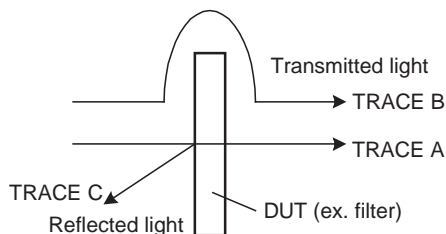

The value of k is an absorption coefficient which is used in determining the DUT reflectivity and transmission efficiency. Different algorithms are used depending on whether transmission efficiency or reflectivity is estimated, so the k value also varies accordingly.

The following equation can be used to determine “ k_r ” and “ k_t ”. In the equation, P_{in} is the level prior to DUT input; P_{out} is the level after DUT input; P_{re} is the DUT reflection level; “ k_r ” is the absorption coefficient used to determine the reflectivity; and “ k_t ” is the absorption coefficient used to determine the transmission efficiency. (Each level is a linear value.)

Estimating the reflected light spectrum from the transmission light spectrum

$$k_t = (P_{in} - P_{re}) / P_{out}$$

Estimating the transmission light spectrum from the reflected light spectrum

$$k_r = (P_{in} - P_{out}) / P_{re}$$

Trace F: CALCULATE F

LOG MATH

This key is used to perform LOG calculations on trace-to-trace data and write the results to trace F. Calculations can be applied to trace C, trace D, and trace E. If both traces selected for calculation are set to "BLANK", then the sub-scale is displayed on the left side of the screen. Otherwise it is displayed on the right side. The calculation results are displayed in the sub-scale.

$F=C-D(\text{LOG})$ Subtracts trace D from trace C in LOG form.

$F=D-C(\text{LOG})$ Subtracts trace C from trace D in LOG form.

$F=C+D(\text{LOG})$ Adds trace C and trace D in LOG form.

$F=D-E(\text{LOG})$ Subtracts trace E from trace D in LOG form.

$F=E-D(\text{LOG})$ Subtracts trace D from trace E in LOG form.

$F=D+E(\text{LOG})$ Adds trace D and trace E in LOG form.

LIN MATH

This key is used to perform linear calculations on trace-to-trace data and write the results to trace F. Calculations can be applied to trace C, trace D, and trace E. The calculation results are displayed in the main scale.

$F=C+D(\text{LIN})$ Adds trace C and trace D in linear form.

$F=C-D(\text{LIN})$ Subtracts trace D from trace C in linear form.

$F=D-C(\text{LIN})$ Subtracts trace C from trace D in linear form.

$F=D+E(\text{LIN})$ Adds trace D and trace E in linear form.

$F=D-E(\text{LIN})$ Subtracts trace E from trace D in linear form.

$F=E-D(\text{LIN})$ Subtracts trace D from trace E in linear form.

POWER/NBW

For more information, see section 5.9, "Power Spectral Density Trace."

Trace G: CALCULATE G**LOG MATH**

This key is used to perform LOG calculations on trace-to-trace data and write the results to trace G. Calculations can be applied to trace C, trace E, and trace F. If both traces selected for calculation are set to "BLANK", then the sub-scale is displayed on the left side of the screen. Otherwise it is displayed on the right side. The calculation results are displayed in the sub-scale.

$G=C-F(\text{LOG})$ Subtracts trace F from trace C in LOG form.

$G=F-C(\text{LOG})$ Subtracts trace C from trace F in LOG form.

$G=C+F(\text{LOG})$ Adds trace C and trace F in LOG form.

$G=E-F(\text{LOG})$ Subtracts trace F from trace E in LOG form.

$G=F-E(\text{LOG})$ Subtracts trace E from trace F in LOG form.

$G=E+F(\text{LOG})$ Adds trace E and trace F in LOG form.

LIN MATH

This key is used to perform linear calculations on trace-to-trace data and write the results to trace G. Calculations can be applied to trace C, trace E, and trace F. The calculation results are displayed in the main scale.

$G=C+F(\text{LIN})$ Adds trace C and trace F in linear form.

$G=C-F(\text{LIN})$ Subtracts trace F from trace C in linear form.

$G=F-C(\text{LIN})$ Subtracts trace C from trace F in linear form.

$G=E+F(\text{LIN})$ Adds trace E and trace F in linear form.

$G=E-F(\text{LIN})$ Subtracts trace F from trace E in linear form.

$G=F-E(\text{LIN})$ Subtracts trace E from trace F in linear form.

NORMALIZE

This is one of the trace calculation modes. The trace data is normalized and displayed. The normalization results can be written to trace G and displayed. One trace can be normalized, either trace A, B, or C. The peak of a normalized waveform is 1 if the subscale is linear, or 0 dB for a LOG scale.

Data are displayed when sweeping is completed at the stop.

If both traces selected for calculation are set to "BLANK", then the sub-scale is displayed on the left side of the screen. Otherwise it is displayed on the right side. The calculation results are displayed in the sub-scale.

The trace display at the side of the data area changes to "NORM @".

$G=\text{NORM A}$ Normalizes trace A and writes the normalized data to trace G.

$G=\text{NORM B}$ Normalizes trace B and writes the normalized data to trace G.

$G=\text{NORM C}$ Normalizes trace C and writes the normalized data to trace G.

CURVE FIT

For more information, see section 5.7, "Curve Fit."

PEAK CURVE FIT

For more information, see section 5.7, "Curve Fit."

5.6 Normalized Display

Procedure

1. Press **TRACE**. The soft key menu for trace settings appears.
2. Press the **ACTIVE TRACE** soft key. Traces A through G appear in soft keys.
3. Press the Trace G soft key. The Trace G setting menu is displayed.
4. Press the **VIEW G DISP/BLANK** soft key and select **DISP**. Each time you press the soft key **DISP** switches to **BLANK**, or viceversa.
5. Press the **CALCULATE G** soft key.
6. Press the **NORMALIZE** soft key.
7. To normalize Trace A press the **G=NORM A** soft key, to normalize Trace B press **G=NORM B**, and to normalize Trace G, press **G=NORM C**.

Example of waveform before normalization

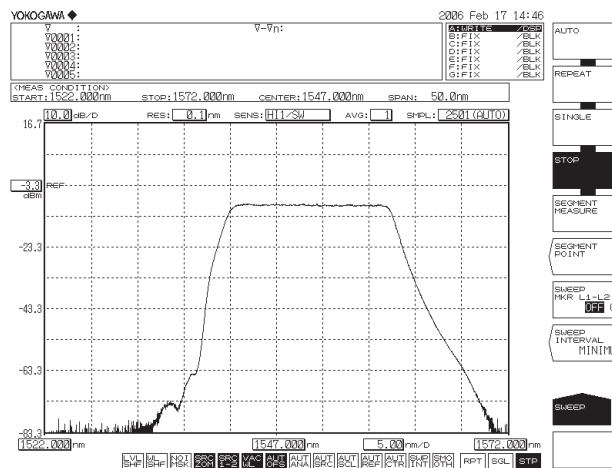

Example of waveform after normalization

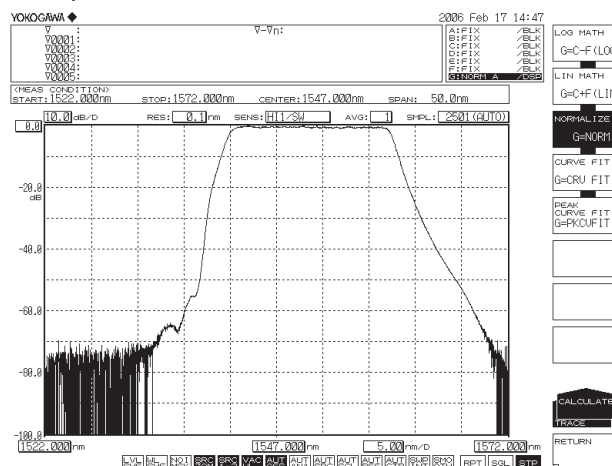

Note

- Normalization is not possible if the waveform level is too low.
- See section 5.5 for information about NORMALIZE.

5.7 Curve Fitting

Procedure

Setting the Target Trace

1. Press **TRACE**. The soft key menu for trace settings appears.
2. Press the **ACTIVE TRACE** soft key. Traces A through G appear in soft keys.
3. Press the Trace G soft key. The Trace G setting menu is displayed.
4. Press the **VIEW G DISP/BLANK** soft key and select **DISP**. Each time you press the soft key **DISP** switches to **BLANK**, or viceversa.
5. Press the **CALCULATE G** soft key.
6. Press the **CURVE FIT** soft key. The menu for selecting the trace to curve fit is displayed.
7. To curve fit Trace A press the **G=CRV FIT A** soft key, to curve fit Trace B press **G=CRV FIT B**, and to curve fit Trace G, press **G=CRV FIT C**.

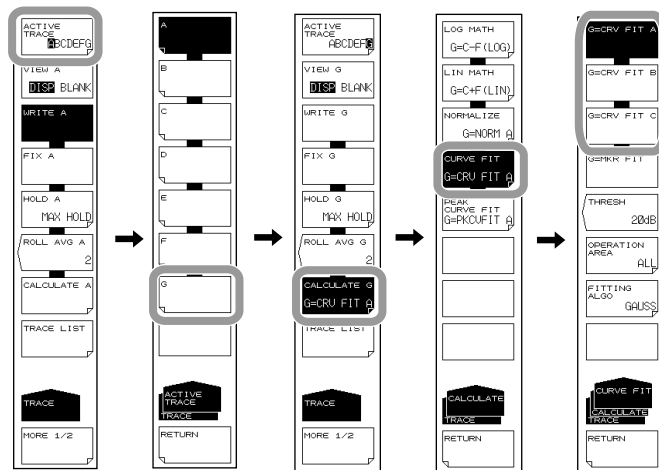

Setting the Calculation Target Range

8. Press the **THRESH** soft key. The threshold setting screen is displayed.
9. Enter a threshold using the rotary knob, arrow keys, or numeric key pad.
10. Press **ENTER**.
11. Press the **OPERATION AREA** soft key. The calculation target range setting menu is displayed.
12. Press the soft key corresponding to the range to be set as the calculation target.

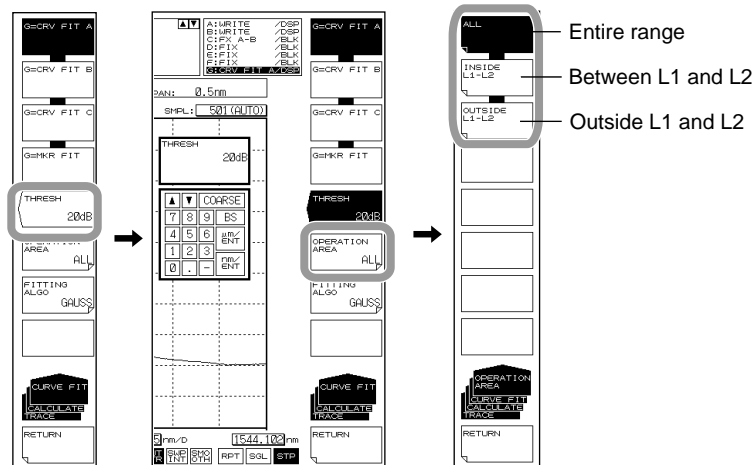

Note

For information about the calculation target range, see the explanation.

Selecting the Curve Fitting Algorithm

13. Press the **FITTING ALGO** soft key. The algorithm setting menu is displayed.
14. Press the soft key corresponding to the algorithm you wish to use.

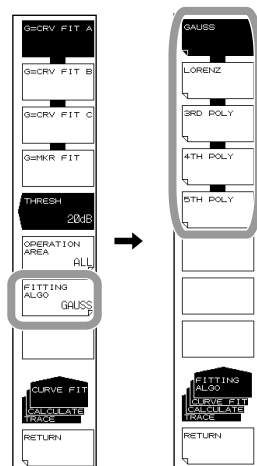

Note

For information about the curve fitting algorithm, see the explanation.

Peak Curve Fit

6. Continuing on from step 5, press the **PEAK CURVE FIT** soft key.
7. To peak curve fit Trace A press the **G=PKCFIT A** soft key, to peak curve fit Trace B press **G=PKCFIT B**, and to peak curve fit Trace G, press **G=PKCFIT C**. Step 8 and thereafter are the same as for curve fitting.

Example of the screen for running peak curve fitting when the curve fitting function is set to GAUSS.

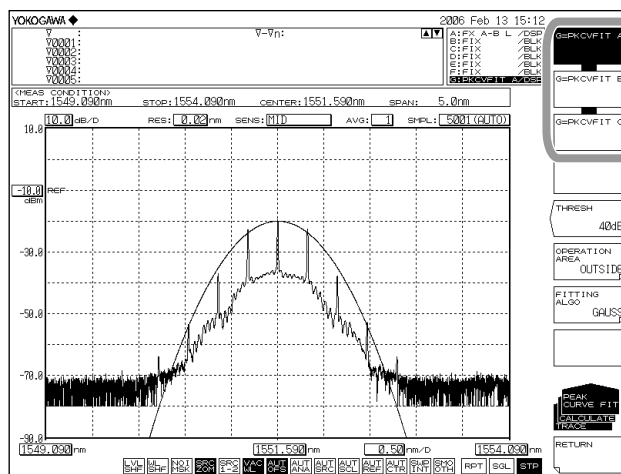

Explanation

Curve Fit Target Range

Curve-fits the specified trace waveform and writes the results to trace G.
 Calculations are applied to data from the threshold value to the peak. The threshold value is set in the range of 0 to 99 dB (steps of 1). The trace display at the side of the data area changes to "CRV FIT @" and "MKR FIT."

Curve Fit Target Trace

Soft Key Display

- G=CRV FIT A Curve-fits trace A.
- G=CRV FIT B Curve-fits trace B.
- G=CRV FIT C Curve-fits trace C.
- G=MKR FIT Make the curve-fit data form markers which are set currently.
 MKR FIT is independent on the trace.

Example of a curve-fitted waveform (data range: OUTSIDE L1-L2)

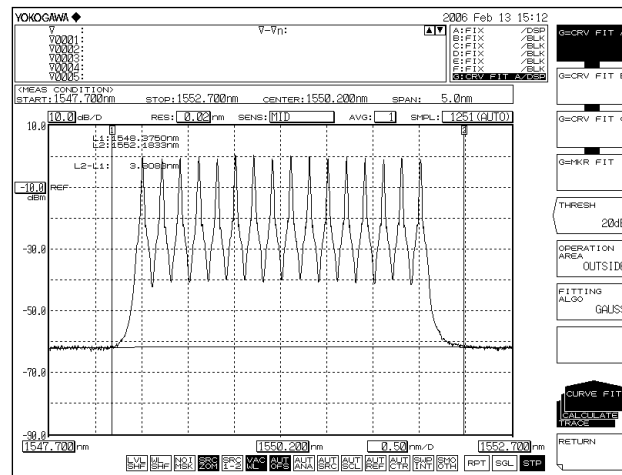

Example of a marker-fitted waveform (data range: ALL)

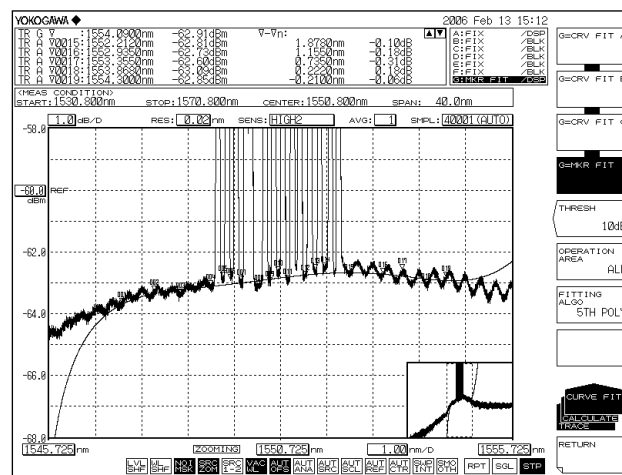

Peak Curve Fit Target Range

Peak-curve-fits the specified trace waveform and writes the results to trace G.
Calculations are applied to mode peaks at the threshold value or more. The threshold value is set in the range of 0 to 99 dB (steps of 1).
The trace display at the side of the data area changes to "PKCVFIT @".

Peak Curve Fit Target Trace

Soft Key Display

G= PKCVFIT A	Peak-curve-fits trace A.
G= PKCVFIT B	Peak-curve-fits trace B.
G= PKCVFIT C	Peak-curve-fits trace C.

5.7 Curve Fitting

Range of Target Data for Calculation

Vertical axis Data from threshold value to peak.
The threshold value is set in the range of 0 to 99 dB (steps of 1).
Horizontal axis Soft key display.

ALL Targets all trace data for calculation.
INSIDE L1-L2 Targets the data of between line markers for calculation.
OUTSIDE L1-L2 Targets the data outside line markers for calculation.

OPERATION AREA when set to INSIDE L1-L2

■: OPERATION AREA

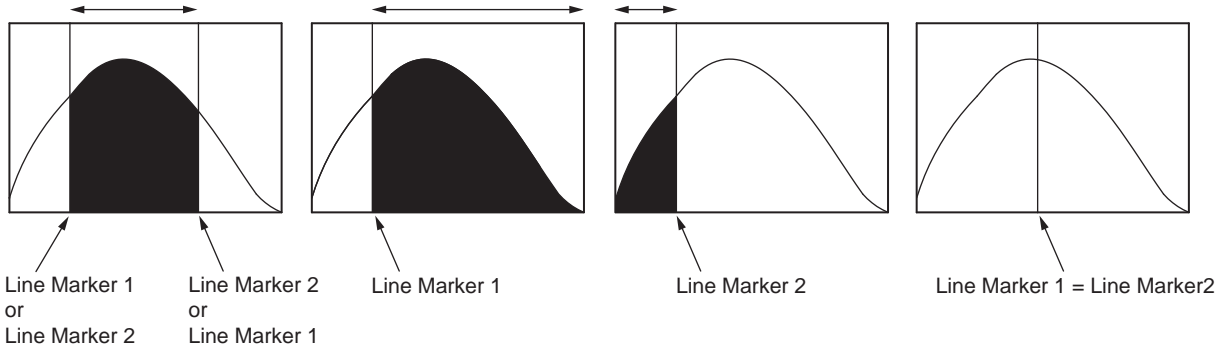

OPERATION AREA when set to OUTSIDE L1-L2

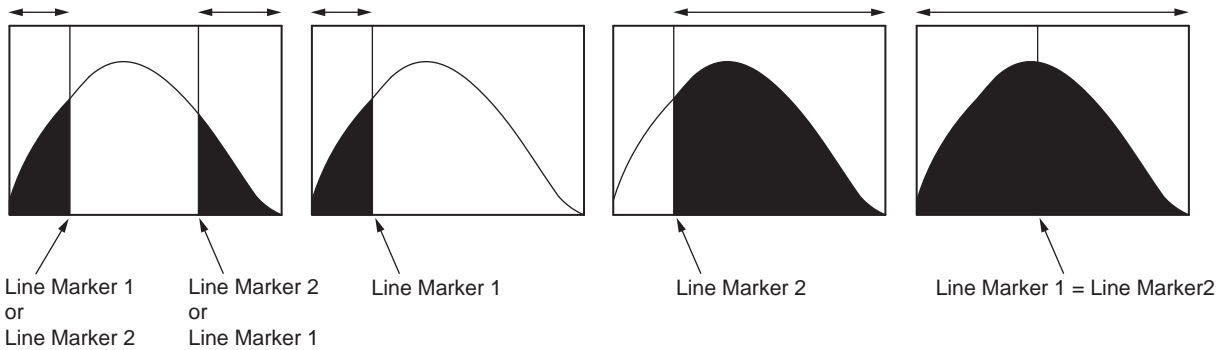

Curve Fitting Algorithm

Soft Key Display	Description
GAUSS	Normal distribution curve
LORENZ	Lorenz curve
3RDPOLY	3rd poly
4THPOLY	4th poly
5THPOLY	5th poly

Note

If G=MKR FIT is selected, fitting cannot be performed if only a small number of markers are placed. A warning displays in these cases: WARNING 111: <G=MKR FIT>failed

GAUSS, LORENZ: Fewer than 3 markers

3RD POLY: Fewer than 4 markers

4TH POLY: Fewer than 5 markers

5TH POLY: Fewer than 6 markers

5.8 Power Density Trace

Procedure

1. Press **TRACE**. The soft key menu for trace settings appears.
2. Press the **ACTIVE TRACE** soft key. Traces A through G appear in soft keys.
3. Press the Trace F soft key. The Trace F setting menu is displayed.
4. Press the **VIEW F DISP/BLANK** soft key and select **DISP**. Each time you press the soft key, it toggles between **DISP** and **BLANK**.
5. Press the **CALCULATE F** soft key.
6. Press the **POWER/NBW** soft key.
7. To display the power density of each trace, press the corresponding key as shown below.

Power density of trace A → $F=PWR/NBW A$

Power density of trace B → $F=PWR/NBW B$

Power density of trace C → $F=PWR/NBW C$

Power density of trace D → $F=PWR/NBW D$

Power density of trace E → $F=PWR/NBW E$

8. Press the **BANDWIDTH** soft key. The bandwidth setting menu appears.
9. Enter the value using the rotary knob, arrow keys, or numeric keypad.
10. Press **ENTER**.

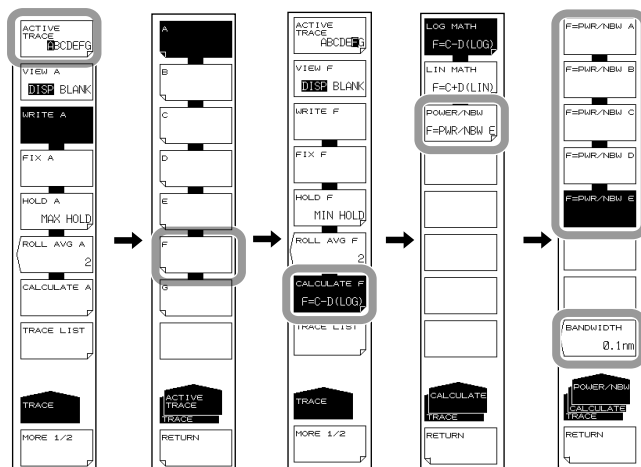

Explanation

In setting the unit (LEVEL UNIT) of the vertical axis in section 5.2, “Horizontal/Vertical Axis Settings,” the power per nanometer can be displayed, but here the power per the specified band in the range of 0.1 nm to 10 nm in 0.1 nm resolution can be displayed. With the analysis function using the ANALYSIS key, only PMD can be analyzed.

Level Axis Unit (Section 4.2)

Level axis units, namely dBm/nm and mW/nm, are units for displaying power per nanometer. If trace F is set to POWER/NBW, the unit is automatically changed to dBm or mW.

If trace F is set to POWER/NBW and you change the level axis to dBm/nm or mW/nm, trace F enters FIX mode, and the waveform is no longer updated.

5.9 Marker Display

Procedure

Displaying Moving Markers

1. Press the **MARKER**. The soft key menu for marker settings appears.
2. Press the **MARKER ACTIVE OFF/ON** soft key.

Note

- If the active trace is not set to DISP, the moving marker cannot be used. Set the trace VIEW @ DISP/BLANK soft key setting to DISP.
- Even if you press **PEAK SEARCH** the moving marker is displayed.

Moving the Moving Markers

3. Enter a wavelength using the numeric key pad, then press **nm/ENTER**.
4. Or, refer to the following and move the moving marker.

Direction	Moving Procedure
Move to right	Turn the rotary knob to the right. Press the UP arrow key.
Move to left	Turn the rotary knob to the left. Press the DOWN arrow key.

Placing Fixed Markers

3. With the moving marker displayed, press the **SET MARKER** soft key. The **SET** soft key and marker number screen are displayed.
4. Press the **SET** soft key. The fixed marker is placed in the position of the current moving marker. Fixed markers are automatically assigned numbers in order starting from 001.

Fixed markers of any number can be positioned. The value is entered in the DATA ENTRY section.

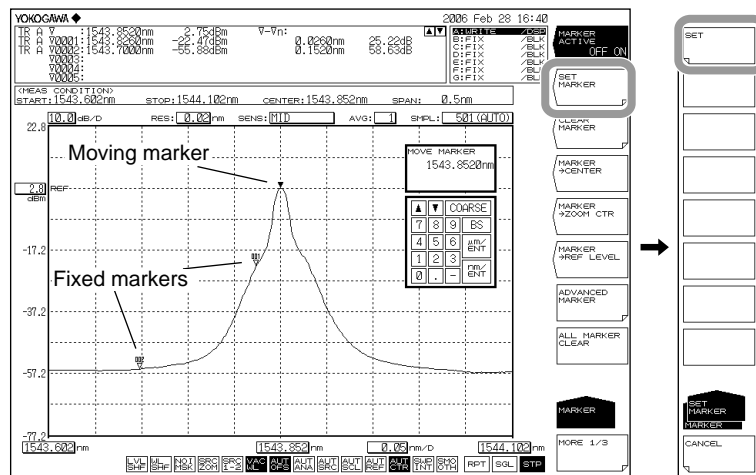

Clearing Fixed Markers

3. Press the **CLEAR MARKER** soft key.
4. The number of the fixed marker to be cleared is entered in the DATA ENTRY section.
5. Press the **CLEAR** soft key.

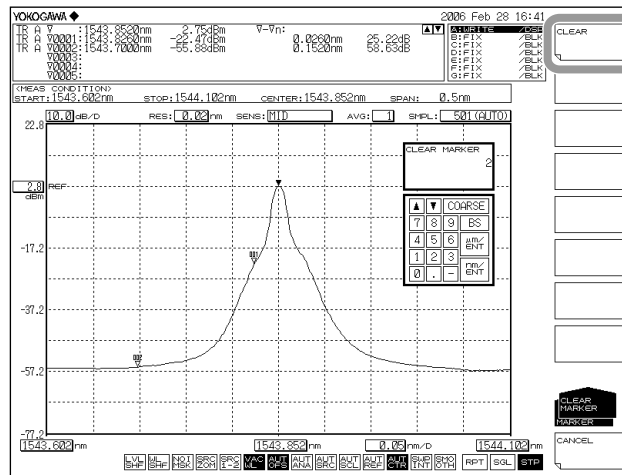

Clearing All Markers

3. Press the **ALL MARKER CLEAR** soft key. All markers (moving markers and fixed markers) displayed on the screen are cleared. In addition, the **MARKER ACTIVE** soft key turns OFF.

Using Moving Markers to Set the Center to Be Measured, the Zoom Center, and the Reference Level

Setting the Moving Marker Wavelength (Frequency / Wavenumber) as the Measurement Center Wavelength (Frequency / Wavenumber)

With the moving marker displayed, press the **MARKER-> CENTER** soft key. The measured center wavelength (frequency / wavenumber) setting screen and setting value are displayed. For information on the center wavelength (frequency / wavenumber), see section 4.5, "Center Wavelength (Frequency / Wavenumber) Setting."

The measurement center wavelength can be set by continuing in the DATA ENTRY section.

Note

The MARKER->CENTER soft key cannot be used under the following conditions.

- When the moving marker is OFF.
- When both SPLIT screens are on HOLD.
- When the measurement data SPAN is 0 nm.

Setting the Moving Marker Wavelength (Frequency / Wavenumber) as the Zoom Center Wavelength (Frequency / Wavenumber)

With the moving marker displayed, press the **MARKER-> ZOOM CTR** soft key. The zoom center wavelength (frequency / wavenumber) setting screen and setting value are displayed. For information on the zoom center wavelength (frequency / wavenumber), see section 5.1, "Zooming In/Out on a Wavelength."

The zoom center wavelength can be set by continuing from the DATA ENTRY section.

Note

The MARKER->ZOOM CTR soft key cannot be used under the following conditions.

- When the moving marker is OFF.
- When both SPLIT screens are on HOLD.
- When the measurement data SPAN is 0 nm.

Setting the Moving Marker Level to the Reference Level

With the moving marker displayed, press the **MARKER-> REF LEVEL** soft key. The reference level setting screen and setting value are displayed. For information on the reference level, see section 4.5, "Reference Level Setting." You can also rewrite the currently displayed waveform according to the modified reference level.

The reference level setting can be set by continuing in the DATA ENTRY section.

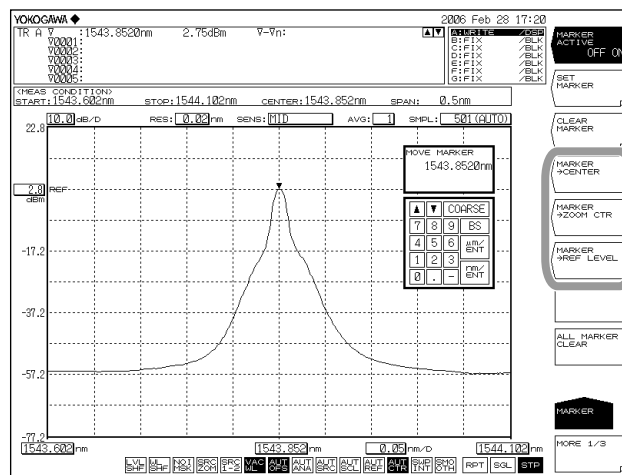

Setting Marker Difference Value Display

You can set the difference display for markers displayed in the data area to OFFSET or SPACING.

1. Press **MARKER**.
2. Press the **MORE** soft key twice. The **MORE 3/3** key menu is displayed.
3. Press the **MARKER DISPLAY** soft key. The difference value display selection menu is displayed.
4. Press the **OFFSET** or **SPACING** soft key.

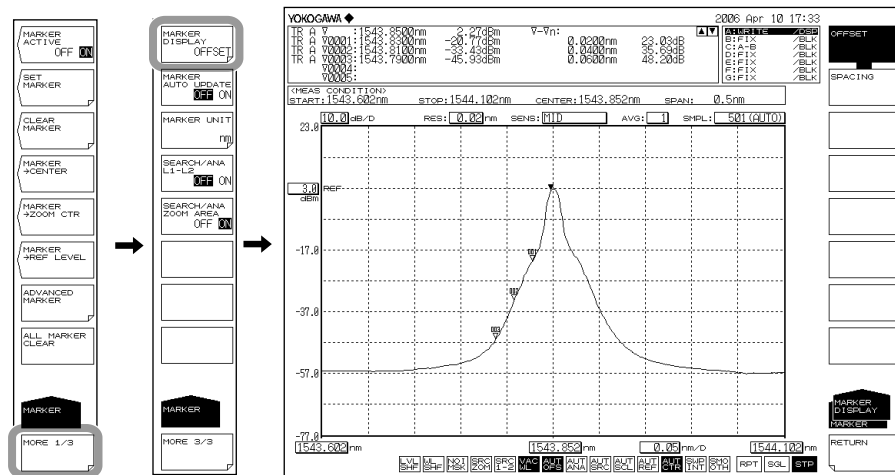

Note

When set to OFFSET, the difference between the moving marker and each fixed marker is displayed. When set to SPACING, the difference between the moving marker and the smallest-numbered fixed marker is displayed along with the difference from each of the fixed markers.

Automatically Updating the Level Value of the Fixed Markers

The fixed marker's level value is updated to track the waveform each time the displayed waveform is updated.

1. Press **MARKER**.
2. Press the **MORE** soft key twice. The **MORE 3/3** key menu is displayed.
3. Press the **MARKER AUTO UPDATE OFF ON** soft key to select ON.

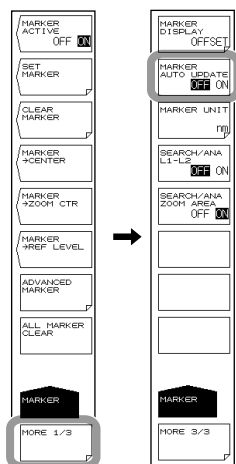

Setting the unit for the Marker Value

1. Press **MARKER**.
2. Press the **MORE** soft key twice. The **MORE 3/3** key menu is displayed.
3. Press the **MARKER UNIT** soft key. The marker unit selection menu is displayed.
4. Press the **nm (THz / cm⁻¹)** soft key.

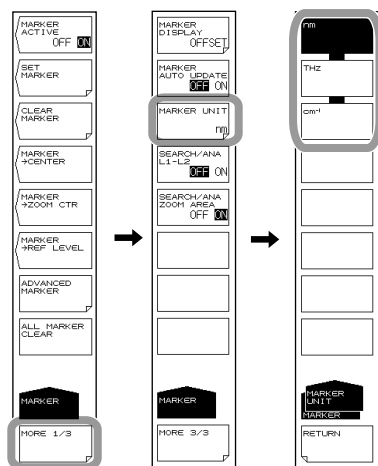

Note

The display unit for the marker value (wavelength or frequency) can be set independently of the waveform display's horizontal axis units (wavelength or frequency) that were specified using the HORIZON SCALE nm/THz soft key.

Displaying Wavelength Line Markers

Here, the horizontal axis is explained in terms of wavelength.

If the unit of the horizontal axis is frequency or wavenumber, substitute wavelength with either frequency or wavenumber, respectively.

1. Press the **MARKER**. The soft key menu for marker settings appears.
2. Press the **MORE 1/3** soft key.
3. Press the **LINE MARKER 1 OFF/ON** or **LINE MARKER 2 OFF/ON** soft key to turn the function ON. Line marker values are displayed in the upper left of the waveform area.

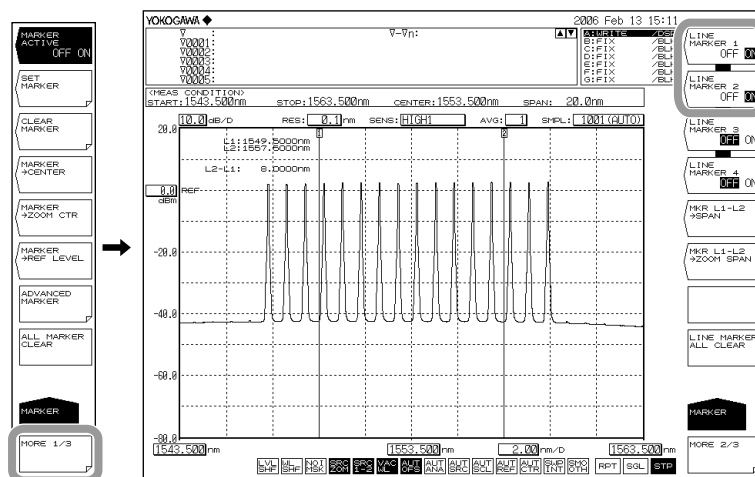

Note

- Wavelength line markers cannot be displayed if the active trace measurement span is 0.000 nm.
- When both wavelength line markers 1 and 2 are displayed, the wavelength difference (L2-L1) is shown below the marker values.

Moving Wavelength Line Markers

4. Refer to the following and move the line marker.

Direction	Moving Procedure
Move to right	Turn the rotary knob to the right. Press the UP arrow key.
Move to left	Turn the rotary knob to the left. Press the DOWN arrow key.

Clearing Wavelength Line Markers

1. Press the **MARKER**. The soft key menu for marker settings appears.
2. Press the **MORE 1/3** soft key.
3. Press the **LINE MARKER 1 OFF/ON** or **LINE MARKER 2 OFF/ON** soft key to turn the function OFF.

Setting Measurement Sweep Width & Display Sweep Width with Line Markers

Setting the Measurement Sweep Width between Line Markers 1 and 2

<<See section 5.6 for details>>

With line marker 1 and 2 displayed, press the **MRK L1-L2 ->SPAN** soft key. The sweep width setting screen and setting value are displayed. The measurement sweep width, measurement start wavelength, and measurement stop wavelength are changed. The measurement sweep width can be set by continuing in the DATA ENTRY section. The available setting range is 0.5 to 1200 nm (in 1 nm steps).

Setting the Area from Line Marker 1 to Line Marker 2 as the Display Scale ZOOM SPAN

With line marker 1 and 2 displayed, press the **MRK L1-L2 ->ZOOM SPAN** soft key. The display sweep width setting screen and setting value are displayed. You can also rewrite the currently displayed waveform according to the specified ZOOM SPAN. See section 5.1.

Note

- If only one of the line markers is displayed, for L1, the wavelength on the right edge of the screen is set to the measurement stop wavelength. For L2, the wavelength on the left edge of the screen is set to the measurement start wavelength.
- The MKR L1-L2 ->ZOOM SPAN soft key cannot be used under the following conditions.
 - When both L1 and L2 are OFF.
 - When both SPLIT screens are on HOLD.
 - When the span of the active trace is 0 nm.

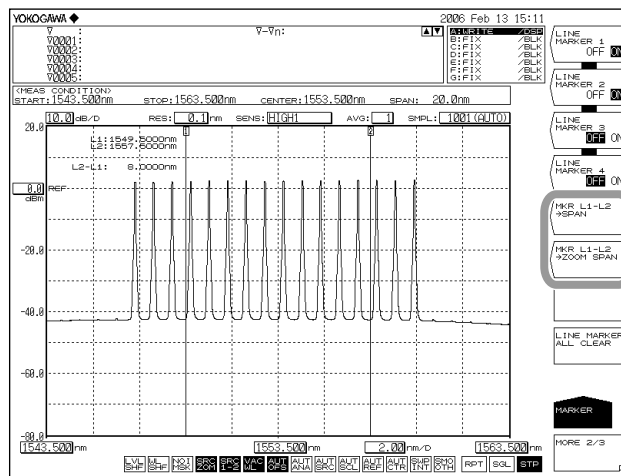

Note

For information on analysis inside the line markers, see section 6.13, "Specifying an Analysis Range."

Displaying Level Line Markers

1. Press the **MARKER** switch. The soft key menu for marker settings appears.
2. Press the **MORE 1/3** soft key.
3. Press the **LINE MARKER 3 OFF/ON** or **LINE MARKER 4 OFF/ON** soft key to turn the function ON. Line marker values are displayed in the upper left of the waveform area.

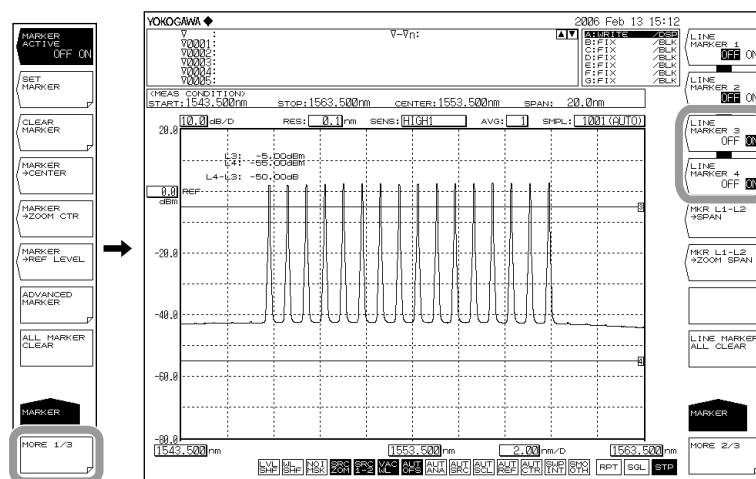

Note

When level line markers 3 and 4 are displayed, the level difference (L4-L3) is shown below the marker values.

Moving Level Line Markers

4. Refer to the following and move the level line marker.

Direction	Moving Procedure
Move upward	Turn the rotary knob to the right. Press the UP arrow key.
Move downward	Turn the rotary knob to the left. Press the DOWN arrow key.

Clearing Level Line Markers

1. Press the **MARKER** switch. The soft key menu for marker settings appears.
2. Press the **MORE 1/3** soft key.
3. Press the **LINE MARKER 3 OFF/ON** or **LINE MARKER 4 OFF/ON** soft key to turn the function OFF. Line marker values are displayed in the upper left of the waveform area.

Clearing All Cursors

Press the **LINE MARKER ALL CLEAR** soft key. All markers (wavelength line markers and level line markers) displayed on the screen are cleared.

Displaying Advanced Markers

1. Press **MARKER**. A soft key menu for marker settings appears.
2. Press the **ADVANCE MARKER** soft key.
A soft key menu for advanced marker settings appears.
3. Press the **ADV MARKER ACTIVE OFF/ON** soft key to turn the function ON.
4. Press a soft key from **MARKER 1 SELECT to MARKER 4 SELECT**.
A soft key menu for setting the advanced marker type and marker target trace appears.
5. Press the **MARKER TRACE** soft key. A soft key menu for selecting the marker target trace appears.
6. Press a soft key from **TRACE A to TRACE G**. The marker can now be displayed on the selected waveform.

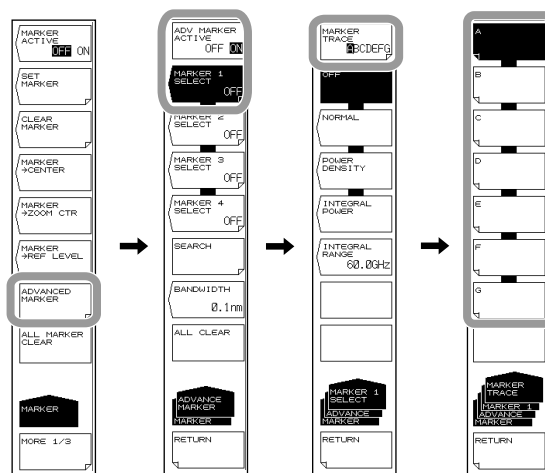

Note

- If the active trace is not set to DISP, you cannot use the advanced markers.
Set VIEW@DISP/BLANK under TRACE to DISP.
- If you press the ADV MARKER ACTIVE OFF/ON soft key to turn it on, the moving markers (MARKER ACTIVE OFF/ON) described on page 5-26 will automatically turn off.
Likewise, if you turn on the moving markers (MARKER ACTIVE OFF/ON) described on page 5-26, the ADV MARKER ACTIVE OFF/ON soft key changes to OFF.
- If the horizontal scale unit is set to wavenumber, you cannot use the advanced markers.

Displaying a Moving Marker

- Press the **NORMAL** soft key. A moving marker appears on the waveform.

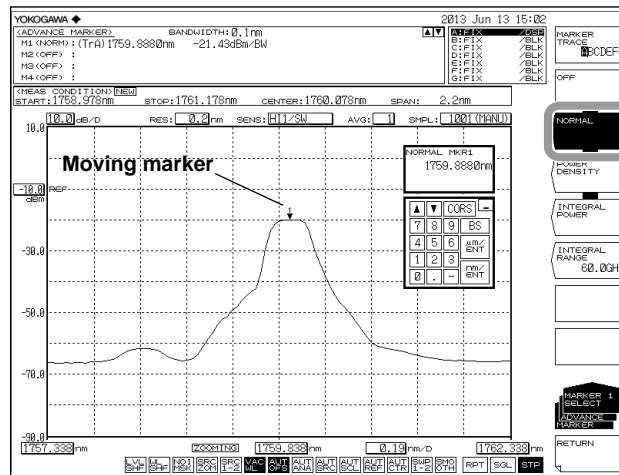

Displaying a Power Spectral Density Marker

- Press the **POWER DENSITY** soft key. A power density marker appears on the waveform.
- Press the **RETURN** soft key. The menu returns to the previous level.
- Press the **BANDWIDTH** soft key. The normalization bandwidth setting menu appears.
- Enter the normalization bandwidth value using the rotary knob, arrow keys, or numeric keypad.
- Press **ENTER**.

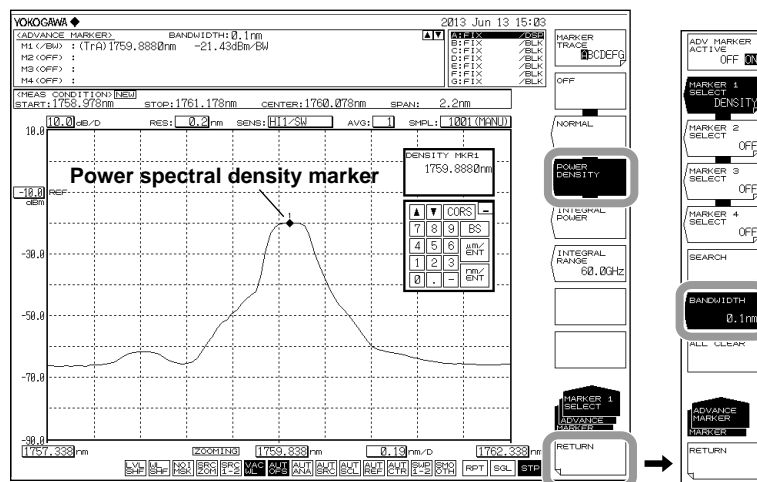

Note

A power spectral density marker cannot be assigned to a differential waveform (based on LOG values) or normalized waveform.

Displaying an Integrated Power Marker

7. Press the **INTEGRAL POWER** soft key. A integrated power marker appears on the waveform.
8. Press the **INTEGRAL RANGE** soft key. The integration frequency range setting menu appears.
9. Enter the frequency range value using the rotary knob, arrow keys, or numeric keypad.
10. Press **ENTER**.

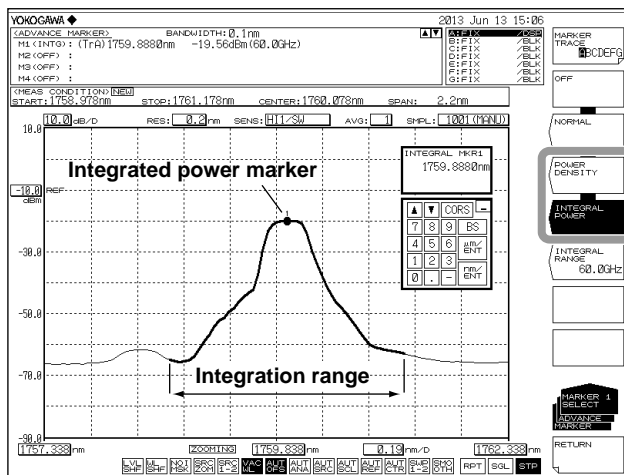

Note

An integrated power marker cannot be assigned to a differential waveform (based on LOG values) or normalized waveform.

Moving an Advanced Marker

Enter the wavelength using the numeric keypad, and then press **nm/ENTER**. Or, move the moving marker by referring to the information below.

Movement direction	Movement method
Move to the right	Turn the rotary knob to the right. Press the UP arrow key.
Move to the left	Turn the rotary knob to the left. Press the DOWN arrow key.

Performing a Single Search Using an Advanced Marker

1. Press **MARKER**. A soft key menu for marker settings appears.
2. Press the **ADVANCE MARKER** soft key.
A soft key menu for advanced marker settings appears.
3. Press the **SEARCH** soft key. The soft key menu for searching appears.

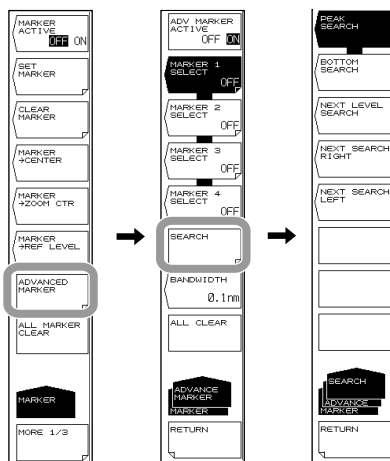

Note

If the advanced marker is turned off, the SEARCH soft key will be unavailable.

Finding the Peak Wavelength/Level

4. Press the **PEAK SEARCH** soft key. An advanced marker is set to the peak (maximum value) of the waveform, and the marker values are displayed in the data area.

Finding the Bottom Wavelength/Level

4. Continuing from step 3, press the **BOTTOM SEARCH** soft key. An advanced marker is set to the bottom (minimum value) of the waveform, and the marker value is displayed in the data area.

Finding the Next Peak/Bottom Level

5. When the advanced marker is displayed at the peak or bottom of the waveform, press the **NEXT LEVEL SEARCH** soft key. On the marker trace waveform, the moving marker at the peak or bottom is set to the next peak (local maximum value) or bottom (local minimum value).

Finding the Level Peak/Bottom to the Right of the Advanced Marker

5. When the advanced marker is displayed at the peak or bottom of the waveform, press the **NEXT SEARCH RIGHT** soft key. The advanced marker is set to the next peak (local maximum value) or bottom (local minimum value) on the right.

Finding the Level Peak/Bottom to the Left of the Advanced Marker

5. When the advanced marker is displayed at the peak or bottom of the waveform, press the **NEXT SEARCH LEFT** soft key. The advanced marker is set to the next peak (local maximum value) or bottom (local minimum value) on the left.

Turning Off the Advanced Marker Display

Press the **OFF** soft key.

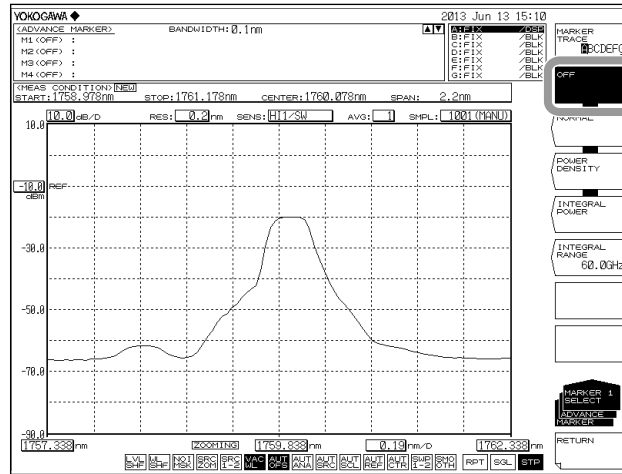

Note

The advanced marker display automatically turns off if you perform any of the following operations.

- Execute auto measurement (section 4.1)
- Clear all traces (section 4.11)
- Change the vertical axis settings (section 4.2) and execute a measurement (section 4.13)
- Change the number of samples (section 4.8) and execute a measurement (section 4.13)

Clearing All Advanced Markers

1. Press **MARKER**. A soft key menu for marker settings appears.
2. Press the **ADVANCE MARKER** soft key.
A soft key menu for advanced marker settings appears.
3. Press the **ALL CLEAR** soft key. All displayed advanced markers (moving markers, power density markers, and integrated power markers) are cleared.

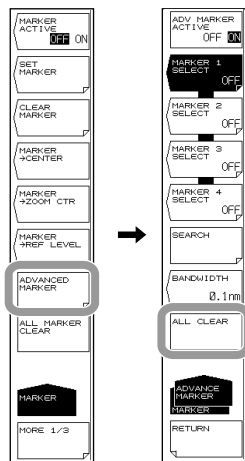

Explanation

Here, the horizontal axis is explained in terms of wavelength.

If the unit of the horizontal axis is frequency or wavenumber, substitute wavelength with either frequency or wavenumber, respectively.

Markers

Moving Markers

Line markers can be moved to an arbitrary wavelength using the rotary knob, arrow keys, or numeric key pad. You can also drag the markers with the mouse.

Moving markers can be moved over a waveform to display the marker value in the data area. If a moving marker is fixed in an arbitrary position, a fixed marker is displayed.

Fixed Markers

Fixed markers are markers fixed to number to which a moving marker was specified. A maximum of 1024 fixed markers can be set. In addition, fixed markers can be set across different traces.

Fixed markers are assigned marker numbers in order starting from 001. You can enter an arbitrary number using the rotary knob, arrow keys, or numeric key pad. A number up to 1024 can be set.

Marker Data in the Data Area

Marker values (wavelength values and level values) for the displayed moving and fixed markers are shown in the data area.

If there are five or more fixed markers, they cannot all be displayed in the data area. To view the values of markers that are not displayed, scroll through the display using the arrow keys. You can scroll when moving markers are ON and active.

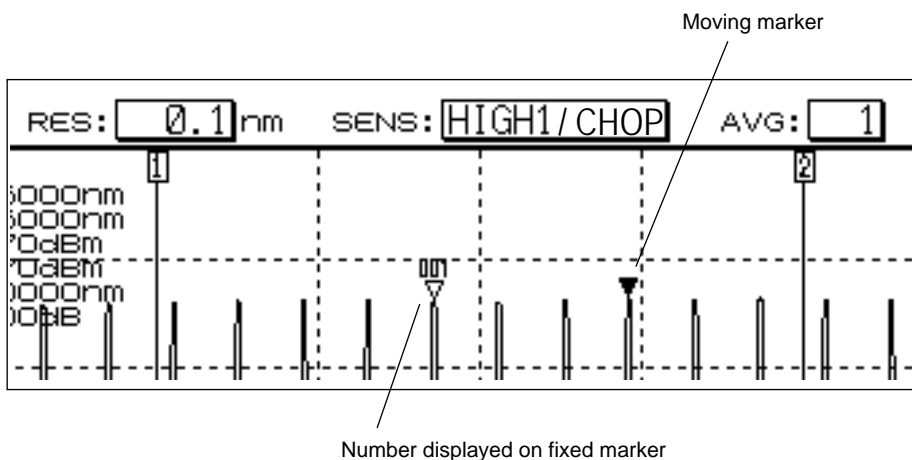
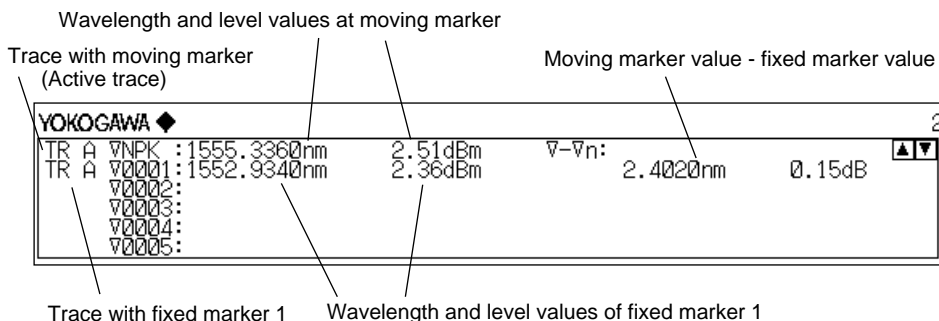

MARKER DISPLAY

This key is used to set whether to display the difference relative to the moving marker (OFFSET) or the difference relative to the next marker (SPACING) in the marker display (Fig. 6-10 "Data area when MARKER DISPLAY is set to OFFSET" and Fig. 6-11 "Data area when MARKER DISPLAY is set to SPACING"). (Default: OFFSET)

If the active trace span is 0 nm, the wavelength difference relative to the moving marker is 0.000 nm.

If a fixed marker is placed at the -210 dBm wavelength value, "???????" is displayed as the level difference from that fixed marker.

When a fixed marker is positioned and the moving marker is set to a wavelength value of -210 dBm, the level difference is set to -210.00 dB, regardless of the fixed marker's level.

OFFSET

Sets the difference value display as the difference between each marker and the moving marker (OFFSET).

TR A	▽	:1543.8500nm	2.27dBm	▽-▽n:		
TR A	▽0001:	1543.8300nm	-20.77dBm		0.0200nm	23.03dB
TR A	▽0002:	1543.8100nm	-33.43dBm		0.0400nm	35.69dB
TR A	▽0003:	1543.7900nm	-45.93dBm		0.0600nm	48.20dB
	▽0004:					
	▽0005:					

Data area when MARKER DISPLAY is set to OFFSET

SPACING

Sets the difference value display as the difference between each marker and the next marker.

TR A	▽	:1543.8500nm	2.27dBm	SPACING:		
TR A	▽0001:	1543.8300nm	-20.77dBm		-0.0200nm	-23.03dB
TR A	▽0002:	1543.8100nm	-33.43dBm		-0.0200nm	-12.66dB
TR A	▽0003:	1543.7900nm	-45.93dBm		-0.0200nm	-12.50dB
	▽0004:					
	▽0005:					

Data area when MARKER DISPLAY is set to SPACING

Line Markers

Wavelength Line Markers

When line markers are displayed, the marker values are shown in the upper left part of the waveform area.

When both wavelength line markers 1 and 2 are displayed, the wavelength difference (L2-L1) is shown below the marker values.

Level Line Markers

When line markers are displayed, the marker values are shown in the upper left part of the waveform area. When level line markers 3 and 4 are displayed, the level difference (L4-L3) is shown below the marker values.

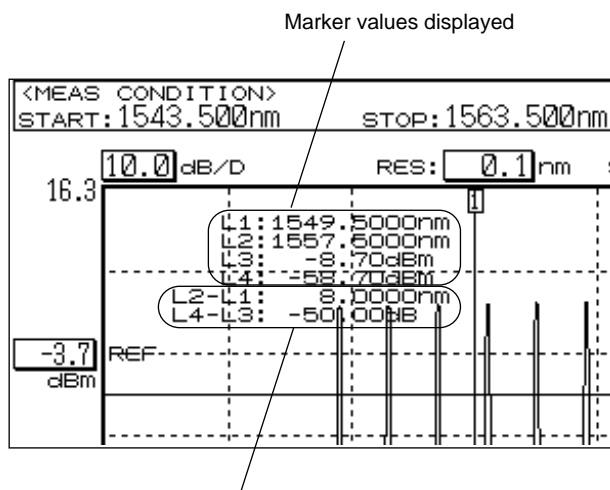

Wavelength (L2 - L1) and level (L4 - L3) difference displayed

Note

You can move line markers by dragging them. As you drag, the line markers in the overview window move accordingly.

Line Markers in the Overview Window

The instrument's OVERVIEW window is displayed when the display scale is enlarged or reduced. When line markers are displayed, they are also displayed on the OVERVIEW window. When a line marker is moved on the OVERVIEW window, it also moves in the waveform area. When moving a line marker, the mouse pointer changes to a hand tool.

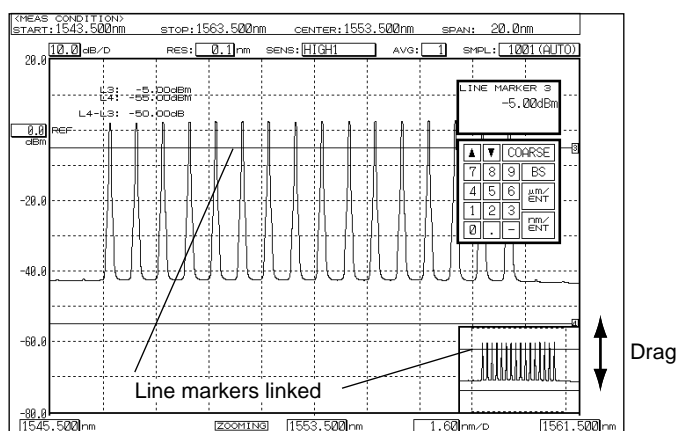

Advanced Markers

Moving Markers

Moving markers can be moved to an arbitrary wavelength using the rotary knob, arrow keys, or numeric keypad.

You can also drag the markers with the mouse.

Moving markers move along the waveform and show marker values (wavelength and level) in the data area.

If two markers are displayed, the wavelength difference and level difference between the markers are displayed.

When marker 1 (M1) and marker 2 (M2) are displayed: marker 2 – marker 1 (M2-1)

When marker 3 (M3) and marker 4 (M4) are displayed: marker 4 – marker 3 (M4-3)

The fixed marker function is not available.

Marker number

Advanced marker type: NORM (moving marker)
 Trace that the marker is assigned to: TrA (trace A)
 Wavelength and level of the moving marker
 Wavelength difference and level difference between the moving markers

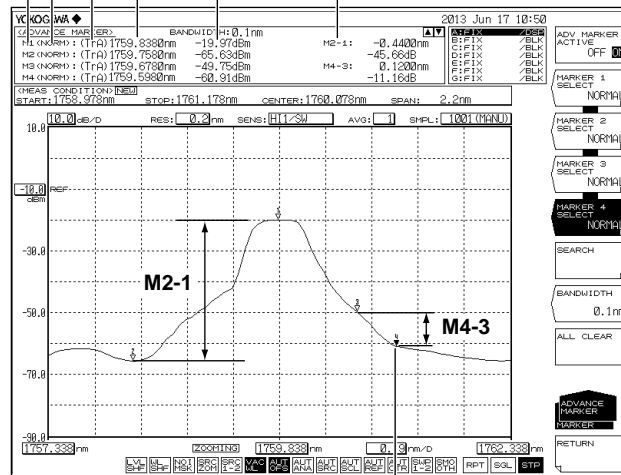

Moving markers

A number is displayed with the moving marker.
 When active, the marker is solidly filled.

Power Density Markers

Power density markers show power values per normalization bandwidth by assuming the marker position on the waveform to be the center. The power values are displayed in the data area. They are used to determine converted power values per given bandwidth such as when measuring the signal noise level.

The selectable normalization bandwidth range is 0.1 to 10.0 nm. If you press the COARSE key, you can set the value in 1 nm steps using the rotary knob or arrow keys. If you do not press the COARSE key, you can set the value in 0.1 nm steps.

The way to move the markers and the data display between markers are the same as with the above-mentioned moving markers.

Advanced marker type: /BW (power density marker)
 Normalization bandwidth
 Power density marker power values

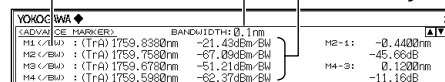

Integrated Power Markers

Integrated power markers show integrated power values over specified frequency ranges by assuming the marker position on the waveform to be the center. The power values are displayed in the data area. These markers are used to determine the integrated power of a widely spread spectrum such as to determine the signal level from a modulated optical signal spectrum. The selectable range of frequency to integrate over is ± 1.0 to ± 999.9 GHz. If you press the COARSE key, you can set the value in 10 GHz steps using the rotary knob or arrow keys. If you do not press the COARSE key, you can set the value in 1 GHz steps.

To determine the signal level of a modulated optical signal, set the integration frequency range so that the point approximately -30 dB below the spectrum peak is included. The waveform in the integration range appears highlighted (in blue).

The way to move the markers and the data display between markers are the same as with the above-mentioned moving markers.

Advanced marker type: INTG (integrated power)

Integrated power marker power values

YOKOGAWA		BANDWIDTH: 0.1 nm		[ADV] [SE] [MARKER]	
M1 (INTG): (TR)	1759.8390nm	-19.56dBm (50.00GHz)	M2-1:	0.4400nm	[ALT]
M2 (INTG): (TR)	1759.7580nm	-20.46dBm (60.00GHz)	M3-1:	0.890B	
M3 (INTG): (TR)	1759.6780nm	-45.67dBm (10.00GHz)	M4-3:	0.1200nm	
M4 (INTG): (TR)	1759.5980nm	-57.47dBm (10.00GHz)	M4-3:	-11.800B	

Note

When advanced markers are in use, the marker levels at the end of measurements are automatically updated.

5.10 Displaying a Split Screen

Procedure

Splitting the Screen

1. Press **DISPLAY**. The soft key menu for setting the screen display appears.
2. Press the **SPLIT DISPLAY** soft key. The screen splits into upper and lower splits.

Displaying a Trace in Either the Upper or Lower Split

3. Press the soft key corresponding to the desired trace. Each time you press the soft key, the display screen toggles between UP and LOW. You can alternately select the upper or lower display for Trace A. For Trace A, the default is Upper. The default for Traces A, B, D, and E is Upper. The default for Trace C, F, and G is Lower.

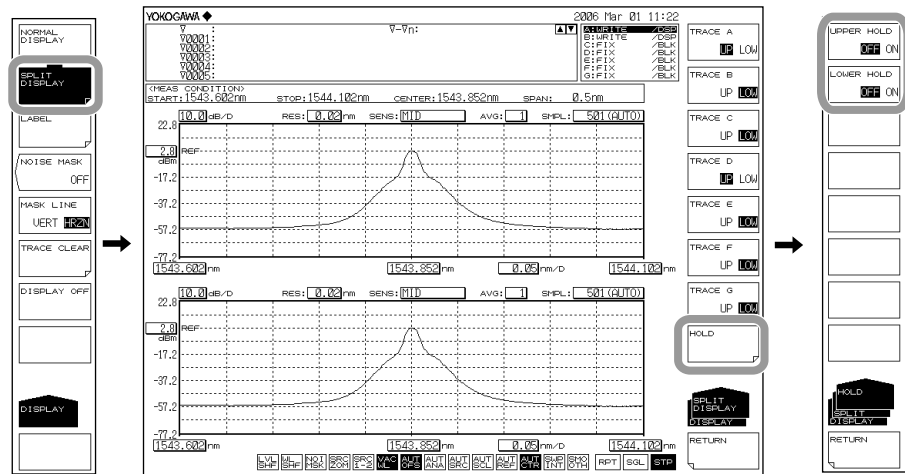

Fixing a Trace

3. Press the **HOLD** soft key.

Fixing/Releasing the Upper Trace

4. Press the **UPPER HOLD OFF/ON** soft key. The trace assigned to the upper split is fixed, along with the scale. To release the trace, press the **UPPER HOLD OFF/ON** soft key again. The display scale and waveform are updated.

Fixing/Releasing the Lower Trace

4. Press the **LOWER HOLD OFF/ON** soft key. The trace assigned to the lower split is fixed, along with the scale. To release the trace, press the **LOWER HOLD OFF/ON** soft key again. The display scale and waveform are updated.

Returning to Normal Display

1. Press **DISPLAY**. The soft key menu for setting the screen display appears.
2. Press the **NORMAL DISPLAY** soft key. The screen returns to normal display (1 screen).

Explanation**HOLD**

The Hold function is used when displaying measured waveforms with the upper and lower portions of the screen having different wavelength ranges.

For example, after measuring trace A in the upper screen, you can hold the upper screen, change measurement conditions, then measure trace B in the lower screen.

HOLD has the characteristics below. These are the same for the upper and lower splits.

- The display scale is fixed.
- The trace is fixed.
- When HOLD is applied to a screen with the active trace (WRITE @), the active trace automatically changes to the FIX state. (FIX @)
- When a screen setting is changed from the HOLD state to NORMAL DISPLAY, the last set display scale is set as the display scale.
- When a trace in the HOLD state (FIX state) is set to a state other than FIX, the HOLD is cleared automatically. When this happens, a warning message is displayed.

5.11 Noise Mask

Procedure

1. Press **DISPLAY**. The soft key menu for setting the screen display appears.
2. Press the **NOISE MASK** soft key. The noise mask value setting screen is displayed.
3. Enter a noise mask value using the rotary knob, arrow keys, or numeric key pad.
4. Press **ENTER**.
5. Press the **MASK LINE VERT/HRZN** soft key and select **VERT** or **HRZN**.

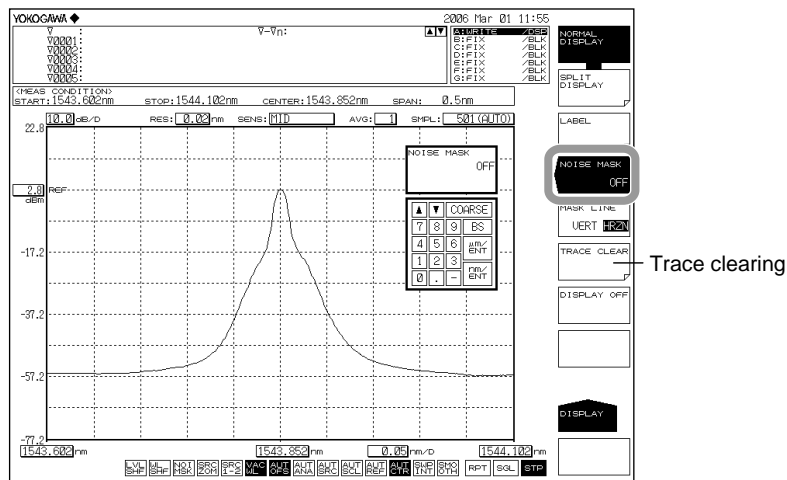

Note

The allowed setting range for the noise mask value is OFF (-999), and -100-0. Settings can be adjusted in steps of 1. The value changes in steps of 10 if you press the COARSE key.

Explanation

Noise Masking

HRZN

Displays the waveform with level values at or below the mask value as the mask value.

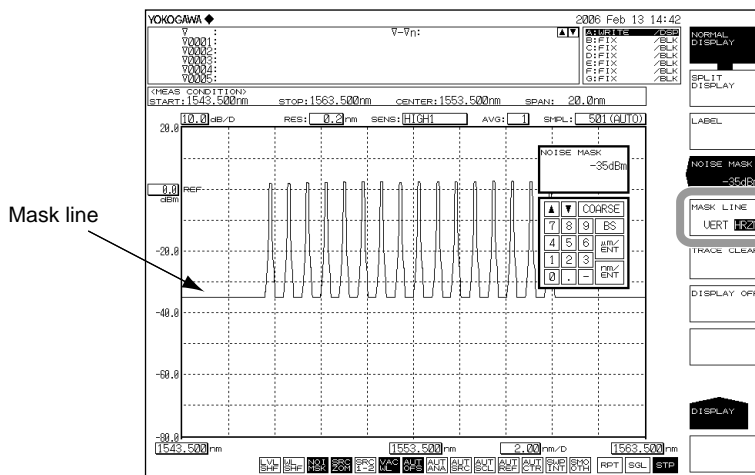

VERT

Displays the waveform with level values at or below the mask value as the display lower limit value (-210 dBm).

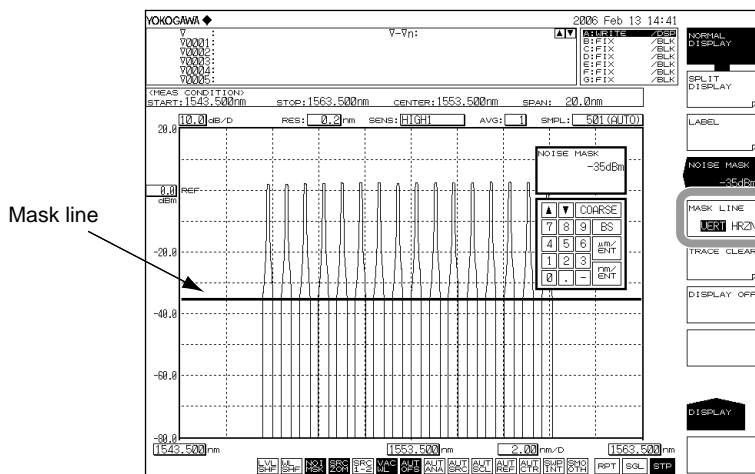

Note

The noise mask function is disabled when the vertical axis is linear.

5.12 Copying and Clearing Traces

Procedure

Copying Traces

1. Press **TRACE**. The soft key menu for trace settings appears.
2. Press the **MORE 1/2** soft key.
3. Press the **TRACE COPY** soft key.
4. Press the **SOURCE TRACE** soft key and select the copy source trace (A to G). The screen returns to the previous state after a selection is made.
5. Press the **DESTINATION TRACE** soft key and select the copy destination trace (A to G). The screen returns to the previous state after a selection is made.
6. Press the **COPY EXECUTE** soft key. The copy executes.

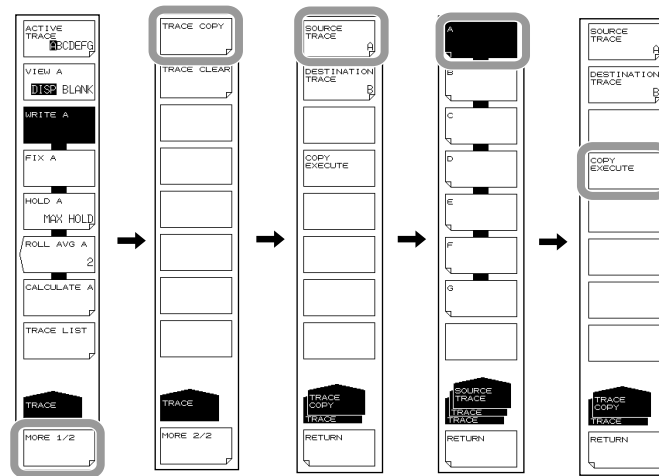

Note

- After the copy is executed, the copy destination trace status changes to FIX and DISP.
- If the copy source and destination trace are the same, the COPY EXECUTE soft key is disabled.

Clearing Traces

1. Press **TRACE**. The soft key menu for trace settings appears.
2. Press the **MORE 1/2** soft key.
3. Press the **TRACE CLEAR** soft key.
4. Press the soft key (A through G) corresponding to the trace of the data you wish to clear.
5. To clear the data from all traces, press the **ALL TRACE** soft key.

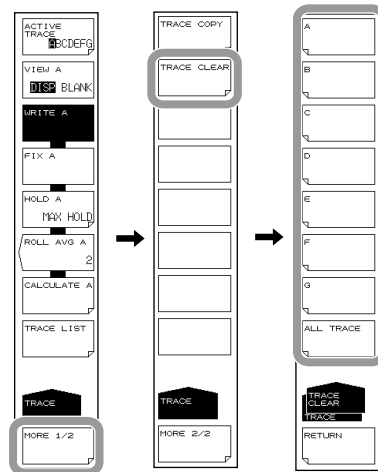

Trace List

1. Press **TRACE**. The soft key menu for trace settings appears.
2. Press the **TRACE LIST** soft key.

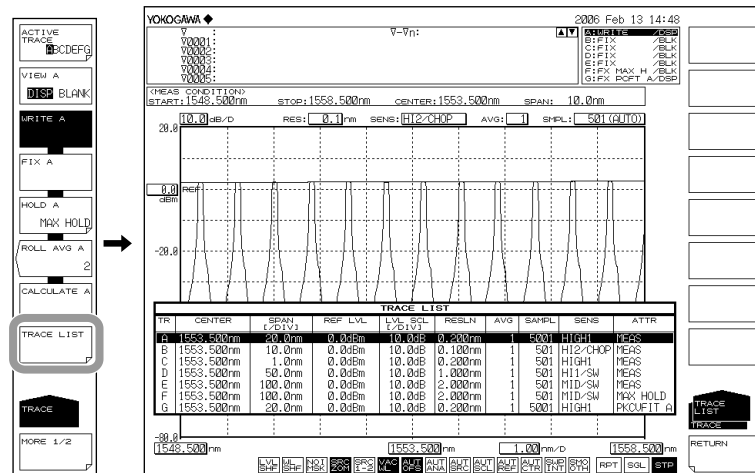

5.13 Single Search

Procedure

Selecting the Single Search

1. Press **PEAK SEARCH**. The menu for detecting peak values is displayed.
2. Press the **MORE 1/2** soft key.
3. Press the **SEARCH MODE** soft key and select **SINGL**.
In the default settings, SINGL (single search) is selected.
4. Press the **MORE 2/2** soft key.

Finding the Peak Wavelength/Level

5. Press the **PEAK SEARCH** soft key. The moving marker is set on the waveform peak (the maximum level value) and the marker value is displayed in the data area.

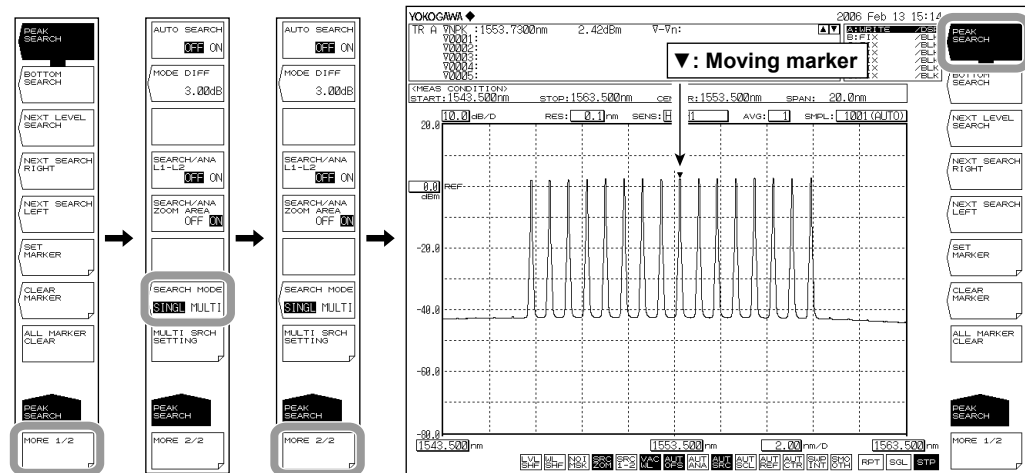

Finding the Bottom Wavelength/Level

5. Continuing on from step 4, press the **BOTTOM SEARCH** soft key. The moving marker is set on the waveform bottom (the minimum level value) and the marker value is displayed in the data area.

Note

- If the active trace is not set to DISP, the moving marker cannot be used. Set the trace **VIEW @ DISP/BLANK** soft key setting to **DISP**.
- Even if you press **PEAK SEARCH** the moving marker is displayed.

Finding the Next Peak/Bottom Level

6. With the moving marker displayed at a waveform peak or bottom, press the **NEXT LEVEL SEARCH** soft key. The moving marker is placed on the next peak (maximum level value) or bottom (minimum level value).

Finding the Level Peak/Bottom to the Right of the Marker

6. With the moving marker displayed at a waveform peak or bottom, press the **NEXT SEARCH RIGHT** soft key. The moving marker is placed on the peak (maximum level value) or bottom (minimum level value) to the right of its current position.

Finding the Level Peak/Bottom to the Left of the Marker

- With the moving marker displayed at a waveform peak or bottom, press the **NEXT SEARCH LEFT** soft key. The moving marker is placed on the peak (maximum level value) or bottom (minimum level value) to the left of its current position.

Setting the Minimum Peak/Bottom Difference of the Mode Judgment Reference

- Press **PEAK SEARCH**. The menu for detecting the peak value is displayed.
- Press the **MORE 1/2** soft key. The 2/2 soft key screen is displayed.
- Press the **MODE DIFF** soft key. The screen for setting the minimum peak/bottom difference of the mode judgment reference is displayed.
- Enter a peak/bottom difference using the rotary knob, arrow keys, or numeric key pad.
- Press **nm/ENTER**.

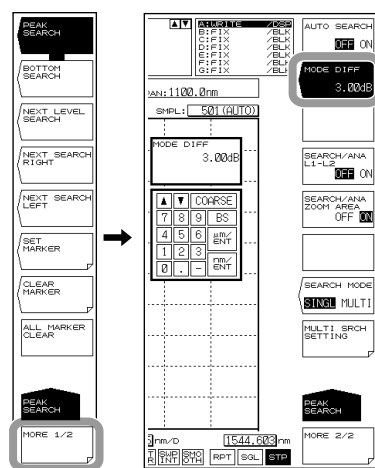

Auto Search

- Press **PEAK SEARCH**. The menu for searching for the peak value is displayed.
- Press the **MORE 1/2** soft key. The 2/2 soft key screen is displayed.
- Press the **AUTO SEARCH** soft key.

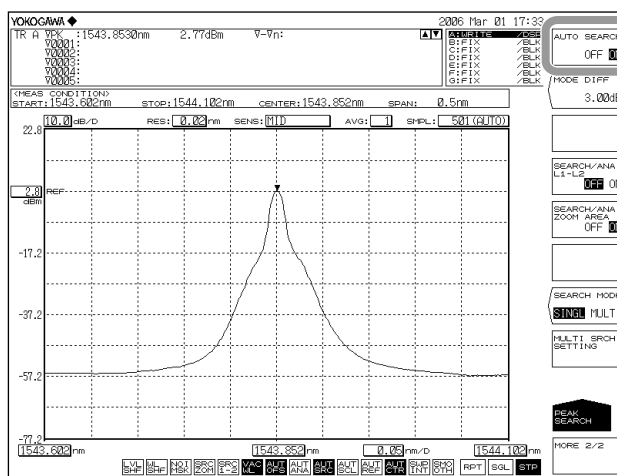

Explanation

The instrument detects the peak (the maximum level value) or bottom (the minimum level value) of the measured waveform.

PEAK SEARCH

Executes a peak search (a search for a maximum level value) on the active trace waveform. A moving marker is placed, and the marker value is displayed in the data area. If the peak level is above the screen top or below the screen bottom, a marker is displayed at the screen top or bottom, but the actual (correct) marker value is displayed in the data area. After measurement the marker can be moved with the rotary knob. Or, if you press an arrow key, you can scroll the data area.

BOTTOM SEARCH

Executes a bottom search (a search for a minimum level value) on the active trace waveform. A moving marker is placed, and the marker value is displayed in the data area. If the bottom level is above the screen top or below the screen bottom, a marker is displayed at the screen top or bottom, but the actual (correct) marker value is displayed in the data area. After measurement the marker can be moved with the rotary knob. Or, if you press an arrow key, you can scroll the data area.

NEXT LEVEL SEARCH

Sets a moving marker at the peak (maximum level value) or bottom (minimum level value) which follows the currently set moving marker value (level value) in the active trace waveform. If there is no such peak or bottom, a warning data is displayed.

WARNING 103 : No data in active trace

NEXT SEARCH RIGHT

Sets a moving marker at the peak (maximum level value) or bottom (minimum level value) to the right of the currently set moving marker value (level value) in the active trace waveform. If there is no such peak or bottom, a warning data is displayed.

WARNING 103 : No data in active trace

NEXT SEARCH LEFT

Sets a moving marker at the peak (maximum level value) or bottom (minimum level value) to the left of the currently set moving marker value (level value) in the active trace waveform. If there is no such peak or bottom, a warning data is displayed.

WARNING 103 : No data in active trace

SET MARKER SET

Sets the moving marker as a fixed marker with the specified number.

A number from 001 to 1024 can be specified. The default is one greater than the highest fixed marker number among the currently set markers, or the number 001 if no markers have been set). If the MARKER ACTIVE soft key turns OFF, the SET MARKER soft key is disabled.

CLEAR MARKER CLEAR

Clears the specified fixed marker number. The marker value in the data area is also cleared. The fixed marker number to be cleared (default value) is the last set fixed marker number.

ALL MARKER CLEAR

This key is used to clear all currently displayed moving markers and fixed markers.

MODE DIFF *.*dB

This key is used to set the minimum peak/bottom difference (dB) serving as a basis for mode determination during mode detection.

When you press this key, the setting screen and current setting value are displayed. The available setting range is 0.01 to 50.00 dB (in 0.01 steps, coarse: steps of 1), and the value is set in the DATA ENTRY section. (Initial value: 3.00 dB.)

SEARCH/ANA L1-L2 OFF/ON

When set to ON and wavelength line markers WL1 and WL2 are set, peak searching, bottom searching (PEAK SEARCH key), and analysis function (ANALYSIS key) calculations are only applied between line markers 1 and 2.

The setting applies to the MARKER and PEAK SEARCH keys, and the SEARCH/ANA L1-L2 ANALYSIS key. If wavelength line markers WL1 and WL2 are not set, the SEARCH/ANA L1-L2 OFF / ON key is disabled. (Initial value: OFF.)

When this key is set to ON,  is displayed at the very bottom of the screen in reverse video.

Note

- If both WL1 and WL2 are set, execution applies over the span between line markers 1 and 2.
- If just WL1 is set, execution applies over the span from line marker 1 to the right edge of the screen.
- If just WL2 is set, execution applies over the span from the left edge of the screen to line marker 2.

SEARCH/ANA ZOOM AREA OFF/ON

When set to ON, peak searching, bottom searching (PEAK SEARCH key), and analysis function (ANALYSIS key) are only applied to data in the ZOOM SPAN range.

The setting applies to the MARKER and PEAK SEARCH keys, and the SEARCH/ANA L1-L2 ANALYSIS key. When this key and the SEARCH/ANA L1-L2 key are set to ON, calculations are applied to data that are both within the ZOOM SPAN range and between line markers 1 and 2. (Initial value: ON.)

When this key is set to ON,  is displayed at the very bottom of the screen in reverse video.

Auto Search

You can automatically detect the peak or bottom value every time a sweep is performed. The following explains the soft keys related to auto searches.

AUTO SEARCH ON/OFF

Turns ON/OFF peak/bottom searching to be performed every sweep.

When set to ON, a peak/bottom search is performed automatically and a moving marker is set automatically after sweeping ends. (Initial value: OFF.)

When this key is set to ON,  is displayed at the very bottom of the screen in reverse video.

5.14 Multi Search

Procedure

Selecting the Multi Search

1. Press **PEAK SEARCH**. The menu for detecting peak values is displayed.
2. Press the **MORE 1/2** soft key.
3. Press the **SEARCH MODE** soft key and select MULTI.

In the default settings, SINGL (single search) is selected.

When you select MULTI, a peak search or a bottom search is executed. Which search is executed depends on which soft key, PEAK SEARCH or BOTTOM SEARCH, has been pressed on the MORE 1/2 menu.

4. Press the **MORE 2/2** soft key.

Finding Multiple Peak Wavelengths/Levels

5. Press the **PEAK SEARCH** soft key. Fixed markers are set on the multiple peaks of the waveform, and the marker values are displayed in the data area. The moving marker is set on the highest peak.

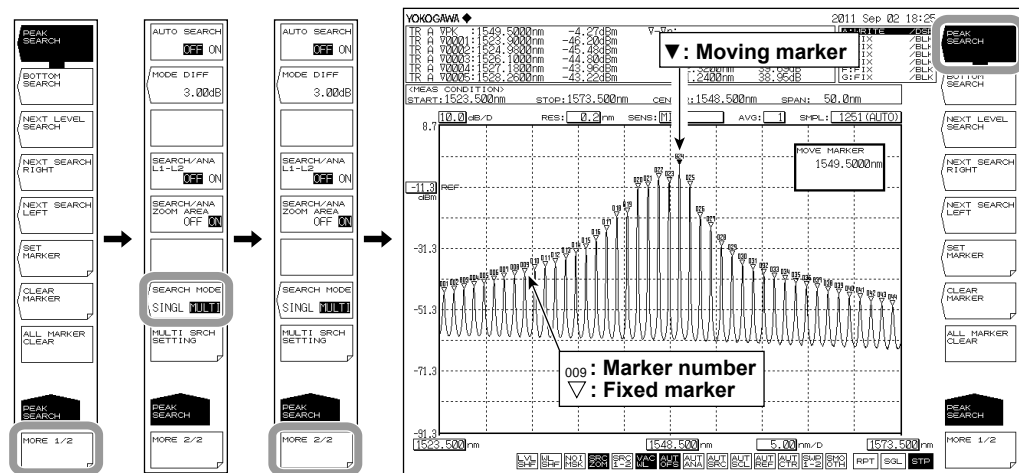

Finding Multiple Bottom Wavelengths/Levels

5. Continuing from step 4, press the **BOTTOM SEARCH** soft key. Fixed markers are set on the multiple bottoms of the waveform, and the marker values are displayed in the data area. The moving marker is set on the lowest bottom.

Note

- If the active trace is not set to DISP, the moving marker cannot be used. Set the trace VIEW @ DISP/BLANK soft key setting to DISP.
- Even if you press PEAK SEARCH the moving marker is displayed.

Finding the Next Peak/Bottom Level

The procedure is the same as the procedure shown for the single search in the previous section.

Finding the Level Peak/Bottom to the Right of the Moving Marker

The procedure is the same as the procedure shown for the single search in the previous section.

Finding the Level Peak/Bottom to the Left of the Moving Marker

The procedure is the same as the procedure shown for the single search in the previous section.

Setting the Mode (Peak/Bottom) Detection Threshold and the Detection List Sort Order

1. Press **PEAK SEARCH**. The menu for detecting peak values is displayed.
2. Press the **MORE 1/2** soft key.
3. Press the **MULTI SRCH SETTING** soft key. The menu for setting the mode (peak/bottom) detection threshold and the marker number assignment order is displayed.

Setting the Mode (Peak/Bottom) Detection Threshold

4. Press the **THRESH** soft key. The screen for setting the threshold appears.
5. Enter the detection threshold using the rotary knob, arrow keys, or numeric keypad.
6. Press **nm/ENTER**.

Setting the Detection List Sort Order

4. Press the **SORT BY** soft key. Each time you press the soft key, the setting toggles between WL and LVL.

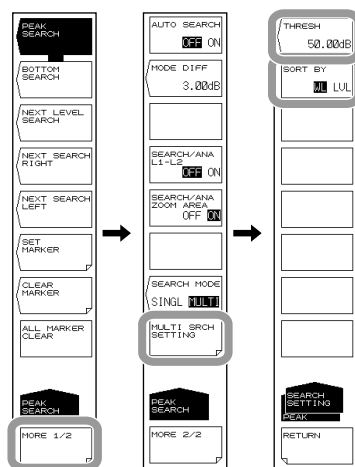

Explanation

The instrument detects multiple peaks (maximum level values) or bottoms (minimum level values) of the measured waveform at the same time.

THRESH

Set the threshold (detection range level) that is used when the multi search detects modes (peaks/bottoms).

For peak searches, the peak detection range is defined as being the levels from the measured waveform's maximum peak to the threshold value.

For bottom searches, the bottom detection range is defined as being the levels from the measured waveform's minimum bottom to the threshold value.

SORT BY

The detected marker values are displayed as a list in the data area. This setting sets the sort order of the detection list.

WL: Wavelengths are displayed in order starting from the shortest wavelength.

LVL: For the peak search, levels are displayed in order starting from the highest level.

For the bottom search, levels are displayed in order starting from the lowest level.

PEAK SEARCH

A peak search (a search for the maximum level values) is performed on the active trace waveform. Fixed markers are displayed on the peak points. The moving marker is displayed on the maximum peak (the maximum level value). The marker values are displayed in the data area. If the peaks are off the screen, their markers are displayed at the top or bottom edge of the screen. Even in this situation, the correct marker values are displayed.

After the measurement has completed, you can use the rotary knob to move the moving marker. You can use the arrow keys to scroll through the data area.

BOTTOM SEARCH

A bottom search (a search for the minimum level values) is performed on the active trace waveform. Fixed markers are displayed on the bottom points. The moving marker is displayed on the minimum bottom (the minimum level value). The marker values are displayed in the data area. If the bottoms are off the screen, their markers are displayed at the top or bottom edge of the screen. Even in this situation, the correct marker values are displayed.

After the measurement has completed, you can use the rotary knob to move the moving marker. You can use the arrow keys to scroll through the data area.

Other Soft Keys

The functions of the following soft keys displayed on the PEAK SEARCH menu are the same as the functions explained in the previous section on the single search. For details, see the explanation in the previous section.

NEXT LEVEL SEARCH

NEXT SEARCH RIGHT

NEXT SEARCH LEFT

SET MARKER

SET

CLEAR MARKER

CLEAR

ALL MARKER CLEAR

MODE DIFF

SEARCH/ANA L1-L2

SEARCH/ANA ZOOM AREA

AUTO SEARCH

Note

The MODE DIFF (mode judgment reference)—the peak/bottom difference—setting is shared between the multi search and single search.

6.1 Spectrum Width Measurement

Procedure

Spectrum width can be measured from the measured waveform.

1. Press **ANALYSIS**. The soft key menu for analyzing measured waveforms appears.
2. Press the **SPEC WIDTH** soft key. The analysis algorithm selection menu is displayed.
3. Press the **THRESH**, **ENVELOPE**, **RMS**, or **PEAK RMS** soft key. Analysis is performed, and the results are displayed in the data area.

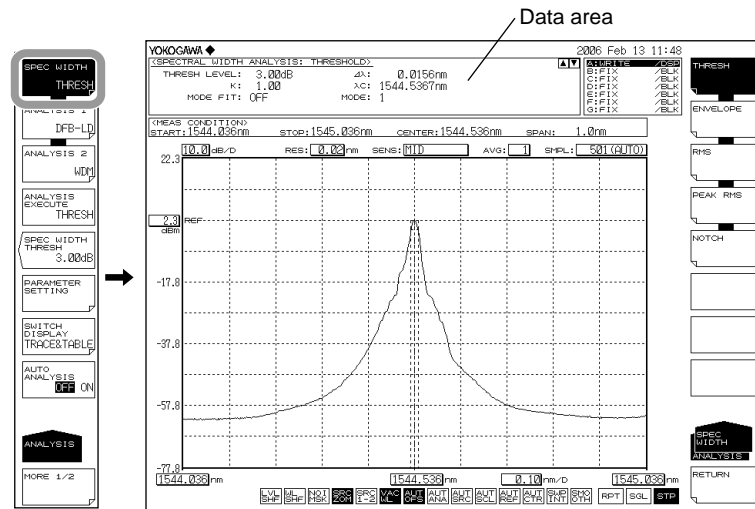

When changing the analysis parameters

4. Continuing on from step 3, press the **PARAMETER SETTING** soft key. The analysis parameter setting screen is displayed.
5. Move the cursor with the arrow keys, and enter a setting value with the numeric key pad.
6. Press the **CLOSE WINDOW** soft key. The analysis parameter setting screen closes, and the soft key menu returns to the previous stage.
7. Press the **ANALYSIS EXECUTE** soft key. Analysis is performed according to the changed parameters, and the results are displayed in the data area.

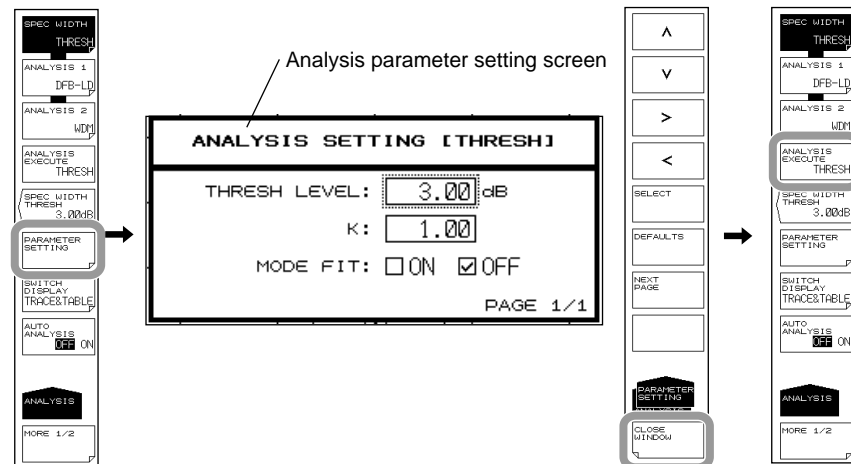

6.1 Spectrum Width Measurement

If you only want to change the THRESH LEVEL, you can also do so with the SPEC WIDTH THRESH soft key.

Changing the Threshold Value for Each Algorithm

4. Continuing on from step 3, press the **SPEC WIDTH THRESH** soft key. The threshold setting screen is displayed.
5. Enter a value using the rotary knob, arrow keys, or numeric key pad.
6. Press **ENTER**.

Automatic Analysis on Each Sweep

4. Continuing on from step 3, press the **AUTO ANALYSIS OFF ON** soft key to select ON. At the end of each sweep, the SPEC WIDTH, ANALYSIS 1, or ANALYSIS 2 function that was selected is executed automatically.

Note

- If the AUTO SEARCH soft key is ON when the AUTO ANALYSIS soft key is turned ON, AUTO SEARCH is automatically turned OFF.
 - When the AUTO ANALYSIS soft key is set to ON,  is displayed at the bottom of the screen in inverse video.
-

Printing Out Analysis Results

2. Continuing on from step 1, press the **MORE 1/2** soft key.
3. Press the **RESULT PRINT** soft key. The results are printed out on the built-in printer.

Saving Analysis Results

2. Continuing on from step 1, press the **MORE 1/2** soft key.
3. Press the **RESULT SAVE** soft key. The file list is displayed.
4. For the subsequent steps, see section 8.5, "Saving/Loading Analysis Results Data."

Explanation**Algorithms****Algorithms for Spectrum Width Analysis**

Algorithm	Description
THRESH	Determines spectrum width from the width between points where the waveform crosses the threshold value.
ENVELOPE	Determines spectrum width from waveform envelope.
RMS	Determines spectrum width from waveform standard deviation.
PEAK RMS	Determines spectrum width from waveform mode peak standard deviation.

Note

- For details about the spectrum width analysis algorithms and parameters, see appendix 2, "Data Calculation Algorithms for Spectrum Widths."
- For information on NOTCH, see section 6.2, "Notch Width Measurement."

Results Display

The analysis results are displayed in the data area.

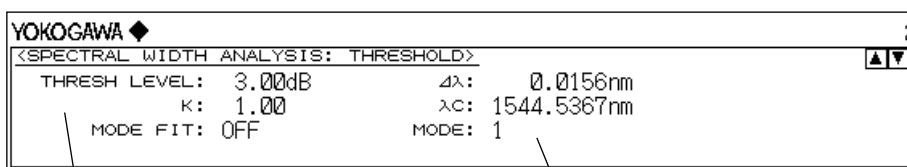

Analysis parameter setting value

Analysis results

$\Delta\lambda$: Spectrum width

λ_c : Spectrum width center

SPEC WIDTH THRESH

You can set threshold values for each spectrum width analysis algorithm. After the setting is made, analysis is executed and the display is updated.

The setting range is 0.01 to 50.00 dB. Settings can be adjusted in steps of 0.01. The value changes in steps of 1.00 if you press the COARSE key. The value is set in the DATA ENTRY section. This setting is held independently by each analysis algorithm. If the SPEC WIDTH soft key is OFF, this soft key is disabled.

The value set by this soft key is shared by the analysis parameter setting screen under the PARAMETER SETTING soft key.

6.2 Notch Width Measurement

Procedure

With notch width measurement, it is possible to measure notch width (pass band width/notch width) from the measured waveform of a filter with V-character type or U-character type wavelength characteristics.

1. Press **ANALYSIS**. The soft key menu for analyzing measured waveforms appears.
2. Press the **SPEC WIDTH** soft key. The analysis algorithm selection menu is displayed.
3. Press the **NOTCH** soft key. Analysis is performed, and the results are displayed in the data area.

Notch width measured waveform (BOTTOM)

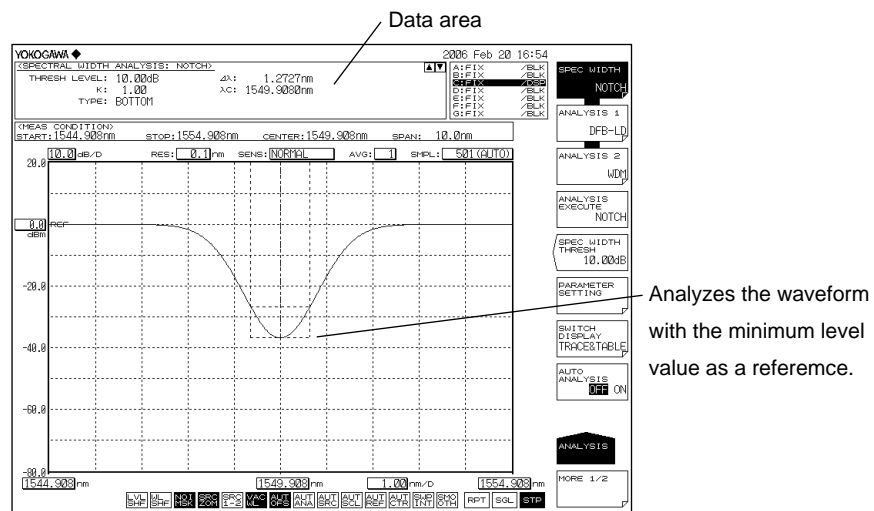

Notch width measured waveform (PEAK)

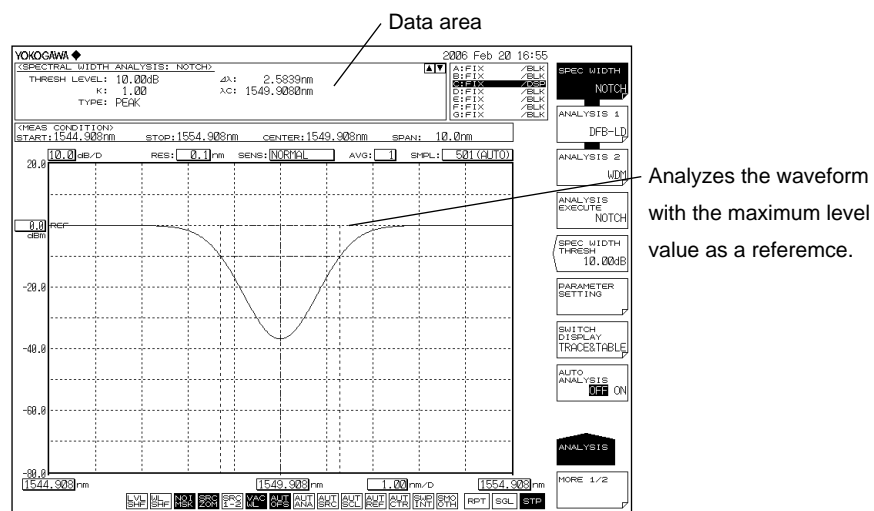

When changing the analysis parameters

4. Continuing on from step 3, press the **PARAMETER SETTING** soft key. The notch analysis parameter setting screen is displayed.
5. Move the cursor with the arrow keys or soft keys, and enter a setting value with the numeric key pad. To switch PEAK and BOTTOM, press the **SELECT** soft key.
6. Press the **CLOSE WINDOW** soft key. The analysis parameter setting screen closes, and the soft key menu returns to the previous stage.
7. Press the **ANALYSIS EXECUTE** soft key. Analysis is performed according to the changed parameters, and the results are displayed in the data area.

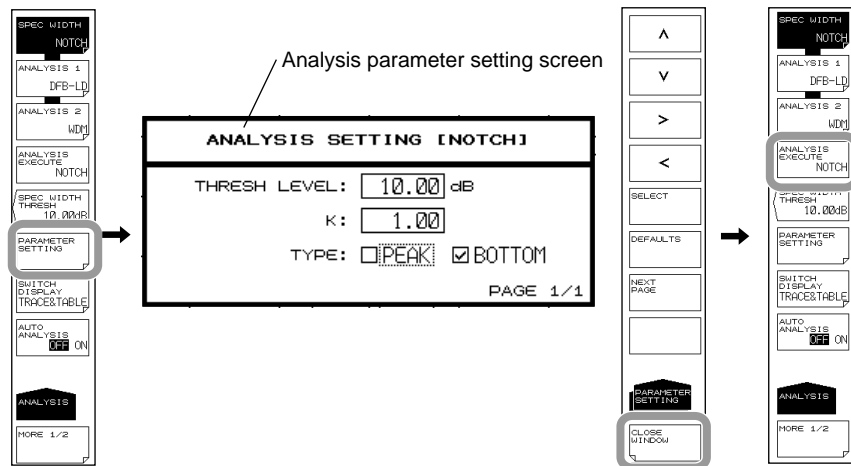

Note

For details about the notch width analysis algorithms and parameters, see appendix 2, "Data Calculation Algorithms for Spectrum Widths."

6.3 SMSR Measurement

Procedure

You can measure SMSR from the measured waveform of a DFB-LD.

1. Press **ANALYSIS**. The soft key menu for analyzing measured waveforms appears.
2. Press the **ANALYSIS 1** soft key. The analysis function selection menu is displayed.
3. Press the **SMSR** soft key. Analysis is performed, and the results are displayed in the data area.

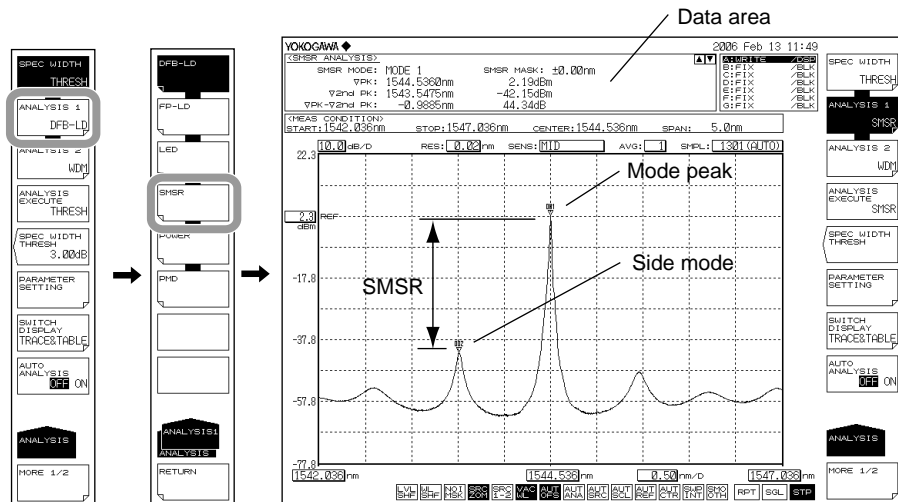

When changing the analysis parameters

4. Continuing on from step 3, press the **PARAMETER SETTING** soft key. The SMSR measurement parameter setting screen is displayed.
5. Move the cursor with the arrow keys or soft keys, and enter a setting value with the numeric key pad. To switch SMSR1 and SMSR2, press the **SELECT** soft key.
6. Press the **CLOSE WINDOW** soft key. The SMSR measurement parameter setting screen closes, and the soft key menu returns to the previous stage.
7. Press the **ANALYSIS EXECUTE** soft key. Analysis is performed according to the changed parameters, and the results are displayed in the data area.

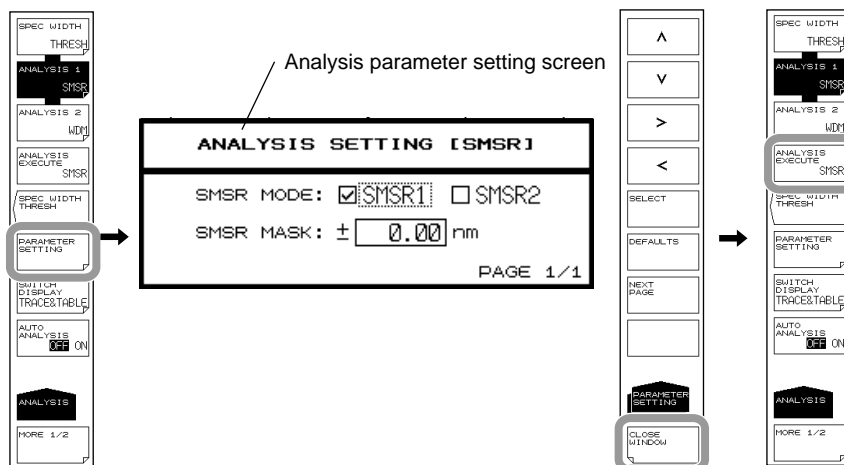

Explanation**SMSR**

SMSR stands for side-mode suppression ratio.

SMSR represents the difference between the mode peak and the side-mode level. It is one of the parameters used to evaluate the performance of DFB-LDs and the like.

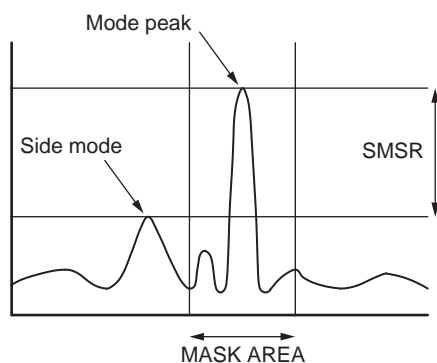
**Note**

For details on SMSR analysis algorithms, see appendix 3, "Details of Analysis Functions."

Results Display

The analysis results are displayed in the data area.

YOKOGAWA ◆	
<SMSR ANALYSIS>	
SMSR MODE: MODE 1	SMSR MASK: ± 0.00 nm
▽PK: 1544.5360nm	2.19dBm
▽2nd PK: 1543.5475nm	-42.15dBm
▽PK-▽2nd PK: -0.9885nm	44.34dB

Analysis results

▽PK: Mode peak wavelength, level value

▽2nd PK: Side mode wavelength, level value

Analysis parameter setting value

MODE 1: Set the 2nd peak excluding the MASK AREA as the side mode.

SMSR MASK: Mask setting range

6.4 POWER Measurement

Procedure

Optical power can be measured by integrating the measured waveform level values.

1. Press **ANALYSIS**. The soft key menu for analyzing measured waveforms appears.
2. Press the **ANALYSIS 1** soft key. The analysis function selection menu is displayed.
3. Press the **POWER** soft key. Analysis is performed, and the results are displayed in the data area.

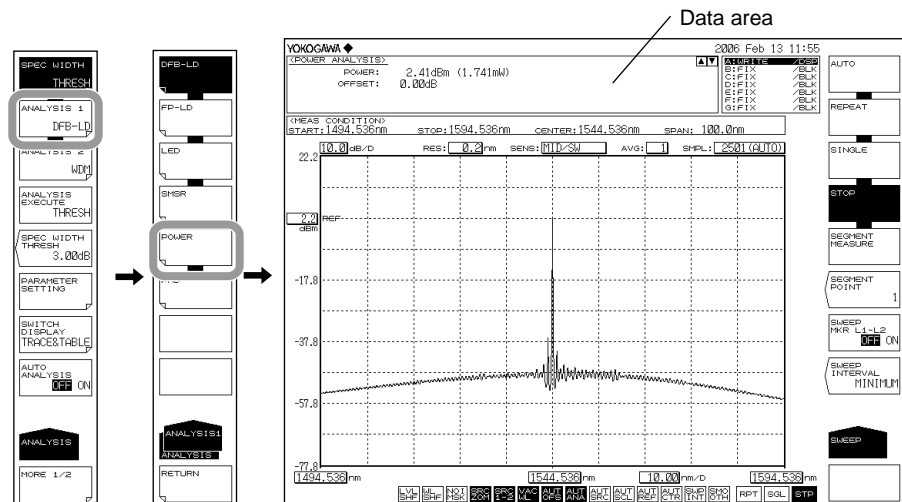

When changing the analysis parameters

4. Continuing on from step 3, press the **PARAMETER SETTING** soft key. The power offset setting screen is displayed.
5. Enter a setting value with the numeric key pad.
6. Press the **CLOSE WINDOW** soft key. The power offset setting screen closes, and the soft key menu returns to the previous stage.
7. Press the **ANALYSIS EXECUTE** soft key. Analysis is performed according to the changed parameters, and the results are displayed in the data area.

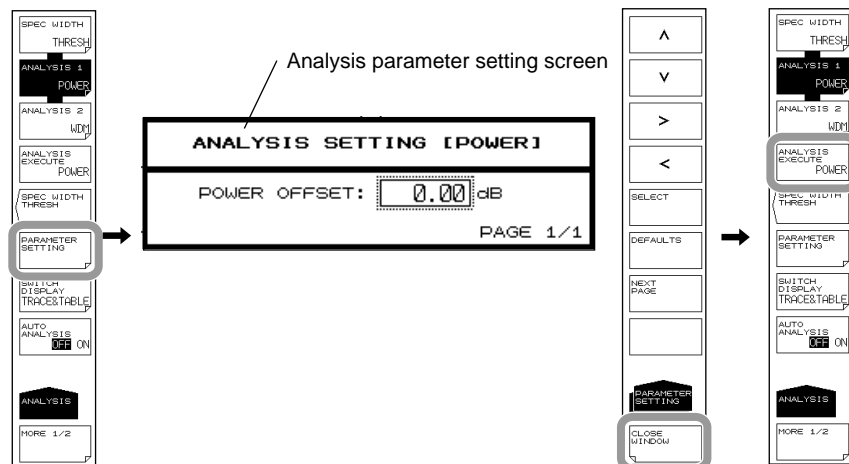

Note

For details on POWER analysis algorithms, see appendix 3, "Details of Analysis Functions."

6.5 DFB-LD, FP-LD, and LED Measurement

Procedure

Light source parameters can be analyzed from the measured waveform of each light source (DFB-LD, FP-LD, LED).

1. Press **ANALYSIS**. The soft key menu for analyzing measured waveforms appears.
2. Press the **ANALYSIS 1** soft key. The analysis function selection menu is displayed.
3. Press the **DFB-LD**, **FP-LD**, or **LED** soft key according to the type of light source to be analyzed. Analysis is performed, and the results are displayed in the data area.

Example of a measured waveform of an FP-LD

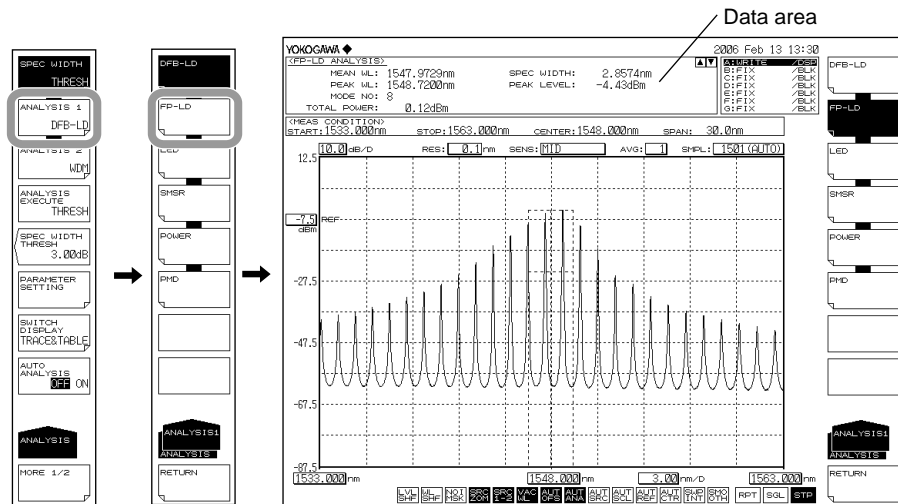

When changing the analysis parameters

4. Continuing on from step 3, press the **PARAMETER SETTING** soft key. The measurement parameter setting screen for the type of light source selected is displayed.
5. Move the cursor with the arrow keys or soft keys, and enter a setting value with the numeric key pad. To select a check box, align the cursor then press the **SELECT** soft key.
6. Press the **CLOSE WINDOW** soft key. The measurement parameter setting screen closes, and the soft key menu returns to the previous stage.
7. Press the **ANALYSIS EXECUTE** soft key. Analysis is performed according to the changed parameters, and the results are displayed in the data area.

Note

For details on the analysis algorithms for the DFB-LD, FP-LD, and LED light sources, see appendix 3, "Details of Analysis Functions."

6.6 PMD Measurement

Procedure

It is possible to measure the polarization mode dispersion (PMD) from a measured waveform by using the instrument in combination with a wideband light source and a polarizer, polarization controller, and an analyzer.

1. Press **ANALYSIS**. The soft key menu for analyzing measured waveforms appears.
2. Press the **ANALYSIS 1** soft key. The analysis function selection menu is displayed.
3. Press the **PMD** soft key. Analysis is performed, and the results are displayed in the data area.

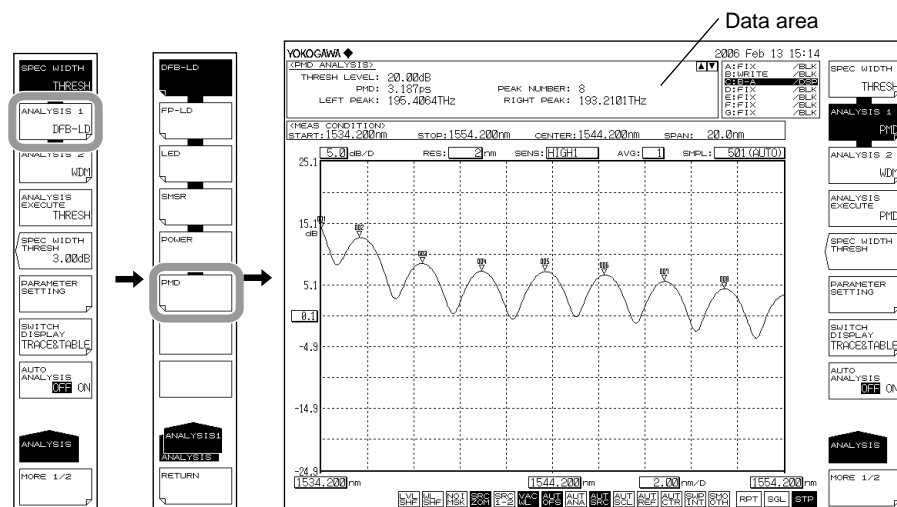

When changing the analysis parameters

4. Continuing on from step 3, press the **PARAMETER SETTING** soft key. The thresh level setting screen is displayed.
5. Enter a setting value with the numeric key pad.
6. Press the **CLOSE WINDOW** soft key. The thresh level setting screen closes, and the soft key menu returns to the previous stage.
7. Press the **ANALYSIS EXECUTE** soft key. Analysis is performed according to the changed parameters, and the results are displayed in the data area.

Note

- When PMD measurement is performed, waveform data at or below the threshold level from the peak are not used in analysis. The threshold level is entered in the threshold level setting screen.
- The mode-determination threshold level during PMD analysis execution is set using the MODE DIFF soft key in the PEAK SEARCH menu. The level difference which exceeds the value set with the MODE DIFF soft key is recognized as a mode.
- See section 6.12 for how to set the mode judgment threshold value.
- For an explanation on the PMD analysis algorithms, see appendix 3, "Details of Analysis Functions."

PMD measurement is performed after loading of the waveform used for PMD measurement.

Load the waveform for PMD measurement.

The following explains the structure of, and acquisition procedure for PMD measurement.

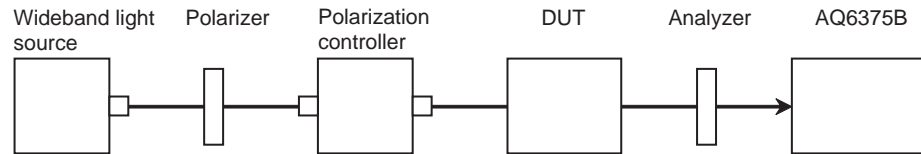

1. Enter measurement conditions so that the entire wavelength range of the wideband light source is measured. Set the resolution to about 0.050 nm.
2. Press **SWEEP**. Next, press the **REPEAT** soft key. Repeat sweeping begins.
3. While watching the waveform during repeat sweeping, adjust the polarization controller so as to maximize the waveform's peak/bottom difference (the level difference between the maximum and minimum values).
4. After the polarization controller has been adjusted, press the **SINGLE** soft key to perform a single sweep. Acquisition of measured waveforms is complete.

6.7 WDM Transmission Signal Analysis (Except Wavenumber Mode)

Procedure

You can measure the center wavelength, level, and SNR of each channel from the measured waveform of a WDM transmission signal. (Except Wavenumber Mode)

1. Press **ANALYSIS**. The soft key menu for analyzing measured waveforms appears.
2. Press the **ANALYSIS 2** soft key. The analysis function selection menu is displayed.
3. Press the **WDM** soft key. Analysis is performed, and the results are displayed in a list. The analysis results display screen is switched with the **SWITCH DISPLAY** soft key.

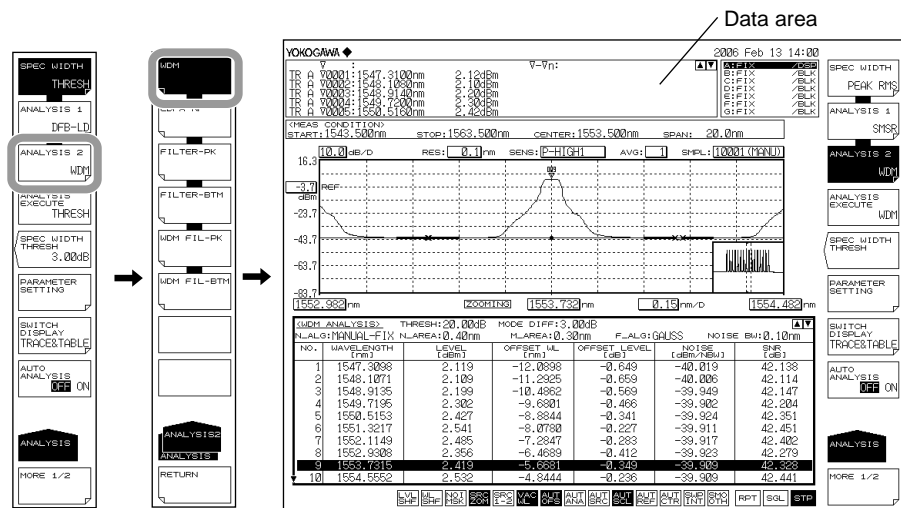

Note

When zooming a waveform, if you click in the list of analysis results, the waveform of the selected channel is displayed in the center of the waveform screen.

6.7 WDM Transmission Signal Analysis (Except Wavelength Mode)

When changing the analysis parameters

- Continuing on from step 3, press the **PARAMETER SETTING** soft key. The WDM analysis parameter setting screen is displayed. If a setting screen has multiple pages, press the **NEXT PAGE** soft key to display the next screen.
- Move the cursor with the arrow keys or soft keys, and enter a setting value with the numeric key pad. To select a check box, align the cursor then press the **SELECT** soft key.

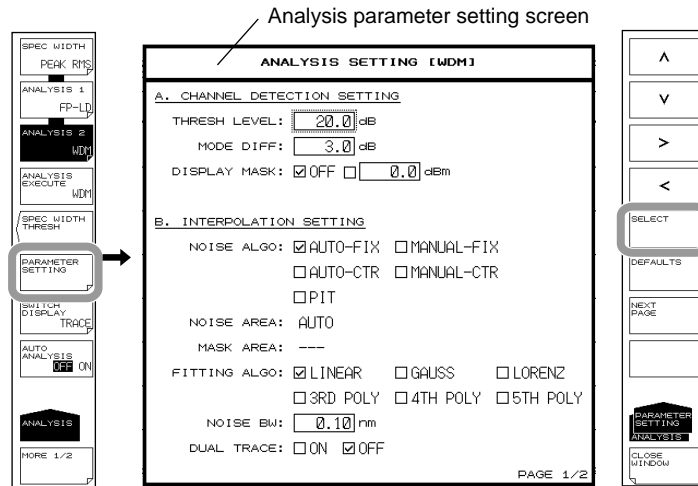

- Press the **CLOSE WINDOW** soft key. The WDM analysis parameter setting screen closes, and the soft key menu returns to the previous stage.
- Press the **ANALYSIS EXECUTE** soft key. Analysis is performed according to the changed parameters, and the results are displayed in a list.

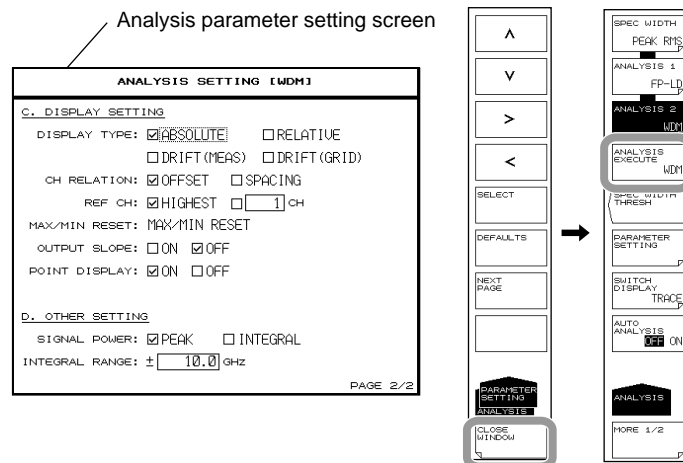

Note

See appendix 4, "WDM Analysis Function" for a description of the WDM analysis algorithms and parameters.

Explanation

The following configuration is used to measure WDM transmission signals.

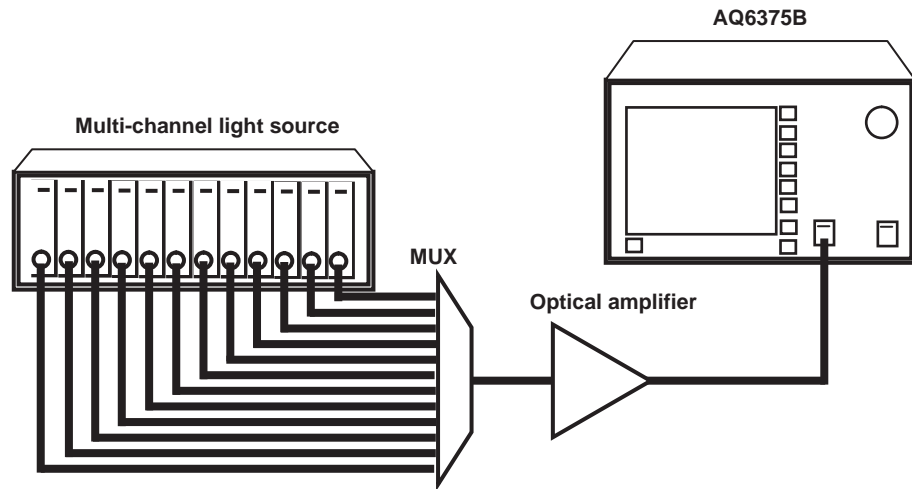

Measure the WDM signal light and write the waveform to the active trace.

Setting Analysis Parameters

The WDM analysis function parameters may be broadly divided into the following three configurations.

Parameter settings may be changed as desired according to the details of the particular analysis.

- Parameters related to channel detection (CHANNEL DETECTION SETTING)
- Parameters related to noise level measurement (INTERPOLATION SETTING)
- Parameters related to analysis results display method (DISPLAY SETTING)

These are explained below. See appendix 4, "WDM Analysis Function" for a description of the parameters.

Parameter Settings Related to Channel Detection

These parameters are used to set threshold level and the like for WDM channel detection.

THRESH LEVEL

This parameter is used to set the threshold level for channel detection.

This setting determines how far down in decibels from the peak level to detect a mode peak as a channel.

MODE DIFF

This parameter sets the minimum value for the peak/bottom difference during channel peak detection.

If the waveform peak/bottom difference equals or exceeds this value, it is detected as a mode peak.

DISPLAY MASK

This parameter sets the mask level value for channel masking.

Channels at a level equal to or below this setting are masked.

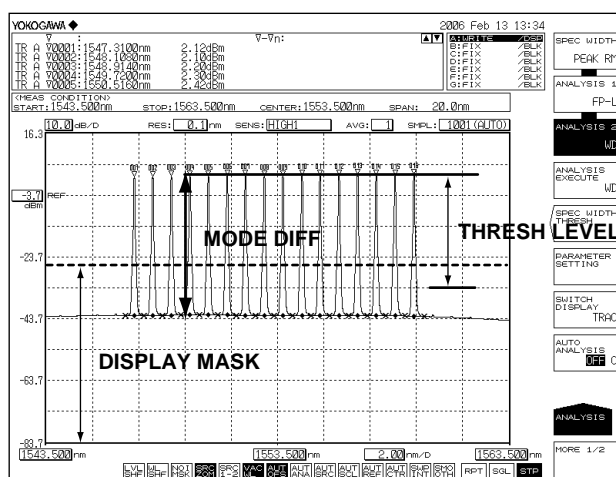

Parameter Settings Related to Noise Level Measurement

These parameters are used to set the interpolation method and bandwidth for noise level measurement.

NOISE ALGO

Select one of the five algorithms shown below for measuring the noise level.

If AUTO-FIX or AUTO-CTR is set, the measurement parameters at another noise level are set automatically. To set the values manually, select MANUAL-FIX or MANUAL-CTR.

- AUTO-FIX Automatic settings (FIX type)
- MANUAL-FIX Manual settings (FIX type)
- AUTO-CTR Automatic settings (CENTER type)
- MANUAL-CTR Manual settings (CENTER type)
- PIT Automatic settings (PIT type)

Note

- If AUTO-FIX, AUTO-CTR, or PIT is selected, the NOISE AREA and MASK AREA parameters are set automatically according to the measured waveform. FITTING ALGO is set to LINEAR.
- See appendix 4, "WDM Analysis Function" for a description of the WDM analysis algorithms and parameters.

6.7 WDM Transmission Signal Analysis (Except Wavenumber Mode)

FITTING ALGO

This parameter is used to select the interpolation algorithm for determining the noise level.

This parameter is only set when NOISE ALGO is set to MANUAL-FIX or MANUAL-CTR.

Interpolation algorithms

Fitting Algorithm	Description
LINER	Linear interpolation
GAUSS	Normal distribution curve
LORENZ	Lorenz curve
3RD POLY	3rd polynomial
4TH POLY	4th polynomial
5TH POLY	5th polynomial

Note

If NOISE ALGO is AUTO-FIX or AUTO-CTR, then FITTING ALGO is automatically set to LINEAR and does not need to be set manually.

NOISE AREA

This parameter is used to set the range of waveform data to be used in determining the noise level through interpolation.

This parameter is only set when NOISE ALGO is set to MANUAL-FIX.

MASK AREA

This parameter is used to set the range of signal light to be masked when determining the noise level through interpolation.

This parameter is only set when FITTING ALGO is not set to LINEAR.

NOISE BW

This parameter is used to set the noise bandwidth.

DUAL TRACE

This parameter is used to turn the dual trace function ON/OFF.

When the dual trace function is used, the signal level and noise level during SNR measurement can each be determined from different traces.

Parameter Settings for Analysis Results Display

These parameters are set with respect to the display format for displaying analysis results on the screen.

DISPLAY TYPE

This parameter is used to select the analysis results display format.

Display Type Settings

DISPLAY TYPE	Description and Procedure
ABSOLUTE (Absolute value display)	<ol style="list-style-type: none"> Set CH RELATION as OFFSET or SPACING. OFFSET: Displays the relative value, channel to the reference channel. SPACING: Displays the wavelength difference and level difference compared to the following adjacent channel. If OFFSET is selected, the reference channel is set through "REF CH". <ul style="list-style-type: none"> If the highest channel is used as a reference Set to HIGHEST. If any desired channel is used as a reference Set the reference channel number in "****CH".
RELATIVE (Relative value display relative to grid)	There are no setting fields for this display type. (See appendix 1, "WDM Wavelength GRID Table" for information on changing the grid table.)
DRIFT(MEAS) (Drift display using past measurement wavelength as a reference)	<p>The procedure for this display type varies depending on the reference.</p> <ul style="list-style-type: none"> Press the MAX/MIN RESET key if you want to use the waveform data of the current active trace as a reference. To change the measurement conditions and set the initially measured waveform as the reference <p>There are no parameter setting items since the data that was measured first becomes the reference.</p>
DRIFT(GRID) (Drift display using grid wavelength as a reference)	<p>The procedure for this display type varies depending on the reference.</p> <ul style="list-style-type: none"> Press the MAX/MIN RESET key if you want to use the waveform data of the current active trace as a reference. To change the measurement conditions and set the initially measured waveform as the reference <p>There are no parameter setting items since the data that was measured first becomes the reference.</p> <p>(See appendix 1, "WDM Wavelength GRID Table" for information on changing the grid wavelength.)</p>

6.7 WDM Transmission Signal Analysis (Except Wavenumber Mode)

OUTPUT SLOPE

Displays the least square approximation line passing through the detected channel peak. The channel slope can be obtained as a numerical value.

OUTPUT RESULTS of analysis results

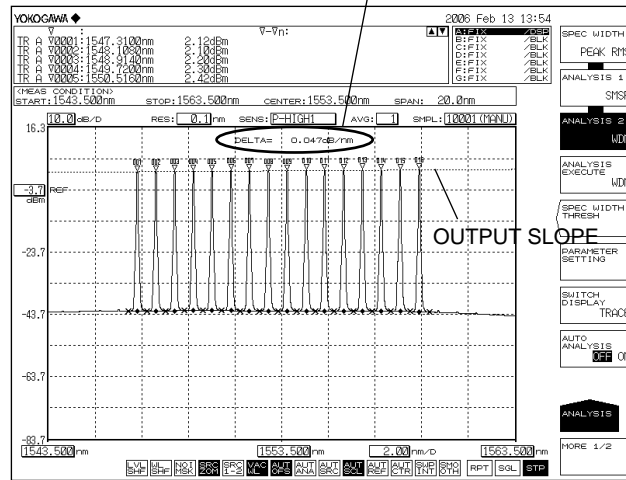

POINT DISPLAY

This parameter is used to display the range of data used in interpolation for determining the noise level.

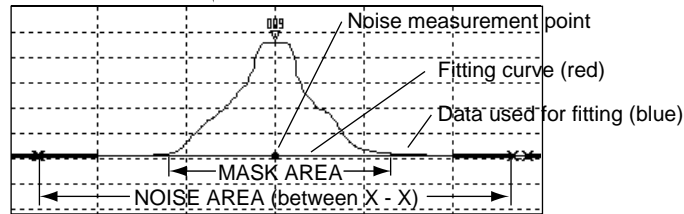
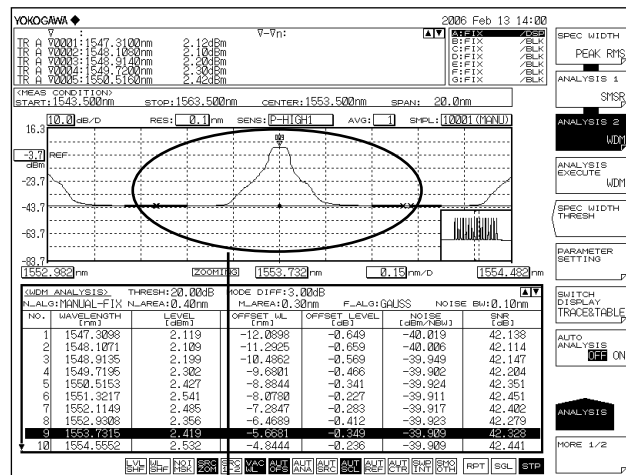

6.8 Optical Amp Gain and NF Measurement (Except Wavenumber Mode)

Procedure

Measurement can be performed of the optical amp gain and noise figure from the measured waveform of the signal light going into the optical amp, and the measured waveform of the output light leaving the optical amp. (Except Wavenumber Mode)

1. Press **ANALYSIS**. The soft key menu for analyzing measured waveforms appears.
2. Press the **ANALYSIS 2** soft key. The analysis function selection menu is displayed.
3. Press the **EDFA-NF** soft key. Analysis is performed, and the results are displayed in a list. The analysis results display screen is switched with the **SWITCH DISPLAY** soft key.

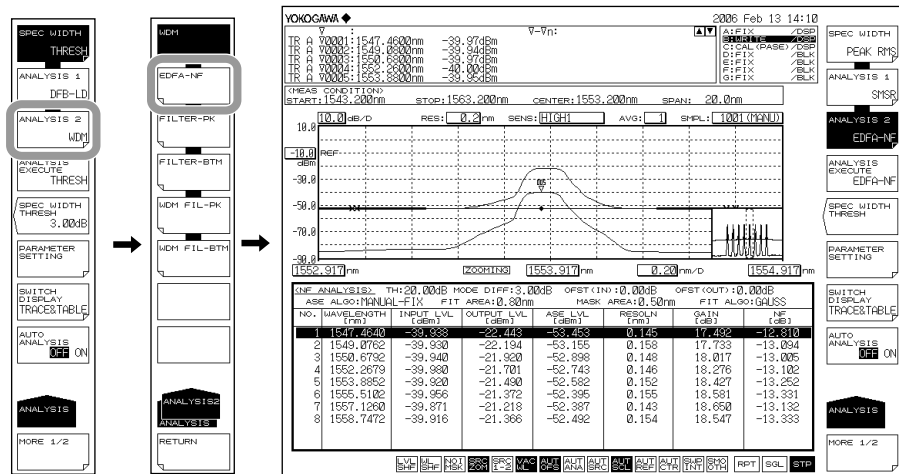

Note

When zooming a waveform, if you click in the list of analysis results, the waveform of the selected channel is displayed in the center of the waveform screen.

6.8 Optical Amp Gain and NF Measurement (Except Wavenumber Mode)

When changing the analysis parameters

- Continuing on from step 3, press the **PARAMETER SETTING** soft key. The EDFA-NF analysis parameter setting screen is displayed.
- Move the cursor with the arrow keys or soft keys, and enter a setting value with the numeric key pad. To select a check box, align the cursor then press the **SELECT** soft key.
- Press the **CLOSE WINDOW** soft key. The EDFA-NF analysis parameter setting screen closes, and the soft key menu returns to the previous stage.
- Press the **ANALYSIS EXECUTE** soft key. Analysis is performed according to the changed parameters, and the results are displayed in a list.

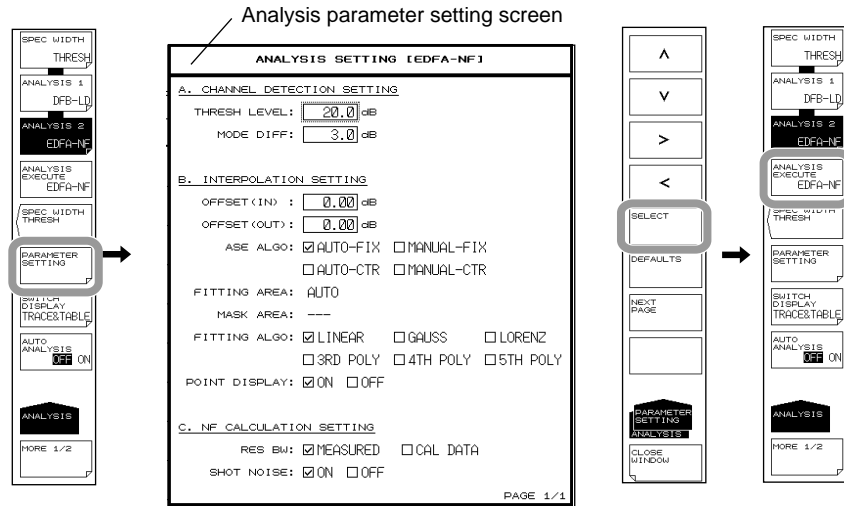

Note

See appendix 5, "Optical Amp Analysis Function" for a description of the optical amp analysis algorithms and parameters.

Analysis of optical amp gain and NF is performed after measuring the signal light going into the optical amp and the output light leaving the optical amp.

Acquiring Waveforms Required for Analysis

The following configuration and general procedure is used to measure optical amp gain and NF.

Signal light measurement configuration

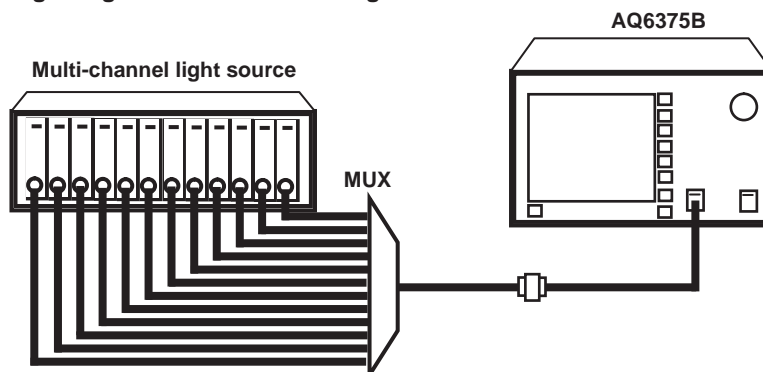

Output light measurement configuration

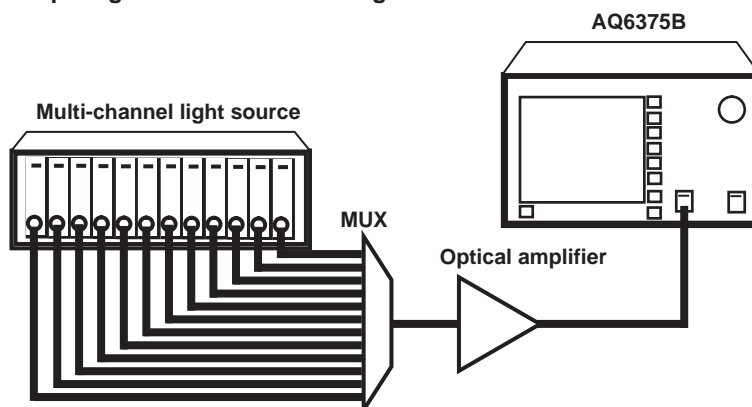

Writing the Waveform of the Signal Light Input to the Optical Amp on Trace A

1. Input the signal light sent to the optical amp into the instrument.
2. Press **TRACE** followed by the **ACTIVE TRACE** soft key, then select A.
3. Press the **VIEW A** soft key and select **DISP**.
4. Press the **WRITE A** soft key. Trace A enters write mode.
5. Measure the signal light waveform according to measurement conditions matching the signal light waveform.
(For details on the measuring procedure, see chapter 4, "Measurement.")
6. Press the **FIX A** soft key under **TRACE**. Trace A enters fixed mode.

Note

If all traces from trace A to trace G have been set to fix mode (FIX) as a result of this action, a warning is displayed. However, this does not pose a problem because trace B is set to write mode in the next step.

6.8 Optical Amp Gain and NF Measurement (Except Wavenumber Mode)

Writing the Waveform of the Output Light from the Optical Amp to Trace B

7. Input the light output from the optical amp into the instrument.
8. Press **TRACE** followed by the **ACTIVE TRACE** soft key, then select B.
9. Press the **VIEW B** soft key and select **DISP**.
10. Press the **WRITE B** soft key. Trace **B** enters write mode.
11. Measure the waveform of the output light with the same measurement conditions used for measuring the signal light waveform.

Examples of signal and output light waveforms

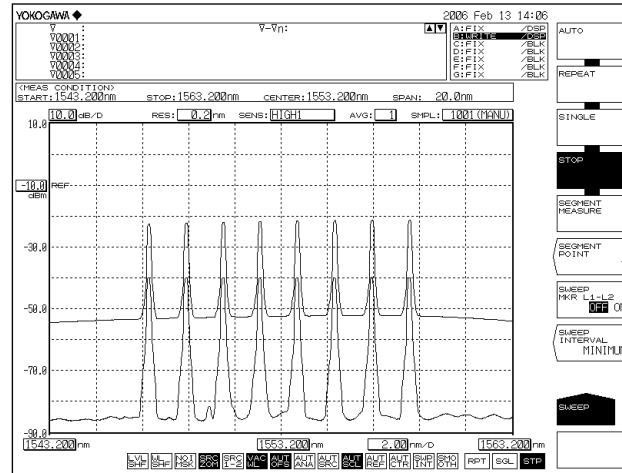

Explanation

Setting EDFA-NF Analysis Parameters

The EDFA-NF analysis function parameters may be broadly divided into the following two configurations.

Parameter settings may be changed as desired according to the details of the particular analysis.

- Parameters related to channel detection (CHANNEL DETECTION SETTING)
- ASE level measurement (INTERPOLATION SETTING).
- NF computation related parameters (NF CALCULATION SETTING).

Below is an explanation of each.

See appendix 3, "Analysis Function Details" for a description of the parameters.

Parameter Settings Related to Channel Detection

These parameters are used to set the threshold level and the like for WDM channel detection.

THRESH LEVEL

This parameter is used to set the threshold level for channel detection.

This setting determines how far down in decibels from the peak level to detect a mode peak as a channel.

MODE DIFF

This parameter sets the minimum value for the peak/bottom difference during channel peak detection.

If the waveform peak/bottom difference equals or exceeds this value, it is detected as a mode peak.

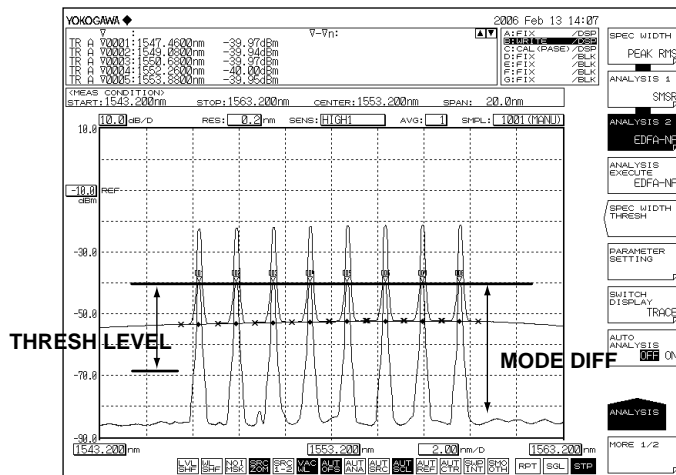

Parameters Related to ASE Level Measurement

These parameters are used to set the waveform level, offset, and interpolation method for ASE level measurement.

OFFSET(IN)

A level offset can be set on a signal light waveform (trace A).

Set "0.00" if a level offset is not needed.

OFFSET(OUT)

A level offset can be set on an output light waveform (trace B).

Set "0.00" if a level offset is not needed.

ASE ALGO

Select one of the four algorithms shown below for measuring the ASE level. If AUTO-FIX or AUTO-CTR is set, the measurement parameters at another ASE level are set automatically. To set the values manually, select MANUAL-FIX or MANUAL-CTR.

- AUTO-FIX Automatic settings (FIX type)
- MANUAL-FIX Manual setting (FIX type)
- AUTO-CTR Automatic setting (CENTER type)
- MANUAL-CTR Manual setting (CENTER type)

Note

- If AUTO-FIX or AUTO-CTR is selected, the FITTING AREA and MASK AREA parameters are set automatically according to the measured waveform. FITTING ALGO is set to LINEAR.
 - See appendix 5, "Optical Amp Analysis Function" for a description of the parameters.
-

FITTING ALGO

This parameter is used to select the interpolation algorithm for determining the ASE level. This parameter is only set when "ASE ALGO" is set to MANUAL-FIX or MANUAL-CTR.

Interpolation algorithms

Fitting Algorithm	Description
LINER	Linear interpolation
GAUSS	Normal distribution curve
LORENZ	Lorenz curve
3RD POLY	3rd polynomial
4TH POLY	4th polynomial
5TH POLY	5th polynomial

Note

If NOISE ALGO is AUTO-FIX or AUTO-CTR, then FITTING ALGO is automatically set to LINEAR and does not need to be set manually.

FITTING AREA

This parameter is used to set the range of waveform data to be used in determining the ASE level through interpolation.

This parameter is only set when "ASE ALGO" is set to MANUAL-FIX.

MASK AREA

This parameter is used to set the range of signal light to be masked when determining the ASE level through interpolation.

This parameter is only set when "FITTING ALGO" is not set to LINEAR.

POINT DISPLAY

This parameter is used to display the range of data used in interpolation for determining the noise level.

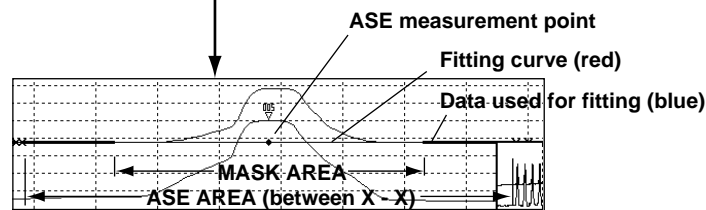
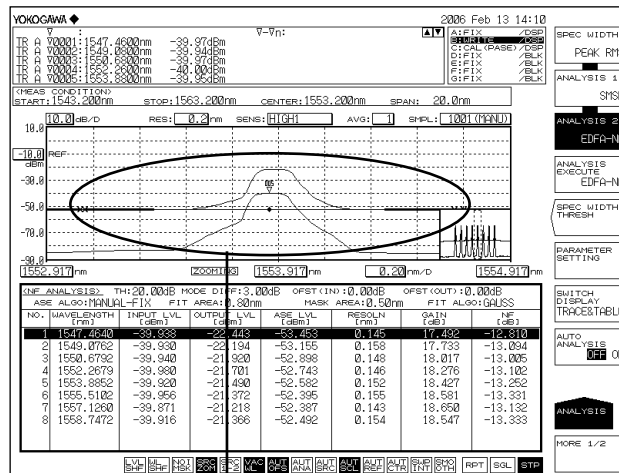

NF computation related parameters

RES BW

Set the method for calculating the measurement resolution RBi of each channel used in computing the NF value.

The default is MEASURED.

If the measuring resolution varies greatly from channel to channel, or in other such cases, set to CAL DATA.

- MEASURED: Determine the value of the THRESH 3dB width for each channel from the TRACE B waveform and set to RBi.
- CAL DATA: Set the actual resolution value stored in the instrument to RBi.

SHOT NOISE

Sets whether the Shot Noise component is included in computation of the NF value.

The default is ON.

- ON: Shot Noise component included in computation of the NF value.
- OFF: Shot Noise component not included in computation of the NF value.

6.9 Optical Filter Characteristics Measurement (Except Wavenumber Mode)

Procedure

Optical filter characteristics can be measured from the measured waveform of the light input to the optical filter from the light source, as well as from the measured waveform light output from the optical filter. (Except Wavenumber Mode)

Filter Measurement (Single Channel)

You can analyze a waveform whose number of modes is 1.

Filter Peak Analysis

1. Press **ANALYSIS**. The soft key menu for analyzing measured waveforms appears.
2. Press the **ANALYSIS 2** soft key. The analysis function selection menu is displayed.
3. Press the **FILTER-PK** soft key. Analysis is performed, and the results are displayed in the data area.

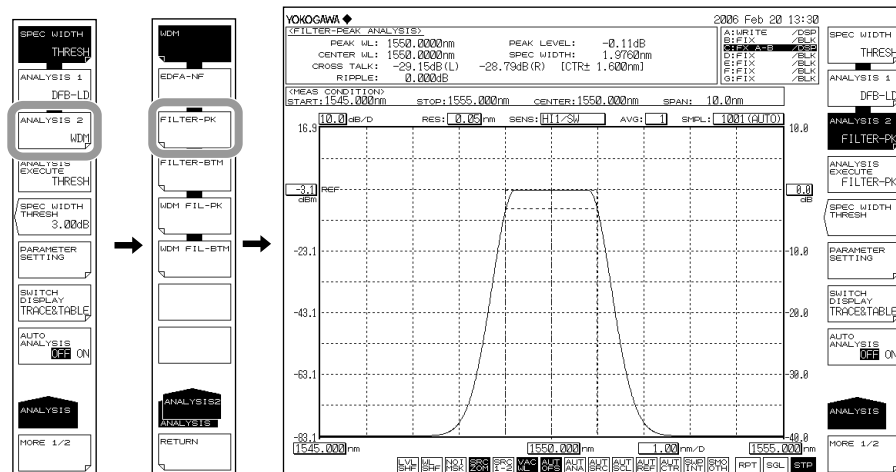

When changing the analysis parameters

4. Continuing on from step 3, press the **PARAMETER SETTING** soft key. The FILTER-PK analysis parameter setting screen is displayed. If a setting screen has multiple pages, press the **NEXT PAGE** soft key to display the next screen.
5. Move the cursor with the arrow keys or soft keys, and enter a setting value with the numeric key pad. To select a check box, align the cursor then press the **SELECT** soft key.
6. Press the **CLOSE WINDOW** soft key. The FILTER-PK analysis parameter setting screen closes, and the soft key menu returns to the previous stage.
7. Press the **ANALYSIS EXECUTE** soft key. Analysis is performed according to the changed parameters, and the results are displayed in a list.

6.9 Optical Filter Characteristics Measurement (Except Wavenumber Mode)

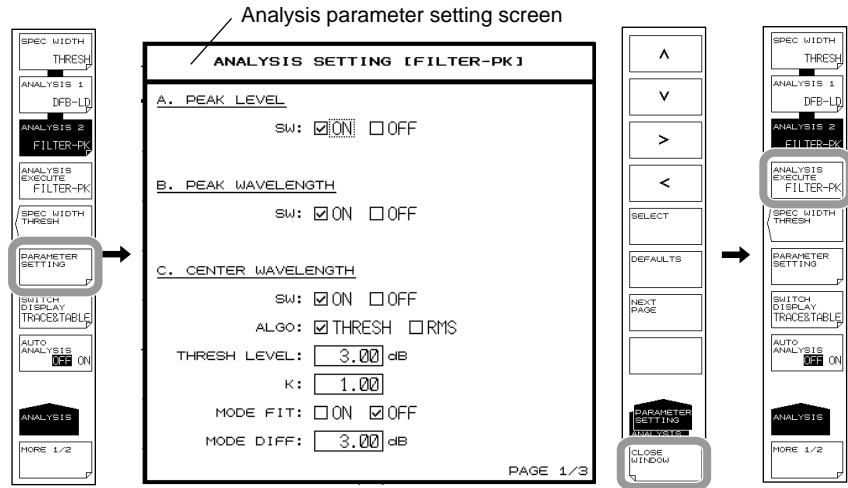

Note

See appendix 6, "Optical Filter Analysis Function" for a description of the optical filter analysis algorithms and parameters.

Filter Bottom Analysis

This is used if the optical filter is of a notch type rather than a pass band type.

1. Press **ANALYSIS**. The soft key menu for analyzing measured waveforms appears.
2. Press the **ANALYSIS 2** soft key. The analysis function selection menu is displayed.
3. Press the **FILTER-BTM** soft key. Analysis is performed, and the results are displayed in the data area.

When changing the analysis parameters

4. Continuing on from step 3, press the **PARAMETER SETTING** soft key. The FILTER-BTM analysis parameter setting screen is displayed. If a setting screen has multiple pages, press the **NEXT PAGE** soft key to display the next screen.
5. Move the cursor with the arrow keys or soft keys, and enter a setting value with the numeric key pad. To select a check box, align the cursor then press the **SELECT** soft key.
6. Press the **CLOSE WINDOW** soft key. The FILTER-BTM analysis parameter setting screen closes, and the soft key menu returns to the previous stage.
7. Press the **ANALYSIS EXECUTE** soft key. Analysis is performed according to the changed parameters, and the results are displayed in a list.

Note

See appendix 6, "Optical Filter Analysis Function" for a description of the optical filter analysis algorithms and parameters.

Filter Measurement for WDM (Multi Channel)

You can analyze multi-mode waveforms.

WDM Filter Peak Analysis

1. Press **ANALYSIS**. The soft key menu for analyzing measured waveforms appears.
2. Press the **ANALYSIS 2** soft key. The analysis function selection menu is displayed.
3. Press the **WDM FILTER-PK** soft key. Analysis is performed, and the results are displayed in a list. The analysis results display screen is switched with the **SWITCH DISPLAY** soft key.

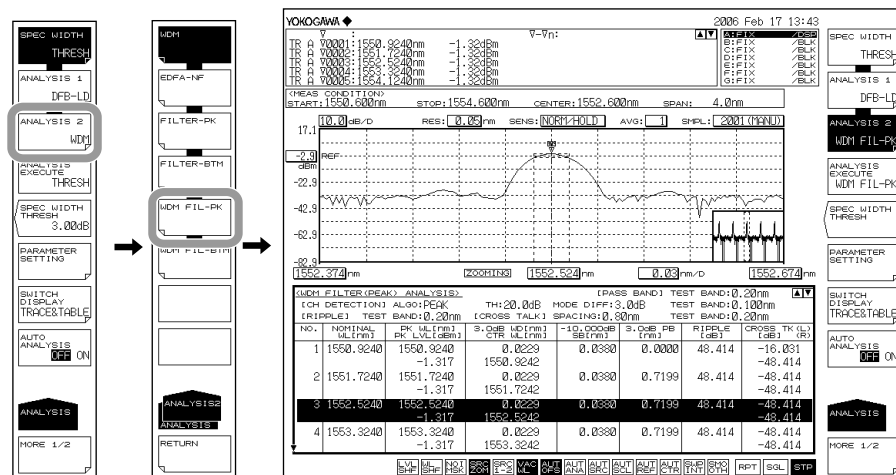

Note

When zooming a waveform, if you click in the list of analysis results, the waveform of the selected channel is displayed in the center of the waveform screen.

When changing the analysis parameters

4. Continuing on from step 3, press the **PARAMETER SETTING** soft key. The WDM FIL-PK analysis parameter setting screen is displayed. If a setting screen has multiple pages, press the **NEXT PAGE** soft key to display the next screen.
5. Move the cursor with the arrow keys or soft keys, and enter a setting value with the numeric key pad. To select a check box, align the cursor then press the **SELECT** soft key.
6. Press the **CLOSE WINDOW** soft key. The WDM FIL-PK analysis parameter setting screen closes, and the soft key menu returns to the previous stage.
7. Press the **ANALYSIS EXECUTE** soft key. Analysis is performed according to the changed parameters, and the results are displayed in a list.

6.9 Optical Filter Characteristics Measurement (Except Wavenumber Mode)

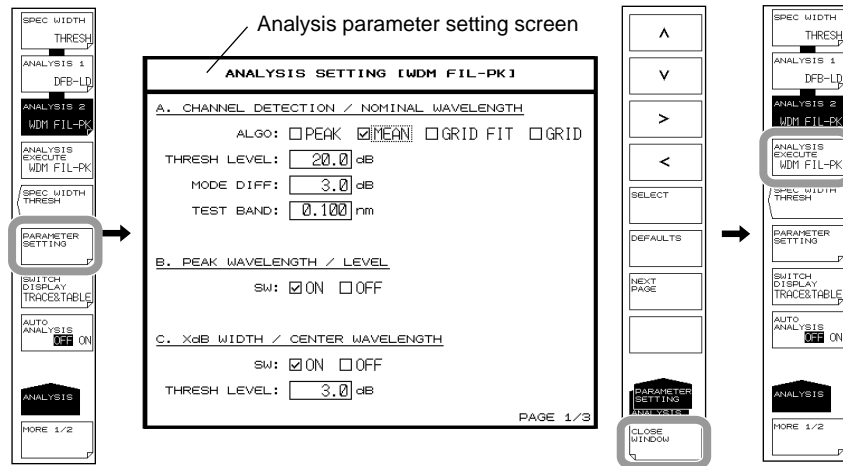

Note

See appendix 6, "Optical Filter Analysis Function" for a description of the optical filter analysis algorithms and parameters.

WDM Filter Bottom Analysis

This is used if the optical filter is of a notch type rather than a pass band type.

1. Press **ANALYSIS**. The soft key menu for analyzing measured waveforms appears.
2. Press the **ANALYSIS 2** soft key. The analysis function selection menu is displayed.
3. Press the **WDM FIL-BTM** soft key. Analysis is performed, and the results are displayed in a list. The analysis results display screen is switched with the **SWITCH DISPLAY** soft key.

Note

When zooming a waveform, if you click in the list of analysis results, the waveform of the selected channel is displayed in the center of the waveform screen.

When changing the analysis parameters

4. Continuing on from step 3, press the **PARAMETER SETTING** soft key. The WDM FIL-BTM analysis parameter setting screen is displayed. If a setting screen has multiple pages, press the **NEXT PAGE** soft key to display the next screen.
5. Move the cursor with the arrow keys or soft keys, and enter a setting value with the numeric key pad. To select a check box, align the cursor then press the **SELECT** soft key.
6. Press the **CLOSE WINDOW** soft key. The WDM FIL-BTM analysis parameter setting screen closes, and the soft key menu returns to the previous stage.
7. Press the **ANALYSIS EXECUTE** soft key. Analysis is performed according to the changed parameters, and the results are displayed in a list.

Note

See appendix 6, "Optical Filter Analysis Function" for a description of the optical filter analysis algorithms and parameters.

6.9 Optical Filter Characteristics Measurement (Except Wavenumber Mode)

First measure the waveform of the wideband light source as a reference waveform, then subtract the WDM optical filter's output waveform from the reference waveform to measure the characteristics of the WDM optical filter.

Acquiring Waveforms Required for Analysis

The following configuration and general procedure is used to measure WDM optical filter characteristics.

A pass band type WDM optical filter is used as an example.

Reference spectrum

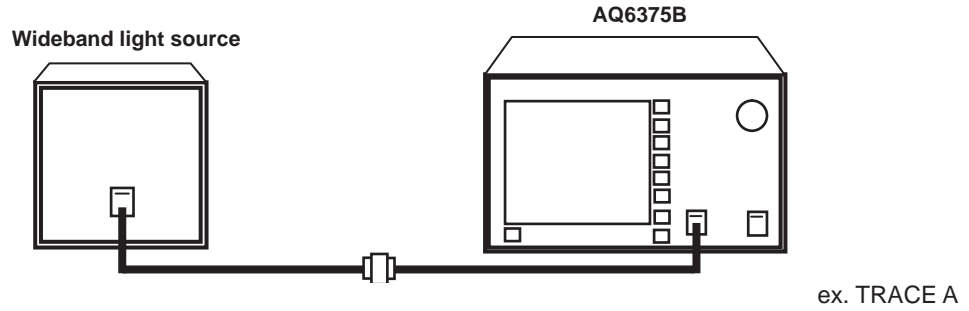

Spectrum measurement after passing through the filter

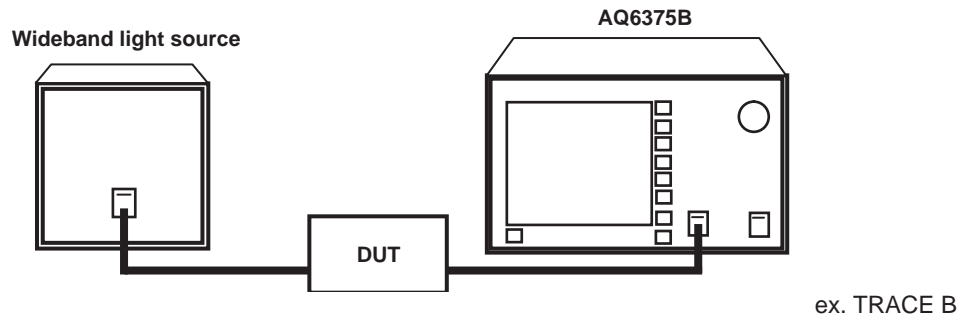

Writing the Waveform of the Light Source Input to the Optical Filter on Trace A

1. Input the emitted light from the light source that is input to the optical filter into the instrument.
2. Press **TRACE** followed by the **ACTIVE TRACE** soft key, then select A.
3. Press the **VIEW A** soft key and select **DISP**.
4. Press the **WRITE A** soft key. Trace A enters write mode.
5. Measure the light source waveform according to measurement conditions matching the light source waveform.
(For details on the measuring procedure, see chapter 4, "Measurement.")
6. Press the **FIX A** soft key under **TRACE**. Trace A enters fixed mode.

Note

If all traces from trace A to trace G have been set to fix mode (FIX) as a result of this action, a warning is displayed. However, this does not pose a problem because trace B is set to write mode in the next step.

Writing the Waveform of the Output Light from the Optical Filter to Trace B

1. Input the emitted light from the light source to the optical filter, then input the light that is output from the optical filter into the instrument.
2. Press **TRACE** followed by the **ACTIVE TRACE** soft key, then select B.
3. Press the **VIEW B** soft key and select **DISP**.
4. Press the **WRITE B** soft key. Trace B enters write mode.
5. Measure the waveform of the output light with the same measurement conditions used for measuring the light source waveform.

Writing the Difference between Traces to Trace C

2. Press **TRACE** followed by the **ACTIVE TRACE** soft key, then select C.
3. Press the **VIEW C** soft key and select **DISP**.
4. Press the **CALCULATE C** soft key.
5. Press the **LOG MATH** soft key. The math function selection menu is displayed.
6. Press the **C = A-B (LOG)** soft key. The waveform which is obtained by subtracting the trace B waveform from the trace A waveform is displayed on trace C.

Explanation

Setting WDM Filter Analysis Parameters

The WDM FIL-PK analysis function parameters may be broadly divided into the two types shown below.

Parameter settings may be changed as desired according to the details of the particular analysis.

- Parameters related to channel detection
- Parameter settings for each analysis item

The following is an explanation of each of the parameters.

See appendix 6, "Optical Filter Analysis Function" for a description of the parameters.

Parameter Settings Related to Channel Detection

These parameters are used to set algorithms and threshold level for WDM channel detection.

ALGO

Depending on the selected algorithm, select one of the following four algorithms for WDM channel detection and reference wavelength analysis on each channel.

- PEAK
- MEAN
- GRID FIT
- GRID

The channel detection and reference wavelength analysis results for each channel vary depending on the algorithm selected.

- **When PEAK is selected**

Each mode peak is detected as a channel.

The peak wavelength of each channel is the reference wavelength.

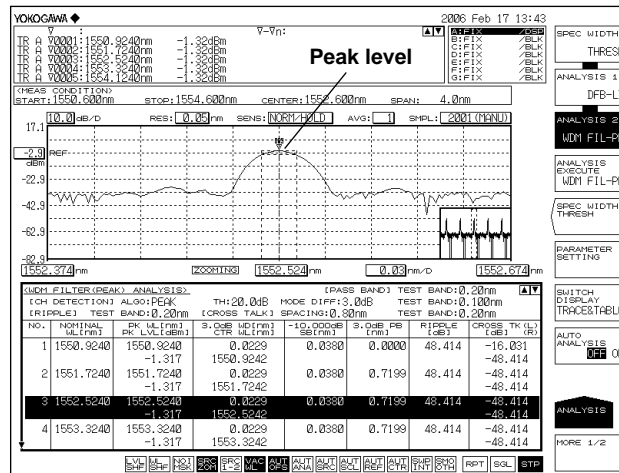

6.9 Optical Filter Characteristics Measurement (Except Wavenumber Mode)

- **When MEAN is selected**
Each mode peak is detected as a channel.
The 3dB center wavelength of each channel is the reference wavelength.

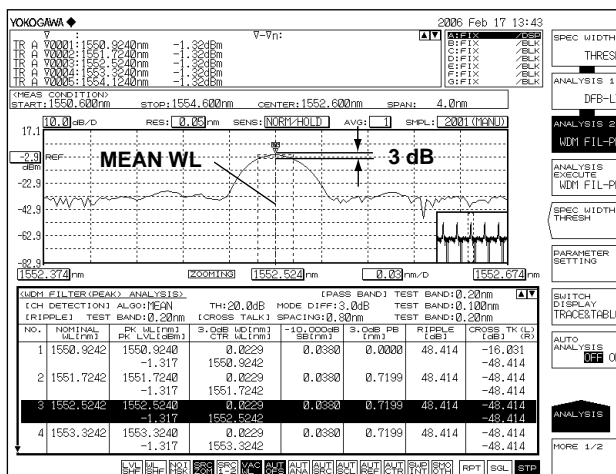

- **When GRID FIT is selected**
The mode peak detected within GRID WL [PLUSMINUS SYMBOL] (TEST BAND/2) is set as the channel.
The GRID wavelength nearest to each channel is the reference wavelength.

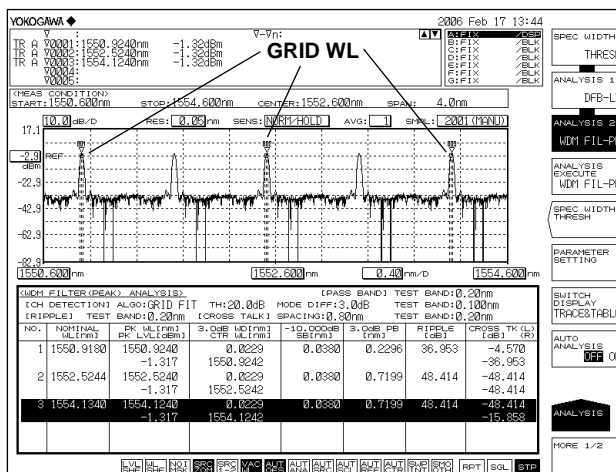

6.9 Optical Filter Characteristics Measurement (Except Wavelength Mode)

- **When GRID is selected**
The wavelengths registered in the GRID table wavelength are recognized as channels.
GRID WL is set as the reference wavelength.

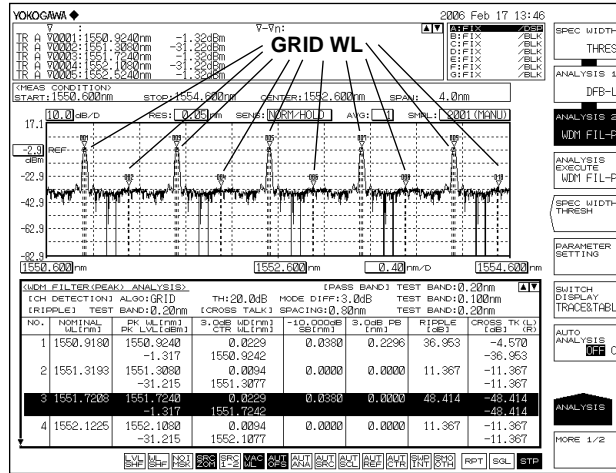

THRESH LEVEL

This parameter is used to set the threshold level for channel detection.

MODE DIFF

This parameter sets the minimum value for the peak/bottom difference during channel peak detection.

TEST BAND

This parameter is used to set the bandwidth for reference wavelength analysis.

Parameter Settings for the Analysis Items

These parameters are set for each WDM optical filter analysis item.

The analysis parameter setting screen is displayed.

Note

See appendix 6, "Optical Filter Analysis Function" for a description of the optical filter analysis algorithms and parameters.

6.10 Editing the Grid Table (Except Wavenumber Mode)

Procedure

Editing a Standard Grid Table

1. Press **SYSTEM**.
2. Press the **GRID EDITOR** soft key. The Grid table edit screen appears.

Setting the Frequency Spacing

3. Press one of the keys from **200 GHz SPACING** to **12.5 GHz SPACING**. Depending on the selected soft key, a frequency spacing table of 200 GHz, 100 GHz, 50 GHz, 25 GHz, or 12.5 GHz can be used.

Setting the Reference Wavelength

4. Press the **REFERENCE WAVELENGTH** soft key. A screen for specifying the standard wavelength is displayed.
5. Enter the standard wavelength using the rotary knob or arrow keys, then press **nm/ENTER**.

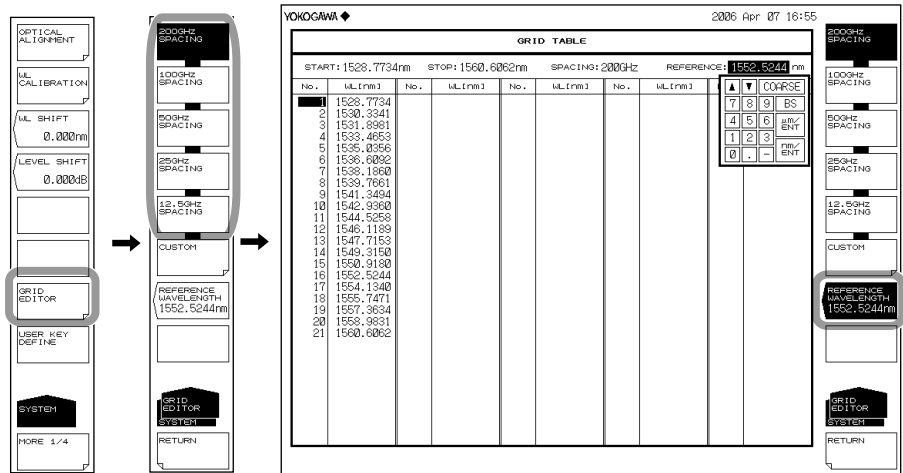

6.10 Editing the Grid Table (Except Wavenumber Mode)

Editing a Custom Grid Table

1. Press **SYSTEM**.
2. Press the **GRID EDITOR** soft key. The Grid table edit screen appears.
3. Press the **CUSTOM** soft key. The custom Grid table edit screen appears.

Setting the Start/Stop Wavelength

4. Press the **START WL** or **STOP WL** soft key. A screen for specifying the start or stop wavelength is displayed.
5. Enter the start or stop wavelength using the rotary knob or arrow keys, then press **nm/ENTER**.

Setting the Frequency Spacing

6. Press the **SPACING** soft key. A screen for specifying the frequency spacing is displayed.
7. Enter the frequency spacing using the rotary knob or arrow keys, then press **nm/ENTER**.
8. Press the **EXECUTE** soft key. The settings entered up to this point are finalized, and the previous menu is displayed allowing setting of the reference wavelength.

The screenshot shows the YOKOGAWA GRID TABLE screen. The main display area contains a table with columns for 'No.', 'UL(nm)', and 'No.'. The table lists 30 rows of wavelength data. Above the table, there are fields for 'START: [1528.7734] nm', 'STOP: [1560.6062] nm', 'SPACING: [50.0] GHz', and 'REFERENCE: 1552.5244 nm'. To the left of the main screen is a vertical menu with soft keys: '500GHz SPACING', '1000GHz SPACING', '50GHz SPACING', '200GHz SPACING', '12.5GHz SPACING', 'CUSTOM', 'REFERENCE WAVELENGTH [1552.5244nm]', 'GRID EDITOR', 'SYSTEM', and 'RETURN'. To the right of the main screen is another vertical menu with soft keys: 'START WL [1528.7734nm]', 'STOP WL [1560.6062nm]', 'SPACING [50.0GHz]', 'VALUE EDIT', 'INSERT', 'DELETE', 'EXECUTE', 'CUSTOM', 'GRID SYSTEM', and 'CANCEL'. Arrows point from the 'CUSTOM' key in the left menu and the 'START WL', 'STOP WL', and 'SPACING' keys in the right menu to their respective labels on the right side of the image.

Setting the Reference Wavelength

9. Press the **REFERENCE WAVELENGTH** soft key. A screen for specifying the standard wavelength is displayed.
10. Enter the standard wavelength using the rotary knob or arrow keys, then press **nm/ENTER**.

Note

- If this Grid Table is edited and then the **CANCEL** key is pressed without pressing the **EXECUTE** key, the edits made to the custom Grid table are canceled.
- Press the **EXECUTE** key to apply the edits in the custom Grid table to the analysis function.

Setting Channel Point Wavelength

- Continuing on from step 3, place the cursor on the channel point you wish to change using the rotary knob, arrow keys, or numeric key pad.
- Press the **VALUE EDIT** soft key. The setting screen for changing the channel point wavelength is displayed.
- Enter the wavelength using the rotary knob or arrow keys, then press **nm/ENTER**.

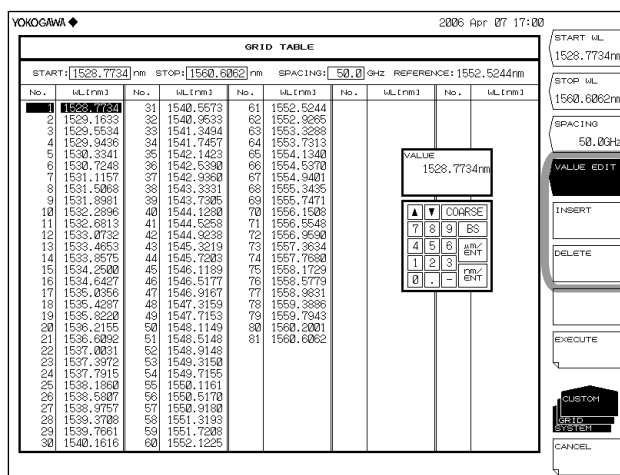

Inserting Channel Points

- Continuing on from step 3, place the cursor on the channel point you wish to insert using the rotary knob, arrow keys, or numeric key pad.
- Press the **INSERT** soft key. A channel point having the same value as the wavelength of the cursor-selected channel point is inserted. Subsequent channel points are shifted down by one point.

Deleting Channel Points

- Continuing on from step 3, place the cursor on the channel point you wish to delete using the rotary knob, arrow keys, or numeric key pad.
- Press the **DELETE** soft key. The channel point at the cursor is deleted. Subsequent channel points are shifted up by one point.

Switching the Units of the Wavelength Axis on the Grid Table to Frequency

- Press **MARKER**.
- Press the **MORE** soft key twice. The MORE 3/3 key menu is displayed.
- Press the **MARKER UNIT** soft key. The marker unit selection menu is displayed.
- Press the **THz** soft key.

Note

For a diagram of soft key operation, see section 5.9, "Displaying Markers."

Explanation

Grid Table

A grid table lists wavelengths (frequencies) that are referenced by part of the analysis function when it is executed. There is a standard Grid table and a custom Grid table.

Standard Grid Table

This Grid table is created with pre-defined wavelength (frequency) ranges. It can be created in the following manner by setting the reference wavelength (frequency) and frequency spacing.

200 GHz SPACING–12.5 GHz SPACING

Creates a grid table with 200 GHz–12.5 GHz grid spacing.

REFERENCE WAVELENGTH

Sets the grid table reference wavelength. This can be set in the range of 1200.0000 to 2400.0000 nm.

Custom Grid Table

Users can edit this Grid table freely.

It is created automatically by setting the start/stop wavelength (frequency), reference wavelength (frequency), and frequency spacing.

Users can add or delete an arbitrary channel to/from the created Grid table or edit wavelength (frequency) values for each channel there.

START WL

Sets the start wavelength.

STOP WL

Sets the stop wavelength.

SPACING

Sets the frequency spacing.

REFERENCE WAVELENGTH

Sets the grid table reference wavelength. This can be set in the range of 1200.0000 to 2400.0000 nm.

VALUE EDIT

You can edit channel points.

Note

For details on the Grid table, see appendix 1, "WDM Wavelength Grid Table."

6.11 Measurement of Level Fluctuations in Single-Wavelength Light (0 nm Sweeping)

Procedure

This function measures changes over time in the level of a specific wavelength level. It is useful for purposes such as optical axis alignment when connecting an optical fiber to a light source. The following discussion pertains to an example in which the spatial light of an He-Ne gas laser (1523.488 nm) is input to an optical fiber.

Setting the Center Wavelength to 1523.488 nm

1. Press **CENTER**. The soft key menu for setting the center wavelength appears.
2. Press the **CENTER WL** soft key. The center wavelength setting screen is displayed.
3. Enter a center wavelength of 1523.488 nm using the rotary knob or numeric key pad.
4. Press **nm/ENTER**.

Setting the Resolution to 2.000 nm

5. Press **SETUP**. The soft key menu for sweep condition settings appears.
6. Press the **RESOLUTION** soft key. The resolution selection menu is displayed.
7. Press the **2.000nm** soft key.
8. Press **nm/ENTER**.

Setting the Sweep Width to 0 nm

9. Press **SPAN**. The soft key menu for setting the sweep width appears.
10. Press the **SPAN WL** soft key. The sweep width setting screen is displayed.
11. Enter a sweep width of 0 nm using the rotary knob or numeric key pad.
12. Press **nm/ENTER**. Set the sweep width to 0 nm. The measurement start wavelength, measurement center wavelength, and measurement stop wavelength are all set to 1523.488 nm.

Setting the Sweep Time

13. Press the **0 nm SWEEP TIME** soft key. A screen for specifying the sweep time is displayed.
14. Enter a numerical value using the rotary knob or numeric key pad, then press **nm/ENTER**.
15. Press **SWEEP**, followed by the **REPEAT** soft key. Sweeping begins.

6.11 Measurement of Level Fluctuations in Single-Wavelength Light (0 nm Sweeping)

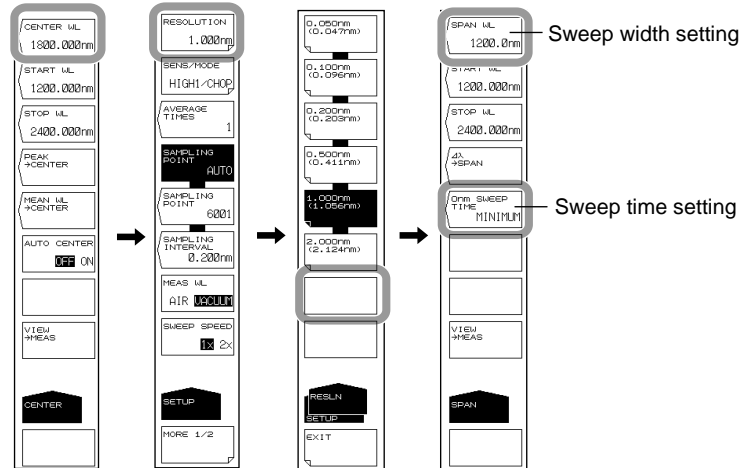

Note

- When the sweep range is set to 0 nm, the horizontal axis is set as the time axis as a result.
- The sweeping time varies depending on the measurement sensitivity (SENS/MODE soft key under SETUP). If the setting for this key is less than the sweeping time for each sensitivity, the setting for the key is invalid and the MINIMUM setting is used.

Explanation

The following is the structure in which the spatial light of an He-Ne gas laser (1523.488 nm) is input to an optical fiber.

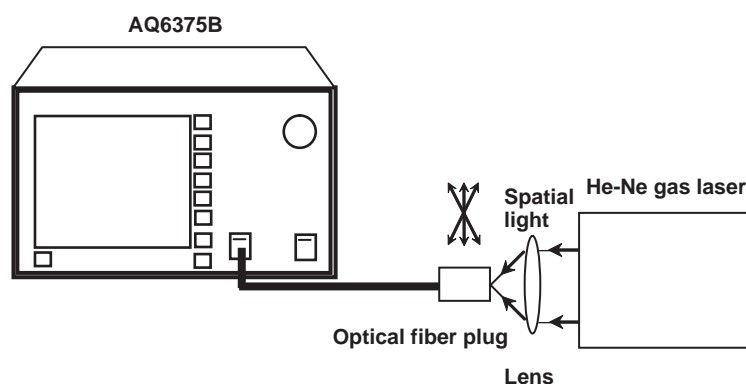

The sweep width is set to 0 nm, the center wavelength is fixed, and measurement of the single-wavelength light only is taken. Finely adjust the optical fiber plug while observing the displayed waveform so as to set the light source input level to the peak.

0nm SWEEP TIME

When the sweep width is 0 nm, the horizontal axis is set as the time axis. The time required to measure from the left edge to the right edge of the screen is set. The allowed settings are MINIMUM and the range of 1 to 50 s. The value changes in 1 s steps.

If you press the COARSE key, you can change the setting in 1-2-5 steps.

If 0 is entered, MINIMUM is shown on the display. Also, the sweeping time varies depending on the measurement sensitivity (SENS/MODE soft key under SETUP). If the setting for this key is less than the sweeping time for each sensitivity, the setting for the key is invalid and the MINIMUM setting is used. The sampling points are automatically set to 1001.

6.12 Go/No-Go Judgment (Template)

Procedure

This function compares preset reference data (template data) with a measured waveform, and makes a Go/No-Go judgment.

Creating Template Data on the Instrument

1. Press **ADVANCE** followed by the **TEMPLATE** soft key.
2. Press the **TEMPLATE EDIT** soft key. The template creation screen is displayed.
3. Press the **LINE SELECT** soft key.
4. Press the soft key corresponding to the type of template you wish to create.
UPPER LINE: Upper limit line
LOWER LINE: Lower limit line
TARGET LINE: Target value line
5. Press the **MODE ABS/REL** soft key to select either ABS (absolute) or REL (relative) as the type (template data types).
6. Press the **EXTRAPOL TYPE** soft key to select the extrapolation method.
TYPE A: Extrapolation type A
TYPE B: Extrapolation type B
NONE: No extrapolation
7. To edit template data, move the cursor to the location of the data to be edited using the rotary knob or arrow keys, then press the **VALUE EDIT** soft key. Enter a value using the numeric key pad, rotary knob, or arrow keys.
8. To add template data, press the **INSERT** soft key. The data at the cursor location is added. Edit the value using the procedure in step 7 and set it as new data.
9. To delete template data, move the cursor to the location of the data to be deleted using the rotary knob or arrow keys, then press the **DELETE** soft key. To delete all template data points, press the **ALL DELETE** soft key.

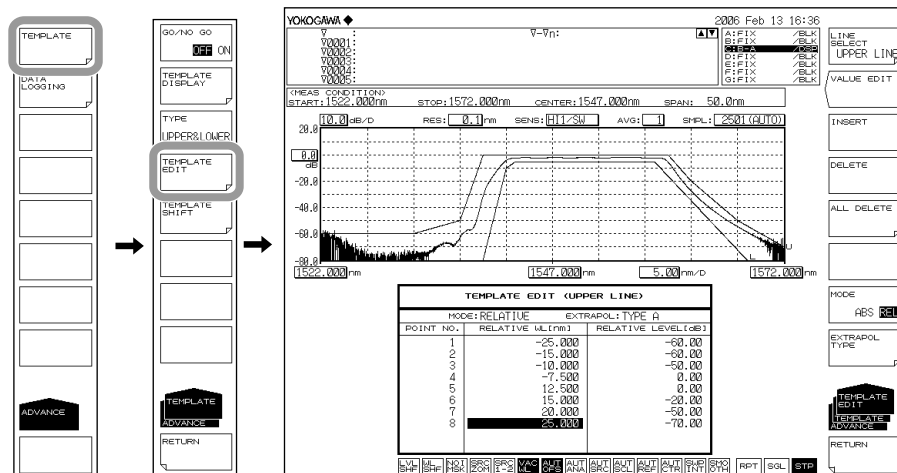

Note

- For information about extrapolation methods, see the explanation.
- The same wavelength/level data prior to insertion are inserted as data in the points that were inserted using the INSERT soft key.
- When the target line is turned OFF with the TEMPLATE DISPLAY soft key, if you edit the template data at the target line, the target line TEMPLATE DISPLAY turns ON.

Executing Go/No Go Judgment

1. After creating or loading template data, press **ADVANCE** followed by the **TEMPLATE** soft key.
2. Press the **TYPE** soft key. The judgment condition setting menu is displayed.
3. Press the **UPPER**, **LOWER**, or **UPPER & LOWER** soft key once.
4. Press the **RETURN** soft key. The screen returns to the previous stage.
5. Press the **GO/NO GO** soft key to select ON. The judgment results are displayed on screen as PASS or FAIL.

Loading Template Data

Load template data on the instrument.

1. Press **FILE**, followed by the **ITEM SELECT** soft key. The soft key menu for selecting the data type appears.
2. Press the **MORE 1/2** soft key, then press the **TEMPLATE** soft key.
3. Press the **READ** soft key.
4. Press the **FILE -> @@@@** soft key. The load target line selection menu is displayed (where @@@@ is the currently set contents).
5. Press the **UPPER LINE**, **LOWER LINE**, or **TARGET LINE** soft key once. The screen returns to the previous stage.
6. Move the cursor to the template data file to load from the file list, then press the **EXECUTE** soft key.

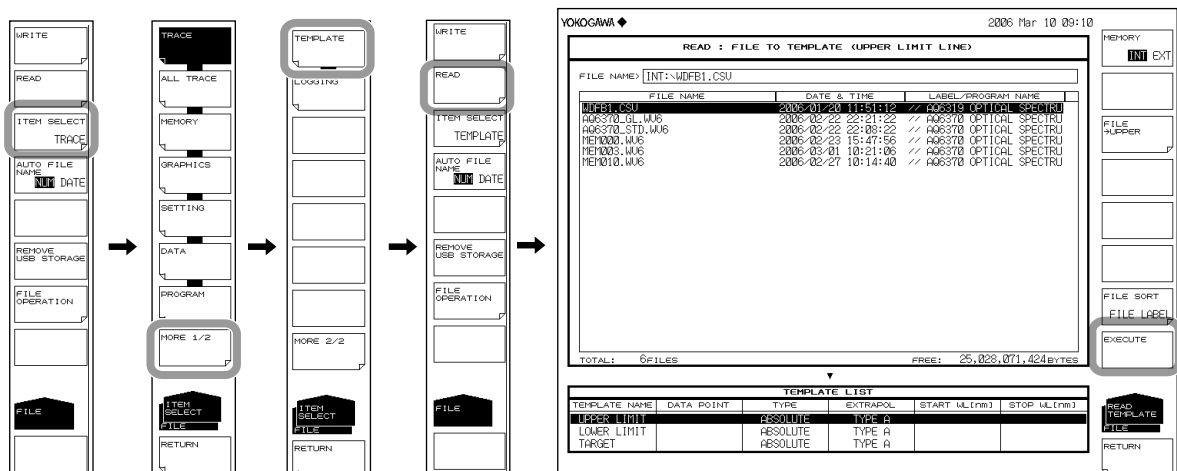

Template Data Types

The following types of template data are available.

- CSV (comma delimited) files created on an external PC
- Waveform files of the instrument (.CSV or .BIN files)

Note

- After loading data, WL SHIFT and LVL SHIFT in the template are set to zero.
- For information about data formats when creating template data on an external PC, see the Explanation subsection.

Setting the Shift Amount and Shifting the Template

The template data wavelength/level can be shifted without changing the template data. The procedure for doing this is shown below.

1. Press **ADVANCE** followed by the **TEMPLATE** soft key.
2. Press the **TEMPLATE SHIFT** soft key. The shift item selection menu is displayed.
3. To shift the wavelength, press the **WL SHIFT ****.***nm** soft key. To shift the level, press the **LEVEL SHIFT **.*dB** soft key.
4. Enter a shift amount using the rotary knob, arrow keys, or numeric key pad.

Note

- Use of this function does not change the template data.
- Use of this function does not query the template type. Both absolute and relative are supported.
- Shifts set by this function apply to all three line types (UPPER LIMIT LINE, LOWER LIMIT LINE, AND TARGET LINE). To shift just one line, edit the template data.

Switching Absolute and Relative Value, and Shifting the Template

This function shifts the wavelength/level based on the template data ABSOLUTE/RELATIVE switching function. The template data themselves can be shifted by changing the ZOOM CENTER WL or REF LEVEL.

The following settings are an example.

- ZOOM CENTER WL: 1547.000 nm
- REF LEVEL: 0.00 dBm

Creating a Template in ABSOLUTE Mode

TEMPLATE EDIT (UPPER LINE)		
MODE: ABSOLUTE		EXTRAPOL: TYPE A
POINT NO.	ABSOLUTE WL [nm]	ABSOLUTE LEVEL [dB]
1	1522.000	-60.00
2	1532.000	-60.00
3	1537.000	-50.00
4	1539.500	0.00
5	1559.500	0.00
6	1562.000	-20.00
7	1567.000	-50.00
8	1572.000	-50.00

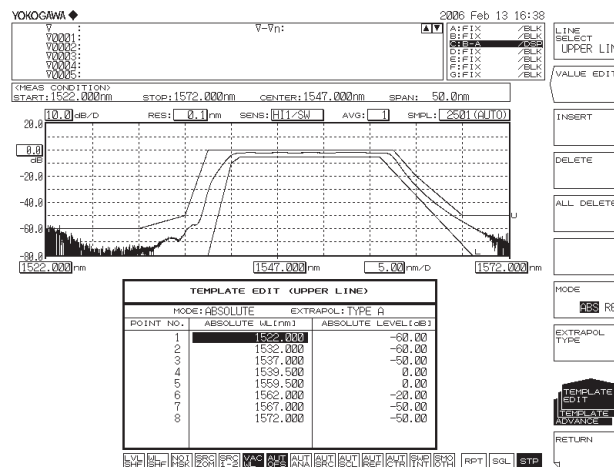

Switching to RELATIVE Mode

1. Press **ADVANCE** followed by the **TEMPLATE** soft key.
2. Press the **TEMPLATE EDIT** soft key. The edit menu is displayed.
3. Press the **MODE ABS/REL** soft key to select **REL**. The instrument enters Relative mode.

TEMPLATE EDIT (UPPER LINE)		
MODE: RELATIVE		EXTRAPOL: NONE
POINT NO.	RELATIVE WL [nm]	RELATIVE LEVEL [dB]
1	-25.000	-60.00
2	-15.000	-60.00
3	-10.000	-50.00
4	-7.500	0.00
5	12.500	0.00
6	15.000	-20.00
7	20.000	-50.00
8	25.000	-50.00

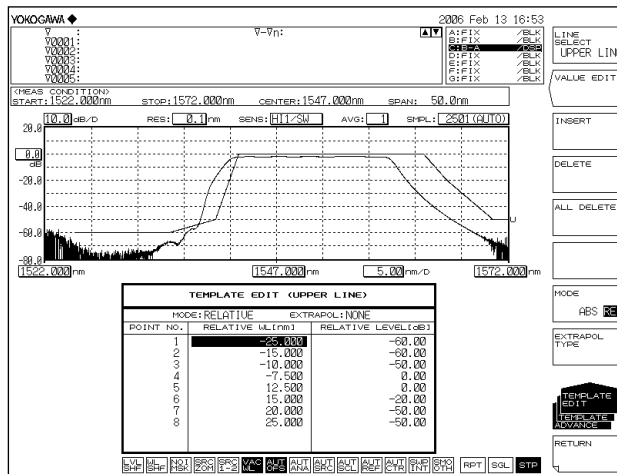

Changing ZOOM CENTER WL and REF LEVEL

- ZOOM CENTER WL: 1544.000 nm
 - REF LEVEL: 10.00 dBm
4. Press **ZOOM**, followed by the **ZOOM CENTER WL** soft key.
 5. Enter 1544.000 using the rotary knob or arrow keys, then press **nm/ENTER**.
 6. Press **LEVEL**, followed by the **REF LEVEL** soft key.
 7. Enter 10.00 using the rotary knob or arrow keys, then press **nm/ENTER**.

TEMPLATE EDIT (UPPER LINE)		
MODE: RELATIVE		EXTRAPOL: NONE
POINT NO.	RELATIVE WL [nm]	RELATIVE LEVEL [dB]
1	-25.000	-60.00
2	-15.000	-60.00
3	-10.000	-50.00
4	-7.500	0.00
5	12.500	0.00
6	15.000	-20.00
7	20.000	-50.00
8	25.000	-50.00

The template relative value does not change after editing.

6.12 Go/No-Go Judgment (Template)

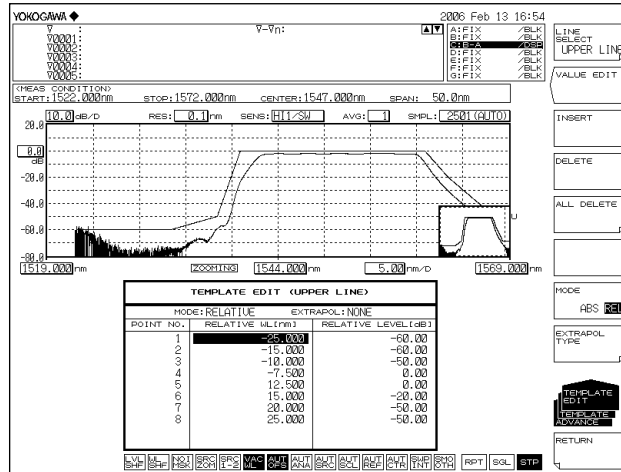

Switching to ABSOLUTE Mode

8. Press **ADVANCE** followed by the **TEMPLATE** soft key.
9. Press the **TEMPLATE EDIT** soft key. The edit menu is displayed.
10. Press the **MODE ABS/REL** soft key, then select **ABS**. The instrument enters Absolute mode.

TEMPLATE EDIT (UPPER LINE)		
MODE: ABSOLUTE		EXTRAPOL: NONE
POINT NO.	ABSOLUTE W[L][nm]	ABSOLUTE LEVEL[dB]
1	1519.000	-60.00
2	1529.000	-60.00
3	1534.000	-50.00
4	1536.500	0.00
5	1556.500	0.00
6	1559.000	-20.00
7	1564.000	-50.00
8	1569.000	-50.00

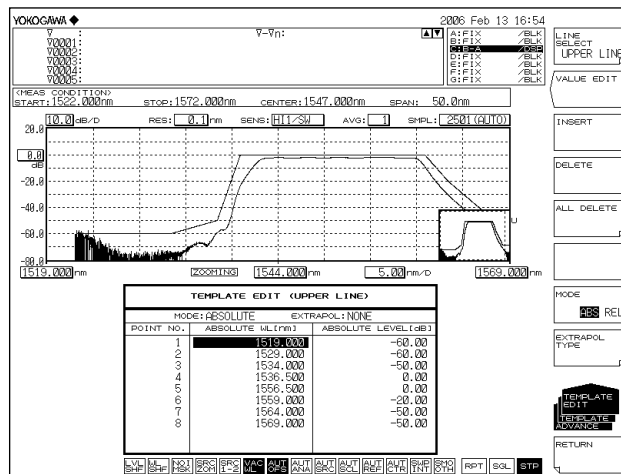

The results and template are shifted 3 nm to the left on screen.

Turning the Template Data Display ON/OFF

1. Press **ADVANCE** followed by the **TEMPLATE** soft key.
2. Press the **TEMPLATE DISPLAY** soft key. The display ON/OFF switch menu is displayed.
3. Press the soft keys for each of the three lines (**UPPER LINE DISPLAY**, **LOWER LINE DISPLAY**, and **TARGET LINE DISPLAY**), and select ON or OFF. The selection changes each time you press the key.

Note

If the GO/NO GO soft key is set to ON, a Go/No Go test is performed according to the test type, even if the TEMPLATE DISPLAY soft key indicator is set to OFF.

Explanation

Go/No Go Judgment

The following are the three types of template.

- Upper limit line
- Lower limit line
- Target line

Upper and lower limit lines are used for Go/No Go judgment. For target line only, the function displays the targeted spectrum on the measurement screen without comparing it to the measured waveform.

Upper Limit Line Judgment

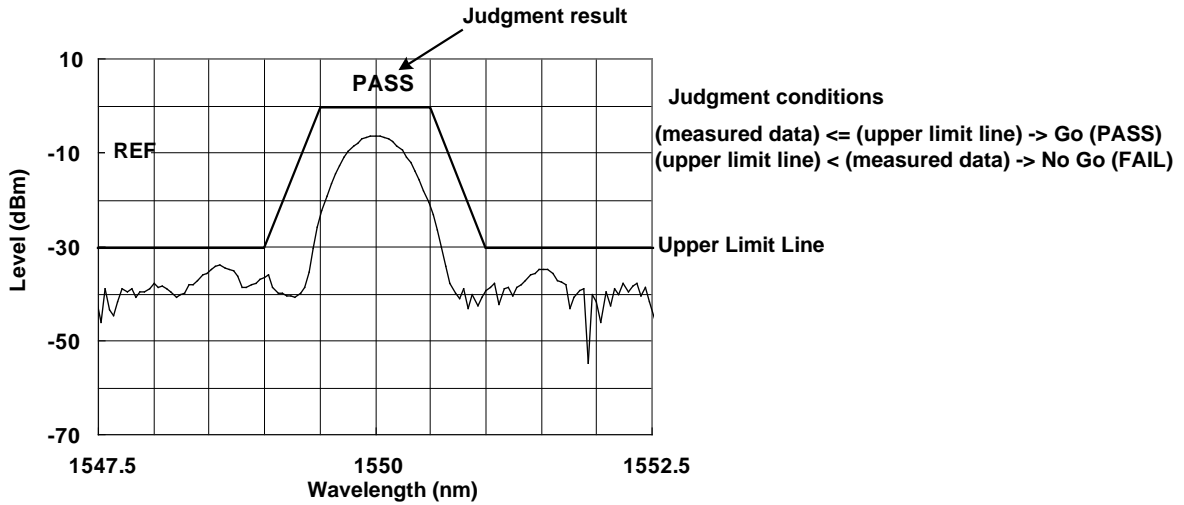

Lower Limit Line Judgment

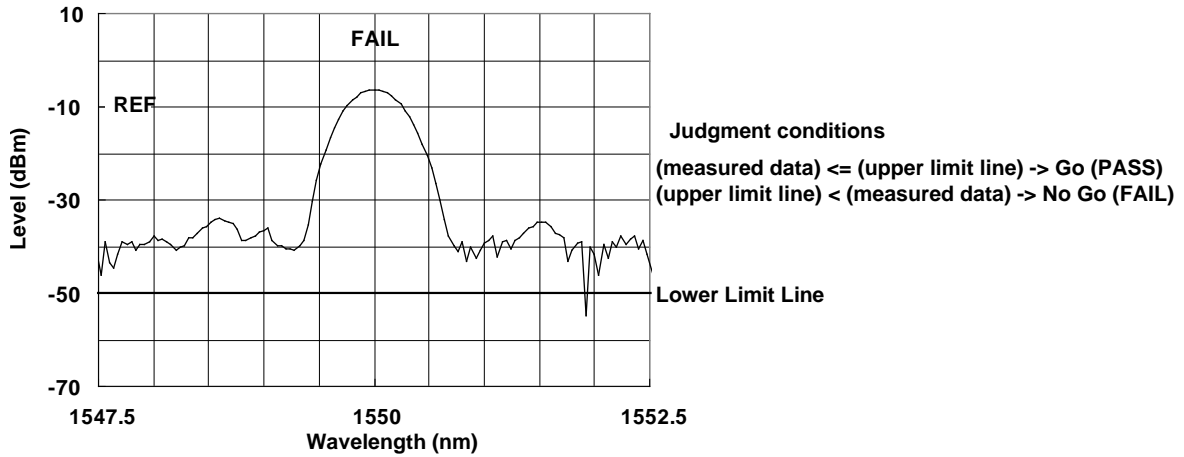

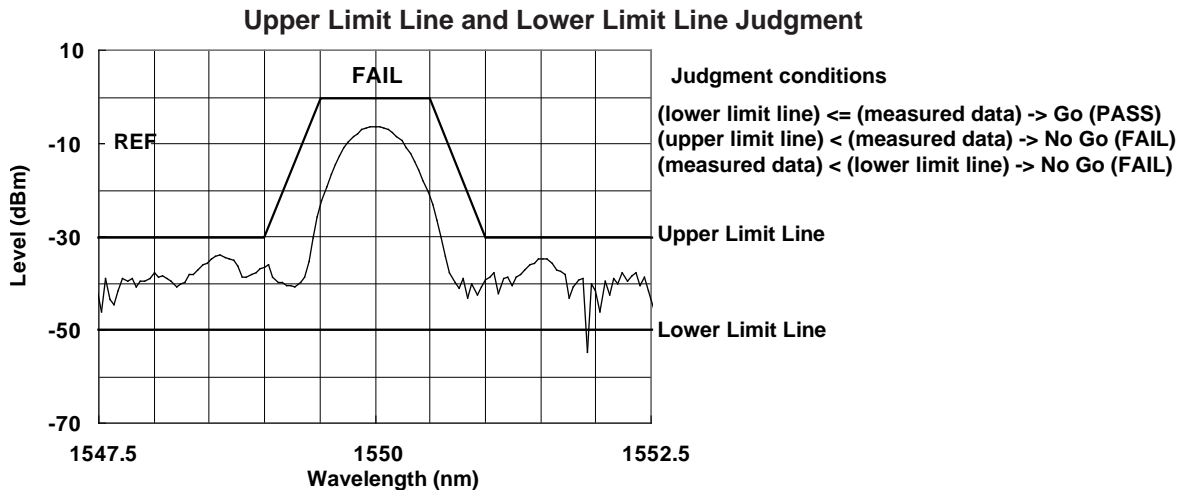
**Note**

- Go/No Go judgment is executed within the wavelength range shown on the screen.
- During execution, the line marker search (<SEARCH/ANA L1-L2> key) and zoom area search function (<SEARCH/ANA ZOOM AREA> key) are enabled.

Target Line

The target line function displays the targeted spectrum on the measurement screen without comparing it to the measured waveform.

This function can be used for displaying and adjusting the target spectrum serving as a reference for adjustments such as adjusting the optical axis of an optical device.

Target Line Display

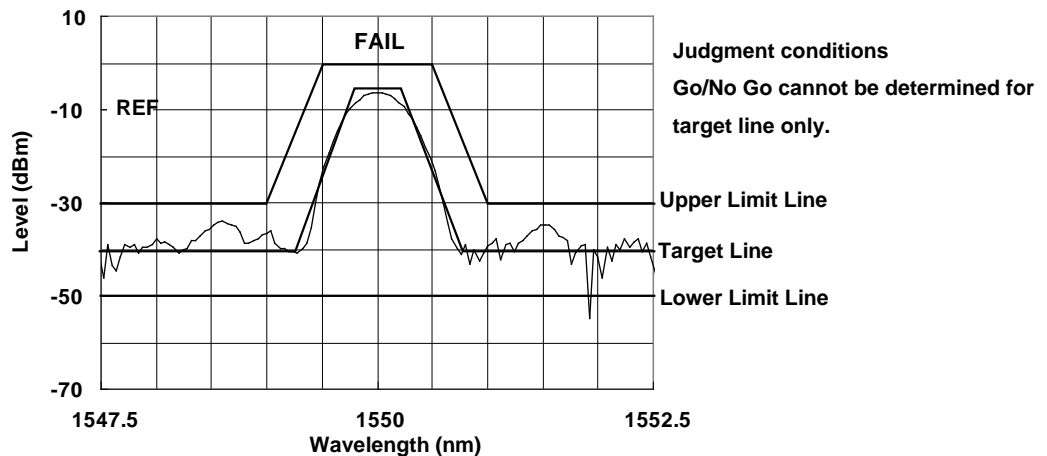

Template Data

- Template data consist of wavelength and level data. Up to 50,001 points of data may be defined.
- An upper limit, lower limit, and target line can be set.
- The on-screen template data display range and the Go/No Go test function execution range follow the display scale wavelength range.

Relationship between Go/No Go Judgment and Wavelength Range

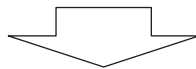
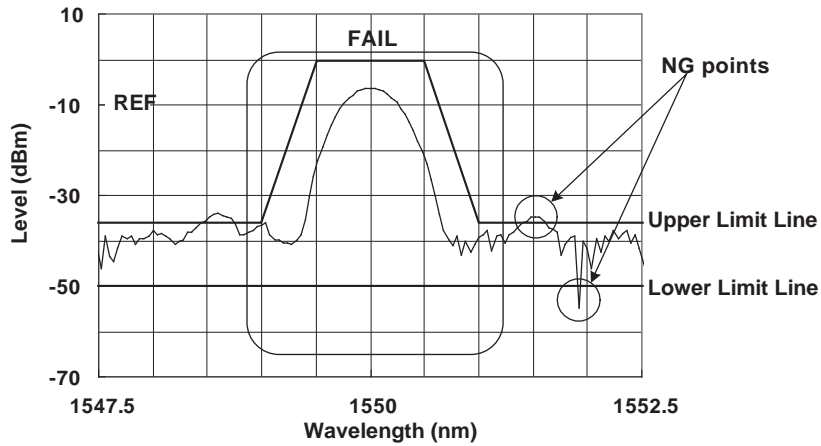

If the waveform is zoomed and the NG point is outside the displayed range, the judgment result is PASS.

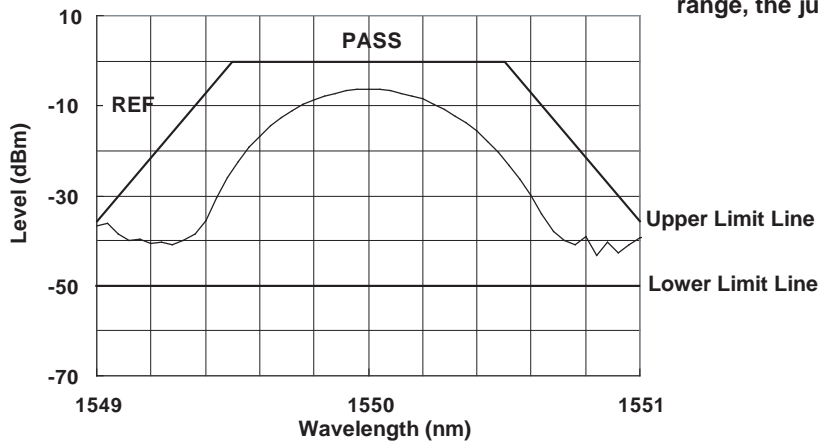

Note

When performing Go/No Go judgment, display the wavelength range on the screen. The Go/No Go testing process is not performed on wavelength ranges that are not displayed.

Template Data Types

ABSOLUTE Templates

ABSOLUTE template data specify both wavelengths and levels as absolute values. The waveform and template data change in conjunction with changes to the center wavelength or display sweep width on the display scale.

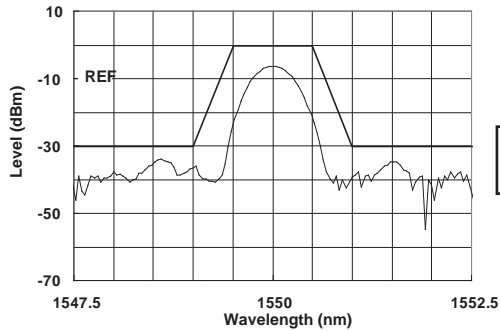

When ZOOM CENTER WL = 1550 nm

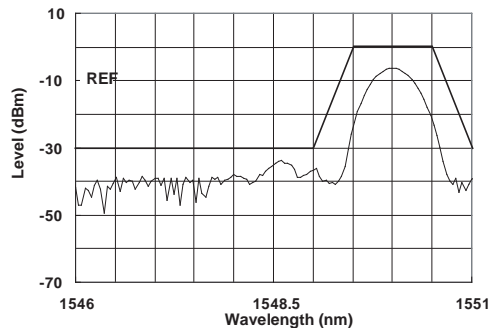

When ZOOM CENTER WL is changed to 1548.5 nm
(template also moves in synch with the waveform)

RELATIVE Templates

RELATIVE template data are specified as relative values with respect to the display scale. These template data are fixed to the scale position even if the center wavelength or display sweep width of the display scale is changed (not linked to the waveform).

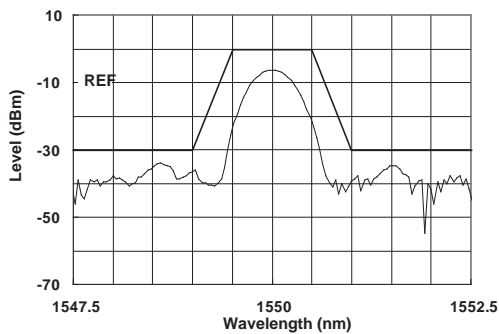

When ZOOM CENTER WL = 1550 nm

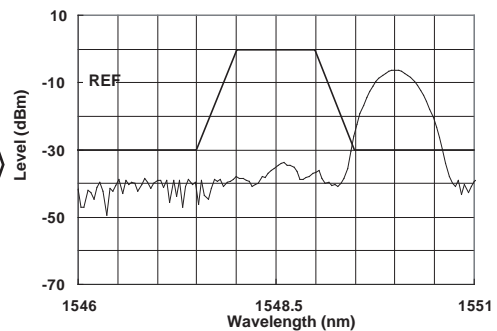

When ZOOM CENTER WL is changed to 1548.5 nm
(template not moved)

Extrapolating Template Data

In cases where the display scale is outside the defined range for template data, the template data outside the range can be extrapolated.

The following three types of extrapolation are available in these situations.

- Type A Extends the outermost data point of the template data to the outside.
- Type B Extends, to the outside, a line joining the outermost template data and the adjacent data point.
- None No extrapolation.

For Type A and Type B

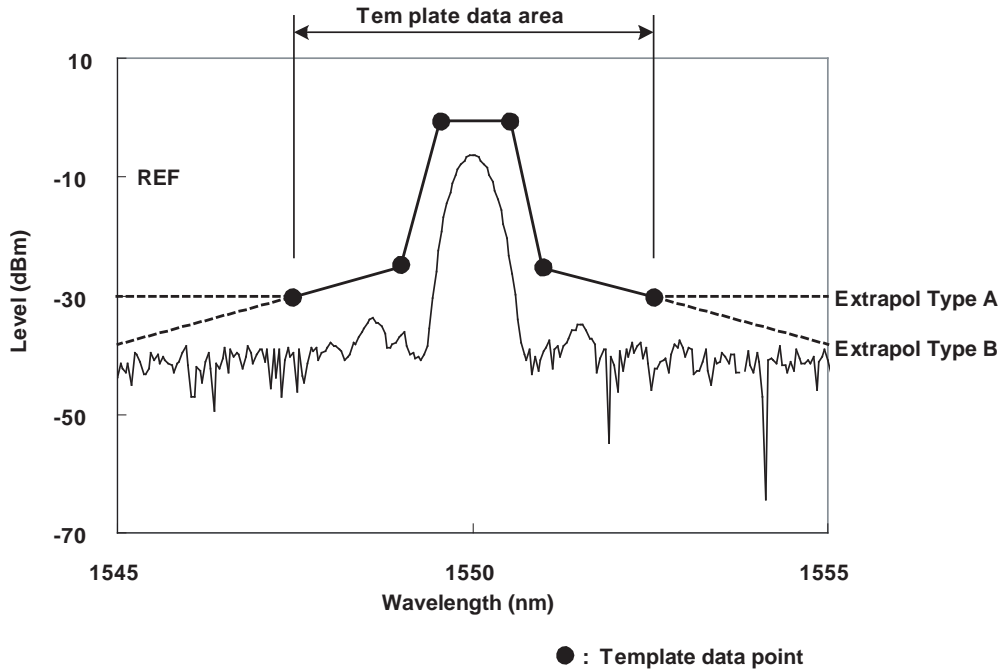

For Extrapolation Type of None

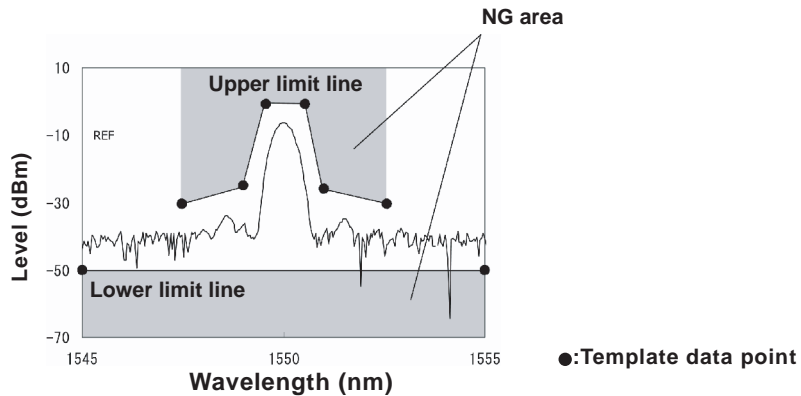

Note

- Data created through extrapolation is limited by the LOG LIMIT setting.
- For templates set to None, the Go/No Go judgment range from the template can be narrower than the waveform display screen. Pay attention to the judgment execution ranges for the upper limit and lower limit lines.

Template Data Format

The file extension for template data file names is always .CSV.

The template data format is shown below. Here, all capital letters are used. As many as 50,001 template data points can be defined.

Save the template data created on an external PC to a USB storage device for loading in the instrument.

	A	B
1	AQ6375B	
2	TEMPLATE	
3	TYPE	ABSOLUTE
4	EXTRAPOL	A
5	1540.000	-20.00
6	1550.000	-10.00
7	1560.000	-20.00

<- Header for the AQ6375B

<- Header indicating template data

<- Header indicating the template type (ABSOLUTE or RELATIVE)

<- Extrapolation type (A or B or None)

<- Wavelength and level data (1550.123, -20.00)

Up to 50001 points of data sorted in order starting from the data of the smallest wavelength

.CSV file containing the above template data

```
AQ6375B,
TEMPLATE,
TYPE,ABSOLUTE
EXTRAPOL,A
1540.000,-20.00
1550.000,-10.00
1560.000,-20.00
```

Note

- Only English capital letters and numbers are supported for all template data.
- Like normal templates, template data can contain up to 50001 points.
- The .CSV extension must be used when saving.
- If the format is not unified, the instrument will not be able to load the template data.

6.13 Specifying an Analysis Range

Analysis between Line Markers

Power Measurement between Line Markers

You can determine the totalized power for the area enclosed by wavelength line marker 1 and wavelength line marker 2.

1. Set wavelength line marker 1 and wavelength line marker 2 at either end of the range where you want to measure the totalized power.
2. Press the **MARKER** switch. The soft key menu for marker settings appears.
3. Press the **MORE 1/3**, **MORE 2/3** soft keys in succession.
4. Press the **SEARCH/ANA L1-L2** soft key, and select ON. When this key is set to ON, **SRC 1-2** is displayed at the very bottom of the screen.
5. Press **ANALYSIS**. The soft key menu for analyzing measured waveforms appears.
6. Press the **ANALYSIS 1** soft key. The analysis function selection menu is displayed.
7. Press the **POWER** soft key. Analysis is performed between line markers, and the results are displayed in the data area.
8. To cancel, press the **SEARCH/ANA L1-L2** soft key, and select OFF. Analysis is performed over the entire screen.

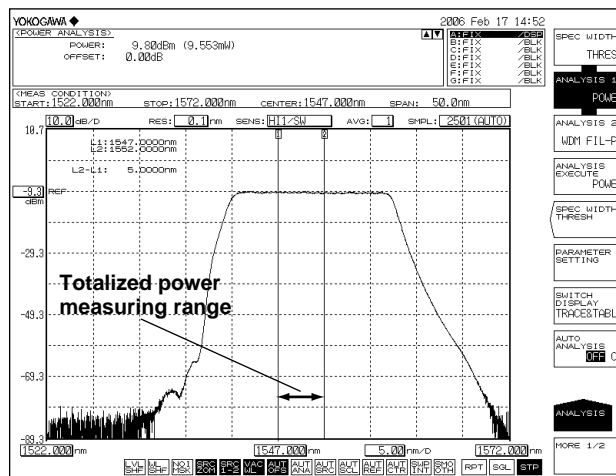

Note

- If both L1 and L2 are set, measurement is executed between line markers 1 and 2.
- If just L1 is set, the measurement occurs over the span from line marker 1 to the right edge of the screen.
- If just L2 is set, the measurement occurs over the span from the left edge of the screen to line marker 2.
- If neither L1 nor L2 is set, measurement is performed from the set start wavelength to the stop wavelength.

Analysis in the Zoom Area

Power Measurement in the Zoom Area

Optical power can be measured by integrating the measured waveform level measurements in the zoom area.

1. Zoom in on the measured waveform. Set the range you want to measure to the display scale. For the procedure on zooming in on the waveform, see section 5.1, "Zooming In/Out on a Waveform."
2. Press the **MARKER** switch. The soft key menu regarding the markers appears.
3. Press the **MORE 1/3**, **MORE 2/3** soft keys in succession.
4. Press the **SEARCH/ANA ZOOM AREA** soft key, and select ON.

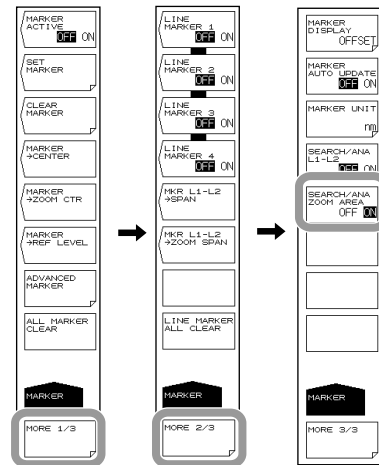

5. Press **ANALYSIS**. The soft key menu for analyzing measured waveforms appears.
6. Press the **ANALYSIS 1** soft key. The analysis function selection menu is displayed.
7. Press the **POWER** soft key. Analysis is performed between display scales, and the results are displayed in the data area.

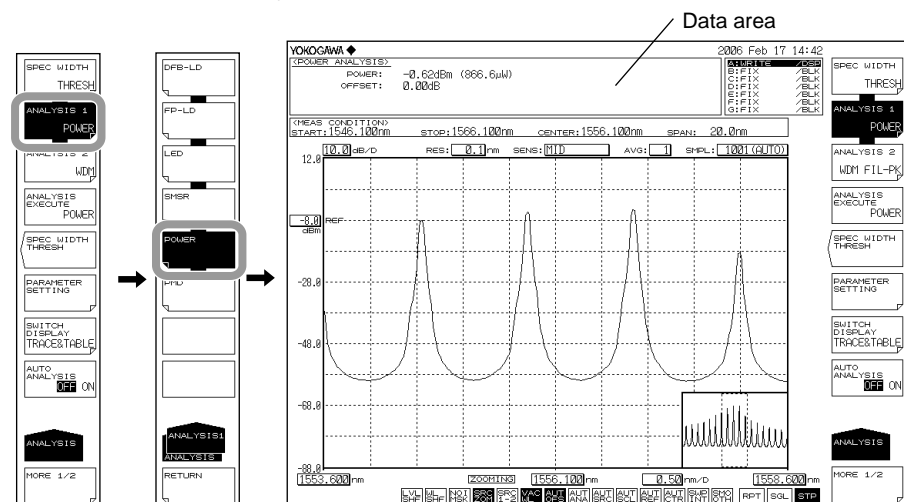

Note

- When the zoom area search function is enabled, **SRC ZOM** is displayed in inverse video.
- If the SEARCH/ANA ZOOM AREA key is OFF, analysis is performed over the entire range of the measurement scale.
- For details on the POWER analysis function, see appendix 3, "Details of Analysis Functions."

6.13 Specifying an Analysis Range

Explanation

When the line marker search function and zoom area search functions are enabled at the same time, the intersection of the two ranges is the range for analysis.

The following shows the POWER measurement analysis range when both the **SEARCH/ANA L1-L2** and **SEARCH/ANA ZOOM AREA** soft keys are ON.

As both of these soft keys are ON, **[SRC]** and **[ZOM]** at the bottom of the screen are displayed in inverse video.

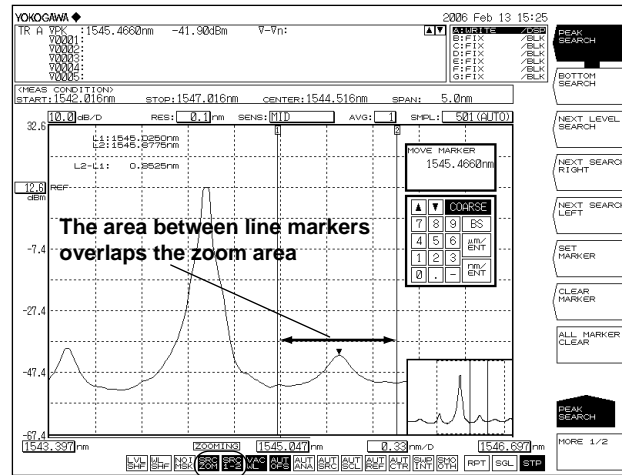

6.14 Correcting Displayed Values

Procedure

Setting the Wavelength Shift Amount

1. Press **SYSTEM**.
2. Press the **WL SHIFT** soft key. The wavelength shift setting screen is displayed.
3. Enter a wavelength shift amount using the rotary knob, arrow keys, or numeric key pad.
4. Press **ENTER**.

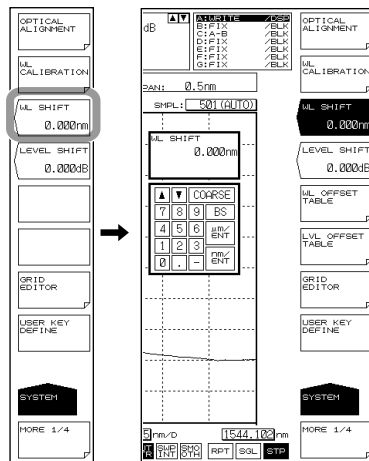

Setting the Level Shift Amount

1. Press **SYSTEM**.
2. Press the **LEVEL SHIFT** soft key. The level shift setting screen is displayed.
3. Enter a level shift amount using the rotary knob, arrow keys, or numeric key pad.
4. Press **ENTER**.

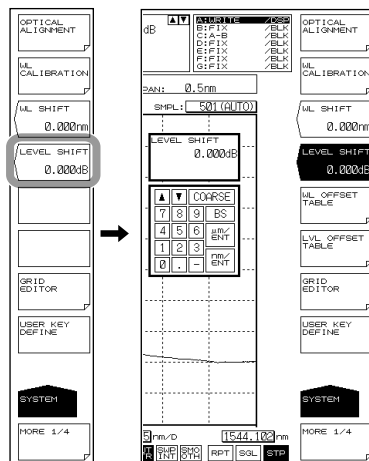

Note

After entering the wavelength or level shift amount, the setting is applied to the displayed values upon the next measurement.

Determining the Level Shift Amount

Even if NA of the optical fiber used is unknown, the level shift amount enabling correct level measurements can be determined.

1. Set up a light source such as a DFB-LD with a spectrum width that is narrower than the instrument's resolution (with a wavelength of 1310 nm or 1550 nm).
2. Connect the light source and the instrument using an optical fiber cord and set the instrument's resolution to 2.000 nm.
3. Execute measurement and determine the peak level.
4. Disconnect the optical fiber cord from the instrument and connect it to a light power meter to measure the light power.
5. Calculate the difference between the peak level value obtained from the instrument and the power value obtained from the light power meter, and set this amount as the instrument's level shift.

Explanation

Input Optical Fiber Numerical Aperture (NA) and Level Measurement Values

The level measurement error of the instrument changes as shown in the figure below, according to the numerical aperture (NA) of the optical fiber connected to the input connector. The instrument's absolute level is calibrated using a 9.5/125 μm single-mode optical fiber (SSMA type in JIS C6835, with PC polishing, 9.5 μm mode field diameter, and 0.104 to 0.107 NA). Even if a single-mode optical fiber is used, the level accuracy will be outside the specifications if the NA is not in the range shown above.

Input optical fiber numerical aperture and level error (typical characteristics)

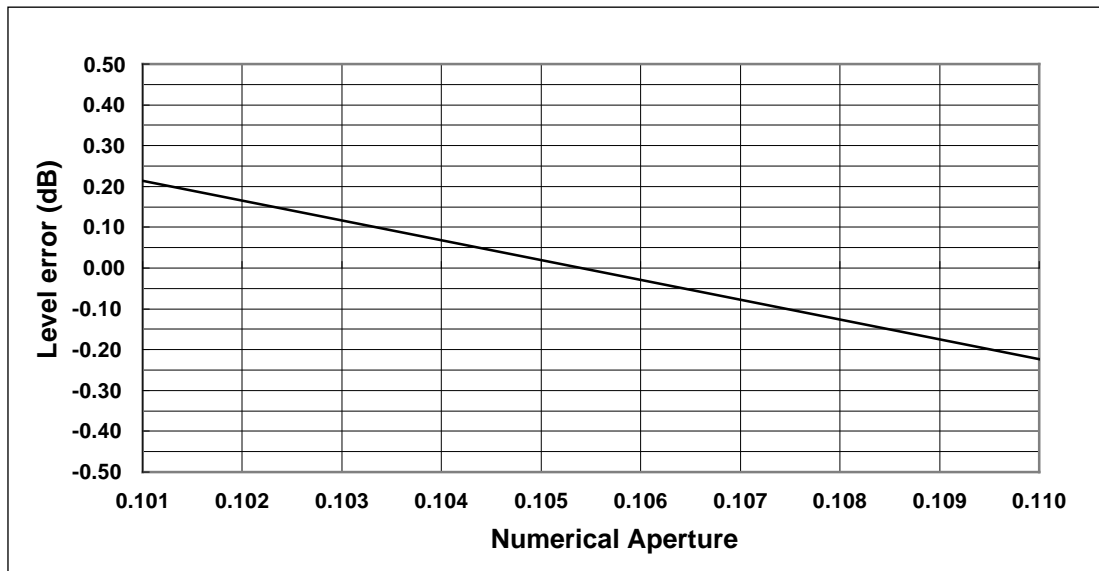

Absolute Level Accuracy

The instrument's absolute level is calibrated with a 9.5 μm single-mode optical fiber. In terms of actual capability, even single-mode optical fibers that do not have a core diameter of 9.5 μm provide nearly the same level of accuracy.

Multimode (GI) fiber provides a relatively accurate spectrum if the light source is low-coherent light such as white light, natural light, or an LED. If the light source has high coherency as in the case of a laser beam, interference will occur inside the optical fiber, and the intensity distribution of light radiating from the fiber tip will vary according to the fiber form. As a result, the spectrum (measurement level) may fluctuate if the fiber is moved.

When an optical fiber with a large core diameter or large NA value is used, a low fraction of the light emitted from the optical fiber is received. Therefore, the measurement level is lower than the true value, but the optical spectrum is accurate in relative terms.

WL SHIFT **. **nm

This key is used to set the wavelength shift.

When the wavelength shift is changed, the set value is added to the display value on the wavelength axis. This key is used for purposes such as correcting differences in wavelength display values among different measurement instruments.

The setting range is -5.000 to 5.000 nm. Settings can be adjusted in steps of 0.001 nm.

The value changes in steps of 0.1 nm if you press the COARSE key.

When setting the wavelength shift amount,  is displayed at the bottom of the screen in inverse video.

LEVEL SHIFT***.***dB

This key is used to set the level shift.

When the level shift is changed, the set value is added to the display value on the level axis.

This key is used for purposes such as correcting level errors due to differences in the NA values of 9.5/125 μm SM optical fibers connected to the instrument, and correcting loss on externally connected isolators, filters and the like.

The setting range is -60.00 to 60.00 dB. Settings can be adjusted in steps of 0.01 dB.

The value changes in steps of 0.1 dB if you press the COARSE key.

When setting the wavelength shift amount,  is displayed at the bottom of the screen in inverse video.

6.15 Analysis Data Logging

Procedure

The analysis data logging function measures and records WDM analysis, DFB-LD analysis, and peak data at regular intervals and displays the data in tables and graphs on the screen. The contents in the table and the optical spectrum data of each measurement can be saved to files.

Logging Screen

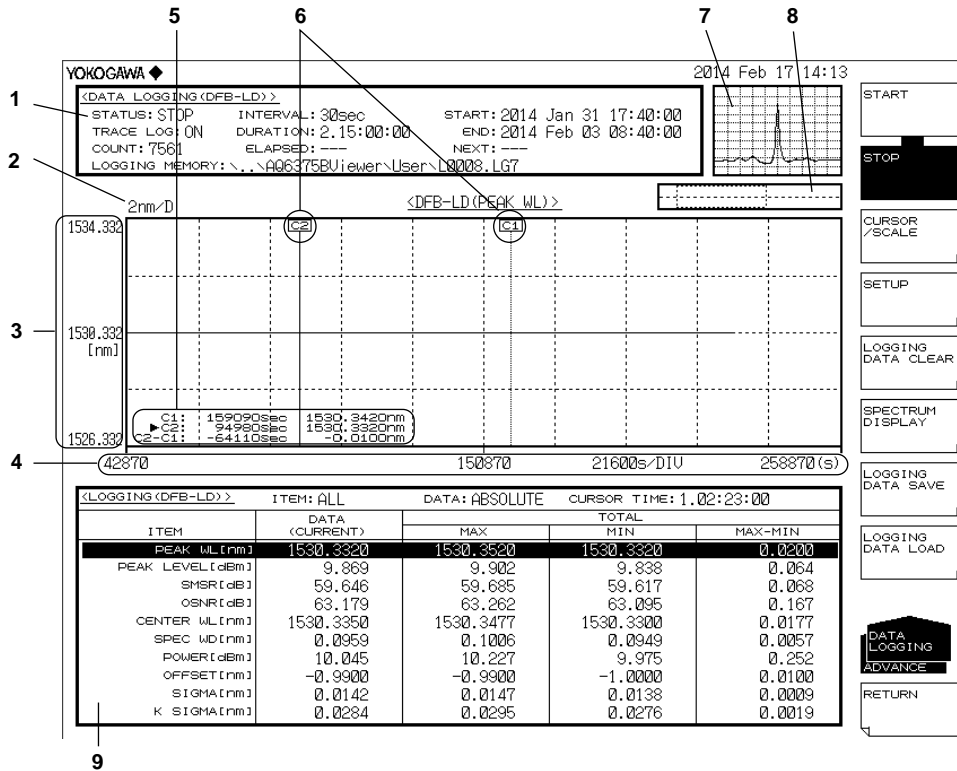

- | Number | Function |
|--------|--|
| 1 | Parameter display area |
| 2 | Wavelength scale (per division) |
| 3 | Displays different scales depending on the displayed item, such as wavelength, power, and SNR. |
| 4 | Time scale |
| 5 | Cursor information (C1, C2, C2-C1) |
| 6 | Cursors (C1, C2) |
| 7 | Thumbnail area. Displays the waveform data at the current cursor position. |
| 8 | Overview display. The current graph area is indicated with a dotted frame. |
| 9 | Logging data list |

Setting the Data Logging Conditions

• Setting the Logging Parameters

1. Press **ADVANCE** and then the **DATA LOGGING** soft key. The soft key menu for data logging appears.
2. Press the **SETUP** soft key. A menu for setting the data logging conditions appears.
3. Press the **LOGGING PARAMETER** soft key. The logging parameter setting screen appears.
4. Move the cursor using the arrow keys or soft keys, and enter the value using the numeric keypad.

To select a check box, align the cursor, and then press the **SELECT** soft key.

5. Press the **CLOSE WINDOW** soft key. The logging parameter setting screen closes, and the soft key menu returns to the previous level.

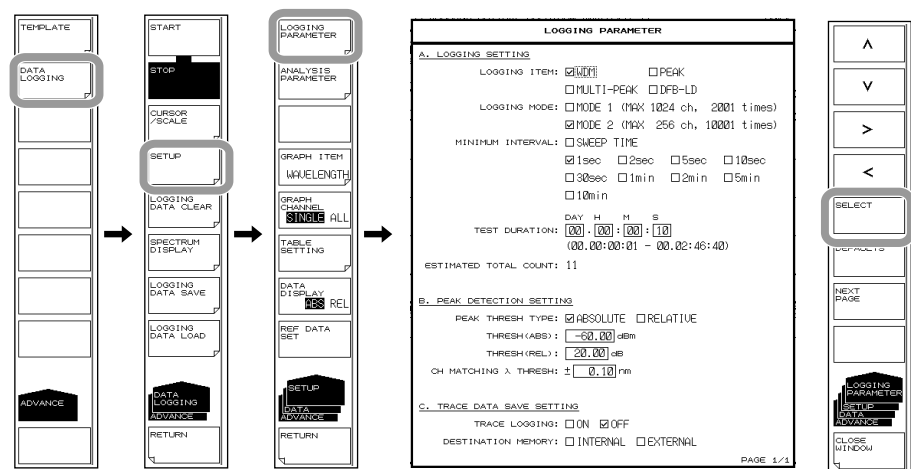

Note

The LOGGING PARAMETER soft key cannot be used while logging measurement is in progress.

Setting the Analysis Conditions

1. Press **ADVANCE** and then the **DATA LOGGING** soft key. The soft key menu for data logging appears.
2. Press the **SETUP** soft key. A menu for setting the data logging conditions appears.

When the Logging Item Is WDM

3. Press the **ANALYSIS PARAMETER** soft key. The WDM analysis parameter setting screen appears.

For the operating procedure, see steps 4 to 6 in “When changing the analysis parameters” of section 6.7.

For parameter descriptions, see section 6.7.

If you change a parameter, the value specified in section 6.7 will also change (because the parameter is shared).

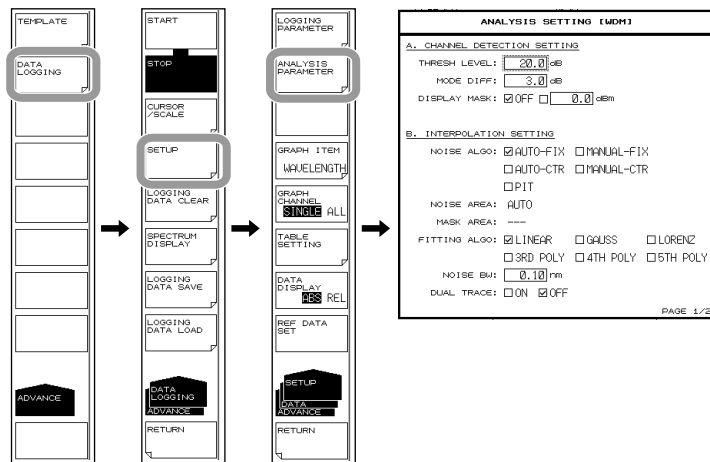

When the Logging Item Is PEAK

- **Setting the Minimum Peak/Bottom Difference of the Mode Judgment Reference**
 3. Press the **ANALYSIS PARAMETER** soft key. The menu for detecting peak values is displayed.
 4. Press the **MODE DIFF** soft key. The screen for setting the mode judgment reference is displayed.
 5. Enter the mode judgment reference using the rotary knob, arrow keys, or numeric keypad.
 6. Press **nm/ENTER**.

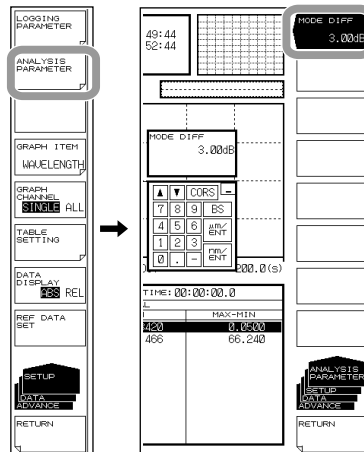

Note

- For a description of the mode judgment reference, see “MODE DIFF” in section 5.12.
- If you change a setting, the value specified in section 5.12 will also change (because the parameter is shared).

When the Logging Item Is MULTI-PEAK

- **Setting the Minimum Peak/Bottom Difference of the Mode Judgment Reference**
 3. Press the **ANALYSIS PARAMETER** soft key. The menu for detecting peak values is displayed.
 4. Press the **MODE DIFF** soft key. The screen for setting the mode judgment reference is displayed.
 5. Enter the mode judgment reference using the rotary knob, arrow keys, or numeric keypad.
 6. Press **nm/ENTER**.

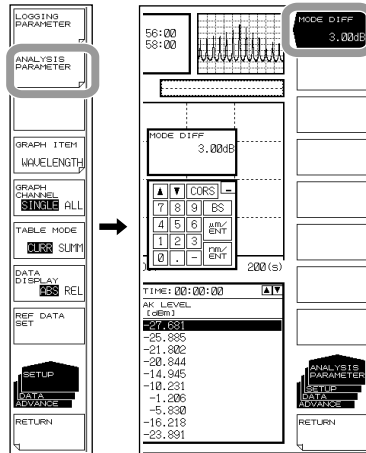

Note

- For a description of the mode judgment reference, see "MODE DIFF" in section 5.12.

When the Logging Item Is DFB-LD

3. Press the **ANALYSIS PARAMETER** soft key. The DFB-LD analysis parameter setting screen appears.

For the operating procedure, see steps 4 to 6 in section 6.5.

For parameter descriptions, see appendix 3.

If you change a parameter, the value specified in section 6.5 will also change (because the parameter is shared).

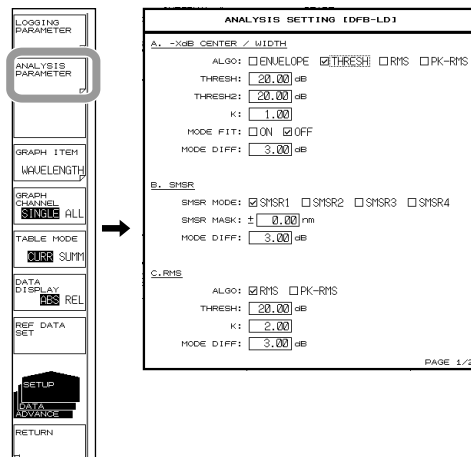

Executing and Stopping Data Logging

1. Press **ADVANCE** and then the **DATA LOGGING** soft key. The soft key menu for data logging appears.
2. Press the **START** soft key. A confirmation message for deleting the existing logging data and the EXECUTE and CANCEL soft keys appear.
3. Press the **EXECUTE** soft key. The existing logging data is deleted, and a new data logging session begins.

When the specified number of measurements is reached, data logging automatically stops.

If you press the **STOP** soft key while data logging is in progress, data logging will be stopped.

If you do not want to delete the existing logging data, press the **CANCEL** soft key. The previous soft key menu will return.

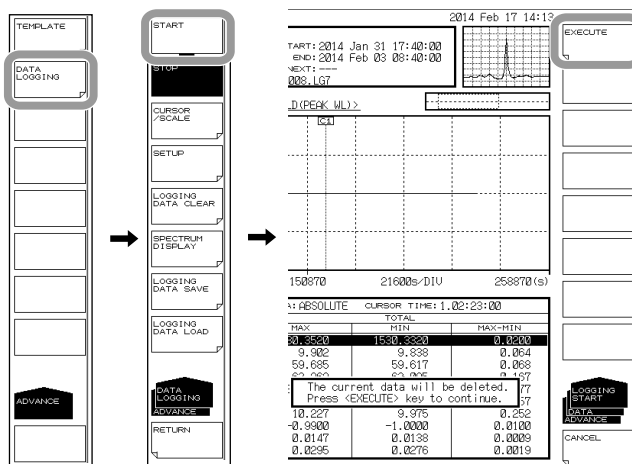

Note

- When TRACE LOGGING is ON, the AQ6375B checks the amount of free space in the temporary trace data storage space before starting to log. If there is insufficient free memory space, a warning will appear.
WARNING 151: Disk space is not enough for logging
If this happens, reduce the number of waveform data values (SAMPLING POINT) or reduce the logging time to decrease the waveform data size.
- If there is no existing logging data, the confirmation message for deleting the data will not appear, and data logging will begin immediately.
- Only the STOP soft key is valid while data logging is in progress.
If you press a soft key other than the STOP soft key, a confirmation message for stopping the data logging will appear. If you do not want to stop data logging, press the NO soft key.

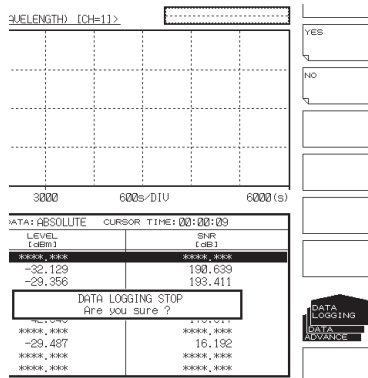

6.15 Analysis Data Logging

- **Displaying the Waveform Data Being Logged on the Screen**

If necessary, you can view the measured waveform during data logging.

4. Press the **SPECTRUM DISPLAY** soft key. The waveform of the data being logged appears on the screen (normal spectrum waveform display).

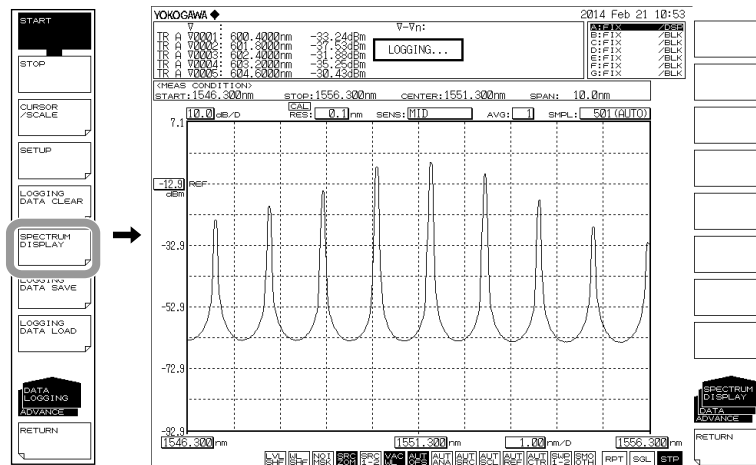

Note

You cannot use the SPECTRUM DISPLAY soft key when data logging is stopped.

- **Returning to the Previous Screen**

5. Press the **RETURN** soft key. The AQ6375B returns to the previous screen.

Selecting the Data to Graph

1. Press **ADVANCE** and then the **DATA LOGGING** soft key. The soft key menu for data logging appears.
2. Press the **SETUP** soft key. A menu for setting the data logging conditions appears.
3. Press the **GRAPH ITEM** soft key. The displayed menu varies depending on what is being logged.

When the Logging Item Is WDM

4. To display the wavelength graph, press the **WAVELENGTH** soft key. To display the level graph, press the **LEVEL** soft key. To display the SNR graph, press the **SNR** soft key.

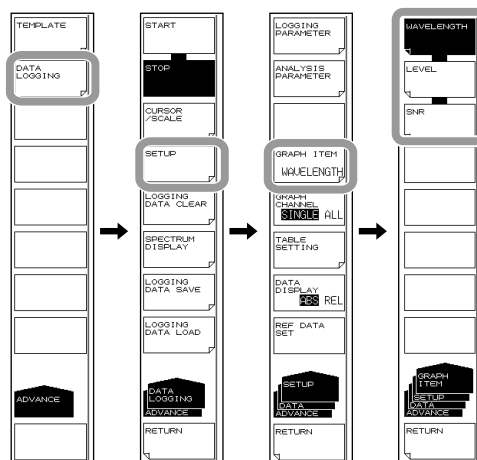

When the Logging Item Is PEAK/MULTI-PEAK

4. To display the wavelength graph, press the **PEAK WL** soft key. To display the level graph, press the **PEAK LEVEL** soft key.

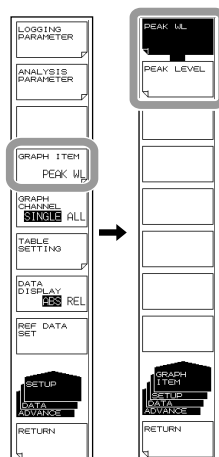

When the Logging Item Is DFB-LD

4. To display the graph of DFB-LD analysis items, press the soft keys below.
 - To display the peak wavelength graph: **PEAK WL**
 - To display the peak level graph: **PEAK LEVEL**
 - To display the side mode suppression ratio graph: **SMSR**
 - To display the signal-to-noise ratio graph: **OSNR**
 - To display the center wavelength graph: **CENTER WL**
 - To display the spectral width graph of the center wavelength based on the -XdB WIDTH (Center WL/SPWD) parameter: **SPEC WD**
 - To display the total power graph: **MORE1/2** and then **POWER**

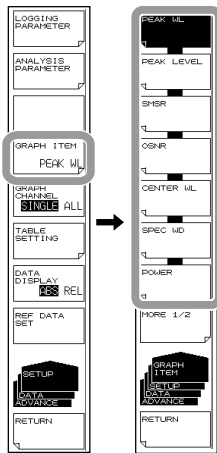

- To display the mode offset graph: **MORE1/2** and then **OFFSET**
- To display the spectral width (σ) graph of the center wavelength based on the RMS parameter: **MORE1/2** and then **SIGMA**
- To display the spectral width ($K\sigma$) graph of the center wavelength based on the RMS parameter: **MORE1/2** and then **K SIGMA**

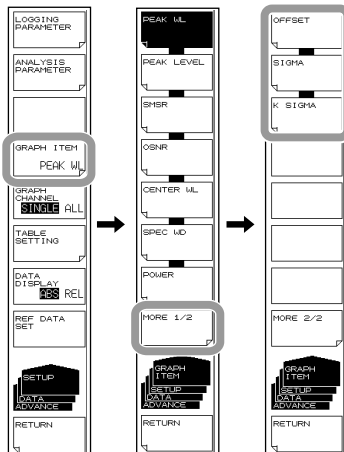

Selecting Whether to Display the Graph of One Channel or All Channels

1. Press **ADVANCE** and then the **DATA LOGGING** soft key. The soft key menu for data logging appears.
2. Press the **SETUP** soft key. A menu for setting the data logging conditions appears.
3. Press the **GRAPH CHANNEL SINGLE/ALL** soft key. The mode changes to SINGLE or ALL.

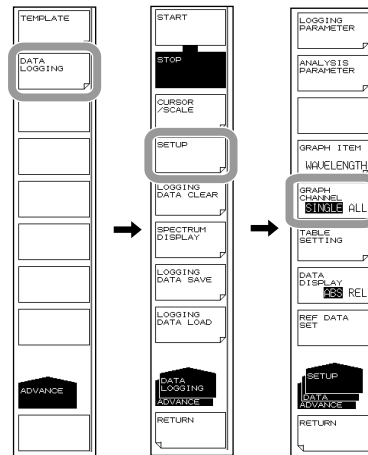

Note

You cannot use the GRAPH CHANNEL SINGLE/ALL soft key when the following settings are used.

- When the logging parameter is DFB-LD
- When the logging parameter is PEAK

Setting the Table Data Display Mode

1. Press **ADVANCE** and then the **DATA LOGGING** soft key. The soft key menu for data logging appears.
2. Press the **SETUP** soft key. A menu for setting the data logging conditions appears.
3. Press the **TABLE SETTING** soft key. The table data display method setting menu appears.
4. Press the **TABLE MODE CURR/SUMM** soft key. The display mode changes to CURR (displays current values) or SUMM (summary display: MAX, MIN, MAX/MIN).
5. If you select summary display in step 4, press the **SUMMARY TYPE MAXMIN/AVG** soft key. The items shown in the summary display switches to maximum/minimum values or average/standard deviation values.

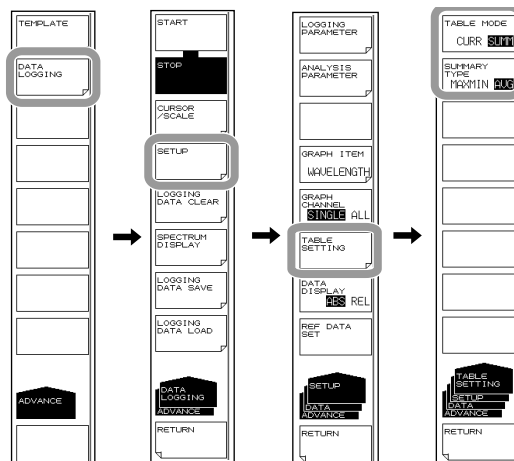

Setting the Table Data Value Display Mode

1. Press **ADVANCE** and then the **DATA LOGGING** soft key. The soft key menu for data logging appears.
2. Press the **SETUP** soft key. A menu for setting the data logging conditions appears.
3. Press the **DATA DISPLAY ABS/REL** soft key. The value display mode changes to ABS (absolute value) or REL (relative value).

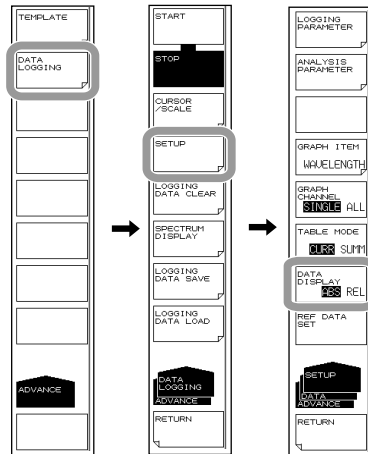

Setting the Reference Value for Displaying the Table Data Values Using Relative Values

1. Move cursor C1 or C2 to the graph value that you want to make the reference value (time).
For instructions on how to move the cursors, see “Displaying Graph Values Using Cursors” on the next page.
2. Press **ADVANCE** and then the **DATA LOGGING** soft key. The soft key menu for data logging appears.
3. Press the **SETUP** soft key. A menu for setting the data logging conditions appears.
4. Press the **REF DATA SET** soft key. The reference value is set to the measured value at the cursor time position.

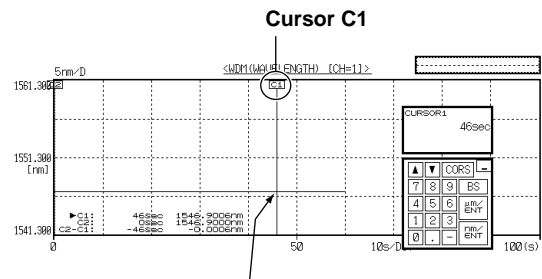
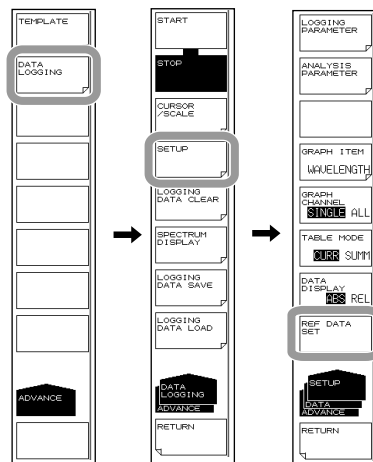

The reference value is set to the measured value at the cursor time position (e.g., 46 s).

Note

You cannot use the REF DATA SET soft key if data logging has not been executed and no data exists.

Displaying the Data Logging Results

• Displaying Graph Values Using Cursors

1. Press **ADVANCE** and then the **DATA LOGGING** soft key. The soft key menu for data logging appears.
2. Press the **CURSOR/SCALE** soft key. The cursor/scale soft key menu appears.
3. Press the **CURSOR SELECT C1 C2** soft key. Cursors C1 and C2 appear in the graph display area, and the cursor values are displayed at the lower right of the graph area.

Each time you press the CURSOR SELECT C1 C2 soft key, the current cursor toggles between cursor C1 and C2.

4. Move the cursor using the rotary knob.

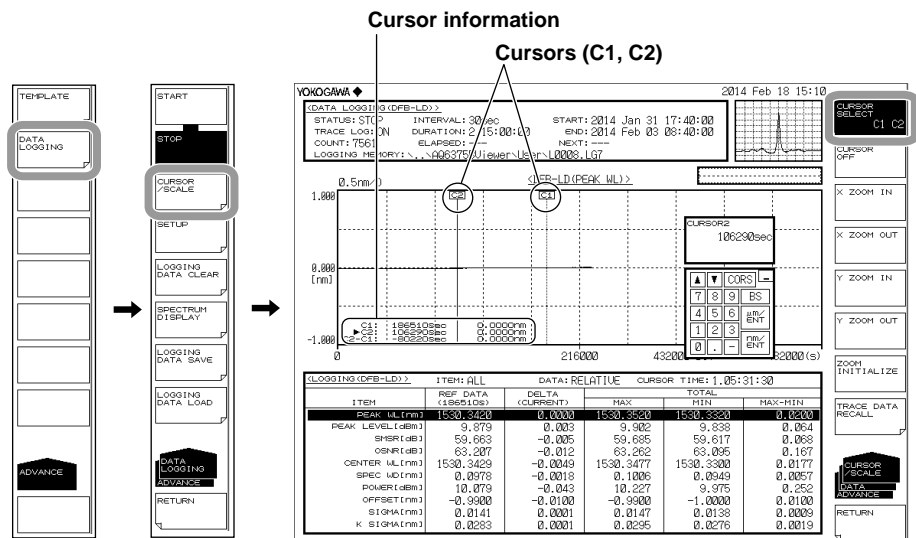

Note

The difference between the two cursor values (C2 – C1) is displayed below the cursor values.

The horizontal axis shows the logging time.

The vertical axis shows the value of the graph data (GRAPH ITEM).

You cannot move the cursors to an area where there is no logging data.

6.15 Analysis Data Logging

- **Clearing the Cursor Display**
 5. Press the **CURSOR OFF** soft key. Both cursors, C1 and C2, are cleared.
- **Zooming the Graph Display**
 1. Press **ADVANCE** and then the **DATA LOGGING** soft key. The soft key menu for data logging appears.
 2. Press the **CURSOR/SCALE** soft key. The cursor/scale soft key menu appears.

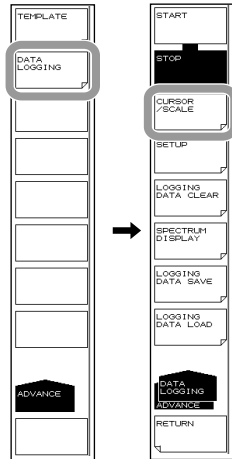

Zooming in on the Horizontal Scale

3. Press the **X ZOOM IN** soft key. The horizontal scale is expanded in 1-2-5 steps at the current cursor (cursor C1 or C2) position.

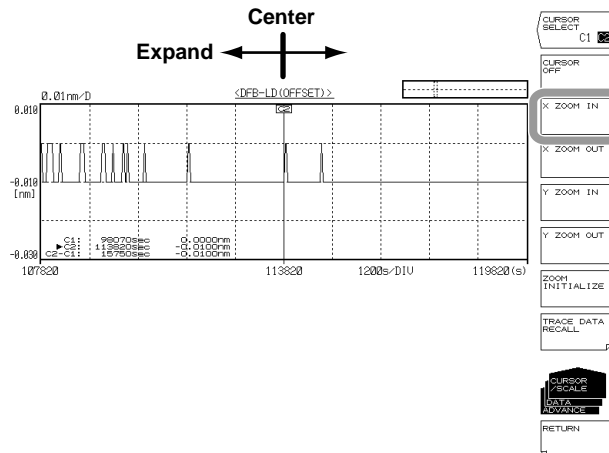

Zooming out from the Horizontal Scale

- Press the **X ZOOM OUT** soft key. The horizontal scale is reduced in 1-2-5 steps at the current cursor (cursor C1 or C2) position.

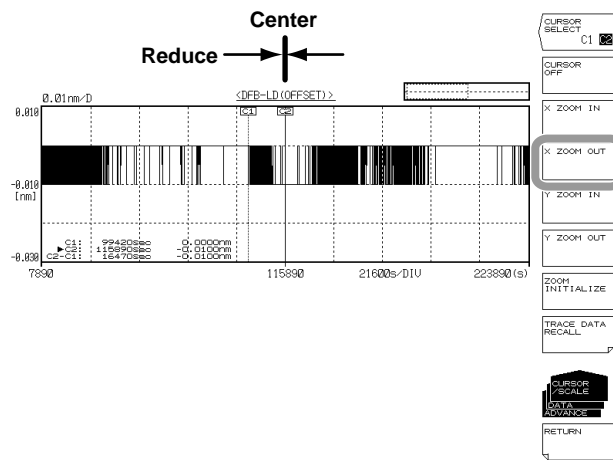

Zooming in on the Vertical Scale

- Press the **Y ZOOM IN** soft key. The vertical scale is expanded in 1-2-5 steps at the current cursor (cursor C1 or C2) position.

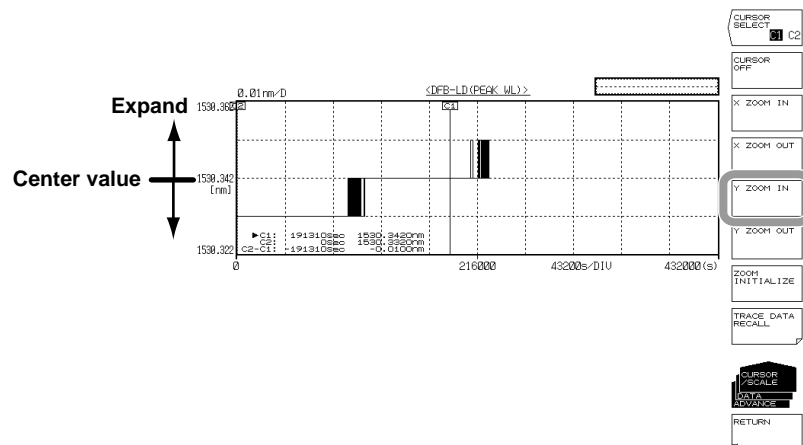

Zooming out of the Vertical Scale

3. Press the **Y ZOOM OUT** soft key. The vertical scale is reduced in 1-2-5 steps at the current cursor (cursor C1 or C2) position.

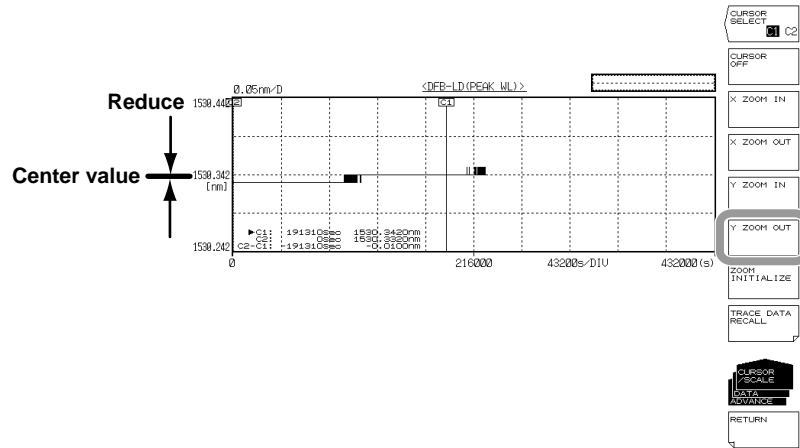

Initializing the Graph Display Zoom

4. Press the **ZOOM INITIALIZE** soft key.

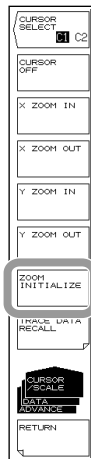

Note

Zooming of the vertical and horizontal scales will be initialized if you perform any of the following operations.

- If you clear the logging data
- If you start a new data logging session
- If you initialize the data (section 9.2)

Loading the Waveform Data of the Logging Data into the Specified Trace (only when the TRACE LOGGING parameter is set to ON)

1. Press **ADVANCE** and then the **DATA LOGGING** soft key. The soft key menu for data logging appears.
2. Press the **CURSOR/SCALE** soft key. The cursor/scale soft key menu appears.
3. Press the **TRACE DATA RECALL** soft key. A soft key menu for selecting the trace to load appears.
4. Press the soft key of the trace you want to load the data into. The waveform data at the current cursor position (cursor C1 or C2) is loaded into the selected trace, and the menu returns to the previous level.

If you press the **RETURN** soft key a few times to return to the ADVANCE level, the waveform data of the specified trace will be displayed.

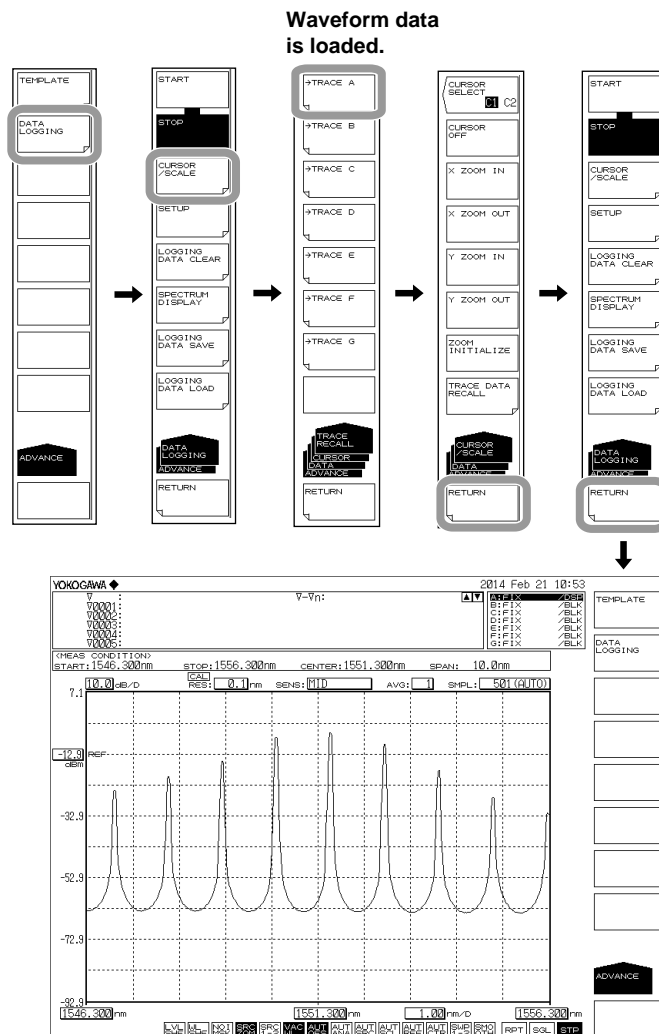

Note

You cannot use the TRACE DATA RECALL soft key in the following situations.

- If data logging has not been executed and no data exists
- If the TRACE LOGGING parameter is set off and no waveform data exists.

Saving the Data Logging Results

1. Press **ADVANCE** and then the **DATA LOGGING** soft key. The soft key menu for data logging appears.
2. Press the **LOGGING DATA SAVE** soft key. The soft key menu for saving the data and TRACELIST appear.

For the operating procedure, see step 4 and subsequent steps in section 7.10.

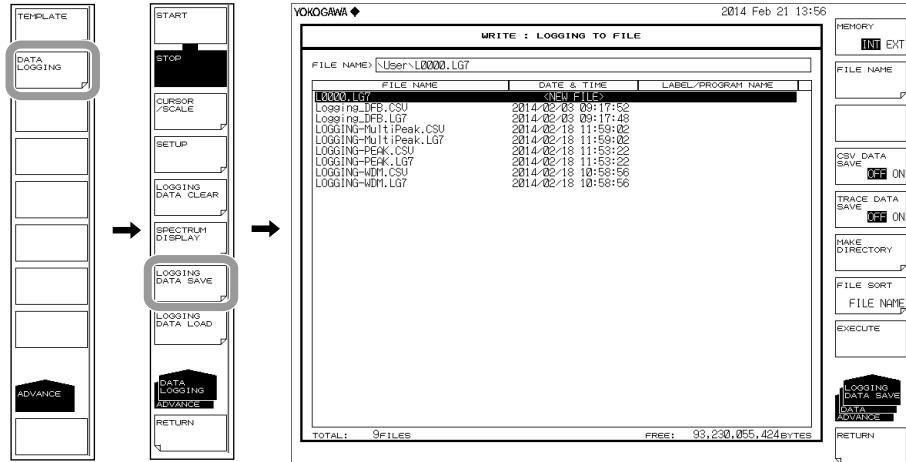

Loading the Data Logging Results

1. Press **ADVANCE** and then the **DATA LOGGING** soft key. The soft key menu for data logging appears.
2. Press the **LOGGING DATA LOAD** soft key. The soft key menu for loading the data and TRACE LIST appear.

For the operating procedure, see step 4 and subsequent steps in “Loading the Logging Data” of section 7.10.

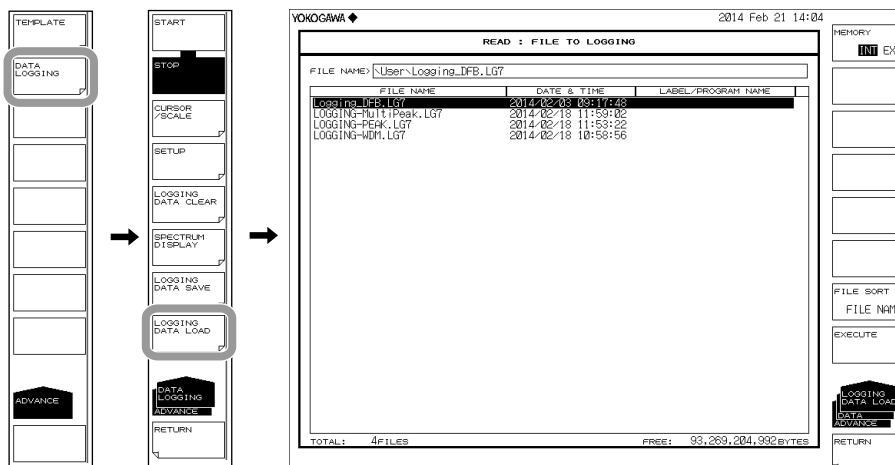

Deleting the Logging Data

1. Press **ADVANCE** and then the **DATA LOGGING** soft key. The soft key menu for data logging appears.
2. Press the **LOGGING DATA CLEAR** soft key. The EXECUTE and CANCEL soft keys appear.
3. Press the **EXECUTE** soft key. The logging data is deleted.

If you do not want to delete the logging data, press the **CANCEL** soft key. The previous soft key menu will return.

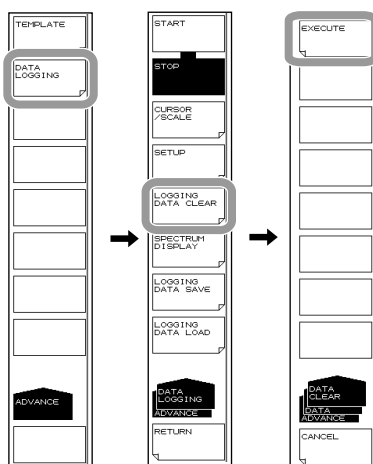

Note

This function is the same as the deletion performed for the data deletion confirmation message that appears when data logging is executed.

Description

Parameter Display

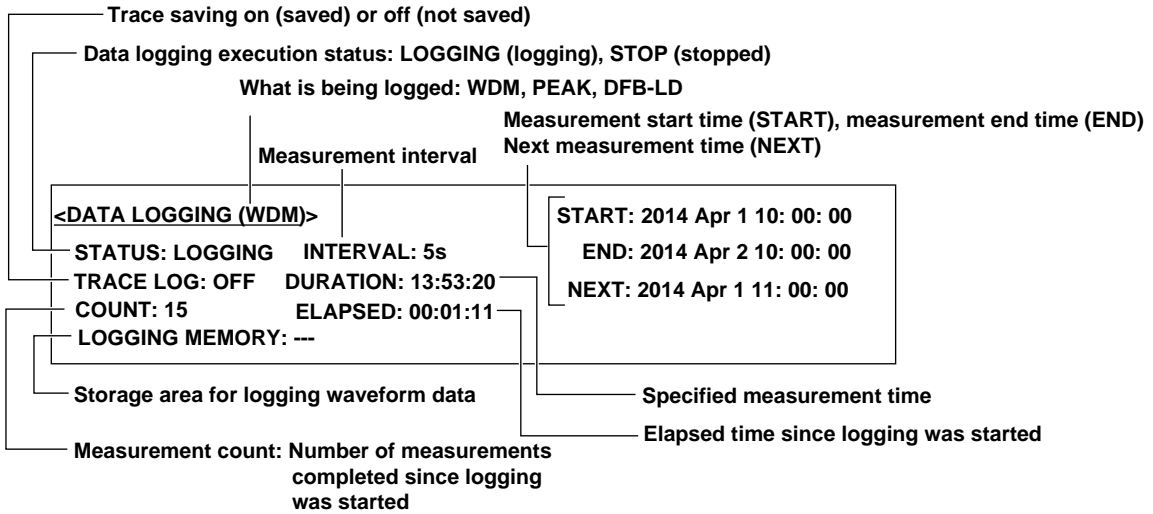

Table Data Display

• **Current Display**

Displays the current analysis data (list of all analysis items) in a table.

ABS (absolute value) display

Measurement time of the displayed data

CH	WAVELENGTH (nm)	LEVEL (dBm)	CURSOR TIME (00:00:00)
2	1548.0050	-20.071	42.131
3	1549.2320	-15.206	47.019
4	1550.4007	-7.419	54.852
5	1551.5726	-5.993	56.279
6	1552.7473	-9.866	52.600
7	1553.9212	-18.087	44.420

REL (relative value) display

REF data time

CH	WAVELENGTH (nm)	REF DATA (dB)	SNR (dB)	LEVEL (dBm)	DELTA (CURRENT) (dB)	SNR (dB)
2	1548.0050	-20.071	54.852	0.0000	0.000	0.000
3	1549.2320	-15.206	47.019	0.0000	0.000	0.000
4	1550.4007	-7.419	54.852	0.0000	0.000	0.000
5	1551.5726	-5.993	56.279	0.0000	0.000	0.000
6	1552.7473	-9.866	52.600	0.0000	0.000	0.000
7	1553.9212	-18.087	44.420	0.0000	0.000	0.000

• **Summary Display**

Displays the current analysis data and the analysis data of MAX, MIN, MAX-MIN values from the start of data logging to the current.

The summary display can display just one of the analysis items that you choose.

ABS (absolute value) display

CH	WAVELENGTH (nm)	MAX (nm)	MIN (nm)	MAX-MIN (nm)
2	1548.0050	1548.0056	1548.0050	0.0006
3	1549.2320	1549.2332	1549.2319	0.0013
4	1550.4007	1550.4010	1550.4006	0.0005
5	1551.5726	1551.5737	1551.5723	0.0015
6	1552.7473	1552.7476	1552.7471	0.0006
7	1553.9212	1553.9218	1553.9211	0.0007

REL (relative value) display

CH	REF WAVELENGTH (nm)	DELTA WAVELENGTH (CURRENT) (nm)	MAX (nm)	MIN (nm)	MAX-MIN (nm)
2	1548.0050	0.0000	1548.0057	1548.0050	0.0007
3	1549.2320	0.0000	1549.2332	1549.2319	0.0013
4	1550.4007	0.0000	1550.4010	1550.4006	0.0005
5	1551.5726	0.0000	1551.5737	1551.5723	0.0015
6	1552.7473	0.0000	1552.7476	1552.7471	0.0006
7	1553.9212	0.0000	1553.9218	1553.9211	0.0007

Logging Parameters

- **LOGGING ITEM**

Selects the logging item.

- **WDM**

Records the WL (channel center wavelength), LEVEL (channel level (peak level – noise level)), SNR (channel signal-to-noise ratio) of WDM analysis.

If the horizontal scale unit is set to wavenumber, you cannot select WDM.

- **MULTI-PEAK, PEAK**

Records the WL (peak center wavelength) and LEVEL (peak level).

- **DFB-LD**

Records all DFB-LD analysis items listed in appendix 3.

- **LOGGING MODE**

If you want to log many channels, use MODE1.

If you want to log many values, use MODE2.

The AQ6375B automatically detects the number of channels.

MODE1: Up to 1024 channels can be logged. The maximum number log entries is 2001.

MODE2: The maximum number log entries is 10001. Up to 256 channels can be logged.

- **MINIMUM INTERVAL**

Sets the logging interval (the time duration from the start of a measurement to the start of the next measurement). Set the logging interval in seconds.

Setting range: SWEEP TIME, 1 s, 2 s, 5 s, 10 s, 30 s, 1 min, 2 min, 5 min, 10 min

In a single measurement, if the sweep time is longer than the measurement interval due to the sweep conditions, the logging interval is set to SWEEP TIME. If this happens, a warning appears. (WARNING 153:Sweep time exceeds the set interval) If this message appears, check the logging interval.

- **TEST DURATION**

Sets the total logging duration of one test.

The setting range depends on the LOGGING MODE setting (maximum logging count) and logging interval. The minimum logging duration is the logging interval. The logging interval for SWEEP TIME is 1 seconds.

Note

If the auto offset function is on, auto offset is executed at regular intervals even during logging.

When auto offset is progress, logging measurement is paused. When an auto offset is

performed at a time when logging measurement would normally occur, a warning appears.

(Warning 152 Logging was skipped for Auto zeroing)

If this message appears, check the auto offset function setting or logging interval setting as necessary.

- **ESTIMATED TOTAL COUNT**

Displays the estimated measurement count during logging.

- **PEAK THRESH TYPE**

Sets how the threshold for detecting the data logging mode (peak or bottom) is specified. Modes whose level is greater than equal to the threshold specified here are logged.

ABS: Specifies the threshold using an absolute value (peak level)

REL: Specifies the threshold using a relative value (difference from the highest peak level)

6.15 Analysis Data Logging

- **THRESH(ABS)**

The absolute value threshold. You can set this when PEAK THRESH TYPE is set to ABS.

Selectable range: +20.00 to -100.00 dBm

- **THRESH(REL)**

The relative value threshold. You can set this when PEAK THRESH TYPE is set to REL.

Selectable range: 0.01 to 99.99 dB

- **CH MATCHING λ THRESH**

Sets the effective range from the center wavelength of data for determining whether the peak of the analysis data of the logging item is the same as that of the analysis data measured the last time.

If the analysis data during measurement is within the effective range, it will be logged as the same peak.

If it is not, the AQ6375B assumes that the previous peak has disappeared and a new peak has appeared and adds a new peak.

Selectable range: 0.1 nm to 10 nm. You must enter the wavelength even when the display mode is set to frequency.

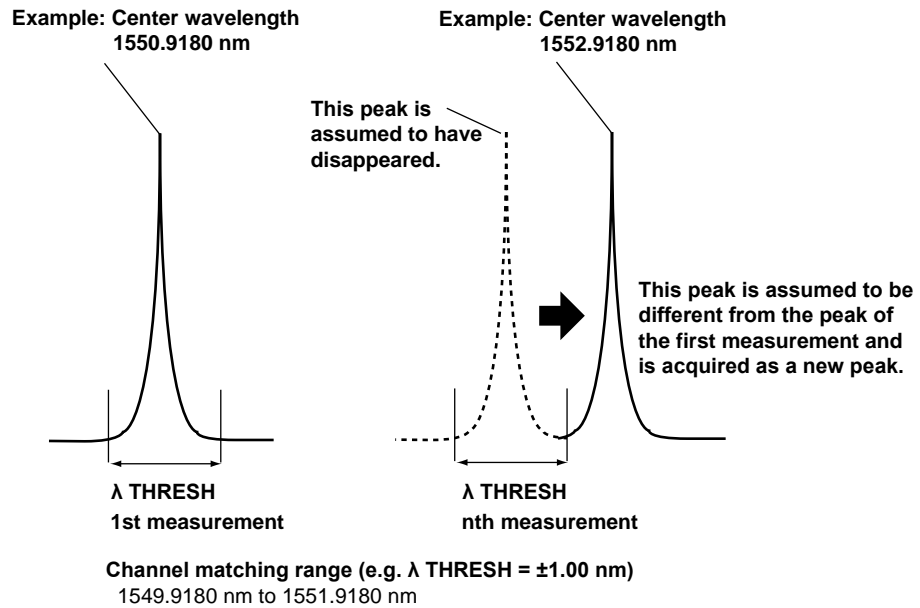

Note

For the following logging items, CH MATCHING λ TERESH cannot be used.

- DFB-LD
 - PEAK
-

- **TRACE LOGGING**

When this setting is on, the trace waveform is also saved when logging data is saved. This waveform data is saved temporarily to a single file in the internal memory or USB storage medium.

Temporary save directory

Internal memory (INTERNAL): \INT\AQLOGDAT\LOGTMP.LG7

USB storage medium \EXT\AQLOGDAT\LOGTMP.LG7

If you restart data logging, the files and directories in the temporary save directory will be deleted.

For instructions on how to save the temporarily saved waveform data to a normal file, see section 7.10.

- **DESTINATION MEMORY**

Selects where the temporary trace waveform data will be saved to.

INTERNAL: Internal memory

EXTERNAL: USB storage medium

If the size of waveform data will be large, use the USB storage medium.

Note

- If you also want to save trace waveforms when logging is in progress (TRACE LOGGING = ON), the temporary storage area must have sufficient free space for saving waveform data of all logging measurements.
If there is insufficient free memory space at the start of logging, a warning will appear. (Warning 151 Disk space is not enough for logging)
If this happens, reduce the number of waveform data values (SAMPLING POINT) or reduce the logging time to decrease the waveform data size.
- Temporary saved data (LOGTMP.LG7) cannot be loaded as a logging file.
If you want to load it, save it to a normal logging file.

Cursors

If you turn on the cursors, cursor values will appear in the lower right of the graph area. Cursor C1 and C2 will appear simultaneously. The value of C2 – C1 will appear below the cursor values.

Scales

The horizontal and vertical scales are automatically set according to the logging parameter conditions and logging data values.

Zooming is performed in 1-2-5 steps.

Example: The horizontal scale settings change like this: 5 s/div, 2 s/div, 1 s/div

The vertical scale settings change like this: 500 nm/div, 200 nm/div, 100 nm/div

7.1 USB Storage Media

Supported USB Storage Media

The instrument supports USB 1.0 or USB 2.0 compliant USB memory devices or hard disks. For details, contact your nearest Yokogawa representative.

Removing USB Storage Media

Always follow the procedure below when removing USB storage media.

1. Press **FILE**. The file menu is displayed.
Check whether the **REMOVE USB STORAGE** soft key is enabled or disabled (dimmed). If the REMOVE USB STORAGE soft key is disabled (dimmed), the USB storage media can be safely removed.
2. If the REMOVE USB STORAGE soft key is enabled, press the **REMOVE USB STORAGE** soft key. If the REMOVE USB STORAGE soft key is disabled (dimmed), the USB storage media can be safely removed.



Note

- If there are 2 or more USB storage devices, only the first connected device is recognized. If you restart the instrument, the USB storage devices that were connected afterward will be recognized.
- Please refer to your USB memory's user's manual for additional precautions.

7.2 Temporarily Saving and Redisplaying Traces to and from Internal Memory

Procedure

You can save waveforms being displayed by the instrument to the instrument's internal memory, and redisplay data that has been saved to the internal memory.

Temporarily Saving Trace Data to Internal Memory

1. Press **MEMORY**. The soft key menu for the internal memory appears.
2. Press the **SAVE** soft key. The internal memory list and trace list are displayed.
3. Select a destination memory number using the **rotary knob**, **arrow keys**, or **numeric key pad**.
4. Press the soft key corresponding to the trace to be saved. The trace data is saved to the selected memory number.

YOKOGAWA 2007 Nov 07 15:49

WRITE : TRACE TO MEMORY NO.01

TR	CENTER	SPAN	REF LVL	LVL	SCL	RESLN	AVG	SAMPL	SENS	ATTR
A	1800.000nm	120.00nm	-10.045m	10.045	1.000nm	1	6001	NORM-AUT	MEAS	
B	1800.000nm	120.00nm	-10.045m	10.045	1.000nm	1	6001	NORM-AUT	MEAS	
C	1800.000nm	120.00nm	-10.045m	10.045	1.000nm	1	6001	NORM-AUT	MEAS	
D	1800.000nm	120.00nm	-10.045m	10.045	1.000nm	1	6001	NORM-AUT	MEAS	
E	1800.000nm	120.00nm	-10.045m	10.045	1.000nm	1	6001	NORM-AUT	MEAS	
F	1800.000nm	120.00nm	-10.045m	10.045	1.000nm	1	6001	NORM-AUT	MEAS	
G	1800.000nm	120.00nm	-10.045m	10.045	1.000nm	1	6001	NORM-AUT	MEAS	

MEMORY LIST

NO	LABEL	ATTR
00	// AG6375 OPTICAL SPECTRUM ANALYZER //	MEAS
01	// AG6375 OPTICAL SPECTRUM ANALYZER //	MEAS
02		
03		
04		
05		
06		
07		
08		
09		
10		
11		
12		
13		
14		
15		
16		
17		
18		
19		

Change display contents

Redisplaying Trace Data

1. Press **MEMORY**. The soft key menu for the internal memory appears.
2. Press the **RECALL** soft key. The internal memory list and trace list are displayed.
3. Select a source memory number using the **rotary knob**, **arrow keys**, or **numeric key pad**.
4. Press the soft key corresponding to the trace number to assign to the data of the selected memory number.
5. Returning to the waveform display screen, data of the selected memory number is displayed in the specified trace number.

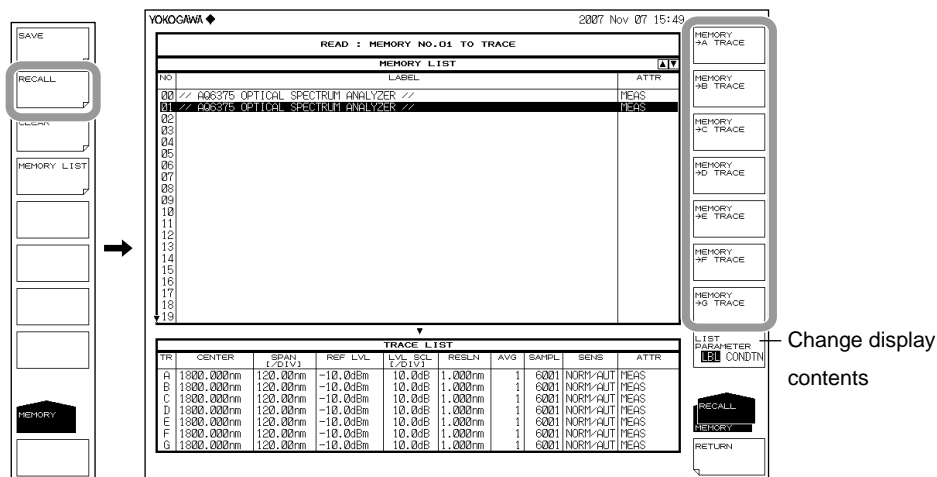

Clearing Memory Data

1. Press **MEMORY**. The soft key menu for the internal memory appears.
2. Press the **CLEAR** soft key. The internal memory list and trace list are displayed.
3. Select the memory number of the data to be cleared using the **rotary knob**, **arrow keys**, or the **UP/DOWN arrow** soft keys.
4. Press the **EXECUTE** soft key. The data of the selected memory number is cleared.

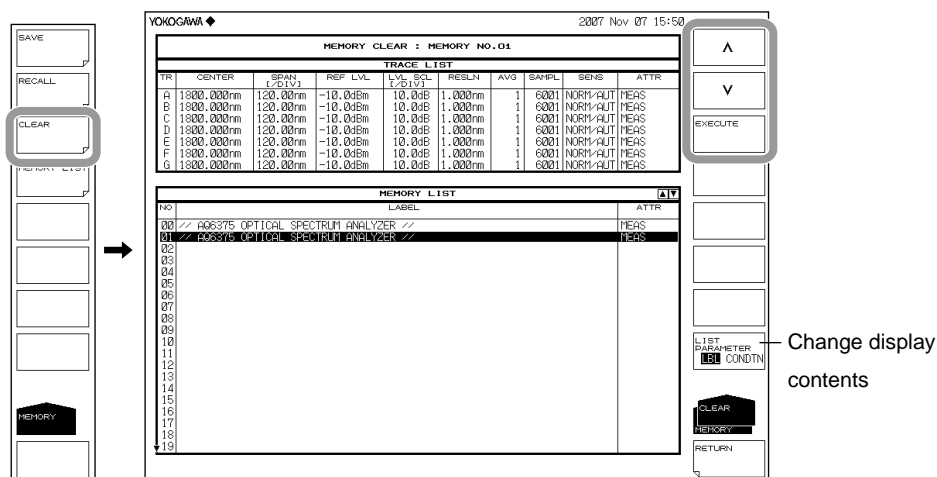

Displaying and Changing the Memory List

1. Press **MEMORY**. The soft key menu for the internal memory appears.
2. Press the **MEMORY LIST** soft key. The internal memory list and trace list are displayed.
3. Press the **LIST PARAMETER** soft key, then select either **LBL** (label) or **CONDTN** (data measurement condition).

The displayed items of the memory list change to labels or measurement conditions. You can also change the display contents of the memory list by using the **SAVE**, **RECALL**, and **CLEAR** menus.

LBL (Label)

MEMORY LIST										
TRACE LIST										
TR	CENTER	SPAN (DIV)	REF LVL	LVL	SCL (DIV)	RESLN	AVG	SAMPL	SENS	ATTR
A	1800.000nm	120.00nm	-10.0dBm	10.0dB	1.000nm	1	6001	NORM/AUT	MEAS	
B	1800.000nm	120.00nm	-10.0dBm	10.0dB	1.000nm	1	6001	NORM/AUT	MEAS	
C	1800.000nm	120.00nm	-10.0dBm	10.0dB	1.000nm	1	6001	NORM/AUT	MEAS	
D	1800.000nm	120.00nm	-10.0dBm	10.0dB	1.000nm	1	6001	NORM/AUT	MEAS	
E	1800.000nm	120.00nm	-10.0dBm	10.0dB	1.000nm	1	6001	NORM/AUT	MEAS	
F	1800.000nm	120.00nm	-10.0dBm	10.0dB	1.000nm	1	6001	NORM/AUT	MEAS	
G	1800.000nm	120.00nm	-10.0dBm	10.0dB	1.000nm	1	6001	NORM/AUT	MEAS	

MEMORY LIST		
LABEL		
NO		ATTR
00	// AG6375 OPTICAL SPECTRUM ANALYZER //	MEAS
01	// AG6375 OPTICAL SPECTRUM ANALYZER //	MEAS
02		
03		
04		
05		
06		
07		
08		
09		
10		
11		
12		
13		
14		
15		
16		
17		
18		
19		

CONDIN (Measurement conditions)

MEMORY LIST										
TRACE LIST										
TR	CENTER	SPAN (DIV)	REF LVL	LVL	SCL (DIV)	RESLN	AVG	SAMPL	SENS	ATTR
A	1800.000nm	120.00nm	-10.0dBm	10.0dB	1.000nm	1	6001	NORM/AUT	MEAS	
B	1800.000nm	120.00nm	-10.0dBm	10.0dB	1.000nm	1	6001	NORM/AUT	MEAS	
C	1800.000nm	120.00nm	-10.0dBm	10.0dB	1.000nm	1	6001	NORM/AUT	MEAS	
D	1800.000nm	120.00nm	-10.0dBm	10.0dB	1.000nm	1	6001	NORM/AUT	MEAS	
E	1800.000nm	120.00nm	-10.0dBm	10.0dB	1.000nm	1	6001	NORM/AUT	MEAS	
F	1800.000nm	120.00nm	-10.0dBm	10.0dB	1.000nm	1	6001	NORM/AUT	MEAS	
G	1800.000nm	120.00nm	-10.0dBm	10.0dB	1.000nm	1	6001	NORM/AUT	MEAS	

MEMORY LIST										
CONDIN										
NO	CENTER	SPAN (DIV)	REF LVL	LVL	SCL (DIV)	RESLN	AVG	SAMPL	SENS	ATTR
00	2005.324nm	2.00nm	-3.5dBm	10.0dB	0.100nm	1	1001	H11/CHOP	MEAS	
01	1800.000nm	120.00nm	-10.0dBm	10.0dB	1.000nm	1	6001	NORM/AUT	MEAS	
02										
03										
04										
05										
06										
07										
08										
09										
10										
11										
12										
13										
14										
15										
16										
17										
18										
19										

Explanation

Up to 64 data can be saved.

It is often useful to temporarily save waveform data for redisplay at a later time. The following data can be saved.

Types of Data	Display in List (ATTR Field)
Measured waveforms	MEAS
Normalized displayed waveforms	NORM A, NORM B, NORM C
Maximum value detection display waveforms	MAX_H
Minimum value detection display waveforms	MIN_H
Curve-fit waveforms	CRV FIT A, CRV FIT B, CRV FIT C
Peak curve fit waveforms	PKCVFIT A, PKCVFIT B, PKCVFIT C
LOG calculation display waveforms	A-B, B-A, A+B, C-D, D-C, C+D, D-E, E-D, D+E, C-F, F-C, C+F, E+F, F-E, E+F, F-E, E+F
Linear calculation display waveforms	A+B LIN, A-B LIN, B-A LIN, 1-k(A/B), 1-k(B/A), C+D LIN, C-D LIN, D-C LIN, D+E LIN, D-E LIN, E-D LIN, C+F LIN, C-F LIN, F-C LIN, E+F LIN, E-F LIN, F-ELIN

7.3 Saving/Loading Displayed Data

Procedure

Waveforms displayed by the instrument and waveforms temporarily saved to internal memory can be saved to a USB storage medium or the internal memory, and loaded from the USB storage medium.



CAUTION

Do not remove the USB storage medium or turn the power OFF while the USB storage medium access indicator is blinking. This can damage the data on the medium or the device itself. Also, always place a USB storage medium in the removable state (following the procedure in section 7.1) before removing it.

French



ATTENTION

Ne retirez pas le dispositif de stockage USB et ne coupez pas l'alimentation lorsque le voyant d'accès au dispositif de stockage USB clignote.

Cela risquerait d'endommager le dispositif ou les données se trouvant sur ce dernier. De plus, toujours faire passer un support de stockage USB à l'état de retrait en toute sécurité (en suivant la procédure figurant à la section 7.1) avant de le retirer.

Saving Trace Data

Selecting the Method of Automatically Setting the File Name

1. Press **FILE**. The soft key menu for saving and loading data appears.
2. Press the **AUTO FILE NAME** soft key. Select NUM (serial number) or DATE.

Setting the Type of the File to Be Saved to TRACE

1. Press **FILE**. The soft key menu for saving and loading data appears.
2. Press the **ITEM SELECT** soft key. The menu for selecting the type of files to be saved is displayed.
3. Press the **TRACE** soft key. TRACE is selected, and the screen returns to the previous stage.
4. Press the **WRITE** soft key. The TRACE LIST is displayed on screen.

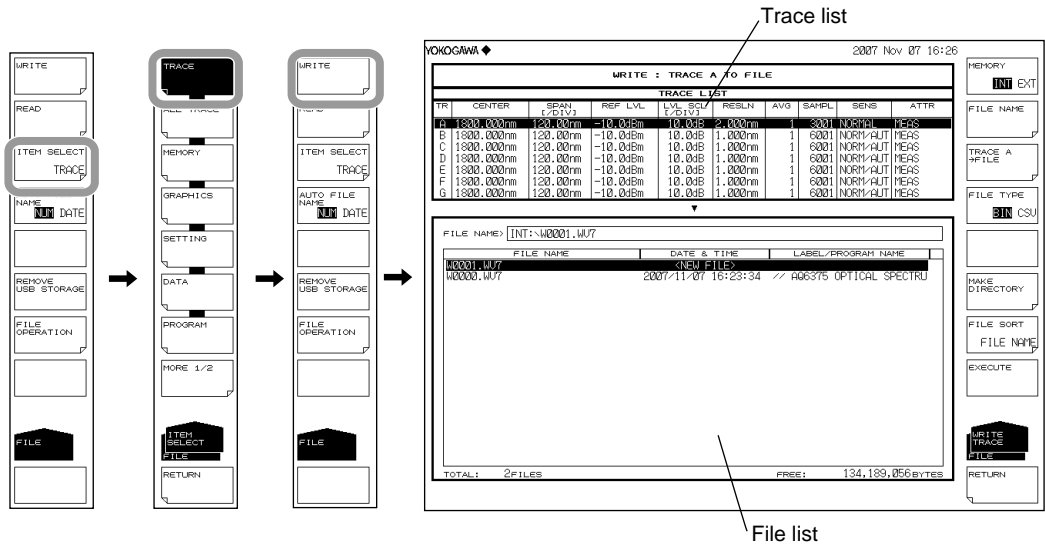

Selecting the Save Destination and Data Format

5. Press the **MEMORY** soft key and specify a save destination of INT (internal memory) or EXT (USB storage medium).
6. Press the **FILE TYPE** soft key and specify a data format of BIN (binary) or CSV (ASCII format).



Selecting a Trace to Save

7. Press the TRACE @->FILE soft key (where @ is the currently selected trace number). The trace selection menu is displayed.
8. Press the soft key corresponding to the trace to be saved.

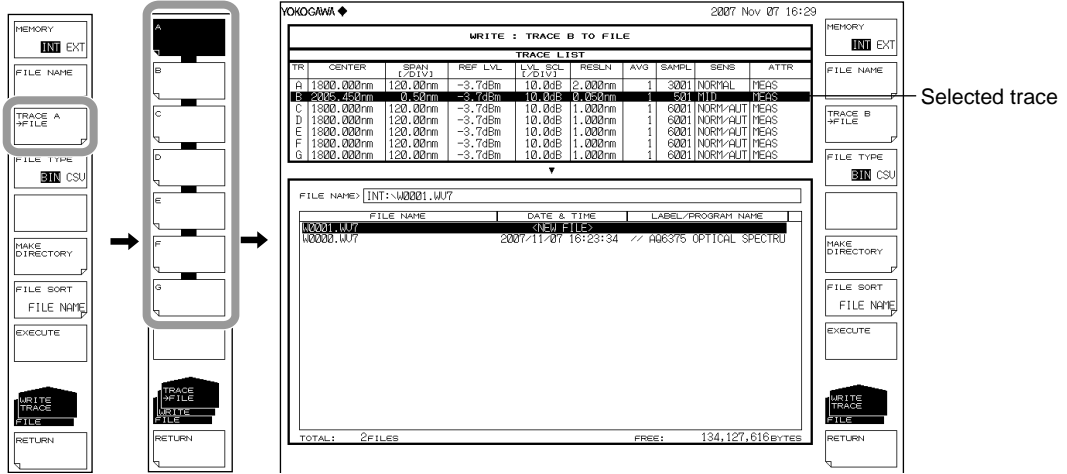

Entering a File Name (When Saving to an Arbitrary File Name)

If a file name is not entered, it is automatically assigned in the form WXXXX.CSV or WXXXX.WV7 (where XXXX is a serial number or saved date and time). For creating a directory and sorting the file list, see the next page.

9. Using the rotary knob, move the cursor to the line in the file list displaying NEW FILE.
10. Press the FILE NAME soft key. The text entry window and corresponding soft key menu are displayed.
11. Follow the instructions in section 3.3 to enter a file name.
12. Press the DONE soft key. The file name is confirmed, and the screen returns to the previous stage.

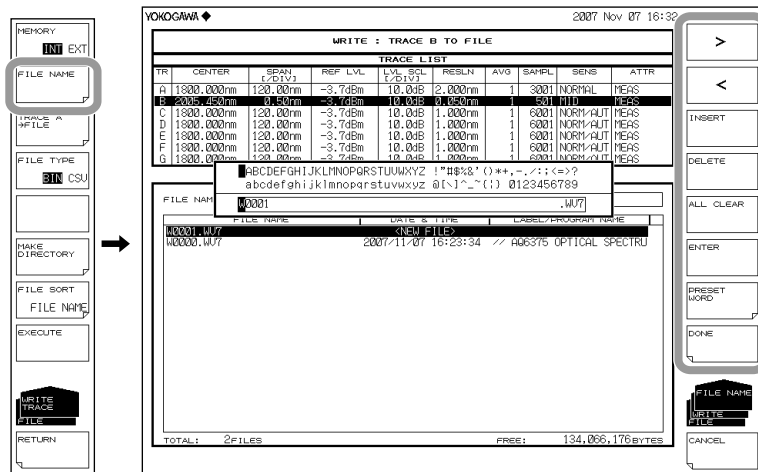

Executing the Save

13. To overwrite an existing file, move the cursor to the file name to be overwritten.

14. Press the **EXECUTE** soft key. The save executes.

When the **RETURN** soft key is pressed, the data is saved. The screen returns to the previous stage.

15. When overwriting during a save, a confirmation message appears. Press the **YES** soft key.

To cancel the save press **NO** soft key.

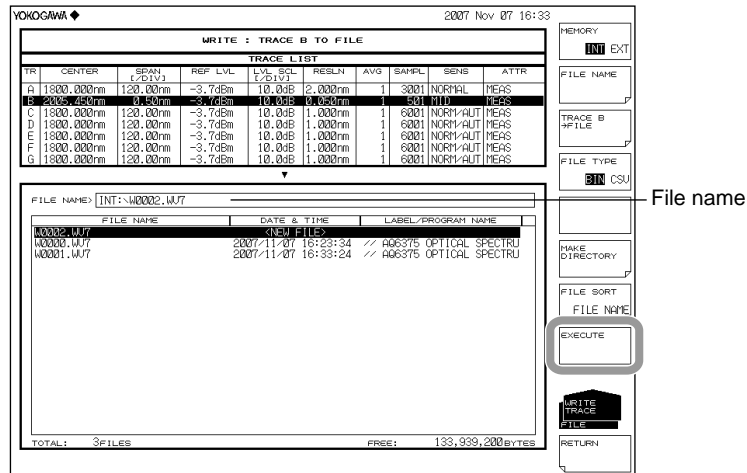

Creating a Directory and Sorting Files

Perform the following procedure if needed.

16. Press the **MAKE DIRECTORY** soft key. The menu for creating directories is displayed.

17. Press the **DIRECTORY NAME** soft key. The text entry window and corresponding soft key menu are displayed. Enter a directory name in the same manner as when entering a file name.

18. Press the **EXECUTE** soft key. The directory is created. Press the **CANCEL** soft key to cancel creation of the directory.

19. Press the **FILE SORT** soft key. The file sort menu is displayed.

20. Press the soft key corresponding to the item by which to sort. The files are sorted in ascending order by the selected item.

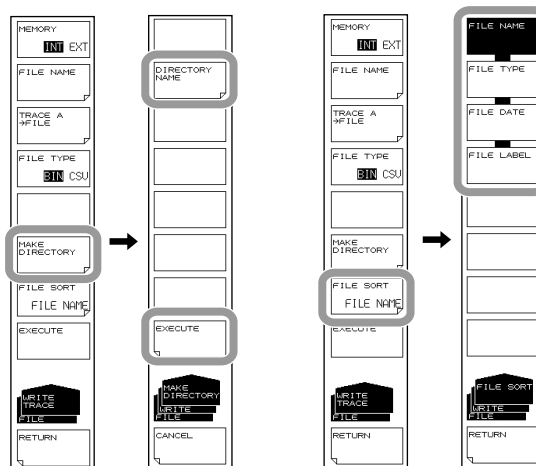

Loading Trace Data

Setting the Type of the File to Be Loaded to TRACE

1. Press **FILE**. The soft key menu for saving and loading data appears.
2. Press the **ITEM SELECT** soft key. The menu for selecting the type of files to be saved is displayed.
3. Press the **TRACE** soft key. TRACE is selected, and the screen returns to the previous stage.
4. Press the **READ** soft key. The file list is displayed on screen.

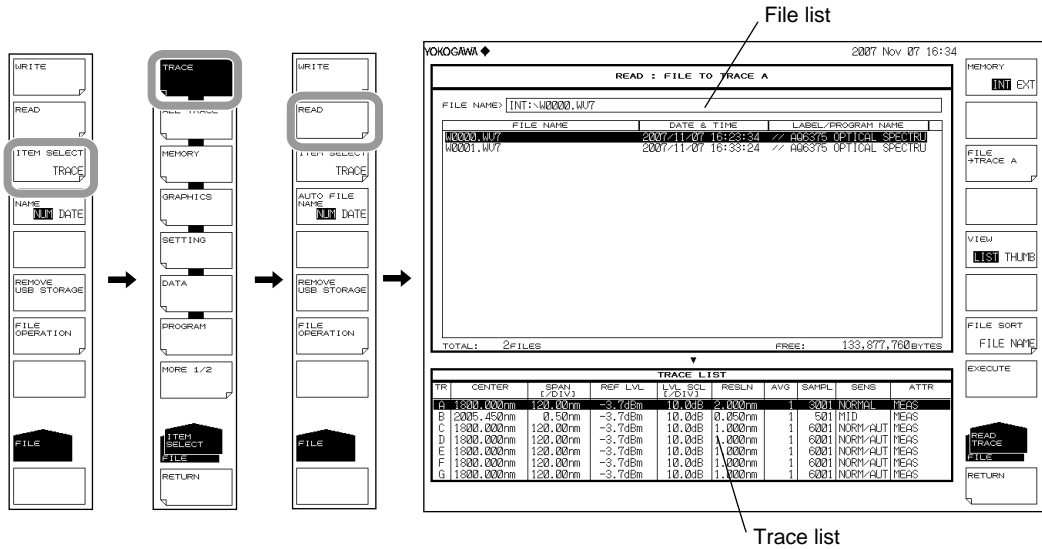

Selecting the File to Be Loaded

5. Press the **MEMORY** soft key and specify **INT** (internal memory) or **EXT** (USB storage medium). A file list of the selected medium is displayed.
 6. Select a file to load from the file list using the **rotary knob** or the **arrow keys**.
- If the **VIEW** soft key is pressed, the display toggles between list and thumbnail display. To sort the files, see page 8-9.

This screenshot shows the **FILE TO TRACE A** screen with the **MEMORY** soft key menu open. The menu options are **INT** and **EXT**. The **FILE LIST** and **TRACE LIST** are visible at the bottom of the screen.

Thumbnail display

This screenshot shows the **FILE TO TRACE A** screen in thumbnail display mode. It displays a grid of small graphs representing different optical spectra. The **VIEW** soft key menu is open, showing **LIST** and **THUMB** options. The **FILE LIST** and **TRACE LIST** are visible at the bottom.

File sort

This screenshot shows the **FILE TO TRACE A** screen with the **VIEW** soft key menu open. The menu options are **LIST** and **THUMB**. The **FILE LIST** and **TRACE LIST** are visible at the bottom.

Selecting a Trace from the Loaded Data

7. Press the **FILE->TRACE @** soft key (where @ is the currently selected trace number). The trace selection menu is displayed.
8. Press the soft key corresponding to the trace to be assigned.

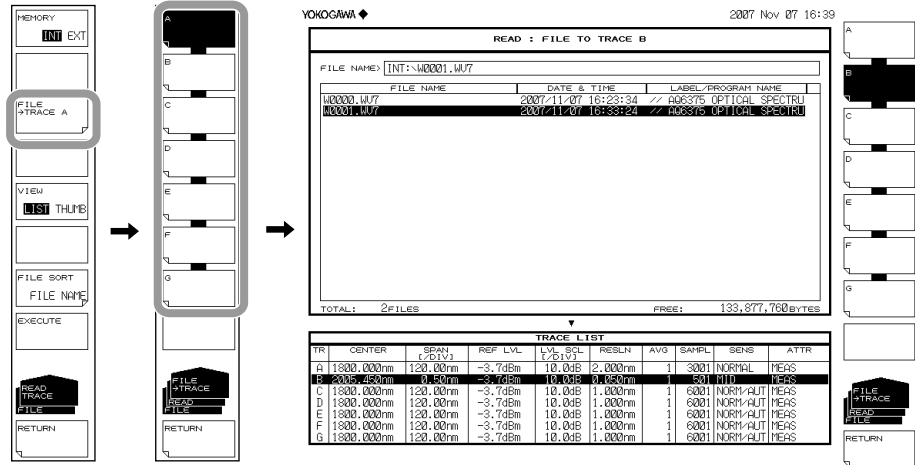

Executing the Load

9. Press the **EXECUTE** soft key. The file is loaded and displayed as the specified trace number.
- When the **RETURN** soft key is pressed, the file is not loaded. The screen returns to the previous stage.

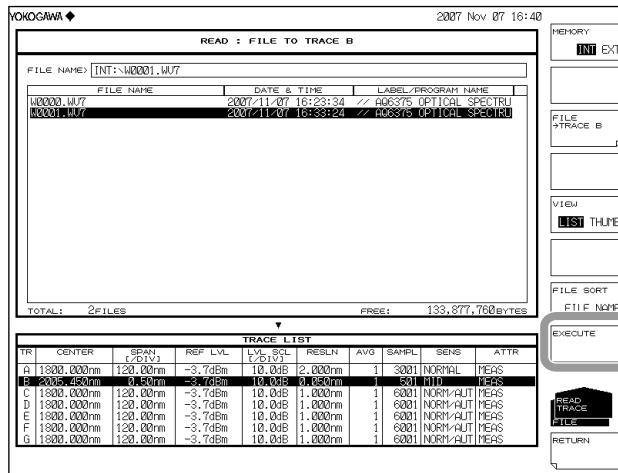

Saving the Data Temporarily Saved to Internal Memory

Setting the Type of the File to Be Saved to MEMORY

1. Press **FILE**.
2. Press the **ITEM SELECT** soft key. The soft key menu switches.
3. Press the **MEMORY** soft key. MEMORY is selected, and the screen returns to the previous stage.
4. Press the **WRITE** soft key. The memory list and file list are displayed.

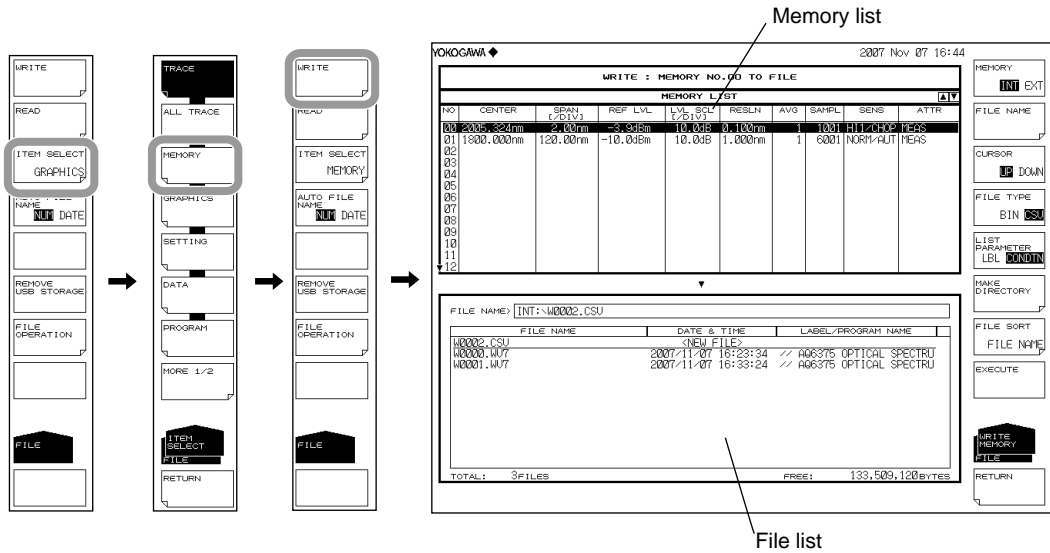

Selecting the Save Destination and Data Format

5. Press the **MEMORY** soft key and specify a save destination of INT (internal memory) or EXT (USB storage medium).
6. Press the **FILE TYPE** soft key and specify a data format of BIN (binary) or CSV (ASCII format).



Selecting a Memory Number to Save

7. Press the **CURSOR** soft key, then set the cursor selection to UP (on the memory list side).
8. Select the memory number of the data to save using the rotary knob, arrow keys, or **numeric key pad**. Press the **LIST PARAMETER** soft key, allowing you to change the information displayed in the memory list to label names or measurement conditions. For more information, see section 7.2.

YOKOGAWA 2007 Nov 07 16:46

WRITE : MEMORY NO.01 TO FILE

NO	CENTER	SPAN (Z-LEVEL)	REF LVL	LVL (Z-LEVEL)	RESLN	AVG	SAFPL	SENS	ATTR
00	2005.324nm	2.00nm	-3.9dBm	10.0dB	0.100nm	1	1001	H1-CHOP	MEAS
01	1800.000nm	120.00nm	-10.0dBm	10.0dB	1.000nm	1	6001	NORM-AUT	MEAS
02									
03									
04									
05									
06									
07									
08									
09									
10									
11									
12									

FILE NAME: INT:\M0002.CSU

FILE NAME	DATE & TIME	LABEL/PROGRAM NAME
M0002.CSU		NEW FILE
M0000.WV7	2007/11/07 16:23:34	// A66375 OPTICAL SPECTRU
M0001.WV7	2007/11/07 16:33:24	// A66375 OPTICAL SPECTRU

TOTAL: 3 FILES FREE: 133,509,120 BYTES

Selected memory number

Entering the Name of the File to Be Saved

If a file name is not entered, it is automatically assigned in the form WXXXX.CSV or WXXXX.WV7 (where XXXX is a serial number saved date and time).

For creating a directory and sorting the file list, see the page 7-9.

For the auto file name, see section 7.12.

9. Press the **CURSOR** soft key, then set the cursor selection to DOWN (on the file list side). An underscore is displayed with the memory number selected in step 8.
10. Using the rotary knob or arrow keys, move the cursor to the line in the file list displaying NEW FILE.
11. Press the **FILE NAME** soft key. The text entry window and corresponding soft key menu are displayed.
12. Follow the instructions in section 3.3 to enter a file name.
13. Press the **DONE** soft key. The file name is confirmed, and the screen returns to the previous stage.

YOKOGAWA 2007 Nov 07 16:47

WRITE : MEMORY NO.01 TO FILE

NO	CENTER	SPAN (Z-LEVEL)	REF LVL	LVL (Z-LEVEL)	RESLN	AVG	SAFPL	SENS	ATTR
00	2005.324nm	2.00nm	-3.9dBm	10.0dB	0.100nm	1	1001	H1-CHOP	MEAS
01	1800.000nm	120.00nm	-10.0dBm	10.0dB	1.000nm	1	6001	NORM-AUT	MEAS
02									
03									
04									
05									
06									
07									
08									
09									
10									
11									
12									

FILE NAME: INT:\M0002.CSU

FILE NAME	DATE & TIME	LABEL/PROGRAM NAME
M0002.CSU		NEW FILE
M0000.WV7	2007/11/07 16:23:34	// A66375 OPTICAL SPECTRU
M0001.WV7	2007/11/07 16:33:24	// A66375 OPTICAL SPECTRU

TOTAL: 3 FILES FREE: 133,509,120 BYTES

Sets the file name

Moves the cursor

Creates a directory

Sorts the file list

Executing the Save

14. To overwrite an existing file, move the cursor to the file name to be overwritten.

15. Press the **EXECUTE** soft key. The save executes.

When the **RETURN** soft key is pressed, the data is saved. The screen returns to the previous stage.

16. When overwriting during a save, a confirmation message appears. Press the **YES** soft key.

To cancel the save press **NO** soft key.

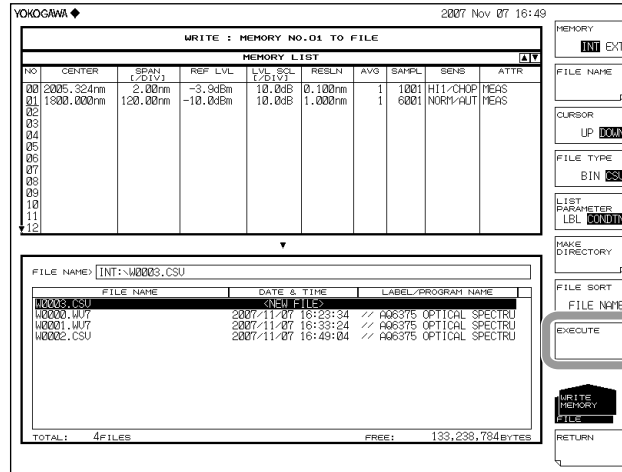

Loading from the Temporary Save Memory

Setting the Type of the File to Be Loaded to MEMORY

1. Press **FILE**.
2. Press the **ITEM SELECT** soft key. The soft key menu switches.
3. Press the **MEMORY** soft key. MEMORY is selected, and the screen returns to the previous stage.
4. Press the **READ** soft key. The memory list and file list are displayed.

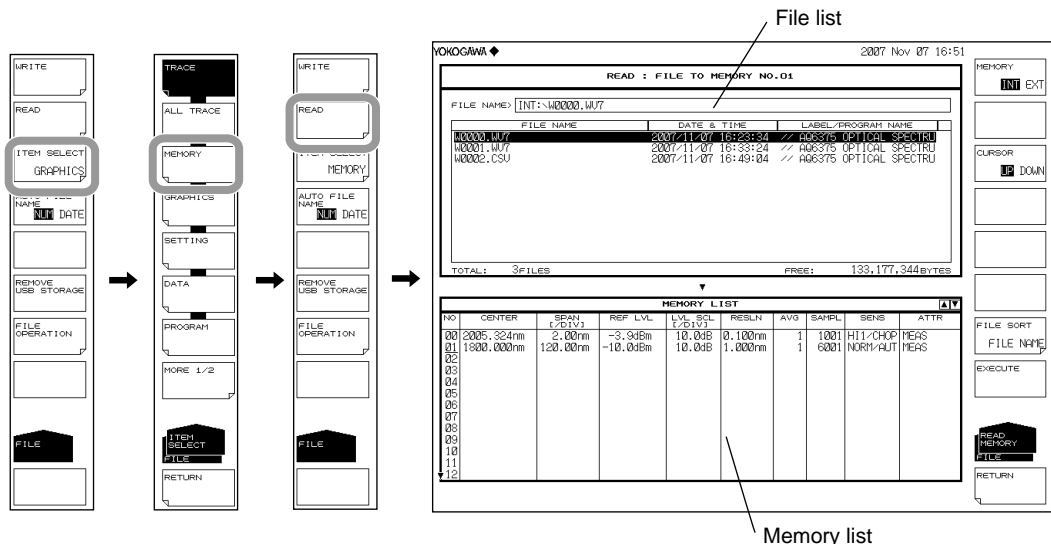

Selecting the File to Be Loaded

5. Press the **MEMORY** soft key and specify INT (internal memory) or EXT (USB storage medium). A file list of the selected medium is displayed.
6. Press the **CURSOR** soft key, then set the cursor selection to UP (on the file list side).
7. Select a file to load from the file list using the **rotary knob** or the **arrow keys**.
You can also press the **FILE SORT** soft key to sort the files. For more information, see page 7-9.

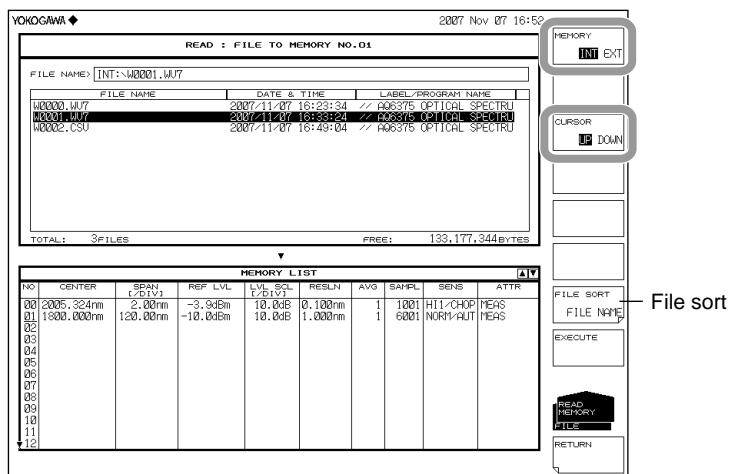

Selecting a Memory Number to Save

8. Press the **CURSOR** soft key, then set the cursor selection to DOWN (on the memory list side).
9. Select the memory number of the load destination using the rotary knob, arrow keys, or numeric key pad.

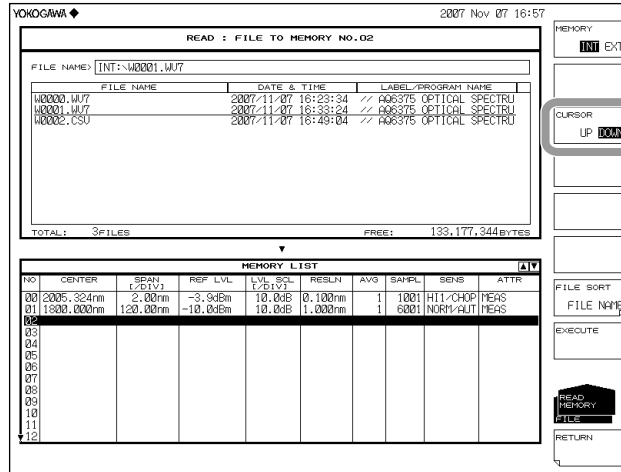

Executing the Load

10. Press the **EXECUTE** soft key. The file is loaded and registered into the specified memory number.

When the **RETURN** soft key is pressed, the file is not loaded. The screen returns to the previous stage.

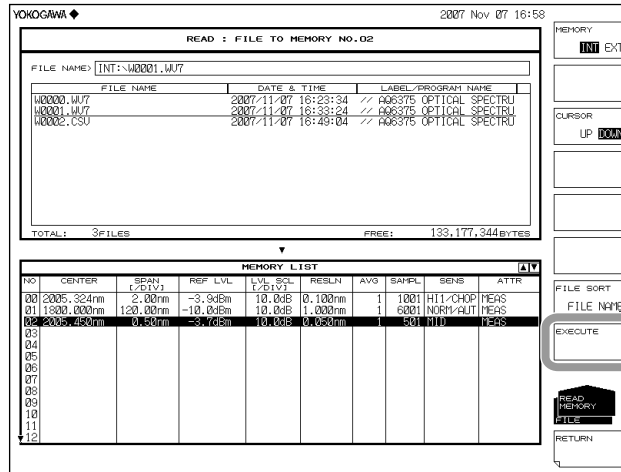

Explanation

You can save data from traces A–G to internal memory or a USB storage medium, or assign previously saved data to trace A–G and display it.

Also, you can save (MEMORY) data that was temporarily saved to internal memory or a USB storage medium, or register previously saved data to the temporary save memory.

Extensions

The extensions used when saving TRACE and MEMORY data are as follows.

BIN (binary format): .WV7

CSV (ASCII format): .CSV

File Name

You can have a file name automatically assigned, or specify an arbitrary name for the save. If you do not assign a file name, a file name is automatically assigned as follows.

File name: WXXXXX.CSV (or .WV7)

XXXX is a serial number from 0000 to 9999 or saved date and time

Note

Only use the characters allowed in file names by MS-DOS when changing a file name. The maximum file name length is 56 characters (including the extension). The following characters can be used in file names.

!#\$%&'()-

0123456789@

ABCDEFGHIJKLMNOPQRSTUVWXYZ^

abcdefghijklmnopqrstuvwxyz{|}~

Data Format

Data can be saved in the following two formats.

BIN

Saves the file in binary format.

With this selection, the waveform data cannot be directly checked using an external application. The file size is smaller than that obtained with ASCII format.

CSV

Saves the file in CSV (Comma Separated Value) ASCII format.

With this selection, the waveform data can be directly checked using an external application. The file size is larger than that obtained with binary format.

File Size

The file size differs depending on the data saved. Be sure to check whether sufficient space is available before saving.

File Sort

You can sort the file list in ascending order by file name, file type, file date, or label.

CSV Data Format

CSV data is saved in the following format.

```

75CSV
// AQ6375B OPTICAL SPECTRUM ANALYZER //
35
"CTRWL",1550.500000
"SPAN", 5.000000
"START WL",1548.000000
"STOP WL",1553.000000
"WLFREQ", 0
"REFL", +5.5
"LSCL",10.0
"RESLN",0.050
"AVG", 1
"SMPLAUTO", 1
"SMPL", 501
"SMPLINTVL",0.0100
"MID"
"MEAS"
"LSUNT",0
"NMSKH","OFF"
"RESCOR",0
"SMOOTH",0
"MEASWL",1
"SWPSPD",0
"CHGPT", 0
"RESCAL0_0", 10000
"RESCAL0_1", 0
"RESCAL0_2", 0
"RESCAL1_0", 10000
"RESCAL1_1", 0
"RESCAL1_2", 0
"RESPARM", 10000
"FREQPARM", 10000
"WNUMPARM", 10000

[TRACE DATA]
1548.0000, -55.653
1548.0100, -55.796
:
:
:
1553.0000, -52.706
    
```

Header

Measurement condition parameters

Waveform data

Header

75CSV	File header
// AQ6375B OPTICAL SPECTRUM ANALYZER //	Label (57 characters)
35	No. of measurement condition parameters

Measurement Condition Parameters

"CTRWL",1550.500000	Center wavelength
"SPAN", 5.000000	Span
"START WL",1548.000000	Measurement start wavelength
"STOP WL",1553.000000	Measurement stop wavelength
"WLFREQ", 0	Horizontal axis scale mode (0: wavelength mode, 1: frequency mode, 2:wavenumber mode)
"REFL", +5.5	Reference level
"LSCL",10.0	Main level scale
"RESLN",0.050	Measurement resolution
"AVG", 1	Averaging times
"SMPLAUTO", 1	Sampling points setting mode (0: MANUAL, 1: AUTO, 2: SMPL INTVL)
"SMPL", 501	The number of sampling points for measurements
"SMPLINTVL",0.0100	Measurement sampling interval
"HIGH 1"	Measurement sensitivity
"MEAS"	Measurement identifier
"LSUNT",0	Vertical axis scale mode (0: dBm, 1: dBm/nm)
"NMSKH","OFF"	Noise mask setting (NMSKV:VERTICAL, NMSKH:HORIZONTAL)
"RESCORE",0	Resolution correction setting (0: OFF, 1: ON)
"SMOOTH",0	Smoothing setting (0: OFF, 1: ON)
"MEASWL",1	Wavelength in the air or in a vacuum (0: AIR, 1: VACUUM)
"SWPSPD",0	Sweep speed (0: 1x, 1: 2x)
"CHGPT", 0	-
"RESCALO_0", 10000	Resolution effective value correction coefficient
"RESCALO_1", 0	Resolution effective value correction coefficient
"RESCALO_2", 0	Resolution effective value correction coefficient
"RESCAL1_0", 10000	Resolution effective value correction coefficient
"RESCAL1_1", 0	Resolution effective value correction coefficient
"RESCAL1_2", 0	Resolution effective value correction coefficient
"RESPARM", 10000	Wavelength resolution RMS coefficient
"FREQPARM", 10000	Frequency resolution RMS coefficient
"WNUMPARM", 10000	Wavenumber resolution RMS coefficient

The reference level and main level scale are saved to one of the following depending on the vertical scale.

Main level scale

Vertical Axis Scale	Save Format	Description
LOG	"REFL"***.	Reference level
	"LSCL"***.	Level scale
Linear	"REFL"***.	Reference level
	"LSCL"***.	Level scale
	"BASEL"***.**	Base level

7.3 Saving/Loading Displayed Data

Sub-level scale

Vertical Axis Scale	Save Format	Description
LOG	"REFL",***.*	Reference level
	"SSCLLOG",***.*	Level scale
	"LOFST",***.*	Level offset
Linear	"REFL",***.*	Reference level
	"SSCLN",***.*	Level scale
	"SMIN",***.*	Base level
DB/km	"REFL",***.*	Reference level
	"SSKM",**.*	Level scale
	"OFSKM",***.*	Offset level
	"LENG",**.*	Optical fiber length
%	"REFL",***.*	Reference level
	"SSPS",***.*	Level scale
	"SMINP",***.*	Base scale

Measurement Sensitivity

The data below is saved as measurement sensitivity depending on the measurement sensitivity type.

Format	Measurement Sensitivity Type
"NORM-HOLD"	NORM/HOLD
"NORM-AUTO"	NORM/AUTO
"NORMAL"	NORMAL
"MID"	MID
"HI1_CHOP"	HIGH 1/CHOP
"HI2_CHOP"	HIGH 2/CHOP
"HI3_CHOP"	HIGH 3/CHOP

Note

If PEAK HOLD is selected in pulse light measurement mode, a P- is added to the front of the data above. Similarly, if EXTERNAL TRIGGER is selected, an E- is added.

Measurement Identifier

The data below is saved as a waveform identifier depending on the waveform type.

Format	Waveform Type	Format	Waveform Type	Format	Waveform Type
"MEAS"	WRITE	"E-D"	E-D(LOG)	"C+FL"	C+F(LIN)
"MAXH"	MAX HOLD	"C+D"	C+D(LOG)	"C-FL"	C-F(LIN)
"MINH"	MIN HOLD	"D+E"	D+E(LOG)	"F-CL"	F-C(LIN)
"RAVG"	ROLL AVG	"C+DL"	C+D(LIN)	"E+FL"	E+F(LIN)
"A-B"	A-B(LOG)	"C-DL"	C-D(LIN)	"E-FL"	E-F(LIN)
"B-A"	B-A(LOG)	"D-CL"	D-C(LIN)	"F-EL"	F-E(LIN)
"A+B"	A+B(LOG)	"D+EL"	D+E(LIN)	"NORM A"	NORMALIZE A
"A-BL"	A-B(LIN)	"D-EL"	D-E(LIN)	"NORM B"	NORMALIZE
"B-AL"	B-A(LIN)	"E-DL"	E-D(LIN)	"NORM C"	NORMALIZE
"A+BL"	A+B(LIN)	"C-F"	C-F(LOG)	"CVFT A",**	CRV FIT A
"1-K(A/B)",*****	1-k(A/B)	"F-C"	F-C(LOG)	"CVFT B",**	CRV FIT B
"1-K(B/A)",*****	1-k(B/A)	"E-F"	E-F(LOG)	"CVFT C",**	CRV FIT C
"C-D"	C-D(LOG)	"F-E"	F-E(LOG)	"CVFTPK A",**	PK CRV FIT A
"D-C"	D-C(LOG)	"C+F"	C+F(LOG)	"CVFTPK B",**	PK CRV FIT B
"D-E"	D-E(LOG)	"E+F"	E+F(LOG)	"CVFTPK C",**	PK CRV FIT C

Waveform Data

Measures waveform data are stored as wavelength values and level values for the number of measurement sampling points.

A waveform measured in frequency mode is also stored as wavelength values. Level values are stored as log values if the vertical axis scale is LOG, and as linear values if the vertical axis scale is linear.

(For LOG Scale)

[TRACE DATA]	Header indicating the start of the trace data
****.****, ±****.***(CR)(LF)	Wavelength value and level value (LOG) of first point
****.****, ±****.***(CR)(LF)	Wavelength value and level value (LOG) of second point
:	
****.****, ±****.***(CR)(LF)	Wavelength value and level value (LOG) of final point

(For LINEAR Scale)

[TRACE DATA]	Header indicating the start of the trace data
****.****, *.*E±***(CR)(LF)	Wavelength value and level value (LINEAR) of first point
****.****, *.*E±***(CR)(LF)	Wavelength value and level value (LINEAR) of second point
:	
****.****, *.*E±***(CR)(LF)	Wavelength value and level value (LINEAR) of final point

7.4 Saving/Loading Displayed Data(All Trace)

Procedure

Waveform data displayed by the instrument (all completely-measured trace data) can be saved to or loaded from USB storage media.



CAUTION

Do not remove the USB storage medium or turn OFF the power when the USB storage medium's access indicator is blinking. Doing so can damage the medium or destroy the data on the medium. Also, when removing the USB storage medium, you must first place the medium in a removable state by following the instructions in section 7.1.



ATTENTION

Ne retirez pas le dispositif de stockage USB et ne coupez pas l'alimentation lorsque le voyant d'accès au dispositif de stockage USB clignote.

Cela risquerait d'endommager le dispositif ou les données se trouvant sur ce dernier. De plus, toujours faire passer un support de stockage USB à l'état de retrait en toute sécurité (en suivant la procédure figurant à la section 7.1) avant de le retirer.

Saving all trace data

Setting the file type of files to save to ALL TRACE

1. Press the **FILE** key. The soft key menu for data saving and loading appears.
2. Press the **ITEM SELECT** soft key. A menu for selecting files to save appears.
3. Press the **ALL TRACE** soft key. ALL TRACE becomes selected, and the screen returns to the previous menu.
4. Press the **WRITE** soft key. TRACE LIST is displayed on screen.

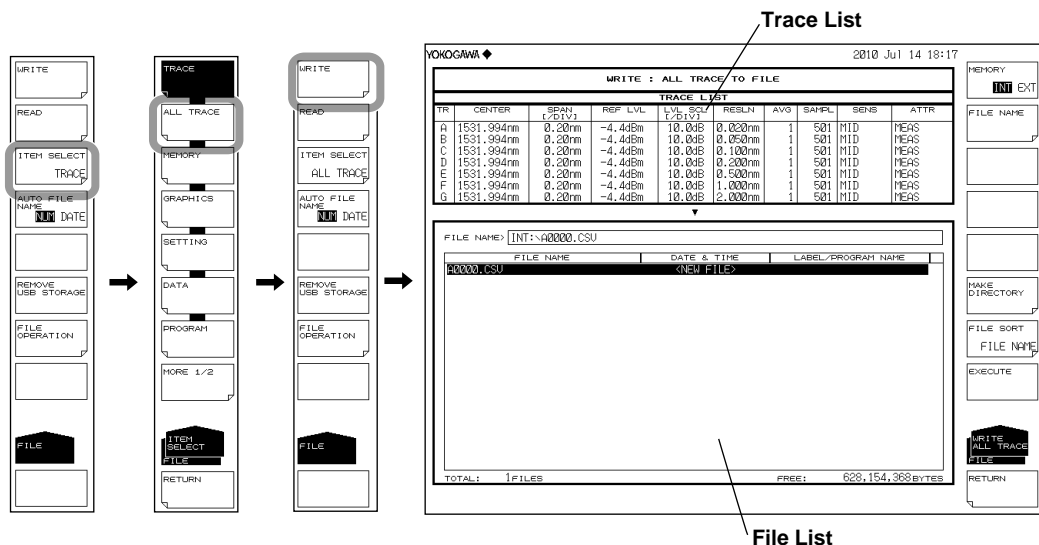

Selecting a save destination

- Press the **MEMORY** soft key, then specify a save destination of **INT** (internal memory) or **EXT** (USB storage medium).



Entering a file name (when saving to an arbitrary file name)

If a file name is not specified, it is automatically set to AXXXX.CSV (where XXXX is a serial number or saved date and time). For the auto file name, see section 7.3.

- Using the rotary knob, move the cursor to the row on the file list that displays **NEW FILE**.
- Press the **FILE NAME** soft key. The text input window and corresponding soft key menu appear.
- Enter a file name according to the instructions in section 4.3.
- Press the **DONE** soft key. The file name is entered, and you are returned to the previous screen.

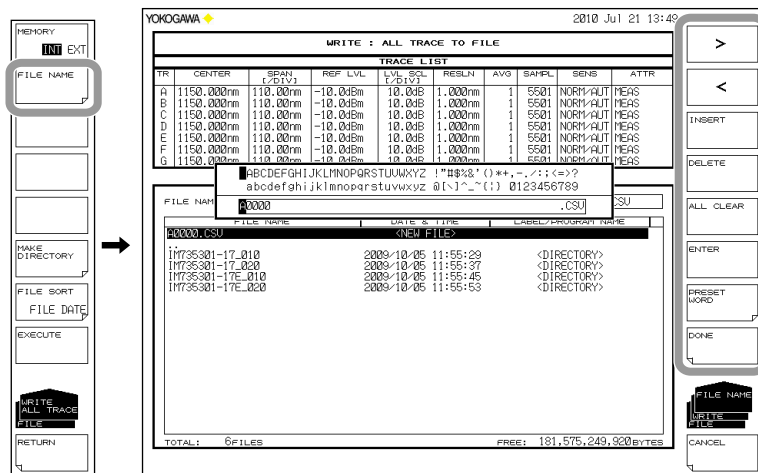

7.4 Saving/Loading Displayed Data(All Trace)

Executing the Save

10. To overwrite previously saved files, place the cursor on the existing file name.
11. Press the **EXECUTE** soft key. Saving executes.
If you press the **RETURN** soft key, saving is cancelled. The screen returns to the previous menu.
12. When overwriting during a save, a confirmation message appears. Press the **YES** soft key. To cancel saving (overwriting), press the **NO** soft key.

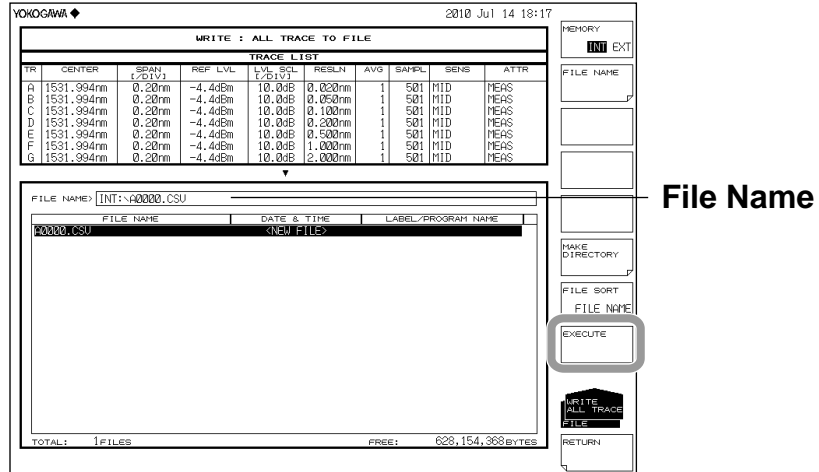

Loading all trace data

Setting the file type of files to load to ALL TRACE

1. Press the **FILE** key. The soft key menu for data saving and loading appears.
2. Press the **ITEM SELECT** soft key. A menu for selecting files to save appears.
3. Press the **TRACE ALL** soft key. TRACE becomes selected, and the screen returns to the previous menu.
4. Press the **READ** soft key. The file list is displayed on screen.

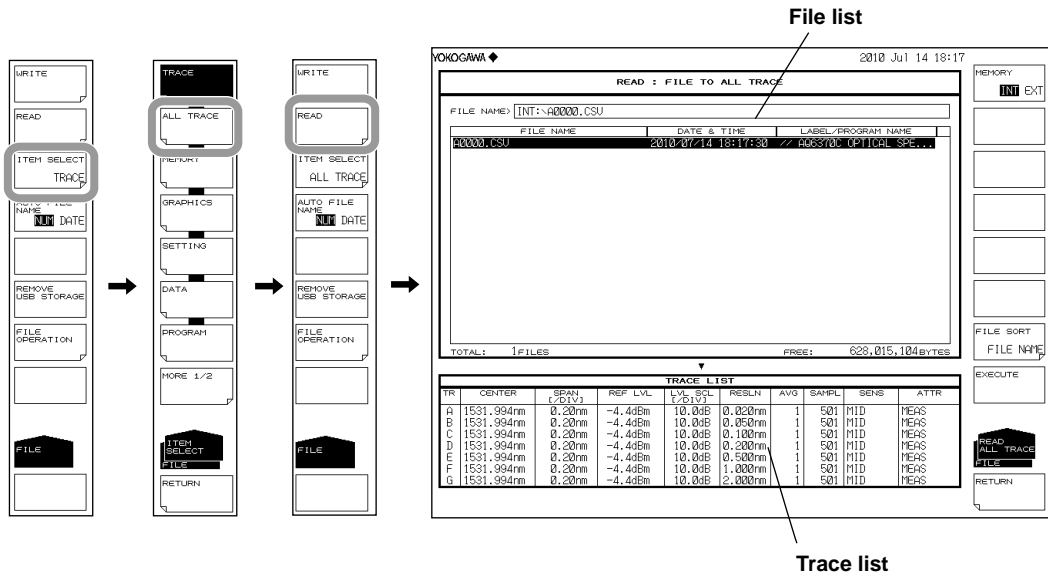

Selecting a file to load

- Press the **MEMORY** soft key, then specify **INT** (internal memory) or **EXT** (USB storage medium). The file list for the selected medium is displayed.
- Using the **rotary knob** or **arrow** keys, select the file to load from the file list. See page 7-9 for information on file sorting.

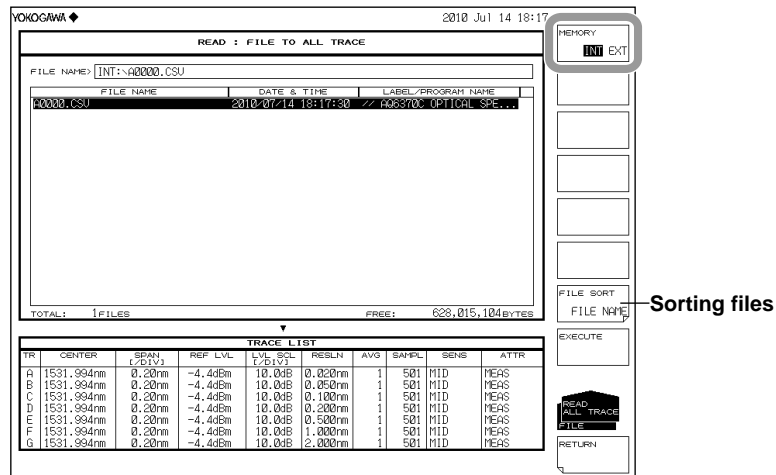

Executing the load

- Press the **EXECUTE** soft key. The file is loaded, and the specified trace number is displayed. If you press the **RETURN** soft key, loading is cancelled. The screen returns to the previous menu.

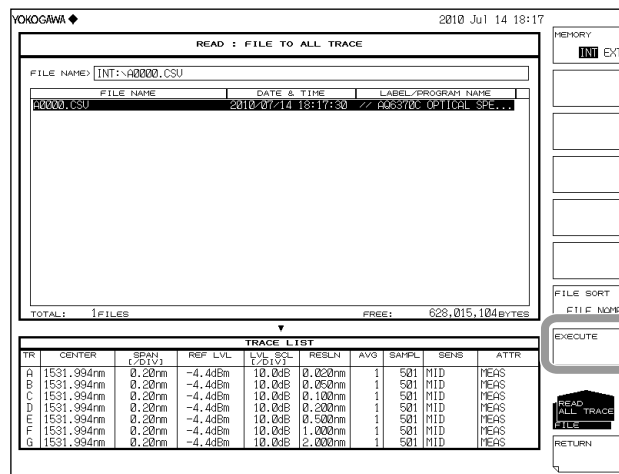

7.4 Saving/Loading Displayed Data(All Trace)

Explanation

You can save measured waveform data as a single file in internal memory or USB storage media, or load previously saved data into traces A through G for display.

Extension

Files are saved under the extension CSV.

File Name

File names can be assigned automatically, or arbitrarily by the user. If a file name is not set, it is saved automatically under the following name. For the auto file name, see section 7.3.

File Name: AXXXX.CSV

XXXX is a serial number from 0000 to 9999 or saved date and time.

Note

File names can only contain the same characters that are allowed for MS-DOS file names. File names can contain up to 56 characters (including the extension). The supported characters are as follows.

```
!#$%&'()-  
0123456789@  
ABCDEFGHIJKLMNOPQRSTUVWXYZ^  
abcdefghijklmnopqrstuvwxyz{}
```

File Size

The maximum file size differs depending on the data being saved. Make sure the save destination has sufficient space before saving.

Sorting files

The file list can be sorted in ascending order by FILE NAME, FILE DAT, or FILE LABEL.

CSV data format

CSV data is saved in the following format.

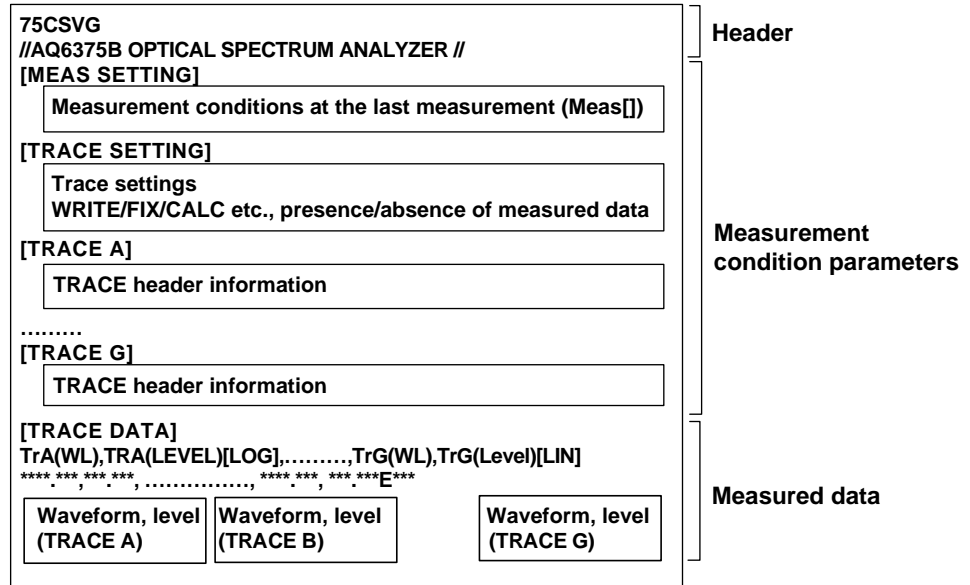

Header

75CSVG File header
 // AQ6375B OPTICAL SPECTRUM ANALYZER // label (57 characters)

Measurement condition parameters

Measurement conditions of each trace, measurement conditions when files were saved, and trace settings are saved.

[MEAS SETTING] section: Measurement settings when files were saved
 [TRACE SETTING] section: Trace settings (active trace information, each trace's settings, presence/absence of measured data)

[TRACE A] to [TRACE G]: Measurement conditions for each trace

The format of the measurement conditions is the same as that of waveform files. See 7.3, "Saving and Loading Waveform Data."

Measured data

The measured waveform data of traces A through G are saved as wavelength and level values of the measured number of samples. Unmeasured trace data is not saved. Waveforms measured in Frequency mode are also saved as wavelength values.

7.5 Saving/Loading Setting Data

Procedure

The measurement conditions set on the instrument and soft key set statuses are saved in binary format.



CAUTION

Do not remove the USB storage medium or turn the power OFF while the USB storage medium access indicator is blinking. This can damage the data on the medium or the device itself. Also, always place a USB storage medium in the removable state (following the procedure in section 7.1) before removing it.

French



ATTENTION

Ne retirez pas le dispositif de stockage USB et ne coupez pas l'alimentation lorsque le voyant d'accès au dispositif de stockage USB clignote.

Cela risquerait d'endommager le dispositif ou les données se trouvant sur ce dernier. De plus, toujours faire passer un support de stockage USB à l'état de retrait en toute sécurité (en suivant la procédure figurant à la section 7.1) avant de le retirer.

Setting the Type of the File to Be Saved to SETTING

1. Press **FILE**.
2. Press the **ITEM SELECT** soft key. The soft key menu switches.
3. Press the **SETTING** soft key. SETTING is selected, and the screen returns to the previous stage.
4. Press the **WRITE** soft key. The file list is displayed.

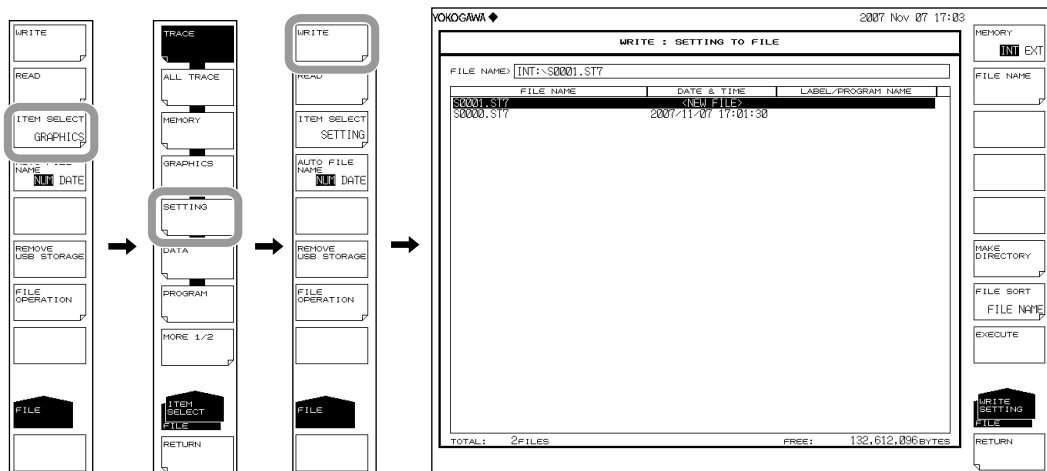

Selecting the Save Destination Medium

- Press the **MEMORY** soft key and specify INT (internal memory) or EXT (USB storage medium). A file list of the selected medium is displayed.



Entering the Name of the File to Be Saved

If a file name is not entered, it is automatically assigned in the form SXXXX.ST7 (where XXXX is a serial number or saved date and time).

For creating a directory and sorting the file list, see the page 7-9.

For the auto file name, see section 7.3.

- Using the rotary knob or arrow keys, move the cursor to the line in the file list displaying NEW FILE.
- Press the **FILE NAME** soft key. The text entry window and corresponding soft key menu are displayed.
- Follow the instructions in section 3.3 to enter a file name.
- Press the **DONE** soft key. The file name is confirmed, and the screen returns to the previous stage.

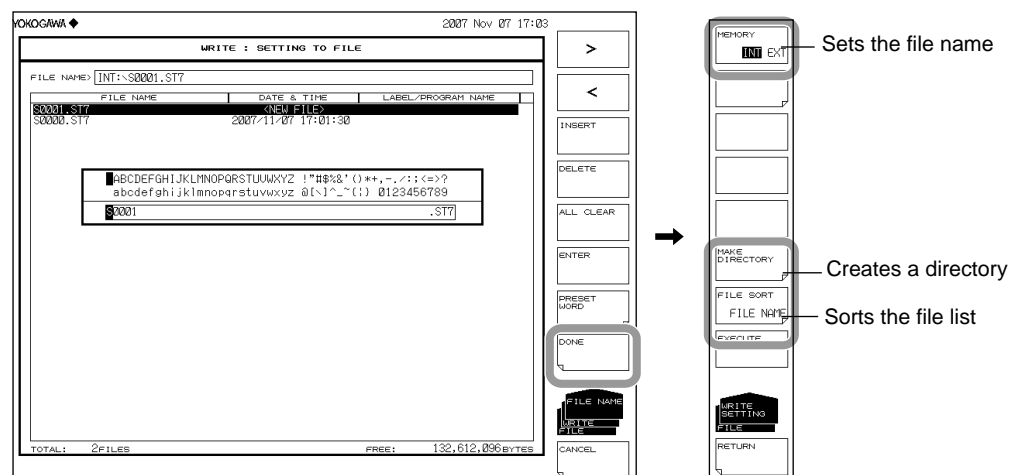

Executing the Save

10. To overwrite an existing file, move the cursor to the file name to be overwritten.
11. Press the **EXECUTE** soft key. The save executes.
When the **RETURN** soft key is pressed, the data is saved. The screen returns to the previous stage.
12. When overwriting during a save, a confirmation message appears. Press the **YES** soft key.
To cancel the save press **NO** soft key.

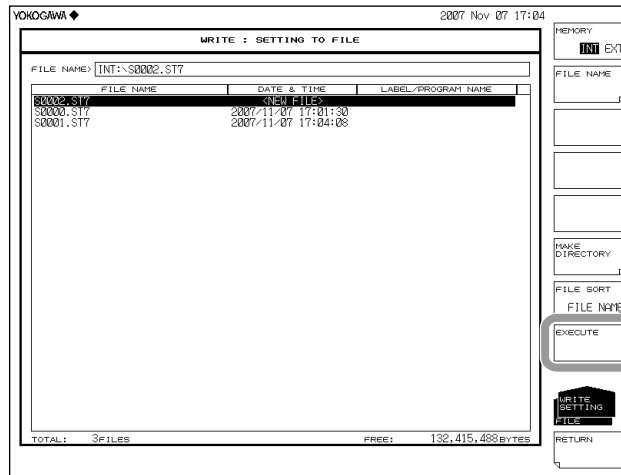

Loading Settings

Setting the Type of the File to Be Loaded to SETTING

1. Press **FILE**.
2. Press the **ITEM SELECT** soft key. The soft key menu switches.
3. Press the **SETTING** soft key. SETTING is selected, and the screen returns to the previous stage.
4. Press the **READ** soft key. The file list is displayed.

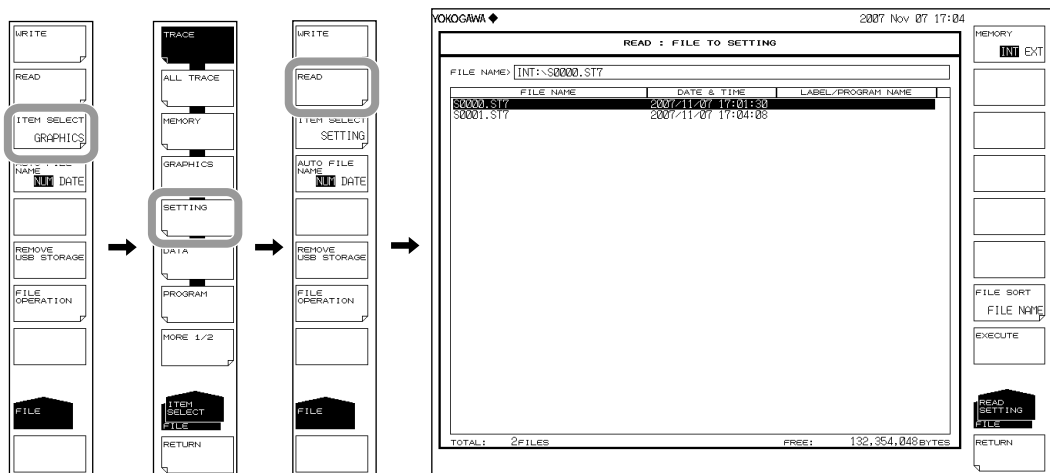

Selecting the File to Be Loaded

5. Press the **MEMORY** soft key and specify INT (internal memory) or EXT (USB storage medium). A file list of the selected medium is displayed.
6. Select a file to load from the file list using the rotary knob or the arrow keys.
You can also press the **FILE SORT** soft key to sort the files. For more information, see page 7-9.

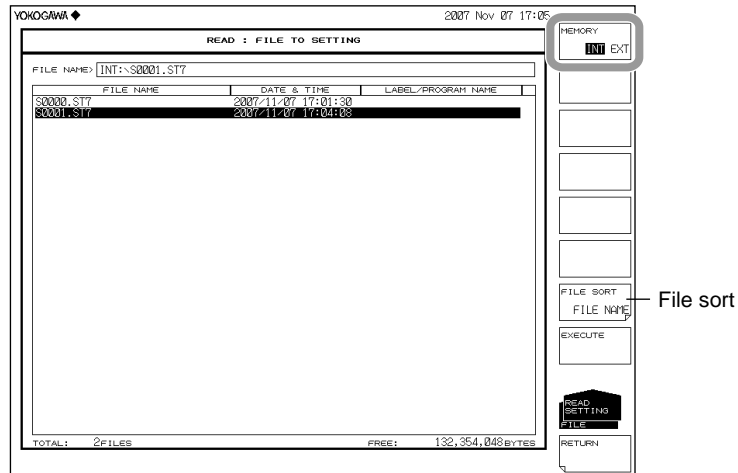

Executing the Load

7. Press the **EXECUTE** soft key. The file is loaded and the settings on the instrument are changed.

When the **RETURN** soft key is pressed, the file is not loaded. The screen returns to the previous stage.

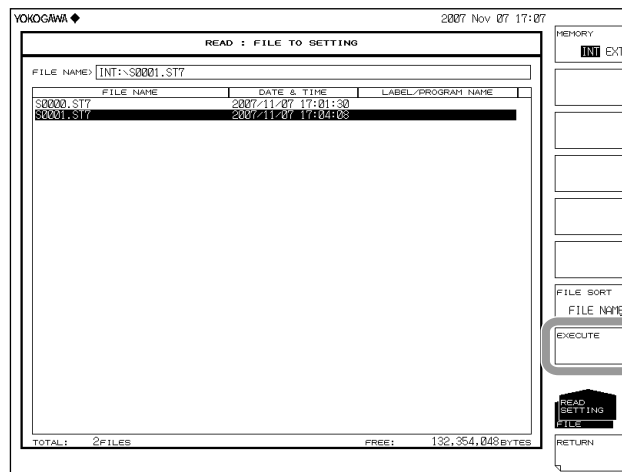

Explanation

You can save instrument setting data to internal memory or a USB storage medium, or load previously saved setting data and modify the settings.

Extension

The extension used when loading is .ST7.

File Name

You can have a file name automatically assigned, or specify an arbitrary name for the save. If you do not assign a file name, a file name is automatically assigned as follows. For the auto file name, see section 7.3. File name:

SXXXX.ST7

XXXX is a serial number from 0000 to 9999 or saved date and time.

Note

Only use the characters allowed in file names by MS-DOS when changing a file name. The maximum file name length is 56 characters (including the extension). The following characters can be used in file names.

!#\$%&'()-

0123456789@

ABCDEFGHIJKLMNOPQRSTUVWXYZ^

abcdefghijklmnopqrstuvwxyz`

File Size

The file size is approximately 74 KB.

File Sort

You can sort the file list in ascending order by file name, file type, file date, or label.

7.6 Saving/Loading Analysis Results Data

Procedure

You can save analysis results including the time and waveform data of the original save in ASCII or binary format.



CAUTION

Do not remove the USB storage medium or turn the power OFF while the USB storage medium access indicator is blinking. This can damage the data on the medium or the device itself. Also, always place a USB storage medium in the removable state (following the procedure in section 7.1) before removing it.

French



ATTENTION

Ne retirez pas le dispositif de stockage USB et ne coupez pas l'alimentation lorsque le voyant d'accès au dispositif de stockage USB clignote.

Cela risquerait d'endommager le dispositif ou les données se trouvant sur ce dernier. De plus, toujours faire passer un support de stockage USB à l'état de retrait en toute sécurité (en suivant la procédure figurant à la section 7.1) avant de le retirer.

Setting the Type of the File to Be Saved to DATA

1. Press **FILE**.
2. Press the **ITEM SELECT** soft key. The soft key menu switches.
3. Press the **DATA** soft key. DATA is selected, and the screen returns to the previous stage.
4. Press the **WRITE** soft key. The file list is displayed.

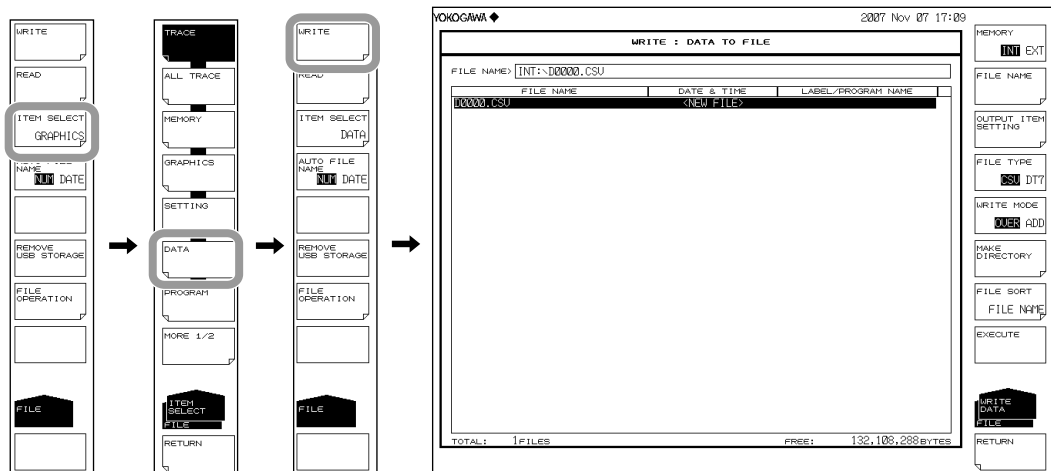

Selecting the Save Destination Medium and Data Format

5. Press the **MEMORY** soft key and specify INT (internal memory) or EXT (USB storage medium). A file list of the selected medium is displayed.
6. Press the **FILE TYPE** soft key and specify a data format of DT7 (ASCII) or CSV (ASCII format).

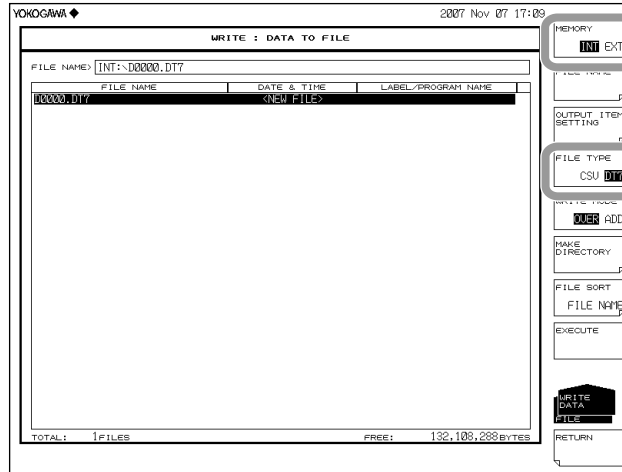

Selecting Data Items to Save

7. Press the **OUTPUT ITEM SETTING** soft key. The menu for selecting data items to be saved is displayed.
8. Press the **Data Item** soft key and specify ON (save) or OFF (do not save).

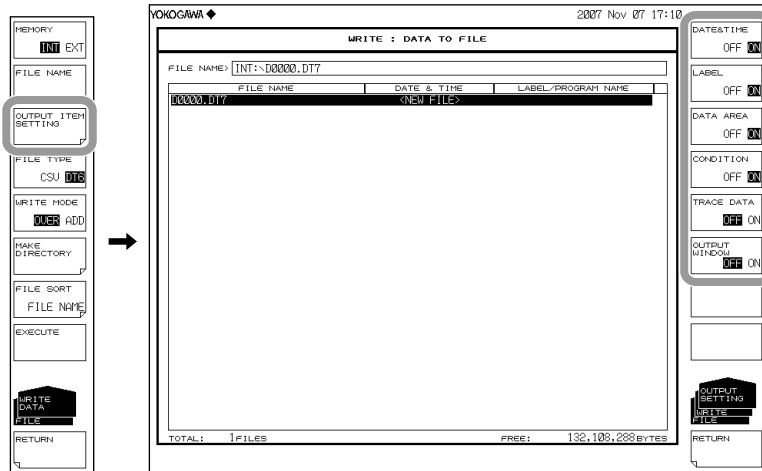

Entering the Name of the File to Be Saved

If a file name is not entered, it is automatically assigned in the form DXXXX.DT7 or DXXXX.CSV (where XXXX is a serial number or saved date and time).

For creating a directory and sorting the file list, see the page 7-9.

For the auto file name, see section 7.3.

9. Using the rotary knob or arrow keys, move the cursor to the line in the file list displaying NEW FILE.
10. Press the **FILE NAME** soft key. The text entry window and corresponding soft key menu are displayed.
- 11 Follow the instructions in section 3.3 to enter a file name.
12. Press the **DONE** soft key. The file name is confirmed, and the screen returns to the previous stage.

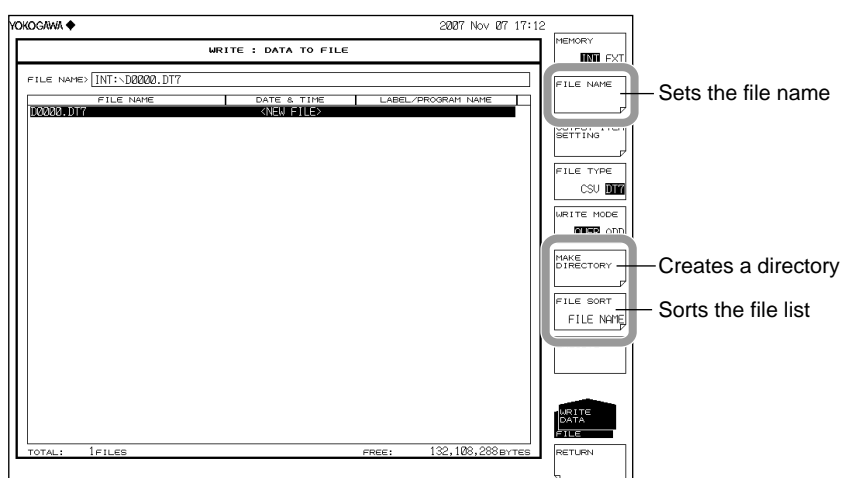

Setting the Save Method and Executing the Save

13. Press the **WRITE MODE** soft key and specify OVER (overwrite) or ADD (add).
14. To overwrite an existing file, move the cursor to the file name to be overwritten.
15. Press the **EXECUTE** soft key. The save executes.

When the **RETURN** soft key is pressed, the data is saved. The screen returns to the previous menu.

16. When overwriting during a save, a confirmation message appears. Press the **YES** soft key. To cancel the save press **NO** soft key.

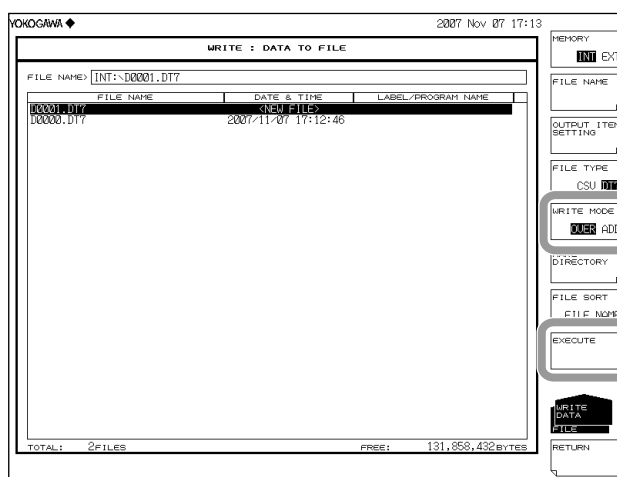

Loading Analysis Data

Setting the Type of the File to Be Loaded to DATA

1. Press **FILE**.
2. Press the **ITEM SELECT** soft key. The soft key menu switches.
3. Press the **DATA** soft key. DATA is selected, and the screen returns to the previous stage.
4. Press the **READ** soft key. The file list is displayed.

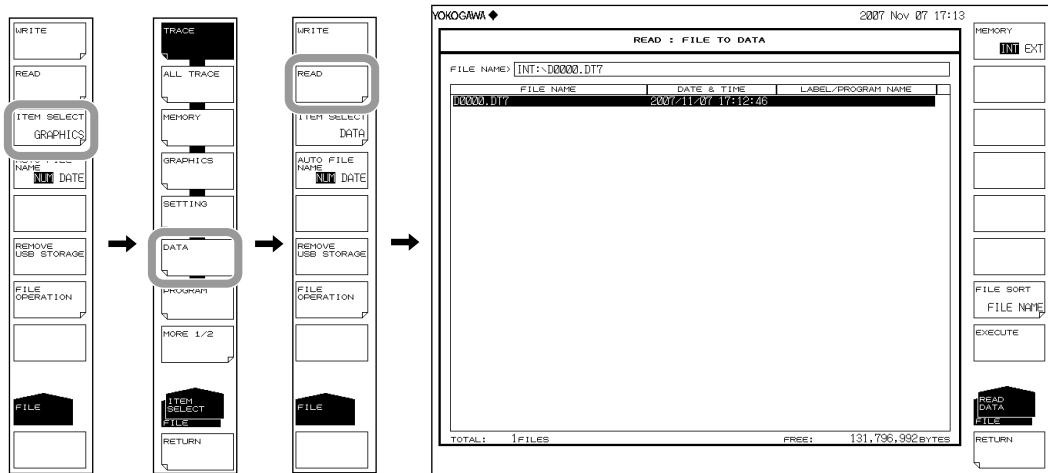

Selecting the File to Be Loaded

5. Press the **MEMORY** soft key and specify INT (internal memory) or EXT (USB storage medium). A file list of the selected medium is displayed.
6. Select a file to load from the file list using the **rotary knob** or the **arrow keys**. You can also press the **FILE SORT** soft key to sort the files. For more information, see page 7-9.

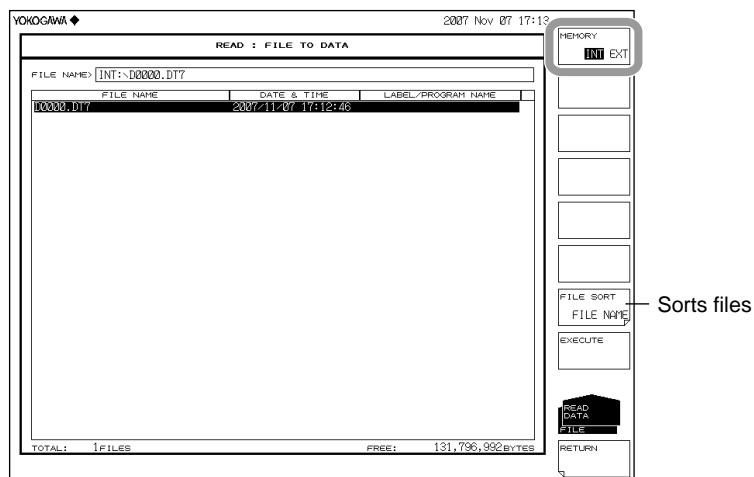

Executing the Load

7. Press the **EXECUTE** soft key. The file is loaded.

When the **RETURN** soft key is pressed, the file is not loaded. The screen returns to the previous stage.

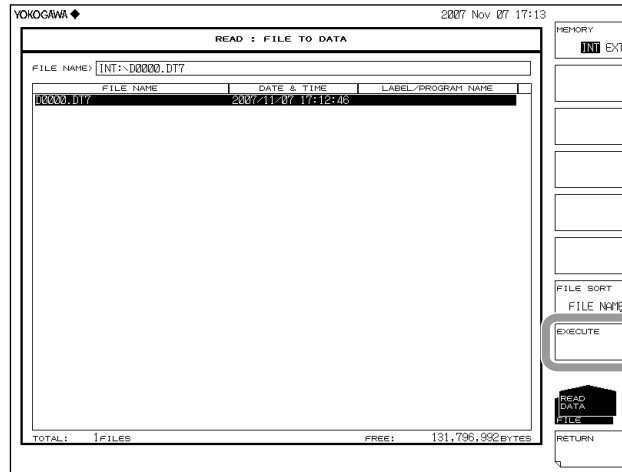

Explanation

Extensions

The extensions used when saving are as follows.

DAT (ASCII format): .DT7

CSV (ASCII format): .CSV

File Name

You can have a file name automatically assigned, or specify an arbitrary name for the save. If you do not assign a file name, a file name is automatically assigned as follows.

For the auto file name, see section 7.3.

File name: DXXXX.CSV (or .DT7)

XXXX is a serial number from 0000 to 9999 or saved date and time.

Note

Only use the characters allowed in file names by MS-DOS when changing a file name. The maximum file name length is 56 characters (including the extension).

The following characters can be used in file names.

!#\$%&'()-

0123456789@

ABCDEFGHIJKLMNOPQRSTUVWXYZ^

abcdefghijklmnopqrstuvwxyz{}

Saveable Data

The following data can be saved.

Saved Item	Initial Value	Description
DATE&TIME	ON	Date and time
LABEL	ON	Label
DATA AREA	ON	Data area value
CONDITION	ON	Measurement conditions
TRACE DATA	OFF	Trace data
OUTPUT WINDOW	OFF	Output window data used by program function

File Size

The file size differs depending on the data saved. Be sure to check whether sufficient space is available before saving.

File Sort

You can sort the file list in ascending order by file name, file type, file date, or label.

Overwrite Method

If files of the same name reside in the save destination, you can select whether to overwrite them or add the data.

OVER: Overwrites the file.

ADD: Adds the data to be saved to the existing file data.

Data Format

You can save in ASCII format.

DT7

Saves as text data.

CSV

Saves the file in CSV (comma separated value) ASCII format.

Data Format

DT7 format is as follows.

```

"75DAT "           ] Label
"                   ]
2006 Apr 07 16:42  ] Date/time of save
"<NF ANALYSIS> TH:20.00dB MODE DIFF:3.00dB OFST(IN):0.00dB OFST(OUT):0.00dB"
" ASE ALGO:AUTO-FIX FIT AREA:AUTO MASK AREA:--- FIT ALGO:LINEAR "
" NO.   WAVELENGTH INPUT LVL OUTPUT LVL ASE LVL RESOLN  GAIN   NF"      ] Header and data
"      [nm]         [dBm]   [dBm]   [dBm]  [nm]   [dB]   [dB]"    ] analysis results
"  1    1544.4983   -29.320 -2.260  -22.281 0.102  27.017 8.533 "
"  2    1545.3041   -29.530 -2.420  -22.184 0.101  27.064 8.619 "

"CTRWL 1551.670000" ]
"SPAN  20.000000"   ]
"REFL -10.0 dBm"    ]
"LSCL 10.0"         ]
"RESLN 0.100"       ] Measurement condition parameter
"AVG", 1             ]
"SMPL 2001"         ]
"HIGH 2"             ]
"NMSK OFF"          ]
1541.6700, -23.200 ] Sampling point portion of the waveform data
..... ..           ] (wavelength and level value)
    
```

7.6 Saving/Loading Analysis Results Data

CSV format is as follows.

75DAT2	}	Label		
TEST				
2005 Apr 07 16:42	}	Date/time data saved		
<NF ANALYSIS>				
TH[dB],20.00	}	Analysis results header and data		
MODE DIFF[dB],3.00				
OFST(IN)[dB],0.00				
OFST(OUT)[dB],0.00				
ASE ALGO,AUTO-FIX				
FIT AREA,AUTO				
MASK AREA,---				
FIT ALGO,LINEAR				
NO.,WAVELENGTH[nm],INPUT LVL[dBm],OUTPUT LVL[dBm],				
ASE LVL[dBm],RESOLN[nm],GAIN[dB],NF[dB]				
1,1544.4983,-29.320,-2.260,-22.281,0.102,27.017,8.533				
2,1545.3041,-29.530,-2.420,-22.184,0.101,27.064,8.619				
CTRWL,1551.670000			}	Measurement condition parameter
SPAN,20.000000				
REFL[dBm],-10.0				
LSCL,10.0				
RESLN,0.100				
AVG,1				
SMPL,2001				
HIGH 2				
NMSK,OFF	}	Sampling point portion of the waveform data (wavelength and level value)		
1541.6700, -23.200				

7.7 Saving/Loading Program Data

Procedure

Programs created with the program function are saved in binary format.



CAUTION

Do not remove the USB storage medium or turn the power OFF while the USB storage medium access indicator is blinking. This can damage the data on the medium or the device itself. Also, always place a USB storage medium in the removable state (following the procedure in section 7.1) before removing it.

French



ATTENTION

Ne retirez pas le dispositif de stockage USB et ne coupez pas l'alimentation lorsque le voyant d'accès au dispositif de stockage USB clignote. Cela risquerait d'endommager le dispositif ou les données se trouvant sur ce dernier. De plus, toujours faire passer un support de stockage USB à l'état de retrait en toute sécurité (en suivant la procédure figurant à la section 7.1) avant de le retirer.

Setting the Type of the File to Be Saved to PROGRAM

1. Press **FILE**.
2. Press the **ITEM SELECT** soft key. The soft key menu switches.
3. Press the **PROGRAM** soft key. PROGRAM is selected, and the screen returns to the previous stage.
4. Press the **WRITE** soft key to display the program list and file list.

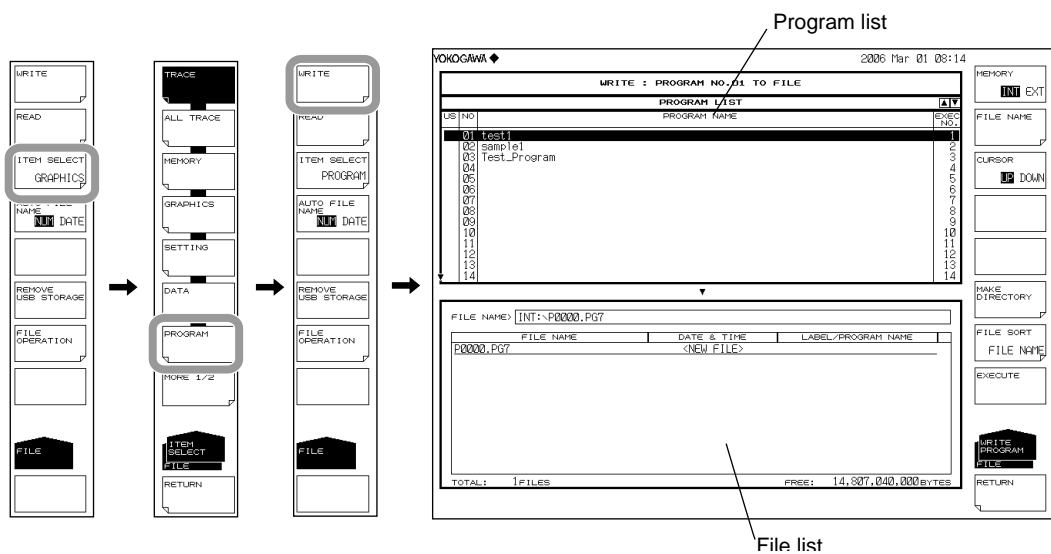

Selecting the Save Destination and Data Format

5. Press the **MEMORY** soft key and specify a save destination of INT (internal memory) or EXT (USB storage medium).



Selecting a Memory Number to Save

6. Press the **CURSOR** soft key, then set the cursor selection to UP (on the program list side).
7. Select the program number of the data to save using the rotary knob, arrow keys, or numeric key pad.

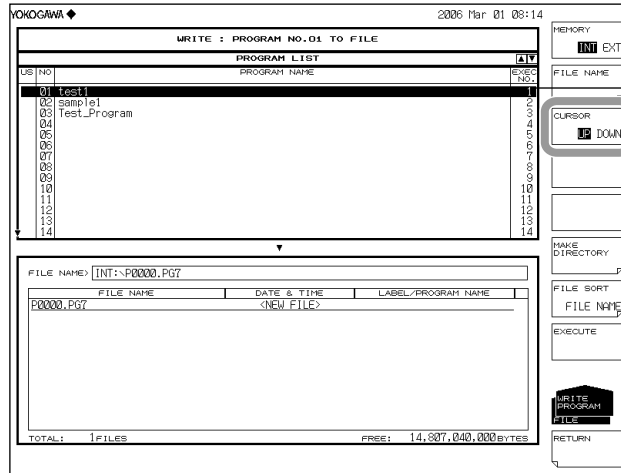

Selected program number

Entering the Name of the File to Be Saved

If a file name is not entered, it is automatically assigned in the form PXXXX.PG7 (where XXXX is a serial number or saved date and time).

For creating a directory and sorting the file list, see the page 7-9.

For the auto file name, see section 7.3.

8. Press the **CURSOR** soft key, then set the cursor selection to DOWN (on the file list side). An underscore is displayed with the program number selected in step 7.
9. Using the **rotary knob** or **arrow keys**, move the cursor to the line in the file list displaying NEW FILE.
10. Press the **FILE NAME** soft key. The text entry window and corresponding soft key menu are displayed.
- 11 Follow the instructions in section 3.3 to enter a file name.
12. Press the **DONE** soft key. The file name is confirmed, and the screen returns to the previous stage.

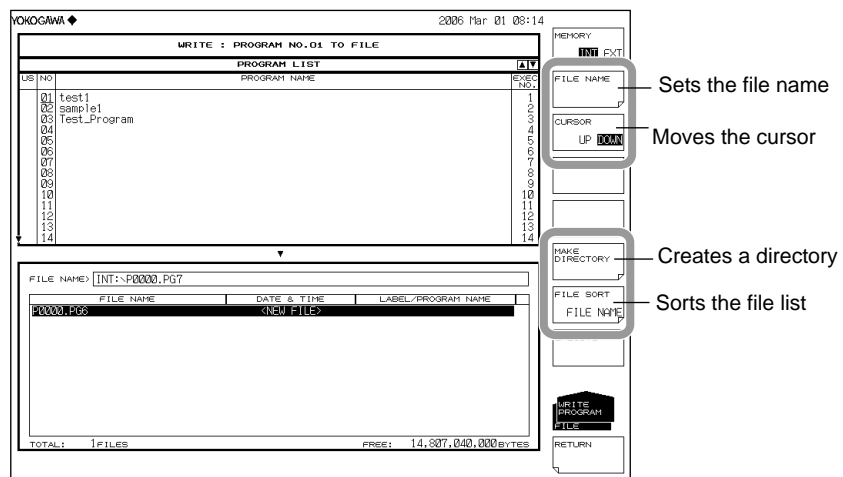

Executing the Save

13. To overwrite an existing file, move the cursor to the file name to be overwritten.

14. Press the **EXECUTE** soft key. The save executes.

When the **RETURN** soft key is pressed, the data is saved. The screen returns to the previous menu.

15. When overwriting during a save, a confirmation message appears. Press the **YES** soft key. To cancel the save press **NO** soft key.

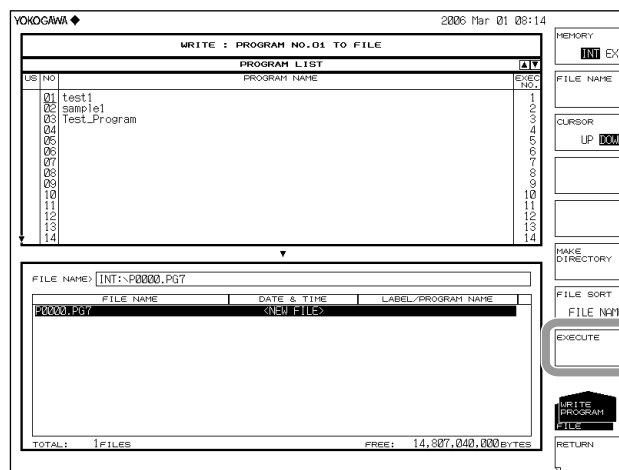

Loading a Program File

Setting the Type of the File to Be Loaded to PROGRAM

1. Press **FILE**.
2. Press the **ITEM SELECT** soft key. The soft key menu switches.
3. Press the **PROGRAM** soft key. PROGRAM is selected, and the screen returns to the previous stage.
4. Press the **READ** soft key. The program list is displayed.

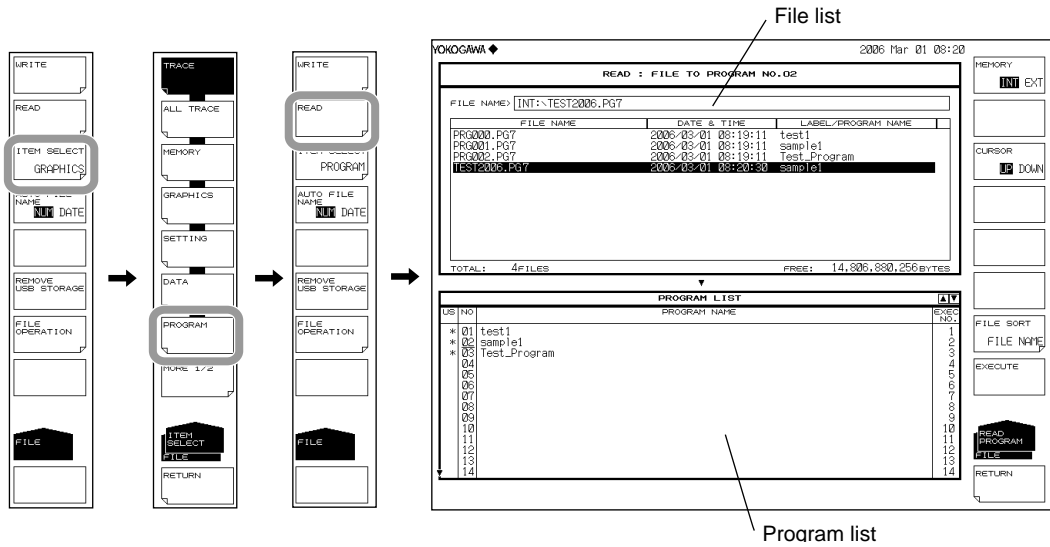

Selecting the File to Be Loaded

5. Press the **MEMORY** soft key and specify INT (internal memory) or EXT (USB storage medium). A file list of the selected medium is displayed.
6. Press the **CURSOR** soft key, then set the cursor selection to UP (on the file list side).
7. Select a file to load from the file list using the rotary knob or the arrow keys.
You can also press the **FILE SORT** soft key to sort the files. For more information, see page 7-9.

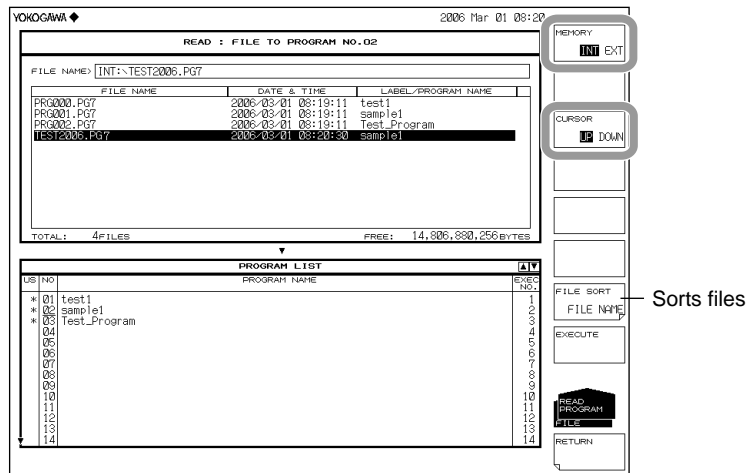

Selecting a Program Number to Save

8. Press the **CURSOR** soft key, then set the cursor selection to DOWN (on the program list side).
9. Select the program number of the load destination using the rotary knob, arrow keys, or numeric key pad.

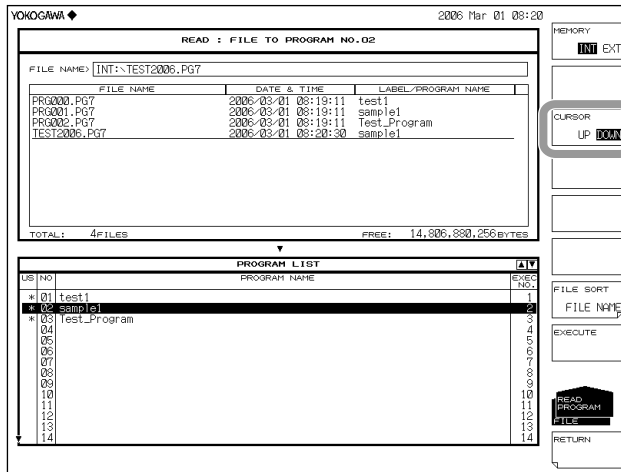

Executing the Load

10. Press the **EXECUTE** soft key. The file is loaded and registered to the specified program number.

When the **RETURN** soft key is pressed, the file is not loaded. The screen returns to the previous stage.

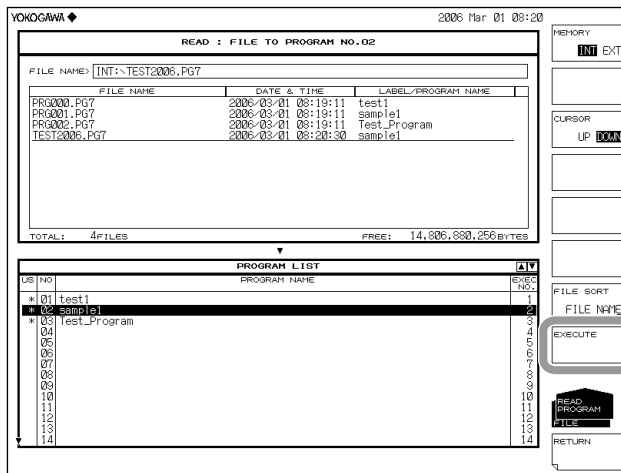

Explanation

Extension

The extension used when saving is as follows.
BIN (binary format): .PG7

File Name

You can have a file name automatically assigned, or specify an arbitrary name for the save. If you do not assign a file name, a file name is automatically assigned as follows. For the auto file name, see section 7.3.

File name: PXXXX.PG7

XXXX is a serial number from 0000 to 9999 or saved date and time.

Note

Only use the characters allowed in file names by MS-DOS when changing a file name. The maximum file name length is 56 characters (including the extension).

The following characters can be used in file names.

!#\$%&'()-

0123456789@

ABCDEFGHIJKLMN OPQRSTUVWXYZ^

abcdefghijklmnopqrstuvwxyz{}⁻

File Size

The file size is approximately 13 KB.

Data Format

Saves the file in binary format.

7.8 Saving Screen Image Data

Procedure

You can save the screen as an image file.



CAUTION

Do not remove the USB storage medium or turn the power OFF while the USB storage medium access indicator is blinking. This can damage the data on the medium or the device itself. Also, always place a USB storage medium in the removable state (following the procedure in section 7.1 before removing it).

French



ATTENTION

Ne retirez pas le dispositif de stockage USB et ne coupez pas l'alimentation lorsque le voyant d'accès au dispositif de stockage USB clignote.

Cela risquerait d'endommager le dispositif ou les données se trouvant sur ce dernier. De plus, toujours faire passer un support de stockage USB à l'état de retrait en toute sécurité (en suivant la procédure figurant à la section 7.1) avant de le retirer.

Setting the Type of the File to Be Saved to GRAPHIC

1. Press **FILE**.
2. Press the **ITEM SELECT** soft key. The soft key menu switches.
3. Press the **GRAPHIC** soft key. GRAPHIC is selected, and the screen returns to the previous stage.
4. Press the **WRITE** soft key to display the file list.

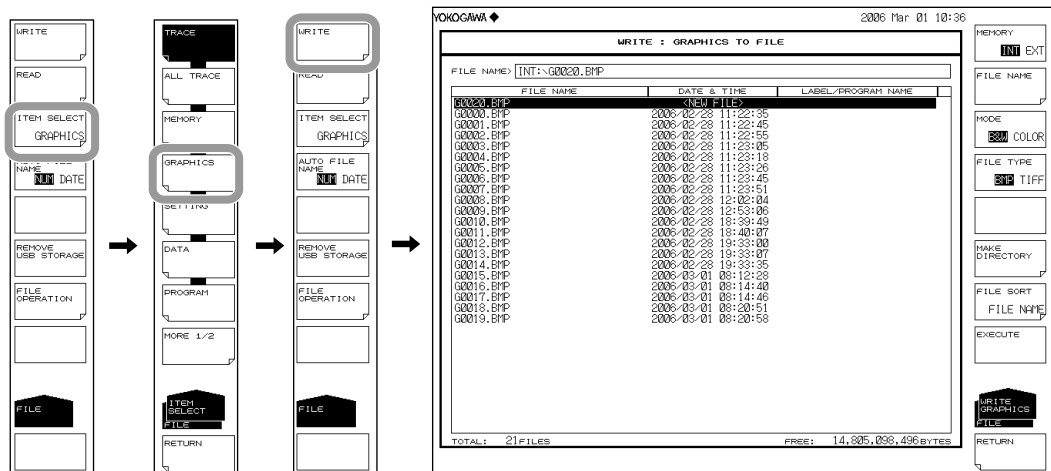

Selecting the Save Destination and Data Format

5. Press the **MEMORY** soft key and specify a save destination of INT (internal memory) or EXT (USB storage medium).



Selecting the Color

6. Press the **MODE** soft key and specify B&W (black & white), COLOR, or PRESET COL (only waveform markers in color).

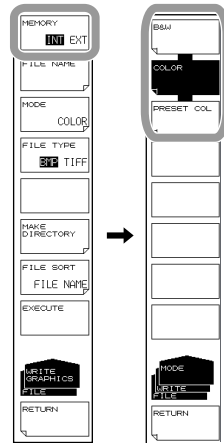

Selecting the Color and File Format

7. Press the **FILE TYPE** soft key to select BMP or TIFF.

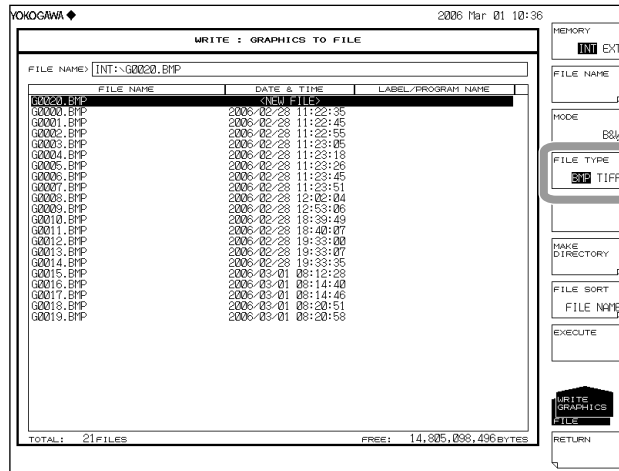

Entering the Name of the File to Be Saved

If a file name is not entered, it is automatically assigned in the form GXXXX.BMP or GXXXX.TIF (where XXXX is a serial number or saved date and time).

For creating a directory and sorting the file list, see the page 7-9.

For the auto file name, see section 7.3.

8. Press the **CURSOR** soft key, then set the cursor selection to DOWN (on the file list side). An underscore is displayed with the program number selected in step 7.
9. Using the **rotary knob** or **arrow keys**, move the cursor to the line in the file list displaying NEW FILE.
10. Press the **FILE NAME** soft key. The text entry window and corresponding soft key menu are displayed.
- 11 Follow the instructions in section 3.3 to enter a file name.
12. Press the **DONE** soft key. The file name is confirmed, and the screen returns to the previous stage.

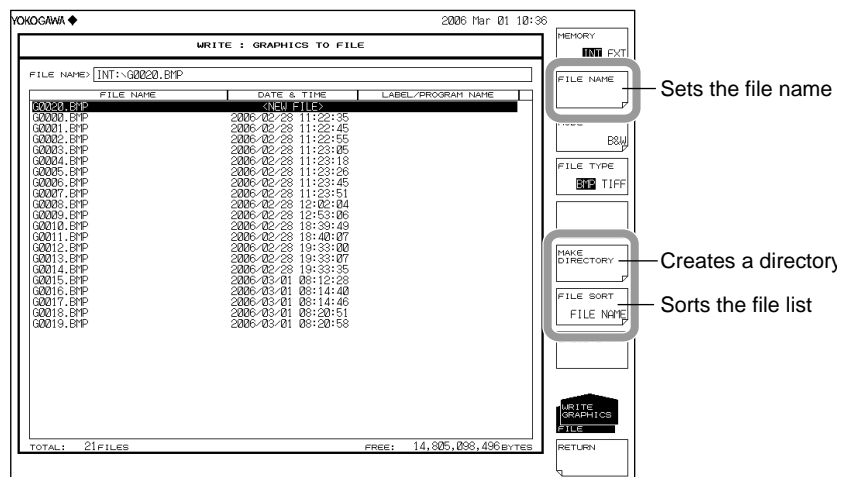

Executing the Save

14. To overwrite an existing file, move the cursor to the file name to be overwritten.
15. Press the **EXECUTE** soft key. The save executes.

When the **RETURN** soft key is pressed, the data is saved. The screen returns to the previous stage.

16. When overwriting during a save, a confirmation message appears. Press the **YES** soft key. To cancel the save press **NO** soft key.

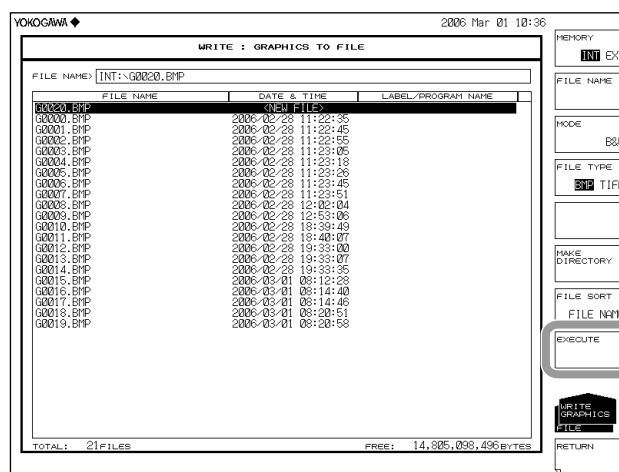

Explanation

Extensions

The extensions used when saving are as follows.

- BMP (bit-mapped format): .BMP
- TIFF: .TIF

File Name

You can have a file name automatically assigned, or specify an arbitrary name for the save. If you do not assign a file name, a file name is automatically assigned as follows. For the auto file name, see section 7.3.

- File name: GXXXX.BMP or GXXXX.TIF
- XXXX is a serial number from 0000 to 9999 or saved date and time.

Note

Only use the characters allowed in file names by MS-DOS when changing a file name. The maximum file name length is 56 characters (including the extension). The following characters can be used in file names.

- !#\$%&'()-
 - 0123456789@
 - ABCDEFGHIJKLMNOPQRSTUVWXYZ^
 - abcdefghijklmnopqrstuvwxyz{}
-

Color

You can save the file in black and white or color. If set to PRESET COLOR, only waveforms and markers are displayed in color; all other items (e.g., soft keys, grid, text, background) are displayed in black & white.

Data Format

You can save the file as a bit-mapped (BMP) or TIFF file.

File Size

The file size differs depending on the data format and color specified.

- BMP (color): Differs depending on the display color.
- BMP (B&W): Approximately 52 KB
- TIFF (color): Approximately 412 KB
- TIFF (black & white): Approximately 52 KB

7.9 Saving/Loading Template Data

Procedure

You can save or load template file in CSV format.



CAUTION

Do not remove the USB storage medium or turn the power OFF while the USB storage medium access indicator is blinking. This can damage the data on the medium or the device itself. Also, always place a USB storage medium in the removable state (following the procedure in section 7.1) before removing it.

French



ATTENTION

Ne retirez pas le dispositif de stockage USB et ne coupez pas l'alimentation lorsque le voyant d'accès au dispositif de stockage USB clignote. Cela risquerait d'endommager le dispositif ou les données se trouvant sur ce dernier. De plus, toujours faire passer un support de stockage USB à l'état de retrait en toute sécurité (en suivant la procédure figurant à la section 7.1) avant de le retirer.

Setting the Type of the File to Be Saved to TEMPLATE

1. Press **FILE**.
2. Press the **ITEM SELECT** soft key. The soft key menu switches.
3. Press the **TEMPLATE** soft key. **TEMPLATE** is selected, and the screen returns to the previous stage.
4. Press the **WRITE** soft key to display the template list and file list.

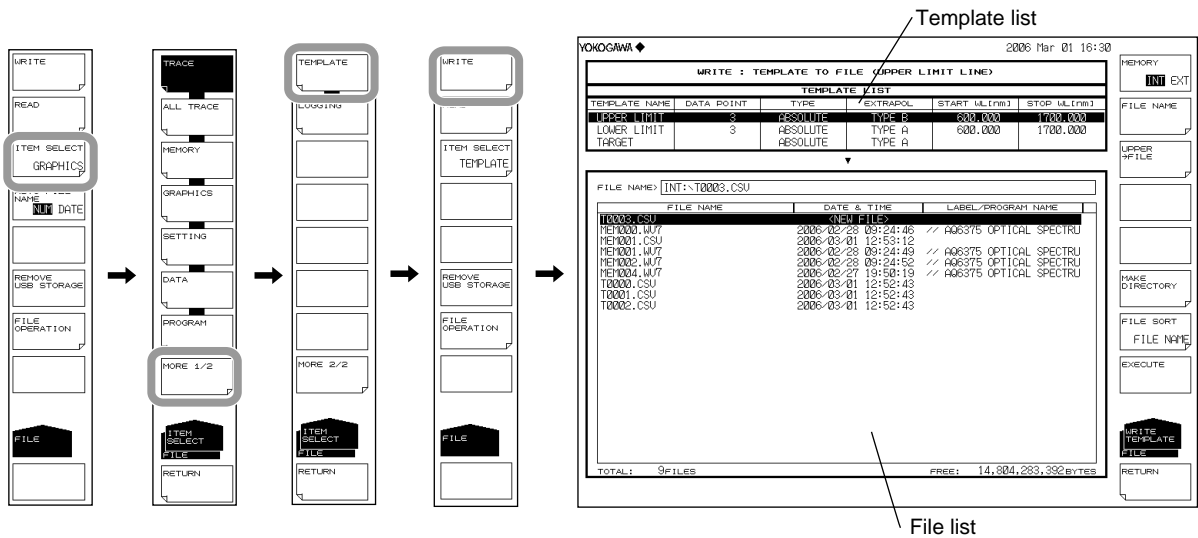

Selecting the Save Destination and Data Format

5. Press the **MEMORY** soft key and specify a save destination of INT (internal memory) or EXT (USB storage medium).



Selecting a Template to Save

6. Press the **@@@@->FILE** soft key (where @@@@ is UPPER, LOWER, or TARGET). The template selection screen appears.
7. Press the soft key corresponding to the template to be saved.

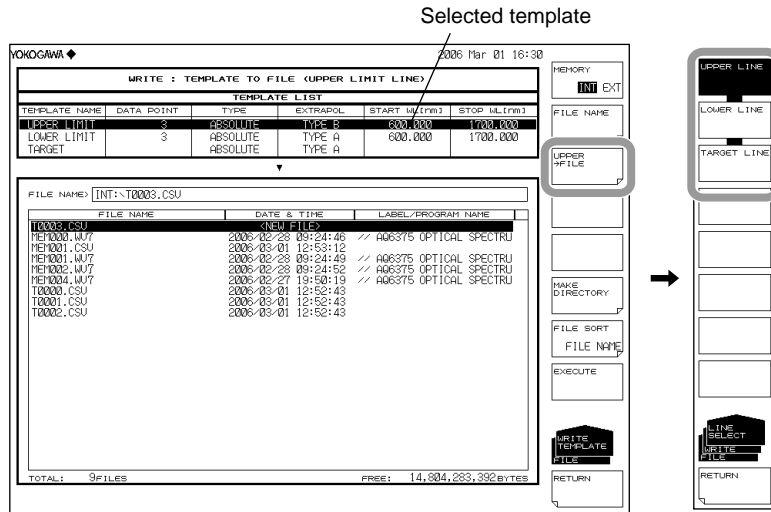

Entering the Name of the File to Be Saved

If a file name is not entered, it is automatically assigned in the form TXXXX.CSV (where XXXX is a serial number or saved date and time).

For the auto file name, see section 7.3.

For creating a directory and sorting the file list, see the page 7-9.

8. Press the **CURSOR** soft key, then set the cursor selection to DOWN (on the file list side). An underscore is displayed with the program number selected in step 7.
9. Using the **rotary knob** or **arrow keys**, move the cursor to the line in the file list displaying NEW FILE.
10. Press the **FILE NAME** soft key. The text entry window and corresponding soft key menu are displayed.
11. Follow the instructions in section 4.3 to enter a file name.
12. Press the **DONE** soft key. The file name is confirmed, and the screen returns to the previous stage.

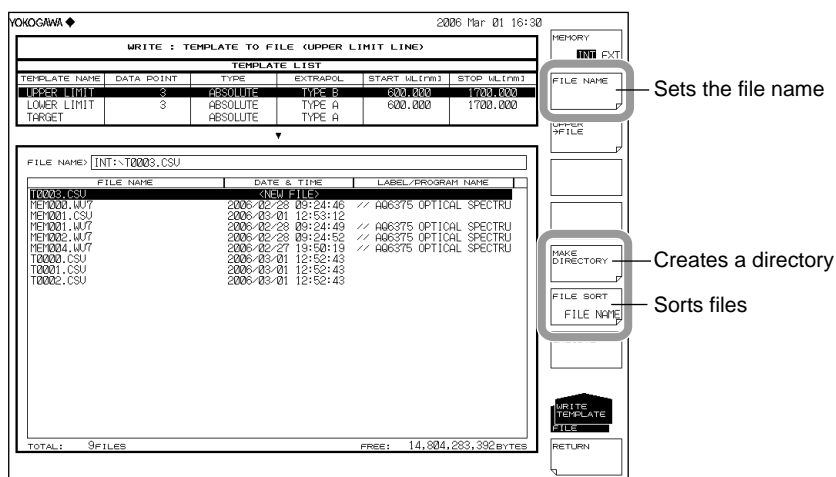

Executing the Save

13. To overwrite an existing file, move the cursor to the file name to be overwritten.
14. Press the **EXECUTE** soft key. The save executes.

When the **RETURN** soft key is pressed, the data is saved. The screen returns to the previous stage.

15. When overwriting during a save, a confirmation message appears. Press the **YES** soft key. To cancel the save press **NO** soft key.

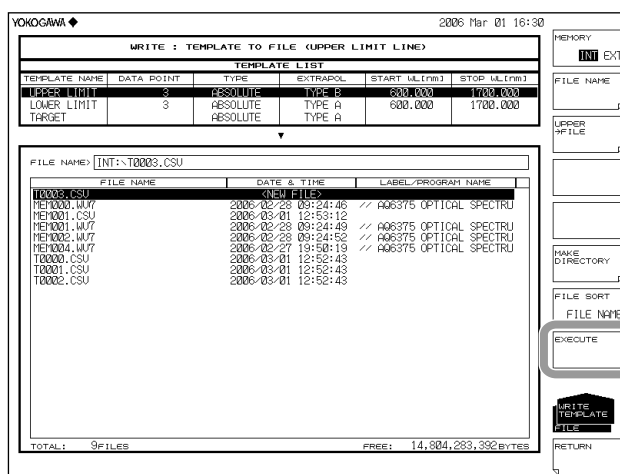

Loading a Template File

Setting the Type of the File to Be Loaded to TEMPLATE

1. Press **FILE**.
2. Press the **ITEM SELECT** soft key. The soft key menu switches.
3. Press the **TEMPLATE** soft key. **TEMPLATE** is selected, and the screen returns to the previous stage.
4. Press the **READ** soft key. The template list is displayed.

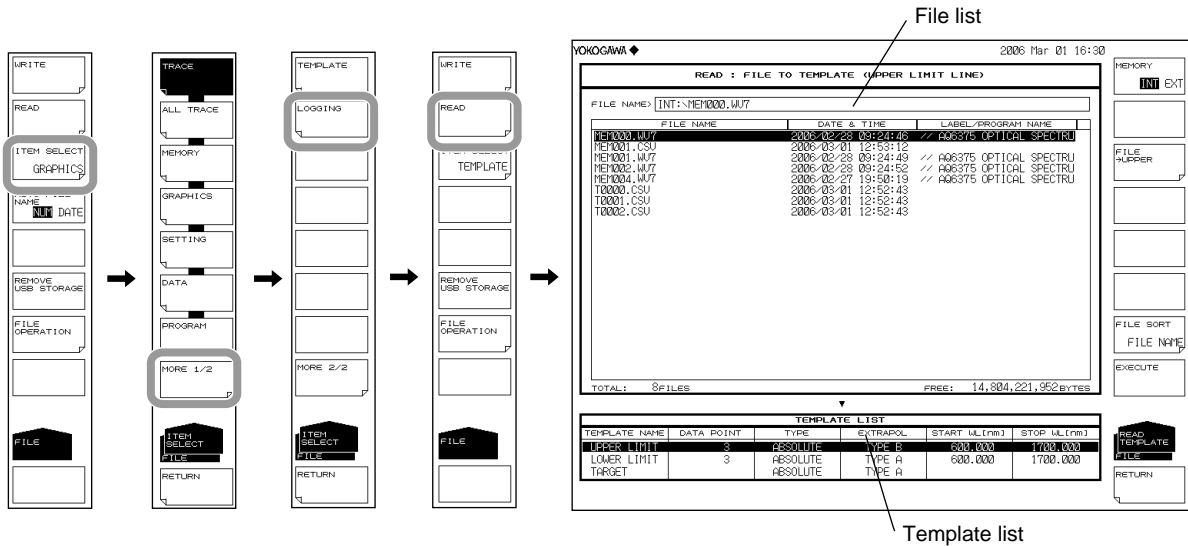

Selecting the File to Be Loaded

5. Press the **MEMORY** soft key and specify **INT** (internal memory) or **EXT** (USB storage medium). A file list of the selected medium is displayed.
6. Select a file to load from the file list using the **rotary knob** or the **arrow keys**. You can also press the **FILE SORT** soft key to sort the files. For more information, see page 7-9.

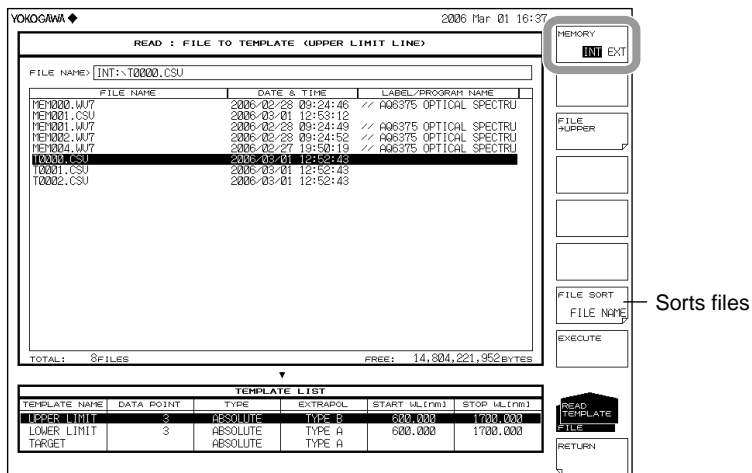

Selecting a Template

8. Press the **FILE->@@@** soft key (where @@@ is UPPER, LOWER, or TARGET). The template selection screen appears.
9. Press the soft key corresponding to the template to be loaded to.

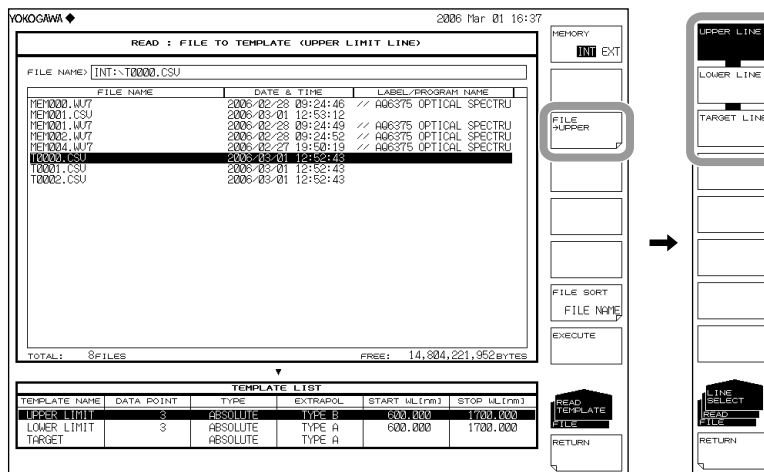

Executing the Load

10. Press the **EXECUTE** soft key. The file is loaded as the specified template.

When the **RETURN** soft key is pressed, the file is not loaded. The screen returns to the previous stage.

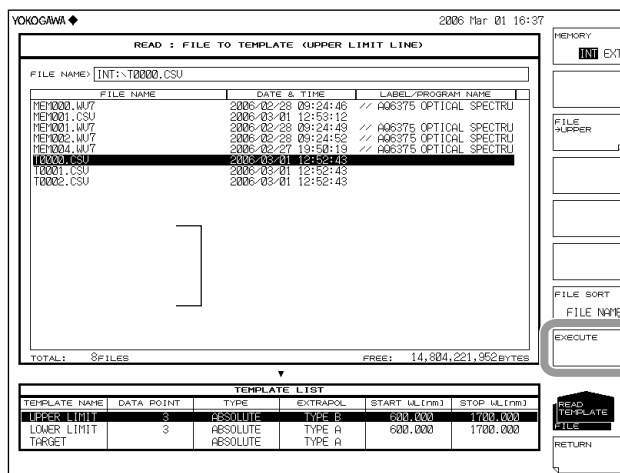

Explanation

Extension

The extension used when saving is .CSV.

File Name

You can have a file name automatically assigned, or specify an arbitrary name for the save. If you do not assign a file name, a file name is automatically assigned as follows.

For the auto file name, see section 7.3.

File name: TXXXX.PG7

XXXX is a serial number from 0000 to 9999 or saved date and time.

Note

Only use the characters allowed in file names by MS-DOS when changing a file name. The maximum file name length is 56 characters (including the extension).

The following characters can be used in file names.

!#\$%&'()-

0123456789@

ABCDEFGHIJKLMNPOQRSTUVWXYZ^

abcdefghijklmnopqrstuvwxyz`

File Size

The file size differs depending on the data.

Data Format

You can save the file in CSV format.

Data Format

AQ6375B	Header indicating the AQ6375B,
TEMPLATE,	Header indicating template data
TYPE,ABSOLUTE	Template type (ABSOLUTE or RELATIVE)
EXTRAPOL,A	Extrapolation type (A, B, or NONE)
1540.000,-20.00	Wavelength and level data
1550.000,-10.00	Data starting with the smallest wavelength
1560.000,-20.00	Sorts up to 50001 points of data

Template Types

The following types of templates are available for saving or loading.

UPPER:	UPPER LINE
LOWER:	LOWER LINE
TARGET:	TARGET LINE

7.10 Saving and Loading Logging Data

Procedure

You can save and load logging data and the corresponding trace waveforms.



CAUTION

Do not remove the USB storage medium or turn off the power when the USB storage media access indicator is blinking. Doing so may damage the USB storage medium or corrupt its data. Before you remove a USB storage medium, be sure to follow the procedure in section 7.1 to make the USB storage medium ready to be removed.

French



ATTENTION

Ne retirez pas le dispositif de stockage USB et ne coupez pas l'alimentation lorsque le voyant d'accès au dispositif de stockage USB clignote. Cela risquerait d'endommager le dispositif ou les données se trouvant sur ce dernier. De plus, toujours faire passer un support de stockage USB à l'état de retrait en toute sécurité (en suivant la procédure figurant à la section 7.1) avant de le retirer.

Setting the Type of File to Save to LOGGING

1. Press **FILE**.
2. Press the **ITEM SELECT** soft key. The soft key menu changes.
3. Press the **MORE 1/2** soft key.
4. Press the **LOGGING** soft key. LOGGING is selected, and the menu returns to the FILE level.
5. Press the **WRITE** soft key. A file list appears.

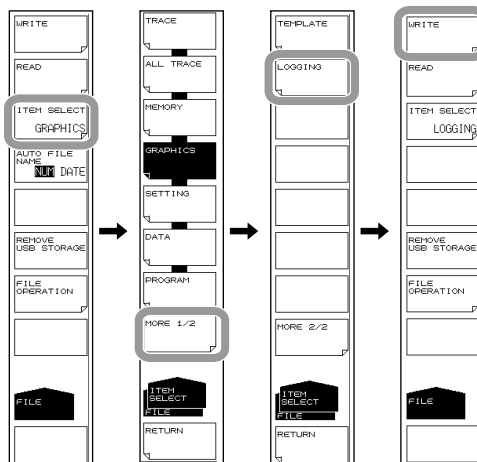

Selecting the Storage Medium

- Press the **MEMORY** soft key to select INT (internal memory) or EXT (USB storage media).

The file list of the selected medium appears.

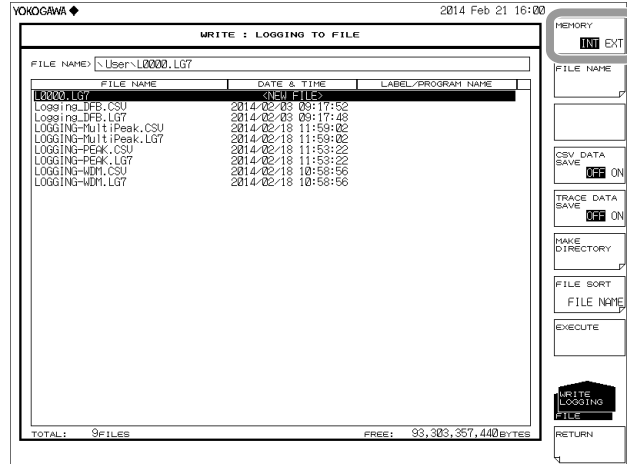

Entering the Name of a File to Save

If you do not specify a file name, the files will automatically be assigned the name LXXXX.LG7 (where XXXX is a serial number or saved date and time).

For instructions on how to create directories and sort the file list, see page 7-9.

For the auto file name, see section 7.3.

- Using the rotary knob or arrow keys, move the cursor to the line in the file list displaying NEW FILE.
- Press the **FILE NAME** soft key. The text entry window and corresponding soft key menu appear.
- Follow the instructions in section 3.3 to enter a file name.
- Press the **DONE** soft key. The file name is confirmed, and the screen returns to the previous level.

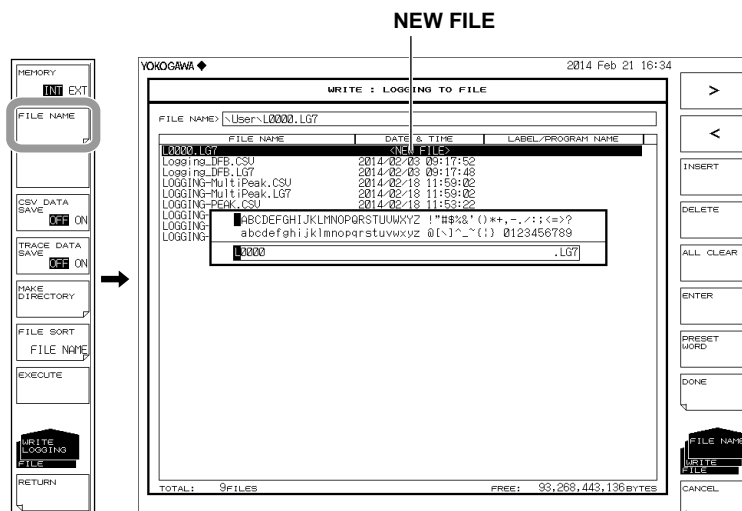

Configuring to Also Save Data in CSV Format When Logging Data Is Saved

11. Press the **CSV DATA SAVE ON/OFF** soft key to select ON (save) or OFF (not save).

Configuring to Also Save the Temporarily Saved Waveform Data When Logging Data Is Saved

12. Press the **TRACE DATA SAVE ON/OFF** soft key to select ON (save) or OFF (not save).

If you don't save the waveform data, it will be deleted when data logging is restarted.

Saving the File

13. To overwrite an existing file, move the cursor to the name of the file you want to overwrite.
14. Press the **EXECUTE** soft key. The file is saved.
If you press the RETURN soft key, the data will not be saved. The menu returns to the previous level.
15. When overwriting a file, a confirmation message appears. Press the **YES** soft key.
To cancel, press the **NO** soft key.

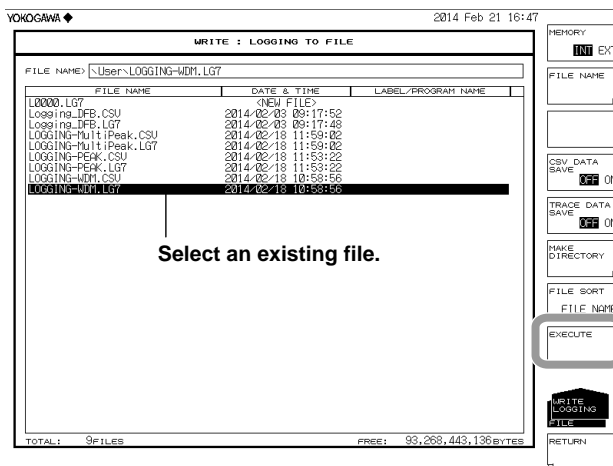

Loading Setting Data

Setting the Type of File to Load to LOGGING

1. Press **FILE**.
2. Press the **ITEM SELECT** soft key. The soft key menu changes.
3. Press the **MORE 1/2** soft key.
4. Press the **LOGGING** soft key. LOGGING is selected, and the menu returns to the previous level.
5. Press the **READ** soft key. A file list appears.

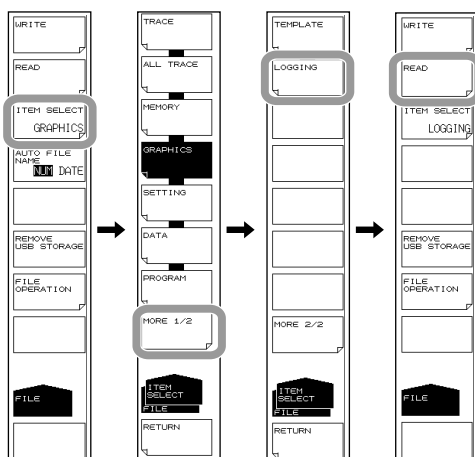

Selecting the File to Load

6. Press the **MEMORY** soft key to select INT (internal memory) or EXT (USB storage media).

The file list of the selected medium appears.

7. Using the rotary knob or arrow keys, select the file you want to load from the file list.

You can sort the files by pressing the **FILE SORT** soft key. For the operating procedure, see page 7-9.

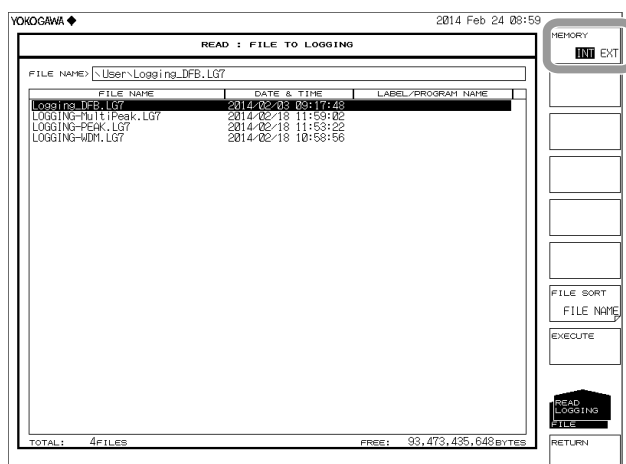

Loading the File

8. Press the **EXECUTE** soft key. The file is loaded.

If you press the **RETURN** soft key, the file will not be loaded. The menu returns to the previous level.

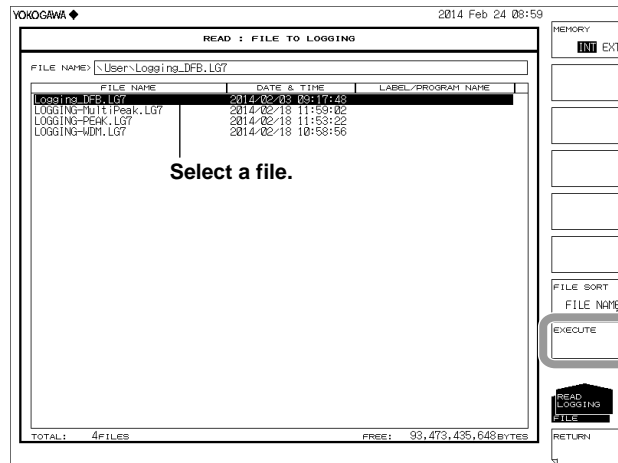

Description

You can save logging data to the internal memory or USB storage media and also load logging data saved previously.

Extension

The file name extensions of logging data are shown below.

LG7 (binary format): .LG7

CSV (ASCII format): .CSV

Logging data saved to CSV format cannot be loaded into the AQ6375B.

If waveform data is also saved (TRACE LOGGING is set to ON), waveform data will be included in the LG9 file, and thus the file size will be large.

File Name

You can save files by assigning their names automatically or with specific names.

If you do not specify a file name, the following file name will be assigned automatically.

For the auto file name, see section 7.3.

File name: LXXXX.LG7 (or .CSV)

XXXX is a serial number from 0000 to 9999 or saved date and time.

Note

For file names, use characters that are allowed by MS-DOS.

The maximum number of characters that you can use for file names is 56 (including the extension).

The characters that you can use are shown below.

!#\$%&'()-

0123456789@

ABCDEFGHIJKLMNOPQRSTUVWXYZ^

abcdefghijklmnopqrstuvwxyz}_

7.10 Saving and Loading Logging Data

Sorting Files

You can sort the file list in descending order by file name, file type, date, or label.

File Size

The file size varies depending on the data that you are saving.

Check that there is sufficient free space at the storage destination before saving the data. The approximate file size when waveform data is saved along with logging data is shown below.

$$\text{File size} = (\text{number of waveform samples}) \times (\text{logging measurement count}) \times 4 (\text{bytes}) + \text{logging data (approx. 100 MB max.)}$$

CSV Data Format

CSV data is saved in the following format.

Header

75 LOG1		File header
// AQ6375B OPTICAL SPECTRUM ANALYZER //		Label (57 characters)
S/N	*****	Instrument number
Software Version	Rxx.xx	Firmware version

Waveform Condition Parameters

The waveform condition format is the same as that of the waveform file.

See section 7.3, "Saving and Loading Waveform Data."

Logging Condition Parameters

INTERVAL	1	Measurement interval
DURATION	00.01.59.59	Measurement duration
COUNT	1	Measurement count
START TIME	2014 Apr 1 10:30:15	Measurement start time
END TIME	2014 Apr 2 10:30:15	Measurement end time
REF NUM	1	Reference data position for relative value display

Measured Data

- WDM analysis

NUM	Time(sec)	CH	WL[nm]	POWER[dBm]	SNR[dB]
1	0.0	1	548.065	-20.071	42.131

- MULTI-PEAK analysis

NUM	Time(sec)	CH	WL[nm]	POWER[dBm]
1	0.0	1	306.822	-27.715

- PEAK analysis

NUM	Time(sec)	WL[nm]	POWER[dBm]
1	0.0	577.848	-56.466

- DFB-LD analysis

NUM	Time(sec)	PEAK WL [nm]	PEAK LEVEL [dBm]	SMSR [dB]	OSNR [dB]	CENTER WL [dB]	SPEC WD [nm]	POWER [dBm]	OFFSET [nm]	SIGMA [nm]	K SIGMA [nm]
1	0.0	530.332	9.888	59.637	63.203	530.3322	0.0968	10.013	-0.99	0.0139	0.0278

7.11 Creating Files

Procedure

You can change file names, copy files, and perform other file manipulations.



CAUTION

Do not remove the USB storage medium or turn the power OFF while the USB storage medium access indicator is blinking. This can damage the data on the medium or the device itself. Also, always place a USB storage medium in the removable state (following the procedure in section 7.1) before removing it.

French



ATTENTION

Ne retirez pas le dispositif de stockage USB et ne coupez pas l'alimentation lorsque le voyant d'accès au dispositif de stockage USB clignote. Cela risquerait d'endommager le dispositif ou les données se trouvant sur ce dernier. De plus, toujours faire passer un support de stockage USB à l'état de retrait en toute sécurité (en suivant la procédure figurant à la section 7.1) avant de le retirer.

Selecting Medium of the File

1. Press **FILE**.
2. Press the **FILE OPERATION** soft key. The file operation menu is displayed.
3. Press the **MEMORY** soft key and specify INT (internal memory) or EXT (USB storage medium). A file list of the selected medium is displayed.

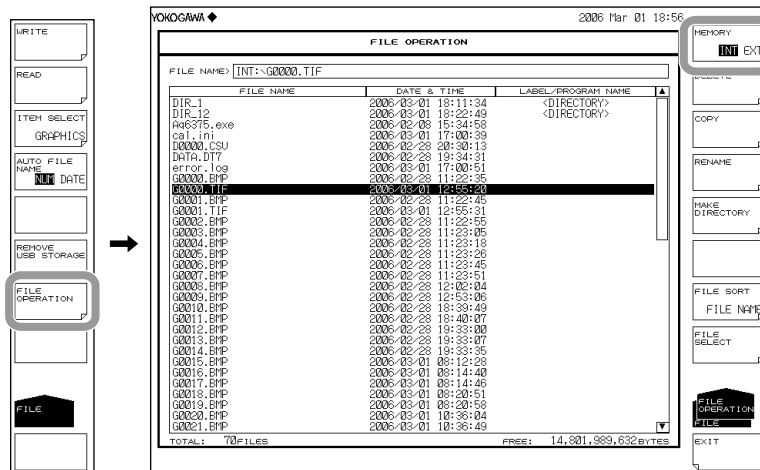

Selecting the File/Directory

4. Select a file or directory using the **rotary knob** or the **arrow keys**. To move to a directory, select the directory and press **ENTER**. The instrument moves to the selected directory.

Select **..** and press **ENTER** to move up one directory.

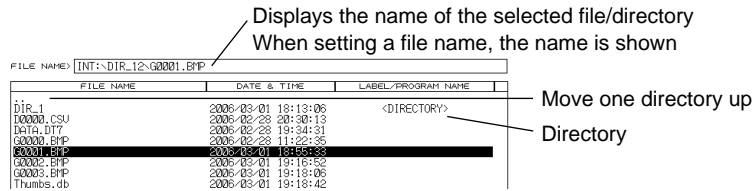

Selecting All Files

5. Press the **FILE SELECT** soft key. The file selection menu is displayed.
 6. Press the **ALL SELECT** soft key. All files are selected.
- Press the **ALL CLEAR** soft key to clear the file selection.

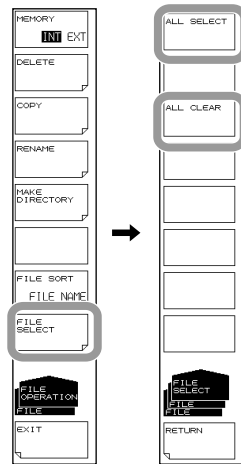

Deleting a File/Directory

5. Select a file or directory to delete using the procedure in step 4.
6. Press the **DELETE** soft key. A deletion confirmation message appears.
7. Press the **YES** soft key. The selected file or directory is deleted. Press the **NO** soft key to cancel deletion of the file or directory. The screen returns to the previous state.

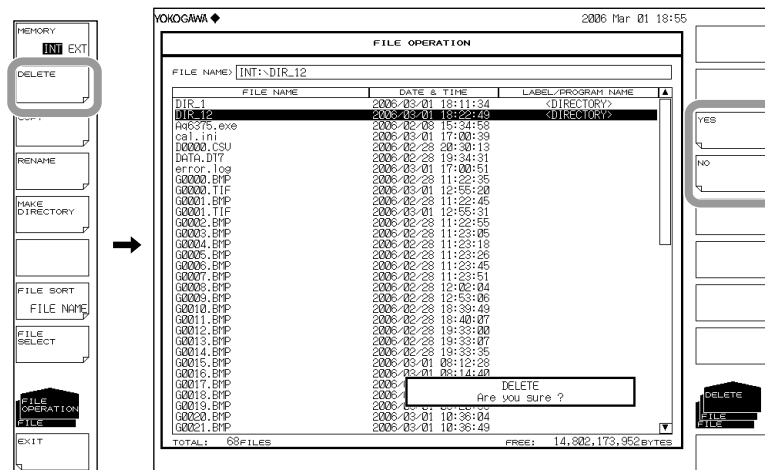

Copying a File/Directory

5. Select a file or directory to copy using the procedure in step 4.
6. Press the **COPY** soft key.
7. Display the copy destination file list using steps 3 and 4. If the copy source and copy destination media are not the same, press the **MEMORY** soft key to select the copy destination medium.
8. When pasting to the same name, press the **EXECUTE** soft key. The selected file or directory is pasted.

When pasting under a different name from the copy source, press the **FILE NAME** soft key. The text entry window and corresponding soft key menu are displayed.

9. Follow the instructions in section 3.3 to enter a file name.
10. Press the **DONE** soft key. The file name is confirmed, and the screen returns to the previous stage.
11. Press the **EXECUTE** soft key. The data is pasted under the specified file or directory name. Press the **CANCEL** soft key to cancel changing of the file or directory name.

Note

When pasting in the same directory as the copy source, change the name before pasting.

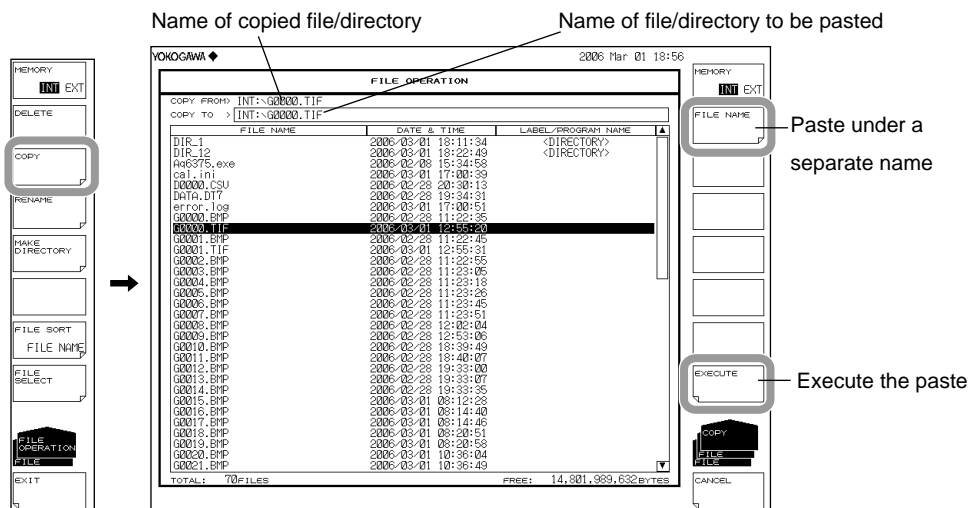

Changing a File/Directory Name

5. Select a file or directory name to change using the procedure in step 4.
6. Press the **RENAME** soft key. The menu for setting names appears.
7. Press the **FILE NAME** soft key. The text entry window and corresponding soft key menu are displayed.
8. Follow the instructions in section 3.3 to enter a file name.
9. Press the **DONE** soft key. The file or directory name is confirmed, and the screen returns to the previous stage.
10. Press the **EXECUTE** soft key. The data is changed to the specified file or directory name. **Press the CANCEL** soft key to cancel changing of the file or directory name.

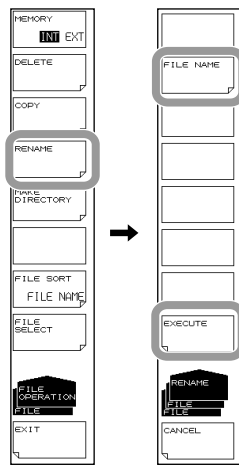

Creating a Directory

5. Display the directory file list for creating directories using the procedure in step 4.
6. Press the **MAKE DIRECTORY** soft key. The menu for setting names appears.
7. Press the **DIRECTORY NAME** soft key. The text entry window and corresponding soft key menu are displayed.
8. Follow the instructions in section 3.3 to enter a directory name.
9. Press the **DONE** soft key. The directory name is confirmed, and the screen returns to the previous stage.
10. Press the **EXECUTE** soft key. A new directory is created. **Press the CANCEL** soft key to cancel creation of the directory.

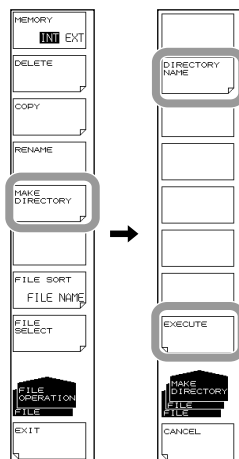

Sorting Files

5. Press the **FILE SORT** soft key. The file sort menu is displayed.
6. Press the soft key corresponding to the item by which to sort. The files are sorted in ascending order by the selected item.

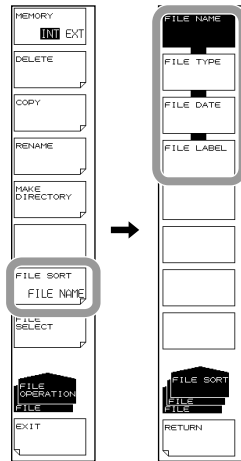

Explanation

File/Directory Name

When changing file/directory names, only use the characters allowed by MS-DOS for file and directory names. The maximum file name length is 56 characters (including the extension).

The following characters can be used in file names.

!#\$%&'()-

0123456789@

ABCDEFGHIJKLMNOPQRSTUVWXYZ^

abcdefghijklmnopqrstuvwxyz}_

File Sort

You can sort the file list in ascending order by file name, file type, file date, or label.

8.1 Registering Soft keys

Procedure

1. Press **SYSTEM**. The soft key menu regarding the system appears.
2. Press the **USER KEY DEFINE** soft key. A registration screen (USER KEY DEFINE MODE) key is displayed.
To exit the soft key registration mode, press UNDO/LOCAL.
3. Press the panel key corresponding to the soft key to register.
4. Press the soft key to register. The name of the soft key you pressed is displayed in the registered key display area of the registration screen.
5. Press **USER**. The soft key menu switches to the USER menu.
6. Press soft key into which you wish to register the soft key selected in step 4. It switches to the name of the soft key to register. At the same time, the registration key display area goes blank again. If a soft key has already been registered, it is overwritten.
7. To clear a registered soft key, register a blank soft key using the same procedure.

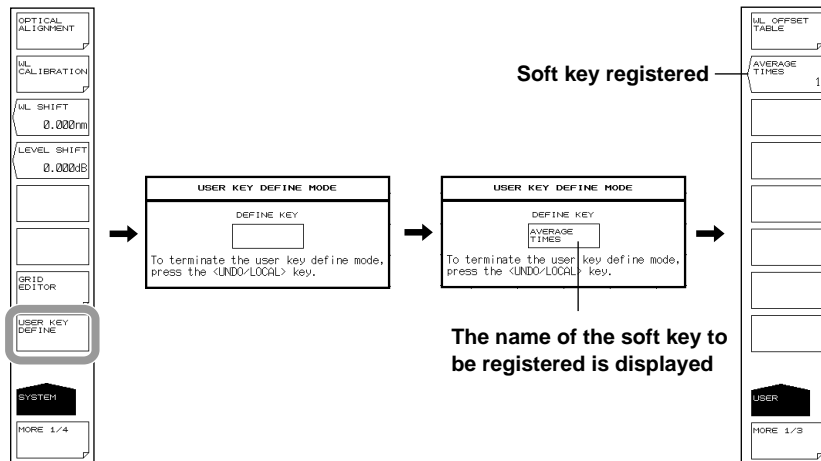

Note

- In principle, only soft keys that are displayed after pressing a function key can be registered. Subsequent soft keys cannot be registered. Soft keys that cannot be registered are not displayed in the registered key display area.
- Like the soft keys of other function keys, registered soft keys execute actions based on the registered contents.

Explanation

Any soft key can be registered as one of up to 24 user keys. Frequently used functions can be registered to a user soft key for easy access in the USER menu.

8.2 Data Initialization

Procedure

1. Press **SYSTEM**. The soft key menu regarding the system appears.
2. Press the **MORE 1/4** soft key to display 4/4.
3. Press the **PARAMETER INITIALIZE** soft key. The initialization item setting menu is displayed.
4. Set the initialization type according to the items to be initialized.
5. Press the **EXECUTE** soft key. The initialization executes.
To cancel, press the **CANCEL** soft key.

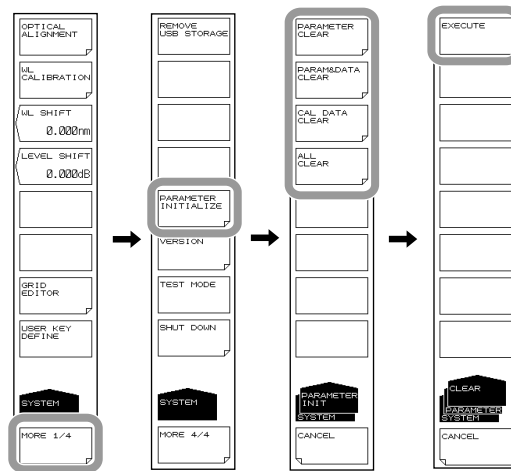

Explanation

You can restore all settings to their factory defaults.

The following four types of initialization are available depending on the items to be initialized.

- **PARAMETER CLEAR**
The parameter setting value of each function is initialized.
Waveform data of TRACE A - G is also initialized.
Use this to return the settings of the instrument to the already-known states.
- **PARAM&DATA CLEAR**
Parameter setting values as well as data including MEMORY and PROGRAM are initialized.
- **CAL DATA CLEAR**
Alignment adjustment values and wavelength calibration values are initialized.
- **ALL CLEAR**
Current parameter setting values and data as well as alignment adjustment values and wavelength calibration values are initialized.

The initial values for each setting are shown below.

SWEEP

Function	Initial Value	Maximum Value	Minimum Value
SEGMENT POINT****	1	50001	1
SWEEP MKR L1-L2 OFF/ON	OFF	-	-
SWEEP INTERVAL ****s	MINIMUM=0	99999	MINIMUM=0

CENTER

Function	Initial Value	Maximum Value	Minimum Value
CENTER WL ****.***nm	1800.000	2400.000	1200.000
CENTER FREQ ***.****THz	187.3703	250.0000	125.0000
CENTER WNUM ****.***cm ⁻¹	6250.000	8333.000	4167.000
START WL ****.***nm	1200.000	2400.000	600.000
START FREQ ***.****THz	124.9135	250.0000	60.0000
START WNUM ****.***cm ⁻¹	4166.667	8333.000	2067.000
STOP WL ****.***nm	2400.000	3000.000	1200.000
STOP FREQ ***.****THz	249.8270	315.0000	125.0000
STOP WNUM ****.***cm ⁻¹	8333.333	10433.000	4167.000
AUTO CENTER OFF/ON	OFF	-	-

SPAN

Function	Initial Value	Maximum Value	Minimum Value
SPAN****.***nm	1200.0	1200.0	0 / 0.5
SPAN FREQ***.***THz	124.91	130.00	0 / 0.01
SPAN WNUM ****.***cm ⁻¹	4167.7	4200.0	0 / 0.5
START WL ****.***nm	1200.000	2400.000	600.000
START FREQ***.****THz	124.9135	250.0000	60.0000
START WNUM ****.***cm ⁻¹	4166.667	8333.000	2067.000
STOP WL ****.***nm	2400.000	3000.000	1200.000
STOP FREQ***.****THz	249.8270	315.0000	125.0000
STOP WNUM ****.***cm ⁻¹	8333.333	10433.000	4167.000
0nm SWEEP TIME**s	MINIMUM	60	MINIMUM

8.2 Data Initialization

LEVEL

Function		Initial Value	Maximum Value	Minimum Value
REF LEVEL	LOG	-10.0dBm	30.0dBm	-90.0dBm
	LINEAR	100μW	1000mW	1.00pW
LOG SCALE**.*dB/D		10.0 , ON	10.0	0.1
LIN SCALE		OFF	-	-
LIN BASE LEVEL**.*mW		0	REF×0.9	0
AUTO REF LEVEL OFF/ON		OFF	-	-
LEVEL UNIT dBm / dBm/nm / dBm/THz		dBm	-	-
Y SCALE SETTING	Y SCALE DIVISION 8/10/12	10	12	8
	REF LEVEL POSITION **DIV	8	12	0
SUB LOG**.*dB/D		5.0 , ON	10	0.1
SUB LIN*.**/D		0.125 , OFF	1.250	0.005
SUB SCALE**.*dB/km		5.0 , OFF	10.0	0.1
SUB SCALE**.*%/D		10.0 , OFF	125.0	0.5
OFFSET LEVEL**.*dB		0.0	99.9	-99.9
SCALE MIN *.*		0.00	1.25	0.00
OFFSET LEVEL**.*dB/km		0.0	99.9	-99.9
SCALE MIN **.*%		0.0	100.0	0.0
LENGTH**.*km		1.000	99.999	0.001
AUTO SUB SCALE OFF/ON		OFF	-	-
SUB REF LVL POSITION **DIV		5	10	0

SETUP

Function		Initial Value	Maximum Value	Minimum Value
RESOLUTION @@@@nm		1	2	0.05
SENS/MODE	NORM/HOLD	OFF	-	-
	NORM/AUTO	ON	-	-
	NORMAL	OFF	-	-
	MID	OFF	-	-
	HIGH1/CHOP	OFF	-	-
	HIGH2/CHOP	OFF	-	-
	HIGH3/CHOP	OFF	-	-
AVG TIMES ***		1	999	1
SAMPLING POINT AUTO		ON	-	-
SAMPLING POINT *****		<SAMPLING POINT AUTO> calculated value, OFF	50001	101
SAMPLING INTERVAL *.*nm		<SAMPLING POINT AUTO> calculated value, OFF	SPAN/100	0.001
MEAS WL AIR/VACUUM		VAC	-	-
SWEEP SPEED 1x/2x		1x	-	-
PLS LIGHT MEASURE		OFF	-	-
TRIGGER SETTING	EDGE RISE/FALL	RISE	-	-
	DELAY ***** μs	0.0	1000.0	0.0
	TRIG INPUT MODE*****	SMPL TRG		
	TRIG OUTPUT MODE*****	OFF		
HORZN SCALE nm/THz		nm	-	-
SMOOTHING OFF/ON		OFF	-	-

ZOOM

Function	Initial Value	Maximum Value	Minimum Value
ZOOM CENTER WL ****.***nm	Center wavelength during measurement of the trace that was measured or read last	2400.000	1200.000
ZOOM CENTER FREQ ***.****THz	Center frequency during measurement of the trace that was measured or read last	250.0000	125.0000
ZOOM CENTER WNUM ****.***cm ⁻¹	Center wavenumber during measurement of the trace that was measured or read last	8333.000	4167.000
ZOOM SPAN WL ****.nm	Measurement span of the trace that was measured or read last	1200.0	0.1
ZOOM SPAN FREQ***.****THz	Measurement span of the trace that was measured or read last	130.0000	0.0100
ZOOM SPAN WNUM ****.*cm ⁻¹	Measurement span of the trace that was measured or read last	4200.0	0.5
ZOOM START WL ****.***nm	Measurement start wavelength of the trace that was measured or read last	2400.000	600.000
ZOOM START FREQ ***.****THz	Measurement start frequency of the trace that was measured or read last	250.0000	60.0000
ZOOM START WNUM ****.***cm ⁻¹	Measurement start wavenumber of the trace that was measured or read last	8333.000	2067.000
ZOOM STOP WL ****.***nm	Measurement stop wavelength of the trace that was measured or read last	3000.000	1200.000
ZOOM STOP FREQ ***.****THz	Measurement stop frequency of the trace that was measured or read last	315.0000	125.0000
ZOOM STOP WNUM ****.***cm ⁻¹	Measurement stop wavenumber of the trace that was measured or read last	10433.000	4167.000
OVERVIEW DISPLAY OFF/L/R	R	-	-
OVERVIEW SIZE LARGE/SMALL	LARGE	-	-

8.2 Data Initialization

DISPLAY

Function		Initial Value	Maximum Value	Minimum Value
NORMAL DISPLAY		ON	-	-
SPLIT DISPLAY		OFF	-	-
SPLIT DISPLAY	TRACE A UP/LOW	UP	-	-
	TRACE B UP/LOW	UP	-	-
	TRACE C UP/LOW	LOW	-	-
	TRACE D UP/LOW	UP	-	-
	TRACE E UP/LOW	UP	-	-
	TRACE F UP/LOW	LOW	-	-
	TRACE G UP/LOW	LOW	-	-
HOLD	UPPER HOLD OFF/ON	OFF	-	-
	LOWER HOLD OFF/ON	OFF	-	-
LABEL		// AQ6375B OPTICAL SPECTRUM ANALYZER //	-	-
NOISE MASK ***dB		OFF	0	OFF(-999)
MASK LINE VERT / HRZN		HRZN	-	-

TRACE

Function		Initial Value	Maximum Value	Minimum Value	
ACTIVE TRACE A/B/C/D/E/F/G		TRACE A	-	-	
VIEW @ DISP/BLANK		TRACE A=DISP, TRACE B/C/D/E/F/G =BLANK	-	-	
FIX @		TRACE B/C/D/E/F/G	-	-	
HOLD @	MAX HOLD	No TRACE , TRACE A,C,E,G	-	-	
	MIN HOLD	No TRACE , TRACE B,D,F	-	-	
ROLL AVG *		No TRACE , 2	100	2	
CALCULATE C @@@@	LOG MATH @@@@	C=A-B(LOG) , ON	-	-	
	LIN MATH @@@@	C=A+B(LIN) , OFF	-	-	
CALCULATE F	LOG MATH @@@@	F=C-D(LOG) , ON	-	-	
	LIN MATH @@@@	F=C+D(LIN) , OFF	-	-	
CALCULATE G	LOG MATH @@@@	G=C-F(LOG) , ON	-	-	
	LIN MATH @@@@	G=C+F(LIN) , OFF	-	-	
	NORMALIZE @@@@	G=NORM A , OFF	-	-	
	CURVE FIT @@@@		G=CRVFIT A , OFF	-	-
		THRESH **dB	20	99	0
		OPERATION AREA ALL / INSIDE L1-L2 / OUTSIDE L1-L2	ALL	-	-
	FITTING ALGO		GAUSS	-	-
			G=PKCVFIT A , OFF	-	-
		THRESH **dB	20	99	0
	PEAK CURVE FIT @@@@		ALL	-	-
OPERATION AREA ALL / INSIDE L1-L2 / OUTSIDE L1-L2		ALL	-	-	
FITTING ALGO		GAUSS	-	-	
TRACE COPY	SOURCE TRACE @	A	-	-	
	DESTINATION TRACE @	B	-	-	

MARKER

Function		Initial Value	Maximum Value	Minimum Value
MARKER ACTIVE OFF/ON		OFF	-	-
SET MARKER	SET	1	1024	1
LINE MARKER 1 OFF/ON		OFF	WL=1200.000 FREQ=856.5000	WL=350.000 FREQ=250.0000
LINE MARKER 2 OFF/ON		OFF	WL=1200.000 FREQ=856.5000	WL=350.000 FREQ=250.0000
LINE MARKER 3 OFF/ON		OFF	LOG=30.0 LINEAR=1000mW	LOG=-90.0 LINEAR=1.00pW
LINE MARKER 4 OFF/ON		OFF	LOG=30.0 LINEAR=1000mW	LOG=-90.0 LINEAR=1.00pW
MAKER DISPLAY OFFSET/SPACING		OFFSET	-	-
MARKER AUTO UPDATE OFF/ON		OFF	-	-
MARKER UNIT nm/THz		nm	-	-
SEARCH/ANA L1-L2 OFF/ON		OFF	-	-
SEARCH/ANA ZOOM AREA OFF/ON		ON	-	-
ADVANCED MARKER	ADV MARKER ACTIVEON/OFF	OFF		
	MARKER1 SELECT	OFF		
	MARKER2 SELECT	OFF		
	MARKER3 SELECT	OFF		
	MARKER4 SELECT	OFF		
	BAND WIDTH	0.1 nm		

PEAK SEARCH

Function		Initial Value	Maximum Value	Minimum Value
PEAK SEARCH		ON	-	-
BOTTOM SEARCH		OFF	-	-
SET MARKER		1	1024	1
AUTO SEARCH OFF/ON		OFF	-	-
MODE DIFF **.**dB		3.00	50.00	0.01
SEARCH/ANA L1-L2 OFF/ON		OFF	-	-
SEARCH/ANA ZOOM AREA OFF/ON		ON	-	-
SEARCH MODE SINGL/MULTI		SINGL	-	-
MULTI SRCH SETTING	THRESH **.**dB	50.00	99.99	0.01
	SORT BY WL/LVL	WL	-	-

ANALYSIS

Function		Initial Value	Maximum Value	Minimum Value	
SPEC WIDTH @@@@	THRESH	THRESH LEVEL **.**dB	3.00	50.00	0.01
		K	1.00	10.00	1.00
		MODE FIT OFF/ON	OFF	-	-
	ENVELOPE	THRESH LEVEL1 **.**dB	3.00	50.00	0.01
		THRESH LEVEL2 **.**dB	13.00	50.00	0.01
		K	1.00	10.00	1.00
	RMS	THRESH LEVEL **.**dB	20.00	50.00	0.01
		K	2.00	10.00	1.00
	PEAK RMS	THRESH LEVEL **.**dB	20.00	50.00	0.01
		K	2.00	10.00	1.00
	NOTCH	THRESH LEVEL **.**dB	3.00	50.00	0.01
		K	1.00	10.00	1.00
		TYPE PAEK/BOTTOM	BOTTOM	-	-

8.2 Data Initialization

		Function	Initial Value	Maximum Value	Minimum Value		
ANALYSIS1 @@@@	DFB-LD	-XdB WIDTH	ALGO ENVELOPE/THRESH/RMS/PK-RMS	THRESH	-	-	
			THRESH **. **dB	20.00	50.00	0.01	
			THRESH2 **. **dB	20.00	50.00	0.01	
			K	1.00	10.00	1.00	
			MODE FIT OFF/ON	OFF	-	-	
			MODE DIFF *. **dB	3.00	50.00	0.01	
		SMSR	SMSR MODE SMSR1/SMSR2/SMSR3/SMSR4	SMSR1	-	-	
			SMSR MASK **. **nm	0.00	99.99	0.00	
			MODE DIFF **. **dB	3.00	50.00	0.01	
		RMS	ALGO RMS/PK-RMS	RMS	-	-	
			THRESH	20.00	50.00	0.01	
			K	2.00	10.00	0.01	
			MODE DIFF	3.00	50.00	0.01	
		POWER	SPAN	0.40	10.00	0.01	
		OSNR	MODE DIFF	3.0	50.00	0.01	
			NOISE ALGO	PIT	-	-	
			NOISE AREA	AUTO	10.00	0.01	
			MASK AREA	-	10.00	0.01	
			FITTING ALGO	LINEAR	-	-	
			NOISE BW	0.10	1.00	0.01	
			SIGNAL POWER	PEAK	-	-	
			INTEGRAL RANGE	10	999	10	
		FP-LD	SPECTRUM WIDTH	ALGO ENVELOPE/THRESH/RMS/PK-RMS	PK-RMS	-	-
				THRESH **. **dB	20.00	50.00	0.01
				THRESH2 **. **dB	20.00	50.00	0.01
				K	2.00	10.00	1.00
				MODE FIT OFF/ON	OFF	-	-
				MODE DIFF *. **dB	3.00	50.00	0.01
	MEAN WAVELENGTH		ALGO ENVELOPE/THRESH/RMS/PK-RMS	PK-RMS	-	-	
			THRESH **. **dB	20.00	50.00	0.01	
			THRESH2 **. **dB	20.00	50.00	0.01	
			K	2.00	10.00	1.00	
			MODE FIT OFF/ON	OFF	-	-	
			MODE DIFF *. **dB	3.00	50.00	0.01	
	TOTAL POWER		OFFSET LEVEL *. **dB	0.00	10.00	-10.00	
	MODE NO.		ALGO ENVELOPE/THRESH/RMS/PK-RMS	PK-RMS	-	-	
			THRESH **. **dB	20.00	50.00	0.01	
			THRESH2 **. **dB	20.00	50.00	0.01	
			K	2.00	10.00	1.00	
			MODE FIT OFF/ON	OFF	-	-	
			MODE DIFF *. **dB	3.00	50.00	0.01	

		Function	Initial Value	Maximum Value	Minimum Value	
ANALYSIS1 @@@@	LED	SPECTRUM WIDTH	ALGO ENVELOPE/THRESH/RMS/PK-RMS	THRESH	-	-
			THRESH **. **dB	3.00	50.00	0.01
			THRESH2 **. **dB	20.00	50.00	0.01
			K	1.00	10.00	1.00
			MODE FIT OFF/ON	OFF	-	-
			MODE DIFF *. **dB	3.00	50.00	0.01
	MEAN WAVELENGTH	ALGO ENVELOPE/THRESH/RMS/PK-RMS	RMS	-	-	
		THRESH **. **dB	20.00	50.00	0.01	
		THRESH2 **. **dB	20.00	50.00	0.01	
		K	2.00	10.00	1.00	
		MODE FIT OFF/ON	OFF	-	-	
		MODE DIFF *. **dB	3.00	50.00	0.01	
	TOTAL POWER	OFFSET LEVEL *. **dB	0.00	10.00	-10.00	
	SMSR	SMSR MODE SMSR1/SMSR2/SMSR3/SMSR4	SMSR1	-	-	
		SMSR MASK *. **nm	0.00	99.99	0.00	
	POWER	OFFSET LEVEL *. **dB	0.00	10.00	-10.00	
PMD	THRESH LEVEL *. **dB	3.00	50.00	0.01		
ANALYSIS2 @@@@	CHANNEL DETECTION SETTING	THRESH LEVEL *. **dB	3.00	50.00	0.01	
		MODE DIFF *. **dB	3.00	50.00	0.01	
		DISPLAY MASK OFF/*. **dB	OFF	0.00	-100.00	
	INTERPOLATION SETTING	NOISE ALGO AUTO-FIX/MANUAL-FIX/ AUTO-CTR/MANUAL-CTR	AUTO-FIX	-	-	
		NOISE AREA *. **nm	0.40	10.00	0.01	
		MASK AREA *. **nm	0.20	10.00	0.01	
		FITTING ALGO LINEAR/GAUSS/LORENZ/ 3RD POLY/4TH POLY/5TH POLY	LINEAR	-	-	
		NOISE BW *. **nm	0.10	1.00	0.01	
		DUAL TRACE OFF/ON	OFF	-	-	
	DISPLAY SETTING	DISPLAY TYPE ABSOLUTE/RELATIVE/ DRIFT(MEAS)/DRIFT(GRID)	ABSOLUTE	-	-	
		CH RELATION OFFSET/SPACING	OFFSET	-	-	
		REF CH HIGHEST/****CH	HIGHEST	1024	1	
		OUTPUT SLOPE OFF/ON	OFF	-	-	
		POINT DISPLAY OFF/ON	ON	-	-	

8.2 Data Initialization

		Function	Initial Value	Maximum Value	Minimum Value	
ANALYSIS2 @@@@	EDFA-NF	CHANNEL DETECTION SETTING	THRESH LEVEL *.*dB	3.00	50.00	0.01
		MODE DIFF *.*dB	3.00	50.00	0.01	
		INTERPOLATION SETTING	OFFSET(IN) *.*dB	0.00	99.99	-99.99
			OFFSET(OUT) *.*dB	0.00	99.99	-99.99
			ASE ALGO LINEAR/GAUSS/LORENZ/ 3RD POLY/4TH POLY/5TH POLY	LINEAR	-	-
			FITTING AREA *.*nm	0.40	10.00	0.01
			MASK AREA *.*nm	0.20	10.00	0.01
			FITTING ALGO LINEAR/GAUSS/LORENZ/ 3RD POLY/4TH POLY/5TH POLY	LINEAR	-	-
			POINT DISPLAY OFF/ON	ON	-	-
		NF CALCULATION SETTING	RES BW MEASURED/CAL DATA	CAL DATA	-	-
	SHOT NOISE OFF/ON		ON	-	-	
	FILTER-PK	PEAK LEVEL	SW OFF/ON	ON	-	-
		PEAK WAVELENGTH	SW OFF/ON	ON	-	-
			SW OFF/ON	ON	-	-
		CENTER WAVELENGTH	ALGO THRESH/RMS	THRESH	-	-
			THRESH LEVEL *.*dB	3.00	50.00	0.01
			K	1.00	10.00	1.00
			MODE FIT OFF/ON	OFF	-	-
			MODE DIFF *.*dB	3.00	50.00	0.01
		SPECTRUM WIDTH	SW OFF/ON	ON	-	-
ALGO THRESH/RMS			THRESH	-	-	
THRESH LEVEL *.*dB			3.00	50.00	0.01	
K			1.00	10.00	1.00	
MODE FIT OFF/ON			OFF	-	-	
RIPPLE WIDTH		SW OFF/ON	ON	-	-	
		THRESH LEVEL *.*dB	3.00	50.00	0.01	
		MODE DIFF *.*dB	0.500	50.000	0.001	
CROSS TALK		SW OFF/ON	ON	-	-	
		ALGO THRESH/PK LEVEL/GRID	THRESH	-	-	
	THRESH LEVEL *.*dB	3.00	50.00	0.01		
	K	1.00	10.00	1.00		
	MODE FIT OFF/ON	OFF	-	-		
	MODE DIFF *.*dB	3.00	50.00	0.01		
	CH SPACE ±.*nm	0.40	50.00	0.00		
SEARCH AREA ±.*nm	0.01	10.00	0.01			

		Function	Initial Value	Maximum Value	Minimum Value	
ANALYSIS2 @@@@	FILTER-BTM	BOTTOM LEVEL	SW OFF/ON	ON	-	-
		BOTTOM WAVE LENGTH	SW OFF/ON	ON	-	-
		CENTER WAVE LENGTH	SW OFF/ON	ON	-	-
			ALGO PEAK/BOTTOM	BOTTOM	-	-
			THRESH LEVEL *.*dB	3.00	50.00	0.01
			MODE DIFF *.*dB	3.00	50.00	0.01
		NOTCH WIDTH	SW OFF/ON	ON	-	-
			ALGO PEAK/BOTTOM	BOTTOM	-	-
			THRESH LEVEL *.*dB	3.00	50.00	0.01
			MODE DIFF *.*dB	3.00	50.00	0.01
		CROSS TALK	SW OFF/ON	ON	-	-
			ALGO PEAK/BOTTOM/BOTTOM LVL/GRID	BOTTOM	-	-
	THRESH LEVEL *.*dB		20.00	50.00	0.01	
	MODE DIFF *.*dB		3.00	50.00	0.01	
	CH SPACE ±*nm		0.40	50.00	0.00	
	SEARCH AREA ±*nm		0.01	10.00	0.01	
	WDM FIL-PK	CHANNEL DETECTION/ NOMINAL WAVELENGTH	ALGO PEAK/MEAN/GRID FIT/GRID	MEAN	-	-
			THRESH LEVEL *.*dB	3.0	50.0	0.1
			MODE DIFF *.*dB	3.0	50.0	0.1
			TEST BAND *.*nm	0.100	9.999	0.001
WDM FIL-PK	PEAK WAVELENGTH / LEVEL	SW OFF/ON	ON	-	-	
	XdB WIDTH/ CENTER WAVELENGTH	SW OFF/ON	ON	-	-	
	XdB STOP BAND	SW OFF/ON	ON	-	-	
		THRESH LEVEL *.*dB	-10.000	30.000	-90.000	
	XdB PASS BAND	SW OFF/ON	ON	-	-	
		THRESH LEVEL *.*dB	3.0	50.0	0.1	
		TEST BAND *.*nm	0.20	99.99	0.01	
	RIPPLE	SW OFF/ON	ON	-	-	
		TEST BAND *.*nm	0.20	99.99	0.01	
CROSS TALK	SW OFF/ON	ON	-	-		
	SPACING *.*nm	0.80	99.99	0.01		
	TEST BAND *.*nm	0.20	99.99	0.01		

8.2 Data Initialization

		Function	Initial Value	Maximum Value	Minimum Value		
ANALYSIS2 @@@@	WDM FIL-BTM	CHANNEL DETECTION / NOMINAL WAVELENGTH	ALGO BOTTOM/NOTCH(P)/NOTCH(B)/ GRID FIT/GRID	NOTCH(B)	-	-	
			THRESH LEVEL *.*dB	20.0	50.0	0.1	
			MODE DIFF *.*dB	20.0	50.0	0.1	
			TEST BAND *.*nm	0.100	9.999	0.001	
		BOTTOM WAVELENGTH/ LEVEL	SW OFF/ON	ON	-	-	
			XdB NOCH WIDTH / CENTER WAVELENGTH	SW OFF/ON	ON	-	-
		ALGORHYTHM NOTCH(P)/NOTCH(B)		NOTCH(B)	-	-	
		THRESH LEVEL *.*dB		3.0	50.0	0.1	
		XdB STOP BAND	SW OFF/ON	ON	-	-	
			THRESH LEVEL *.*dB	-10.000	30.000	-90.000	
		XdB ELIMINATION BAND	SW OFF/ON	ON	-	-	
			THRESH LEVEL *.*dB	3.0	50.0	0.1	
			TEST BAND *.*nm	0.20	99.99	0.01	
		RIPPLE	SW OFF/ON	ON	-	-	
			TEST BAND *.*nm	0.20	99.99	0.01	
		CROSS TALK	SW OFF/ON	ON	-	-	
			SPACING *.*nm	0.80	99.99	0.01	
			TEST BAND *.*nm	0.20	99.99	0.01	
		SPEC WIDTH THRESH *.*dB			3.00	50.00	0.01
		SWITCH DISPLAY	TRACE&TABLE/TABLE/TRACE/GRAPH&TABLE/GRAPH		TRACE&TABLE	-	-
			GRAPH&TABLE/ GRAPH	LINE MRKER Y1 OFF/ON	OFF	-	-
		LINE MRKER Y2 OFF/ON		OFF	-	-	
		AUTO ANALYSIS OFF/ON			OFF	-	-
		SEARCH/ANA L1-L2 OFF/ON			OFF	-	-
		SEARCH/ANA ZOOM AREA OFF/ON			ON	-	-

MEMORY

Function		Initial Value	Maximum Value	Minimum Value
SAVE	LIST PARAMETER LBL/ CONDTN	LBL	-	-
RECALL	LIST PARAMETER LBL/ CONDTN	LBL	-	-
CLEAR	LIST PARAMETER LBL/ CONDTN	LBL	-	-
MEMORY LIST	LIST PARAMETER LBL/ CONDTN	LBL	-	-

FILE

Function		Initial Value	Maximum Value	Minimum Value		
WRITE	DRIVE INT/EXT	INT	-	-		
	TRACE	TRACE@ → FILE	A	-	-	
		FILE TYPE BIN/CSV	BIN	-	-	
	MEMORY	CURSOR UP/DOWN	DOWN	-	-	
		FILE TYPE BIN/CSV	BIN	-	-	
		LIST PARAMETER LBL/CONDTN	LBL	-	-	
	GRAPHICS	MODE B&W/ COLOR/ PRESET COL	COLOR	-	-	
		FILE TYPE BMP/TIFF	BMP	-	-	
	DATA	OUTPUT ITEM SETTING	DATE&TIME OFF/ON	ON	-	-
			LABEL OFF/ON	ON	-	-
			DATA AREA OFF/ON	ON	-	-
			CONDITION OFF/ON	ON	-	-
			TRACE DATA OFF/ON	OFF	-	-
			OUTPUT DISPLAY OFF/ON	OFF	-	-
		FILE TYPE CSV/DT9	CSV	-	-	
		WRITE MODE OVER/ADD	OVER	-	-	
	PROGRAM	CURSOR UP/DOWN	DOWN	-	-	
	TEMPLATE	@@@@ → FILE	UPPER LINE	-	-	
	LOGGING	CSV DATA SAVE OFF/ON	OFF	-	-	
		TRACE DATA SAVE OFF/ON	OFF	-	-	
		FILE SORT @@@@	FILE NAME	-	-	
	READ	DRIVE INT/EXT	INT	-	-	
		TRACE	FILE → TRACE @	A	-	-
		MEMORY	CURSOR UP/DOWN	DOWN	-	-
			FILE SORT @@@@@@@@@@	FILE NAME	-	-
		ITEM SELECT @@@@	TRACE	-	-	
	FILE OPERATION	DRIVE INT/EXT	INT	-	-	
		COPY	DRIVE INT/EXT	INT	-	-
		FILE SORT @@@@@@@@@@	FILE NAME	-	-	

8.2 Data Initialization

PROGRAM

Function	Initial Value	Maximum Value	Minimum Value
EXECUTE1 **	01 (Program number)	-	-
EXECUTE2 **	02 (Program number)	-	-
EXECUTE3 **	03 (Program number)	-	-
EXECUTE4 **	04 (Program number)	-	-
EXECUTE5 **	05 (Program number)	-	-
EXECUTE6 **	06 (Program number)	-	-
EXECUTE7 **	07 (Program number)	-	-
EXECUTE8 **	08 (Program number)	-	-
EXECUTE9 **	09 (Program number)	-	-
EXECUTE10 **	10 (Program number)	-	-
EXECUTE11 **	11 (Program number)	-	-
EXECUTE12 **	12 (Program number)	-	-
EXECUTE13 **	13 (Program number)	-	-
EXECUTE14 **	14 (Program number)	-	-
EXECUTE15 **	15 (Program number)	-	-
EXECUTE16 **	16 (Program number)	-	-
EXECUTE17 **	17 (Program number)	-	-
EXECUTE18 **	18 (Program number)	-	-
EXECUTE19 **	19 (Program number)	-	-
EXECUTE20 **	20 (Program number)	-	-
EXECUTE21 **	21 (Program number)	-	-

ADAVANCE

Function		Initial Value	Maximum Value	Minimum Value	
TEMPLATE	GO/NO GO OFF/ON	OFF	-	-	
	TEMPLATE DISPLAY	UPPER LINE DISPLAY OFF/ON	OFF	-	-
		LOWER LINE DISPLAY OFF/ON	OFF	-	-
		TARGET LINE DISPLAY OFF/ON	OFF	-	-
	TEST TYPE @@@@	UPPER&LOWER	-	-	
	TEMPALTE EDIT	LINE SELECT @@@@	UPPER LINE	-	-
		MODE ABS/REL	ABS	-	-
		EXTRAPOL TYPE	TYPE A	-	-
	TEMPLATE SHIFT	WL SHIFT**.*nm	0	999.999	-999.999
		LEVEL SHIFT *.*dB	0	99.99	-99.99
DATA LOGGING	CURSOR/SCALE	CURSOR SELECT C1/C2/OFF	OFF	-	-
	LOGGING PARAMETER	LOGGING ITEM WDM/PEAK/MULTI-PEAK/DFB-LD	WDM		
		LOGGING MODE MODE1/MODE2	MODE2		
		MINIMUM INTERVAL SWEEP TIME/1sec/2sec/5sec/10sec/30sec/1min/2min/5min/10min	1sec		
		TEST DURATION **.*.***.***	00.00:00:10	*2	*1
		PEAK THRESH TYPE ABSOLUTE/RELATIVE	ABSOLUTE		
		THRESH(ABS) ***.***	-60.00	+20.00	-100.0
		THRESH(REL) **.*	20.00	99.99	0.01
		CH MATCHING λ THRESH \pm *.*	0.10		
		TRACE LOGGING OFF/ON	OFF		
	DESTINATION MEMORY INTERNAL/EXTERNAL	INTERNAL			
	SETUP	GRAPH CHANNEL SINGLE/ALL	SINGLE	-	-
		TABLE MODE CURR/SUMM	CURR	-	-

1 INTERVAL parameter value (the same as that for 1sec when SWEEP TIME is used)

2 99.23:59:59 (when the INTERVAL parameter is set to SWEEP TIME)

Maximum measurement count \times minimum interval (when the INTERVAL parameter is not set to SWEEP TIME)

8.2 Data Initialization

SYSTEM

Function		Initial Value	Maximum Value	Minimum Value	
WL CALIBRATION	BUILT-IN SOURCE	ON	-	-	
	EXTERNAL LASER ****.***nm	1523.488 , OFF	2400.000	1200.000	
	EXTERNAL GAS CELL ****.***nm	1530.372 , OFF	2400.000	1200.000	
WL SHIFT **.***nm		0.000	5.000	-5.000	
LEVEL SHIFT ***.***dB		0.000	60.000	-60.000	
GRID EDITOR	200GHz SPACING	ON	-	-	
	100GHz SPACING	OFF	-	-	
	50GHz SPACING	OFF	-	-	
	25GHz SPACING	OFF	-	-	
	12.5GHz SPACING	OFF	-	-	
	CUSTOM	START WL ****.***nm	1528.7700	2400.0000	1200.0000
		START WL ****.***THz	192.1000	250.0000	125.0000
		STOP WL ****.***nm	1560.6100	2400.0000	1200.0000
		STOP WL ****.***THz	196.1000	250.0000	125.0000
		SPACING ***.GHz	50.0	999.9	0.1
REFERENCE WAVELENGTH ****.***nm		1552.5243	2400.0000	1200.0000	
REFERENCE WAVELENGTH ****.***THz		192.1000	250.0000	125.0000	
REMOTE INTERFACE @@@@		GP-IB	-	-	
GP-IB SETTING	MY ADDRESS **	1	30	0	
	COMMAND FORMAT @@@@	AQ6375B	-	-	
RS-232C SETTING	BOUD RATE @@@@	9600BPS	115200BPS	1200BPS	
	PARITY @@@@	NONE	-	-	
	FLOW @@@@	NONE	-	-	
	COMMAND FORMAT @@@@	AQ6375B	-	-	
NETWORK SETTING	TCP/IP SETTING	AUTO(DHCP)	-	-	
	REMOTE PORT NO.	10001	65535	1024	
	COMMAND FORMAT @@@@	AQ6375B	-	-	
	REMOTE MONITOR	MONITOR PORT OFF/ON	ON		
		PORT NO.	20001 (FIX)		
FOLDER SHAREING DISABLE/READ ONLY		DISABLE	-	-	
HARD COPY DEVICE @@@@		INTERNAL FILE (NO PRINTER)	-	-	
TRIG INPUT MODE		SMPL TRIG	-	-	
TRIG OUTPUT MODE		OFF	-	-	
AUTO OFFSET SETTING	AUTO OFFSET OFF/ON	ON	-	-	
	INITERVAL *** min	10	999	10	
UNCAL WARNING DISPLAY OFF/ON		ON	-	-	
BUZZER	CLICK OFF/ON	ON	-	-	
	WARNING OFF/ON	ON	-	-	
LEVEL DISP DIGIT *		2	3	1	
WINDOW TRANSPARENT OFF/ON		ON	-	-	
SET CLOCK	YR-MO-DY	ON	-	-	
	MO-DY-YR	OFF	-	-	
	DY-MO-YR	OFF	-	-	
SELECT COLOR @@@@		COLOR1	-	-	

8.3 Help

Procedure

1. Displays a menu for displaying help.
2. Press **HELP**. An explanation for the displayed menu appears.
3. Select the soft key of the help text to display, then press the **SELECT** soft key. The help information is displayed.
4. To quit, press the **QUIT HELP** soft key.

Menu after pressing HELP

YOKOGAWA 2006 May 11 19:10

KEY	EXPLANATION
SWEEP	Selects the sweep mode.
AUTO	This key automatically sets the optimal measurement conditions for the light source being measured. MORE INFO
REPEAT	Perform repeat sweeping. The soft key is highlighted and repeat sweeping starts.
SINGLE	Perform a single sweep. The soft key is highlighted and a single sweep starts.
STOP	Stop sweeping.
SEGMENT MEASURE	Measure just the number of sampling points set using the <SEGMENT POINT> key, with the current stopped position serving as the sweeping start position.
SEGMENT POINT 501	Set the number of sampling points for performing <SEGMENT MEASURE>key. Setting Range : 1 to 50001 (Default:1)
SWEEP PER L1-L2 ON	Set a function which limits the sweeping range during a sweep to the space between line markers. MORE INFO
SWEEP INTERVAL MINIMUM	Set the time from one sweeping start to the next sweeping start during repeat sweeping. MORE INFO

Selection of soft keys for displaying help

Displays the selected help text

HELP
QUIT HELP

8.4 Registering and Loading Character Strings

In menus such as File Name that have PRESET WORD soft keys, you can register input character strings and load previously registered strings.

Procedure

Registering Strings

1. After a string has been entered in the string name entry screen, press the **PRESET WORD** soft key.
The character string registering/loading menu appears.
2. Select a registration number using the UP and DOWN arrow keys.
3. Press the **SAVE** soft key. The character string is registered to the specified number.

Loading Character Strings

1. After moving the cursor over the place to enter a string in the string name entry screen, press the **PRESET WORD** soft key.
The character string registering/loading menu appears.
2. Select the registration number of the string to load using the UP and DOWN arrow keys.
3. Press the **RECALL** soft key. The character string is registered to the specified number.

Deleting Character Strings

1. In the string name entry screen, press the **PRESET WORD** soft key.
The character string registering/loading menu appears.
2. Select the registration number of the string to delete using the UP and DOWN arrow keys.
3. Press the **CLEAR** soft key. The character string is registered to the specified number.

The screenshot shows a menu titled "WRITE : GRAPHICS TO FILE" with a timestamp of "2006 Mar 07 21:11". The main area displays a list of registered character strings:

REGISTRATION NUMBER	FILE NAME	DATE & TIME	LABEL/PROGRAM NAME
G0013	DIR_1	2006-03-01 18:11:34	<DIRECTORY>
G0012	DIR_12	2006-03-01 20:54:42	<DIRECTORY>
G0000	G0000.BMP	2006-03-07 13:04:13	
G0001	G0001.TIF	2006-03-01 12:55:20	
G0001	G0001.BMP	2006-03-07 13:04:24	
G0001	TIF		
G0002	BR		!@#%&'()*+,-./:;<=>?
G0003	BR		abcdefghijklmnopqrstuvwxyz @[-]~^_{}
G0004	BR		0123456789
G0012	BR		.BMP

Below the list is a "SAVE/RECALL : PRESET WORD" section with a "PRESET WORD" field containing "G000000000000".

Navigation and action keys are shown on the left and right sides of the screen:

- Left side: >, <, INSERT, DELETE, ALL CLEAR, ENTER, **PRESET WORD**, DONE, FILE NAME, UP/FILE, CANCEL.
- Right side: ^, v, CLEAR, SAVE, RECALL, **PRESET WORD**, FILE NAME, UP/FILE, RETURN.

At the bottom, it shows "TOTAL: 18 FILES" and "FREE: 14,659,325,352 BYTES".

List of registered character strings

8.5 Locking Keys

This function prevents the AQ6375B from being operated using keys other than those registered as user keys.

For details on how to register user keys, see section 8.1, "Registering Soft Keys."

Procedure

Locking the Keys

1. Press **SYSTEM**. The soft key menu regarding the system appears.
2. Press the **MORE** soft key repeatedly until the MORE 3/4 menu is displayed.
3. Press the **OPERATION LOCK** soft key. A password input screen appears.
To cancel this screen press another soft key or panel key.
4. Enters the password. The default password is 1234.
5. Press the **LOCK** soft key. A message stating that the keys have been locked appears, and the soft key menu changes to a USER menu.

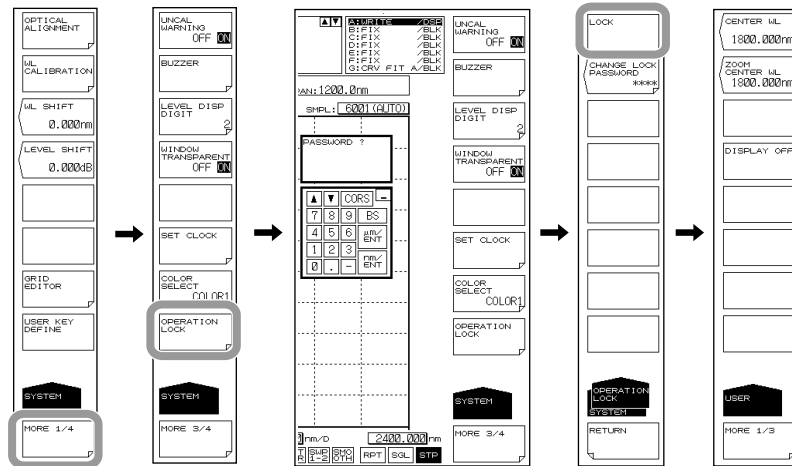

Note

- If no user keys are registered, nothing appears on the USER soft key menu. In the screen example, three soft keys, CENTER WL, ZOOM CENTER WL, and DISPLAY OFF, are registered.
- While the keys are locked, only the following panel keys can be used.
USER, LOCAL (release remote mode), HELP, COPY, POWER switch
- If you forget the password, initialize the data (ALL CLEAR). For the procedure, see section 8.2, "Data Initialization."
- The power switch is enabled even while the keys are locked. If you turn off the AQ6375B in the lock mode, the AQ6375B will start in lock mode when the power is turned back on.

8.5 Locking Keys

• Changing the Password

5. Press the **CHANGE LOCK PASSWORD** soft key. A password input screen appears.
6. Enters a new 4-digit password. A screen to reenter the password appears.
7. Reenter the password entered in step 6. A password change completion message appears.

Note

- The characters that can be used for the password are numbers from 0 to 9.
- If you forget the password when the keys are locked, you will not be able to unlock.
If you change the password from the default, manage your password carefully.

Unlocking the Keys

1. Press any of the locked keys (other than USER, LOCAL, COPY, or HELP keys or POWER switch). A soft key menu for unlocking the keys appears.
2. Press the **UNLOCK** soft key. A password input screen appears.
3. Enters the password. A message stating that the keys have been unlocked appears, and the soft key menu changes to a USER menu.

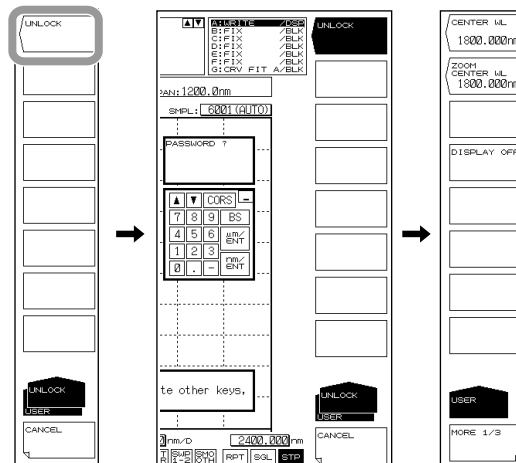

Note

Even when the keys are locked, you can still use the AQ6375B remote commands and program commands as usual. However, if the AQ6375B is in remote mode as a result of receiving REN (Remote Enable) or a listen address with ATN set to True from the controller, the key lock cannot be released. In such a case, press the LOCAL key to switch the AQ6375B to remote mode, and then release the key lock.

For details on switching between local and remote modes, see section 1.2 in the AQ6370C/AQ6370D/AQ6373/AQ6373B/AQ6375/AQ6375B Optical Spectrum Analyzer Remote Control User's Manual, IMAQ6370C-17EN.

8.6 Other Settings

Procedure

UNCAL mark and Warning Display Settings

1. Press **SYSTEM**.
2. Press the **MORE 1/4** soft key two times to display the MORE 3/4 screen.
3. Press the **UNCAL WARNING OFF ON** soft key. The settings turns ON and OFF each time you press the key. When ON, the UNCAL mark and a warning is displayed.

Buzzer Settings

1. Press **SYSTEM**.
2. Press the **MORE 1/4** soft key two times to display the MORE 3/4 screen.
3. Press the **BUZZER** soft key. The menu for turning the click sound and warning sound ON/OFF is displayed.
4. Press the **CLICK** or **WARNING** soft key. The settings turn ON and OFF each time you press the selected soft key. When ON, the buzzer sound is enabled.

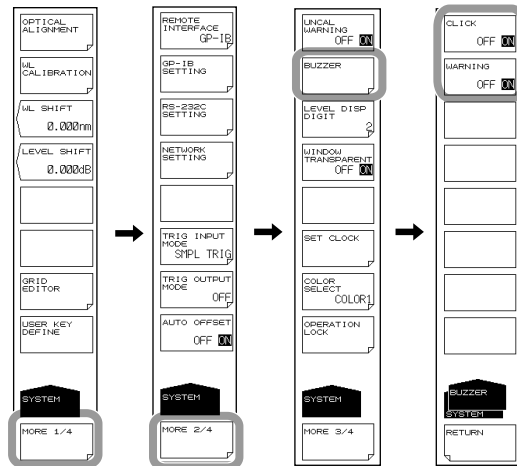

Setting the Test Mode

The test mode is adjusted at the factory, and is not typically changed by end users.

1. Press **SYSTEM**.
2. Press the **MORE 1/4** soft key three times to display the MORE 4/4 screen.
3. Press the **TEST MODE** soft key. The password entry screen is displayed.
4. To cancel this screen press another soft key or panel key.

Turning Automatic Offset ON/OFF

You can specify whether to have the instrument perform automatic offset adjustment on its internal amplifier circuit.

1. Press **SYSTEM**.
2. Press the **MORE** soft key repeatedly until the MORE 2/4 menu is displayed.
3. Press the **AUTO OFFSET SETTING** soft key. The automatic offset setup menu appears.
4. Press the **AUTO OFFSET OFF ON** soft key. The settings turns ON and OFF each time you press the key. When this is set to ON, the offset is adjusted automatically.
5. Press the **INTERVAL** soft key to set the automatic offset execution interval. (We recommend the default value of 10min.)

Note

- If the AUTO OFFSET key is OFF, the offset can fluctuate over time, and the level axis performance can degrade. Always have it turned ON.
 - When the AUTO OFFSET key is set to ON,  is displayed at the bottom of the screen.
-

Setting the Remote Monitor

This function can be used to monitor the instrument's screen and control the instrument from a remote PC that is connected over TCP/IP. To use this function, you need remote monitoring software (not included).

1. Press **SYSTEM**.
2. Press the **MORE** soft key repeatedly until the MORE 2/4 menu is displayed.
3. Press the **NETWORK SETTING** soft key. The Ethernet setup menu is displayed.
4. Press the **REMOTE MONITOR** soft key. The remote monitor setup menu is displayed.
5. Press the **MONITOR PORT** soft key. Each time you press the soft key, the setting toggles between ON and OFF. When this is set to ON, the remote monitor is enabled.

Sharing Directories

The user area directory of the AQ6375B internal memory can be shared on a PC.

1. Press **SYSTEM**.
2. Press the **MORE** soft key repeatedly until the MORE 2/4 menu is displayed.
3. Press the **NETWORK SETTING** soft key. The Ethernet setup menu appears.
4. Press the **FOLDER SHARING** soft key. A directory sharing setup menu appears.
5. Press the **READ ONLY** soft key. Directory sharing is enabled.
Pressing the **DISABLE** soft key disables directory sharing.

Turning the Display OFF

This function can be used to temporarily turn the display OFF.

1. Press **DISPLAY**.
2. Press the **DISPLAY OFF** soft key. The display turns OFF.

If you press a panel key or move the mouse, the display will turn ON.

Configuring a Firewall

You can close the TCP port when the communication interface (ETHERNET), remote monitoring, and directory sharing are not in use.

1. Press **SYSTEM**.
2. Press the **MORE** soft key repeatedly until the MORE 2/4 menu is displayed.
3. Press the **NETWORK SETTING** soft key.
The Ethernet setup menu appears.
4. Press the **FIREWALL** soft key.
Each time you press the soft key, the setting toggles between ON and OFF.
When this is set to ON, the firewall is enabled.

Clearing Measured Data, Analysis Conditions, Parameters, Etc.

The PRESET key clears all internal settings of the AQ6375B except for the remote interface (ETHERNET, GP-IB, and RS232) settings.

1. Press **PRESET**. A confirmation message for clearing the message and YES and NO soft keys appear.
2. Press the **YES** soft key. The measured data and parameter settings are cleared.
If you do not want to clear them, press the **NO** soft key. The previous soft key menu will return.

Explanation

Automatic Offset

When the AUTO OFFSET is set to ON, the offset of the internal amplifier circuit is adjusted at time intervals of approximately 10 minutes. (Default: ON)
If the AUTO OFFSET is OFF, the auto-offset adjustment operation is not performed.
When you switch from OFF to ON, the offset adjustment is executed immediately.
When switched to ON, the offset adjustment is performed during repeat sweeping when sweeping reaches 100%. During a single sweep, the offset adjustment is performed when the sweep is completed.
During offset adjustment, a message indicating that the offset is being adjusted is displayed in the lower-left corner and in the center of the top part of the screen.

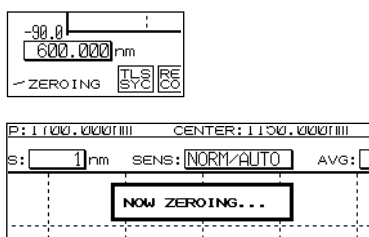

Note

If, during offset adjustment, you use key operations or remote commands to execute a sweep, the sweep will start after the offset adjustment is completed.

Remote Monitor

This function can be used to monitor the instrument's screen and control the instrument from a remote PC that is connected to the instrument through a TCP/IP port.

To use this function, you need remote monitoring software (not included). You cannot use the remote monitoring port to perform remote control with normal remote commands.

User Name and Password

A user name and password are required to access the instrument using this function.

Use the menu that is displayed when you press the REMOTE USER ACCOUNT soft key in the Ethernet setup to specify these settings. See the remote control user's manual, IM AQ6370C-17EN.

MONITOR PORT

Enables and disables the remote monitor TCP/IP port.

If you set this to OFF, the remote monitor is disabled.

PORT NO.

This is the remote monitor TCP/IP port number. It is fixed to 20001. You cannot use this port to perform remote control with normal remote commands.

DISCONNECT

During remote monitoring, press this soft key to disconnect the instrument from the remote PC.

This soft key can only be used when the instrument is connected to a PC.

Sharing Directories

The user area directory of the AQ6375B internal memory can be shared on a PC. When the user area directory is shared, the files in the directory can be copied to the PC over the network. You cannot save files to the AQ6375B.

Turning the Display OFF

This function can be used to temporarily turn the display OFF. Use this function when you are using the instrument in a darkroom or similar environment in which the light from the screen has an effect on the work.

DISPLAY OFF

Press this soft key to turn OFF the backlight, which will also turn the display OFF.

When Remote Commands Have Been Used to Turn the Display OFF

If remote commands have been used to turn the display OFF, even if you perform panel key or mouse operations to turn the display ON, the following message will be displayed and the display will be turned OFF after approximately 5 seconds.

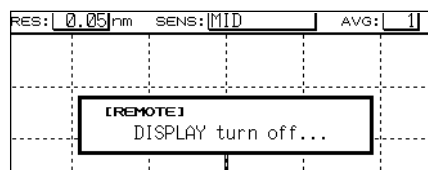

To keep the display turned ON, use a remote command, or press LOCAL to switch the instrument from remote to local mode.

Clearing Measured Data, Analysis Conditions, Parameters, Etc.

This function clears all measurement parameters, display parameters, analysis parameters, and the waveform display. It is the same operation as when the AQ6375B receives an *RST remote command.

The following data is not cleared.

- Remote interface (ETHERNET, GP-IB, and RS232C) settings
- Wavelength calibration data and alignment adjustment data
- Various type of data saved to internal memory
- Registered programs created using the program function

Firewall

This feature closes the TCP port to cut off the communication when features that use the TCP port are set to off.

Feature Name Soft Key Name	Operation
Directory sharing <FOLDER SHARING>	DISABLE: Communication is cut off (the TCP port is closed). READ ONLY: Communication is not cut off (the TCP port is open).
Remote monitoring <MONITOR PORT ON/OFF>	OFF: Communication is cut off (the TCP port is closed). ON: Communication is not cut off (the TCP port is open).
Communication interface <REMOTE INTERFACE>	GP-IB, RS232: Communication is cut off (the TCP port is closed). ETHERNET: Communication is not cut off (the TCP port is open).

8.7 Displaying System Information

Procedure

Displaying system information

1. Press **SYSTEM**.
2. Press the **MORE 1/4** soft key to display MORE 4/4.
3. Press the **SYSTEM INFORMATION** soft key. The system information menu is displayed.
4. Press the **SYSTEM INFO** soft key. The system information is displayed on screen.
5. If you press the **RETURN** soft key, you are returned to the original menu.

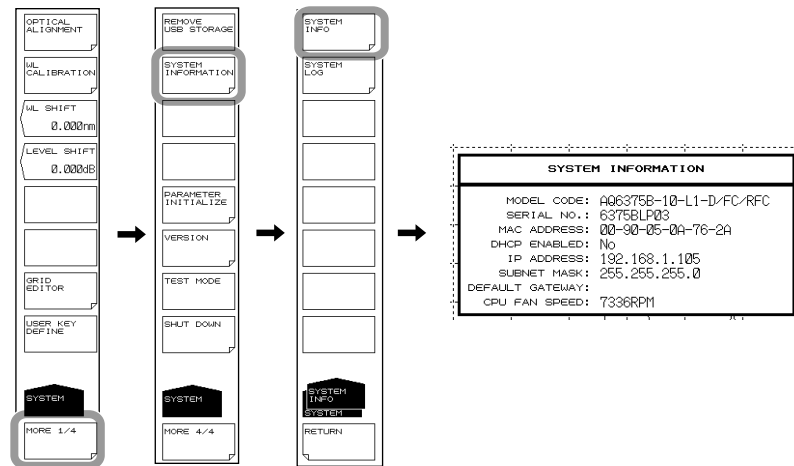

Display Contents

MODEL	Model No.
SPECIAL CODE (not always displayed)	Special Code
SERIAL NO.	Serial No.
MAC ADDRESS	MAC address of the Ethernet port
DHCP ENABLED	TCP/IP settings
IP ADDRESS	
SUBNET MASK	
DEFAULT GATEWAY	
CPU FAN SPEED	CPU fan rotation speed (RPM)

9.1 Updating the Firmware

When there is a firmware update, such as when new functions are added, you can update the firmware in the AQ6375B. Download the update firmware from the YOKOGAWA website.

<http://www.yokogawa.com/yumi/>

CAUTION

- When the firmware is being updated, do not manually turn the power off. If you do, you may not be able to start the AQ6375B.
- If there are multiple update firmware files in the USB memory device, the AQ6375B will not be updated.

French

ATTENTION

- Lorsque le micrologiciel est en cours de mise à jour, ne pas mettre manuellement l'instrument hors tension. Le cas échéant, l'AQ6375B risque de ne pas démarrer.
- L'AQ6375B ne sera pas mis à jour en cas de présence de plusieurs fichiers de mise à jour micrologicielle sur la clé USB, l'AQ6375B n'est pas mis à jour.

Preparing to Update the Firmware

The AQ6375B can read the update firmware (.UPD extension) in one of two ways. Prepare the update firmware according to your environment.

- **Reading the Firmware from a USB Memory Device**
Create a directory named "UPDATE" in the USB memory device, and save the update firmware (.upd extension) in that directory.
Check that the AQ6375B is not connected to a network. If it is, you will not be able to update.
- **Reading the Firmware from an External PC**
Save the update firmware (.upd extension) in the external PC, and connect the PC to the AQ6375B over a network.

Procedure

Reading the Firmware from a USB Memory Device

1. Press **SYSTEM**. A system menu appears.
2. Press the **MORE** soft key repeatedly until the MORE 4/4 menu is displayed.
3. Press the **VERSION** soft key. The firmware version is displayed.
4. Press the **UPDATE(USB)** soft key. The "Insert Update Files" message appears.
5. Connect a USB memory device containing the update firmware to the AQ6375B.
6. Press the **CONTINUE** soft key. A list of update firmware is displayed.
7. The message "Please disconnect LAN CABLE and remove USB storage device" appears. Remove the USB memory device.

9.1 Updating the Firmware

Note

Do not reconnect the network cable that you removed from the ETHERNET port until the updating is complete.

8. Press the YES(REBOOT) soft key.

The AQ6375B automatically restarts and starts updating. A update-in-progress screen appears while the firmware is being updated. When updating is complete, the AQ6375B automatically shuts down. This completes the update procedure. Turn the power on, and the AQ6375B will start normally.

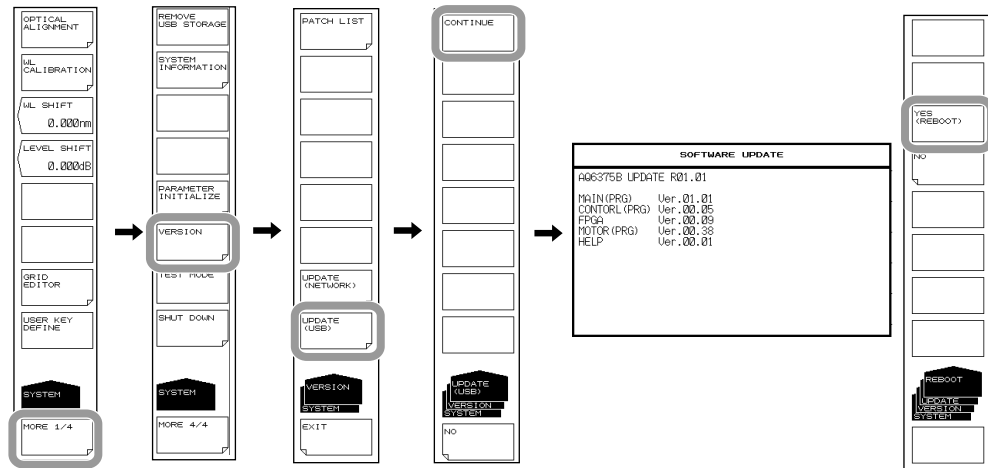

Note

- If the AQ6375B is connected to a network, you will not be able to update the firmware. If it is connected to a network, the message “Please disconnect LAN CABLE and remove USB storage device” will appear, and the YES soft key will be unavailable. When you remove the cable from the ETHERNET port, the message “Please remove USB storage device” will appear, and the YES soft key will become available.
- Once updating starts, you cannot abort the process until it is complete. You can cancel using the NO soft key or another key in any of the steps before step 7.

Now Updating..

DO NOT turn off the instrument.

When the update is completed, the instrument will be turned off automatically.

The screen that appears while updating

Reading the Firmware from a PC

1. Press **SYSTEM**. A system setup menu appears.
2. Press the **MORE** soft key repeatedly until the MORE 4/4 menu is displayed.
3. Press the **VERSION** soft key. The firmware version is displayed.
4. Press the **UPDATE(NETWORK)** soft key. The "Insert Update Files (NETWORK)" message appears.
5. Connect the PC containing the update firmware to the AQ6375B over a network.
6. Use a file management software on the PC to copy the update software (.upd extension) to the UPDATE directory of the AQ6375B internal memory.
7. For the remaining of the procedure, follow the steps from step 6 in "Reading the Firmware from a USB Memory Device."

Note

When you update the firmware, the setup data will be initialized.

If necessary, save the setup data. For the operating procedure, see section 7.5.

9.2 Mechanical Inspection

WARNING

When performing inspection, turn OFF the MAIN POWER switch on the rear panel and remove the power cable.

CAUTION

- If any foreign particles become trapped in the various connectors, malfunction or damage can result.
 - If any of the various types of connectors do not fit snugly, the instrument may not operate normally.
 - If any abnormalities occur, please contact your nearest Yokogawa representative.
-

French

AVERTISSEMENT

Lors de la réalisation d'une inspection, mettre l'instrument hors tension en plaçant l'interrupteur MAIN POWER sur OFF sur le panneau arrière, puis débrancher le cordon d'alimentation.

ATTENTION

- Si des corps étrangers se retrouvent emprisonnés dans les différents connecteurs, un dysfonctionnement ou un endommagement risque de se produire.
 - Si l'ajustement de l'un des différents types de connecteurs n'est pas parfait, l'instrument risque de ne pas fonctionner normalement.
 - En cas d'anomalie, contacter le représentant Yokogawa le plus proche.
-

Check the following:

- That the instrument's exterior is not damaged or deformed.
 - That all switches, connectors, and other assembled parts are not loose.
 - That switches can be operated smoothly.
-

9.3 Operational Inspection

Checking the Operations of Each Switch

With the power to the instrument turned ON, operate each switch once briefly to check that the unit functions properly.

9.4 Inspection of Wavelength Accuracy

Perform a check of the instrument's wavelength accuracy.

Use a light source such as a gas laser whose wavelength accuracy is known.

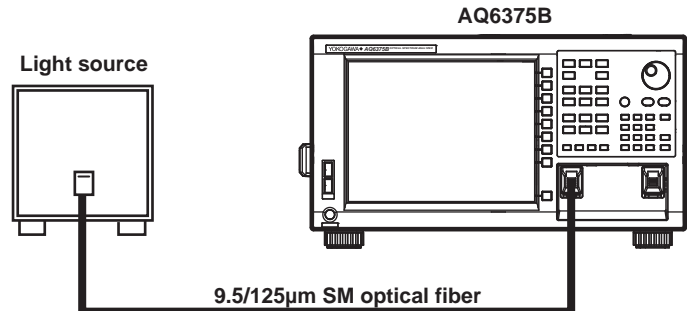

Procedure

1. Connect a light source to the instrument as shown in the figure above, then measure spectrums of the light source.
Confirm that the THRESH 3 dB center wavelength of the measured spectrum matches the wavelength of the light source (is within the wavelength accuracy standard).
For more information, see section 6.1, "Spectrum Width Measurement".
2. If the wavelength error is large, use the internal reference light source to calibrate wavelengths.
For the calibration procedure, see section 2.2, "Wavelength Calibration."
3. For performing wavelength calibration, check wavelength accuracy again according to procedure.

Note

If the wavelength error of the instrument is outside of $[\pm] 20$ nm, you cannot perform wavelength calibration with the internal reference light source. In this case, readjustment is necessary. Please contact your nearest Yokogawa representative.

9.5 Inspection of Level Accuracy

Perform a check of the instrument's level accuracy.
Use a light source of 1550 nm.

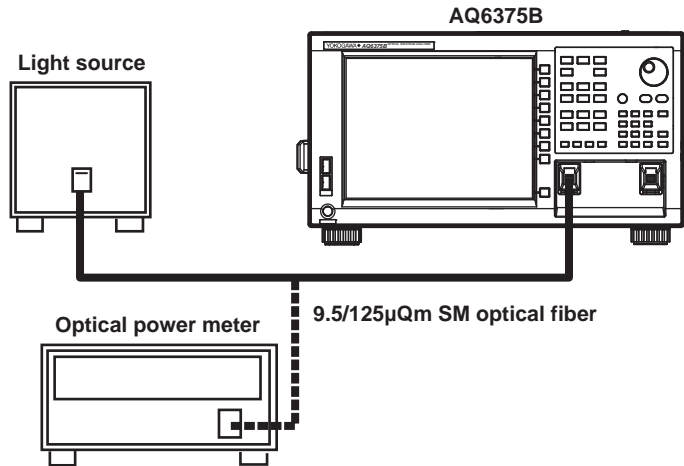

Procedure

1. Execute the alignment adjustment function on the unit's internal monochromator. For details, see section 2.1, "Alignment Adjustment."
2. Connect the light source and instrument with a 9.5/125 [MICRO]m SM optical fiber and turn the light source ON.
3. Press **SWEEP**.
4. Press the **AUTO** soft key. The spectrum of the light source is automatically measured.
5. When automatic measurement is complete and REPEAT sweep begins, press **SETUP**.
6. Press the **RESOLUTION** soft key then set the instrument's wavelength resolution to 2 nm.
7. Press **PEAK SEARCH** or **MARKER** then measure the peak level of the waveform.
8. Remove the SM optical fiber from the instrument and connect the light source to an optical power meter.
9. Use the optical power meter to measure power values of the light source.
10. Check that peak level values obtained in step 7 agree with the ones obtained by the optical power meter (within the specified level accuracy). For information on level accuracy, see chapter 9 of the *Getting Started Guide*, IM AQ6375B-02EN.

Note

- Connect the light source with the unit via the 9.5/125 mm SM optical fiber. Then, turn on the light source. If a wide spectrum light source is used, the power measurements may not be accurate.
- The level measurement error of the instrument changes as shown in the figure below, according to the numerical aperture (NA) of the optical fiber connected to the input connector. The instrument's absolute level is calibrated using a 9.5/125 µm single-mode optical fiber (SSMA type in JIS C6835, with PC polishing, 9.5 µm mode field diameter, and 0.104 to 0.107 NA). Even if a single-mode optical fiber is used, the level accuracy will be outside the specifications if the NA is not in the range shown above.

9.6 Replacing Fuses

There is a fuse inside the instrument. However, you should not replace the fuse yourself. It could indicate additional internal damage.
If you believe the fuse is blown, please contact your nearest YOKOGAWA dealer.

9.7 Daily Maintenance

Cleaning the Exterior of the Instrument

When removing dirt from the case or operation panel, remove the power cord from the power outlet, then wipe gently with a clean, dry cloth. Do not use volatile chemicals since this might cause discoloring and deformation.

Cleaning the Optical Output Section of the Internal Reference Light Source



WARNING

The instrument has a built-in reference light source for alignment adjustments, and infrared light is always being output from the optical output connector. Never look into the optical output connector. Infrared light entering the eyes can cause severe injury and loss of vision.

CAUTION

Wiping with a soiled cleaner can damage the optical outputs.

French



AVERTISSEMENT

Cet instrument dispose d'une source de lumière de référence intégrée pour les ajustements d'alignement. La lumière infrarouge est toujours émise depuis le connecteur de sortie optique. Ne regardez jamais directement dans le connecteur de sortie optique. La lumière infrarouge risquerait de gravement vous blesser ou de provoquer une perte de vision.

ATTENTION

L'utilisation d'un écouvillon sale peut endommager les sorties optiques.

Cleaning the Optical Connector Connection Section of the Connector Adapter

It is recommended that the following cleaner be used for this procedure.

Recommended cleaner: "CleTOP Stick Type" (NTT-ME)

Open the optical connector cover at the front of the unit. Use the cleaner to clean the optical connector connection section. Grasp it as close to the cleaner support (base) as possible. Insert the cleaner straight into the optical connector connection section and rotate it.

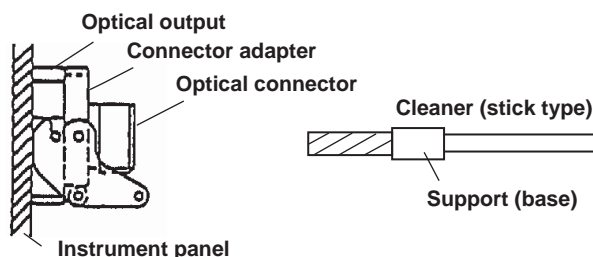

Cleaning the Optical Output



WARNING

The instrument has a built-in reference light source for alignment adjustments, and infrared light is always being output from the optical output connector. Never look into the optical output connector. Infrared light entering the eyes can cause severe injury and loss of vision.

CAUTION

- When attaching or removing a connector adapter, be careful not to damage the ferrule edge or adapter.
- Wiping with a soiled swab can damage the optical outputs.

French



AVERTISSEMENT

Cet instrument dispose d'une source de lumière de référence intégrée pour les ajustements d'alignement. La lumière infrarouge est toujours émise depuis le connecteur de sortie optique. Ne regardez jamais directement dans le connecteur de sortie optique. La lumière infrarouge risquerait de gravement vous blesser ou de provoquer une perte de vision.

ATTENTION

- Lorsque vous branchez ou retirez un adaptateur de connecteur, veillez à ne pas endommager le bord de la fêrulle ou l'adaptateur.
- L'utilisation d'un écouvillon sale peut endommager les sorties optiques.

Turn the power OFF, then remove the connector adapter from the instrument. Remove the connector adapter, then use a swab dipped into a small quantity of undiluted alcohol to clean the ferrule end of the optical output section. Be sure to use a new swab each time. Remove the connector adapter from the unit. For removal, see chapter 6 of the *Getting Started Guide*, IM AQ6375B-02EN. Use a swab dipped into a small quantity of undiluted alcohol to clean the ferrule end of the optical output section. After the cleaning is finished, connect the connector adapter to the instrument.

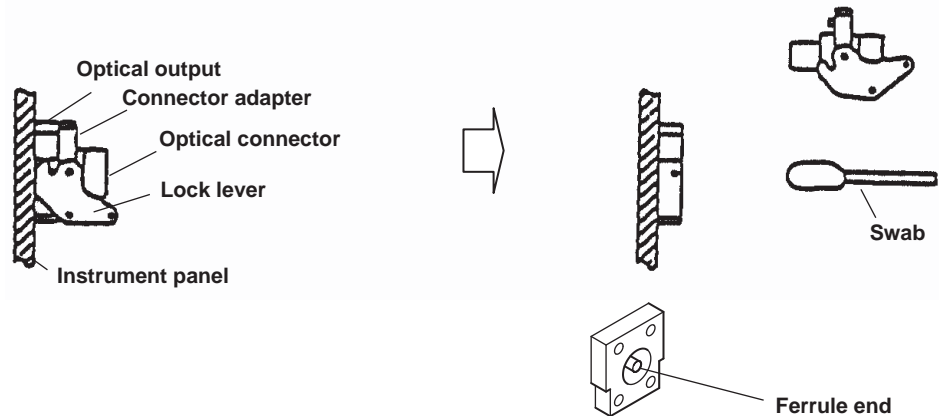

9.8 Care during Storage

If the instrument is stored for a long time, sufficient care should be taken of the following:

- Wipe off any dust, fingerprints, or other dirt that has adhered to the instrument.
- Perform the inspections given in section 9.3, "Operational Inspection" to check that the instrument operates properly.
- Do not store the unit in the following locations:
 - Where it would be exposed to direct sunlight or excessive dust
 - Where water droplets can contact the instrument, or where high humidity can cause them to form on the instrument
 - Where active gas is present, or where the instrument may be subject to corrosion
 - Where the humidity indicated below can occur
 - Where temperatures can exceed 50 [DEGC]
 - Where the temperature can fall below -10 [DEGC]
 - Where the humidity can exceed 80%

For extended storage, it is recommended that the instrument be stored within the range of the following environmental conditions while, at the same time, the above conditions are met.

- Temperature 5–30[DEGC]
- Humidity 40-70%
- Daily fluctuations of temperature/humidity are small.

9.9 Recommended Replacement Parts

The following parts are wearable. It is recommended to replace them after the time period indicated below. For replacement of parts, please contact your nearest Yokogawa representative.

Part Name	Replacement Period
Cooling fan	3 years
Backup battery (lithium)	5 years
LCD backlight	At normal operating conditions, approximately 70000 hours

9.10 Warning Display Function

No.	Message	Cause of Warning
No.1 - 49: Message generation after the execution of functions		
1	Unsuitable Resolution	Data may not be extracted completely, because the resolution setting is not appropriate for the span and the sampling number.
2	Unsuitable Level Scale	A level scale larger than 5 dB/DIV has been set in the range fixed mode (SENS:NORM HOLD).If a level scale is set to 5 dB/DIV or more in the range fixed mode, data from the top and bottom of the screen may not be properly displayed.
3	Unsuitable Ref Level	Although an attempt was made to set the peak level of a waveform to the reference level, the nearest value within the range was chosen because the peak level value was outside the setting range of the reference level values.
4	Unsuitable Marker Value	Although an attempt was made to set a maker value to the reference level, the nearest value within the range was chosen because the marker value was outside the setting range of the reference level values.
5	<AUTO ANALYSIS> off	Selection of the <AUTO ANALYSIS> key was canceled.
6	<AUTO SEARCH> off	Selection of the <AUTO SEARCH> key was canceled.
7	Each Trace resolution mismatch	When the calculation between traces was performed, resolutions of traces were set differently.
8	<HOLD> off	HOLD was canceled because the allocation of traces to the divided screen was changed.
9	Trace * state changed	The HOLD state was canceled because the state of traces under HOLD was changed from FIX to another state.
10	<AUTO REF LEVEL> off	Selection of the <AUTO REF LEVEL> key was canceled.
11	<AUTO SUB SCALE> off	Selection of the <AUTO SUB SCALE> key was canceled.
12	Input light power is too high	Since the intensity of input light is too high, measuring waveforms may be saturated.
13	Level scale changed <dBm>	The horizontal scale was changed to wavenumber mode with the level scale set to dBm/nm or dBm/THz.
14	Unsuitable sampling point	Sample point setting for using the smoothing function is missing.
15	ADVANCED MARKER off	An assigned advanced marker was set to off.
16	<ADVANCED MARKER> off	The advanced marker function was turned off.
17	<LEVEL UNIT> changed	The <LEVEL UNIT> key setting was changed.
18	<POWER/NBW> trace state changed	The <POWER/NBW> trace setting in trace settings was changed to FIX mode.
19	Analysis result is not correct	Because analysis was performed on a POWER/NBW trace, a correct analysis result may not be displayed.
No.50 - 199: Generation of a reason why a function cannot be executed		
54	Unsuitable logging item setting	Logging item setting is not correct.
101	All traces in FIXed state	Waveforms cannot be re-written, because all traces have been set to FIX.
102	Sweep stopped	Sweep was stopped, because all traces were set to FIX during the sweep.
103	No data in active trace	An attempt was made to execute analysis functions when there was no data in an active trace.
107	Unsuitable memory number	A number other than 0 - 99 was specified when the memory was saved or recalled. Or, an attempt was made to recall data from a memory where waveforms have not been saved.
108	Marker setting out of range	An attempt was made to execute the analysis function between markers in the state where both line marker 1 and line marker 2 were set outside the measurement range.
109	Auto sweep failed	Although the AUTO sweep started, the sweep stopped because optimum conditions were not found.
110	No data between line markers	An attempt was made to execute the analysis function in a state where there was no data in the line markers of an active trace.

9.10 Warning Display Function

No.	Message	Cause of Warning
111	<G=MKR FIT> failed	Trace G cannot write fitting curve because numbers of data is not sufficient during <G=MKR FIT>.
120	USB Storage not inserted	USB storage medium not inserted.
121	USB Storage not initialized	SUB storage not initialized.
122	USB Storage is write protected	The USB storage device is write protected.
123	File not found	The specified file cannot be read because it has not been found. Or, the file does not exist on the disk.
124	Illegal directory name	Directory cannot be created because the name is not valid.
125	Illegal file name	A file cannot be saved due to an incorrect file name.
126	Directory already exists	Directory cannot be created because a directory of the same name already exists.
128	File is write protected	The file cannot be re-written or deleted because its property has been set to READ ONLY.
129	USB Storage full	The file cannot be saved, because the hard disk or the USB storage device is full.
130	Directory full	No files can be created because the directory area is full.
131	No data	There was no data to be saved, although an attempt was made to save the file.
132	File is not a trace file	The file cannot be read because it is not a waveform file.
133	File is not a program file	The file cannot be read because it is not a program file.
134	File is not a data file	The file cannot be read because it is not a data file.
135	File is not a settings file	The file cannot be read because it is not a settings file.
137	File is not a template file	File cannot be loaded since it is not a template file or there is a problem with the format of the template data.
138	Cannot copy	The file copy cannot be executed because the "copy from" file and the "copy to" file have the same name.
140	No paste possible	The paste operation cannot be executed during the editing of programs because the number of blank rows is not sufficient.
141	No merge possible	It is not possible to execute a merge during the editing of programs because the merged result would exceed the maximum number of rows.
142	WL calibration failed	Calibration cannot be executed because the level of a light source is not sufficient during the wavelength calibration or because wavelength deviations exceed the calibration range.
143	Optical Alignment failed	Alignment adjustment cannot be executed because the level of a light source is not sufficient during the alignment adjustment.
144	Go/No go judgment stopped	Go/No go judgment stopped because template data reading or AUTO sweep was carried out with Go/No go judgment function set to ON.
145	No template data	Go/No go judgment or template data display was attempted to be made with no template data provided.
150	File is not a logging file	The file cannot be loaded because it is not a logging file.
151	Disk space is not enough for logging	Logging cannot be started because there is not enough space for saving waveform files with the logging function.
152	Logging was skipped for Auto zeroing	Unable to log at the specified interval because auto offset was in progress at the time logging would have occurred (displayed only the first time after logging is started).
153	Sweep time exceeds the set interval	Unable to log at the specified interval because the sweep time is longer than the interval (displayed only the first time after logging is started).
154	This file is not compatible	The file could not be loaded because the model does not support it.
160	Printer paper empty	There was no printer paper, although an attempt was made to use the internal printer for printing.
161	Printer head up	It was not possible to execute printing because the head-up lever of the internal printer was raised.
164	Printer Head Temperature error	The temperature of the built-in printer's printer head is abnormal when printing.
170	Illegal character	An illegal character was entered for a network name.

No.	Message	Cause of Warning
171	Illegal address	An illegal address was set to an IP address.
172	This version is not compatible	Attempted to load an incompatible update file.
173	Update file read error	An incorrect number of files or file corruption was found when attempting to load the update file.
174	Invalid password	The password entered for the key lock is not correct.
175	Re-entered password is not matched	The two passwords entered for the key lock do not match.
176	Password needs to be 4-digit number	The password entered for the key lock is not a 4-digit number.
No. 200 - 299: Warnings for hardware failures		
200	Fan motor stopped!	The fan motor (main unit) stopped. Automatically shuts down after 10 seconds from occurrence.
201	Calibration data failed!	Started up in emulation mode because there was a problem with the instrument's calibration data.
202	Fan motor stopped	The CPU fan stopped.
205	Internal communication error!	An abnormality occurred during instrument-internal communication.
206	Internal communication error!	An abnormality occurred during instrument-internal communication.
207	Internal Temperature Over!	Internal temperature is abnormally high. Automatically shuts down after 10 seconds from occurrence.
210	Internal Temperature warning!	Warning for rising internal temperature.
211	Auto offset error!	Obtained an abnormal value during AUTO OFFSET operation.
212	Auto offset error!	Obtained an abnormal value during AUTO OFFSET operation.
213	Auto temperature control error!	Problem with the light detector temperature control.
214	Measurement sequence error!	The sweep stopped because measurement sequence fell into disorder during the sweep.
220	Boot sequence error!	Started up in emulation mode because an abnormality occurred upon start-up
221	Boot sequence error!	Started up in emulation mode because an abnormality occurred upon start-up
222	Emulation Mode.	Entered emulation mode because an abnormality occurred.
223	Boot sequence error!	Started up in emulation mode because an abnormality occurred upon start-up
224	Internal communication error!	An abnormality occurred during instrument-internal communication.
225	Internal communication error!	An abnormality occurred during instrument-internal communication.
226	Internal communication error!	An abnormality occurred during instrument-internal communication.
227	Internal communication error!	An abnormality occurred during instrument-internal communication.
228	Memory allocation error!	Data memory initialization failed.
230	Monochromator error!	Entered emulation mode because an abnormality with the operation of the monochromator occurred.
231	Monochromator error!	Entered emulation mode because an abnormality with the operation of the monochromator occurred.
232	Monochromator error!	Entered emulation mode because an abnormality with the operation of the monochromator occurred.
233	Monochromator error!	Entered emulation mode because an abnormality with the operation of the monochromator occurred.
234	Monochromator error!	Entered emulation mode because an abnormality with the operation of the monochromator occurred.
235	Monochromator error!	Entered emulation mode because an abnormality with the operation of the monochromator occurred.
236	Monochromator error!	Entered emulation mode because an abnormality with the operation of the monochromator occurred.

9.10 Warning Display Function

No.	Message	Cause of Warning
No.300 - 399: Errors during the execution of program functions		
300	Parameter out of range	A variable value is out of range or is not defined for a command that sets a parameter using variables.
302	Scale unit mismatch	There is a difference between the Y-axis scale of the active trace and the unit of a parameter in the "LINE MKR 3 or 4" command.
303	No data in Active trace	Setting of the moving marker, a peak (or bottom) search, or activation of the analysis function was made with no data in the active trace.
304	Marker value out of range	Specified wavelength was out of the sweep range in the moving marker or line wavelength marker setting command.
305	No data in trace A or B	No waveform data in traces A or B when executing the "EDFA NF" command
306	Invalid data	Trace had no data when attempting to save it to memory or to write it to FD/HDD.
307	Unsuitable Write item	All data items were OFF at execution of "WRITE DATA".
320	Undefined variable	A command containing an undefined variable was executed.
321	Variable unit mismatch	The unit of each variable does not agree within a command containing two or more variables.
322	Overflow	An overflow occurred in an arithmetic operation.
323	Undefined marker variable	A command containing a marker-value variable was executed when no marker had been displayed.
324	Invalid marker variable	A command containing the corresponding variable was executed at a time other than immediately after execution of a spectrum width search, peak search, etc.
325	Undefined line number	GOTO command's jumping destination is a number other than 1 to 200.
326	F1 greater than F2	$F1 > F2$ when the "IF $F1 \leq @@@@ \leq F2$ " command was executed.
340	Printer paper empty	No printer paper
341	Printer head up	No print is made because the printer's head-up lever is raised.
345	Option does not respond	No response from an external device.
346	Option is not connected	No external device is connected.
347	GPIB2 not system controller	System controller connected to the GP-IB2 port has been set to an external computer.
360	Disk full	No file can be created due to insufficient free space on the USB storage medium.
361	USB Storage not inserted	USB storage medium not inserted.
362	USB Storage is write protected	The USB storage device is write protected.
363	USB Storage not initialized	USB storage not initialized. Or, it has been formatted in a format not supported by this instrument.
364	Directory full	Directory is full, therefore no file can be created.
365	File not found	The specified file cannot be read because it has not been found. Or, the file does not exist on the disk.
366	File is write protected	The file is specified to be read only, so that it cannot be rewritten or deleted.
367	No data	No data to store.
368	File is not a trace file	A file cannot be read because it is not a trace file.
369	Illegal file name	A file cannot be saved due to an incorrect file name.
380	Undefined program	An attempt was made to run a program that is not defined.
381	Syntax error	Command incorrect (a program has been rewritten for some reason).

Appendix 1 GRID Table for WDM Wevelength

Some analytical functions refer to the GRID table for analysis(See the following table.) The AQ6375B contains the nominal center frequencies specified by the ITU-T (International Telecommunication Union-Telecommunication sector) G692 as the GRID table. It also contains two tables: the standard GRID table created according to the pre-defined wavelength (frequency) range and the custom GRID table that users can edit freely.

List of Analytical Functions with GRID Tables

Function	Item	Parameter Name	Setting Parameter
WDM	DISPLAY SETTING	DISPLAY TYPE	DRIFT(GRID)
FILTER PEAK	CROSS TALK	ALGO	GRID
FILTER BOTTOM	CROSS TALK	ALGO	GRID
WDM FILTER PEAK	CAHNEL DETECTION/ NOMINAL WAVELENGTH	ALGO	GRIF FIT GRID
WDM FILTER BOTTOM	CAHNEL DETECTION/ NOMINAL WAVELENGTH	ALGO	GRIF FIT GRID

Note

Concerning the units of wavelength axis for GRID tables, wavelength values and frequency values can be changed by the setting of marker units.

The two GRID tables (standard and custom) have different parameter ranges, which are shown in the following table.

Type	Parameter Range
Standard GRID Table	Start frequency 192.1000 THz(fixed) Stop frequency 196.1000 THz(fixed) Reference frequency 125.0000 to 250.0000 THz Frequency spacing To be selected from among 200 GHz/100 GHz/50 GHz/25 GHz/12.5GHz
Fixed GRID Table	Start frequency 176.3486 to 229.7924 THz Stop frequency 176.3486 to 299.7924 THz Reference frequency 125.0000 to 250.0000 THz Frequency spacing 0.1 to 999.9 GHz

Standard GRID Table

This GRID table is created with pre-defined wavelength (frequency) ranges. It can be created in the following manner by setting the reference wavelength (frequency) and frequency spacing.

Custom GRID Table

Users can edit this GRID table freely. It is created automatically by setting the start/stop wavelength (frequency), reference wavelength (frequency), and frequency spacing. Users can add or delete an arbitrary channel to/from the created GRID table or edit wavelength (frequency) values for each channel there.

Appendix 2 Data Calculation Algorithms for Spectrum Widths

The AQ6375B can calculate spectrum widths of waveforms being displayed. This section provides four types of spectrum width calculation methods as well as algorithms for the NOTCH width calculation.

THRESH Method

This method is used to obtain the spectrum widths of two points, which are lower than the peak level by a threshold value (THRESH [dB]) specified by a parameter, as well as their center wavelengths.

The following table shows the details of parameters for the THRESH method.

Parameter	Abbreviation	Default Value	Setting Range	Unit	Description
THRESH	TH	3.00	0.01 to 50.00	dB	Threshold value
THRESH K	K	1.00	1.00 to 10.00	-	Multiplying factor
MODE FIT	MODE FIT	OFF	ON / OFF	-	Set whether the half of maximum point is aligned to the mode peak or not.

Algorithms differ depending on the number of mode peaks. Algorithms for these numbers are described below.

In the case of one mode peak

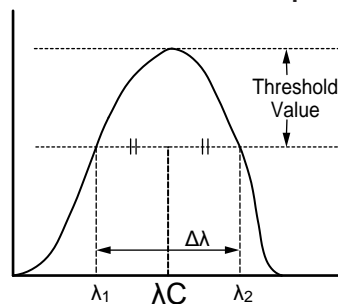

- Perform a mode search to obtain the mode peak.
- Set the wavelengths, which cross the line below the mode peak by the threshold value (THRESH[dB]), to λ_1 and λ_2 .
- Use the following equations, which incorporate multiplication by the multiplying factor K for λ_1 and λ_2 , to obtain new λ_1 and λ_2 .

$$\lambda'C = (\lambda_2 + \lambda_1)/2$$

$$\lambda_1 = K \times (\lambda_1 - \lambda'C) + \lambda'C$$

$$\lambda_2 = K \times (\lambda_2 - \lambda'C) + \lambda'C$$

- Obtain the spectrum width from the following equation.

$$\Delta\lambda = \lambda_2 - \lambda_1$$
- Obtain the center wavelength λC from the following equation.

$$\lambda C = (\lambda_2 + \lambda_1)/2$$

Note

If "MODE FIT" is set to ON in the case of a one mode peak, the spectrum width $\Delta\lambda$ and the center wavelength λC will become as follows.

$$\Delta\lambda = 0.0000\text{nm}$$

$$\lambda C = \text{center wavelength of the mode peak}$$

In the case of two or more mode peaks

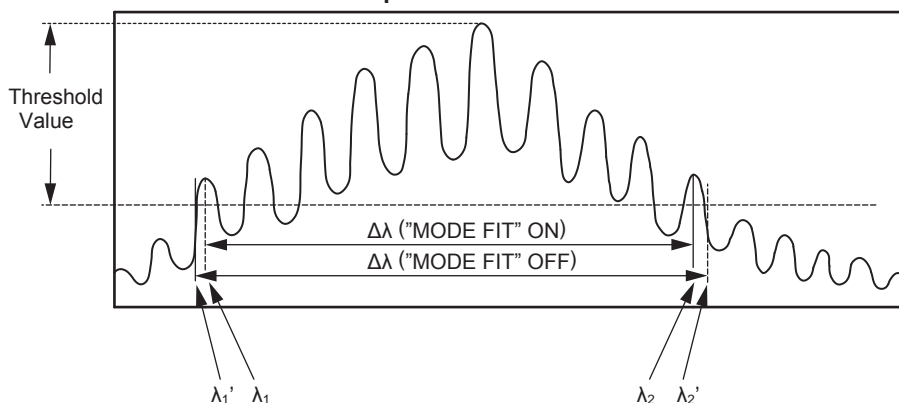

- If “MODE FIT” is ON, set the wavelengths of the mode peaks, which are outmost from the threshold value (THRESH[dB]) among the mode peaks, to λ_1 and λ_2 . If “MODE FIT” is OFF, set the wavelengths, which are located outside λ_1 and λ_2 , and which cross the line below the mode peak with the largest mode peak level by the threshold value (THRESH[dB]), to λ'_1 and λ'_2 .
 - If “MODE FIT” is ON, use the following equations, which incorporate multiplication by the multiplying factor K for λ_1 and λ_2 , to obtain new λ_1 and λ_2 .
 - When “MODE FIT” is ON
 - $\lambda'C = (\lambda_2 + \lambda_1)/2$
 - $\lambda_1 = K \times (\lambda_1 - \lambda'C) + \lambda'C$
 - $\lambda_2 = K \times (\lambda_2 - \lambda'C) + \lambda'C$
 - When “MODE FIT” is OFF
 - $\lambda'C = (\lambda'_2 + \lambda'_1)/2$
 - $\lambda'_1 = K \times (\lambda'_1 - \lambda'C) + \lambda'C$
 - $\lambda'_2 = K \times (\lambda'_2 - \lambda'C) + \lambda'C$
 - Obtain spectrum widths from the following equations.
 - $\Delta\lambda = \lambda_2 - \lambda_1$ (when “MODE FIT” is ON)
 - $\Delta\lambda = \lambda'_2 - \lambda'_1$ (when “MODE FIT” is OFF)
 - Obtain center frequencies λC from the following equations
 - $\lambda C = (\lambda_2 + \lambda_1)/2$ (when “MODE FIT” is ON)
 - $\lambda C = (\lambda'_2 + \lambda'_1)/2$ (when “MODE FIT” is OFF)
- MODE displayed in the data area shall be the number of mode peaks between λ_1 and λ_2 .

ENVELOPE Method

This method is used in conjunction with a straight line (envelope) connecting mode peaks to obtain the spectrum widths of the two points, which are lower than the peaks by a configured threshold value (THRESH [dB]), as well as their center wavelengths. The following table shows the details of parameters for the ENVELOPE method.

Parameter	Abbreviation	Default Value	Setting Range	Unit	Description
THRESH 1	TH1	3.00	0.01 to 50.00	dB	Threshold value
THRESH 2	TH2	13.00	0.01 to 50.00	dB	Lower limit value when the number of modes is calculated
K	K	1.00	1.00 to 10.00	-	Multiplying factor

Algorithms differ depending on the number of valid mode peaks. Valid mode peaks mean the mode peaks, among the mode peaks obtained from a mode search, whose level (LOG) is equal to or greater than the line that is below the peak level by the lower limit (THRESH2). Algorithms for these numbers of valid modes are described below.

In the case of one valid mode peak.

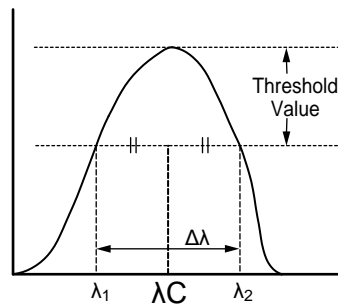

- Perform a mode search to obtain the mode peak.
- Set the wavelengths, which cross the line below the mode peak by the threshold value (THRESH[dB]), to λ_1 and λ_2 .
- Use the following equations, which incorporate multiplication by the multiplying factor K for λ_1 and λ_2 , to obtain new λ_1 and λ_2 .

$$\lambda'C = (\lambda_2 + \lambda_1)/2$$

$$\lambda_1 = K \times (\lambda_1 - \lambda'C) + \lambda'C$$

$$\lambda_2 = K \times (\lambda_1 - \lambda'C) + \lambda'C$$

- Obtain the spectrum width from the following equation.
- Obtain the center wavelength λC from the following equation.

$$\Delta\lambda = \lambda_2 - \lambda_1$$

$$\lambda C = (\lambda_2 + \lambda_1)/2$$

In the case of two valid mode peaks.

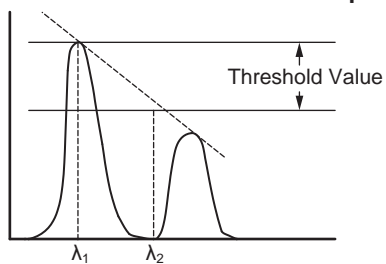

- Set the levels (LOG) of the two valid mode peaks to LG1 and LG2 in order from the left.
- Obtain λ_1 and λ_2 in the following manner.
 - In the case of $|LG2-LG1|$ is threshold value (THRESH1[dB]) or less.
 λ becomes λ_1 and λ_2 from the left in order.
 - In the case of $|LG2-LG1|$ is larger than threshold value (THRESH1[dB])
 Connect two valid mode peaks with a straight line (envelope).
 In the case of $LG1 > LG2$, set the wavelength for the left mode peak to λ_1 . Set the wavelength of the point, where the line below the peak level by the threshold value (THRESH[dB]) and the straight line (envelope) cross, to λ_2 .
 In the case of $LG1 < LG2$, set the wavelength for the right mode peak to λ_2 . Set the wavelength of the point, where the line below the peak level by the threshold value (THRESH[dB]) and the straight line (envelope) cross, to λ_1 .
- Use the following equations, which incorporate multiplication by the multiplying factor K for λ_1 and λ_2 , to obtain new λ_1 and λ_2 .

$$\lambda'C = (\lambda_2 + \lambda_1)/2$$

$$\lambda_1 = K \times (\lambda_1 - \lambda'C) + \lambda'C$$

$$\lambda_2 = K \times (\lambda_2 - \lambda'C) + \lambda'C$$
- Obtain the spectrum width from the following equation.

$$\Delta\lambda = \lambda_2 - \lambda_1$$
- Obtain the center wavelength λ_C from the following equation

$$\lambda_C = (\lambda_2 + \lambda_1)/2$$

In the case of three or more valid mode peaks.

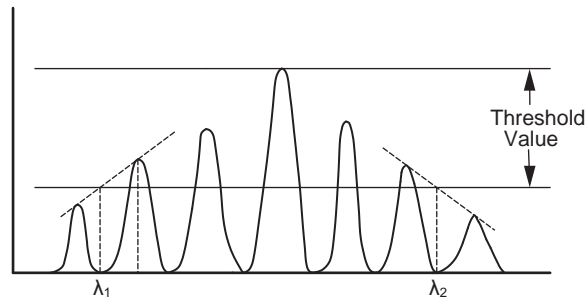

- Set the levels (LOG) of three or more valid mode peaks to LG1, LG2 ••• LGn in order from the left. Set the level of the mode peak at the highest level to LGp.
- Obtain λ_1 in the following manner:
 - In the case of $|LGp-LG1|$ is threshold value (THRESH1[dB]) or less
Set the wavelength of the LG1 mode peak to λ_1 .
 - In the case of $|LGp-LG1|$ is larger than threshold value (THRESH1[dB])
 - i Obtain the leftmost mode peak with $|LGp-THRESH1|$ or more.
 - ii Use a straight line to connect the mode peak obtained in (i) with the mode peak on the left of (i) and also at the highest level.
 - iii Set the point, where the line of $|LGp-THRESH1|$ and the straight line (envelope) cross, to λ_1 .
- Obtain λ_2 in the following manner:
 - In the case of $|LGp-LGn|$ is threshold value (THRESH1[dB]) or less.
Set the wavelength of the LG1 mode peak to λ_2 .
 - In the case of $|LGp-LGn|$ is larger than threshold value (THRESH1[dB])
 - i Obtain the rightmost mode peak with $|LGp-THRESH1|$ or more.
 - ii Use a straight line to connect the mode peak obtained in (i) with the mode peak on the right of (i) and also at the highest level.
 - iii Set the point, where the line of $|LGp-THRESH1|$ and the straight line (envelope) cross, to λ_2 .
- Use the following equations, which incorporate multiplication by the multiplying factor K for λ_1 and λ_2 , to obtain new λ_1 and λ_2 .

$$\lambda'C = (\lambda_2 + \lambda_1)/2$$

$$\lambda_1 = K \times (\lambda_1 - \lambda'C) + \lambda'C$$

$$\lambda_2 = K \times (\lambda_2 - \lambda'C) + \lambda'C$$
- Obtain the spectrum width from the following equation.

$$\Delta\lambda = \lambda_2 - \lambda_1$$
- Obtain the center wavelength λC from the following equation.

$$\lambda C = (\lambda_2 + \lambda_1)/2$$

RMS Method

Use the RMS method to obtain the spectrum width and its center wavelength. Following table shows the details of parameters for the RMS method.

Parameter	Abbreviation	Default Value	Setting Range	Unit	Description
THRESH	TH	20.00	0.01 to 50.00	dB	Threshold value
K	K	2.00	1.00 to 10.00	-	Multiplying factor

Algorithms for the analysis are described below.

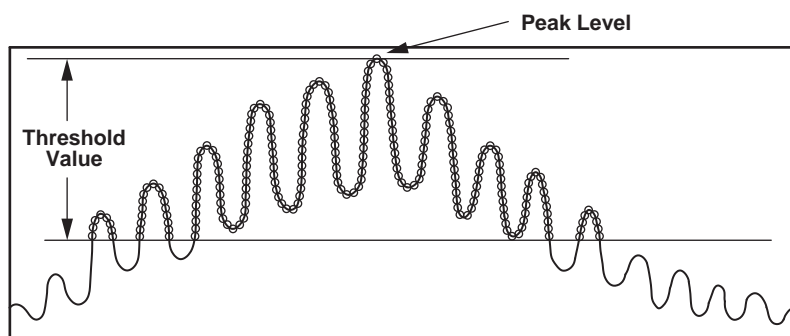

- Take out the data points exceeding the threshold value TH, within the displayed waveform, and find the spectrum width by the following calculation.
- When the wavelength at each point is λ_i and the level at the point is P_i , the mean wavelength λ_c can be found by the following expression.

$$\lambda_c = \frac{\sum P_i \times \lambda_i}{\sum P_i}$$

- By using the mean wavelength λ_c , find the spectrum width $\Delta\lambda$ by the following expression.

$$\Delta\lambda = K \times \sqrt{\frac{\sum P_i \times (\lambda_i - \lambda_c)^2}{\sum P_i}}$$

PEAK RMS Method

Use the PEAK RMS method to obtain the spectrum width and its center wavelength. Following table shows the details of the parameters for the PEAK RMS method.

Parameter	Abbreviation	Default Value	Setting Range	Unit	Description
THRESH	TH	20.00	0.01 to 50.00	dB	Threshold value
K	K	2.00	1.00 to 10.00	-	Multiplying factor

Algorithms for the analysis are described below.

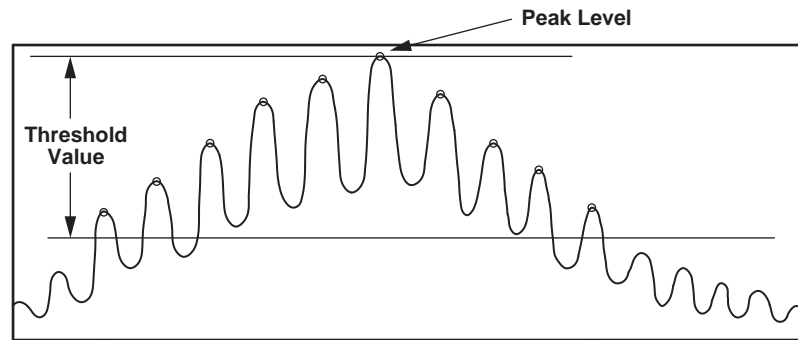

- Take out the data points exceeding the limit value TH, within the displayed waveform, and find the spectrum width by the following calculation. The mode peak count above the TH is shown in the MODE data area.
- When the wavelength at each point is λ_i and the level at the point is P_i , the mean wavelength λ_c can be found by the following expression.

$$\lambda_c = \frac{\sum P_i \times \lambda_i}{\sum P_i}$$

- By using the mean wavelength λ_c obtained in above discription, find the spectrum width $\Delta\lambda$ by the following expression.

$$\Delta\lambda = K \times \sqrt{\frac{\sum P_i \times (\lambda_i - \lambda_c)^2}{\sum P_i}}$$

NOTCH Width Measurement

Obtain a bottom level. Then, obtain the NOTCH width for the bottom level and its center wavelength.

Following table shows the details of parameters for NOTCH analyses.

Parameter	Abbreviation	Default Value	Setting Range	Unit	Description
THRESH	TH	3.00	0.01 to 50.00	dB	Threshold value
K	K	1.00	1.00 to 10.00	-	Multiplying factor
TYPE	TYPE	BOTTOM	BOTTOM / PEAK	-	Reference position for search

Algorithms for analyses are described here. They differ depending on the types of analysis (BOTTOM/PEAK). Algorithms for each type of analysis are described below.

When “TYPE” is BOTTOM

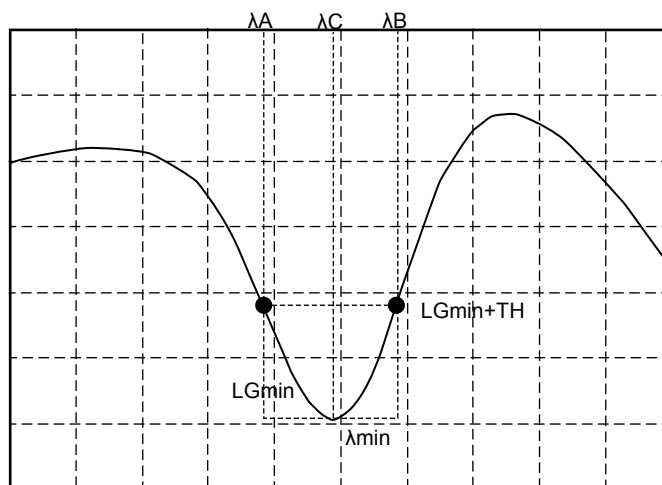

- Obtain the minimum level “LGmin.” Also, set the wavelength of this point to λ_{min} .
- Set the rightmost wavelength, which is located on the left of λ_{min} and which crosses the level (LOG) of $|LGmin + \text{threshold value (THRESH[dB])}|$, to λ_A .
- Set the leftmost wavelength, which is located on the right of λ_{min} and which crosses the level (LOG) of $|LGmin + \text{threshold value (THRESH[dB])}|$, to λ_B .
- Obtain λ_A and λ_B through multiplication by the value which is set to the multiplying factor K.

$$\lambda'C = (\lambda_B + \lambda_A)/2$$

$$\lambda_A = K \times (\lambda_A - \lambda'C) + \lambda'C$$

$$\lambda_B = K \times (\lambda_B - \lambda'C) + \lambda'C$$

- Obtain the NOTCH width from the following equation.

$$\Delta\lambda = \lambda_A - \lambda_B$$

- Obtain the center wavelength λ_C from the following equation.

$$\lambda_C = (\lambda_A + \lambda_B)/2$$

When "TYPE" is PEAK.

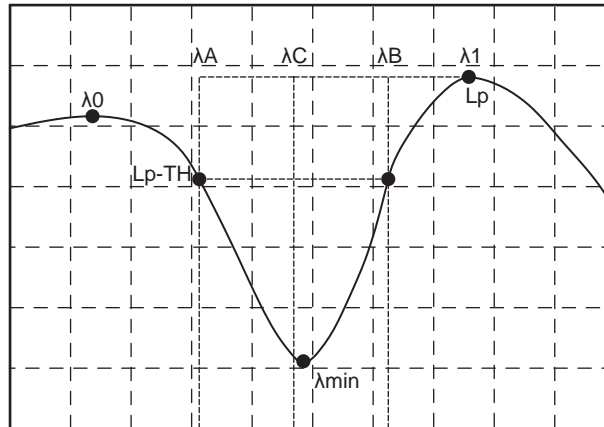

- Obtain the minimum level "LGmin." Also, set the wavelength of this point to λ_{min} .
- Obtain LG0 at the peak level (LOG) on the left of LGmin. Also, set the wavelength of this point to λ_0 .
- Obtain LG1 at the peak level (LOG) on the right of LGmin. Also, set the wavelength of this point to λ_1 .
- Of LG0 and LG1, set whichever is greater to L_p .
- Between λ_0 and λ_1 , set the leftmost wavelength crossing the level (LOG) of $|L_p - \text{threshold value (THRESH[dB])}|$ to λ_A .
- Between λ_0 and λ_1 , set the rightmost wavelength crossing the level (LOG) of $|L_p - \text{threshold value (THRESH[dB])}|$ to λ_B .
- Obtain λ_A and λ_B through multiplication by the value which is set to the multiplying factor K.

$$\lambda'C = (\lambda_B + \lambda_A)/2$$

$$\lambda_A = K \times (\lambda_A - \lambda'C) + \lambda'C$$

$$\lambda_B = K \times (\lambda_B - \lambda'C) + \lambda'C$$

- Obtain the NOTCH width from the following equation.

$$\Delta\lambda = \lambda_A - \lambda_B$$

- Obtain the center wavelength λ_C from the following equation.

$$\lambda_C = (\lambda_A + \lambda_B)/2$$

Appendix 3 Details of Each Analytical Functions

This section describes the algorithms for analyses using the ANALYSIS 1 soft key in the ANALYSIS. ANALYSIS 1 provides such functions as collective analysis of various light sources, POWER analysis, SMSR analysis, and PMD analysis.

SMSR Analysis Function

Use the optical spectrum after the measurement of DFB-LD to analyze the SMSR (Side Mode Suppression Ratio) of DFB-LD.

Following table shows the details of parameters for NOTCH analyses.

Parameter	Abbreviation	Default Value	Setting Range	Unit	Description
SMSR MODE	MODE	SMSR1	SMSR1/SMSR2/ SMSR3/SMSR4	-	Execution mode during SMSR measurement
SMSR MASK	MASK	±0.00	0.00 to 99.99	nm	Setting of near-peak mask range during SMSR1 or SMSR3 measurement

Algorithms for analyses are described here. They differ depending on the SMSR modes. Algorithms for each mode of analysis are described below.

SMSR1

The next highest mode peak after excluding the highest mode peak level and the mask setting range is defined as the side mode.

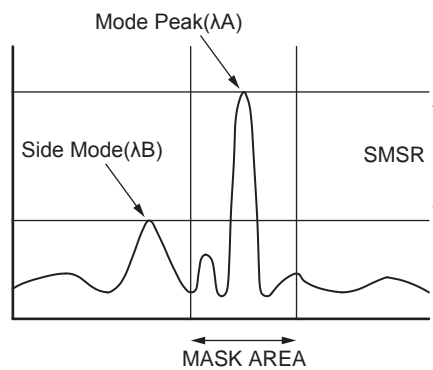

Algorithms of analysis for the SMSR1 mode are as follows:

- Perform a mode search to obtain the mode peak.
- Of the obtained mode peaks, set the point of the mode peak at the highest level (LOG) to PA. Also, set the wavelength value of this point to λA.
- Except for the mode peaks within the range of $PA \pm 1000 \times (\text{SMSR MASK})/\text{SPAN}$, set the wavelength of the highest mode peak, which is next to PA, to λB. If a relevant point does not exist, set the wavelength value at the highest level outside the range of $PA \pm 1000 \times (\text{SMSR MASK})/\text{SPAN}$ to λB. If there is more than one λB, set the leftmost wavelength value to λB. Also, set the levels (linear values) for each point of λA and λB to LA and LB.
- Obtain SMSR and Δλ from the following equations.

$$\text{SMSR} = LA / LB$$

$$\Delta\lambda = \lambda B - \lambda A$$

SMSR2

Of the highest mode peak level and the mode peaks on either side, whichever is higher is defined as the side mode.

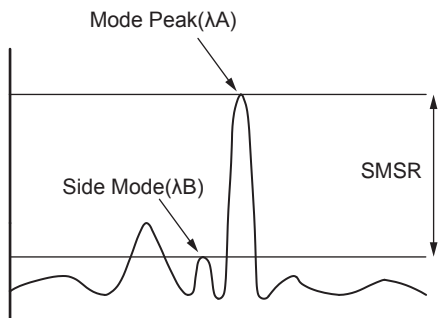

Algorithms of analysis for the SMSR1 mode are as follows.

- Perform a mode search to obtain the mode peak.
- Of the obtained mode peaks, set the wavelength value of the mode peak at the highest level (LOG) to λ_A .
- Of the mode peaks on either side of λ_A , set the wavelength value at the higher level to λ_B . If there is no mode peak other than λ_A , $\lambda_B = \lambda_A$ shall be applicable.
- Also, set the levels (linear values) for each point of λ_A and λ_B to L_A and L_B .
- Obtain SMSR and $\Delta\lambda$ from the following equations.

$$SMSR = L_A / L_B$$

$$\Delta\lambda = \lambda_B - \lambda_A$$

SMSR3

The main mode is defined as the highest mode peak. The side modes are defined as the highest mode peaks outside of the mask area—one on the left side and one on the right side of the mask area.

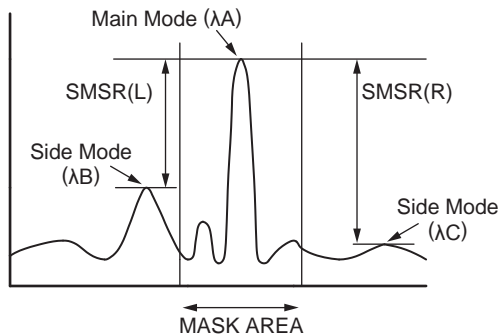

The analysis algorithm for the SMSR3 mode is as follows:

1. A mode search is performed to obtain the mode peaks.
2. The main mode point is set to P_A . The wavelength of this point is set to λ_A .
3. The wavelength of the side mode that has a wavelength shorter than P_A is set to λ_B .
The wavelength of the side mode that has a wavelength longer than P_A is set to λ_C .
If relevant points do not exist, for the levels outside the mask area, the wavelength at the highest level whose wavelength is shorter than P_A is set to λ_B and the wavelength at the highest level whose wavelength is longer than P_A is set to λ_C .
4. The levels (linear values) of λ_A , λ_B , and λ_C are set to L_A , L_B , and L_C , respectively.
5. The SMSR and $\Delta\lambda$ are obtained from the following equations.

$$SMSR(L) = L_A / L_B$$

$$SMSR(R) = L_A / L_C$$

$$\Delta\lambda(L) = \lambda_B - \lambda_A$$

$$\Delta\lambda(R) = \lambda_C - \lambda_A$$

SMSR4

The main mode is defined as the highest mode peak. The side modes are defined as the mode peaks adjacent to the main mode.

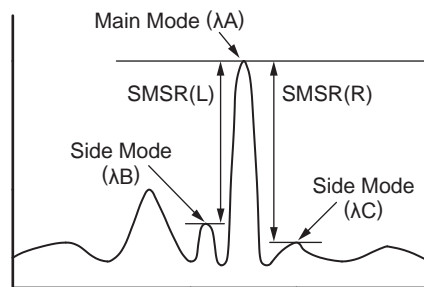

The analysis algorithm for the SMSR4 mode is as follows:

1. A mode search is performed to obtain the mode peaks.
2. The main mode point is set to PA. The wavelength of this point is set to λ_A .
3. The wavelength of the side mode that has a wavelength shorter than PA is set to λ_B .
The wavelength of the side mode that has a wavelength longer than PA is set to λ_C .
If there is no mode peak whose wavelength is shorter than PA, λ_B is set to λ_A . If there is no mode peak whose wavelength is longer than PA, λ_C is set to λ_A .
4. The levels (linear values) of λ_A , λ_B , and λ_C are set to LA, LB, and LC, respectively.
5. The SMSR and $\Delta\lambda$ are obtained from the following equations.

$$\text{SMSR(L)} = \text{LA} / \text{LB}$$

$$\text{SMSR(R)} = \text{LA} / \text{LC}$$

$$\Delta\lambda(\text{L}) = \lambda_B - \lambda_A$$

$$\Delta\lambda(\text{R}) = \lambda_C - \lambda_A$$

POWER Analysis Function

This function allows the user to add up level values of measured waveforms, thereby enabling the calculation of total power. It would be more convenient if the between line markers search function and the zoom area search function were also used for the POWER analysis.

Following table shows the details of the parameters for POWER analysis.

Parameter	Abbreviation	Default Value	Setting Range	Unit	Description
POWER OFFSET	OFST	0.00	-10.00 to 10.00	dB	Compensation value in power measurement

Algorithms for the analysis are as follows.

- Obtain actual wavelength resolutions for all display points. (Use the table to interpolate the values for $\lambda_x = \lambda_{SHIFT} + \lambda_{OFST}$.)

While in the vacuum wavelength mode (**MEAS WL AIR/VACUUM** soft key in the **SET UP**), use the following equation to obtain λ_x .

$$\lambda_0 = \lambda + \lambda_{SHIFT}$$

$$\lambda_x = \lambda_0 / N(\lambda_0) + \lambda_{OFST}$$

If the display mode on the **X** axis (**HORIZON SCALE nm/THz** soft key in the **SET UP**) is the frequency display mode, use the equation below to convert an actual resolution (frequency) R_i for all display points to a wavelength value.

$$R_i = (\lambda_i \times \lambda_i \times R_{fi}) / C$$

λ_i : Wavelength (nm) at each point

R_{fi} : Actual resolution(THz)

C : Speed of light in the vacuum(2.99792458×10^8 [m/s])

- Set the actual resolution for the i th point to R_i , while setting the level to L_i .
- Obtain the total power in the equation below.

$$POWER = \frac{SPAN}{SAMPLE - 1} \times \sum \frac{L_i}{R_i} \times POWEROFFSET$$

PMD Analysis Function

Measured waveforms are used to analyze PMD values.

Following table shows the details of the parameter for PMD analysis.

Parameter	Abbreviation	Default Value	Setting Range	Unit	Description
THRESH	TH	10.00	0.01 to 50.00	dB	Threshold value

Algorithms of the analysis are as follows.

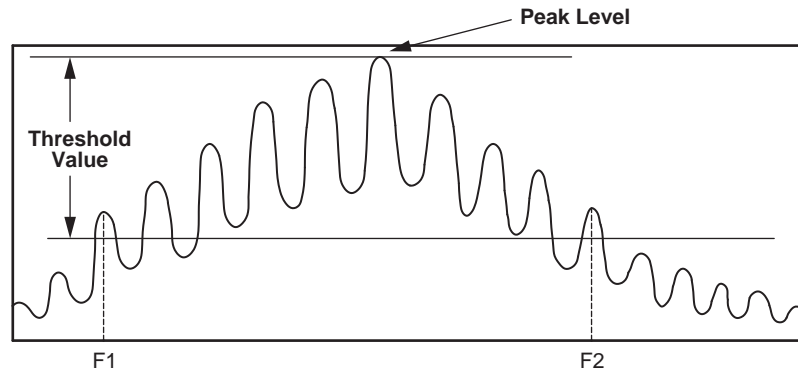

- Perform a mode search to obtain mode peaks.
- Of these mode peaks, set the ones whose level (LOG) is equal to or greater than the line that is below the peak level by the lower limit (THRESH), to the valid mode peaks.
- Set the frequency of the leftmost valid mode peak to F1(THz).
- Set the frequency of the rightmost valid mode peak to F2(THz).
- Set the number of mode peaks between F1 and F2 to N.
- Obtain the PMD value from the following equation.

$$PMD = (N-1) / (F2-F1)$$

DFB-LD Analysis Function

The following parameters for DFB-LD light sources are analyzed collectively.

- -XdB WIDTH
- SMSR
- RMS
- POWER
- OSNR

Following table shows the details of parameters for DFB-LD analysis.

Parameter	Abbreviation	Default Value	Setting Range	Unit	Description
-XdB WIDTH (Center WL/ SPWD)	ALGO	THRESH	ENVELOPE/ THRESH/RMS/ PK-RMS	-	
	THRESH	20.00	0.01 to 50.00	dB	
	THRESH2	20.00	0.01 to 50.00	dB	Valid only when ALGO is ENVELOPE.
	K	1.00	1.00 to 10.00	-	
	MODE FIT	OFF	ON / OFF	-	Valid only when ALGO is THRESH.
	MODE DIFF	3.00	0.01 to 50.00	dB	Invalid when ALGO is RMS.
SMSR	SMSR MODE	SMSR1	SMSR1/SMSR2/ SMSR3/SMSR4	-	
	SMSR MASK	±0.00	0.00 to 99.99	nm	
	MODE DIFF	3.00	0.01 to 50.00	dB	
RMS	ALGO	RMS	RMS/PK-RMS	-	-
	THRESH	20.00	0.01 to 50.00	dB	-
	K	2.00	0.01 to 10.00	-	-
	MODE DIFF	3.00	0.01 to 50.00	dB	Invalid when ALGO is RMS.
POWER	SPAN	0.40	0.01 to 10.00	nm	-
OSNR	MODE DIFF	3.00	0.01 to 50.00	dB	-
	NOISE ALGO	PIT	AUTO-FIX/ MANUAL-FIX/ AUTO-CTR/ MANUAL-CTR/ PIT	-	-
	NOISE AREA	AUTO	AUTO/ 0.01 to 10.00	nm	-
	MASK AREA	-	-/ 0.01 to 10.00	nm	-
	FITTING ALGO	LINEAR	LINEAR/GAUSS/ LORENZ/3RD POLY/4TH POLY/5TH POLY	-	-
	NOISE BW	0.10	0.01 to 1.00	nm	-
	SIGNAL POWER	PEAK	PEAK/INTEGRAL	-	-
	INTEGRAL RANGE	10	10 to 999	GHz	-

Concerning the algorithms for DFB-LD analysis, refer to data calculation algorithms for spectrum widths and SMSR analysis algorithms.

FP-LD Analysis Function

The following parameters for FP-LD light sources are analyzed collectively

- SPECTRUM WIDTH
- MEAN WAVELENGTH
- TOTAL POWER
- MODE NO.

Following table shows the details of parameters for FP-LD analysis.

Parameter	Abbreviation	Default Value	Setting Range	Unit	Description
SPECTRUM WIDTH	ALGO	PK-RMS	ENVELOPE / THRESH / RMS / PK-RMS	-	
	THRESH	20	0.01 to 50.00	dB	
	THRESH2	20	0.01 to 50.00	dB	Valid only when ALGO is ENVELOPE.
	K	2	1.00 to 10.00	-	
	MODE FIT	OFF	ON / OFF	-	Valid only when ALGO is THRESH.
	MODE DIFF	3	0.01 to 50.00	dB	
MEAN WAVELENGTH	ALGO	PK-RMS	ENVELOPE / THRESH / RMS / PK-RMS	-	
	THRESH	20	0.01 to 50.00	dB	
	THRESH2	20	0.01 to 50.00	dB	Valid only when ALGO is ENVELOPE.
	K	2	1.00 to 10.00	-	
	MODE FIT	OFF	ON / OFF	-	Valid only when ALGO is THRESH.
	MODE DIFF	3	0.01 to 50.00	dB	
TOTAL POWER	OFFSET LEVEL	0	-10.00 to 10.00	dB	
MODE NO.	ALGO	PK-RMS	ENVELOPE / THRESH / RMS / PK-RMS	-	
	THRESH	20.00	0.01 to 50.00	dB	
	THRESH2	20.00	0.01 to 50.00	dB	Valid only when ALGO is ENVELOPE.
	K	2.00	1.00 to 10.00	-	
	MODE FIT	OFF	ON / OFF	-	Valid only when ALGO is THRESH.
	MODE DIFF	3.00	0.01 to 50.00	dB	

Concerning the algorithms for FP-LD analysis, refer to data calculation algorithms for spectrum widths and power analysis algorithms.

LED Analysis Function

The following parameters for LED light sources are analyzed collectively.

- SPECTRUM WIDTH
- MEAN WAVELENGTH
- TOTAL POWER

Following table shows the details of parameters for LED analysis.

Parameter	Abbreviation	Default Value	Setting Range	Unit	Description
SPECTRUM WIDTH	ALGO	THRESH	ENVELOPE / THRESH / RMS / PK-RMS	-	
	THRESH	3	0.01 to 50.00	dB	
	THRESH2	20	0.01 to 50.00	dB	Valid only when ALGO is ENVELOPE.
	K	1	1.00 to 10.00	-	
	MODE FIT	OFF	ON / OFF	-	Valid only when ALGO is THRESH.
MEAN WAVELENGTH	ALGO	RMS	ENVELOPE / THRESH / RMS / PK-RMS	-	
	THRESH	20	0.01 to 50.00	dB	
	THRESH2	20	0.01 to 50.00	dB	Valid only when ALGO is ENVELOPE.
	K	2	1.00 to 10.00	-	
	MODE FIT	OFF	ON / OFF	-	Valid only when ALGO is THRESH.
TOTAL POWER	OFFSET LEVEL	0	-10.00 to 10.00	dB	

Concerning the algorithms for LED analysis, refer to data calculation algorithms for spectrum widths and power analysis algorithms.

Appendix 4 Detailed Explanations of WDM Analysis Function

This function provides the analyses of NOISE level and SNR in each mode within the measurement range of WDM waveforms.

Items for analysis

NO.:	Channel No. i
WAVELENGTH:	Center wavelength λ_i of the channel
LEVEL:	Level (peak level – noise level) L_i of the channel
OFFSET WL:	Relative wavelength to the wavelength of the reference channel (REF)
OFFSET LVL:	Relative level to the level of the reference channel (REF)
SPACING:	Wavelength spacing to the adjacent channel
LVL DIFF:	Level difference from then adjacent channel
NOISE:	Noise level LN_i of the channel
SNR:	SNR value SN_i of the channel
GRID WL:	Nearest GRID wavelength to the channel
MEAS WL:	Center wavelength λ_i of the channel
REL WL:	Relative wavelength to the nearest GRID wavelength of the channel

Note

Indications of dBm/nm and dBm/THz are forcibly changed to dBm indications before execution.

List of Parameters

Related to Channel Detection

Parameter	Default	Setting Range	Unit	Description
THRESH	20.0	0.1 to 99.9	dB	Threshold value for channel detection.
MODE DIFF	3.0	0.0 to 50.0	dB	Minimum value for peak/bottom difference during channel detection.
DISPLAY MASK	OFF	OFF, -100.0 to 0.0	dBm	Levels equal to or below this level are not detected as WDM channels.

Appendix 4 Detailed Explanations of WDM Analysis Function

Related to SNR Analysis

Parameter	Default	Setting Range	Unit	Description
NOISE ALGO	AUTO-FIX	AUTO-FIX MANUAL-FIX AUTO-CTR MANUAL-CTR PIT	-	Selection of algorithms for noise level measurement.
NOISE AREA	0.40nm	0.01 to 10.00nm	nm	A range of waveform data for use in noise level analysis is specified as a range centering on channel wavelengths. When N_ALGO is: <ul style="list-style-type: none"> • AUTO-FIX "AUTO" • MANUAL-FIX ** ** • AUTO-CTR "Between Ch" • MANUAL-CTR "Between Ch" • PIT "-"
MASK AREA	0.20nm	0.01 to 10.00nm	nm	Specify the signal optical spectrum range to be masked within the waveform data, while using the channel wavelength as its center. When N_ALGO is: <ul style="list-style-type: none"> • AUTO-FIX "-" • MANUAL-FIX When F_ALGO is LINEAR: "-" Other cases: input of parameter values <ul style="list-style-type: none"> • AUTOL-CTR "-" • MANUAL-CTR When F_ALGO is LINEAR: "-" Other cases: input of parameter values Limiter is applied during input to ensure NOISE AREA is MASK AREA or more. <ul style="list-style-type: none"> • PIT "-"
FITTING ALGO	LINEAR	LINEAR GAUSS LORENZ 3RD POLY 4TH POLY 5TH POLY	-	Selection of a fitting algorithm for obtaining noise levels.
NOISE BW	0.10nm	0.01 to 1.00nm	nm	Setting of noise bandwidth.
DUAL TRACE	OFF	ON/OFF	-	OFF: Active trace is handled as the target for analysis. ON: Wavelengths and levels are calculated from TRACE A. Noise levels are calculated from TRACE B.

Related to display

Parameter	Default	Setting Range	Unit	Description
DISPLAY TYPE	ABSOLUTE	ABSOLUTE RELATIVE DRIFT(MEAS) DRIFT(GRID)	-	Setting of the format to display wavelengths, levels, noises, and SNRs, which are the results of analyses. ABSOLUTE: display of absolute values RELATIVE: display of relative values compared to GRID. DRIFT(MEAS): display of drift values by using wavelengths measured previously as references. DRIFT(GRID): display of drift values by using the grid wavelengths as references.
CH RELATION	OFFSET	OFFSET SPACING	-	Setting of the format to display wavelengths between channels and level relative values during DISPLAY: ABSOLUTE. This parameter is valid only when DISPLAY is set to ABSOLUTE. OFFSET: Display of offset values by using one arbitrary channel as the reference. SPACING: Display of offset values compared to an adjacent channel
REF CH	HIGHEST	HIGHEST ****	-	Setting of the reference channel when CH RELATION is set to OFFSET. This parameter is valid only when DISPLAY is set to ABSOLUTE and also when CH RELATION is set to OFFSET. HIGHEST: A channel at the highest level is used as the reference. ****: A ****th channel is used as the reference.
MAX/MIN RESET	-	-	-	If pressed, MAX/MIN is RESET. Button valid only when DISPLAY is set to DRIFT
OUTPUT SLOPE	OFF	ON/OFF	-	ON/OFF of the function to obtain the least square approximation line of the channel peak.
POINT DISPLAY	ON	ON/OFF	-	ON/OFF of the function to display the data range used for fitting into the waveform window.

Algorithm for Analysis

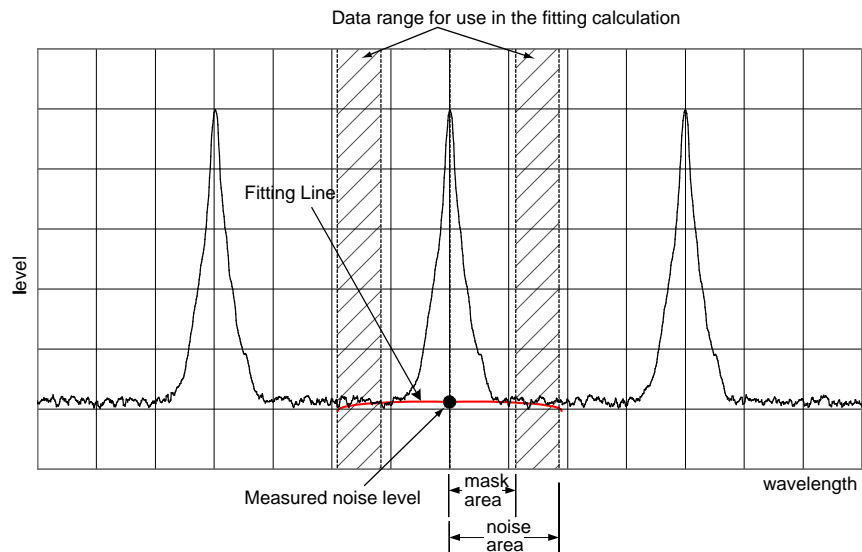

1. Apply channel detection to measured waveform data using the following procedure:
 - Find all maximum points and minimum points to obtain mode peaks where peak/bottom differences between maximum points and minimum points on both sides are equal to or greater than MODE DIFF.
 - Of the obtained mode peaks, choose only the ones whose level difference compared to the highest peak is equal to or greater than THRESH. Note, however, that mode peaks with a level difference equal to or less than DISPLAY MASK shall be excluded. The number of mode peaks chosen in this manner shall be the Number of Channels "N."
2. Obtain the wavelength λ_i of each mode peak.
3. Determine the center wavelengths λ_i of each mode peak, which are 2 points down $A[\text{dB}]$ to the left and right from mode peak λ_i (where $A[\text{dB}]$ is 3 dB or the MODE DIFF setting, whichever is smaller).
4. Determine the signal level LS_i of each mode according to the parameter SIGNAL POWER setting.
 - For "PEAK"
 $LS_i = \text{Level } LP_i \text{ of each mode peak}$
 - For "INTEGRAL"
 $LS_i = \text{The integral of the power value in the range of the center wavelength } \pm \Delta f [\text{GHz}] \text{ of each mode}$
 $(\Delta f : \text{parameter INTEGRAL RANGE setting value})$
5. Follow the setting of the parameter NOISE ALGO to determine the noise area and mask area for performing the NOISE fitting.
 (If the mask area is set outside the noise area when the channel wavelength λ_i is the center, the mask area and the noise area will become the same value.)
6. Obtain the measurement resolution RB_i of each channel from the values stored in the AQ6375B.
7. According to the setting of the parameter FITTING ALGO, generate fitting waveforms from the noise area and mask area determined in 5 and obtain the level at the center wavelength λ_i as the noise level LN_i .
8. Using the signal level LS_i and noise level LN_i obtained in 4 and 7, determine the level Li of each channel using the following equation.
 $Li = LS_i(\text{linear}) ? LN_i(\text{linear})$

9. Obtain the normalized noise level LNNi from the equation below.

$$LNNi = [LNi(\text{LOG}) - 10 \times \text{Log}(RBi[nm])] + 10 \times \text{Log}(NBW)$$
 NBW =noise bandwidth (configurable parameter)
10. Use the mode peak level Li obtained in 8 and 9 and the normalized noise level LNNi to obtain SNi from the following equation.

$$SNi = Li - LNNi$$
11. Display the results of foregoing analyses according to the settings of the parameter DISPLAY SETTING.

Automatic Parameter Setting Function

This unit provides the noise area/mask area automatic setting function. To activate the automatic setting, set the algorithm to AUTO-FIX or AUTO-CTR.

AUTO-FIX

Noise Algorithm

Obtain the left and right noise areas (NA_Ri, NA_Li) of each channel according to the number of detected WDM channels as follows:

When the number of WDM channels “n” is 1

Internally obtain the measurement resolution of SNi calculation trace and the value of the noise measurement point NOISE AREA in accordance with the resolution, and then obtain the values from the following equations.

$$NA_Ri = \lambda_i + \text{NOISE AREA}$$

$$NA_Li = \lambda_i - \text{NOISE AREA}$$

When the number of WDM channels “n” is 2 or more

Obtain the channel spacing of each channel (spacing of λ_i .) With the minimum spacing set to SPACING as well as NOISE AREA = SPACING / 2, obtain the NOISE AREA. Finally, obtain the values from the following equations.

$$NA_Ri = \lambda_i + \text{NOISE AREA} \quad (i = 1, 2, \dots, n)$$

$$NA_Li = \lambda_i - \text{NOISE AREA} \quad (i = 1, 2, \dots, n)$$

Fitting Algorithm

While the setting is at AUTO-FIX, LINEAR is used for the fitting algorithm, which is calculated as follows.

- Obtain ELi and ERi as the level (LOG) of each position of the noise areas NA_Li and NA_Ri.
- Use the data of the straight line connecting the two points of ELi and ERi to fill the inside of the fitting range.
- Set the level of λ_i of the data generated in the fitting to the noise level LNi.

Note

Due to being set to LINEAR, it is not possible to set the mask areas.

AUTO-CTR

Noise Algorithm

Obtain the left and right noise areas (NA_Ri, NA_Li) of each channel according to the number of detected WDM channels as follows (while treating the center points between channels as NA_Ri and NA_Li).

When the number of WDM channels “n” is 1

Internally obtain the measurement resolution of SNi calculation trace and the value of the noise measurement point NOISE AREA in accordance with the resolution, and then obtain the values from the following equations.

$$NA_Ri = \lambda_i + \text{NOISE AREA}$$

$$NA_Li = \lambda_i - \text{NOISE AREA}$$

When the number of WDM channels “n” is 2 or more

$$\lambda N1 = (3\lambda_1 - \lambda_2)/2$$
$$i=2,3,\dots,n$$
$$\lambda Ni = (\lambda_i - \lambda_{i-1})/2$$
$$\lambda Nn+1 = (3\lambda_n - \lambda_{n-1})/2$$

If the above values are calculated, the following results will be generated.

$$i=1,2,\dots,n$$
$$NA_Li = \lambda Ni$$
$$NA_Ri = \lambda Ni+1$$

Fitting Algorithm

While the setting to AUTO-CTR, LINEAR is used for the fitting algorithm, which is calculated as follow.

- Obtain ELi and ERi as the level (LOG) of each position of the noise areas NA_Li and NA_Ri.
- Use the data of the straight line connecting the two points of ELi and ERi to fill the inside of the fitting range.
- Set the level of λ_i of the data generated in the fitting to the noise level LNi.

Note

Due to being set to LINEAR, it is not possible to set the mask areas.

PIT

Noise Algorithm

Obtain the noise areas for measured waveform to the minimum level position of a before the next channel in each channel.

When inside noise areas obtain at the left and right noise areas of each channel. outside noise areas is applied.

When the number of WDM channels “n” is 1

Internally obtain the measurement resolution of SNi calculation trace and the value of the noise measurement point NOISE AREA in accordance with the resolution, and then obtain the values from the following equations.

$$NA_Ri = \lambda_i + NOISE AREA$$
$$NA_Li = \lambda_i - NOISE AREA$$

When the number of WDM channels “n” is 2 or more

$$i=1$$
$$NA_Li = \lambda_i - (\lambda Ni - \lambda_i)$$
$$NA_Ri = \lambda Ni$$
$$i=2,3,\dots,n-1$$
$$NA_Li = \lambda N(i - 1)$$
$$NA_Ri = \lambda Ni$$
$$i=n$$
$$NA_Li = \lambda N(i - 1)$$
$$NA_Ri = \lambda_i + (\lambda_i - \lambda N(i - 1))$$

Fitting Algorithm

While the setting to PIT, LINEAR is used for the fitting algorithm, which is calculated as follows.

- Obtain ELi and ERi as the level (LOG) of each position of the noise areas NA_Li and NA_Ri.
- Use the data of the straight line connecting the two points of ELi and ERi to fill the inside of the fitting range.
- Set the level of λ_i of the data generated in the fitting to the noise level LNi.

Note

Due to being set to LINEAR, it is not possible to set the mask areas

Setting of the Parameter “DUAL TRACE”

This function enables more precise analyses by measuring waveforms with different measurement resolutions at trace A and trace B and also by performing measurements with resolutions different in noise level from the signal level of each channel.

When “DUAL TRACE” is ON, targets for the analysis of each trace will be:

- TRACE A: trace subject to channel detection
- TRACE A: calculation traces λ_i and Li
- TRACE B: noise level LNi calculation trace

OUTPUT SLOPE Function

The parameter “OUTPUT SLOPE” provides a function to obtain the least square approximation curve of channel peaks. This function makes it possible to measure gain tilts. If “OUTPUT SLOPE” is set to ON, results will be displayed in the waveform display section and in the analysis table.

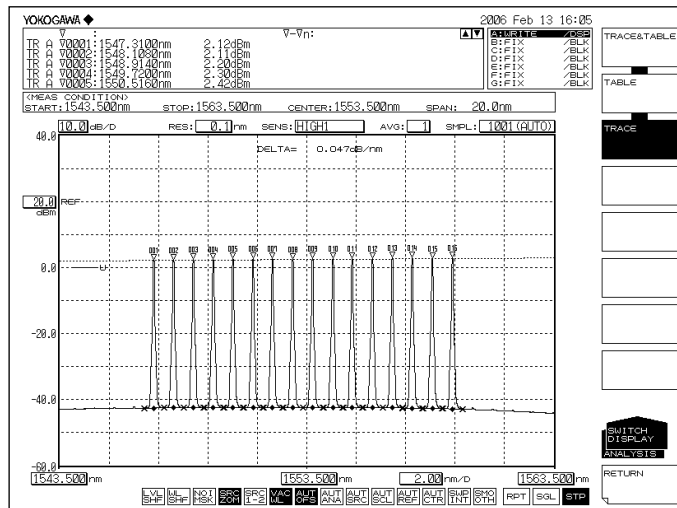

Items to be Displayed When DISPLAY is Set ABSOLUTE

Results of analyses are displayed in absolute values.

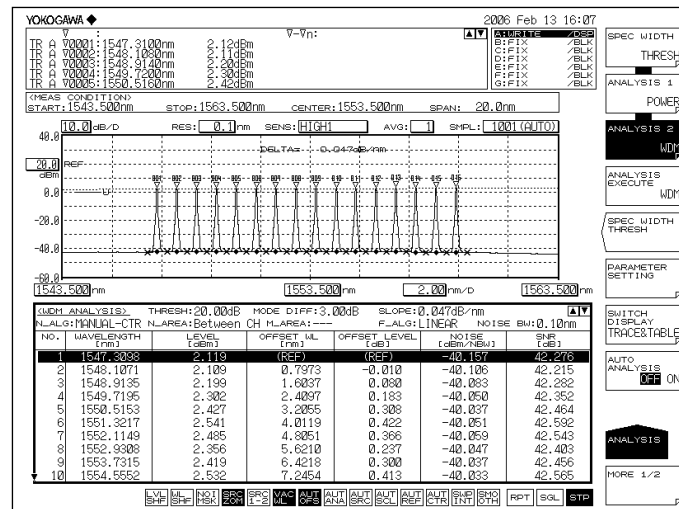

Explanations of display items

- NO: Channel number
- WAVELENGTH: Center wavelength of the channel
- LEVEL: Level of the channel (peak level – noise level)
- OFFSET WL: Relative wavelength to the wavelength of the reference channel (REF)
- OFFSET LVL: Relative level to the wavelength of the reference channel (REF)
- SPACING: Wavelength spacing with the adjacent channel
- LVL DIFF: Level difference from the adjacent channel
- NOISE: Noise level of the channel
- SNR: SNR value of the channel

- OFFSET WL/LVL is displayed when the parameter CH RELATION is "OFFSET."
SPACING and LVL DIFF are displayed when the parameter CH RELATION is "SPACING."
- When ABSOLUTE and CH RELATION are OFFSET, it is possible either to set the reference channel to the mode peak with the highest level or to set a mode peak that will become the reference arbitrarily.
 - When REF CH is HIGHEST
The WDM mode peak with the highest level shall be the reference. The wavelength difference and level difference (LOG) compared to it shall be OFFSET WL and OFFSET LVL of each WDM mode peak.
 - When REF CH is ***
REF CHANNEL*** shall be the reference. The wavelength difference and level difference (LOG) against it shall be OFFSET WL and OFFSET LVL of each WDM mode peak. (If the ***th mode peak does not exist, the WDM mode peak on the longest wavelength shall be the reference.)

RELATIVE

Of the analytical results, wavelength values are displayed as relative values to the values in the grid table.

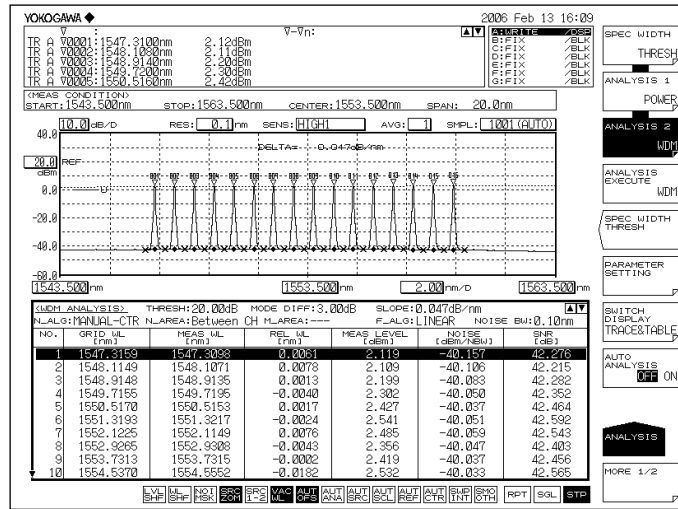

Explanations of display items

- NO: Channel number
- GRID WL: GRID wavelength of the channel
- MEAS WL: Center wavelength of the channel
- REL WL: Relative wavelength to the GRID wavelengths of the channel
- MEAS LVL: Level of the channel (peak level – noise level)
- NOISE: Noise level of the channel
- SNR: SNR value of the channel

DRIFT(MEAS)

Wavelengths measured previously are used as references to display wavelength/level changes (drifts).

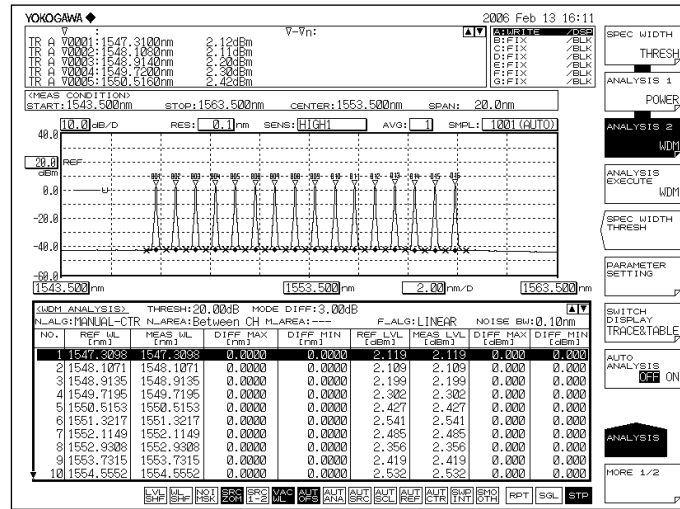

Explanations of display items

- NO: Channel number
- REF WL: Reference wavelength of the channel (previous wavelength measured)
- MEAS WL: Center wavelength of the channel
- DIFF MAX (wavelength): Maximum value of the relative wavelength to the reference wavelength of the channel
- DIFF MIN (wavelength): Minimum value of the relative wavelength to the reference wavelength of the channel
- REF LVL: Reference level of the channel (previous measurement level)
- MEAS WL: Measurement level of the channel
- DIFF MAX (level): Maximum value of the relative level to the reference level of the channel
- DIFF MIN (level): Minimum value of the relative level to the reference level of the channel

Reference wavelength/level can be changed under the following conditions.

- Active trace waveform data when MAX/MIN RESET is set by the parameter.
- The first waveform data measured when wavelength axes (SPAN WL/START WL/ STOP WL) were changed according to the measurement conditions.

DRIFT(GRID)

Grid wavelengths are used as references to display wavelength/level changes (drifts). Note that reference levels are previous measurement levels.

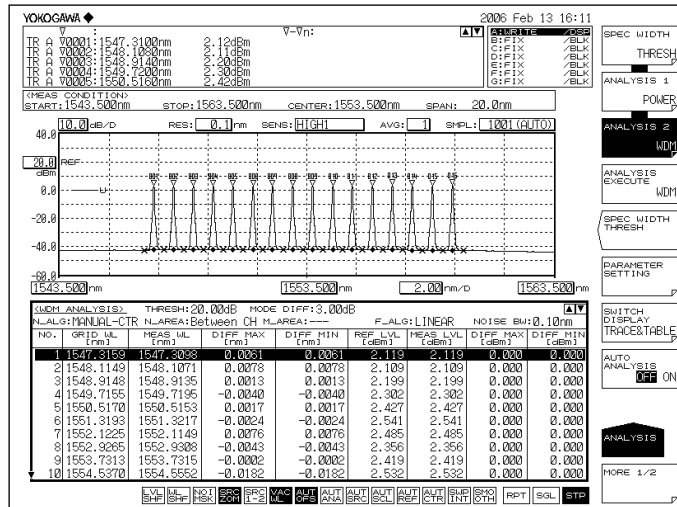

Explanations of display items

- NO: Channel number
- GRID WL: Reference wavelength of the channel (grid wavelength)
- MEAS WL: Center wavelength of the channel
- DIFF MAX (wavelength): Maximum value of the relative wavelength to the reference wavelength of the channel
- DIFF MIN (wavelength): Minimum value of the relative wavelength to the reference wavelength of the channel
- REF LVL: Reference level of the channel (previous measurement level)
- MEAS WL: Measurement level of the channel
- DIFF MAX (level): Maximum value of the relative level to the reference level of the channel
- DIFF MIN (level): Minimum value of the relative level to the reference level of the channel

- Absolute values and reference values to the GRID table are displayed. The GRID table can be freely configured.
- Reference wavelengths/levels can be changed under the following conditions:
 - When MAX/MIN RESET is set by the parameter, reset is performed by the active trace waveform data.
 - Reset is performed by the first waveform data that was measured when wavelength axes (SPAN WL/START WL/STOP WL) were changed by measurement conditions.

Appendix 5 Details of Optical Amplifier Analysis Function

This function enables the analysis of gains and NF (noise figures) of optical fiber amplifiers.

Items to be analyzed

λ_i	Center wavelength of each channel. -> Center frequency during the frequency mode.
LIN _i	Signal optical power of each channel (after OFFSET compensation)
LOUT _i	Output optical power of each channel (after OFFSET compensation)
LASE _i	ASE power of each channel (after OFFSET compensation)
R _{bi}	Measurement resolution of each channel
G _i	Gain of each channel
N _{fi}	NF of each channel

List of parameters

Related to channel detection

Parameter	Default	Setting Range	Unit	Description
THRESH	20.0	0.1 to 99.9	dB	Threshold value for channel detection.
MODE DIFF	3.0	0.0 to 50.0	dB	Minimum value of the peak/bottom difference during channel detection
OFFSET(IN)	0.00	-99.99 to 99.99	dB	Level offset value of signal optical power.
OFFSET(OUT)	0.00	-99.99 to 99.99	dB	Level offset value of output optical power.
ASE ALGO	AUTO-FIX	AUTO-FIX MANUAL-FIX AUTO-CTR MANUAL-CTR	-	Selection of the algorithm for ASE level measurement.
FIT AREA	0.40nm	0.01 to 10.00nm	nm	A range of waveform data for use in ASE level analysis is specified as a range centering on channel wavelengths. When A_ALGO is <ul style="list-style-type: none"> AUTO-FIX: "AUTO" MANUAL-FIX: **.** AUTO-CTR: "Between Ch" MANUAL-CTR: "Between Ch"
MASK AREA	0.20nm	0.01 to 10.00nm	nm	Of the waveform data, specify the signal optical spectrum range for masking, which centers on the channel wavelength. When A_ALGO is <ul style="list-style-type: none"> AUTO-FIX: "-" MANUAL-FIX When F_ALGO is LINEAR: "-" Other cases: input of parameter value. <ul style="list-style-type: none"> AUTO-CTR: "-" MANUAL-CTR When F_ALGO is LINEAR: "-" Other cases: input of parameter value. Apply the limiter during input to ensure FITTING AREA is MASK AREA or more.
FITTING ALGO	LINEAR	LINEAR GAUSS LORENZ 3RD POLY 4TH POLY 5TH POLY	-	Selection of the fitting algorithm for obtaining ASE levels
POINT DISPLAY	ON	ON / OFF	-	ON/OFF for the function to display data range used for fitting in the waveform window.
RES BW	CAL DATA	MEASURED CAL DATA	-	Set the method for calculating the measurement resolution R _{Bi} of each channel. MEASURED: Determine the value of the THRESH 3dB width for each channel from the TRACE B waveform and set to R _{Bi} . CAL DATA: Set the actual resolution value stored in the instrument to R _{Bi} .
SHOT NOISE	ON	ON / OFF	-	Shot Noise component is included in computation of the NF value. ON: Shot Noise component included in computation of the NF value. OFF: Shot Noise component not included in computation of the NF value.

Algorithm for analysis

- 1 Apply the WDM analysis to the signal optical waveform data of TRACE A to perform channel detection. Note, however, that the parameter DISPLAY MASK is not used.
- 2 Obtain the center wavelength λ_i of each channel and signal optical level LIN'i of TRACE A optical signal.
- 3 Obtain the output optical level LOU'T'i of each channel from the output optical waveform data of TRACE B.
- 4 Obtain LINi and LOU'Ti, which are generated by compensating OFFSET(IN,OUT) for signal optical level and output optical level, respectively.
- 5 According to the setting of the parameter ASE ALGO, determine fitting area and mask area for performing the ASE fitting.
- 6 Set the method for calculating the measurement resolution RBi of each channel.
 - MEASURED: Determine the value of the THRESH 3dB width for each channel from the TRACE B waveform and set to RBi.
 - CAL DATA: Set the actual resolution value stored in the instrument to RBi.
- 7 Remove the signal optical SE elements contained in the output optical spectrum in the following order and write the result into TRACE C.
 - Obtain levels (linear) on both sides of the channel of the fitting area that was obtained in 5.
 - Use the obtained levels on both sides to obtain the provisional ASE level LB'i via the linear interpolation.
 - Obtain LBi, which is generated by compensating OFFSET(OUT) for the provisional ASE level LB'i.
 - Obtain the provisional gain G'l using the following equation.

$$G'i=(LOU'Ti - LBi)/LINi$$
 - Multiply the TRACE A data (linear) by the provisional gain G'l and subtract the result from the TRACE B data (linear). Then, write the result into TRACE C.
- 8 In the TRACE C data (linear) generated in 7, perform a fitting according to the settings of the parameter FITTING ALGO and create the estimated ASE spectrum in TRACE C. The data for use in the fitting is from the range of the center wavelength of each channel \pm FIT AREA to the range of MASK AREA. Obtain the level at λ_i in TRACE C as the ASE level LASE'i (linear). Then, obtain LASEi, which is generated by compensating OFFSET (OUT) for it.

Calculate gain G and NF (linear) from the following equations.

Gain G

$$G_i = (LOU'Ti - LASEi)/LINi$$

NF value (during the air wavelength mode)

$$NF_i = \frac{N(\lambda_i)^2}{h \times c^2} \times \frac{\lambda_i^3}{R_{Bi}} \times \frac{LASE_i}{G} + \frac{1}{G} \quad (\text{SHOT NOISE parameter:ON})$$

$$NF_i = \frac{N(\lambda_i)^2}{h \times c^2} \times \frac{\lambda_i^3}{R_{Bi}} \times \frac{LASE_i}{G} \quad (\text{SHOT NOISE parameter:OFF})$$

NF value (during the vacuum wavelength mode)

$$NF_i = \frac{1}{h \times c^2} \times \frac{\lambda_i^3}{R_{Bi}} \times \frac{LASE_i}{G} + \frac{1}{G} \quad (\text{SHOT NOISE parameter:ON})$$

$$NF_i = \frac{1}{h \times c^2} \times \frac{\lambda_i^3}{R_{Bi}} \times \frac{LASE_i}{G} \quad (\text{SHOT NOISE parameter:OFF})$$

$N(\lambda_i)$: Refraction index of the air

C : Speed of light in the vacuum 2.99792458×10^8 [m/s]

h : Planck's constant $6.6260755 \times 10^{-34}$ [J•s]

Perform LOG conversion for Nfi, Gi, and LASEi.

Automatic Parameter Setting Function

The AQ6375B provides a fit area/mask area automatic setting function.

AUTO-FIX

ASE algorithm

The fitting algorithm is LINEAR.

Since the algorithm is LINEAR, the mask area setting will not be required.

Obtain the left and right fit areas (NA_Ri, NA_Li) of each channel by using the number of detected channels as follows.

When the number of channels “n” is 1

Internally obtain the measurement resolution of trace B and the value of the noise measurement point NOISE AREA in accordance with the resolution, and obtain the fit areas from the following equations.

$$NA_Ri = \lambda_i + NOISE\ AREA$$

$$NA_Li = \lambda_i - NOISE\ AREA$$

When the number of channels “n” is 2 or more

Obtain the channel spacing (spacing of λ_i) of each channel. Set the minimum spacing to SPACING and also use the following to obtain the NOISE AREA.

$$NA_Ri = \lambda_i + NOISE\ AREA \quad (i=1,2,\dots,n)$$

$$NA_Li = \lambda_i - NOISE\ AREA \quad (i=1,2,\dots,n)$$

AUTO-CTR

ASE algorithm

The fitting algorithm is LINEAR.

Since the algorithm is LINEAR, the mask area setting will not be required.

Obtain the left and right fit areas (NA_Ri, NA_Li) of each channel by using the number of detected channels as follows (center points between channels are treated as NA_Ri, NA_Li.)

When the number of channels “n” is 1

Internally obtain the measurement resolution of trace B and the value of the noise measurement point NOISE AREA in accordance with the resolution, and obtain the fit areas from the following equations.

$$NA_Ri = \lambda_i + NOISE\ AREA$$

$$NA_Li = \lambda_i - NOISE\ AREA$$

When the number of channels “n” is 2 or more

$$\lambda N1 = (3\lambda_1 - \lambda_2)/2$$

$i=2,3,\dots,n$

$$\lambda Ni = (\lambda_i + \lambda_{i-1})/2$$

$$\lambda Nn+1 = (3\lambda_n - \lambda_{n-1})/2$$

Perform the calculations.

$i=1,2,\dots,n$

$$NA_Li = \lambda Ni$$

$$NA_Ri = \lambda Ni+1$$

Appendix 6 Details of Optical Filter Analysis Function

FILTER PEAK Analysis Function

This function enables the collective analysis of measured waveforms of optical filters via multiple parameters.

It can be used for filter analysis only if the number of modes is one. Items and algorithms for analysis are the same as in the AQ6317 series.

Items for analysis

PEAK LVL:	Peak level
PEAK WL:	Peak wavelength
CENTER WL:	Center wavelength
SPECTRUM WIDTH:	Wavelength width at threshold value TH
RIPPLE WIDTH:	Ripple width
CROSS TALK:	Cross talk

List of Parameters

Item	Parameter	Default	Setting Range	Unit	Description
PEAK LEVEL	SW	ON	ON or OFF	-	ON/OFF switchover of display.
PEAL WL	SW	ON	ON or OFF	-	ON/OFF switchover of display.
CENTER WL	SW	ON	ON or OFF	-	ON/OFF switchover of display
	ALGO	THRESH	THRESH RMS	-	Selection of algorithm for spectrum width.
	THRESH LVL	THRESH : 3.00 RMS : 3.00	0.1 to 50.0	dB	Threshold value for channel detection. Valid only when ALGO is THRESH.
	K	THRESH : 1.00 RMS : -	1.00 to 10.00	-	Multiplying factor. Valid only when ALGO is THRESH.
	MODE FIT	THRESH : OFF RMS : -	ON or OFF	-	Whether "half of maximum point" is set to the mode peak or not. Valid only when ALGO is THRESH.
	MODE DIFF	THRESH : 3.00 RMS : -	0.0 to 50.0	dB	Minimum value of the peak/bottom difference during channel detection. Valid only when ALGO is THRESH.
SPECTRUM WIDTH	SW	ON	ON or OFF	-	ON/OFF switchover of display.
	ALGO	THRESH	THRESH RMS	-	Selection of algorithm for spectrum width.
	THRESH LVL	THRESH : 3.00 RMS : 3.00	0.1 to 50.0	dB	Threshold for channel detection.
	K	THRESH : 1.00 RMS : -	1.00 to 10.00	-	Multiplying factor. Valid only when ALGO is THRESH.
	MODE FIT	THRESH : OFF RMS : -	ON or OFF	-	Whether "half of maximum point" is set to the mode peak or not. Valid only when ALGO is THRESH.
SPECTRUM WIDTH	MODE DIFF	THRESH : 3.00 RMS : -	0.0 to 50.0	dB	Minimum value of the peak/bottom difference during channel detection. Valid only when ALGO is THRESH.
RIPPLE WIDTH	SW	ON	ON or OFF	-	ON/OFF switchover of display.
	THRESH LVL	3	0.1 to 50.0	dB	Threshold value for channel detection.
	MODE DIFF	0.5	0.000 to 50.000	dB	Minimum value of the peak/bottom difference during channel detection.
CROSS TALK	SW	ON	ON or OFF	-	ON/OFF switchover of display.
	ALGO	THRESH	THRESH PK LVL GRID	-	Selection of algorithm for spectrum width.
	THRESH LVL	THRESH : 3.00 PK LVL : - GRID : -	0.1 to 50.0	dB	Threshold value for channel detection. Valid only when ALGO is THRESH.
	K	THRESH : 1.00 PK LVL : - GRID : -	1.00 to 10.00	-	Multiplying factor. Valid only when ALGO is THRESH.
	MODE FIT	THRESH : OFF PK LVL : - GRID : -	ON or OFF	-	Whether "half of maximum point" is set to the mode peak or not. Valid only when ALGO is THRESH.
	MODE DIFF	THRESH : 3.00 PK LVL : - GRID : -	0.0 to 50.0	-	Minimum value of the peak/bottom difference during channel detection. Valid only when ALGO is THRESH.
	CH SPACE	0.4	0.00 to 50.00	nm	Setting of channel spacing
	SEARCH AREA	0.01	0.01 to 10.00	nm	Setting of the analysis range. Valid only when ALGO is GRID.

Details of Analyses

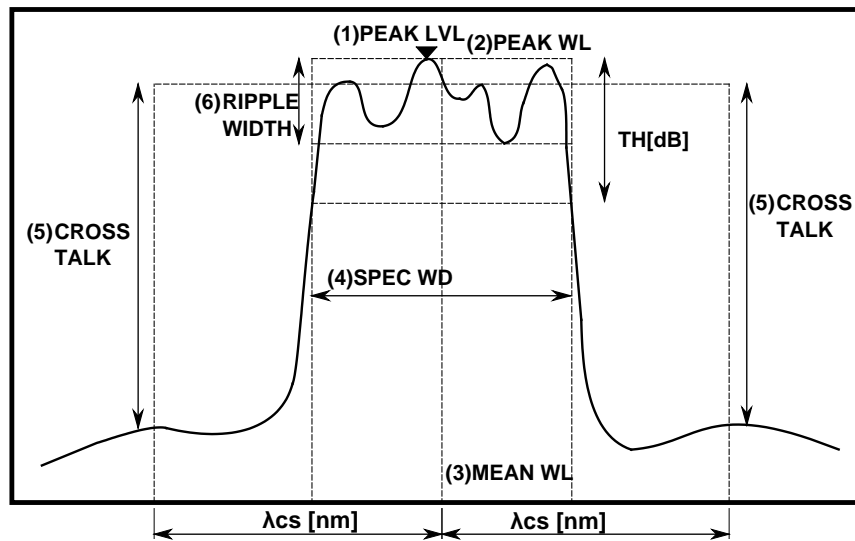

- (1) Peak level (PEAK LVL): value of the level at the waveform peak position
- (2) Peak wavelength (PEAK WL): value of the wavelength at the waveform peak position
- (3) Center wavelength (MEAN WL): value of the center wavelength at the threshold value TH
- (4) Spectrum width (SPEC WD): spectrum width at the threshold value TH
- (5) Cross talk (CRS TALK)

In the case of THRESH / PEAK LV algorithms

Obtain the value of the level on the reference wavelength (MEAN WL for THRESH and PEAK WL for PEAK LV). Also, obtain the value of the level at the wavelength which is $\pm\lambda_{CH\ SPACE}$ away from the reference wavelength. Then, set the difference in level value between the two to the cross talk.

In the case of ITU-T algorithms

Set the ITU-T grid wavelength, which is nearest to the peak wavelength, to the reference wavelength. Set the difference between the bottom level within the range of the reference wavelength $\pm\lambda_{SEARCH\ AREA}$ and the peak level within the range of the position $\pm\lambda_{CH\ SPACE}$ away from the reference wavelength $\pm\lambda_{SEARCH\ AREA}$ to the cross talk.

- (6) Ripple width (RIPPLE WD): Perform a spectrum width search. Set the value of the peak level – bottom level within the obtained spectrum width to the ripple width.

Note

- Unless the parameter "MODE DIFF" is set to a value smaller than uneven portions of a waveform regarded as a ripple, RIPPLE = 0 will result.
- RIPPLE = 0 if the parameter setting is "THRESH" < "MODE DIFF"

FILTER BOTTOM Analysis Function

This function enables the collective analysis of multiple parameters via the measured waveforms of optical filters.

It is used for filter analysis if the number of modes is one. Items and algorithms for analysis are the same as in the AQ6317 series.

Items for analysis

- BOTTOM LVL: Bottom level
- BOTTOM WL: Bottom wavelength
- CENTER WL: Center wavelength
- NOTCH WIDTH: Notch width
- CROSS TALK: Cross talk

List of parameters

Item	Parameter	Default	Setting Range	Unit	Description
BOTTOM LEVEL	SW	ON	ON or OFF	-	ON/OFF switchover of display.
BOTTOM WL	SW	ON	ON or OFF	-	ON/OFF switchover of display.
CENTER WL	SW	ON	ON or OFF	-	ON/OFF switchover of display.
	ALGO	BOTTOM	PEAK BOTTOM	-	Selection of algorithm for spectrum width.
	THRESH LVL	3	0.1 to 50.0	dB	Threshold value for channel detection.
	MODE DIFF	3	0.0 to 50.0	dB	Minimum value of the peak/bottom difference during channel detection.
NOTCH	SW	ON	ON or OFF	-	ON/OFF switchover of display.
WIDTH	ALGO	BOTTOM	PEAK BOTTOM	-	Selection of algorithm for spectrum width.
	THRESH LVL	3	0.1 to 50.0	dB	Threshold value for channel detection.
	MODE DIFF	3	0.0 to 50.0	dB	Minimum value of the peak/bottom difference during channel detection. Valid only when ALGO is THRESH.
CROSS TALK	SW	ON	ON or OFF	-	ON/OFF switchover of display.
	ALGO	BOTTOM	PEAK BOTTOM BOTTOM_LVL GRID	-	Selection of algorithm for spectrum width.
	THRESH LVL	3	0.1 to 50.0	dB	Threshold value for channel detection. Valid when ALGO is PEAK/BOTTOM.
	MODE DIFF	3	00 to 50.0	-	Multiplying factor. Valid only when ALGO is THRESH.
	CH SPACE	0.4	0.0 to 50.00	nm	Setting of channel spacing.
	SEARCH AREA	0.01	0.01 to 10.00	nm	Setting of the range of analysis. Valid only when ALGO is GRID.

Details of Analysis

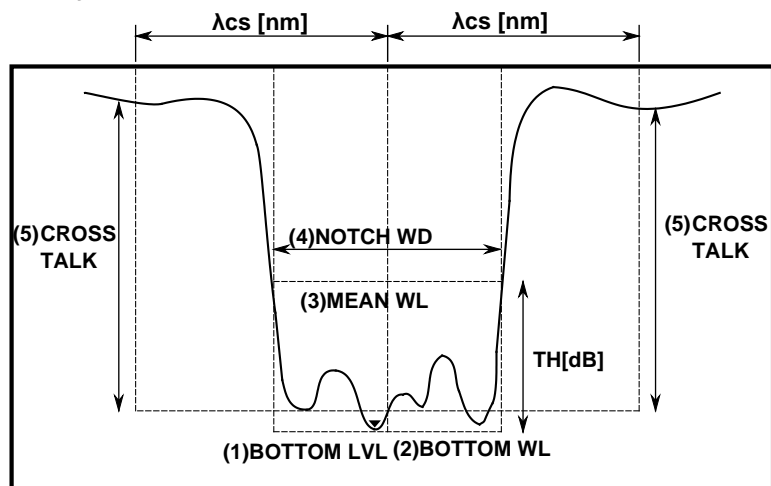

- (1) Bottom level (BTM LVL): Value of level at the waveform bottom position
- (2) Bottom wavelength (BTM WL): Value of wavelength at the waveform bottom position
- (3) Center wavelength (MEAN WL): Value of center wavelength at the threshold value TH
- (4) Notch width (NOTCH WD): Notch width at the threshold value TH
- (5) Cross talk (CRS TALK)

In the case of PEAK / BOTTOM / BOTTOM LV algorithms

Obtain the level value at the reference wavelength (MEAN WL for PEAK/BOTTOM, BOTTOM WL for BOTTOM LV). Also, obtain the level value at the wavelength which is $\pm\lambda_{CH\ SPACE}$ away from the reference wavelength. Then, set the difference in level value between the two to the cross talk.

In the case of ITU-T algorithms

Set the ITU-T grid wavelength, which is nearest the bottom wavelength, to the reference wavelength. Set the difference between the peak level within the range of the reference wavelength $\pm\lambda_{SEARCH\ AREA}$ and the bottom level within the range of the position $\pm\lambda_{CH\ SPACE}$ away from the reference wavelength $\pm\lambda_{SEARCH\ AREA}$ to the cross talk.

WDM FILTER PEAK Analysis Function

This function enables the collective analysis of multiple items for each channel via the measured waveforms of multi-channel optical filters.

It also enables filter analysis for multi-mode waveforms, which is different from FILTER PEAK analysis.

Items for analysis

Item for Analysis	Description
Nominal Wavelength	Reference wavelength/frequency of each channel.
Peak Wavelength / Level	Peak wavelength/frequency and level of each channel.
xdB Width / Center Wavelength	xdB width of each channel and its center wavelength/frequency.
xdB stop-band	Wavelength width/frequency width across xdB of each channel.
xdB pass-band	Pass band xdB from the bottom within the test band of each channel.
Ripple	Max-min level (flatness) within the test band of each channel.
Cross Talk	Difference in level from the position xnm away from each channel.

List of Parameters

Item	Parameter	Default	Setting Range	Unit
Channel Detection, Nominal Wavelength	ALGORHYTHM	MEAN	PEAK / MEAN / GRID/ GRID FIT	-
	MODE DIFF	3	0.1 to 50.0	dB
	THRESH	20	0.1 to 99.9	dB
	TEST BAND	0.1	0.001 to 9.999	nm
Peak Wavelength/ Level	SW	ON	ON / OFF	-
XdB Width	SW	ON	ON / OFF	-
Center Wavelength	THRESH	3	0.1 to 50.0	dB
XdB stop-band	SW	ON	ON / OFF	-
	THRESH LVL	-10	-90.00 to 30.00	dB
XdB pass-band	SW	ON	ON / OFF	-
	THRESH	3.0	0.1 to 50.0	dB
	TEST BAND	0.20	0.01 to 99.99	nm
Ripple	SW	ON	ON / OFF	-
	TEST BAND	0.20	0.01 to 99.99	nm
Cross Talk	SW	ON	ON / OFF	-
	SPACING	0.80	0.01 to 99.99	nm
	TEST BAND	0.20	0.01 to 99.99	nm

Algorithms for analysis

Channel Detection, Nominal Wavelength

Parameter

THRESH
MODE DIFF
ALGO
TEST BAND

Procedure

PEAK

- Channel: Each mode peak detected via a mode search (Except for the mode peaks at levels which are lower than the mode at the highest level by THRESH[dB] or less.)
- Reference wavelength: Wavelength of each mode peak.
- Peak wavelength/level: Wavelength and level of each mode peak.

MEAN

- Channel: Each mode peak detected via a mode search (Except for the mode peaks at levels which are lower than the mode at the highest level by THRESH[dB] or less.)
- Reference wavelength: 3 dB center wavelength at each mode peak.
- Peak wavelength/level: Wavelength and level of each mode peak.

GRID FIT

- Channel: Modes within the range of GRID wavelength \pm (TEST BAND/2) among the mode peaks detected via a mode search (except for the mode peaks at levels which are lower than the mode at the highest level by THRESH[dB] or less).
If the number of relevant modes in one GRID is more than one, only the mode at the highest level will be regarded as the channel.
- Reference wavelength: GRID wavelength nearest to each channel.
- Peak wavelength/level: Wavelength and level of the mode peak of each channel.

GRID

- Channel: A mode search shall not be performed. All GRID wavelengths within the range of analysis shall be the channels.
- Reference wavelength: GRID wavelength of each channel.
- Peak wavelength/level: Peak wavelength and peak level within the range of GRID wavelength \pm (TEST BAND/2) of each channel.

PEAK LVL/PEAK WL

Parameter

THRESH

MODE DIFF

Procedure

- Apply WDM analysis to the waveform data of an active trace and perform channel detection. Note that the parameter DISPLAY MASK is not used.
- Obtain the mode peak wavelength (PEAK WL) of each channel of the active trace and its signal optical level (PEAK LVL).

XdB Width

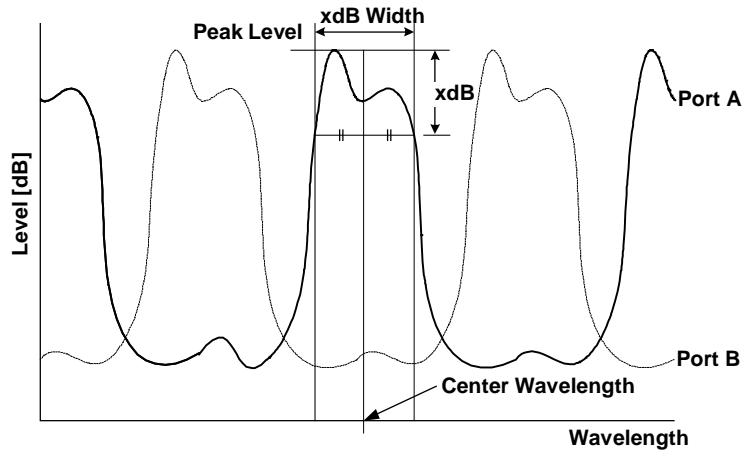

Parameter

THRESH

Procedure

Obtain the width (xdB_Width), which is below the peak level LPI of each channel by the parameter THRESH_LEVEL both on the left and on the right, and its center wavelength. The algorithm for analysis is the same as the algorithm THRESH of the spectrum width.

XdB stop band

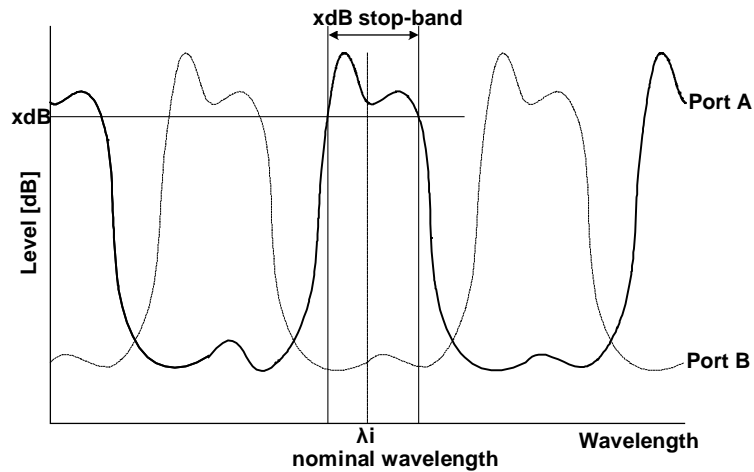

Parameter
THRESH

Procedure

Obtain the width ($x\text{dB_stop-band}$) that centers on the reference wavelength λ_i of each channel and that is located below by the parameter THRESH_LEVEL both on the left and on the right.

XdB pass-band

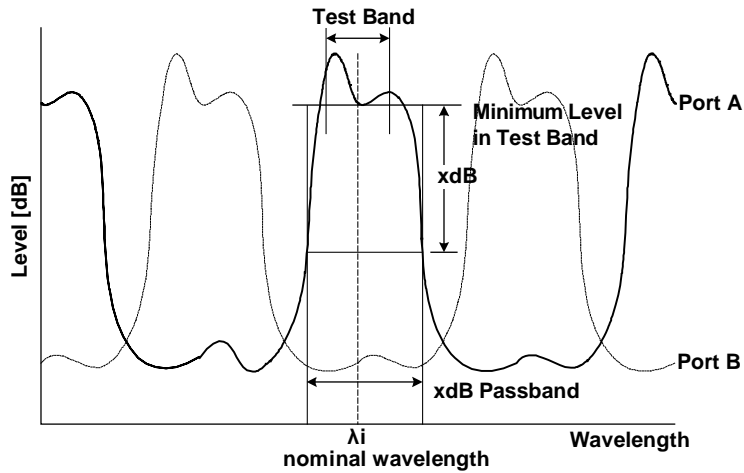

Parameter
THRESH
TEST BAND

Procedure

- Perform the bottom search within the range of parameter Test_Band/2 by centering on reference wavelength λ_i of each channel and obtain the bottom level (L_{Bi}).
- Obtain the width ($x\text{dB_pass-band}$) that is below the bottom level L_{Bi} obtained in the above procedure by the parameter THRESH_LEVEL.

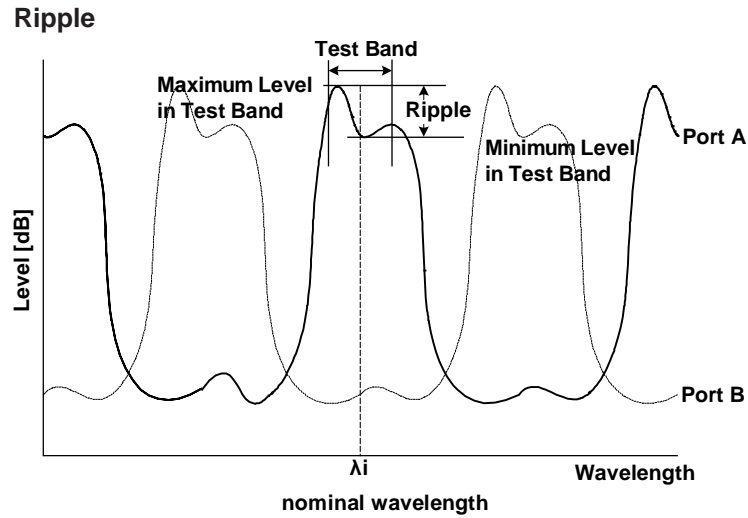

Parameter
TEST BAND

Procedure

- Perform the peak search and bottom search within the range of parameter Test_Band/2 by centering on the reference wavelength λ_i of each channel, and obtain the peak level (LP'i) and the bottom level (LB'i).
- Use the peak level (LP'i) and bottom level (LB'i) obtained in the above procedure to obtain the ripple from the following equation:

$$\text{Ripple} = \text{LP}'i - \text{LB}'i$$

Cross Talk

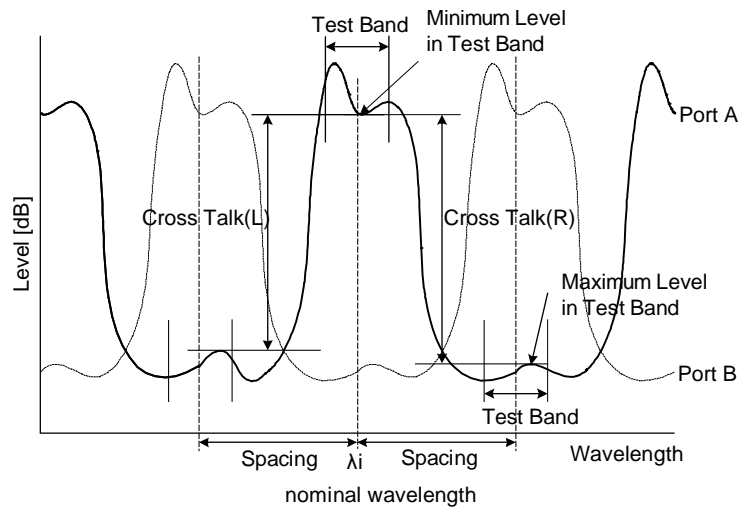

Parameter

- SPACING
- TEST BAND

Procedure

- Perform a bottom search within the range of parameter Test_Band/2 while centering on reference wavelength (λ_i) of each channel and obtain the bottom level (L_{Bi}).
- Perform a peak search within the range of parameter Test_Band/2 while centering on the point ($\lambda_i - \lambda_{SP}$) that is obtained by subtracting the parameter SPACING from the reference wavelength λ_i of each channel. Then, obtain the peak level (L_{PLi}).
- Perform a peak search within the range of parameter Test_Band/2 while centering on the point ($\lambda_i + \lambda_{SP}$) that is obtained by adding the parameter SPACING to the reference wavelength λ_i of each channel. Then, obtain the peak level (L_{PRi}).
- Use the values obtained in the above procedure to obtain the left and right cross talks (X_{TLi}, X_{TRi}) of each channel from the following equations:

$$X_{TLi} = L_{Bi} - L_{PLi}$$

$$X_{TRi} = L_{Bi} - L_{PRi}$$

WDM FILTER BOTTOM Analysis Function

This function enables the collective analysis of multiple items of each channel via the measured waveforms of multi-channel optical filters.

It also enables filter analysis for multi-mode waveforms, which is different from the FILTER BOTTOM analysis.

Items for analysis

Item for Analysis	Description
Nominal Wavelength	Reference wavelength/frequency of each channel.
Bottom Wavelength / Level	Peak wavelength/frequency and level of each channel
xdB Notch Width / Center Wavelength	xdB notch width of each channel and its center wavelength/frequency.
xdB stop-band	Wavelength width / frequency width across xdB of each channel.
xdB Elimination band	Elimination band that is xdB from the bottom within the test band of each channel.
6Ripple	Max-min level (flatness) within the test band of each channel.
Cross Talk	Difference in level between the positions that are xnm away in each channel.

List of Parameters

Item	Parameter	Default	Setting Range	Unit
Channel Detection, Nominal Wavelength	ALGORHYTHM	NOTCH(B)	PEAK / NOTCH(P) / NOTCH(B) / GRID / GRID FIT	-
	MODE DIFF	3.0	0.1 to 50.0	dB
	THRESH	20.0	0.1 to 99.9	dB
	TEST BAND	0.100	0.001 to 9.999	nm
Bottom Wavelength/Level	SW	ON	ON / OFF	-
XdB Width Center Wavelength	SW	ON	ON / OFF	-
	ALGORHYTHM	NOTCH(B)	NOTCH(P) / NOTCH(B)	-
	THRESH	3.0	0.1 to 50.0	dB
XdB stop-band	SW	ON	ON / OFF	-
	THRESH	-10.000	-90.000 to 30.000	dB
XdB Elimination band	SW	ON	ON / OFF	-
	THRESH	3.0	0.1 to 50.0	dB
	TEST BAND	0.20	0.01 to 99.99	nm
Ripple	SW	ON	ON / OFF	-
	TEST BAND	0.20	0.01 to 99.99	nm
Cross Talk	SW	ON	ON / OFF	-
	SPACING	0.80	0.01 to 99.99	nm
	TEST BAND	0.20	0.01 to 99.99	nm

Algorithm for analysis

NOMINAL WAVELENGTH

Parameter

ALGO
MODE DIFF
THRESH
TEST BAND

Procedure

- BOTTOM

Channel: Each mode bottom detected by a mode search (Except for the mode bottoms at levels which are above the mode at the lowest level by THRESH[dB] or more.)

Reference wavelength: Wavelength of each mode bottom.

Bottom wavelength/level: Wavelength/level of each mode bottom.

- NOTCH(B)

Channel: Each mode bottom detected by a mode search (Except for the mode bottoms at levels which are above the mode at the lowest level by THRESH[dB] or more.)

Reference wavelength: 3dB-center wavelength with each mode bottom as the reference (ALGO=BOTTOM).

Bottom wavelength/level: Wavelength and level of each mode peak.

- NOTCH(P)

Channel: Each mode peak detected by a mode search (Except for the mode bottoms at levels which are above the mode at the lowest level by THRESH[dB] or more.)

Reference wavelength: 3dB-center wavelength with each mode bottom as the reference (ALGO=PEAK).

Bottom wavelength/level: Wavelength and level of each mode bottom.

- GRID FIT

Channel: Modes within the range of GRID wavelength \pm (TEST BAND/2) among the mode bottoms detected via a mode search (except for the mode bottoms at levels which are higher than the mode at the lowest level by THRESH[dB] or more).

If the number of relevant modes in one GRID is more than one, only the mode at the lowest level will be regarded as the channel.

Reference wavelength: GRID wavelength nearest to each channel.

Bottom wavelength/level: Wavelength and level of the mode bottom of each channel.

- GRID

Channel: A mode search shall not be performed. All the GRID wavelengths within the range of analysis shall be the channels.

Reference wavelength: GRID wavelength of each channel.

Peak wavelength/level: Bottom wavelength and bottom level within the range of GRID wavelength \pm (TEST BAND/2) of each channel.

BOTTOM WL / BOTTOM LVL

Parameter
 THRESH
 MODE DIFF

Procedure
 Obtain the wavelength λ_i of the mode bottom of each channel and its signal optical level L_{Bi} .

XdB_NOTCH_WIDTH/CENTER WAVELENGTH

Parameter
 ALGO

Procedure
 According to the settings of the parameter ALGO, obtain the xdB notch width (xdB_Notch_Width) of each channel and its center wavelength/frequency (Center_Wavelength).

NOTCH(B)

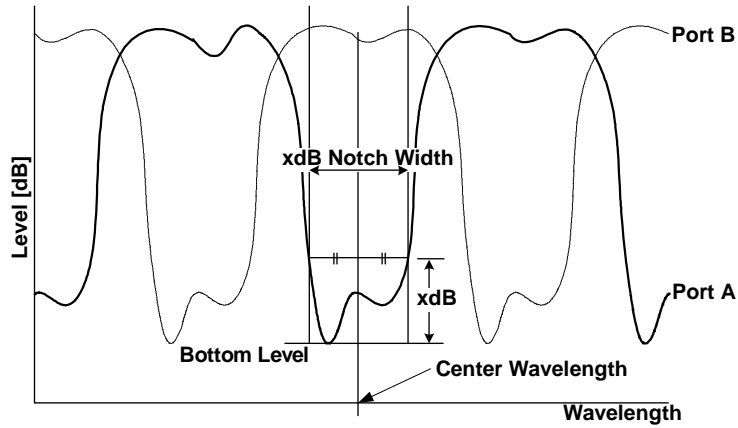

Obtain the width (xdB_Notch_Width) between the two points, which are above the bottom level of each channel by the parameter THRESH_LEVEL, and its center wavelength (Center_Wavelength).

NOTCH(P)

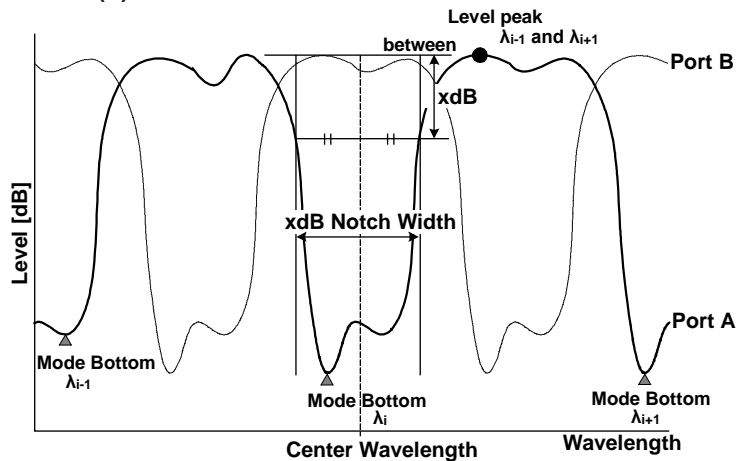

Obtain the width (xdB_Notch_Width) between the two points, which are below the higher point of either the left peak level or the right peak level of each channel by the parameter THRESH_LEVEL, and its center wavelength/frequency (Center_Wavelength).

XdB_STOP-BAND

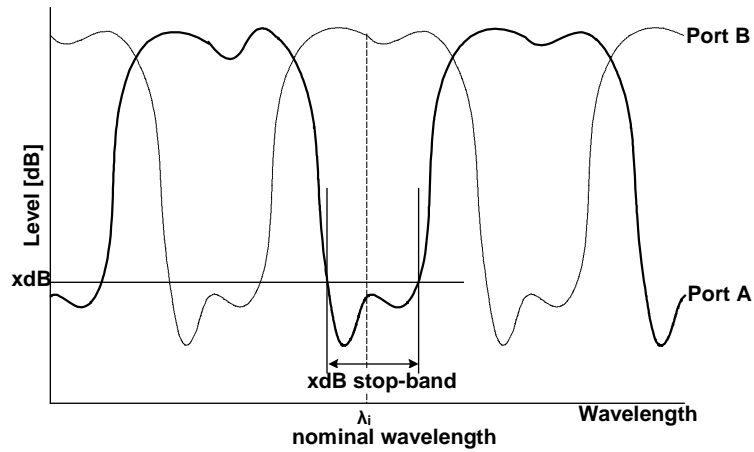

Parameter
THRESH

Procedure
Obtain the width ($x\text{dB_stop-Band}$) that centers on the nominal wavelength λ_i of each channel and that is located below by the parameter THRESH_LEVEL both on the left and on the right.

XdB_ELIMINATION BAND

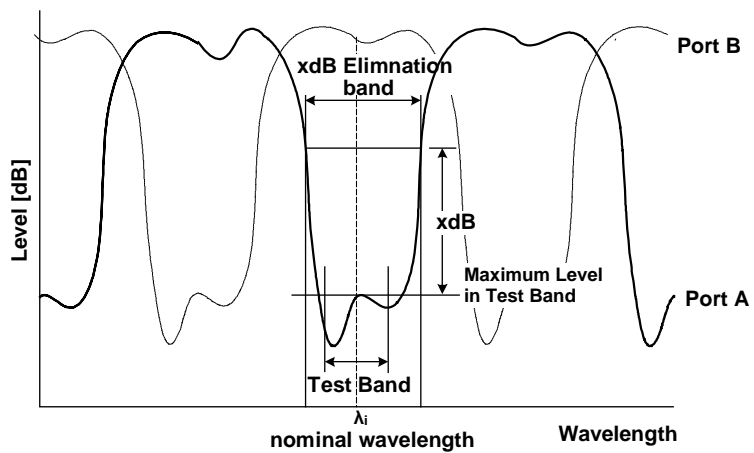

Parameter
THRESH
TEST BAND

Procedure

- Perform the peak search within the range of the parameter Test_Band/2 by centering on the nominal wavelength λ_i of a channel and obtain the peak level (L_{Pi}).
- Obtain the width ($x\text{dB_Elimination_Wavelength}$) that is above the peak level L_{Pi} obtained in the above procedure by the parameter THRESH_LEVEL both on the left and on the right.

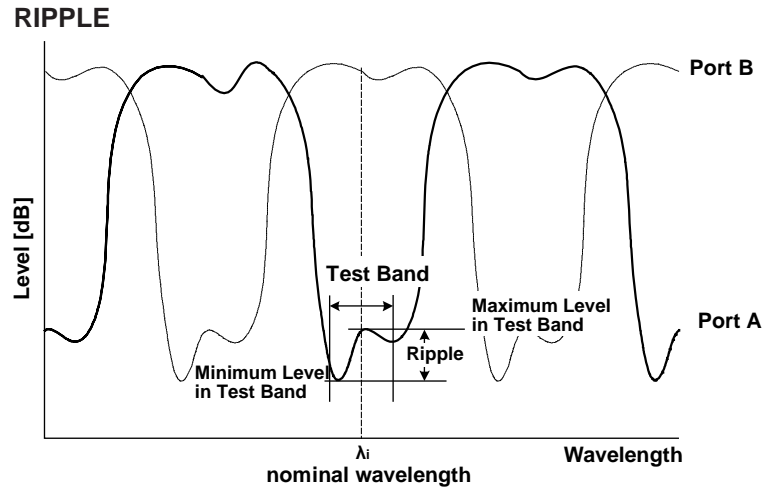

Parameter
TEST BAND

Procedure

- Perform the peak search and bottom search within the range of parameter Test_Band/2 by centering on reference wavelength λ_i of each channel, and obtain the peak level (LP'i) and the bottom level (LB'i).
- Use the peak level (LP'i) and bottom level (LB'i) obtained in the above procedure to obtain the ripple (Ripple) from the following equation:

$$\text{Ripple} = \text{LP}'i - \text{LB}'i$$

CROOS TALK

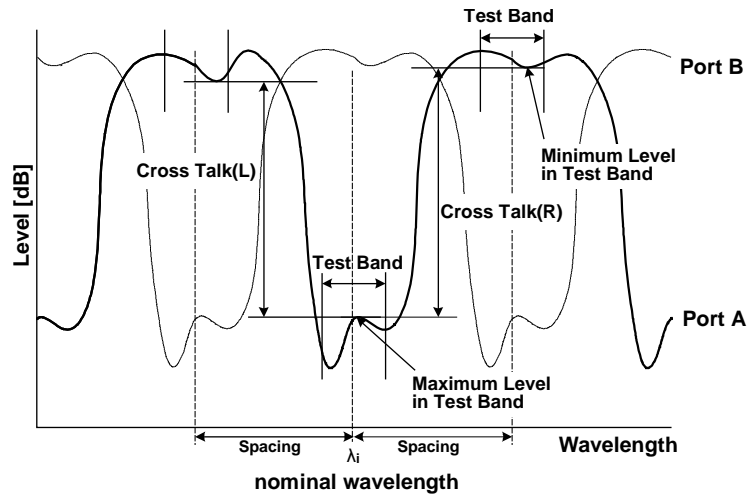

Parameter
 SPACING
 TEST BAND

Procedure

- Perform a peak search within the range of parameter Test_Band/2 while centering on the reference wavelength λ_i of each channel and obtain the peak level (LP^{"i}).
- Perform a bottom search within the range of parameter Test_Band/2 while centering on the point $(\lambda_i - \lambda_{SP})$ that is obtained by subtracting the parameter SPACING from the reference wavelength λ_i of each channel. Then, obtain the bottom level (LPL_i).
- Perform the bottom search within the range of parameter Test_Band/2 while centering on the point $(\lambda_i + \lambda_{SP})$ that is obtained by subtracting the parameter SPACING from the reference wavelength λ_i of each channel. Then, obtain the bottom level (LPR_i).
- Use the values obtained in the above procedures to obtain the left and right cross talks (XTL_i, XTR_i) of each channel from the following equations:

$$XTL_i = LP^{''i} - LPL_i$$

$$XTR_i = LP^{''i} - LPR_i$$

Appendix 7 Soft Key Tree Diagram

The following is an overview of the instrument's menus. Some menus are omitted.

SWEEP

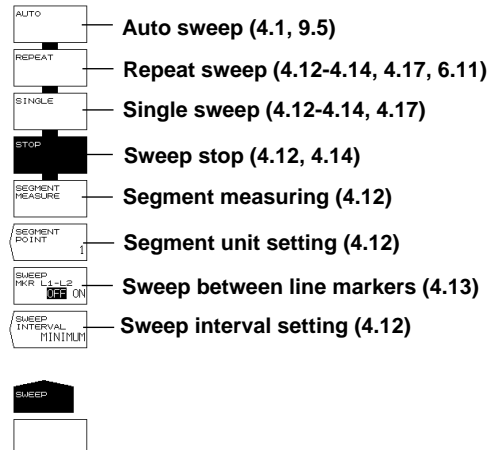

CENTER

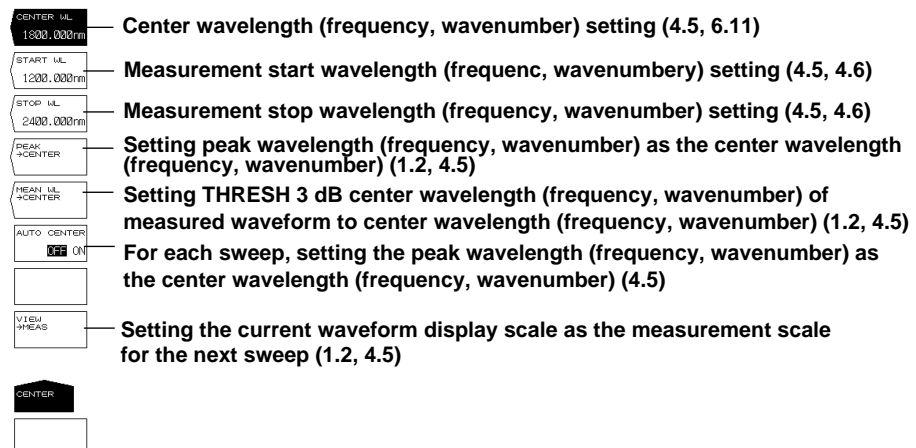

SPAN

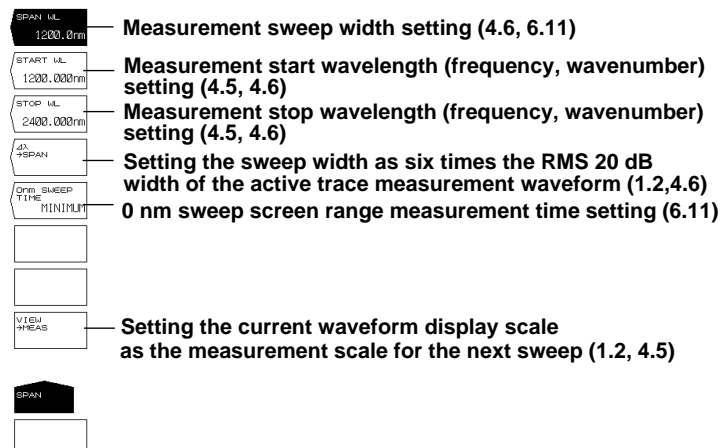

LEVEL

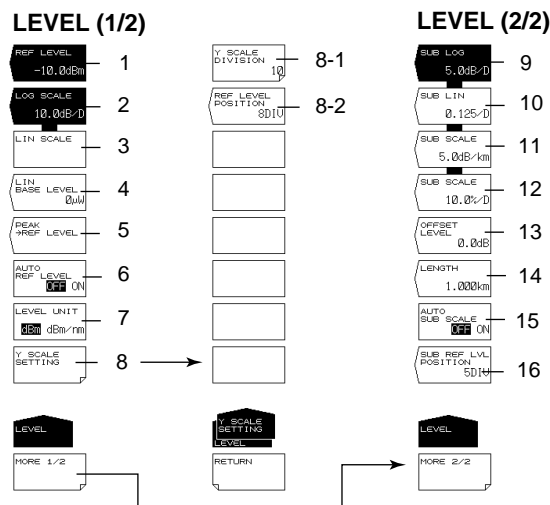

- 1 Reference level setting (1.5, 4.1, 4.4, 6.12)
- 2 LOG scale setting (4.2, 4.4)
- 3 Linear scale setting (4.2, 4.4)
- 4 Linear scale bottom settings (4.2)
- 5 Setting the peak level to the reference level (1.2, 4.4)
- 6 Automatic setting of reference level (4.4)
- 7 Vertical axis units setting (4.2)
- 8 Vertical axis setting (4.2)
 - 8-1 Setting the number of vertical axis divisions (4.2)
 - 8-2 Reference level screen position setting (4.2)
- 9 Setting subscale to LOG (4.3)
- 10 Setting subscale to LINEAR (4.3)
- 11 Setting subscale to dB/km (4.3)
- 12 Setting subscale to % (4.3)
- 13 Linear subscale bottom setting or offset level setting for LOG (4.3)
- 14 Optical fiber length setting (4.3)
- 15 Automatic scaling of subscale (4.3)
- 16 Position settings in the reference level subscale (4.3)

SETUP

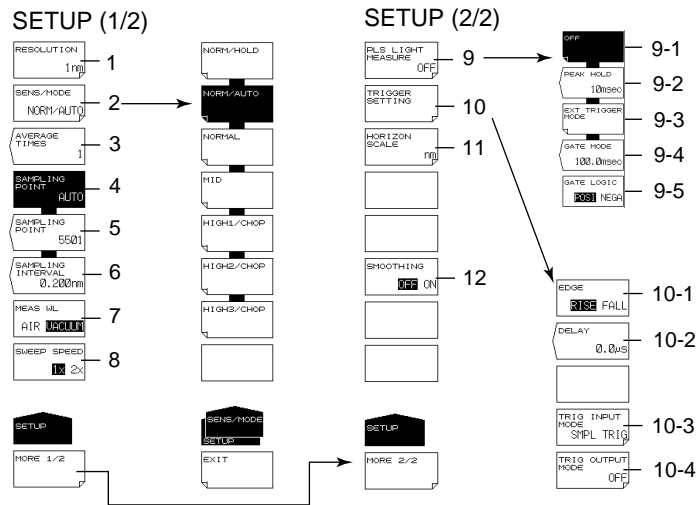

- 1 Measurement resolution setting (4.7, 6.10, 9.5)
- 2 Measurement sensitivity, CHOP mode settings (4.9)
 - 2.1 CHOP mode setting (4.9)
- 3 Averaging times setting (4.10)
- 4 Automatic sampling points setting (4.7, 4.8)
- 5 Manual sampling points setting (4.8)
- 6 Sampling interval setting (4.8)
- 7 Setting the measured wavelength to air/vacuum (4.2)
- 8 Sweep speed setting (4.10)
- 9 Pulse light measurement settings (4.14, 4.15)
 - 9-1 Pulse light measurement OFF (4.14)
 - 9-2 Peak hold time setting (4.14)
 - 9-3 External trigger mode setting (4.15)
- 10 Trigger condition settings (4.15)
 - 10-1 Edge setting (4.15)
 - 10-2 Delay setting (1.2, 4.15)
 - 10-3 Trigger input mode setting (4.16)
 - 10-4 Trigger output mode setting (4.17)
- 11 Horizontal axis units setting (4.2)
- 12 Smoothing (4.18)

ZOOM

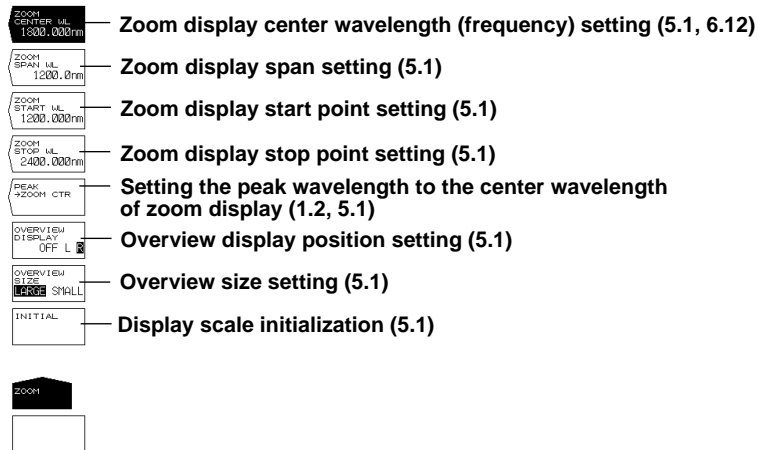

DISPLAY

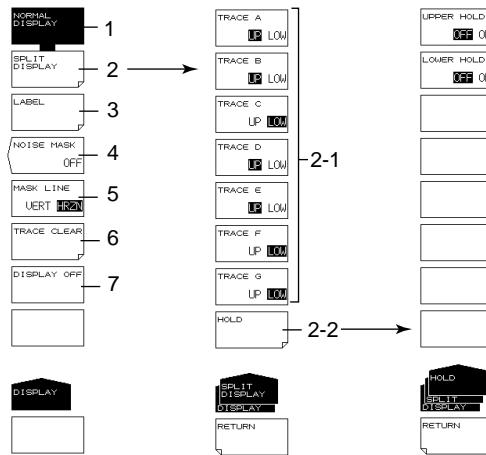

- 1 Normal display (5.10)
- 2 Split display (5.10)
 - 2-1 Display position setting
 - 2-2 Display position fixing
- 3 Label setting (3.3)
- 4 Noise mask setting (1.3, 5.11)
- 5 Mask method setting (5.11)
- 6 Trace clearing (5.12)
- 7 Turning the display OFF (8.6)

TRACE (MORE 1/2)

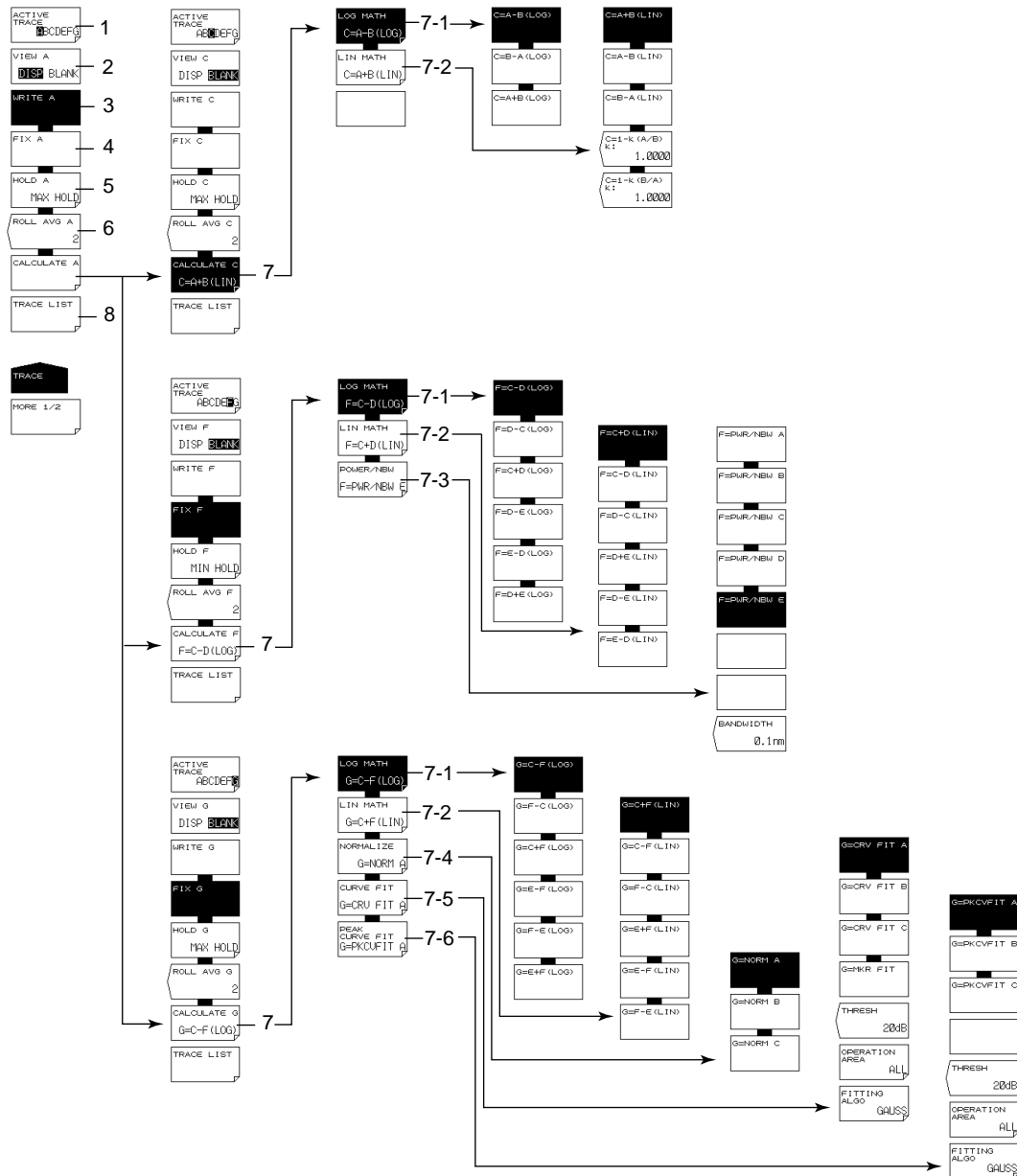

- 1 Active trace setting (4.11, 5.2-5.7, 6.8, 6.9)
- 2 Show/hide active trace setting (4.11, 5.2-5.7, 6.8, 6.9)
- 3 Setting write mode on the active trace (4.11, 5.2, 6.8, 6.9)
- 4 Setting fixed mode on the active trace (5.2, 6.8, 6.9)
- 5 Setting MAX/MIN hold mode on the active trace (5.3)
- 6 Active trace sweep average setting(5.4)
- 7 Trace-to-trace calculation settings (trace C, F, G only) (5.5-5.7, 6.9)
 - 7-1 LOG based between-trace calculation (5.5, 6.9)
 - 7-2 LIN based between-trace calculation (5.5)
 - 7-3 Power spectral density display (trace F only) (5.5, 5.8)
 - 7-4 Trace normalization (trace G only) (5.5, 5.6)
 - 7-5 Trace curve fitting (trace G only) (5.5, 5.7)
 - 7-6 Trace peak curve fitting (trace G only) (5.5, 5.7)
- 8 Trace conditions list display (5.12)

TRACE(MORE 2/2)

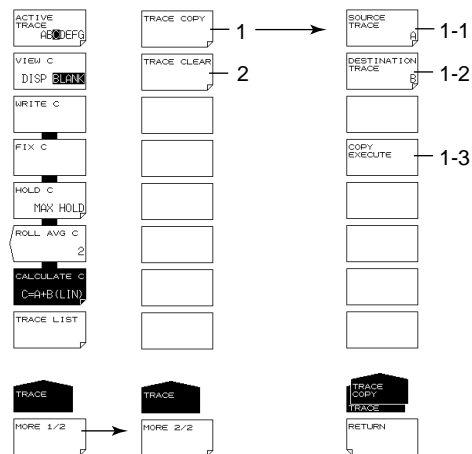

- 1 Copy trace (5.12)
 - 1-1 Copy source trace setting (5.12)
 - 1-2 Copy target trace setting (5.12)
 - 1-3 Execute copy (5.12)
- 2 Trace clearing (5.12)

MARKER

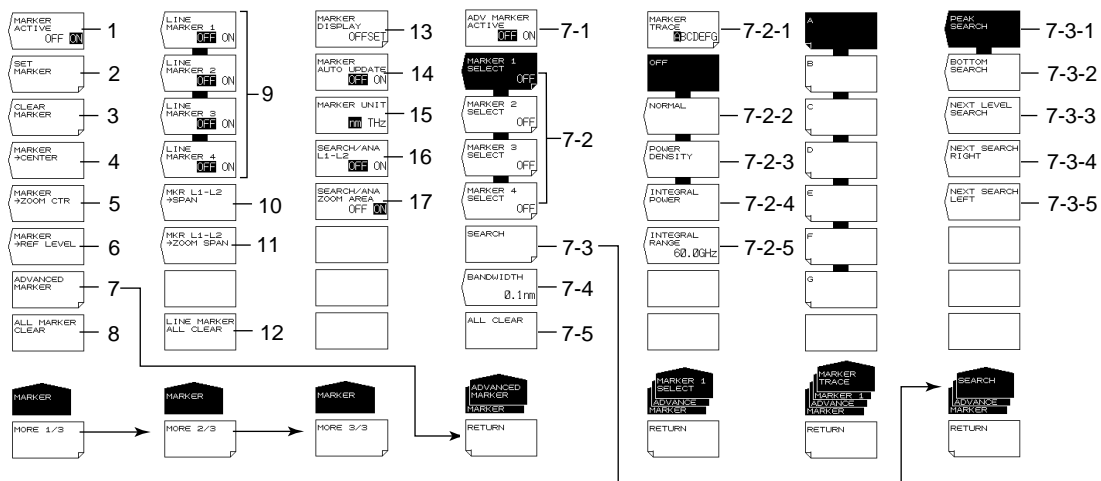

- 1 Moving marker display ON/OFF (5.9)
- 2 Setting moving markers to fixed markers (5.9, 5.13)
- 3 Clearing fixed markers (5.9, 5.13)
- 4 Setting the moving marker wavelength (frequency) to measurement center (1.2, 4.5, 5.9)
- 5 Setting the moving marker wavelength (frequency) to display scale center (1.2, 5.9)
- 6 Setting the moving marker level to reference level (4.4, 5.9)
- 7 Displays advanced markers (1.3, 5.9)
 - 7-1 Turns on or off the advanced marker display (5.9)
 - 7-2 Sets advanced markers (5.9)
 - 7-2-1 Selects the trace to assign the marker to (5.9)
 - 7-2-2 Sets moving markers (5.9)
 - 7-2-3 Sets power density markers (5.9)
 - 7-2-4 Sets integrated power markers (5.9)
 - 7-2-5 Sets integration wavelength range (5.9)
 - 7-3 Executes a search based on advanced markers (5.9)
 - 7-3-1 Executes a peak search (5.9)
 - 7-3-2 Executes a bottom search (5.9)
 - 7-3-3 Sets the advanced marker from the current position to the next peak or bottom value (5.9)
 - 7-3-4 Sets the advanced marker from the current position to the next local peak or bottom value on the right (5.9)
 - 7-3-5 Sets the advanced marker from the current position to the next local peak or bottom value on the left (5.9)
- 8 Clear all displayed moving and fixed markers (5.9, 5.13)
- 9 Line markers ON/OFF (5.9)
- 10 Setting the measurement span to between line markers 1 and 2 (1.2, 4.6, 5.9)
- 11 Setting the zoom span to between line markers 1 and 2 (1.2, 5.9)
- 12 Clear all displayed line markers (5.9)
- 13 Marker display settings (5.9)
- 14 Setting whether to automatically update the fixed marker's level values when updating active trace (5.9)
- 15 Marker value units setting (5.9, 6.10)
- 16 Setting the peak search, bottom search, and analysis function ranges to between line markers L1 and L2 (5.13, 6.13) (For both the PEAK SEARCH and ANALYSIS menus)
- 17 Setting the peak search, bottom search, and analysis function ranges to within the zoom range (5.13, 6.13) (For both the PEAK SEARCH and ANALYSIS menus)

PEAK SEARCH

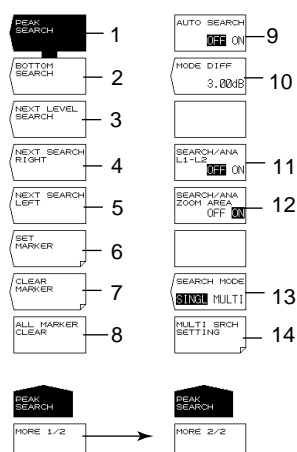

- 1 Executing peak search (5.13)
- 2 Executing bottom search (5.13)
- 3 Moving the moving marker from the current position to the next peak/bottom value (5.13)
- 4 Moving the moving marker from the current position to the next peak/bottom value to the right (5.13)
- 5 Moving the moving marker from the current position to the next peak/bottom value to the left (5.13)
- 6 Setting the moving marker to the fixed marker (5.9, 5.13)
- 7 Clearing fixed markers (5.9, 5.13)
- 8 Clearing all displayed moving and fixed markers (5.9, 5.13)
- 9 Turning ON/OFF peak/bottom search each sweep (5.13)
- 10 Setting the minimum peak/bottom difference of the mode judgment reference (5.13, 6.6, 6.8)
- 11 Setting the peak search, bottom search, and analysis function ranges to between line markers L1 and L2 (5.13, 6.12)
(For both the MARKER and ANALYSIS menus)
- 12 Setting the peak search, bottom search, and analysis function ranges to within the zoom range (5.13, 6.12)
(For both the MARKER and ANALYSIS menus)
- 13 Switching between the single and multi peak/bottom searches (5.13, 5.14)
- 14 Setting the threshold and sort order of the multi search (5.14)

MEMORY

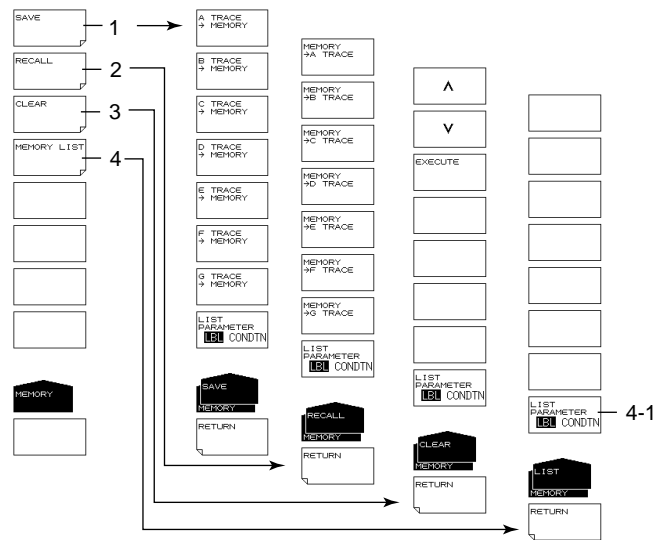

- 1 Temporarily saving a trace (7.2)
- 2 Loading temporarily saved trace (7.2)
- 3 Clearing temporarily saved traces (7.2)
- 4 Displaying temporarily saved traces in a list (7.2)
- 4-1 Changing list display contents (7.2)

FILE

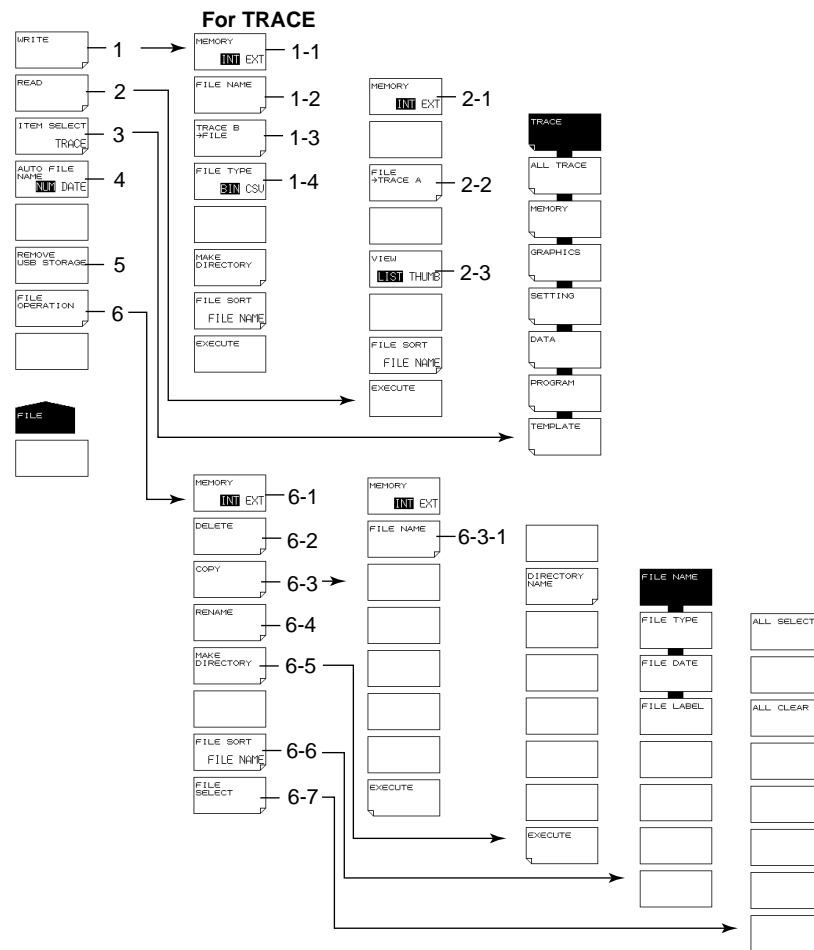

- 1 Saving data (chapter 7)
 - 1-1 Setting the save destination for trace data (7.3)
 - 1-2 Entering a file name (7.3)
 - 1-3 Setting the trace to save (7.3)
 - 1-4 Setting the data format (7.3)
- 2 Loading data (6.12, chapter 7)
 - 2-1 Setting the loading source for trace data (7.3)
 - 2-2 Setting the loading destination trace (7.3)
 - 2-3 Switching list/thumbnail display (7.3)
- 3 Setting the target item (6.12, chapter 7)
- 4 Assigning the filename automatically (7.12)
- 5 Removing the USB storage medium (2.3, 7.1)
- 6 File manipulation (7.11)
 - 6-1 Setting the target storage device (7.11)
 - 6-2 Deleting a file (7.11)
 - 6-3 Copying a file (7.11)
 - 6-3-1 Setting the paste destination (7.11)
 - 6-3-2 File name when saving to separate name (7.11)
 - 6-4 Renaming (7.11)
 - 6-5 Creating a directory (7.11)
 - 6-6 Sorting a file (7.11)
 - 6-7 File selection (7.11)

For ALL TRACE

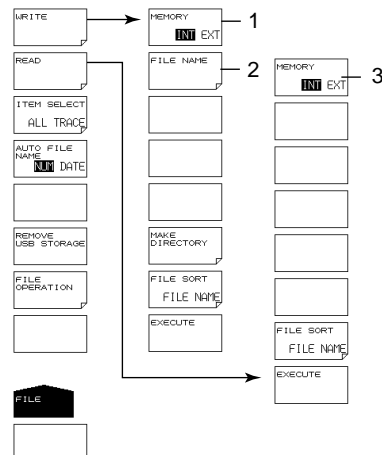

ALL TRACE

- 1 Save destination setting for all trace data (7.4)
- 2 File name setting (7.4)
- 3 Load source setting for all trace data (7.4)

For MEMORY

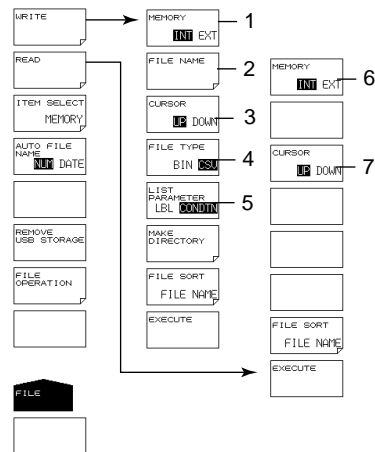

MEMORY

- 1 Setting the MEMORY data save destination (7.3)
- 2 Entering a file name (7.3)
- 3 Switching the cursor target window (7.3)
(setting the source/destination memory number)
- 4 Setting the data format (7.3)
- 5 Switching the MEMORY list display contents (7.3)
- 6 Setting the MEMORY data loading source (7.3)
- 7 Switching the cursor target window (7.3)
(setting the source/destination load file)

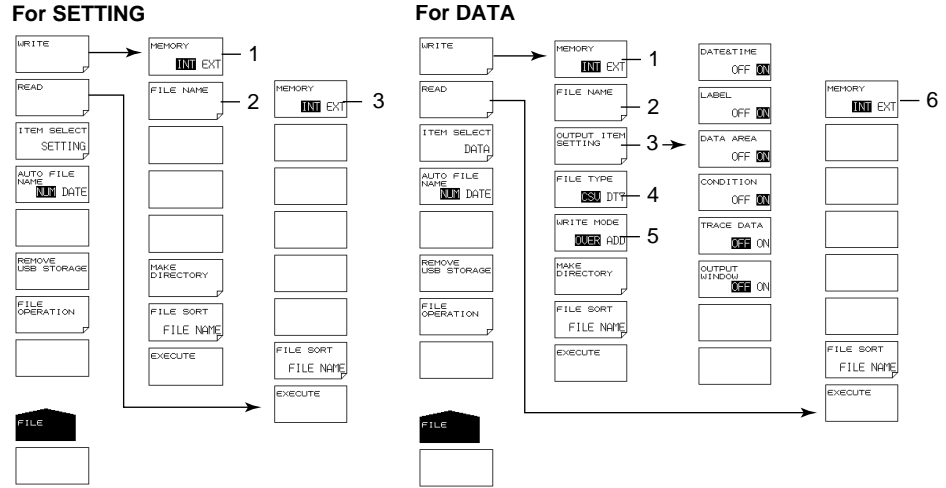

SETTING

- 1 Setting the save destination for settings (7.5)
- 2 Entering a file name (7.5)
- 3 Setting the loading source for settings (7.5)

DATA

- 1 Setting the save destination for analysis results data (7.6)
- 2 Entering a file name (7.6)
- 3 Setting the items to save (7.6)
- 4 Data format setting (7.6)
- 5 Setting overwrite or add (7.6)
- 6 Setting the loading source for analysis results data (7.6)

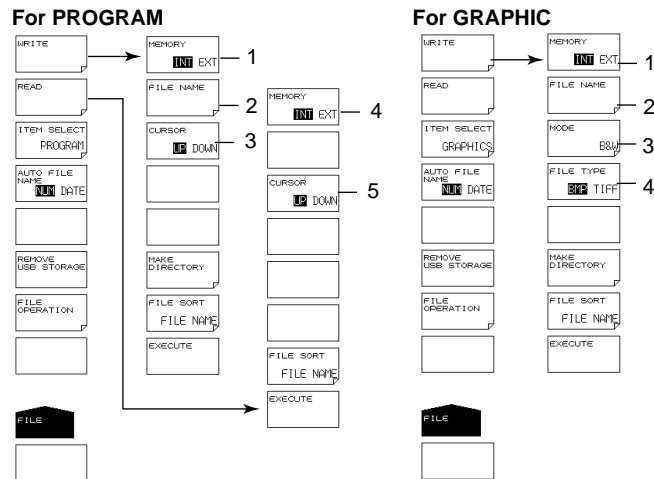

PROGRAM

- 1 Setting the save destination for program data (7.7)
- 2 Entering a file name (7.7)
- 3 Switching the cursor target window (7.7)
(setting the source/destination program number)
- 4 Setting the loading source for program data (7.7)
- 5 Switching the cursor target window (7.7)
(setting the source/destination load file)

GRAPHIC

- 1 Setting the save destination for image data (7.8)
- 2 Entering a file name (7.8)
- 3 Color mode setting (7.8)
- 4 Data format setting (7.8)

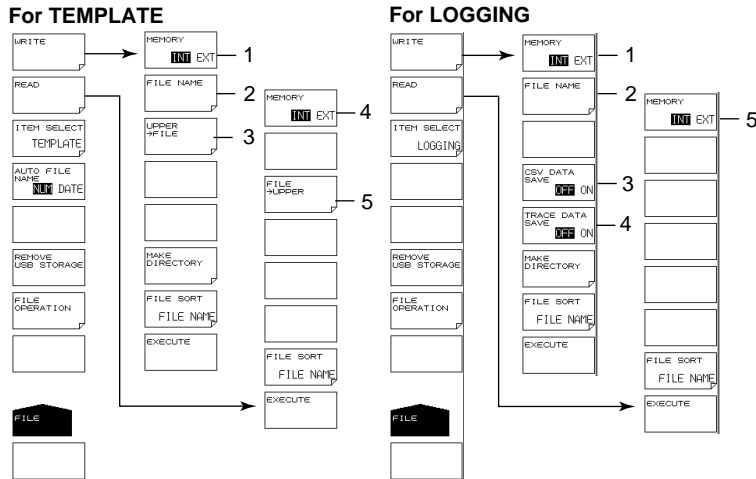

TEMPLATE

- 1 Setting the save destination for template data (7.9)
- 2 Entering a file name (7.9)
- 3 Setting a template to save (7.9)
- 4 Setting the loading source for template data (7.9)
- 5 Setting the loading destination for template data (6.12, 7.9)

LOGGING

- 1 Sets the logging data save destination (7.10)
- 2 Sets the file name (7.10)
- 3 Sets the logging data to save (7.10)
- 4 Sets the logging data load source (7.10)

PROGRAM (See IMAQ6370C-17EN)

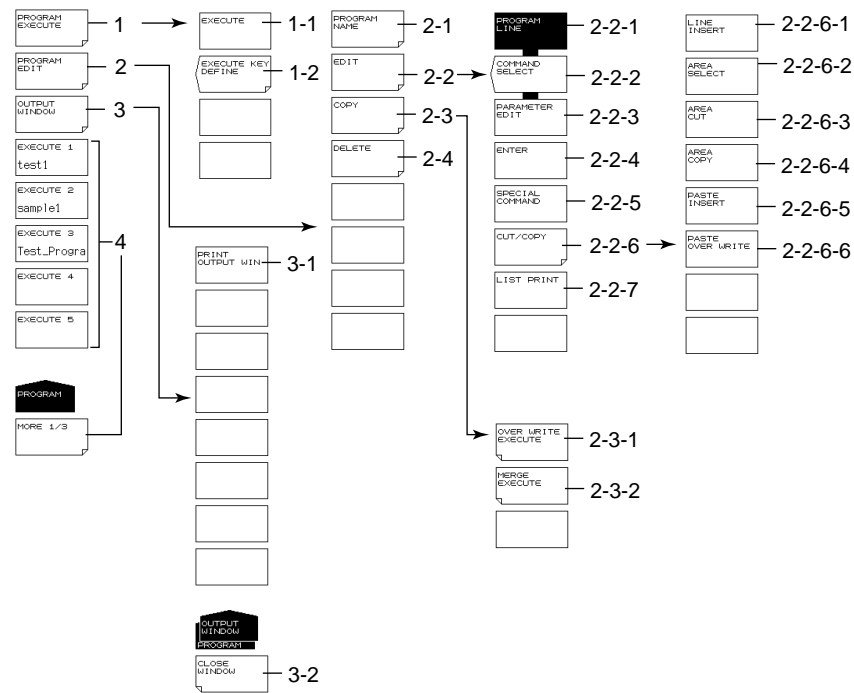

- 1 Program execution
 - 1-1 Program execution
 - 1-2 Registering programs to soft keys
- 2 Editing programs
 - 2-1 Entering program names
 - 2-2 Editing lines
 - 2-2-1 Setting program lines
 - 2-2-2 Setting function commands
 - 2-2-3 Editing parameters
 - 2-2-4 Finalizing input values
 - 2-2-5 Special command settings
 - 2-2-6 Cutting/pasting lines
 - 2-2-6-1 Inserting lines
 - 2-2-6-2 Setting the target area
 - 2-2-6-3 Deleting an area
 - 2-2-6-4 Copying an area
 - 2-2-6-5 Pasting (inserting)
 - 2-2-6-6 Pasting (overwriting)
 - 2-2-7 Printing program lists
 - 2-3 Copying programs
 - 2-3-1 Overwriting
 - 2-3-2 Copying and adding contents (merge)
 - 2-4 Deleting programs
- 3 OUTPUT WINDOW display
 - 3-1 OUTPUT WINDOW print out
 - 3-2 Closing the OUTPUT WINDOW
- 4 Executing programs registered to soft keys

ADVANCE

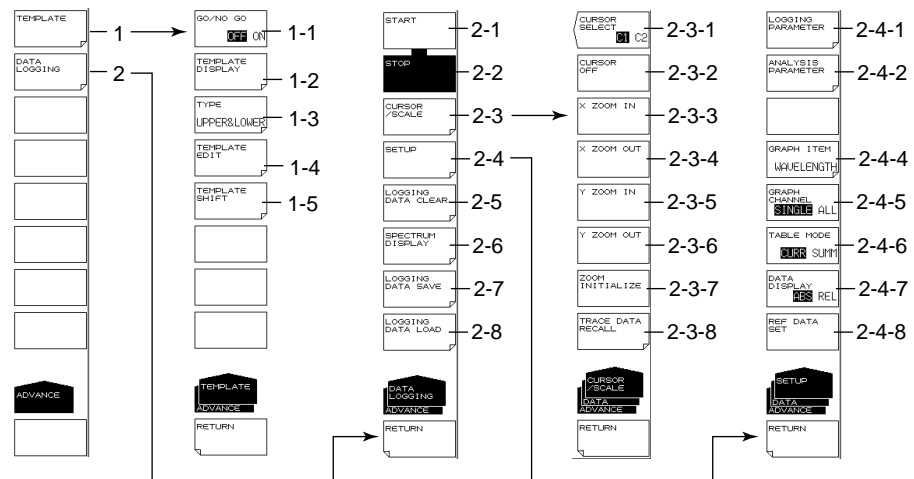

- 1 Template settings (6.12)
 - 1-1 GO/NO GO ON/OFF (6.12)
 - 1-2 Displaying templates (6.12)
 - 1-3 Setting the template type (6.12)
 - 1-4 Editing templates (6.12)
 - 1-5 Setting the template shift amount (6.12)

- 2 Sets data logging (6.15)
 - 2-1 Executes data logging (6.15)
 - 2-2 Stops data logging (6.15)
 - 2-3 Displays cursors and scales (6.15)
 - 2-3-1 Selects the cursor display (6.15)
 - 2-3-2 Turns off the cursor display (6.15)
 - 2-3-3 Expands the horizontal scale at the current cursor position (6.15)
 - 2-3-4 Reduces the horizontal scale at the current cursor position (6.15)
 - 2-3-5 Expands the vertical scale at the center of the measured values (6.15)
 - 2-3-6 Reduces the vertical scale at the center of the measured values (6.15)
 - 2-3-7 Initializes the display scale (6.15)
 - 2-3-8 Loads the waveform data of the logging data into the specified trace (6.15)
 - 2-4 Sets data logging conditions (6.15)
 - 2-4-1 Sets logging parameters (6.15)
 - 2-4-2 Sets analysis conditions (6.15)
 - 2-4-4 Selects the data to display a graph of (6.15)
 - 2-4-5 Selects the number of channels to display on the graph (6.15)
 - 2-4-6 Sets the table data display mode (6.15)
 - 2-4-7 Sets the table data value display mode (6.15)
 - 2-4-8 Sets the reference value for displaying relative values of the table data (6.15)
 - 2-5 Deletes logging data (6.15)
 - 2-6 Displays waveform data while data logging is in progress (6.15)
 - 2-7 Saves logging data (6.15)
 - 2-8 Loads logging data (6.15)

SYSTEM(MORE 1/4)

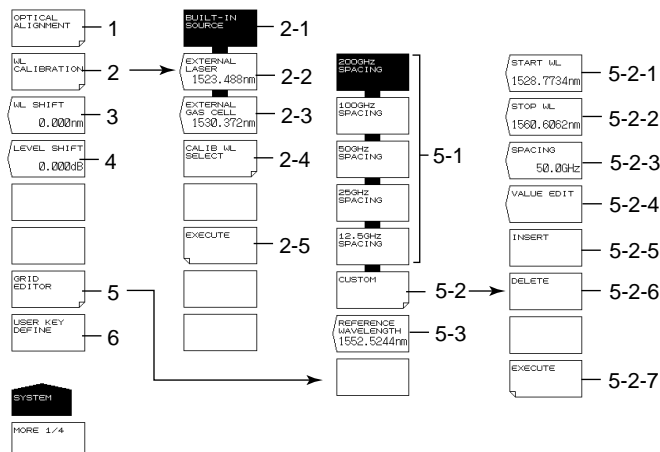

- 1 Executing monochromator alignment adjustment (2.1)
- 2 Wavelength calibration (2.2)
 - 2-1 Wavelength calibration using the internal light source (2.2)
 - 2-2 Wavelength calibration using a laser type external reference light source (2.2)
 - 2-3 Wavelength calibration using a gas cell type external reference light source (2.2)
 - 2-4 Wavelength calibration setting for wavelength calibration using an external reference light source (2.2)
 - 2-5 Executing wavelength calibration (2.2)
- 3 Setting the wavelength shift amount (value specified for the wavelength axis display value is added) (6.14)
- 4 Setting the level shift amount (value specified for the level axis display value is added) (6.14)
- 5 Editing the grid table (6.10)
 - 5-1 Creating a grid table with predetermined grid spacing (6.10)
 - 5-2-1 Setting the start wavelength (6.10)
 - 5-2-2 Setting the stop wavelength (6.10)
 - 5-2-3 Setting the frequency Spacing (6.10)
 - 5-2-4 Setting channel point wavelength (6.10)
 - 5-2-5 Inserting channel points (6.10)
 - 5-2-6 Deleting channel points (6.10)
 - 5-2-7 Finalizing input values (6.10)
 - 5-2 Creating a custom grid table (an arbitrary grid table) (6.10)
 - 5-3 Setting the grid table reference wavelength (6.10)
- 6 Registering user keys (8.1)

SYSTEM(MORE 3/4, MORE 4/4)

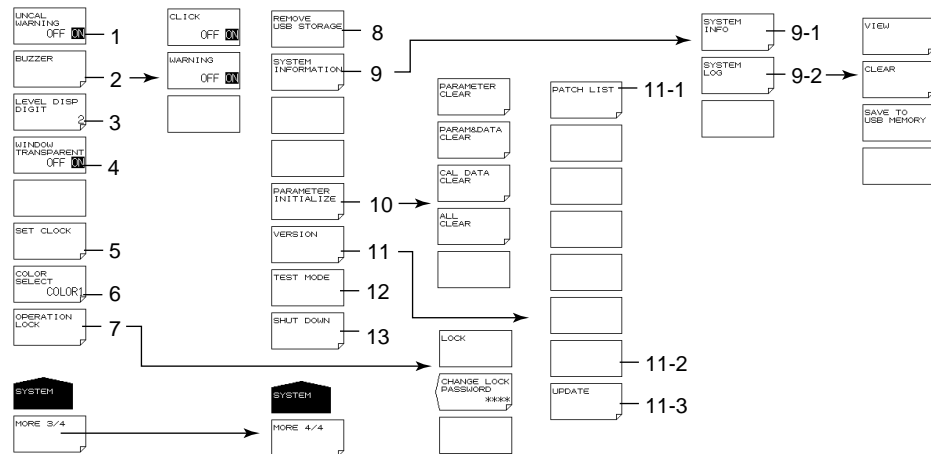

- 1 UNCAL, warning display ON/OFF (8.6)
- 2 Buzzer settings (8.6)
- 3 Setting the number of level data digits (3.4)
- 4 Semitransparent display ON/OFF (3.4)
- 5 Date/time setting (3.5)
- 6 Setting the display color (3.4)
- 7 Locking the operation key and changing the password for operation lock (8.5)
- 8 Removing the USB storage medium (7.1)
- 9 System information display (8.7)
 - 9-1 Displaying the serial number, Ethernet port MAC address, and other items (8.7)
 - 9-2 Displaying, clearing, and saving the system log to USB memory (8.7)
- 10 Initializing settings (8.2)
- 11 Displaying the software version and upgrading (9.1)
 - 10-1 Displaying the patch list (9.1)
 - 10-2 Upgrading the software (9.1)
- 12 Service menu (8.6)
- 13 System shutdown (See IMAQ6370C-17EN)

Appendix 8 END USER LICENSE AGREEMENT

- You have acquired a device (“DEVICE”) that includes software licensed by YOKOGAWA TEST & MEASUREMENT CORPORATION from Microsoft Licensing Inc. or its affiliates (“MS”). Those installed software products of MS origin, as well as associated media, printed materials, and “online” or electronic documentation (“SOFTWARE”) are protected by international intellectual property laws and treaties. The SOFTWARE is licensed, not sold. All rights reserved.
- **IF YOU DO NOT AGREE TO THIS END USER LICENSE AGREEMENT (“EULA”), DO NOT USE THE DEVICE OR COPY THE SOFTWARE. INSTEAD, PROMPTLY CONTACT YOKOGAWA TEST & MEASUREMENT CORPORATION FOR INSTRUCTIONS ON RETURN OF THE UNUSED DEVICE(S) FOR A REFUND. ANY USE OF THE SOFTWARE, INCLUDING BUT NOT LIMITED TO USE ON THE DEVICE, WILL CONSTITUTE YOUR AGREEMENT TO THIS EULA (OR RATIFICATION OF ANY PREVIOUS CONSENT).**
- **GRANT OF SOFTWARE LICENSE. This EULA grants you the following license:**
 - You may use the SOFTWARE only on the DEVICE.
 - **NOT FAULT TOLERANT. THE SOFTWARE IS NOT FAULT TOLERANT. YOKOGAWA TEST & MEASUREMENT CORPORATION HAS INDEPENDENTLY DETERMINED HOW TO USE THE SOFTWARE IN THE DEVICE, AND MS HAS RELIED UPON YOKOGAWA TEST & MEASUREMENT CORPORATION TO CONDUCT SUFFICIENT TESTING TO DETERMINE THAT THE SOFTWARE IS SUITABLE FOR SUCH USE.**
 - **NO WARRANTIES FOR THE SOFTWARE. THE SOFTWARE is provided “AS IS” and with all faults. THE ENTIRE RISK AS TO SATISFACTORY QUALITY, PERFORMANCE, ACCURACY, AND EFFORT (INCLUDING LACK OF NEGLIGENCE) IS WITH YOU. ALSO, THERE IS NO WARRANTY AGAINST INTERFERENCE WITH YOUR ENJOYMENT OF THE SOFTWARE OR AGAINST INFRINGEMENT. IF YOU HAVE RECEIVED ANY WARRANTIES REGARDING THE DEVICE OR THE SOFTWARE, THOSE WARRANTIES DO NOT ORIGINATE FROM, AND ARE NOT BINDING ON, MS.**
 - **Note on Java Support.** The SOFTWARE may contain support for programs written in Java. Java technology is not fault tolerant and is not designed, manufactured, or intended for use or resale as online control equipment in hazardous environments requiring fail-safe performance, such as in the operation of nuclear facilities, aircraft navigation or communication systems, air traffic control, direct life support machines, or weapons systems, in which the failure of Java technology could lead directly to death, personal injury, or severe physical or environmental damage. Sun Microsystems, Inc. has contractually obligated MS to make this disclaimer.
 - **No Liability for Certain Damages. EXCEPT AS PROHIBITED BY LAW, MS SHALL HAVE NO LIABILITY FOR ANY INDIRECT, SPECIAL, CONSEQUENTIAL OR INCIDENTAL DAMAGES ARISING FROM OR IN CONNECTION WITH THE USE OR PERFORMANCE OF THE SOFTWARE. THIS LIMITATION SHALL APPLY EVEN IF ANY REMEDY FAILS OF ITS ESSENTIAL PURPOSE. IN NO EVENT SHALL MS BE LIABLE FOR ANY AMOUNT IN EXCESS OF U.S. TWO HUNDRED FIFTY DOLLARS (U.S.\$250.00).**
 - **Limitations on Reverse Engineering, Decompilation, and Disassembly.** You may not reverse engineer, decompile, or disassemble the SOFTWARE, except and only to the extent that such activity is expressly permitted by applicable law notwithstanding this limitation.
 - **SOFTWARE TRANSFER ALLOWED BUT WITH RESTRICTIONS.** You may permanently transfer rights under this EULA only as part of a permanent sale or transfer of the Device, and only if the recipient agrees to this EULA. If the SOFTWARE is an upgrade, any transfer must also include all prior versions of the SOFTWARE.
 - **EXPORT RESTRICTIONS.** You acknowledge that SOFTWARE is of US-origin. You agree to comply with all applicable international and national laws that apply to the SOFTWARE, including the U.S. Export Administration Regulations, as well as end-user, end-use and country destination restrictions issued by U.S. and other governments. For additional information on exporting the SOFTWARE, see <http://www.microsoft.com/exporting/>.

Installation and Use. The SOFTWARE may not be used by more than two (2) processors at any one time on the DEVICE. You may permit a maximum of ten (10) computers or other electronic devices (each a “Client”) to connect to the DEVICE to utilize the services of the SOFTWARE solely for file and print services, internet information services, and remote access (including connection sharing and telephony services). The ten (10) connection maximum includes any indirect connections made through “multiplexing” or other software or hardware which pools or aggregates connections. Except as otherwise permitted in the NetMeeting/Remote Assistance/Remote Desktop Features terms below, you may not use a Client to use, access, display or run the SOFTWARE, the SOFTWARE’s user interface or other executable software residing on the DEVICE.

If you use the DEVICE to access or utilize the services or functionality of Microsoft Windows Server products (such as Microsoft Windows NT Server 4.0 (all editions) or Microsoft Windows 2000 Server (all editions)), or use the DEVICE to permit workstation or computing devices to access or utilize the services or functionality of Microsoft Windows Server products, you may be required to obtain a Client Access License for the Device and/or each such workstation or computing device. Please refer to the end user license agreement for your Microsoft Windows Server product for additional information.

Appendix 8 END USER LICENSE AGREEMENT

Restricted Uses. The SOFTWARE is not designed or intended for use or resale in hazardous environments requiring fail-safe performance, such as in the operation of nuclear facilities, aircraft navigation or communication systems, air traffic control, or other devices or systems in which a malfunction of the SOFTWARE would result in foreseeable risk of injury or death to the operator of the device or system, or to others.

Restricted Functionality. You are licensed to use the SOFTWARE to provide only the limited functionality (specific tasks or processes) for which the DEVICE has been designed and marketed by YOKOGAWA TEST & MEASUREMENT CORPORATION. This license specifically prohibits any other use of the software programs or functions, or inclusion of additional software programs or functions, on the DEVICE.

Security Updates. Content providers are using the digital rights management technology ("Microsoft DRM") contained in this SOFTWARE to protect the integrity of their content ("Secure Content") so that their intellectual property, including copyright, in such content is not misappropriated. Owners of such Secure Content ("Secure Content Owners") may, from time to time, request MS, Microsoft Corporation or their subsidiaries to provide security related updates to the Microsoft DRM components of the SOFTWARE ("Security Updates") that may affect your ability to copy, display and/or play Secure Content through Microsoft software or third party applications that utilize Microsoft DRM. You therefore agree that, if you elect to download a license from the Internet which enables your use of Secure Content, MS, Microsoft Corporation or their subsidiaries may, in conjunction with such license, also download onto your DEVICE such Security Updates that a Secure Content Owner has requested that MS, Microsoft Corporation or their subsidiaries distribute. MS, Microsoft Corporation or their subsidiaries will not retrieve any personally identifiable information, or any other information, from your DEVICE by downloading such Security Updates.

NetMeeting/Remote Assistance/Remote Desktop Features. The SOFTWARE may contain NetMeeting, Remote Assistance, and Remote Desktop technologies that enable the SOFTWARE or other applications installed on the Device to be used remotely between two or more computing devices, even if the SOFTWARE or application is installed on only one Device. You may use NetMeeting, Remote Assistance, and Remote Desktop with all Microsoft products; provided however, use of these technologies with certain Microsoft products may require an additional license. For both Microsoft products and non-Microsoft products, you should consult the license agreement accompanying the applicable product or contact the applicable licensor to determine whether use of NetMeeting, Remote Assistance, or Remote Desktop is permitted without an additional license.

Consent to Use of Data. You agree that MS, Microsoft Corporation and their affiliates may collect and use technical information gathered in any manner as part of product support services related to the SOFTWARE. MS, Microsoft Corporation and their affiliates may use this information solely to improve their products or to provide customized services or technologies to you. MS, Microsoft Corporation and their affiliates may disclose this information to others, but not in a form that personally identifies you.

Internet Gaming/Update Features. If the SOFTWARE provides, and you choose to utilize, the Internet gaming or update features within the SOFTWARE, it is necessary to use certain computer system, hardware, and software information to implement the features. By using these features, you explicitly authorize MS, Microsoft Corporation and/or their designated agent to use this information solely to improve their products or to provide customized services or technologies to you. MS or Microsoft Corporation may disclose this information to others, but not in a form that personally identifies you.

Internet-Based Services Components. The SOFTWARE may contain components that enable and facilitate the use of certain Internet-based services. You acknowledge and agree that MS, Microsoft Corporation or their affiliates may automatically check the version of the SOFTWARE and/or its components that you are utilizing and may provide upgrades or supplements to the SOFTWARE that may be automatically downloaded to your Device.

Links to Third Party Sites. The SOFTWARE may provide you with the ability to link to third party sites through the use of the SOFTWARE. The third party sites are not under the control of MS, Microsoft Corporation or their affiliates. Neither MS nor Microsoft Corporation nor their affiliates are responsible for (i) the contents of any third party sites, any links contained in third party sites, or any changes or updates to third party sites, or (ii) webcasting or any other form of transmission received from any third party sites. If the SOFTWARE provides links to third party sites, those links are provided to you only as a convenience, and the inclusion of any link does not imply an endorsement of the third party site by MS, Microsoft Corporation or their affiliates.

Additional Software/Services. The SOFTWARE may permit YOKOGAWA TEST & MEASUREMENT CORPORATION, MS, Microsoft Corporation or their affiliates to provide or make available to you SOFTWARE updates, supplements, add-on components, or Internet-based services components of the SOFTWARE after the date you obtain your initial copy of the SOFTWARE ("Supplemental Components").

If YOKOGAWA TEST & MEASUREMENT CORPORATION provides or makes available to you Supplemental Components and no other EULA terms are provided along with the Supplemental Components, then the terms of this EULA shall apply.

If MS, Microsoft Corporation or their affiliates make available Supplemental Components, and no other EULA terms are provided, then the terms of this EULA shall apply, except that the MS, Microsoft Corporation or affiliate entity providing the Supplemental Component(s) shall be the licensor of the Supplemental Component(s).

YOKOGAWA TEST & MEASUREMENT CORPORATION, MS, Microsoft Corporation and their affiliates reserve the right to discontinue any Internet-based services provided to you or made available to you through the use of the SOFTWARE.

This EULA does not grant you any rights to use the Windows Media Format Software Development Kit ("WMFSDK") components contained in the SOFTWARE to develop a software application that uses Windows Media technology. If you wish to use the WMFSDK to develop such an application, visit <http://msdn.microsoft.com/workshop/imedia/windowsmedia/sdk/wmsdk.asp>, accept a separate license for the WMFSDK, download the appropriate WMFSDK, and install it on your system.

Index

Symbol	Page
0nm SWEEP TIME	6-41
A Page	
Absolute Level Accuracy	2-13, 6-59
ABSOLUTE Templates	6-51
Active Trace	4-34
ADVANCE	App-65
Air Wavelength	1-3, 4-2
Algorithm for determining the ASE level	6-24
Algorithms for Spectrum Width Analysis	6-3
Algorithms for WDM channel detection	6-32
Alignment	1-2
ALL MARKER CLEAR	5-53
All Trace	7-22
Analog Out	1-6, 4-49
ANALYSIS	App-58
Analysis between Line Markers	1-13, 6-54
Analysis in the Zoom Area	1-13, 6-55
Arrow keys	3-5
ASE ALGO	6-24
ASE Level Measurement	6-24
Automatic Analysis on Each Sweep	6-2
Automatic Offset	8-23
Auto Measurement	1-2, 4-1
Auto Search	5-53
AUTO SEARCH ON/OFF	5-53
AUTO SUB SCALE	4-10
AVERAGE TIMES	4-32
Averaging Times (Roll)	5-11
B Page	
BIN	7-17
BOTTOM SEARCH	5-52, 5-56
Buzzer Settings	8-21
C Page	
CALCULATE Mode	1-8
Calculation Range	5-24
Calibration	1-2
CENTER	App-50
Center Wavenumber	4-15
CHOP	4-30
CHOP MODE	4-30
Clearing Traces	5-49
CLEAR MARKER	5-52
Colors	3-7
Copying Traces	5-48
CSV	7-17, 7-40
CSV Data Format	7-18
Curve Fit	1-8
Curve Fit Target Range	5-22
Curve Fit Target Trace	5-22
Curve Fitting Algorithm	5-24
Custom Grid Table	6-38, App-1
D Page	
Data Initialization	1-14
Date	3-8
DELAY	4-45
DFB-LD	1-12
DFB-LD Analysis Function	App-16
DISPLAY	App-53
DISPLAY MASK	6-15
Display OFF	8-24
DISPLAY TYPE	6-17
DUAL TRACE	6-16
E Page	
EDFA-NF Analysis Parameters	6-23
EDGE	4-45
ENVELOPE Method	App-4
External Trigger	1-5
External Trigger Mode	4-44
Extrapolating Template Data	6-52
EXT TRIGGER MODE	4-40
F Page	
FILE	App-60
FITTING ALGO	6-16, 6-24
FITTING AREA	6-24
FIX @	4-34
Fixed Markers	5-26, 5-39
Fixing a Waveform	5-8
FIX Mode	1-7, 4-34
FP-LD	1-12
FP-LD Analysis Function	App-17
Frequency	1-3
Frequency Display Mode	4-5
Fuses	9-8
G Page	
Gas Cell	2-6
Go/No Go Judgment	1-13, 6-48
Grid Table	6-38, App-1
H Page	
HELP	1-14, 8-17
HOLD	5-45
Horizontal Axis	4-2
HRZN	5-47
I Page	
Initialization	8-2
initial values	8-3
Interval	4-28
K Page	
Keyboard	3-4

Strings	3-6
Sub Scale	4-7
Sub Scale REF Position	4-7
SUMMARY TYPE	6-69
SWEEP	App-50
Sweep Average	5-11
Sweeping between Line Markers	4-37
SWEEP INTERVAL	4-36
Sweep Speed	4-31
SWEEP TRIG	4-45
Sweep Trigger	1-5
Sweep Width	4-24
Switching between Wavelength and Frequency	1-3
SYSTEM	App-66

T Page

Target Line	6-49
Template	1-13
Template Data	6-50
Template Data Format	6-53
Template Data Types	6-51
TEST BAND	6-34
Test Mode	8-21
THRESH	5-55
THRESH LEVEL	6-15, 6-23, 6-34
THRESH Method	App-2
Time	3-8
TRACE	1-7, App-54
Trace List	5-49
Trace-to-Trace Calculations	5-14
Transparent	3-7
Trigger Input Mode	4-43
Trigger Output	4-47

U Page

UNCAL	4-25, 4-26, 8-21
Units for the Vertical Axis	4-4
Updating a Waveform	5-8
Upper Limit Line Judgment	6-48
Upper Trace	5-44
USB Mouse	1-14
USB Storage Media	7-1

V Page

Vacuum Wavelength	1-3, 4-2
VERT	5-47
Vertical Axis	4-3
Vertical Axis Effective Range	4-6
VIEW @	4-34

W Page

Warning	8-21, 9-13
Wavelength	1-3
Wavelength Display Mode	4-5
Wavelength Display Sweep Width	5-6
Wavelength Line Markers	5-41
Wavenumber	4-19, 4-25
WDM Analysis	1-12
WDM analysis function parameters	6-14
WDM Filter Analysis Parameters	6-32
WL SHIFT	6-59
WNUM	4-15
WRITE @	4-34
WRITE Mode	1-7, 4-34

Z Page

ZOOM	1-7, App-53
Zoom Center Wavelength	5-6
Zooming In/Out	5-1, 5-3
Zoom Start Wavelength	5-6
Zoom Stop Wavelength	5-6